



UNEP : UNITED NATIONS ENVIRONMENT PROGRAMME
INDUSTRY AND ENVIRONMENT

Mine Rehabilitation for Environment and Health Protection

A Training Manual



WHO : WORLD HEALTH ORGANISATION
REGIONAL OFFICE FOR EUROPE

Mine Rehabilitation for Environment and Health Protection

A Training Manual



World Health Organisation
European Centre for Environment and Health (ECEH)
Rome Operational Division
Solid Waste Programme
Via Francesco Crispi, 10
I-00187 Rome
Italy
Tel: 39 6 48 77 51
Fax: 39 6 48 77 599
e-mail: ecehr@who.it

United Nations Environment Programme
Industry and Environment Centre
39-43 quai André Citroën
75739 Paris Cedex 15
France
Tel: 33 1 44 37 14 50
Fax: 33 1 44 37 14 74
e-mail: unepie@unep.fr
<http://www.unepie.org>

Copyright © 1998 UNEP

This publication may be reproduced in whole or in part and in any form for educational or non-profit purposes without special permission from the copyright holder, provided acknowledgement of the source is made. UNEP would appreciate receiving a copy of any publication that uses this publication as a source.

No use of this publication may be made for resale or for any other commercial purpose whatsoever without prior permission in writing from UNEP.

First edition 1998

The designations employed and the presentation of the material in this publication do not imply the expression of any opinion whatsoever on the part of the United Nations Environment Programme concerning the legal status of any country, territory, city or area or of its authorities, or concerning delimitation of its frontiers or boundaries. Moreover, the views expressed do not necessarily represent the decision or the stated policy of the United Nations Environment Programme, nor does citing of trade names or commercial processes constitute endorsement.

UNITED NATIONS PUBLICATION

ISBN: 92-807-1720-0

Cover Photograph

We are grateful to Rio Tinto plc for permission to use the cover photograph. It shows the early stages of the rehabilitation process at Richards Bay Minerals (RBM) in South Africa. RBM mines and processes the heavy minerals which occur in the coastal dunes of Zululand. Mined out areas are reformed into dunes and re-vegetated with one third indigenous forest and two thirds commercial (casuarina) plantation as was laid down by the former KwaZulu authorities. This rehabilitation policy reflects a vegetation mosaic similar to that which existed before mining. The casuarina stabilise loose sand and encourage the development of a thick humus which hosts various plants and wildlife. In the foreground windbreaks have been erected to protect the young plants from wind damage. In the background dunes are at a more advanced stage of rehabilitation with their respective covers of either indigenous or commercial vegetation.

Evaluation Questionnaire

UNEP/WHO MINE REHABILITATION FOR ENVIRONMENT AND HEALTH PROTECTION A TRAINING MANUAL

The United Nations Environment Programme (UNEP) and the World Health Organisation (WHO) would like to assess the usefulness and effectiveness of this training manual. We would appreciate your co-operation in completing the following questionnaire.

1. Quality:

Please rate the following quality aspects of the manual by ticking the appropriate box:

	Very Good	Adequate	Poor
Subject Coverage	<input type="checkbox"/>	<input type="checkbox"/>	<input type="checkbox"/>
Up-to-Date	<input type="checkbox"/>	<input type="checkbox"/>	<input type="checkbox"/>
Readability	<input type="checkbox"/>	<input type="checkbox"/>	<input type="checkbox"/>
Structure	<input type="checkbox"/>	<input type="checkbox"/>	<input type="checkbox"/>
Presentation	<input type="checkbox"/>	<input type="checkbox"/>	<input type="checkbox"/>
"User-friendliness"	<input type="checkbox"/>	<input type="checkbox"/>	<input type="checkbox"/>
Objectivity	<input type="checkbox"/>	<input type="checkbox"/>	<input type="checkbox"/>

2. Usefulness:

In general, how much of the manual is:

	Most	About Half	Little
Of technical/substantive value to you?	<input type="checkbox"/>	<input type="checkbox"/>	<input type="checkbox"/>
Relevant to you?	<input type="checkbox"/>	<input type="checkbox"/>	<input type="checkbox"/>
Will be used by you?	<input type="checkbox"/>	<input type="checkbox"/>	<input type="checkbox"/>
New to you?	<input type="checkbox"/>	<input type="checkbox"/>	<input type="checkbox"/>

Please describe any changes that would improve the manual:

Is there certain information lacking in the manual that could be added? Please describe.

Would it be useful if the manual were translated into your language? If so, which language?

3. Effectiveness: Trainers

This manual was designed as a resource document to provide trainers with the tools necessary to conduct training courses on environmental and health protection for mine rehabilitation. In your opinion, to what extent will the manual contribute to the achievement of this objective?

Please tick one box Fully Adequately Inadequately

Please state reasons for your answer:

How many programmes have you organized using the manual? _____

Who were the trainers? _____

On average, how many days are the programmes? _____

How many participants have been trained using the manual? _____

4. Effectiveness : Participants

What have been the responses of participants who took part in the training:

a. Has the feedback generally been positive or negative?

b. Do any ask for further guidance/information?

5. Distribution

Will others use your copy? Yes No Unknown

If 'Yes', how many? _____

Did you receive this manual directly from UNEP? Yes No

If 'No', who forwarded it to you? _____

UNEP and WHO would like to thank you for completing this questionnaire. Please fax your reply to UNEP IE, Attention: Fritz Balkau, at (33) 1.44.37.14.74, or airmail it to: UNEP IE, Tour Mirabeau, 39-43 quai André Citroën, 75739 Paris Cedex 15, France

PREFACE

This manual has been prepared jointly by the United Nations Environment Programme, Industry and Environment (UNEP IE) and the World Health Organisation (WHO). It complements an earlier trainer's package on Environmental Management of Mine Sites (UNEP IE Technical Report No. 30). The earlier report introduced in a general way some of the key environmental issues relating to mines. This present manual covers one of these in a more comprehensive manner - that of site rehabilitation. Rehabilitation is the aspect most easily perceived by regulators and the public as being deficient in mining operations. It is important that companies put emphasis on this aspect, and this in turn needs competent, trained personnel.

Trainers and training programmes often lack good educational resource material, and access to effective curricula. In order to ensure that future generations of mining professionals are able to integrate the environmental dimension into their daily work, UNEP together with other partners has been preparing resource materials for trainers in industry and at institutions. This manual is one example of such material. At the same time, trainers in countries in each region are encouraged to meet and exchange among themselves their experiences and curriculum ideas so that each programme is most closely matched to the needs of the country.

This training manual is designed as an applied, hands-on guide to address the rehabilitation of disturbed land, particularly as it applies to mining lands. It is not designed to explore the theory and philosophies of rehabilitation, it is presented as a practical, factual method whereby rehabilitation techniques can be applied.

The techniques presented in this manual are the result of both research in the practical aspects of mine rehabilitation and the experience of private sector and public sector technicians as well as scientists and engineers in Canada and elsewhere. The composite exercises presented are based on actual cases, but the names and locations have been changed.

Trained personnel are only part of the equation. There has to be a willingness to apply the knowledge and skills in the field. UNEP, WHO and other organisations prepare practical guidance on how companies and ministries can implement the advice into their organisational decisions through the use of environmental and health management tools, and adoption of formal environmental management systems.

We are very aware that progress will continue to be made, and we encourage users of this document to become active partners in the use, review, revisions and further dissemination of the information: contact information may be found in the Acknowledgements section.

MINE REHABILITATION FOR ENVIRONMENT AND HEALTH PROTECTION: A TRAINING MANUAL

CONTENTS

List of Tables
List of Figures
Preface
Background
How to Use this Manual
About the Authors
Acknowledgements
Photographs

PART I BACKGROUND AND PLANNING

1. INTRODUCTION

- 1.1 National Environmental Management Strategies
- 1.2 The Regulatory Framework

2. THE MINING SEQUENCES

- 2.1 Introduction
- 2.2 Exploration
- 2.3 Project Development
- 2.4 Mine Operation
- 2.5 Suspension/Inactive Mine
- 2.6 Mine Closure
- 2.7 Post-Closure
- 2.8 Exercises

3. ENVIRONMENTAL ISSUES IN MINING

- 3.1 Introduction
- 3.2 Overview of Environmental Issues in Mining
- 3.3 Prevention of Impact and Control of Pollution
- 3.4 Summary
- 3.5 Exercises

4. OCCUPATIONAL HEALTH AND THE MINING PROCESS

- 4.1 Introduction
- 4.2 The Physical Impacts on Occupational Health
- 4.3 The Chemical Impacts on Occupational Health
- 4.4 Biological Impacts
- 4.5 Risk Reduction Methods
- 4.6 Medical Surveillance
- 4.7 Exercises

PART II MINING, MINE WASTE AND ENVIRONMENTAL ENGINEERING

5. ENVIRONMENTAL MANAGEMENT SYSTEMS

- 5.1 Background
- 5.2 ISO 14 000
- 5.3 Environmental Management Programmes (EMPs)
- 5.4 Baseline Study
- 5.5 Glossary
- 5.6 Exercises

6. OPERATING PLAN FOR ACTIVE MINES

- 6.1 Introduction
- 6.2 Exercises

7. REHABILITATION PLANNING

- 7.1 Introduction
- 7.2 Principles of Rehabilitation
- 7.3 Physical Stability
- 7.4 Chemical Stability
- 7.5 Critical Considerations
- 7.6 Rehabilitation Plan
- 7.7 Exercises

8. MONITORING

- 8.1 Introduction
- 8.2 Monitoring Physical Stability
- 8.3 Monitoring for Chemical Stability
- 8.4 Monitoring for Environmental Impact
- 8.5 Exercises

9. EROSION CONTROL

- 9.1 Introduction
- 9.2 Wind
- 9.3 Water
- 9.4 Exercises

10. LANDSCAPING

- 10.1 Introduction
- 10.2 Planning
- 10.3 Technical Guidelines
- 10.4 Exercises

11. TOPSOIL MANAGEMENT

- 11.1 Introduction

- 11.2 Nature of Topsoil
- 11.3 Stockpiling of Topsoil
- 11.4 The Placing of Topsoil
- 11.5 Inappropriate Placement of Topsoil
- 11.6 Exercises

12. AMELIORATION AND VEGETATION

- 12.1 Introduction
- 12.2 Assessment of Soil Conditions
- 12.3 The Incorporation of Organic Materials and Mulches
- 12.4 The Correction of pH
- 12.5 The Application of Fertilisers
- 12.6 Irrigation
- 12.7 Species Selection and Provenance Concept
- 12.8 Seeds and Seed Collection
- 12.9 Exercises

13. STABILITY OF TAILINGS DISPOSAL SITES

- 13.1 Introduction
- 13.2 Dam Siting
- 13.3 Dam Construction
- 13.4 Instability Factors
- 13.5 Exercises

14. DISPOSAL OF WASTE ROCK

- 14.1 Introduction
- 14.2 Siting
- 14.3 Structure
- 14.4 Aesthetics
- 14.5 Exercises

15. ACIDIC DRAINAGE

- 15.1 Introduction
- 15.2 Early Planning
- 15.3 Perpetual Treatment
- 15.4 Inhibit or Reduce the Rate of Oxidation
- 15.5 Removal
- 15.6 Paste Backfill
- 15.7 Biological Treatment
- 15.8 Co-Disposal of Tailings and Waste Rock
- 15.9 Other Methods
- 15.10 Exercises

16. TAILINGS REHABILITATION

- 16.1 Objectives
- 16.2 Rehabilitation Considerations
- 16.3 Physical Treatment Options for Tailings Rehabilitation

- 16.4 Vegetation
- 16.5 Exercises

17. CHEMICALS, HEAVY METALS AND TOXIC MINE WASTE

- 17.1 Introduction
- 17.2 Processing Chemicals
- 17.3 Heavy Metals
- 17.4 Petroleum Products
- 17.5 Salts
- 17.6 Radioactive Waste
- 17.7 Other Wastes
- 17.8 Implications for Closure and Rehabilitation
- 17.9 Exercises

18. ADITS AND SHAFTS

- 18.1 Introduction
- 18.2 Methods of Securing and Sealing Openings
- 18.3 Crown Pillars
- 18.4 Exercises

19. BUILDINGS AND INFRASTRUCTURE

- 19.1 Introduction
- 19.2 Buildings
- 19.3 Power Lines
- 19.4 Roads
- 19.5 Exercises

**PART III REPRESENTATIVE CASE STUDIES IN THE COUNTRY OF
“UDANAX”**

20. THE COUNTRY CONTEXT

- 20.1 Introduction
- 20.2 National Profile
- 20.3 Exercises

21. SUREFIRE MINE TAILINGS SITE I

- 21.1 Background
- 21.2 Tailings Dam
- 21.3 Tailings Surface Rehabilitation
- 21.4 Exercises

22. ONGOING REHABILITATION AT PORT MINE

- 22.1 Background
- 22.2 Siting and Noise Control
- 22.3 Water Management
- 22.4 Revegetation

22.5 Exercises

23. TAILINGS DAM FAILURE AT GLITTER MINE NORTH

23.1 Background

23.2 Tailings Dam

23.3 Tailings Surface Rehabilitation

23.4 Acidic Drainage

23.5 Oxan Creek and Forested Areas

23.6 Monitoring

23.7 Exercises

PART IV BIBLIOGRAPHY, ANSWERS TO EXERCISES AND ANNEX

24. BIBLIOGRAPHY

25. MODEL ANSWERS TO EXERCISES

**ANNEX EXAMPLES OF ENVIRONMENTAL LEGISLATION AND RELATED
ISSUES (WITH SPECIAL REFERENCE TO ZIMBABWE)**

LIST OF TABLES

- 3.1 Some Potential Environmental Impacts of Mining
- 3.2 Flotation Reagents Used in Base Metal Concentrators
- 4.1 Occupational Exposure Limits in Various Countries for Dust containing Free Silica in mg/m^3
- 7.1 Perpetual Disruptive Forces: Consequences and Control Technology
- 7.2 Chemical Stability - Potential Control Technologies
- 7.3 Rehabilitation Measures - Underground Workings
- 7.4 Rehabilitation Measures - Open-cast Workings
- 7.5 Rehabilitation Measures - Mine Rock and Overburden Piles
- 7.6 Rehabilitation Measures - Tailings Impoundment
- 7.7 Rehabilitation Measures - Water Management
- 7.8 Rehabilitation Measures - Buildings and Equipment
- 7.9 Rehabilitation Measures - Infrastructure
- 7.10 Rehabilitation Measures - Landfill and Other Wastes
- 8.1 Monitoring Methods for Physical Stability
- 8.2 Instrumentation Monitoring for Tailings Dams
- 8.3 Monitoring Methods for Chemical Stability
- 9.1 Common Mulch
- 9.2 Various Water Pollutants
- 9.3 Minimum Design Inflow Floods for Dams
- 10.1 Spacing Between Benches
- 10.2 Maximum Slopes for Land Use
- 12.1 Common Mulch Application Rates
- 12.2 Lime Application Rates
- 12.3 Nutrient Sources
- 12.4 Guidelines to Slope Inclination
- 16.1 Contaminants and Hazardous Materials Commonly Found in Tailings
- 20.1 Main Origins of Gross Domestic Product
- 20.2 Structure of Employment
- 20.3 Mineral Production
- 20.4 Mineral Production Split by Company
- 20.5 Environmental Sensitivity: Udanax
- 20.6 Shrubs in Udanax
- 20.7 Forbs in Udanax
- 20.8 Trees in Udanax

At many sites however, the damage has already been done, in which case rehabilitation in a post-project sense is required. These situations are invariably expensive, and often with no clear view of where the funds will come from. Post-project rehabilitation must therefore be intensely practical, cost-effective and low-budget. In many cases the objective will be to make a site secure rather than to plan for a productive after-use. Time may become one of the tools of the specialist, relying on nature to do over many years what technology and intensive care can achieve in a few months at more active sites.

The issue of legal and financial responsibility is at the heart of many rehabilitation projects. For new projects, legislation may set performance targets in terms of environmental impacts and long-term land-use, perhaps enforced through financial bonds or securities that guarantee the public purse against defaulting companies. The rehabilitation procedures may already be evaluated at the EIA stage and established as obligations in the project permit.

Many companies now see their relationships with the public as being at least as important as regulatory compliance. Public acquiescence of mining as a future activity is strongly influenced by its vision of ecological performance at today's sites. The rehabilitation of sites which leaves a public asset in terms of farmland, recreation reserves or nature habitat has become an increasingly common policy of mining companies. Such rehabilitation must pay regard to these demands of objectives, going beyond the mere physical stabilisation of slopes and pits and providing a vegetation cover at the least cost.

Health and safety has long been regarded as a workplace issue, with objectives being limited to physical safety and protection from toxic exposures. These are still important issues, but they have been joined by concerns about public safety from structures during and after operation; about the fate of hazardous materials and wastes buried at the site; about the use of pesticides by rehabilitation workers; and about public security of the land after closure. These issues require planning as much as the physical aspects of rehabilitation, with the added factor of worker and consultation that may be required.

Beyond the confines of the mine, mining wastes, if not properly contained, can potentially affect public health in nearby communities. Mining wastes may include cyanide compounds, heavy metals, radionuclides and asbestos (though never all of these in one waste stream). These can become solubilised or carried as suspended particles in waters leaching from the waste sites. This leachate, together with drainage from the mine, is often highly acidic or saline, and may also carry a high sediment load. The common incidents of contamination, which could ultimately affect public health or well-being, are pollution of drinking water supplies, aquatic ecosystems including fishing grounds, agricultural soils and urban areas.

As environmental and safety issues continue to evolve, all aspects of mine management must be reviewed from time to time to see if they are still relevant. Old practices may no longer be acceptable, as in the use of certain chemicals or in the standards of disposal. New techniques may become available in slope stabilisation, in revegetation or in monitoring. It is necessary for supervisors and managers to remain up-to-date with the latest techniques in order to constantly improve environmental performance. For this, a constant link with

environmental and technical research and development as well as with the changing environmental priorities of governments is an absolute necessity for all managers.

Managing the issues

In recent years, more and more companies have greatly upgraded their approach to environmental management. Some have adopted formal environmental systems in order to guide the process while others have integrated environmental management deeply into operational practices. In both cases, a change in corporate culture is involved. Explicit targets have been set, new environmental tools have been applied, and greater emphasis has been put on communication, training, incentives and partnerships.

The change in culture depends on a shift in understanding and the commitment to act. In both cases personnel has needed a new outlook and new skills. In the end, information and training are at the heart of the new approach.

Trainers have had difficulty developing effective programmes. Often this has been for very practical reasons, but the lack of good training materials has greatly slowed down the development of new understandings and new skills. It is easy to listen to a lecture or to read a book, but difficult to apply the results in the real world with real constraints. Training implies practice, and with opportunities being often limited, practice comes by exploring the situation of case studies and of scenarios under experienced tutors.

The purpose of this UNEP/WHO manual is to give practising trainers the opportunity for a more hands-on approach to training. In the end, however, we realise that nothing replaces the real world, and we can only hope that the simulations and discussions provided through the use of such manuals will be sufficient preparation for trainees to move forward with increased confidence when they apply their new knowledge.

PHOTOGRAPHS

The following photographs illustrate some environmental and health problems caused by mining. In several cases, the solutions that have been found to these particular problems are shown as well. It should be noted that not all solutions illustrated here will be suitable to all climates and situations. These examples are simply illustrative.

The photograph captions are as follows:

1. Major tailings dam failure. In the foreground is an emergency berm used to stop the earth flow.
2. Close-up of the emergency berm referred to in photograph 1.
3. Tailings dam failure showing destruction of a wooded area by earth flow.
4. Typical acidic impact on vegetation.
5. Fume kill area before revegetation, 1984.
6. The same area after revegetation, 1992.
7. Uranium mine acid-producing tailings - before.
8. Subaqueous rehabilitation of the same site - no acidic effluent.
9. Rehabilitation tailings using a wetland technique, which raises pH, causes heavy metals to precipitate to the bottom, and provides habitat.
10. Revegetated waste rock and tailings in winter.
11. Lime application to a site by air to increase the pH of the soil. The site is a fume kill area.
12. The use of bales of hay for water management. Used here as a diversion.

HOW TO USE THIS MANUAL

This manual is intended to assist with training programmes for operational and field personnel. It will also serve to make managers and inspectorates more aware of the key issues and options in rehabilitation and can thus serve as an element in more general courses and curricula.

While this manual touches on many technical subjects, it has **NOT** been designed as a textbook and should **NOT** be quoted as a design manual. Where specific technical information is required, such as guidelines for building tailings dams, for example, relevant references should be consulted, including details of local regulatory requirements. It is also not a comprehensive guide to mine rehabilitation, as it provides an overview of the issues that need to be considered, rather than in-depth coverage of any issue in particular.

The manual contains summaries of the main principles of rehabilitation, mine waste disposal and tailings dams stabilisation, particularly from the point of view of environmental and health protection. It addresses rehabilitation from the perspective of mines that are still in the planning stage, operational mines, and abandoned mine sites.

As simple reading is rarely sufficient to provide effective learning experience, the manual contains case studies and examples as well as a set of work exercises and questions to be used in the classroom or in the field. Useful diagrams and tables are provided in the form of transparencies for use by the trainer. References and bibliographies are indicated for further study.

In its present form, the manual is intended primarily to help trainers in their teaching or instruction, not as a manual for those being trained. Its use for individual study is possible, however the format and contents were not designed with this in mind, and the individual student will miss the learning opportunities that come with group discussions, field work and advice from mining specialists in classroom situations. Trainers should use it as a source of ideas only, not as the last word on the subject. For example, it is not expected that all the questions in a given chapter will be used; they are intended to be examples and pointers, to enable the trainer to find more appropriate questions suited to the particular course being presented.

The manual is suitable as a model for a complete course on mine rehabilitation, or to teach on selected individual units. In order to make it possible for the manual to be used as a stand-alone source document, some material on environmental impacts and environmental management generally has been included. Trainers should add material or modify some sections to suit local circumstances. It will also be useful for trainers to refer to the companion volume *Environmental Management of Mine Sites: a training manual* (UNEP Technical Report - No. 30) for further material and issues to explore.

This manual can never be complete. By providing a structure for the package, in a convenient loose-leaf format, trainers can expand certain themes and develop their own exercises and practical sessions. The use of local case studies and comments on local environmental priorities is a particularly important aspect of this adaptation process. Very simple overhead slide masters have been included. Trainers will probably want to make additional slides using tables and diagrams from the main part of each chapter.

Inevitably, it has been necessary to simplify and select from the voluminous literature on the subject of rehabilitation. The authors hope that the current manual fills a practical need of many trainers. We apologise in advance for any omissions that individual users may find. Feedback on this first edition is very welcome, and suggestions and additions, with appropriate acknowledgements, may find their way into subsequent editions. Contact addresses may be found in the Acknowledgements section.

USEFUL CONTACTS

Since “who you know is <often> more important than what you know”, the following list of contacts will help you to find additional resources in making use of this manual:

National and local Departments of the Environment	National and local Departments of Mining
World Health Organisation European Centre for Environment and Health Rome Operational Division Via Francesco Crispi, 10 I-00187 Rome Italy Tel 39 6 48 77 51 Fax 39 6 48 77 599 Email ecehr@who.it	UNEP Industry and Environment 39 - 43 quai André Citroën 75739 Paris Cedex 15 France Tel 33 1 44 37 14 50 Fax 33 1 44 37 14 74 Email unepie@unep.fr http://www.unepie.org
Mineral Resources Forum: http://www.natural-resources.org/environment	National and local environmental NGOs
International Council on Metals and the Environment 294 Albert Street, Suite 506 Ottawa, Ont. K1P 6E6 Canada Tel 1 613 235 42 63 Fax 1 613 235 28 65 Email info@icme.com http://www.icme.com	Australian Minerals & Energy Environment Foundation 9th Floor, 128 Exhibition St Melbourne Vic, 3000 Australia Tel 61 3 96 79 99 64 Fax 61 3 96 79 99 00 Email ameef@amira.com.au http://www.ameef.com.au/
International Journal of Surface Mining, Reclamation and Environment A. Balkema Publishers P.O. Box 1675 Rotterdam Netherlands Tel 31 10 414 58 22 Fax 31 10 413 59 47 http://ftp.info-mine.com/minpubs/ijsm/ijsm.html	Mining Environmental Management 60 Worship Street London EC2A 2HD England Tel 44 171 216 60 60 Fax 44 171 216 60 50 http://www.mining-journal.com/mj/
National and local mining associations/ chambers of mines	Mining and environmental professional societies

ABOUT THE AUTHORS

About UNEP

Founded in 1972, the United Nations Environment Programme (UNEP) is the 'environmental conscience' of the United Nations. It has three key roles:

- to monitor the world environment;
- to develop international consensus on responses to address priority environmental issues through international conventions; and
- to facilitate the implementation of these responses.

The Industry and Environment Centre (UNEP IE) was established by UNEP in 1975 to bring industry and environment together to promote environmentally sound industrial development.

Its goals are to:

- encourage the incorporation of environmental criteria in industrial development plans;
- facilitate the implementation of procedures and principles for the protection of the environment;
- promote the use of safe and clean technologies; and
- stimulate the exchange of information and experience throughout the world.

UNEP IE provides access to practical information and develops co-operative onsite action and information exchange backed by regular follow-up and assessment. To promote the transfer of information and the sharing of knowledge and experience, UNEP IE has developed four complementary tools:

- technical reviews and guidelines;
- internet-based information systems, which may be viewed at: <http://www.natural-resources.org> and <http://www.unepie.org>;
- *Industry and Environment* - a quarterly review; and
- a technical query response service.

In keeping with its emphasis on technical co-operation, UNEP IE facilitates technology transfer and the implementation of practices to safeguard the environment through promoting awareness and interaction, training and diagnostic studies.

About WHO

The World Health Organisation is a specialised agency of the United Nations with primary responsibility for international health matters and public health. Through WHO, which was created in 1948, the health professions of over 180 countries exchange their knowledge and experience, working for the attainment by all citizens of the world of a level of health that will permit them to lead socially and economically productive lives.

The WHO Regional Office for Europe is one of six regional offices throughout the world, each with its own programme geared to the particular health problems of the countries it serves.

The WHO European Region embraces some 850 million people living in an area that stretches from Greenland in the north-west and the Mediterranean in the south to the Pacific coast of the Russian Federation in the east. WHO/Europe therefore concentrates both on the problem of industrial and post-industrial societies and on those faced by the emerging democracies of the central and eastern part of the Region. Since 1990, the number of Member States has risen to 51.

Within the WHO European Region, the WHO European Centre for Environment and Health, Rome Operational Division, based in Rome, Italy, has the responsibility to promote and develop improved public health engineering, including the safer management and disposal of all forms of wastes.

Michael A. Klugman, Ph.D., P.Eng.

Dr Klugman received his education at Rhodes University, South Africa, and McGill University, Canada. He was a professor at the Colorado School of Mines, United States, has worked in industry, in economics, mining exploration, development, operations and rehabilitation in all parts of the world, excluding Asia. In government service he was a Regional Director, Ontario Ministry of Natural Resources. Subsequently, he created the Mineral Development and Rehabilitation Branch, Ontario Ministry of Northern Development and Mines, to administer the new, « environmentally friendly » Mining Act. In addition, he has written and presented training workshops on disturbed land rehabilitation to both government and industry personnel from Canada, Europe, South America and Africa. He wrote the curriculum, Mine Environment Rehabilitation and Protection, for the Zimbabwe School of Mines. This curriculum is also used at the University of Atakama, Chile.

ACKNOWLEDGEMENTS

The contents and background of this manual are drawn from many sources, including publications listed in the Bibliography, and from practical experience from many sources in North America, Australia and Africa. Much of these data have been drawn from publications by Golder Associates, the Rehabilitation of Mines Guidelines for Proponents, Version 1.2, developed by the Ontario Ministry of Northern Development and Mines, and from a handbook developed by the Australian Mining Council (now the Minerals Council of Australia). These sources are acknowledged in particular.

We are thankful for the additional technical and engineering inputs provided by colleagues within the offices of UNEP IE and WHO. A special thanks is also extended to Ingo Hemsing for his tireless efforts to complete the compilations of the final text and to Gitte Andersen for organising the editing and layout. Andrew Parsons took charge of the final stages of preparing the manual for publication.

Frances Klugman, who patiently edited and typed the manuscript, and Ian Watson, who made many sketches, which are included in the text, are also gratefully acknowledged.

Comments and feedback should be sent to:

Fritz Balkau
UNEP
Industry and Environment Centre
39-43 Quai André Citroën
75739 Paris Cedex 15
France

Tel: 33 1 44 37 14 50
Fax: 33 1 44 37 14 74
e-mail: fbalkau@unep.fr

Philip Rushbrook
World Health Organisation
European Centre for Environment and Health (ECEH)
Rome Operational Division
Solid Waste Programme
Via Francesco Crispi, 10
I-00187 Rome
Italy

Tel: 39 6 48 77 51
Fax: 39 6 48 77 599
e-mail: ecehr@who.it

LIST OF FIGURES

- 2.1 The Mining Sequence
- 5.1 EMS Elements according to ISO 14001
- 5.2 Continual Improvement
- 6.1 Poor Planning
- 6.2 Good Planning
- 6.3 Placing of Waste Piles to Screen Mine Operations
- 6.4 Poor Screening
- 6.5 Examples of Good Screening
- 8.1 Examples of Monitoring Stations and Areas
- 9.1 Dimpling Effect from Dumping
- 9.2 Use of Discarded Vehicle Tyres
- 9.3 Type of Windbreak - NOT RECOMMENDED
- 9.4 Type of Windbreak - RECOMMENDED
- 9.5 Unprotected Gap - NOT RECOMMENDED
- 9.6 Staggered Gaps - RECOMMENDED
- 9.7 Example of the Use of Old Conveyor Belt to Line a Ditch
- 9.8 Use of Flexible Plastic Flume
- 9.9 Discharge into Protected Drain or Watercourse (cross-section)
- 9.10 Discharge into Protected Drain or Watercourse (perspective view)
- 9.11 The Use of Hay Bales for Temporary Control
- + 12
- 9.13 The Use of a "Sand Bag" as a Control Structure (plan view)
- 9.14 The Use of a "Sand Bag" as a Control Structure (cross-section)
- 9.15 For Flow Control Retain Vegetated Buffer Strips
- 9.16 Settlement Dam with Siphon and Spillway with Sediment
- 9.17 Sediment Being Removed by Scraper (Slusher)
- 10.1 Ideal Slope Profile
- 10.2 Grade Comparisons and Conversion Chart
- 12.1 Soil Texture Field Test
- 13.1 Uncontrolled Discharge of Tailings into a Lake - NOT RECOMMENDED
- 13.2 Discharge of Tailings over Undulating Ground - NOT RECOMMENDED
- 13.3 The Upstream Method
- 13.4 The Downstream Method
- 13.5 The Centreline Method
- 14.1 An Illustration of a Pattern that Might be Used to Control Torrential Rainwater Run-Off
- 14.2 Outside Faces Dumped First
- 14.3 Continuous Dumping, in Filling the Internal Space with Concurrent Progressive Rehabilitation on the Outer Slopes
- 14.4 Rehabilitated Lower Slopes and the Start of the Second Lift
- 15.1 Deep Water Tailings Disposal
- 15.2 (a) Concept of Cross Valley Dam
- 15.2 (b) Dam Cross-Section A-A¹
- 15.3 Fully Lined Ringed Tailings Impoundment
- 15.4 Side Hill Containment

- 15.5 Deposition in an Open-cast Pit
- 15.6 Example of a Multi-Layered Pervious Cover
- 16.1 The Structure of an Impermeable Cap
- 18.1 The Shaft Plug
- 18.2 Adit Plug
- 18.3 Configuration of a Tapered Plug
- 20.1 Map of Udanax
- 21.1 Location of Tailings Relative to Housing
- 23.1 Glitter Mine Site

Best Practice Environmental Management in Mining booklets may be obtained from:
Supervising Scientist Group
Environment Australia
PO Box E305
Kingston
ACT 2604
Australia
Tel 61 2 62 17 20 10
Fax 61 2 62 17 20 60
http://www.environment.gov.au/ssg/pubs/mining_booklets.html



Picture 1 : Major tailings dam failure. In the foreground is an emergency berm used to stop the earth flow.



Picture 2 : Close-up of the emergency berm in photograph 1.



Picture 3 : Tailing dam failure showing destruction of a wooded area by earth flow.



Picture 4 : Typical acidic impact on vegetation.



Picture 5 : Fume kill area before revegetation, 1984.



Picture 6 : Same area after revegetation, 1992.



Picture 7 : Uranium mine acid-producing tailings - before.



Picture 8 : Subaqueous rehabilitation of the same site - no acidic effluent.



Picture 9 : Rehabilitation tailings using wetland technique which raises pH, causes heavy metals to precipitate to the bottom and provides habitat.

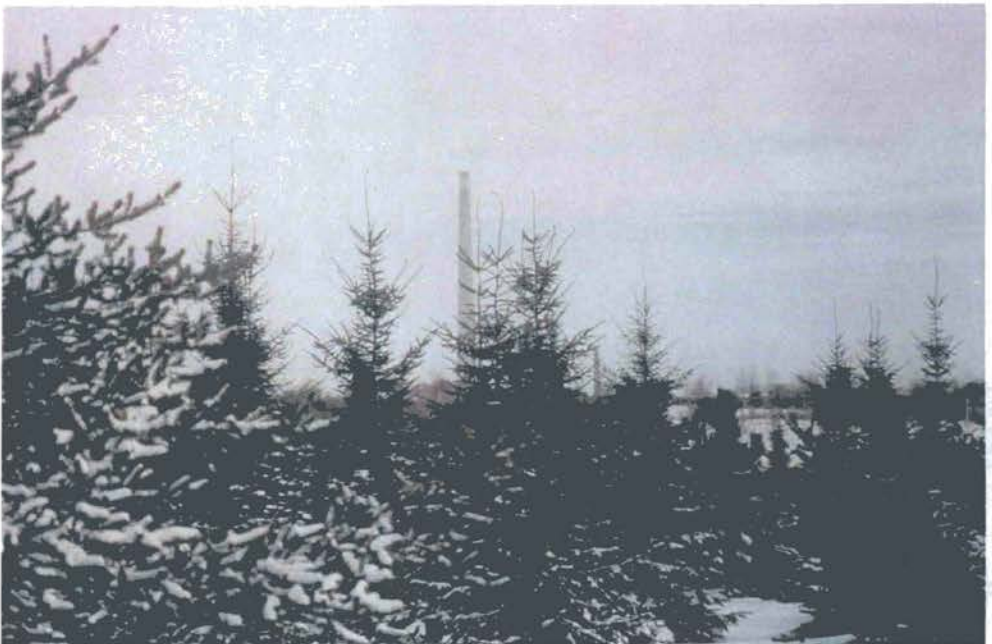

Picture 10 : Revegetated waste rock and tailings in winter.



Picture 11 : Lime application to the site by air to increase the pH of the soil.
The Site is a fume kill area.



Picture 12 : The use of bales of hay for water management. Used here as a diversion.

Part I

Background and Planning

Chapter 1

Introduction

The «resource industries», such as mining, forestry, agriculture and fishing are primary industries and as such create wealth, while the secondary industries redistribute or recycle and enhance wealth.

The creation of wealth through the development of mineral resources is of prime importance to the overall economy of a country. For this reason, sustaining and developing the mineral industry of a country, in a world that is increasingly aware of environmental impacts, is essential to the well being and future of the country. Taking these facts into consideration it is not difficult to appreciate that mining must continue to flourish and grow. Due to many pressures on operators to undertake every activity in an environmentally acceptable way, the practice of responsible environmental mine management has become of prime importance in order to make as small an impact on the environment as possible. The impact of mine waste is no exception.

The mining industry in the past, world wide, has not had a good track record relative to the scars and disturbances left behind after the decommissioning or abandonment of mines or, for that matter, during the life of the mine. That is not to say that all mining companies operations or mine operations were remiss in how they closed down or decommissioned mines. There are some excellent examples of good management going back for many years where 85-year old forests now grow on historic, closed down, decommissioned mine sites.

The demand for change across society, relative to the management of the landscape by all users of that landscape, is powerful and is growing in strength. This does not only apply to mining but to all major users such as agriculture, forestry, road construction, power-line construction.

1.1 NATIONAL ENVIRONMENTAL MANAGEMENT STRATEGIES

Agenda 21 is concerned with the practicalities of integrating environment and development in decision making. It calls on countries:

“to integrate environment and development at the policy, planning and management levels.”

The review of all economic, sectoral and environmental policies and considerations must ensure the involvement of all concerned individuals, groups and organisations in the decision making. This is best achieved through the development of a national sustainable development strategy, which must encompass a country’s mining sector so that it operates within a framework consistent with the national sustainable development principles. The strategy must take into account both the economic and environmental future of the country.

The objectives of a « National Sustainable Development Strategy » are:

- to enhance individual and community well-being and welfare by following a path of economic development that safeguards the welfare of future generations
- to provide for equity within and between generations
- to protect biodiversity and maintain essential ecological processes and life-support systems.

Mining activities involve a degree of environmental disturbance and public health risk, which have impacts on human activities, ecological systems and biodiversity. However, environmental impacts of mining have not been as extensive as those of some other land uses, such as agriculture or urban development, and although often significant, occupy relatively small areas.

The principal objective of environmental management should be to achieve the greatest possible benefit possible from the use of our natural resources without reducing their potential to meet future needs and the carrying capacity of the environment.

The guiding principles for a National Sustainable Development Mining Sector Strategy are:

- Decision making processes should integrate effectively both long- and short-term economic, environmental, social and equity considerations
- Where there are threats of serious or irreversible environmental damage, lack of full scientific certainty should not be used as a reason for postponing measures to prevent environmental degradation
- The global dimension of environmental impacts of actions and policies should be recognised and considered
- The need to develop a strong, growing and diversified economy which can enhance the capacity for environmental protection should be recognised
- Cost-effective and flexible policy instruments should be adopted, such as improved valuation, pricing and incentive mechanism
- Decisions and actions should provide for broad community involvement on issues which affect them.

In undertaking any mineral development project all aspects such as the technical, environmental, economic and social must be included in the planning and implementation.

Environmental and health considerations in any project must not be seen as placing undue constraints on the development options of a country. If a project is to be halted on environmental grounds, then alternative options which are environmentally sound must be provided to meet a country's development needs.

1.2 THE REGULATORY FRAMEWORK

Mining, like other industrial activities, is subject to environment protection laws, regulations and standards in all aspects of its operation.

In order to ensure proper consideration of environmental performance at the outset, early review of project proposals through Environmental Impact Assessment (EIA) or some similar method has become common. In many countries such an assessment is now a legal requirement.

Mining operations and environment protection requirements are commonly implemented through legislation, such as:

- Mining legislation
- Environmental planning and assessment legislation
- Environment protection legislation
- Occupational health and safety legislation

1.2.1 Mining and Environment Protection Legislation

Countries with a mining sector commonly incorporate environment protection requirements such as waste disposal, water quality controls, rehabilitation and occupational health and safety within the relevant mining laws. Others specifically target the public's health and safety, the environment and aesthetics in the legislated rehabilitation requirements. In addition, in concert with other jurisdictions, they develop a "one window" approach so that the proponent only deals with one regulator rather than many.

Many countries impose environment protection requirements through comprehensive and specific environment protection legislation. In addition other countries are moving towards this type of legislation. Such legislation will usually comprise:

- Environmental impact assessment or other environmental planning provisions
- Nature conservation, national park protection, flora and fauna protection, cultural and natural heritage
- Water quality protection laws
- Air emissions regulated under "clean air" laws
- Control of soil contamination by wastes and hazardous chemicals
- Other environmental issues, such as noise, vibration, subsidence, emergency response procedures; hazardous chemicals and wastes control.

As mentioned above, this can also be accomplished in some countries by memoranda or agreements between the various enforcement agencies. Health ministries and regulatory

bodies are now taking a more active involvement in the potential effects of mines on surrounding communities.

1.2.2 Environmental Assessment and Planning

The keystone to competent successful environmental management is planning. As a prelude to the planning a preliminary study or assessment must be undertaken to provide the benchmarks upon which the operations plan and rehabilitation plan must be based.

This is to ensure that environmental issues are addressed and that potential negative environmental impacts may be identified early in the project development. This preliminary or impact assessment is an integral part of planning and delivery of acceptable remediation.

The process is designed to ensure that all factors, geological, physical, biological, sociological and economic, are considered in the project design. It considers how the development of mining activity will affect the human population, the local and regional ecology, and the land use. Changes to water regimes and landscapes, the disposal of mine waste rock and tailings, together with other issues such as the logistics, have to be evaluated.

The «Environmental Impact Statement» (EIS) or «The Baseline Study» is prepared to:

- Identify any environmental constraints on a mining development
- Provide the basis for a plan for environmental management and protection
- Ensure that the decision makers and all stakeholders are fully informed of the nature of the development, its impact on the environment and the nature of the mitigating measures proposed.

1.2.3 Environmental Quality Standards and Criteria

Standards and norms provide the numerical limits to which industrial operations must be designed and managed. Criteria are scientifically determined. They are usually described in terms of physical, chemical, radiological, microbial and biological values. Guidelines set down the criteria and their range. When regulated and enforced by legislation they are standards. Guidelines and standards can apply to any of the following:

- Water quality in streams or rivers, effluent discharge, drinking water
- Air emissions, and/or workplace air quality
- Dust, hazardous chemicals or radioactivity levels
- Noise emissions, and vibration
- Waste disposal limits on materials permitted to be dumped (i.e., leachability, toxicity)

There are no international standards which apply universally, although agencies such as WHO have issued internationally recognised guidelines for air and drinking water qualities to protect human health. Each country usually eventually develops its own requirements and sets its own standards accordingly.

In the past, industrial discharge standards have usually been based on what is technically achievable by a plant. This may be more or less than the assimilative capacity of the local environment.

1.2.4 Enforcement Mechanisms

Maintaining and improving public health and the natural environment should be the principal objective of regulatory enforcement. Regulations for the protection of the environment from the impacts of mining operations are increasing in number and complexity. Governments usually set maximum permissible discharge levels or minimal levels of acceptable environmental quality. They will usually incorporate the best economically available technology standards, clean water and air laws, and a permitting procedure which may be the responsibility of local government within nationally approved standards. Ideally, the enforcement of environmental protection laws should be carried out by government inspectors who are committed to compliance of the laws, and are not involved with the promotion of economic development.

References

For further reading on this subject, the following texts are suggested. Additional references are to be found in Part IV.

Dhar, B B 1990. *Environmental Management of Mining Operations*.

Eggert, R E, ed. 1994. *Mining and the Environment: International Perspectives on Public Policy*.

International Council on Metals and the Environment, 1998. *Environmental Charter*

Tolba, M K and El-Kholy O A, eds 1992. *The World Environment 1972 - 1992: Two decades of challenge*.

United Nations Department of Technical Co-operation for Development and Development Policy Forum of the German Foundation for International Development 1992. *Mining and the Environment - the Berlin Guidelines*. Mining Journal Books, London.

United Nations Environment Programme 1994. *Environmental Management of Mine Sites*. TR 30.

United Nations Environment Programme Industry and Environment office 1992. *Environmental Aspects of Selected Non-ferrous Metals (Cu, Ni, Pb, Zn, Au) Ore Mining, A Technical Guide*. TR 5.

United Nations Environment Programme Industry and Environment office 1997. *Mining and Sustainable Development*. Industry and Environment, Vol. 20 No. 4.

World Bank, United Nations Environment Programme and International Council on Metals and the Environment 1994. *Development, Environment and Mining: Enhancing the Contribution of the Mineral industry to Sustainable Development*.

Chapter 2

The Mining Sequence

2.1 INTRODUCTION

There are six stages in the life cycle of a mine which embrace the full life span of a mine. The six stages incorporate land acquisition, deposit discovery, production decisions, production, mine closure to the final decommissioning, shut down and post-closure maintenance, as necessary. Smelting is an important component of mining activities, but, for the most part, it falls outside the scope of this manual. The six stages are:

- Exploration
- Project Development
- Mine Operation
- Suspension or Inactive
- Mine Closure
- Post Closure

A diagram showing the relationship between the various stages is shown in Figure 2.1.

It is important to note that mines have been abandoned at each of these stages. While this chapter is concerned primarily with introducing the concept of the various stages of a mine's development, if an abandoned site is to be rehabilitated, it is necessary to know at which stage this occurred, as it will affect the rehabilitation operations.

Figure 2.1. The Mining Sequence

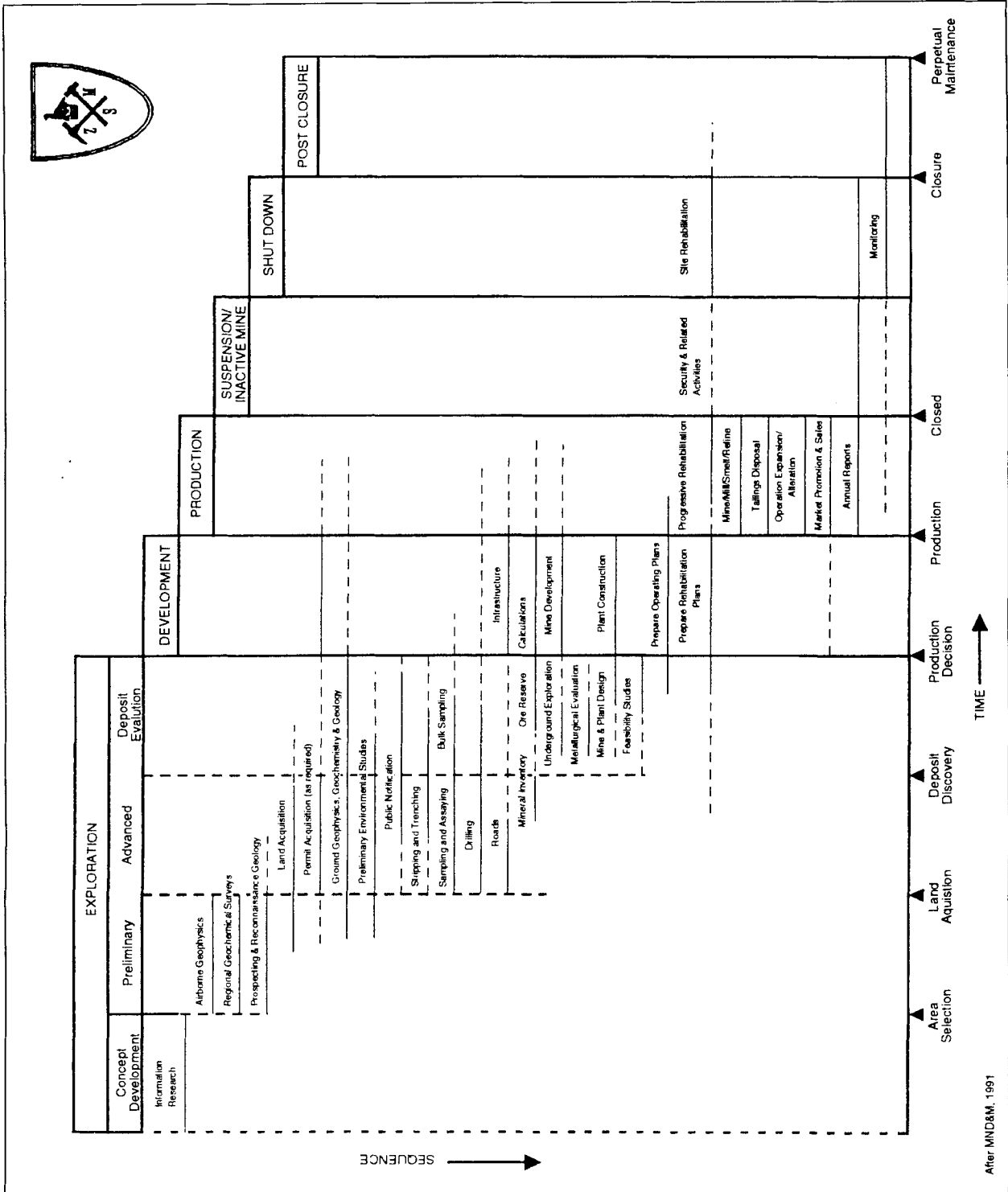

2.2 EXPLORATION

In exploration there are four broad categories. These are:

- the development of the concept
- the preliminary exploration
- the advanced exploration
- the deposit evaluation.

2.2.1 Concept and Development

The first sequence of mine development involves the gathering of information and researching the information to identify an area in which exploration might take place. It involves looking at the geological characteristics of the area, the mineralisation that may or may not be known, the sociological, cultural and economic conditions under which a mine development programme would be carried out.

2.2.2 Preliminary Exploration

Once the site or area has been selected, regional geological prospecting and reconnaissance are undertaken. This also may involve airborne geophysical and regional geochemical surveys. The structure of the programme would be dictated by the locality, the climate and the topography of the selected area.

If the indications of mineralisation look promising the land acquisition for the site would be started as well as the exploration permit (license) acquisition, if required. Ground surveys should be initiated and intensified towards the end of the preliminary exploration stage.

2.2.3 Advanced Exploration

This will involve the continuation of negotiations and permitting started under preliminary exploration. Ground geophysical, ground geochemistry and detailed geology investigations would be intensified, along with continued evaluation of the technical and economic viability of the ore deposit.

If the commercial indications look promising, a Preliminary Study to establish the baseline for rehabilitation should be undertaken on the site. Along with this, the local inhabitants, the public, the government agencies, should all be notified that the property is going into advanced exploration. In addition, this may involve more intense land disturbance such as major stripping and trenching, sampling and assaying, diamond drilling and the development of roads in order to access the property. All of these activities should be carried out with the environmental impact well in mind.

In addition a rehabilitation plan may be required for this stage of the programme, should the property not go to production.

2.2.4 Deposit Evaluation

The activities described under advanced exploration should now be continued and the mineral inventory and all estimates should be brought to a point where decisions can be made whether to develop the mine or not. Deposit evaluation might include underground exploration and would definitely include bench testing for mineral and metallurgical evaluation. The mine and the plant design should be started and completed and the feasibility studies relative to the economics of the programme should be carried out.

The Preliminary Study should have been completed at this time and two other very important steps, the « Operating Plan » and the « Rehabilitation Plan » for the site, should be prepared. The preparation of these plans may continue on into the next stage of mine development. Both plans are dynamic and should continually be amended, however, the bulk of the operating plan should be completed before full production begins.

This point is usually considered as the end of exploration. However in a good operation, exploration in areas nearby to the working part of the site should continue throughout the life of the mine until all viable ore bodies have been identified and recovered.

2.3 PROJECT DEVELOPMENT

As mentioned previously, during the development stages exploration should be continued.

This stage includes the development of the infrastructure, the development of the mine workings, the physical plant, the mill, the tailings site, the water management structures and the support facilities.

The rehabilitation plan, started at the deposit evaluation stage, should be completed prior to going into operation. It should include long range planning which may need to be based on conceptual ideas of the final land forms and uses for the restored mine site.

The operating plan should be completed at this time so that when production commences, the mine operations and progressive rehabilitation will go ahead concurrently.

2.4 MINE OPERATION

This is the point at which the mine will go into production. A regular revision of the ore reserve estimations, as mentioned previously, would continue. Progressive rehabilitation would also continue, having started at the time of advanced exploration. The mine, the mill, the smelter, and the refinery, if present, would also go into operation at this time.

Ongoing exploration and rehabilitation represent the two longest stages of the mining sequence. The life of the mine may extend for a period of as little as five, or perhaps over fifty years. This would be dependent on the ore reserves, the rate of production and the price of metals.

Depending on the products, market promotion and sales would be on going. On-site processing might include comminution to reduce particle size, flotation, gravity separation or magnetic, electrical or optical sorting, and ore leaching. As part of operations and rehabilitation, the management and treatment of tailings for disposal and waste waters would be a continuous requirement.

It is often required that annual reports on the progress of rehabilitation along with the annual report on production and the annual financial report be produced. In some countries there is also a requirement by the government to provide reports on environmental compliance, and sometimes an occupational health compliance as well.

2.5 SUSPENSION/INACTIVE MINE

Should there be a need for a temporary shut-down of the mine, proper environmental security must be put in place, as well as fiscal security and physical security. Environmental security must be maintained on the property and rehabilitation, if possible, should continue. During this period there needs to be continued monitoring. When the mine goes back into operation again, the procedures followed during the production stage would continue.

2.6 MINE CLOSURE

When the decision has been made to decommission and close down the mine the site rehabilitation should be brought to its final stages. All physical facilities, such as buildings, conveyor belt lines, silos and chimney stacks, should be removed and all logistics features such as roads and power lines should be appropriately rehabilitated. Also, closure monitoring should be established and continued into the next stage, which is the post-closure period.

2.7 POST-CLOSURE

This is the period following the shut-down and rehabilitation of the mine. If all of the environmental impacts have been appropriately or acceptably addressed, there may be a situation where the mine owner can “walk-away” from the site. Monitoring, however, will be required over a specific period of time to ensure that all the remedial work that has been carried out is stable and secure and working.

Under other active care conditions a site may have to undergo perpetual maintenance. This would be in addition to the post closure monitoring. Under passive care conditions continual or periodic checking and monitoring would take place.

Should a security deposit or financial assurance be required by the government or by some other regulating agency, the security deposit, or financial assurance, should be accrued starting during the period in which there has been a significant disturbance of the land under advanced exploration.

If this financial commitment is required, and development production has commenced, appropriate accounts should be established. The funds in the security deposit must be accessible to the mine operator as progressive rehabilitation is undertaken and on completion of all rehabilitation. This security deposit or financial assurance would be cancelled or terminated should, during the post-closure period, when a “walk-away” situation was attained.

2.8 EXERCISES

1. Elaborate on the six segments of the mining sequence based on your own experience. When and where was rehabilitation undertaken?
2. Compare the mining sequence for opencast, underground and alluvial mining. Are the same personnel involved in each segment? How does this affect the management of rehabilitation activities?
3. During the mining sequence, three essential studies or plans have to be undertaken. What are they, when do they start and when should they be completed? Explain how such studies are carried out.
4. For which of the segments can separate rehabilitation plans be developed? Explain your answer.
5. What are the implications for ground disturbance in each segment?

Further exercises to be developed by the trainer.

Chapter 3

Environmental Issues in Mining

3.1 INTRODUCTION

It is now generally accepted that with good planning, modern technologies and careful management, much of the degradation historically associated with mining can be avoided. Indeed, mining environmental practice is generally improving, as attitudes, technologies and regulations advance. The continuing challenge facing company and government personnel is to apply mining technologies, operational practices, and regulatory options so as to maintain output while minimising the damage.

The major environmental issues facing countries were summarised in Agenda 21, the global action plan agreed by countries at the 1992 Earth Summit in Rio. Priorities for action included protection of inland and marine waters, global atmospheric protection, toxic chemicals and wastes. The urgent need for action by governments, international organisations and industry was stressed, with more initiatives called for on cleaner production methods, technology transfer, local capacity building and training. In addition to action at the national level, the increasing number of agreements on international conventions on hazardous wastes, climate change and biodiversity demonstrate the growing commitment to environmental action around the world.

The immediate pollution impacts that affect local communities and ecologies are usually a first priority for action by mining companies and governments. Company and national environmental plans will indicate what these priorities are and how they should be addressed. Many non-governmental organisations (NGOs) are also active at the local and national level.

This chapter will briefly explain the major environmental issues concerning mining and give an explanation of the best way in which they can be addressed by governments and industry. While it is not concerned directly with rehabilitation, its purpose is to set the overall environmental context for rehabilitation and to outline other environmental issues which may need to be addressed concurrently by mining practitioners and regulators. In this sense, it complements Chapter 1, which addresses the national environmental management and regulatory contexts.

The major phases in mining which impact the environment are:

- Exploration - including surveys, field studies, drilling and exploratory excavations. Some land disturbance and wastes already occur at this stage.
- Project development - includes roads and buildings, access tunnels, erection of treatment plants, overburden stripping and placing, preparation of disposal areas, construction of service infrastructure, power lines and generating plants, water supplies and sewerage, laboratories and amenities.

- Mine operation - underground or surface mining, hydraulic mining in or near river beds. Newer processes may include heap-leaching of ore or tailings, and solution mining of buried deposits.
- Beneficiation - on-site processing may include comminution to reduce particle size, flotation using selected chemicals, gravity separation or magnetic, electrical or optical sorting, ore leaching with a variety of chemical solutions.
- Associated transport and storage of ore and concentrates may be a handling risk and can be a handling risk and can result in localised site contamination.
- Mine closure - rehabilitation is best done progressively rather than at the end of life of the mine. While the closure and rehabilitation is intended to mitigate environmental impact, it is important that it does not itself create secondary effects through excessive fertiliser use, spread of weeds, siltation and incompatible landscape features.

3.2 OVERVIEW OF ENVIRONMENTAL ISSUES IN MINING

Without adequate preventive measures mining can greatly alter the environment around the site. There may be changes in landscapes, water tables, and animal habitats, as well as air and water pollution, and permanent degradation of land. Toxic chemicals, dusts, heat and noise can seriously affect the health of workers, and sometimes their families. Impacts may occur from mining itself or from ancillary operations such as transport, laboratories, etc. Some of these impacts may occur far from the mine itself.

Serious indirect effects may occur in addition to the impact at the mining site itself. The development of remote tracts of land may introduce pest species of plants and animals, and can bring new diseases into an area. Access roads encourage settlers to open the adjacent land to exploitation, often causing degradation from uncontrolled land-use practices.

Conversely, some impacts such as access roads, improved water supply, and provision of local employment are positive developments highly appreciated by many governments.

The major potential environmental impacts to be evaluated and controlled are summarised in Table 3.1. While there are many, very important socio-economic impacts associated with mining, these fall outside the scope of this manual.

Public health concerns beyond the boundary of the mine site need to be addressed. Communities nearby or downstream from mining activities are not immune from the potential effects of mining operations. Three impacts are particularly important (see after Table 3.1):

Table 3.1 - Some Potential Environmental Impacts of Mining

Environmental impacts

Destruction of natural habitat at the mining site and at waste disposal sites
Destruction of adjacent habitats as a result of emissions and discharges
Destruction of adjacent habitats arising from influx of settlers
Changes in river regime and ecology due to siltation and flow modification
Alteration in water-tables
Change in landform
Land degradation due to inadequate rehabilitation after closure
Land instability
Danger from failure of structures and dams
Abandoned equipment, plant and buildings

Pollution impacts

Drainage from mining sites, incl. acid mine drainage and pumped mine water
Sediment runoff from mining sites
Pollution from mining operations in riverbeds
Effluent from minerals processing operations
Sewage effluent from the site
Oil and fuel spills
Soil contamination from treatment residues and spillage of chemicals
Leaching of pollutants from tailings and disposal areas and contaminated soils
Air emissions from minerals processing operations
Dust emissions from sites close to living areas or habitats
Release of methane from mines

Occupational health impacts

Handling of chemicals, residues and products
Dust inhalation
Fugitive emissions within the plant
Air emissions in confined spaces from transport, blasting, combustion
Exposure to asbestos, cyanide, mercury or other toxic materials used on-site
Exposure to heat, noise, vibration
Physical risks at the plant or at the site
Unsanitary living conditions

1. Catastrophic failure of a dam retaining mining wastes. Such failures have been responsible in recent years for deaths in neighbouring communities and environmental damage on a large scale.
2. Visible pollution and health problems from airborne and gaseous discharges. High noise levels, low frequency vibrations, and increased road traffic and associated accidents are similar intrusive health concerns.
3. Insidious pollution, such as heavy metal or other chemical contamination of drinking water, soil and local food supplies. The accumulative effects of this contamination may decrease life expectancy.

Potential Major Pollutants

We will now look at some of the major pollutants that can be expected from a variety of point and diffuse sources.

Potential water contaminants may include:

- suspended solids and sediment from runoff and processing operations
- acids from various processes
- acid mine drainage during and after site operation (see below)
- heavy metals leached from wastes and concentrates around the site
- sulphate, thiosulphate, polythionates etc. from acid drainage
- arsenic and other salts from oxidised mine waters
- mercury, if used in the process, or from ores
- cyanide if used in leaching processes
- oil and fuels from ancillary operations
- other processing chemicals as may be used on the site
- groundwater constituents that may be pumped or discharged off-site
- sewage from the site

The problem of acid mine drainage is particularly serious at many sites, and frequently persists after mine closure. Quantities and concentrations of such drainage depend on site-specific characteristics, but are usually characterised by low pH and elevated content of heavy metals and dissolved salts. The oxidation of any iron content adds decolouration and deoxygenation of waters to the problems of metal toxicity.

These pollutants can cause considerable damage to natural waterways, and in some cases to groundwater. Excessive discharges will damage natural ecosystems and affect local fisheries, and may deprive downstream populations of a clean water supply. In some cases sediment may block river channels and affect boat transportation.

Pollution does not necessarily cease when the operation shuts down. Discharges from contaminated sites and waste dumps may last considerably longer than the economic life of the mine.

Potential air contaminants may include:

- dust from the site or from processing. Composition is location-specific
- natural gas from underground mines
- CFC losses from refrigeration plant and air-conditioning
- other air contaminants important in workplace safety as shown below

Air pollution affects mainly workers on the site, although in dry climates neighbouring populations and mine settlements may also suffer an effect from dust.

Workplace Safety

In addition to risks from accidents, which are discussed under 3.5 below, general exposure to dust and fumes may seriously damage the health of workers. Some chemical agents used in processing present occupational risks if not correctly handled or controlled. Care in handling explosives is of course a major preoccupation at mines.

Of particular interest are:

- cyanide, mercury
- acids, especially in concentrated form, and as mists from processing
- flotation and extraction agents, Xanthate dust
- asbestos, solvents, herbicides and other pesticides used on the site
- toxic machine oils, including PCBs (if still used)
- heavy metal residues, especially, arsenic, mercury, lead
- gases in confined spaces from engines, blasting and ancillary operations.
- explosives

The quantities of the above will vary from site to site, and no general indication can be given as to how much to expect.

Health impacts will usually be of a chronic nature, unless major exposure incidents occur. Often such health impacts are permanent, and in the case of asbestos, mercury and other heavy metals may even lead to eventual death. In some cases workers' families have been affected by the same illness due to contaminants brought into the home by the workers on their clothes, although the effects are usually less severe.

Exposure to excessive noise is a serious risk in many mines. Noise may be from machinery, drilling, blasting and transport vehicles.

Wastes

There are many sources of waste within a mine. Some is generated in great quantity but is of limited toxicity. Mines may also produce smaller quantities of hazardous wastes from ancillary operations, and these require special care in handling and disposal. Common wastes include:

- overburden from the mine
- gangue and waste rock from the mining
- solid or sludge processing residues
- ancillary sources such as workshops, laboratories, housing derelict equipment and building
- unused chemicals, fuel or oils

Leaching from dumpsites subject to acid mine drainage can lead to serious water pollution.

Disposal of the more minor wastes can also result in soil and groundwater contamination if they are soluble or subject to eventual leaching. Direct loss of human life is uncommon, but slow leaching can have serious ecological consequences for many years.

Environmental Emergencies

These may result from the failure of mining operations themselves (slope failure, rupture of tailings dams, collapse of underground drives) or be associated with unsafe waste disposal operations (see above). There have also been a number of dramatic accidents during the transport of chemicals or fuels. The loss of a barge-load of cyanide chemicals for example can have dramatic effects on river and offshore ecosystems.

Large scale waste disposal operations may present risk of catastrophic failure of tailings dams or heaps, collapse of dump heaps and so on. Such failures have sometimes led to major loss of life at the site or at nearby communities.

Site Remediation

It is now expected as a matter of course that a worked out mine site will be rehabilitated for some other specified use, but there are many older sites where this was not done. The most efficient time to plan for closure is during the actual planning stage of the mine itself, as this is where the location of disturbed areas and waste dumps is considered. Once established, these areas are difficult to change.

Rehabilitation must pay attention to future possible uses of the site, as well as changes in the hydraulic regime of the land. Often the landscape aspects must also be taken into account.

Stabilisation of old dumps against erosion and revegetation is a costly exercise if it is not done progressively.

Remediation of older, "orphan" sites is one of the crippling legacies of past mining practices. Water pollution, unsafe structures and derelict land are often part of this legacy.

Other Issues

While the major issues above are well known by most miners, a number of more recent environmental issues have also arisen in recent years. Because their impact are often less immediate or less visible they are frequently overlooked. These newer issues include:

- transport and recovery of hazardous mine waste
- hazardous chemical residues, and their disposal
- chemical safety
- use of ozone depleting substances at a mine site
- emissions of greenhouse gases, (including carbon dioxide from energy use)
- protection of natural habitats (biodiversity)

The importance of habitat and species protection is often underestimated by mining professionals, and even by the neighbouring communities who often tend to have a more local vision of environment. Nevertheless the protection of 'biodiversity' is one of the environmental challenges of our time which impacts particularly on operations in natural areas. While mining will inevitably create some disturbance during the operation, much can be done (and sometimes has been done) to enhance a site for wildlife both during and after mining.

It is becoming more important for mine managers to become more conscious of all the above issues, and to address them along with the better known and more major impacts of water and air pollution, mine waste disposal, and land degradation. It should also be remembered that the environmental agenda is still evolving, and further changes in priorities and issues no doubt lie ahead.

3.3 PREVENTION OF IMPACT AND CONTROL OF POLLUTION

3.3.1 Management Implications

The company should set itself measurable environmental targets, and establish a clear line responsibility for achieving these. There must be personnel with environmental expertise who carry out regular monitoring and report to top management. Senior management should require periodic audits of environmental performance. There should be adequate finance and staff to carry out these activities.

Monitoring is required to obtain baseline information about environmental quality before operations begin, and to examine periodically the impact of the operation on water quality (surface and groundwater), on native species, on chemical contamination of soils, and on human health (both workplace, and outside if necessary).

Monitoring also serves to identify economic loss of raw or refined material, and general operating inefficiencies. The monitoring data will be continually reviewed, and also provide input to the audit process.

3.3.2 Site Location

Little can be done in respect to the siting of the mining operation itself as the location of orebodies is fixed. There may be some possibility to adjust the mine development plan to avoid sensitive areas, however. There is often more flexibility to adjust ancillary operations such as exploration, processing, services, transport links, and infrastructure, although an additional cost may be involved.

If the environmental impact is still too high as identified through an EIA, and if technical measures cannot overcome the basic problem, then the mine should not be developed. This may be the case in sites of natural heritage, of exceptional habitat value, close to cultural sites or inhabited areas, or where pollution will irrevocably impact other economic activity such as fisheries, agriculture or tourism.

3.3.3 Minimisation of Impact

Mine development and operation

A number of mining techniques are in widespread use depending on the site-specific characteristics, and the environmental and other constraints that may be imposed. Among the techniques that could be considered are:

- The choice of using open-cast or underground mining will depend largely on economic grounds based on the depth and concentration of minerals, however environmental impact may have an influence;
- Immediate progressive backfilling while mining is still under way is often not favoured for practical reasons, but could be considered in special cases;
- In some cases solution mining may be used instead of excavation. Decisions about which chemical agents to use, e.g. cyanide, will depend partly on environmental risks;
- In-situ heap leaching is often of lower impact than removal of ore for processing elsewhere. Available processes include chemical and biological leaching;

- Extraction using mercury is not now recommended, but is still used by small-scale miners who ignore the obvious risks;
- Hydraulic mining in open river systems is less and less acceptable due to the immediate damage to river ecosystems. Similarly, dredging can cause significant modification of land and river systems.
- Prevention of AMD is achieved by careful predevelopment planning, and implementation of progressive reclamation of disturbed areas and waste dumps. In the case of tailing dams, permanent subaqueous disposal reduces the rate of oxidation of pyrites, and hence acid generation.

Beneficiation and processing

The processes chosen will depend on the ore characteristics and location, and so it is difficult to generalise. There has however been considerable research into cleaner, safer options. For each project these options should be evaluated by someone familiar with the particular mineral sector to ensure that the final choice is environmentally as well as economically sound. The combination of "low-waste process plus effluent treatment plant" needs to be evaluated for best overall performance.

The use of safe, low-impact processing chemicals is one of the factors to be considered. A number of national and international information sources now exist to advise on impact and availability of suitable chemicals. A list of common chemicals used in flotation is shown below.

Table 3.2. Flotation Reagents used in Base Metal Concentrators

Acids	Modifiers
Sulphuric acid	Copper sulphate
	Sodium cyanide
Alkalis	Zinc sulphate
Lime	Sodium sulphide
Sodium carbonate	Sodium silicate
Sodium hydroxide	SO ₂
	Starch
Collectors	Frothers
Potassium amylxanthate	Dowfroth 250
Potassium ethylxanthate	Hexylic alcohol
Potassium isopropylxanthate	Pine oil
Aniline dicresyl dithiophosphate	HBTA frother
Gas-oil	
Amine	

Dust control

Dust can be controlled on a mining site through careful design and selection of excavation, transport and crushing equipment, and paying attention to dust hoods and shields around fixed plant. Forced air ventilation systems should be fitted with dust extractors such as cyclones, bag filters or wet scrubbers. Ore handling operations should be examined to minimise the height of fall of ore, for example. Water sprays are more effective in preventing dust generation than in removal of dust from air. Dust suppression on roads is also necessary, however the use of waste oils and process effluents for this purpose may itself give rise to secondary environmental problems, and such methods should be carefully assessed.

Storage dumps should be protected against wind, or otherwise treated to reduce dust generation (also to reduce economic loss of material). Dust from dried out tailings dams may also need to be addressed as many dried-out fines are readily dispersed by wind. Revegetation is usually the cheapest option. The dam structure itself may need some dust control measures such as covering or chemical stabilisation.

Noise reduction

Machinery should be inherently low-noise, or else fitted with noise shields. Noise should also be one of the criteria for choice of mobile transport equipment. Traffic movement should be planned to avoid as much as possible steep grades and noise sensitive areas (habitats as well as human dwellings). Engines should be switched off when not in use for significant periods. As a last resort only should personnel be required to wear hearing protection and be constrained to sound-proof cabins.

3.3.4 Recycling and Reuse

Mine spoil is usually too voluminous to be reused except for minor uses.

Drainage water from the mining site is not usually recovered, except in dry regions where water recovery may be extensively practised.

Greater potential exists for reuse of wastewater and processing effluents. The segregation of various waste flows may allow for a greater degree of flexibility in re-use. The characteristics of composition, use and discharge will determine the options in each case.

Unused or spent processing chemicals frequently present additional opportunities for recovery, particularly in view of their often considerable commercial value. Recovery and reuse of processing by-products is another potentially important area, although again the possibilities depend very much on the specifics of the process in use.

3.3.5 Effluent Treatment

Technologies

Mine drainage and effluents will often need treatment prior to discharge. Source segregation may make it easier to treat special waste streams such as processing effluents. Some specific methods in common use are:

- Neutralisation and precipitation for free acid and heavy metals. These factors usually occur together, and the treatment addresses both simultaneously. Choice of neutralising agent depends on the heavy metal content. Some cheap neutralising agents such as calcium carbonate do not achieve a sufficient increase in pH to precipitate some metals. The use of lime results in the production of gypsum, which may subsequently block pipes and machinery;
- Oxidation may be necessary as pre-treatment to achieve better removal of some metals such as iron;
- Separation of precipitated metal hydroxides requires some care as these may not settle well by themselves. Settling agents and sludge thickening may be required. The resulting sludge must itself be properly disposed of in a separately designed impermeable site to avoid causing groundwater pollution;
- Cyanide is often treated in open ponds rather than specific treatment plants (this "treatment" amounts to little more than simple evaporation of cyanide in most cases). Care must be taken that levels of cyanide gas do not build up under static air conditions to poison workers or wildlife. High levels of cyanide should be treated by chemical oxidation in a separate plant;
- Thio-salt removal can present a problem as no cheap chemical oxidation methods are available. Biological oxidation requires design of specific systems;
- Arsenic is often a difficult metal to remove. Treatment methods include carefully designed coprecipitation procedures using ferric hydroxide, or calcium salts. Pre-oxidation may be required. Disposal of the sludge must be in specially designed impermeable sites;
- Treatment of beneficiation effluents must be done according to the specific composition of such liquors. Attention is required to ensure the adequate separate treatment of periodic slugs of high concentration wastewater that arise when tanks are cleaned or solutions are discarded. Treatment plants have in the past often not been designed to cater for such slugs.

Disposal of Processing Effluents

Effluent from mines and processing operations is usually discharged, after suitable treatment, to water bodies near the site. The discharge conditions depend on the characteristics of the local water bodies.

In dry regions pumped water and effluents may be discharged to evaporation basins, however precautions need to be taken to avoid contaminated seepage from such basins affecting the groundwater. Disposal to tailings dams may be feasible for some effluents if the volumes are within the capacity of the dam.

3.3.6 Waste Disposal

Solid Waste

More options often exist for managing waste disposal than for the mining operation itself. Waste disposal options may even influence the design and development of the mine, and so are an integral part of the choice of operation. The location and design of tailings dams and water impoundments is determined by local conditions and engineering feasibility. It is true however that severe geographical and climatic conditions have caused many supposedly "safe" structures to fail, and a high degree of design safety needs to be ensured.

As a rule mine waste has to be disposed of close to the point of excavation. There are different possibilities depending on the amount of waste generated, its form and chemical composition, and of course the characteristics of the site itself.

Immediate backfilling in the excavation is often not possible due to the human activity still going on there, and to avoid covering as yet unmined orebodies.

Surface disposal is particularly difficult on hill sites and in confined valleys, but elsewhere also consideration should be given to ecological values and safety aspects at the disposal site.

Waste and tailings heaps near buildings or other sensitive structures need particular care to ensure that they are stable in the long as well as short term. Serious loss of life has occurred in the past where some tailings deposits have collapsed into nearby buildings. The effect of possible seismic events should be taken into account.

Ongoing control of seepage and surface water which affect the stability of waste deposits needs close attention.

Tailings and solid waste disposal directly into water bodies generally results in too much environmental damage to be recommended.

Tailings dam construction is a well established technique, but close attention must be given to stability and permeability of the dam, especially if predominantly local materials are used for construction.

Important features of tailing dam design include:

- careful design based on construction materials available
- adequate site preparation
- close attention to grading of construction materials
- control of seepage through and around the dam
- monitoring of the phreatic surface behind the dam
- control of surface runoff water on the dam face
- diversion or control of flooding events
- ready supply of construction material for maintenance and repair

Other Wastes

Other wastes may come from ancillary operations such as laboratories, power plants and maintenance depots, living quarters, transport yards and so on. These waste include a range of hazardous chemical residues such as paints, oils, lubricants, herbicides, solvents and cleaners. A big mining operation can generate substantial quantities of such wastes. A clear programme of minimisation, reuse and proper disposal needs to be prepared, including the designation and construction of a specially prepared disposal site.

Garbage from living quarters and office operations also needs proper disposal, generally in a different way to the above. This does not exclude the same site being used, however separate handling, and disposal in a different part of the site is recommended. Garbage and putrescible waste should be regularly covered with inert material.

Some special waste must be taken away from the site and sent to specialised destruction facilities elsewhere, e.g. pesticide residues, PCBs, solvents. This may be able to be arranged through the supplier of materials.

The reuse, burning or other disposal of waste oils should be carefully thought out before the mine opens. Waste oil should not be disposed of to landfills or otherwise to ground. Its use as a dust suppressant is no longer generally acceptable. The same is true of solvents.

Where heavy electrical equipment is used, this should be chosen to be free of PCBs. Where PCBs are still found in existing equipment, this should be removed and sent to specialised disposal facilities elsewhere (generally in developed countries) in consultation with the supplier. The cost of such incineration is usually high.

The establishment of proper disposal procedures for specialised wastes does much to sensitise the workforce to environmental issues, and has a useful outcome in terms of individual commitment to pollution control.

3.3.7 Ancillary Operations

Roadways, borrow areas, stockpiles, parking areas and equipment depots can constitute a significant proportion of the surface area that is developed in a mine. Runoff, erosion and contamination from such areas can be very significant, and accordingly environmental control should consider these as closely as the mine itself.

While environmental control at these points is not necessarily difficult, it must become an important element of a site working plan, and effective design and preventive action needs to be taken.

Where extensive use is made of air conditioning and cooling of deep mines, the refrigeration plant needs to be chosen (or be retrofitted) to be free of CFCs. Such equipment is now commercially available. Fire protection systems should avoid the use of halons.

3.3.8 Accidents and Emergencies

All mines should make provision for dealing with unexpected incidents, whether natural phenomena or due to equipment failures. Collapse of mines or tailings structures is an ever-present risk, and worst-event scenarios can help the management plan for such eventualities. The possibility of chemical accidents during transport or storage (or indeed use) also needs to be given some attention. The same is of course true of hazards from fuels or explosives. Where a neighbouring community is close by, liaison with community leaders and civil defence authorities is essential. The APELL process, a programme of UNEP Industry and Environment, is a useful aid in preparing for emergencies.

3.3.9 Site Remediation

Public opinion is more and more expecting industry to assume more of the burden of clean-up of past sites. Company managers can respond by including remediation of old sites into their present on-going operation so as to gradually work towards a long-term improvement.

3.3.10 Chemical Safety

This includes control of exposure to contaminants arising from the ore as well as materials brought into the site. Mine managers should take a life cycle management approach to the chemicals they use. This may require new skills, new facilities and perhaps new monitoring and auditing systems.

3.4 SUMMARY

Mining can have many serious negative impacts on the environment. Mining can change the landscape, alter water tables, disrupt the local ecology, generate serious air and water pollution, and permanently degrade large areas of land. Exposure to toxic chemicals, dusts, heat and noise can seriously affect the health of workers, and sometimes their families.

A number of serious indirect effects may also occur, and in extreme cases may even diminish national development potential through damage to the natural resource base.

Aspects which need to be addressed in mining projects are:

- Location of the mine, and of ancillary operations must be carefully assessed, and appropriate mitigation measures taken in the planning stage;
- The mining technologies that are most suitable to the environmental as well as economic situation should be selected;
- Safe, low-waste processing and beneficiation methods should be selected for each ore, with attention being paid to effluent recirculation and treatment;
- Technologies and operations should maximise the opportunities for recycling and re-use of residues and effluents;
- Effective treatment should be given to effluents, drainage and runoff water to ensure that all discharges comply with environmental requirements, even under non-standard climatic events. Particular attention should be given to mine drainage during operation and after closure;
- Dust control is important at most mines, and involves both equipment design and operational procedures;
- Solid waste disposal activities must be appropriately located as well as conservatively designed. Attention needs to be given to long-term stability of disposal areas and tailings dams. Drainage and leachate from disposal sites must be minimised by appropriate location, design and ongoing maintenance. Special disposal sites may be established for chemical-type wastes, sludges and common refuse;
- Control of impact from ancillary operations such as roads, parking areas, depots, borrow areas etc. needs to be an important part of a site working plan;
- Safe handling of chemicals and wastes must be ensured. Some common chemicals such as PCBs and CFCs should be phased out;

- Site rehabilitation should be progressive during the active life of a mine. Upon closure all equipment should be removed and final site restoration effectuated.

A number of more recent issues to be considered include use of toxic chemicals, disposal of hazardous waste, release of ozone depleting substances, accident prevention and preparedness, and generation of greenhouse gases such as carbon dioxide and methane.

While environmental assimilative capacity varies greatly from one location to another, some broad emission and discharge target guidelines are given as a starting point for project design.

The use of specific project design criteria can help to confirm that all relevant actions have been taken to minimise environmental impact.

Within the operating company environmental control must become a priority to be managed rather than an unwelcome nuisance to be attended to when problems start to appear. Effective control only occurs when corporate management adopts environmental performance goals and a suitable management structure from the outset.

If allowed to go unchecked, these impacts can destroy natural resources, and diminish the long-term development potential of a country. Fortunately many deleterious effects can be avoided through a combination of better project planning, use of low-impact technologies, and careful ongoing operation of a site.

3.5 EXERCISES

1. How does your mine impact the environment? Brainstorm for several minutes.
2. Identify the most important impacts from Table 3.1 in each mining phase. With which of these have you had personal contact? Prioritise them for you country or mine.
3. Which of the environmental problems in question 2 are explicitly included in your country's national environmental management programme and national legislation?
4. What community impacts does your mine, or a mine well-known to you, have?

Study Projects

1. Review the quantities of waste generated by different types of mining activity.
2. How has environmental legislation evolved in your country?

Further exercises to be developed by the trainer.

References

For further reading on this subject, the following texts are suggested. Additional references are to be found in Part IV.

Australian Environmental Protection Agency 1995 (ongoing). Best Practice Environmental Management in Mining

Dhar, B.B., New Delhi: Ashishi Publishing House, 1990. Environmental Management of Mining Operations.

Mining Association of Canada (MAC), 1990. Guide for Environmental Practice.

UNEP 1991. Environmental Aspects of Selected Non-Ferrous Metals Ore Mining (Technical Report Series N°5).

UNEP, 1983. The Restoration and Rehabilitation of Land and Soils after Mining Activities, Environmental Management Guidelines.

UNEP, 1990. Storage of Hazardous Materials: A Guide for Safe Warehousing of Hazardous Materials (Technical Report Series N° 3).

UNEP/IRPTC, 1985. Treatment and Disposal Methods for Waste Chemicals.

UNESCO/UNEP, Vartanyan, G.S. (Ed.), 1989. Mining and the Geoenvironment, Geology and the Environment, Volume II.

US Bureau of Mines Information (USBM), 1985. Control of Acid Mine Drainage (Circular n° 9027).

WB/UNEP/WHO, 1989. The Safe Disposal of Hazardous Wastes: The Special Problems of Developing Countries, ISBN-O-8213-1144-1.

Chapter 4

Occupational Health and the Mining Process

4.1 INTRODUCTION

Mining involves the handling, transportation and processing of large quantities of material. During these processes the workforce may be exposed a variety kind of health related impacts. Most are the same as in any other industrial complex but some, due to the nature of mining operations, require a special consideration. Much research is related to chemical exposures, such as the impact of heavy metals on workers, as well as on the physical aspects which can affect the health e. g. injuries to the sceleto-muscular system from strains, and stress fractures, accidents and falls. Thermal environment, illumination, dust and the atmospheric pressure can also be contributory causes of injury or illness. Working with noisy equipment (i.e. drills, loaders, mechanical shovels, diesel locomotives, trucks etc.) and intense vibration tools which could lead to deafness or the so called “dead hand” syndrome, respectively, are two further examples of occupational health hazards faced by for mine workers.

In the this chapter two main forms of occupational health problems are emphasised;

- Physical impacts on occupational health, and
- Chemical effects on occupational health.

Physical impacts include noise and vibration, extremes of temperature, particulates, and atmospheric pressure. Chemical effects concentrate on issues such as airborne particulates, gaseous contaminants, cyanide and ingestion and inhalation of heavy metals of heavy metals. The possible biological impact on occupational health related to mine workers are also addressed. Later in this chapter an introduction risk reduction methods is presented, in which different methods are described to minimise the possible risks mentioned in this chapter.

4.2 THE PHYSICAL IMPACTS ON OCCUPATIONAL HEALTH

4.2.1 Noise

As mentioned before miners are often exposed to high noise levels either in underground mines caused by e.g. drilling and conveyer equipment or on the surface by locomotives, trucks, loaders and excavators. Grinding mills and air compressors are noise sources of high level in beneficiation plants. Occupational deafness can readily occur from an exposure to noise in excess of 85 dBA for 8 hours a day for a long period of time. Auditory fatigue is the temporary hearing loss caused by loud noises and in its most mild form decreases in hearing capacity for a limited period of time. The hearing loss may become permanent and irreversible if a worker is exposed to high noise level over a prolonged and repeated period of time. The nervous and cardiovascular systems are adversely affected too from the impact of high noise levels. Research concerning hearing losses from workers proved that losses start in the frequencies of about 4000 Hz. The regulatory standard in many countries is 85 dBA although it is

known that there are already some risks of hearing losses at 75 dBA. The 85 dBA is regarded commonly in some countries as the “acceptable risk” for occupational exposure to noise. The relevant WHO/IPCS Environmental Health Criteria document, and other specialised literature, explain the health effects of noise.

4.2.2 Vibration

Hand pneumatic tools, for instance those used for scarifying when used over a long time of period, are mainly responsible for health problems related to vibration. Nerve stimulation, spasms on the arterioles, neurovascular alterations in the hands, muscular weakness and muscle atrophy, tenosynovitis and degenerative alterations (primarily in the ulnar and median nerves) have been observed.

4.2.3 Thermal Impacts

Dehydration (heat exhaustion), heat cramps, heat stroke, salt depletion and spasm in legs arms and stomach are all possible results of excessive heat exposure. In underground mines, the adjacent rock walls, the intake air, the machinery and the workers themselves are the main sources of heat. Rock temperature for instance can rise by as much as 1 °C per 150 m depth.

Combinations of factors temperature, i.e. humidity velocity of the air and radiant heat may result in serious heat stress for some mine workers. Abrupt changes of temperature when leaving the hot underground mine can lead to a higher prevalence of colds, flu and bronchial disorders.

Other influences are more related to open cast mining. Absorption of solar radiation by dark coloured rocks may lead to an additional heat source through heat radiation. In contrast to dark coloured rock, pale rock (e.g. quartzite) does not absorb as much solar radiation, instead it reflects more ultra violet radiation which may effect the eyes (i.e. cataracts) if not properly protected. Moreover infra-red can cause also conjunctivitis and sunburns.

Workers exposed to extreme cold, particularly in open cast operations, may suffer from frostbite in the hands and feet, and when the environment is very cold, general hypothermia can become a serious health disorder, especially for poorly clothed surface workers.

4.2.4 Atmospheric Pressure

This problem is most relevant to mines operated in high altitudes. It is essential to provide an acclimatisation period for new workers, at least one week to enable their bodies to adapt physically to the lower oxygen pressures. Failure to do this might lead to respiratory problems and physical accidents through fatigue, nausea, or even, blackouts.

4.3 THE CHEMICAL IMPACTS ON OCCUPATIONAL HEALTH

4.3.1 Airborne Particles

Both open-cast mining and underground mining and waste handling produce airborne dust at many stages in the mining process, excavation, drilling, conveying, waste rock piles, tailing dams, unsurfaced haul and access road, and during the beneficial process (i.e. crushing process).

As long as they are in active use, mining excavations and waste handling produces large quantities of dust. After abandonment this emission usually decreases quickly except in the vicinity of uncovered bare soil surfaces.

Dust emission from tailing dams becomes a more significant source of dust problems after a mine is abandoned. Especially as a result of waste dewatering leading to the exposure to wind of fine, dry material on the surface. Windy weather may lead to “dust storms” when an appropriate action to cover dewatered tailings dams have not been undertaken.

This dust mainly consists out of the compounds which are mined. During the mining process material from the disturbed surface, from the mineral and the removed rock is partly released as dust into the air. Hazardous components like lead and nickel, which are very toxic and also free crystalline silica, cadmium and arsenic associated with gold in sulphide ores can be found on some mining activities. Some polymetallic ores contain mercury which is also high toxic.

The impact of dust to the health of labour is twice; firstly the particles can be inhaled like silica dust for instance and cause, in this case, silicosis. Secondly the chemical substances, if soluble, can pass into the blood system and may lead to organic degeneration (e.g. degenerative effects in internal organs, particularly in liver, kidneys and heart are associated with arsenic).

4.3.2 Gaseous Contaminants

Diesel engines and blasting fumes in underground mines generate contaminants like carbon monoxide, nitrogen oxides, sulphur dioxides, carbon dioxide and a significant amount of volatile hydrocarbons. Carbon monoxide and nitrogen oxides levels should be carefully monitored. Carbon monoxide binds strongly to haemoglobin and that prevents the oxygenation of the blood. The result is headaches, dizziness, drowsiness and may lead to unconsciousness or even death. Nitrogen oxides, generated by blasting operations, internal combustion engines welding and cutting operations, may lead to lung and respiratory tract problems, chronic bronchitis, or worse emphysema. Other observations are shortness of breath, teeth decay and nasal ulcers.

Aldehydes from diesel engines and sulphur dioxide, affect the upper respiratory tract and fine aerosols like benz-d-pyrene can be carcinogenic. Some mine workers, may be exposed

to isocyanates from polyurethanes used in insulation. These substances are strong respiratory irritants and may induce allergies (e.g. asthma and skin complaints) in susceptible workers.

4.3.3 Cyanides

Ingested cyanides, used for extracting for instance gold, are extremely toxic. It also can penetrate through the skin and reacts aggressively with the respiratory system when inhaled. Thus, direct contact as well as inhalation must be avoided.

4.3.4 Heavy Metals

It would be too extensive to explain the impact of all toxic metals; cases of toxicity have been reported for as many as 45 different metals.

There are fine dust particles of certain elements or compounds from ores which can be absorbed through the lung and exert toxic effects on the body (see also section 4.3.1 “Airborne Particles”). Examples include mercury, manganese and arsenic. Mercury poisoning has been observed in miners exposed to cinnabar ore. Especially in Brazil and other Amazonian countries, where mercury is used to produce a mercury - gold amalgam, the traders inhale high levels of mercury vapour. Manganese poisoning, manifested as a Parkinson-type disease, has frequently been reported in miners exposed to manganese ore. Arsenic compounds affect the central nervous system and the vascular walls and as mentioned previously degenerative changes in internal organs, particularly in liver, kidneys and heart were observed.

4.4 BIOLOGICAL IMPACTS

Temperature and humidity, presence of stagnant water, scrap food and lack of hygiene through, for instance, unavailable toilets in the tunnels, which could lead to contamination (hand to mouth via food) and may cause diarrhoea are health related factors. It also may increase the problems related to parasites and other biological agents. In addition to that rodents and insects may find good conditions to spread out and to act as vectors in the transmission of diseases. Some of them, like ankylostomiasis and mycosis are wide spread in some countries.

4.5 RISK REDUCTION METHODS

4.5.1 Dust Control

An effective dust control programme requires full knowledge of the design and operation of mining machines and equipment with a view to minimising the production of airborne dust, an efficient use of water for dust suppression and the application of exhaust ventilation and dust filtration techniques.

The common purpose of these technical measures is to keep the dust concentration in the working environment at permissible levels taking in account the content of silica and other factors in exposure(see also table 4.1 below). Regular monitoring of dust concentration and composition are essential. It is especially important to evaluate the respirable fraction of the dust (1 - 5µm particle diameter) as this is the most noxious. This size characterisation allow their penetration and deposition in pulmonary spaces which may lead to serious respiratory disorders (e.g. fibrogenic effects, local irritation along the respiratory system, lung cancer).

Table 4.1. Occupational exposure limits in various countries for dust containing free silica in mg/m³

France	USA	former USSR
10/(x+2) [*]	0.1	No limit

* Amount of respirable dust as a function of x = percentage of quartz in respirable dust.

Source: Technical Report No. 5 “Environmental Aspects of Selected Non-ferrous Metals Ore Mining”, A Technical Guide, UNEP/ILO 1991

4.5.2 Control of Chemical Hazards

The identification and analysis of chemical containment of the atmosphere is also important. In enclosed areas, the concentration of gases or other chemical substances which have particularly dangerous toxic or asphyxiating effects, such as methane, nitrous oxides, carbon monoxide, should be monitored constantly or as a minimum, several times each day. The tendency nowadays is to provide a constant check on environmental factors in the entire mine and a warning system when hazardous emissions in the air exceed permissible levels.

4.5.3 Control of Noise and Vibration

To control noise and vibration in mining industry, the following basic techniques are available:

- changing to slower running equipment, altering the design, construction or installation
- improving maintenance
- replacing compressed air powered equipment by electrical devices
- using properly designed air silencers, resilient mountings
- isolating the source by enclosure of noisy and/or vibrating fixed equipment

- increasing the noise and vibration absorption between the source and the listener by locating noisy or vibrating activities as far as possible from areas of potential nuisance and by, in the case of noise, erecting some form of screening structure between the source and the listener
- screens used in practice include walls, waste and soil banks and trees.

4.6 MEDICAL SURVEILLANCE

In view of the characteristics of work in non-ferrous metal mines, periodical supervision is of particular importance to ensure workers' health does not deteriorate. The medical examination regime in a well organised mine usually consists of pre-employment health examination to determine his or her fitness to work, and thereafter a periodic examination to detect early changes in his or her physical and mental state of health. Pre-employment examination makes it possible to compile a miner's personal medical record in which all relevant information on his state of health throughout his employment can be recorded. Periodic medical supervision varies from mine to mine. In some, all employees undergo examination every year or every two years; in others, the intervals between examinations vary according to the age of the employee or the occupational hazards to which he is exposed such as dust, ionising radiation, toxic substances, noise and vibration.

It is important to relate the general state of health with the results of monitoring of the working environment. This helps evaluate the effectiveness of control measures.

4.7 EXERCISES

1. Name typical sources of noise and vibration.
2. What is the typical regulatory standard in many countries with established mining operations?
3. What is the noise level at which the risk of hearing loss becomes high?
4. What are the different thermal impacts on underground and open-cast miners, respectively?
5. Why is it recommended that miners, before working in high altitudes, arrive at the mine site at least one week before starting heavy manual work?
6. What are the main sources of dust production in an active mine?
7. Why can tailing dams cause dust problems after abandonment?
8. Name some hazardous components which may be contained in mining dusts.

9. How does carbon monoxide influence the body and what are the results?
10. What is cyanide used for, and what are the impacts on the body when exposed to it?
11. How many heavy metals are suspected to be toxic to humans in concentrations that could occur in mines?
12. Which heavy metal is the cause for a Parkinson-type disease which some miners contract?
13. What are the possible reasons for biological infections in workers?
14. Upon which fraction of dust should most attention be spent, and why?
15. Name the basic techniques which can be used to control noise and vibrations.
16. Why and when should routine medical surveillance be carried out on mine workers?
17. What are the principles of the mine health and safety legislation in your country? How effective is the legislation?
18. What common methods are used for dust suppression in your country? Comment on their effectiveness. How widespread are they?
19. What common methods are used for noise suppression in your country? Comment on their effectiveness. How widespread are they?

Study Projects

1. Design a handout for all relevant workers that describes the handling precautions for cyanide. Refer to general mine health and safety books, chemical data sheets, manufacturers' instructions, etc.
2. Examine the International Programme for Chemical Safety Environmental Health Criteria books. What are the eco-toxicity levels for some metals mined or produced as by-products from mining in your country? (The following metals are covered: Al, As, Ba, Be, Cd, Cr, Pb, Mn, Hg, Ni, Pt, Se, Th, Sn, Ti, and V).

Further exercises to be developed by the trainer.

References

For further reading on this subject the following texts are suggested. Additional references are to be found in Part IV Bibliography.

- International Labour Office (ILO), 1991. Safety and health in open-cast mines. An ILO Guide of Practice. ILO: Geneva, Switzerland. ISBN 92-2-107103-0 (English). ISBN 92-2-207103-4 (French). ISBN 92-2-307103-8 (Spanish).
- International Labour Office (ILO), 1986. Safety and health in coal mines. An ILO Guide of Practice. ILO: Geneva, Switzerland ISBN 92-2-105339-3.
- International Programme on Chemical Safety, ongoing since 1973. Environmental Health Criteria. These publications cover a wide range of elements and chemical compounds.
- International Programme on Chemical Safety and Commission of the European Communities, 6 series, 1990 - 1991. International Chemical Safety Cards. Similar to the previous reference, but these cards give environmental, health and safety information in a condensed format.
- World Health Organisation, 1996. Screening and surveillance of workers exposed to mineral dust. ISBN 92-4-154498-8. Ed.: Wagner, G.R. World Health Organisation, Geneva, Switzerland.
- WHO (1992) Problem-based Training Exercises for Environmental Epidemiology. Instructor's Guide. WHO/PEP/92.05-A. WHO, Geneva, Switzerland.
- WHO (1992) Problem-based Training Exercises for Environmental Epidemiology. Group Practice Exercises for Students. WHO/PEP/92.05-B. WHO, Geneva, Switzerland.

Part II

Mining, Mine Waste and Environmental Engineering

Chapter 5

Environmental Management Systems

Owing to the range and complexity of environmental issues confronting a mine manager, an environmental management system (EMS) is an important means of ensuring that all the desired practices and standards are maintained at a mine site, and that the various separate actions are in fact complementary. A carefully prepared EMS is an integral component of an overall company management system right from the outset of operation, and therefore of planning for eventual mine closure and decommissioning. An EMS is not an afterthought or a tool for getting out of a difficult situation.

By assessing and monitoring the company's environmental management programme (EMP – defined and discussed below), regulators are able to ensure that proper environmental management practices and standards are observed, and thus the public are better informed as well. Increasingly, regulators will monitor and inspect the EMS and EMP, rather than the mine itself

The “Environmental Management Systems” module of the *Best Practice Environmental Management in Mining* series published by the Australian Environment Protection Agency summarises the benefits of an EMS very clearly:

A competently prepared EMS is a useful tool, which may assist mine management to meet both current and future environmental requirements and challenges. It is a quality assurance system which can be used to review a company's operations against environmental performance indicators. Thus it helps the company to reach its environmental objectives and targets. An EMS provides a structured method of offering management an improved view and control of the organisation's environmental performance, that can be applied from planning and exploration through to mine closure.

5.1 BACKGROUND

In the past, environmental management efforts concentrated on the development of legislative and regulatory structures together with enforcement through permitting systems. The response of industry was largely reactive. It invested in “end-of-pipe” technological solutions to ensure compliance with the ever-increasing regulations and the environmental conditions attached to operating permits.

Since the mid-1980s, industry has been taking a more proactive stance, recognising that sound environmental management on a voluntary basis can enhance corporate image, increase profits and competitiveness, reduce environmental costs and obviate the need for further legislative measures by the authorities. One of the most important activities of the last few years has been the development of environmental management standards, which have served to provide a standardised approach to the preparation and implementation of environmental management systems.

The British Standard for EMS (BS 7750) was published in 1992, and formed the basis for the standard developed by the International Organisation for Standardisation (ISO), ISO 14 001, which was finalised in 1996. This standard is discussed in greater detail below, as it is rapidly becoming a requirement for international trade. The European Union adopted the Eco Management and Audit Scheme (EMAS) in 1993. Its reporting requirements are stricter than ISO 14 000, and some of its features differ from the ISO standard.

5.2 ISO 14 000

5.2.1 Introduction

The ISO 14 000 series is a family of international standards currently being developed through international consensus in a process lasting several years. Because of its widespread adoption in many countries, and because it is becoming a requirement in international trade, we have decided to focus on ISO 14 000 in preference to other environmental management systems. The series contains six categories of standards, as follows:

- Environmental Management Systems (ISO 14 001, 14 004),
- Environmental Auditing (ISO 14 010 - 12),
- Environmental Labelling (ISO 14 020 - 24),
- Environmental Performance Evaluation (ISO 14 031),
- Life Cycle Analysis (ISO 14 040 - 43), and
- Environmental Aspects in Product Standards.

Of the six categories, ISO 14 001 is the only standard used for certification purposes. The other five are guidelines designed to augment EMS implementation and provide a useful framework for performance improvement activities. It is important to note that adoption of ISO 14 000 will not automatically produce an environmentally friendly mine or company. The standards lay out the management system to be used; it is up to mine personnel to implement them. The standard makes this point clear in the introduction to ISO 14 001, where it says that the standard “does not establish absolute requirements for environmental performance beyond commitment, in the policy, to compliance with applicable legislation and regulations and to continual improvement. Thus, two organisations carrying out similar activities but having different environmental performance may both comply with its requirements.”

The ISO 14 000 series envisages a co-regulatory system, whereby regulatory bodies and companies work together to achieve the environmental outcome most beneficial to all parties. In the long term, implementation of the system should establish a sound basis for reliable, consistent management of environmental impacts. In particular, implementation of the system will require a company to:

- Take stock of its impacts on the environment;
- Establish its own objectives and targets;
- Commit itself to effective and reliable processes;
- Continual improvement; and
- Bring all employees and managers into a system of shared awareness and personal responsibility for the company's performance with regard to the environment.

For further information, and particularly if training material on EMS is required, please consult the *Environmental Management System Training Resource Kit*, published by UNEP, ICC and FIDIC in 1997.

5.2.2 Implementation of an EMS using ISO 14 001

Environmental management systems will differ from mine to mine, depending on the particular circumstances at each operation. This section describes the essential components common to all systems, and which are required by ISO 14 000.

Environmental policy statement

The policy expresses the commitment of top management to environmental management appropriate to the mine's activities, including commitments to comply with all relevant legislation and regulation, and to continual improvement. It must be communicated to all employees, and made available to the public.

Planning

Planning begins the process of putting the environmental policy statement into practice, by:

- identifying environmental "aspects" or impacts (whether adverse or beneficial),
- establishing legal requirements,
- setting objectives and targets, and
- establishing an environmental management programme (EMP).

Implementation and operation

Once planning has been carried out, the system needs to be implemented. The following steps are required:

- human and technological resources have to be put in place,
- appropriate personnel must be trained,
- internal and external communication procedures need to be instituted,
- information systems must be set up and implemented, and
- emergency preparedness procedures must be established and tested periodically.

Checking and corrective action (audit phase)

It is not enough to implement the system; actual performance and compliance with procedures and legislation need to be monitored. Where non-conformance is identified, corrective and preventive action must be taken, and procedures should be prepared beforehand, not only after the problem has been recognised. Appropriate records need to be kept of all actions. Lastly, the EMS should be audited periodically.

Management review

Company management is required to review the entire EMS, and make changes where necessary.

Continuous improvement

The system does not end with a report stored in the managing director's filing cabinet. The commitment to continuous improvement, coupled with the review process, means that environmental performance should improve steadily.

The ISO 14 000 system is represented diagrammatically in Figure 5.1. The process of continuous improvement may be envisioned as shown in Figure 5.2.

5.3 ENVIRONMENTAL MANAGEMENT PROGRAMMES (EMPs)

While an EMS defines *how* issues are managed, an environmental management programme (EMP) sets out *what* will be done, i.e. the operational programme. Both terms are defined in the glossary at the end of the chapter.

The purpose of an EMP is to ensure that environmental impacts are well managed, i.e. to ensure that adverse impacts are avoided or minimised and positive impacts maximised. It is comprehensive, though not exhaustive, in its coverage of the activities of the mine, and sets out in a structured manner how the mining operations will be managed with respect to the environment, from the project development stage through to closure and post-closure. It must take into account national and international regulations and commitments, community expectations, and economic considerations. In some countries, the EMP is part of the regulatory system, and the mining company is required by law to comply with any undertakings it makes, and to submit regular reports to the regulatory authorities.

Figure 5.1 EMS Elements according to ISO 14 001
(reproduced from “Environmental Management System Training Resource Kit”,
UNEP/ICC/FIDIC, 1997.)

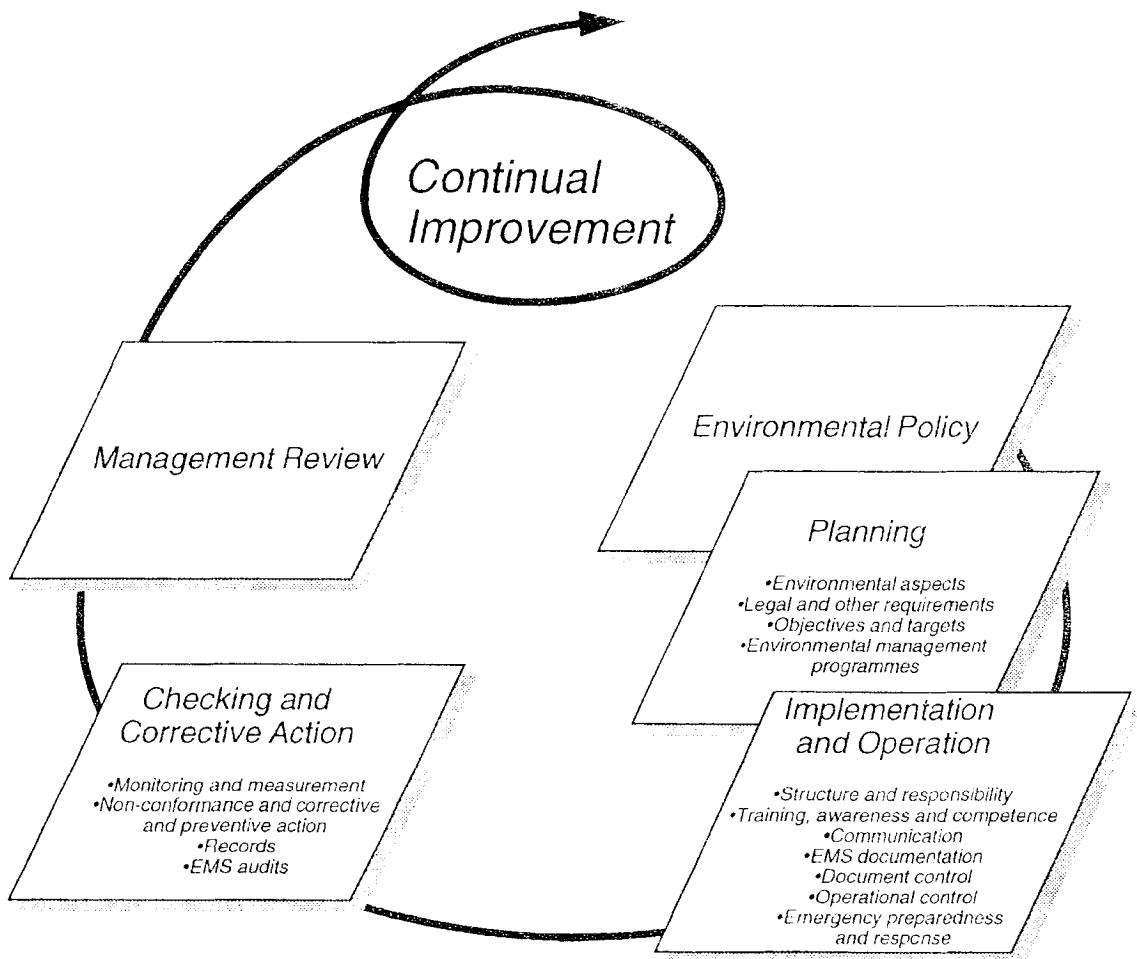
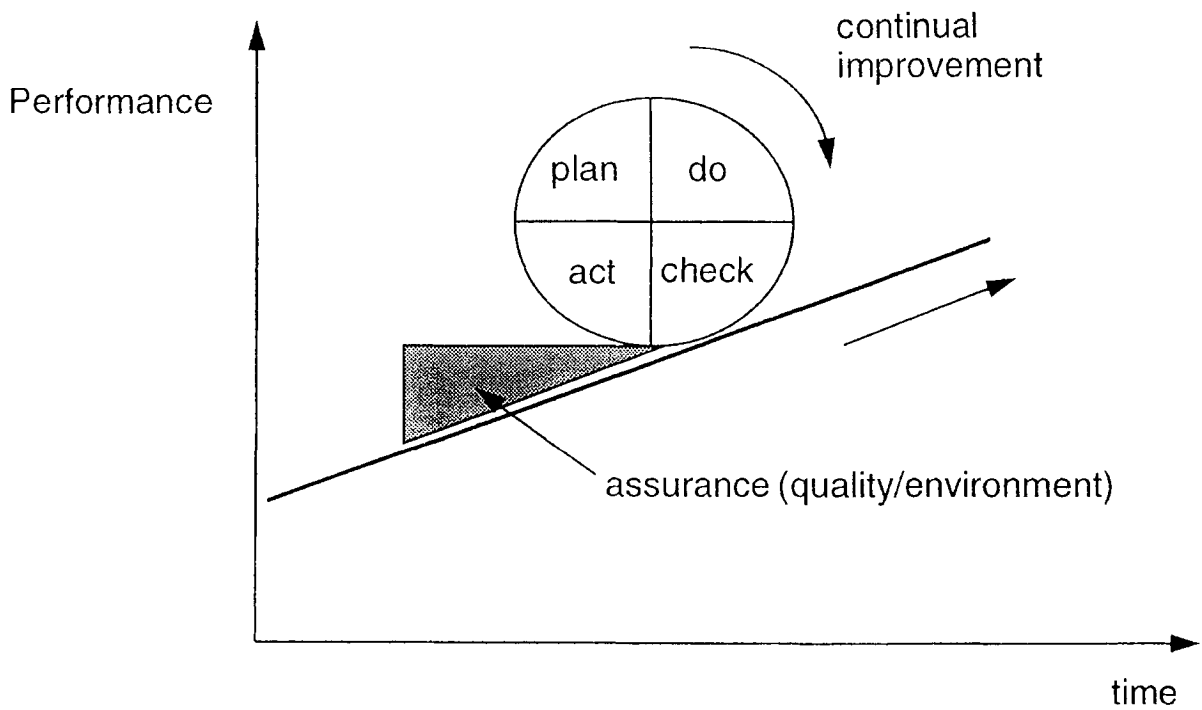

Figure 5.2 Continual Improvement

(reproduced from "Environmental Management System Training Resource Kit", UNEP/ICC/FIDIC, 1997.)



An EMP is not static; it should be updated whenever new information or research come to light, and when alterations are made to the mining operations. Because post-closure land use options are very important, particularly to the government and the local community, even if the projected mine life is more than a generation, it is essential that the EMP and its components plan from the outset for eventual closure. Thus a mine should be planned for closure before the first hole is dug, while remaining aware that the final outcome could be quite different.

An EMP includes many features, not all of which are relevant to this manual. The most important components of an EMP are:

- Environmental impact assessment (EIA)
- Monitoring
- Auditing
- Rehabilitation programme
- Waste disposal
- Compliance with regulatory requirements
- Community relations and information
- Environmental emergency response

5.3.1 Environmental Impact Assessment (EIA)

One of the stages in the project cycle of a mine is an assessment of the likely impacts of the mine on the environment. This is called an environmental impact assessment (EIA). The assessment should cover the different stages of the mine's development (see chapter 2). It should estimate the magnitude, extent, timing and duration of each impact. It is necessary to provide reasonable justification for these estimates, based on research results, field measurements, precedents from elsewhere, etc.

Some authorities distinguish between EIA and the environmental impact statement (EIS), which is the major written (hard copy) product of the EIA, but this manual has not made this distinction. Here, an EIA should be understood to include the environmental studies, as well as the associated reports and recommendations.

A very important part of an EIA, and not only because this manual is concerned with mine site rehabilitation, is the assessment of what will be the final state of the property after mine closure. Adequate preparation needs to start being made well in advance, i.e. before mining begins, and then as mining progresses, for the eventual closure of the mine. The EIA should address any potentially significant post-closure impacts of the mine's operations, with full details

of how they will be minimised. It goes without saying that such impacts should be reduced to the bare minimum.

The EIA is not meant to be a preliminary study simply to satisfy the requirements of regulators or banks. It should be updated with further baseline data as this comes to hand. Where appropriate, its findings should be used throughout the mine's life.

5.3.2 Monitoring and Auditing

Once environmental objectives have been set within the context of the mine's environmental management programme, which is informed by the EIA, the mining operations have to be monitored in order to:

- assess and optimise environmental performance;
- prevent, detect and remedy undesired environmental impacts;
- demonstrate compliance with objectives and regulations; and
- review and update, if necessary, the EMP.

A monitoring programme collects all the necessary information required to achieve the above goals, across the entire range of the mine's activities that might impact on the environment. Because EMPs differ from mine to mine, so will monitoring programmes. If a monitoring programme is a regulatory requirement, then it will probably have to be approved by the regulatory authorities before it is instituted. It is quite likely that more data will be collected than is required by the authorities.

Environmental monitoring programmes may initially appear to be expensive to implement. However, in reality they are a sound financial investment, particularly when critical environmental constraints are identified. Planning can then ensure that cost-effective mitigating measures are adopted, a clean hazard-free operating environment is maintained and mine site rehabilitation is undertaken in a continuous, cost effective and satisfactory manner.

Auditing is used to check compliance with objectives, procedures and regulations, and, in some cases, to assess preparedness for accidents. An audit may be undertaken by company personnel, or by external auditors, depending on its purpose. Impartial, external observers may be required for regulatory purposes, and their findings will usually be more authoritative in the eyes of the community and government authorities.

There is a wide range of audits that may be undertaken. Definitions of Audit \cong vary widely, but a number of different types concerned with environmental performance may be distinguished:

1. Environmental management systems audit - for those companies with a formalised EMS in place. This type of audit can be conducted at three levels:

- * First Party Audit by the company upon itself (ie: an internal audit);

- * Second Party Audit by one company working on its own behalf on another (e.g. audit on a supplier by a customer);
 - * Third Party Audit by an independent organisation against an appropriate standard.
2. Compliance audits - to demonstrate compliance or otherwise with environmental legislation, regulation, licences, approvals and other documentation including the corporate environmental policy, and commitment to industry codes, charters and principles that the company has signed.
 3. Technical or process audits - to determine whether a particular process or operation is having a detrimental effect on the environment. These audits may focus on energy, waste, pollution or site aspects, for example.
 4. Environmental liability audit - as a prerequisite to insurance that covers both sudden and accidental pollution as well as gradual pollution.
 5. Environmental performance audit - to assess the environmental performance of an ongoing activity.

5.3.3 Rehabilitation Programme

Once a mine moves into the operational stage, the rehabilitation programme begins, and it continues until mine closure and perhaps beyond. This training manual sets out the details of what the rehabilitation programme incorporates.

5.4 BASELINE STUDY

At the outset of the EMP, it is necessary to carry out a baseline study of the site to provide data as a benchmark for later rehabilitation or remediation.

Whether the site is being considered as a potential mine site, whether it is an already a disturbed site, an abandoned mine or is an operating mine, this baseline study is essential for the planning of the necessary rehabilitation.

The baseline study should include the following in its table of contents:

- Location and history
- Land use
- Topography
- Climate
- Geology and Mineralogy

- Water quality and Sediment quality
- Soils
- Plant and Animal Life

5.4.1 Location and History

This should include:

- A general site description
- Its location and ownership
- Exploration and development
- Past production, if possible
- Whether there have been tailings and waste rock piles, their location including their present condition.
- The location of crown pillars and their stability, if possible.
- Pit slopes
- Openings to the surface, such as glory holes, old shafts, adits, tunnels
- Old mill sites and whatever infrastructure remains on the property.

5.4.2 Land Use

Previous activity that may be unrelated to the current activity should also be described, particularly where there is reason to believe that there was contamination in the past. An attempt should be made to determine the extent of the contamination.

As examples:

- An abandoned tailings area that is at present producing acid mine drainage
- An old industrial site which has diesel and other hydrocarbon contaminants
- An intensive farming area which may have residual chemicals and pesticides in the soil

Each of these should be identified in the baseline study as it relates to land use.

5.4.3 Topography

Topographic information is needed and should define the boundaries of the watershed surrounding and adjacent to the site. The impact, that has come about as a result of past mining or potential mining activities, should be described and any major topographic changes, or potential topographic changes noted. It is also advisable to identify potential visual impacts.

5.4.4 Climate and Local Air Quality

The climatic conditions and local air quality should be described as they relate to the site and to the potential development and rehabilitation activities. The wind intensities and directions should be determined in order to locate necessary wind breaks, in establishing revegetation sequences for tailings areas, to ensure that new seedlings are not smothered by being planted down wind of bare or exposed tailings. These data are also important in establishing the location of facilities or habitations. Rain and precipitation data should be included and should also be used in the assessment of the hydrogeological and hydrological conditions. This would also include regional storm data and earthquake data, if pertinent.

Climatic data may be obtained from the relevant government agency. The qualitative description of the air quality at the time of the baseline study should be brief and only pertinent to the site.

5.4.5 Geology and Mineralogy

It is important to describe the local geology and mineralogy in some detail. Also, to provide the mineralogy of the ore and of the host rock that will be disturbed or that will be encountered during mining. This should include any petrographic, mineralographic or other detailed geological studies and analyses that have been carried out, as well as descriptions and chemical analyses of the ore and of the development minerals. The data on the potential tailings and the waste rock should also be included, if necessary, being very aware of any minerals that might generate acid or other contaminants derived from leaching.

5.4.6 Hydrology and Hydrogeology

Sufficient necessary data must be collected, both adjacent to and downstream of the site, to allow an assessment of the potential effects of the mining operations, the past operations and the subsequent rehabilitation measures on the water quality and fisheries habitats, if pertinent.

Within this segment should be:

- A map of the surface drainage patterns and the flows within the receiving streams.
- The volumes and depths of the receiving water bodies, if pertinent.

- The direction and rate of ground water flow away from present or potential tailings.
- The direction and rate of ground water flow away from other disturbed areas which might also have been contaminated.
- The nature of the ground water table within the tailings, if present, and other areas should also be known to establish a background of any potential contamination.
- Significant aquifers should be identified and the data recorded. This might require a stratigraphic study of the site and the surrounding areas.
- The location of recharge and discharge areas.
- All known ground water users should be identified and mapped. This would include wells and springs within the affected drainage basin or basins.

5.4.7 Water Quality and Sediment Quality

The water quality and the sediment quality should be obtained and recorded for the sites, where applicable. The baseline study is to determine any changes that might occur during the development or rehabilitation of a property. The original conditions of the water and the sediment-loading provide a benchmark for future operating or post-operating conditions. In order to carry this out in the baseline study, ground water stations should be established. These would include:

- Water treatment effluent stations if present. This is pertinent to an older property that is operating or inactive and is beginning rehabilitation work.
- Site monitoring stations located at the points beyond which no further contaminant loading occurs from the mine site. This pertains to an old site.
- Baseline monitoring station or stations located outside the area of influence of the disturbed area. These stations are established and operate continuously until all work is completed and the site is returned to an acceptable condition.

In the baseline study the station locations should cover all of the potential sources of contamination from the site whether they are previous sources of contamination or sources that may develop as a result of developing or rehabilitating the site.

Water Analyses

In establishing the benchmark the water analysis should include both physical and chemical values. These values measured should include:

- pH
- redox potential

- total suspended solids
- conductivity
- temperature
- dissolved oxygen
- major cations and anions
- heavy metals
- total oil and grease
- ammonia
- arsenic and cyanide

There may be other elements that are considered necessary locally, but this list is fairly comprehensive.

Sediment Analyses

Sediment analyses should include:

- nutrients concentrations
- total organic carbon
- residual loss on ignition (a measure of organic matter present in the sediment)
- heavy metals contents, which could be of critical impact if not kept to low levels.

5.4.8 Soils

The nature and composition of the local soils and their potential for use in rehabilitation should be described. Possible erosion concerns should also be addressed including both water and wind erosion. The extent of soil contamination as the result of air emissions should also be addressed. The emissions may be of possible concern if the property is in the vicinity of a smelter, a power plant or other heavy industrial site.

5.4.9 Plant and Animal Life

A description of the terrestrial plant and animal life that may be affected on the site should be provided. The main focus will be on the description of existing local flora and fauna and on the expected impact of the rehabilitation or development upon them.

Reference materials on the local natural ecology, vegetation, flora and fauna may be available from government agencies, such as the Ministries or Departments of Natural Resources, Agriculture, Land and Waters, Environment, Parks and Wildlife, Fisheries.

These data will be useful in the future in establishing a benchmark and for charting trends as a tool for evaluating the performance of the rehabilitation measures. Specific knowledge of the habitat conditions could be important to future decisions and the adequacy and the practicability of the rehabilitation measures that are undertaken.

This is a basic outline of a baseline study. It is not all inclusive, it may be shorter or longer depending on the size of the project. Naturally, a large project would involve a longer, more comprehensive study as opposed to a small project which would be a shorter, more condensed and simpler study.

5.5 GLOSSARY

Environmental management system (EMS)

The part of the overall management system that includes organisational structure, planning activities, responsibilities, practices, procedures, processes and resources for developing, implementing, achieving, reviewing and maintaining the environmental policy. (ISO 14 000)

Environmental management programme (EMP)

The action steps, schedules, resources and responsibilities required for an organisation to achieve stated objectives and policy conformance. (UNEP/ICC/ FIDIC EMS Training Kit)

Environmental aspect

Element of an organisation's activities, products or services that can interact with the environment. (ISO 14 000)

5.6 EXERCISES

1. What is the purpose of undertaking a baseline study?
2. What are the features that should be examined and established in a baseline study?
3. In establishing a bench mark in a baseline study, what physical and chemical values should be established?

4. In undertaking a baseline study, where and how would you obtain information on plant and animal life?
5. Describe why “a competently prepared EMS is a useful tool”.
6. What potential problems might there be if a company’s EMS is not integrated into its overall management systems?
7. Describe how international approaches to environmental management have changed over the last thirty years. What do you think the advantages might be of current approaches for:
 - a) The environment;
 - b) Governments; and
 - c) Mining companies.
8. In what way does ISO 14 001 differ from the other standards in the ISO 14 000 series?
9. How is possible that an ISO 14 001 certified company might not be “environmentally friendly”? How might a mine ensure that this is not true of it?
10. What do you think should be included in an environmental policy statement? Write a statement for your company.
11. In more detail than the previous question, write the part of the environmental policy statement that focuses specifically on rehabilitation.
12. You are responsible for setting up your mine’s EMP. What will be the main chapter headings? How will you plan for closure?
13. Consider the area or section of the mine where you work. Which environmental aspects do you need to monitor, why, and how often? If you do not work at a mine, consider water impacts on a mine or situation with which you are familiar.
14. You need to carry out an environmental audit of a mine. Where would you look for information and advice as to what to do?
15. Who should undertake a baseline study?
16. When in the mining sequence should it be carried out?
17. For an existing mine, how does it differ from a project still in the conceptual stage?
18. To whom and how should the study be communicated in: a) the company; b) the government; and c) the community?

19. How is the study linked to legal requirements and the EMS?
20. How will the baseline study be useful in designing the rehabilitation programme?
21. What is the difference between a baseline study and an impact study? What is the relationship between the two?

Further exercises to be developed by the trainer.

References

For further reading on this subject, the following texts are suggested. Additional references are to be found in Part IV.

Australian and New Zealand Environment and Conservation Council (ANZECC), 1992. Australian Water Quality Guidelines for Fresh and Marine Waters.

Australian Environment Protection Agency, 1995, ongoing. Best Practice Environmental Management in Mining series. The following modules are particularly appropriate to this section:

- Mine Planning for Environment Protection
- Environmental Impact Assessment
- Environmental Management Systems
- Environmental Monitoring and Performance
- Environmental Auditing

Chow, V.T., (Ed), 1964. Handbook of Applied Hydrology, McGraw-Hill, Inc.

International Association for Impact Assessment has compiled a list of introductory references on EIAs (and on other types of impact assessments as well). It may be viewed at: <http://www.ext.nodak.edu/IAIA/environm.html>.

International Organisation for Standardisation, 1996. ISO 14 001: Environmental Management Systems - Specification with Guidance for Use. Consult the following web page to find the relevant contact information for your country: <http://www.iso.ch/adresse/membodies.html>.

Lindbeck, Keith and Murray, Colin, 1993. A Cooperative Approach to Environmental Assessment, Regulations and Management for the Mining Operations in Western Australia. Proceedings of the Tenth National Meeting of the American Society of Surface Mining and Reclamation, Spokane, Washington.

Minerals Council of Australia, 1996. Australian Minerals Industry Code for Environmental Management.

South African Department of Minerals and Energy, 1992. *Aide-Mémoire* for the Preparation of Environmental Management Programme Reports for Prospecting and Mining. This was under revision at the time of writing (June 1998).

United Nations, 1994. Environmental Management of Mine Sites: A training manual. TR 30. UNEP IE and UNDDSMS.

United Nations, 1997. Environmental Management Training Resource Kit. UNEP/ICC/FIDIC.

Chapter 6

Operating Plan for Active Mines

6.1 INTRODUCTION

If the mine is an abandoned mine or at the point of decommissioning, the preliminary study described in the previous chapter should be sufficient to form the basis for the « rehabilitation plan ».

If, however, the mine is a new mine about to go into production, or is in production, an « operating plan » should be drawn up. The plan should describe briefly the activities of the mine so that the rehabilitation plan can relate to the situation on the site. The level of detail of this plan will depend on the relative importance of each feature that is to be rehabilitated. Also to be included is the point at which each part of the mine will be rehabilitated if carried out progressively during the operational phase of the mine's life.

Since a preliminary study has already been undertaken on the site, it is not necessary to repeat the past history of the site in the operating plan.

Basically, the operating plan should follow the table of contents which is outlined below. Again, this is not an exclusive table, but it should serve as a guide.

- Schedule of Operations
- Mining Activities
- Mine Development Rock, Ore and Concentrate Management
- Milling Processes
- Tailings Disposal and Impoundment
- Water Management and Treatment
- Special Waste Management
- Ongoing Monitoring
- Ongoing Rehabilitation
- Chemicals and Fuel Storage and Handling
- Buildings and Infrastructure
- Emergency Planning and Community Awareness

6.1.1 Schedule of Operations

For new and existing mines, which would include advanced exploration, a description including the following should be included:

- The expected duration of advanced exploration activities
- The expected mine life
- Long term projections of development
- The expected schedule of development of the major features in the development of the mine, such as open pits, tailings dams, rock and overburdened piles, mine and mill buildings, roads, power lines and other infrastructure
- Modifications that might be made to existing water courses. This is very important

6.1.2 Mining Activities

The anticipated annual mining rates should be given for the life of the mine.

Projected Tonnage Estimates

These figures should include:

- The types of ore and rock that will be removed
- The chemical composition of the ore and the host rock
- The anticipated annual tonnage of each rock type and ore removed
- The tonnage that will be processed
- The tonnage that will be placed on surface rock piles
- The tonnage of tailings that will be placed on the surface
- The tonnage of mine waste rock or tailings that will subsequently be used as mine backfill.

Underground Operations

For underground operations, describe the mining methods used, or to be used. A description should show:

- The schedule of operations and development
- The actual mining method to be employed
- The extent of underground development. This should include all future plans
- The underground management and movement of rock and ore
- The backfill methods
- The projected stability conditions in the mine

Open-cast Mines

The local public should be involved in any development and rehabilitation that may occur, it is prudent to insure that the visual aspects from the highways or from nearby heights of land are pleasant to the eye or as compatible to the landscape as possible. Figures 6.1 and 6.2 show examples of poor and good planning in the operation and progressive rehabilitation of an open-cast mine.

For open-cast mines the methods to be used should be described and the rate of development given. The description should contain:

- The schedule of operations and development
- The detailed plans of the development and operating methods
- The stripping ratio of mine rock to ore
- The bench heights
- The slopes, the faces, and the pit wall stability
- The access and haulage routes
- The access protection
- The safety and security measures for both workers and the public

For both underground and open-cast operations the nature of all mine openings to the surface should be shown on a map, including crown pillars and potential subsidence zones, should there be any.

Any available reports that relate to the property, such as geotechnical investigations, geotechnical and geological core logs, and hydrogeological studies. Any engineering geology interpretations and rock mechanics reports and data should be incorporated into the plan and should be appended to the report.

6.1.3 Mine Development Rock, Ore and Concentrate Management

Much of the environmental impact on a site is caused by the deposition of overburden piles, rock piles and tailings piles. Therefore, gathering the information suggested in this chapter for the operating plan is essential to ensure good rehabilitation planning and environmental protection.

The placing of the waste piles, if properly planned, can significantly contribute to the aesthetics of the final rehabilitated site. The waste piles, if competently placed and landscaped, can become attractive barriers, screening the mine operations. Figure 6.3 illustrates an example showing the placing of dumps as they relate to the mine operations.

Figure 6.1. Poor Planning

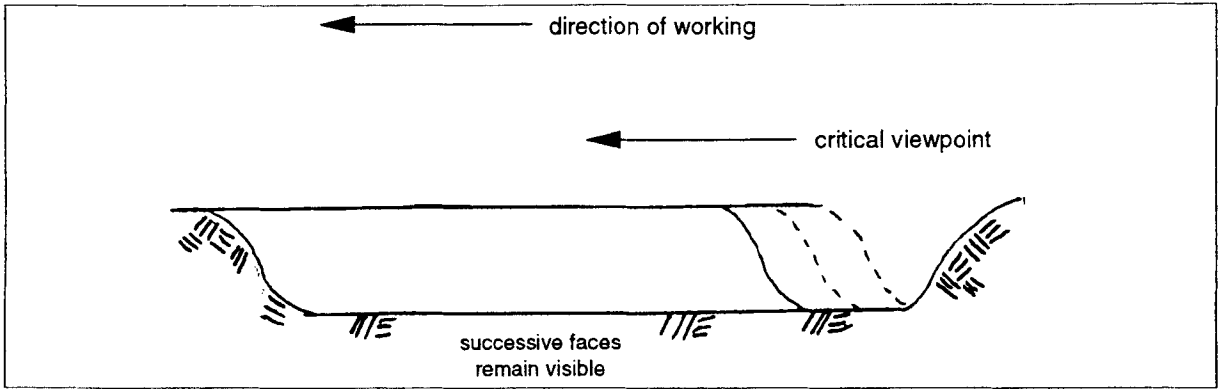

Figure 6.2. Good Planning

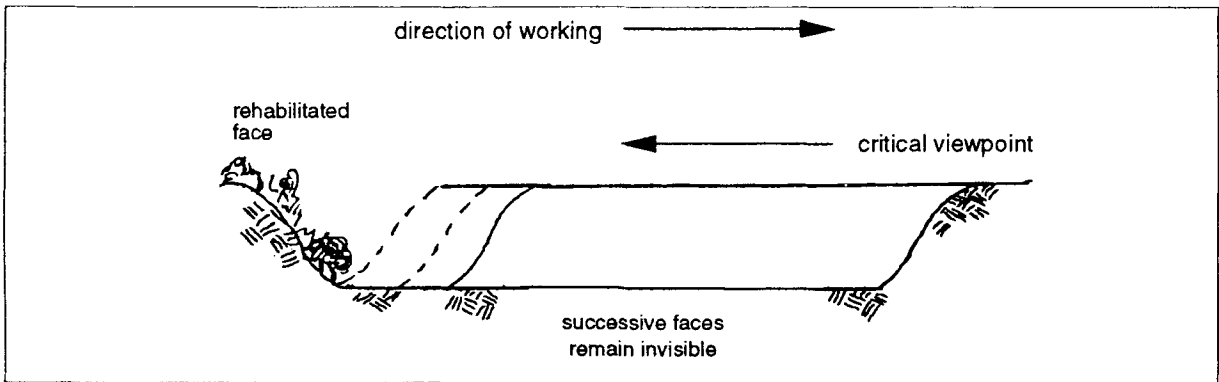
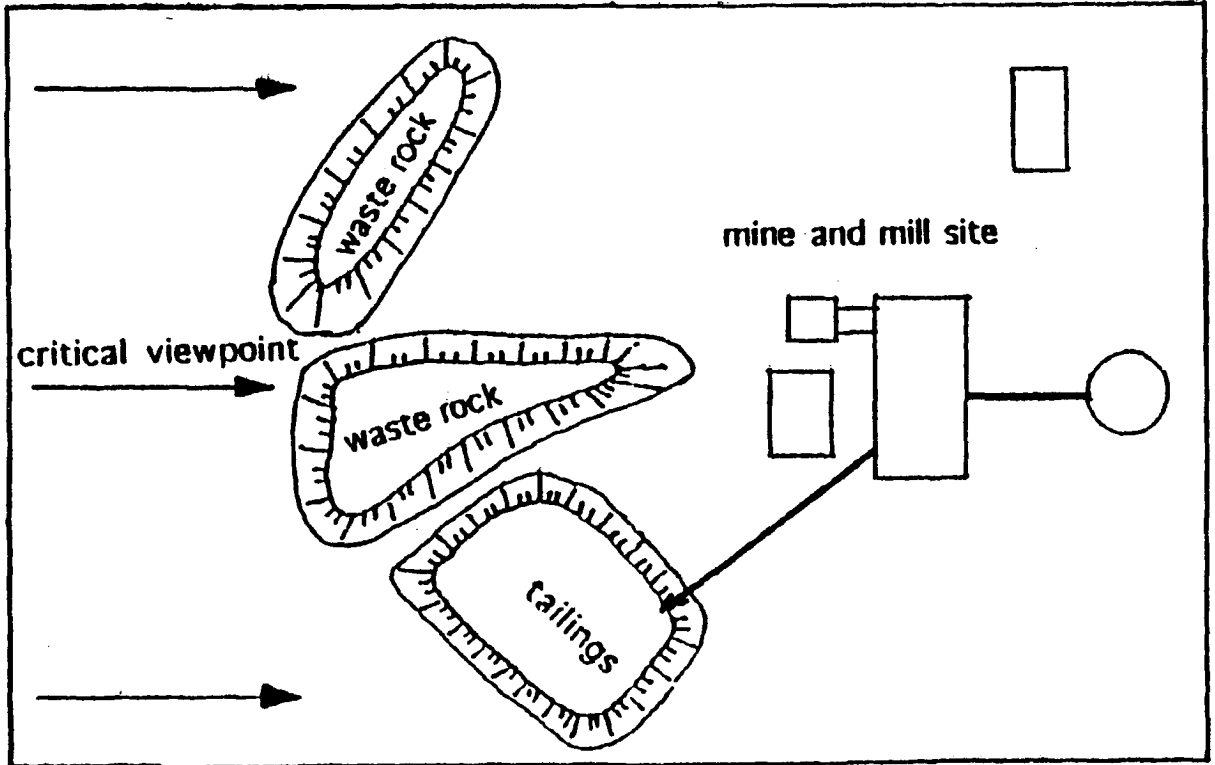

Figure 6.3. Placing of Waste Piles to Screen Mine Operations



The location of all rock and material piles related to the extraction of the ore should be shown on the plan. This would include piles of topsoil, overburden, waste rock, active ore, spent ore and concentrate. These data are essential for the rehabilitation plan in that progressive rehabilitation may form an integral part of the storing and management of these rock piles.

Storage Areas

Where available the following information should be incorporated into the description of each storage area:

- The original topography
- The superficial and bedrock geology
- The foundation materials underlying the rock piles
- The foundation materials and aquifers underlying the impoundment structures
- The hydrology and hydrogeology
- The anticipated or expected leachate composition and the location of its containment

Nature of the Stored Material

The details regarding the ore, concentrate, waste rock, overburden and other waste material piles should include the following:

- The plan of the areas to be covered and the consequent piles
- The site preparation procedure, including the stripping and storage of soil and subsoil
- The construction procedures of each individual pile
- The total height of each pile or dam
- The proposed stability of the slopes of the piles and impoundment structures
- Any proposed blending or segregation of the materials and the methods of accomplishing this
- The material types, their physical and chemical characteristics and whether it is anticipated acid drainage will be produced
- The water management both through and around the piles
- The assessment of the seepage in the containment structures as the piles are developed
- The seepage control works for both the short term and the long term, if possible
- The interstitial pore water characteristics

6.1.4 Milling Processes

The description of the milling processes should be briefly outlined. This should include:

- The projected annual milling rate over the proposed mine life
- The process flow sheet
- The list of reagents used
- The water balance for the mill
- The characteristics of the process and tailings
- The particle size distribution and morphology of the tailings
- The chemistry of the tailings, especially a determination if they may be acid generating
- The various types of tailings and the tonnages of each type of tailing
- The composition of the residues in the mill tailings
- The amounts that will be placed in surface impoundments
- The amounts that are to be used as mine backfill

6.1.5 Tailings Disposal and Impoundment

A plan, showing in detail the location and the expected size of the tailings impoundment area or areas, should include the following:

Storage Areas

- The original topography
- Map of adjacent community and land use
- The superficial and bedrock geology
- The foundation materials in the storage areas
- The geotechnical data

Nature of Tailings Impoundment

The tailings impoundment details should include physical characteristics which would include the following:

- The area of the impoundment

- The site preparation. Including the stripping and the storage of the soil and the subsoil
- The height and detailed geotechnical design of the structure
- The annual rate of rise of the tailings structure
- The tailing disposal methods
- The construction procedures for the dam and retaining embankments
- The stability analysis of the embankment
- The engineering characteristics of the tailings
- The chemical characteristics of the tailings
- The water management both within and around the dam

Hydrology and Hydrogeology

The tailings impoundment hydrology and hydrogeology should be described and should include:

- The water balance and the current and projected long term waste levels within the impoundment
- The flood control and diversion structures
- The methods of flood control through and around the impoundment
- The seepage control methods in both the short and in the long term

Chemical and Water Quality

The chemical and water quality characteristics of the tailings should be described and should include the following geochemical data:

- The acid generating potential of the tailings
- The generating controls necessary for acidic drainage
- The analysis of the seepage
- The containment transport

6.1.6 Water Management and Treatment

The operating plan should describe the locations and nature of water treatment facilities, if any. These should include the sediment control structures and any applicable wetlands that

have or will operate during the mining operations. Also, which facilities will be used to implement the rehabilitation plan. Should water treatment produce sludge, the long term and short term disposition of the sludge should be described.

In many cases the conditions that relate to water treatment during operations might have very little significance to rehabilitation measures in the rehabilitation plan. The details required in relation to the operating period should however provide adequate background information that can be used to address the rehabilitation concerns.

The operating plan should also describe details relating to non-process water. Runoff from tailings and other waste heaps, and impacts on groundwater and streams should be included. Naturally, the plan should be designed to minimise these impacts both during and after operation.

Water Management

For water management there should be a brief description of the following in the operating plan:

- The process flow sheet
- The facility and the plant capacity
- The projected period of operation
- The operating schedule
- The capacities of the plant
- The operation, maintenance and monitoring procedures
- The overall water balance
- The location and the facilities for sludge disposal
- The long term behaviour and the final disposition of sludge that are stored on sites must also be described

Wetlands

Wetlands, if present on the site, represent a superficial environmental impact and should be described in the operating plan. The plan should include:

- The aerial extent of the wetland
- The biological nature of the wetland
- The physical structure of the wetland

- The design flow
- The retention time and projected design life of the wetland
- The expected and actual effluent quality

Sediment Control

The sediment control structure or structures used in the operation will also have a significant impact on the environment and should be well documented in the operation plan. The plan should describe:

- The capacity of the structures
- The details of the control dams
- The stability analysis of the structures
- The operation and maintenance of these structures
- The methods of sediment retrieval
- The nature and location of sediment disposal facilities

6.1.7 Special Waste Management

The quantity of solid waste that will be generated on the site should be part of the plan. It should include the amount that will be disposed of off-site as well as the amount of waste that will be disposed of on the mine site. A description of the methods and locations of the disposal sites on the mine site should be provided. It must be remembered that poorly stored or disposed of solid waste might in the long term generate additional environmental hazards.

6.1.8 Ongoing Monitoring

Monitoring is covered in detail in Chapter 8. A monitoring programme collects information across the entire range of the mine's activities that might impact on the environment. Because it needs to be integrated with the overall operating plan, and because it is an ongoing exercise, it should be covered in the operating plan. Some of the details that should be included in the operating plan are:

- all impacts to be monitored
- monitoring frequency
- location of monitoring stations or points
- location of monitoring records

6.1.9 Ongoing Rehabilitation

As is stated elsewhere in this manual, rehabilitation is not an activity that is reserved for mine closure, but rather an ongoing activity once the operation is under way. The operating plan therefore needs to set out the details of how this ongoing rehabilitation will be factored into the mine planning.

6.1.10 Fuel and Chemical Storage and Handling

An inventory and the details of all storage sites for petroleum products, chemicals and hazardous or toxic materials should be included in the operating plan as well as in the rehabilitation plan. The inventory of all these products should be available and kept up-to-date at all times. The details of storage or removal of these materials from the mine site should also be included in the operating plan. If removed from the mine site a description of the methods of transport and the final location should be included.

6.1.11 Buildings and Infrastructure

The nature and location of all structures and facilities on the site should be described and shown on the plan. In developing the site plan, it is also advisable to identify potential visual impacts and to plan the siting of buildings, waste dumps and tailings dumps, so that they may be screened. Figure 6.4 illustrates poor screening and Figure 6.5 shows examples of good screening.

A list of the construction materials used in the buildings and in the other facilities must be included. Provision for appropriate removal and disposal on decommissioning must also be outlined in detail.

The particular characteristics of the mine and its operating procedures should be sufficiently detailed in the operating plan to allow a smooth transition into rehabilitation planning and rehabilitation.

6.1.12 Emergency Planning and Community Awareness

Despite the best planning, accidents do happen. Thus it is essential that accidents themselves are planned for in advance. Instead of panicking, prior preparation for accidents can greatly diminish their affects on human safety and health and on the environment. This planning includes activities that make the community and the local authorities aware of what *could* happen, and how to be prepared for it. UNEP IE has a programme called APELL (Awareness and preparedness for Emergencies at Local Level), which helps companies, authorities and communities to prepare for emergencies. It should be contacted for information.

Figure 6.4. Poor Screening

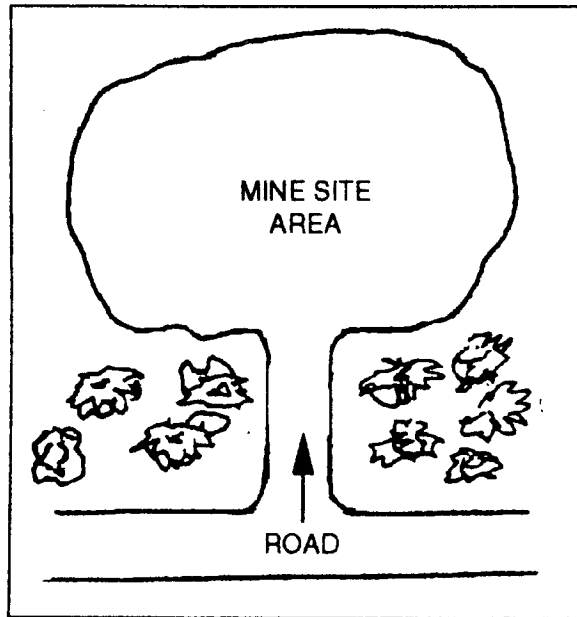
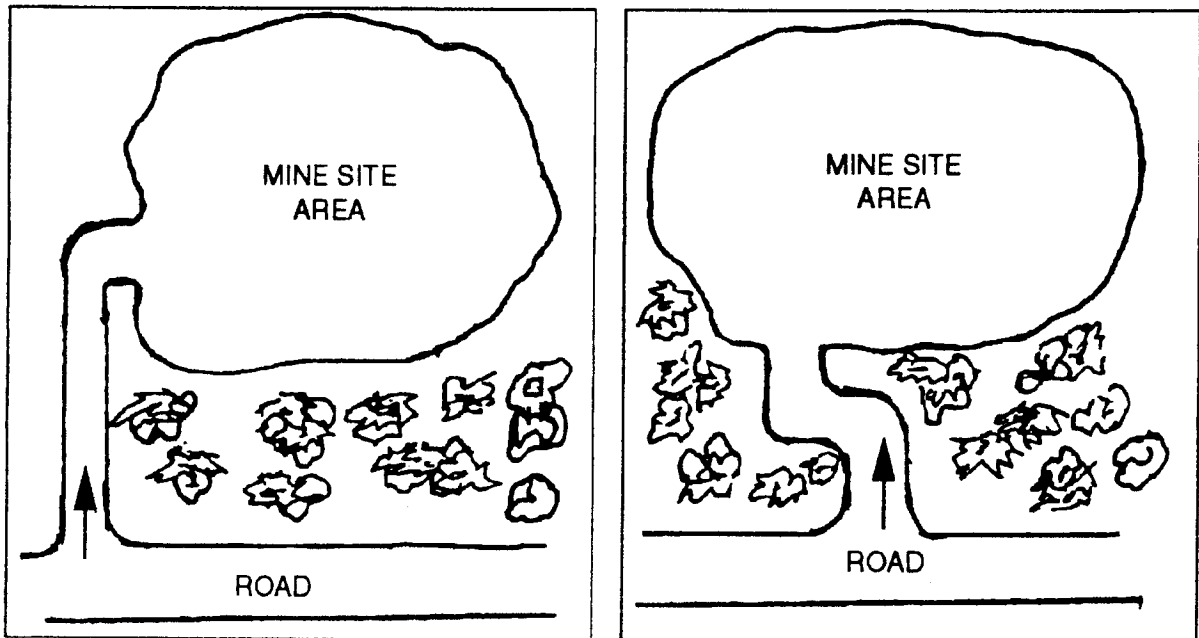

Figure 6.5. Examples of Good Screening



6.2 EXERCISES

1. What should the table of contents for an operation plan be?
2. In planning the Schedule of Operations, what descriptions should be provided?
3. In developing an open-cast mine, relative to the critical viewpoint, how would you plan it? Give sketches of both good and poor planning and explain why.
4. What details should be addressed in describing the milling process?
5. How can it be ensured that the results of the preliminary study have been adequately addressed in the operating plan?
6. How can it be ensured that planning for rehabilitation has been incorporated into the operating plan?
7. Who is responsible for the operating plan? Who should be involved in preparing it?
8. Explain the relationship between the preliminary study and ongoing monitoring in the operating plan.
9. Which aspects of the operating plan are especially important for rehabilitation?
10. What monitoring data will be required for the water management programme?

Further exercises to be developed by the trainer.

References

For further reading on this subject, the following texts are suggested. Additional references are to be found in Part IV.

- Australian Environment Protection Agency, 1995. *Mine Planning for Environment Protection. Part of the Best Practice Environmental Management in Mining series.*
- Hustrulid, W.H. (Ed), 1982. *Underground Mining Methods Handbook.* Society of Mining Engineers, New York, New York
- Laubscher, D.H., 1981. *Selection of Mass Underground Mining Method, Design and Operation of Caving and Sublevel Stopping Mines.* Society of Mining Engineers, New York, New York
- Ontario Ministry of Labour, 1982. *Guidance for Engineers and Inspectors - Tailings Dams and Related Structures*
- Piteau Associates, 1991. *Mined Rock and Overburdened Piles: Interim Guidelines - for Investigation and Design.* Bi-Tech Publishers, Vancouver, British Columbia
- Ritcey, G.M., 1989. *Tailings Management Problems and Solutions - In the Mining Industry.* Elsevier
- Vick, S.G., 1990. *Planning, Design and Analysis of Tailings Dams.* Bi-Tech Publishers Ltd., Vancouver, British Columbia
- United Nations Environment Programme Industry and Environment office and International Commission on Large Dams (ICOLD), 1996. *A Guide to Tailings Dams and Impoundments: Design, Construction, Use and Rehabilitation.* Bulletin 106.
- Welsh, Donald E., 1989. *Planning, Design and Operations of Tailings Facilities.* Canadian Mining Journal, Don Mills, Ontario

Chapter 7

Rehabilitation Planning

7.1 INTRODUCTION

Each mine site has particular characteristics that will influence the procedures that are adopted in the rehabilitation programme. These characteristics at first may seem obvious but critical differences are often only identified after careful investigation. For this reason, a Rehabilitation Plan must be designed first at a conceptual level, where alternative rehabilitation measures are considered. The pros and cons and the rationale of the various approaches should be compared and the preferred option selected.

A clear, unambiguous set of goals and objectives for the rehabilitation plan must be set at the beginning. It should take account of applicable regulations, company policy and the outcome of community consultations. Of prime importance is that the plan should stress progressive rehabilitation from the very start of operations.

In assessing rehabilitation alternatives there are a number of criteria that should be considered.

- The ability to meet expected environmental conditions
- The cost effectiveness of the programme
- The certainty of the present technology and techniques used and their anticipated long-term performance
- The maintenance and monitoring requirements

The proposed future land use will also influence what procedures need to be taken relative to plant species in that area or to other critical local natural systems.

This section outlines the basic rehabilitation plan which with appropriate modification can apply to most disturbed areas. The development of a rehabilitation plan for a mine site must consider all components at the site. For each component the following aspects should be addressed:

- physical stability
- chemical stability
- environmental impact
- human safety
- future land use.

In the past mine rehabilitation requirements were restricted mainly to measures required to ensure physical stability. This state of mind led to the construction of stable tailings embankments and spillways, the removal of derelict or deteriorating buildings and the prevention of public access as the sole rehabilitation requirement in countries where rehabilitation requirements were in force.

More recently, there has been an increased recognition of the potential for chemical instability. This has come about by the realisation that the leaching of contaminants from the mine site and their entry into the local water regime represents a major impact on the environment. The need to demonstrate chemical stability, or achieve sufficiently low release rates, so that the downstream environments are not adversely affected, is now critical. A rehabilitated, disturbed site must be both physically and chemically stable and must also achieve a land use similar to its previous use or to another acceptable condition.

7.2 PRINCIPLES OF REHABILITATION

If the mine is an abandoned mine or at the point of decommissioning, the baseline study as described in Chapter 5, should be sufficient to form the basis for the « rehabilitation plan ». If, however, the mine is a new mine about to go into production, or is in production, an « operating plan » should be drawn up. This subject is covered in Chapter 6.

Good planning and environmental mine management procedures will minimise the adverse impacts of a mining operation. Rehabilitation refers to the operations whereby adverse impacts are avoided wherever possible, and where the unavoidable impacts are remediated to a satisfactory condition. To the extent practicable, progressive rehabilitation should proceed along with mining. The following is a list of basic principles which are not exhaustive but which address most aspects of rehabilitation. They should always be followed:

- Remember that human beings are part of the environment! Community consultation and participation in rehabilitation and long-term maintenance is very important, and should be addressed as early as possible.
- Ensure the site is made safe.
- Be aware of any statutory requirements in the beginning, and ensure these are met and adhered to in the plan and implementation.
- If a new project, prepare a plan of the proposed rehabilitation prior to the commencement of mining.
- As far as is possible the site should be rehabilitated progressively in step with the rate of mining.

- Always remove and keep the top soil for subsequent rehabilitation.
- Where possible respread cleared vegetation on disturbed areas.
- Where feasible reinstate the natural drainage patterns where they have been altered or diverted.
- Remove or control residual toxic materials.
- Compacted surfaces which have commonly been used as staging or base areas are usually contaminated with diesel and other hydrocarbons. These should be ripped to loosen the soil compaction and to enable access to the hydrocarbon contaminants so that remedial measures may be employed to remove them.
- Structurally stabilise tailings dams and waste dumps, ensure that they are adequately drained and are suitable for long term land use.
- Neutralise or control chemical materials in tailings dams by appropriate screening or impervious covers.
- Minimise the long term visual impact by creating land forms which are compatible with the adjacent landscape.
- Ensure that erosion by wind and water is minimised both during and following operations and rehabilitation.
- Ensure that the indigenous vegetation is re-introduced into the area providing the re-vegetation is consistent with post mining land use.
- Be sure to re-vegetate the area with plant species that will control erosion, provide diversity and enable plant succession so as to restore a stable and compatible ecosystem.
- Prevent the introduction of noxious weeds and pests.
- When mining is completed remove all facilities and equipment from the site, unless approval to leave certain structures for post-mining uses, tourism or heritage benefits.
- Monitor and manage rehabilitated areas until they are self-sustaining or are in a satisfactory and acceptable condition.

7.3 PHYSICAL STABILITY

Rehabilitation measures for physical stability must address the deterioration of the materials and structures remaining on a mine site after operations have ceased. The materials may be composed of soil and rock, such as pit walls or crown pillars, or be composed of man-made materials such as concrete or steel. The potential deterioration of materials and structures by perpetual disruptive forces should be evaluated in drawing up the rehabilitation plan.

Many of the physical considerations pertaining to the closure of a mine are the same as those during mine operations. The differences are, however, related to the longer time span for which structures need to remain stable. The difference in time scale is likely to be a minimum of an order of magnitude such as 200 years, or as much as 2 000 years of stability for closure as compared to 20 years of stability for an operating mine.

The gradual changes in soil and rock conditions coupled with changing ground water and climatic conditions may dictate the need for a more conservative choice of design parameters for operations and for rehabilitation.

Tailings dams in particular need careful consideration for longevity. Although immediate static conditions may be satisfactory, long term forces may suggest the need for additional protective measures. Since gradual deterioration of materials take place with time, due to both physical weathering and chemical reactions, which may form noxious precipitates, conservative values of material strengths and resistance to reaction, should be selected. This deterioration is most commonly brought about by perpetual disruptive forces. These include wind erosion, water erosion, sheeting, rilling and gulleying, sedimentation, debris accumulation, soil restructuring and physical and chemical weathering.

Biological disruption would include root penetration, burrowing, intrusion and actions by animals and humans. These perpetual disruptive forces are summarised in Table 7.1.

7.4 CHEMICAL STABILITY

Chemical stability issues include acid mine drainage, the leaching of metals, the precipitation of metals and the flushing of mill reagents and other chemicals. Measures for the control of chemical reactions and the treatment and control of drainage, must be site specific and specific to the source and the type of contaminant. It is therefore a very complex problem which has to be very carefully addressed. Table 7.2 is a summary of potential control technologies for chemical stability.

In considering the table it must be recognised that these are potential control technologies, one method alone, or two together, or three, may not necessarily be fool proof.

It does however outline the state of the art relative to the various chemical reactions that can take place.

Table 7.1. Perpetual Disruptive Forces: Consequences and Control Technology

Perpetual Disruptive Forces	Consequences	Control Technology
PHYSICAL ACTIVITIES		
<ul style="list-style-type: none"> • Wind Erosion 	<ul style="list-style-type: none"> • Major release mechanism from exposed tailing impoundments 	<ul style="list-style-type: none"> • Short-term-chemical stabilisation • Wind breaks • Long-term - establish and maintain vegetative, or rock cladding
<ul style="list-style-type: none"> • Water Erosion 	<ul style="list-style-type: none"> • Erosion usually occurs during extreme precipitation and flood events 	<ul style="list-style-type: none"> • Sedimentation traps, groins, baffles, dams, linings and vegetation • Design diversion structures to accommodate extreme events
	<ul style="list-style-type: none"> • Sheet and rill erosion of impoundment surfaces, covers and embankment 	<ul style="list-style-type: none"> • Linings and flow control • Slopes flatter than 3 to 1 are usually required for erosion resistance and the establishment of vegetation
	<ul style="list-style-type: none"> • Gully erosion, a major cause of instability of tailing surfaces, covers and embankment 	<ul style="list-style-type: none"> • Riprap, rock cladding, baffles, linings
CHEMICAL ACTIVITIES		
<ul style="list-style-type: none"> • Precipitation of salts 	<ul style="list-style-type: none"> • Render drainage system inoperative 	
<ul style="list-style-type: none"> • Physical/Chemical Leaching 	<ul style="list-style-type: none"> • Decomposition or breakdown of intact particles 	<ul style="list-style-type: none"> • Evaluation decomposition of rocks used for long term stability; only use rocks not susceptible to weathering in permanent structures
BIOLOGICAL ACTIVITIES		
<ul style="list-style-type: none"> • Root penetrations generally beneficial effect on covers 	<ul style="list-style-type: none"> • Roots may penetrate drains and clog • Penetrate low permeability layers, rot and provide air or seepage channels 	<ul style="list-style-type: none"> • Ensure adequate drains • Use of larger drains with surplus drainage void space
<ul style="list-style-type: none"> • Burrowing intrusion 	<ul style="list-style-type: none"> • Burrowing along phreatic line in fine material may induce piping failures 	<ul style="list-style-type: none"> • Monitoring and maintenance • Use materials that animals cannot penetrate

Table 7.2. Chemical Stability - Potential Control Technologies

CONTROL TECHNOLOGY	Acid Drainage	Metal Leaching	Mill Reagents
CONTROL OF REACTIONS			
<ul style="list-style-type: none"> • Conditioning of waste/removal of deleterious minerals • Covers and seals for exclusion of water • Covers and seals for exclusion of oxygen • Blending/base addition • Bactericides (short term only) • Change mill process, change reagents • Change mill process, add fixing of neutralising agents 	Yes Yes Yes Yes Yes	Yes Yes	Yes Yes
CONTROL OF MIGRATION			
<ul style="list-style-type: none"> • Covers and seals to reduce infiltration • Controlled placement to reduce infiltration • Diversion of surface water • Interception of groundwater 	Yes Yes Yes Yes	Yes Yes Yes Yes	Yes Yes Yes Yes
COLLECTION AND TREATMENT			
<ul style="list-style-type: none"> • Active treatment in chemical treatment plant • Passive treatment using wetland • Passive treatment using alkaline trench • Passive treatment using retention pond 	Yes Yes Yes	Yes Yes Yes	Yes Yes Yes

7.5 CRITICAL CONSIDERATIONS

In the formulation of a rehabilitation plan there are a number of critical considerations which must always be kept in mind as the rehabilitation plan is prepared and as rehabilitation progresses. The plan should include an assessment and description of the expected conditions and uses that will follow rehabilitation. At sites where previous activities unrelated to the mining project may have contaminated the site, the plan should also address these contaminants in the planning for the expected improvements to the quality of the environment and to the land use productivity. It is very pertinent to compare the preliminary study to the rehabilitation plan and to merge the two initiatives.

The level of detail provided for each aspect should reflect each site's specific concerns and must not be simply a description in broad terms.

7.5.1 Land Use

Mining is intrusive and mined lands can often not be returned to their original use. If possible, they should be turned to an acceptable alternative use. In some instances pre-mining conditions of the land may not be the most desirable post-rehabilitation land use. It is recognised that in planning for and predicting a future land use, when the rehabilitation is still a long time in the future, the plan can only be made on a conceptual basis.

Again, it must be stressed that the first objective is public health and safety in determining the rehabilitation requirements and the utilisation of the land in the future. The hazards that are remaining on the rehabilitated site should be of the same, or of lesser magnitude, to the hazards typical of the area prior to the mining development. For example, if it is an area that has cliffs or fairly extreme topography the rehabilitation can meld with, and reflect the surrounding landscape.

7.5.2 Topography

The mining operation will probably have had a significant topographic impact on the landscape. This should be taken into consideration when designing the rehabilitation plan, remembering that many of these new man-made topographic features, such as tailings dams, will remain. This is particularly true in the case of open-cast operations where the location, the area and the depth of open pits, or other excavations should be built into the rehabilitation plan and be clearly indicated on both the plan and on the future topographic maps. Steep areas such as old mine rock piles or old tailings dams, which will remain after rehabilitation, represent new hill-like structures. These too must be carefully built into the future landscape.

It is essential that in designing a rehabilitation plan care should be taken that the visual impact on the public is well understood and catered for in the plan.

7.5.3 Hydrology and Hydrogeology

The rehabilitation plan should assess the potential effects of the mining operations and the rehabilitation on the surface water and on the ground water quality, on the site, adjacent to the site and down stream from the site. Of prime importance is that the plan should ensure that as rehabilitation is carried out, that the post-rehabilitation impact does not exceed the impact experienced during the operating life of the mine. In addition, where possible, the rehabilitation should move towards the regional or local background, as described in the preliminary study, and should blend in with the environment of the surrounding landscape.

The plan should identify the permanent changes required to achieve the long term stability to surface and sub-surface drainage patterns and to stream flows.

7.5.4 Plant, Animal and Aquatic Life

Much of the focus within most rehabilitation plans will be the impact of the mining operation and the subsequent rehabilitation on the local fauna, flora and aquatic environments.

Mining and other industrial activities that impact on a natural environment alter the local ecological balance and in many cases, the return to the pre-operation conditions cannot be made. The ultimate goal, therefore, is to rehabilitate the site to the extent that the area impacted will be amenable to support a balanced diversity of flora and fauna. This may not necessarily be the same as the previous diversity of aquatic or terrestrial life, but should be demonstrated to be acceptable.

7.6 REHABILITATION PLAN

The contents of the rehabilitation plan should include all or most of the following:

- Schedule
- Site Security and Safety
- Mine Workings
 - Underground Workings
 - Open Cast Workings
- Mine Development Rock and Overburden Piles
- Tailings Impoundment
- Water Management and Treatment
- Buildings, Equipment and Infrastructure
- Landfill Waste Disposal
- Chemical and Fuel Storage Areas
- Hazardous Waste Storage and Disposal

7.6.1 Schedule

A schedule should be provided to describe the implementation of progressive rehabilitation or of each stage of rehabilitation during the shut-down and decommissioning procedure. The schedule should describe the rehabilitation measures or work, the time to carry them out and the type of activities involved.

It must be remembered that the schedule may be conceptual, particularly if the operations cover a long mine life.

7.6.2 Site Security and Safety

The nature and location of all security systems such as barriers, fences, gates, berms and ditches should be described for each stage of the rehabilitation programme.

7.6.3 Mine Workings

This section is divided into two sections: Underground Workings and Open-cast Workings.

Underground Workings

Underground mining requires a complex system of access, service and stoping excavations to recover the ore. The excavations will have different levels of stability, with the larger excavations possibly backfilled or allowed to collapse. If there is resulting subsidence, the ground surface may be affected to a greater or lesser extent. These impacts must be assessed and included in the rehabilitation plan.

Most mining methods fall into different broad categories, they are given below. The relative impacts of each method is also shown so that in planning the rehabilitation these conditions may be up front and addressed.

Concurrent Caving

The ore is mined by caving or collapsing. The overlying rock must cave or collapse at the same time as the extraction of the ore in a controlled manner.

Post-Caving

The mining of the ore takes place without backfill. Caving could occur at anytime after the ore has been extracted. This does not lead to secure safety conditions as the collapse is not controlled and the timing is unknown.

Open Stopping with Rigid Pillars

Pillars are left to maintain stability whilst the ore is being extracted. Collapse and surface disruption could occur in the future, particularly if the rigid pillars are removed on retreating out of the mine.

Mining Fill

The openings left by mining of the ore are backfilled with material which may be cemented. This greatly reduces potential surface disruption.

Each category may have variations which would be dependent on the geometry of the ore, the stability of the rock and the practical mining constraints and economics at the time of extraction. The complexity, size and configuration of the underground workings, the type of mining operations used and the geometry of the ore-body all contribute to the potential long term impacts. Rehabilitation objectives and control technologies for physical and chemical stability and for land use are summarised in Table 7.3.

Open-Cast Workings

The geometry of each open-cast is unique. It depends upon the grade of the ore, the configuration of the ore body, the strength of the host rock and on the topography. Many pits are excavated to below the water table causing changes in the ground water flow. Surface drainage patterns are also commonly disrupted and most pits partially or entirely fill with water after the shut-down or abandonment of the mine. Rehabilitation objectives and control technologies measures for physical and chemical stability and for land use are summarised in Table 7.4.

7.6.4 Mine Rock and Overburden Piles

In order to gain access to the ore most mining projects require the removal of uneconomic rock. The mine rock is placed in piles, commonly as near to the excavation as is possible, without hindering future mining operations. At some mines ore is placed in piles and leached leaving the spent ore. In other cases the low grade ore is also piled and left. Because of economics, the low grade ore and the spent ore are commonly left as waste and have to be rehabilitated on the closure of the mine. These piles generally contain sulphides which usually develops into an acid drainage problem.

Overburden piles including topsoil, subsoil and excavated unconsolidated rock should be utilised in the rehabilitation of the site.

The configuration of a pile, whether rock or overburden, is primarily dependent on the dumping method used and on the local topography.

The rehabilitation plan should describe the specific measures and methods to be utilised progressively, at each stage of the rehabilitation, in order to achieve a long term physical and chemical stability for each of the piles. If there is a need for ongoing maintenance after rehabilitation it should also be identified and described.

Table 7.3. Rehabilitation Measures - Underground Workings

Issues	Rehabilitation Objectives	Control Technologies
PHYSICAL STABILITY ISSUES		
<ul style="list-style-type: none"> • Openings to surface which are hazardous to public (shafts, raises & stopes open to the surface, and portals to adits & declines) 	<ul style="list-style-type: none"> • Prevent inadvertent access • Permanently seal openings 	<ul style="list-style-type: none"> • Minimise number of openings (P) • Permanently plug or seal all access openings to surface • Backfill shafts & stopes, if practical • Vent water & gas pressures
<ul style="list-style-type: none"> • Surface disruption which are hazardous to public (caving, collapse of crown pillars) 	<ul style="list-style-type: none"> • Prevent inadvertent access • Surface stabilisation • Underground stabilisation 	<ul style="list-style-type: none"> • Use mining method resulting in stable surface (P) • Stabilise surface, if feasible • Ditch/berm &, if necessary, fence & sign post unsafe areas until natural stabilisation occurs • Backfill surface openings, if practical
<ul style="list-style-type: none"> • Surface disturbance (subsidence) 	<ul style="list-style-type: none"> • Surface re-contouring where beneficial 	<ul style="list-style-type: none"> • Use mining method resulting in stable surface (P) • Re-contouring or diversion to establish drainage patterns
<ul style="list-style-type: none"> • Barrier pillars stability which are hazardous to neighbouring operations 	<ul style="list-style-type: none"> • Prevent collapse and flooding of adjacent mine • Prevent collapse and stress transfer to adjacent mine 	<ul style="list-style-type: none"> • Permanently support boundary pillar, if practical and necessary • Ensure access to neighbouring mine and continued pumping, if required
CHEMICAL STABILITY ISSUES		
<ul style="list-style-type: none"> • Acid drainage and/or leaching of minerals or contaminants • Seepage of mill reagents from backfill 	<ul style="list-style-type: none"> • Meet water quality objectives by: <ol style="list-style-type: none"> 1. Control reactions 2. Control migration 3. Collect and treat 	<ul style="list-style-type: none"> • Flood workings to control reactions • Permanently plug workings & drill-holes to control migration • Collect & treat passively; active treatment to be avoided where possible • Drain all oil containing equipment, motors, transformers, etc.
LAND USE ISSUES		
<ul style="list-style-type: none"> • Productivity & aesthetics • Drainage interrupted • Groundwater lost 	<ul style="list-style-type: none"> • Return to original or accepted alternative use • Establish surface and groundwater drainage patterns 	<ul style="list-style-type: none"> • Backfill disrupted portions & openings where practicable • Contour surface • Flood workings • Establish vegetation

(P) - Option to be implemented at approved pre-mining or at operating stage.

Table 7.4. Rehabilitation Measures – Open-cast Workings

	Rehabilitation Objectives	Control Technologies
PHYSICAL STABILITY ISSUES		
<ul style="list-style-type: none"> • Safety • Hazardous cliffs • Water hazard • Failing slopes 	<ul style="list-style-type: none"> • Restrict access to hazardous areas • Emergency access to water 	<ul style="list-style-type: none"> • Ditch and berm • Fence, & sign post, if necessary • Slope stabilisation where practicable • Provide emergency access to water
<ul style="list-style-type: none"> • Slope Failure • Deep seated or overall slope failure • Erosion 	<ul style="list-style-type: none"> • Prevent deep seated failure, if practicable • Restrict access to unstable areas • Control sediment release, if necessary 	<ul style="list-style-type: none"> • For potentially unstable slopes, either stabilise by flattening slopes or constructing toe berm, or restrict access with ditch/berm &, if necessary, fence & sign post • Establish vegetation or place riprap • Provide stable spillway & overflow channel, rehabilitate for fish, waterfowl, wildlife habitat.
CHEMICAL STABILITY ISSUES		
<ul style="list-style-type: none"> • Acid drainage and/or leaching of metals 	<ul style="list-style-type: none"> • Meet water quality objectives by; <ol style="list-style-type: none"> 1. Control reactions 2. Control migration 3. Collect and treat 	<ul style="list-style-type: none"> • Flood to control reaction • Cover to control reactions and/or migration • Collect and treat, active treatment to be avoided where possible
LAND USE ISSUES		
<ul style="list-style-type: none"> • Productivity of land • Visual impacts 	<ul style="list-style-type: none"> • Return to approved alternative use 	<ul style="list-style-type: none"> • Backfill pit where practicable & beneficial • Flatten slopes • Contour - blend with natural topography • Establish vegetation

The details of the rehabilitation plan should include such aspects as:

- All piles of materials that will remain on the site
- The side slopes and stability of the piles
- The zones and descriptions of the different types of material
- The foundation materials

- The water management structures and their connection to the natural drainage systems
- The base drainage systems
- The sediment control structures

Rehabilitation methods and control technologies for physical and chemical stability and for land use are summarised in Table 7.5.

7.6.5 Tailings Impoundment

Tailings are the residual fraction of the ore after the recoverable economic minerals have been removed and represent the largest waste component of the operation. They are composed of sand, silt and mud in a water slurry. After processing they are deposited into an impoundment area. The impoundment structure is designed and constructed so that as far as is possible there will be a minimal physical impact and chemical impact on the environment. Where possible, the natural topography along with the constructed embankment dictates the design of the impoundment structure. When the topography is not amenable to being part of the structure, the whole impoundment structure is constructed with embankments.

History, however, has shown that many of the tailings impoundment areas have not been well or appropriately designed for the conditions under which they exist. Subsequently, they have failed, causing death in many cases and serious material damage in others. They also tend to be an eyesore and a source of public aggravation since many are not rehabilitated adequately, produce wind-blown dust and sand and are easily erodible.

Rehabilitation methods utilised in each stage of decommissioning or closure, should be designed to achieve long term physical and chemical stability. The techniques used should be described within the rehabilitation plan and a topographic plan showing locations of all of the impoundments should also be an integral part. Again, it must be stressed that the schedule of rehabilitation should be included in the plan.

If any structures are left on the site, the engineering details should always be available to any succeeding owner of the property and to the public. A description of the design life, the flood potential and the storage capacity for each of the structures after rehabilitation should be included. If these data are not available it is difficult to undertake remedial work should there be a failure. Table 7.6 provides the rehabilitation methods and the control techniques for the physical and chemical stability and land use of the site.

Table 7.5. Rehabilitation Measures - Mine Rock and Overburden Piles

	Rehabilitation Objectives	Control Technologies
PHYSICAL STABILITY ISSUES		
<ul style="list-style-type: none"> • Slope failure <ul style="list-style-type: none"> - deep seated or overall slope failure - erosion • Drainage disruption 	<ul style="list-style-type: none"> • Avoid deep seated failure • Avoid large surface slumps and sediment release 	<ul style="list-style-type: none"> • Site selection to avoid low strength foundations (P) • Internal drains to prevent water table rise • Construct in lifts to achieve flatter slopes • Covers to control infiltration of water • Ditches for water management • Bulldoze crest, if required, to flatten slope • Construct toe berm to stabilise slope and to flatten inclination • Collect sediment in ponds • Establish vegetation or riprap, where required • Monitor
CHEMICAL STABILITY ISSUES		
<ul style="list-style-type: none"> • Acid drainage and/or leaching of metals or contaminants 	<ul style="list-style-type: none"> • Meet water quality objectives by: <ol style="list-style-type: none"> 1. Control reactions 2. Control migration 3. Collect and treat 	<ul style="list-style-type: none"> • Underwater disposal to control reactions • Pre-treatment-blending of alkaline material to mitigate acid drainage (P) • Cover to control reactions and/or migration • Segregation of deleterious materials for controlled disposal or cellular pile construction • Collect and treat, active treatment to be avoided where possible • Monitor • Complete detoxification of all cyanide dumps, as required
CHEMICAL STABILITY FOR SPENT ORE PILES		
<ul style="list-style-type: none"> • Flushing of mill reagents <ul style="list-style-type: none"> - cyanide 	<ul style="list-style-type: none"> • Meet water quality objectives by: <ol style="list-style-type: none"> 1. Control reactions 2. Control migration 3. Collect and treat 	<ul style="list-style-type: none"> • Detoxify by flushing with water or other solution to degrade cyanide to pH<7 • Regulate seepage to meet water quality objectives with covers and/or retention pond prior to release
<ul style="list-style-type: none"> • Flushing of acid 		<ul style="list-style-type: none"> • Detoxify by flushing with lime solution to achieve effluent water quality which meets mine effluent objectives, if possible • Regulate seepage to meet water quality objectives with cover • Collect and treat - active treatment to be avoided where possible
LAND USE ISSUES		
<ul style="list-style-type: none"> • Productivity of land • Visual impacts 	<ul style="list-style-type: none"> • Returned to acceptable alternative use 	<ul style="list-style-type: none"> • Contour-blend with natural topography • Establish vegetation where practical

(P) - Option to be implemented at approved pre-mine stage.

Table 7.6. Rehabilitation Measures - Tailings Impoundment

	Rehabilitation Objectives	Control Technologies
PHYSICAL STABILITY ISSUES		
<ul style="list-style-type: none"> • Tailings <ul style="list-style-type: none"> - dust - water erosion 	<ul style="list-style-type: none"> • Control dust migration • Control tailings erosion 	<ul style="list-style-type: none"> • Establish erosion resistant covers of vegetation soil, riprap or water • Monitor
<ul style="list-style-type: none"> • Dams <ul style="list-style-type: none"> - deep seated or overall slope failure - surface slump - erosion 	<ul style="list-style-type: none"> • Factor of safety >1.5 for static conditions • Erosion resistant overtopping protection • Restrict access 	<ul style="list-style-type: none"> • Appropriate site selection and dam design (P) • Where necessary, stabilise embankments by constructing toe berm to flatten overall slope • Riprap or vegetation cover to control erosion • Increase freeboard and/or upgrade spillway to prevent overtopping • Ditch/berm/fence to prevent erosion by motorised vehicles
<ul style="list-style-type: none"> • Weathering • Destruction of permanent <ul style="list-style-type: none"> - structures - spillways - decant towers & pipes • Drainage disruption 	<ul style="list-style-type: none"> • Remove or establish long-term stability • Integrate with local drainage 	<ul style="list-style-type: none"> • Remove or plug/backfill structures • Diversions and spillways designed for long-term stability • Plug/seal decant lines through embankments • Define and provide for long-term monitoring and maintenance • Avoid ongoing operation where possible
CHEMICAL STABILITY ISSUES		
<ul style="list-style-type: none"> • Tailings and pore water <ul style="list-style-type: none"> - acid drainage - leaching - mill reagents 	<ul style="list-style-type: none"> • Meet water quality objectives by: <ol style="list-style-type: none"> 1. Control reactions 2. Control migration 3. Collect and treat 	<ul style="list-style-type: none"> • Implement permanent control measures • Flood to control reactions • Pre-treatment-removal of deleterious material for controlled disposal elsewhere or blending with alkali material to mitigate acid drainage (P) • Cover to control acid reactions and/or migration using inert material or bog • Ditch to divert runoff • Collect and treat - active treatment to be avoided where possible
<ul style="list-style-type: none"> • Dams, structures 	<ul style="list-style-type: none"> • Meet water quality objectives by: <ol style="list-style-type: none"> 1. Control reactions 2. Control migration 3. Collect and treat 	<ul style="list-style-type: none"> • Do not construct with materials which are potential acid producers or are leachable • Decontaminate and/or remove acid generating or leaching materials
LAND USE ISSUES		
<ul style="list-style-type: none"> • Productivity of land • Visual impacts 	<ul style="list-style-type: none"> • Return to appropriate land use 	<ul style="list-style-type: none"> • Rehabilitate by one or more of the following means: <ul style="list-style-type: none"> - flood, contour, cover, establish vegetation, wetland

(P) - Option to be implemented at approved pre-mine stage.

7.6.6 Water Management and Water Treatment

Water Management

The techniques used for ensuring that water on or around the site is controlled for the benefit of the mining operation and for the surrounding environment is referred to as water management. This involves the storage, conveyance and treatment of the water used on site, and also the diversion, discharge and the treatment of excess water. Water management facilities at mine sites include structures such as dams, spillways, diversion ditches, culverts, pipelines, pump houses, milling plants, settling ponds and dewatering systems. Poor water management design and execution can create problems long after the site is abandoned.

All other facilities that require maintenance, apart from those that will be needed to treat the water and the effluent from the site after the shut-down of the site, should be removed during the final rehabilitation phase.

Water management at a mine site during operations will cause changes in the natural hydrological and hydrogeological regimes. Ideally, there should be an attempt to return the drainage pattern to its pre-mining configuration. There are, however, instances where the local environment has adapted to the changed water regime and restoring it to former conditions may produce a negative impact. The rehabilitation objectives and control technologies for physical and chemical stability and for land use are summarised in Table 7.7.

Water Treatment

Water is used extensively throughout a mining operation both in the mill for an extraction of the minerals and in mining both underground or on the surface. Along with the use of water in the mining and milling operations, water treatment processes implemented during the mine operation very commonly must be continued after the shutdown until the water quality conditions meet the rehabilitation target objectives. Any project that requires long term water treatment after decommissioning cannot be considered as being closed until the water treatment is no longer needed.

The water treatment processes in use must be outlined in the rehabilitation plan. Very commonly, there will be a need for both the chemical and physical circuits, developed to upgrade the water during the life of the mine, to continue their operation. In the final stage of the mine, as it approaches closure, the discharge to the receiving environment must continue to be acceptable. Therefore, the pump houses and the dewatering systems used to handle the water must be maintained.

Table 7.7. Rehabilitation Measures - Water Management

	Rehabilitation Objectives	Control Technologies
PHYSICAL STABILITY ISSUES		
<ul style="list-style-type: none"> • Water dams <ul style="list-style-type: none"> - stability - erosion - overtopping - intakes/ decant towers 	<ul style="list-style-type: none"> • Ensure long-term stability • Protect erodible slopes • Ensure no overtopping • Seal pipes 	<ul style="list-style-type: none"> • Maintain embankment indefinitely • Breach dam • Maintain operating spillway in durable Rock • Plug intakes with concrete, plug decants and remove towers • Monitor
<ul style="list-style-type: none"> • Ditches <ul style="list-style-type: none"> - overtopping - erosion 	<ul style="list-style-type: none"> • Adequate flood capacity • Prevent blockage • Prevent erosion 	<ul style="list-style-type: none"> • Design for extreme events • Construct from materials suitable for long-term stability • Riprap protection • Provide for long-term maintenance • Monitor
<ul style="list-style-type: none"> • Storage Tanks <ul style="list-style-type: none"> - stability 	<ul style="list-style-type: none"> • Remove 	<ul style="list-style-type: none"> • Drain, remove or knock down, fill, & cover • Monitor
<ul style="list-style-type: none"> • Pipelines <ul style="list-style-type: none"> - collapse - obstruction 	<ul style="list-style-type: none"> • Remove surface and large shallow pipes 	<ul style="list-style-type: none"> • Remove all surface and large shallow pipes • Plug those pipes at depth • Monitor
<ul style="list-style-type: none"> • Culverts <ul style="list-style-type: none"> - blockage - collapse 	<ul style="list-style-type: none"> • Ensure maintenance free passage of water under design flood conditions 	<ul style="list-style-type: none"> • Remove and breach if not required • Upgrade to pass design flood • Provide for long-term maintenance • Monitor
CHEMICAL STABILITY ISSUES		
<ul style="list-style-type: none"> • Contaminated reservoirs 	<ul style="list-style-type: none"> • Meet water quality objectives by: <ol style="list-style-type: none"> 1. Control reactions 2. Control migration 3. Collect and treat 	<ul style="list-style-type: none"> • Drain, treat and discharge • Strip and dispose of contaminated soils in tailings dam or approved location • Breach dam • Establish vegetation • Treat indefinitely, if necessary • Monitor
LAND USE ISSUES		
<ul style="list-style-type: none"> • Dams <ul style="list-style-type: none"> - interruption of drainage 	<ul style="list-style-type: none"> • Restore drainage patterns • Determine if alternative use exists 	<ul style="list-style-type: none"> • Breach and restore to erosion resistant drainage • Stabilise to maintain dam
<ul style="list-style-type: none"> • Reservoirs <ul style="list-style-type: none"> - productivity of land - potential water supply 	<ul style="list-style-type: none"> • Return to appropriate alternative use 	<ul style="list-style-type: none"> • Maintain dam • Drain and establish vegetation
<ul style="list-style-type: none"> • Ditches 	<ul style="list-style-type: none"> • Restore drainage patterns 	<ul style="list-style-type: none"> • Grade to restore natural drainage • Establish vegetation

The most common contaminants carried by water as effluents from mining operations are:

- Cyanide and other mill reagents
- Suspended solids as fine particles
- Contaminated leachates from dump sites or polluted soil
- Acid mine drainage, from the oxidation of sulphide minerals
- Residues from blasting agents, such as nitrates
- Suspended or dissolved heavy metals from the mine workings and tailings deposits

The water treatment facilities after closure, or towards closure, probably represent the most complex and costly part of a rehabilitation programme.

7.6.7 Building Equipment and Infrastructure

Building and Equipment

All structures, facilities, and infrastructure on the site should be identified and described and the proposed rehabilitation and disposal methods outlined. A list of all materials that are to be disposed of on the site must also be carefully described as deterioration of man-made materials can often represent additional hazards. The rehabilitation objectives and control technologies of buildings and equipment for physical and chemical stability and for land use are summarised in Table 7.8.

Infrastructure

The site infrastructure, such as roads, railroads, airfields, power lines and water distribution systems, should all be identified and described in the plan. Rehabilitation methods and disposal methods should also be described. The rehabilitation measures of infrastructure for physical and chemical stability and for land use are summarised in Table 7.9.

7.6.8 Land Fill Disposal

Industrial and domestic wastes, produced as a result of the activities of the mining operation and its domestic support facilities, should be recycled as far as possible. Once all viable recycling options have been exhausted, these wastes are usually disposed to land.

The plan should include an inventory of all waste disposal areas, a description of the rehabilitation methods to be utilised and the schedule for progressive rehabilitation. Included in the plan should be a discussion of the long-term physical and chemical stability of the

waste management programme. Where wastes are to be removed or transported off the mine site and disposed of elsewhere, the transportation system and waste site should be identified and the method of disposition described.

Table 7.8. Rehabilitation Measures - Buildings and Equipment

	Rehabilitation Objectives	Control Technologies
PHYSICAL STABILITY ISSUES		
<ul style="list-style-type: none"> • Safety and access • Maintenance and stability <ul style="list-style-type: none"> - building - hoist & shaft facility - power plant - conveyors - mobile equipment 	<ul style="list-style-type: none"> • Control access 	<ul style="list-style-type: none"> • Decontaminate if necessary • Disassemble & remove all equipment and buildings • Backfill excavations • Remove buried tanks • Restore natural drainage
CHEMICAL STABILITY ISSUES		
<ul style="list-style-type: none"> • Buildings - insulation • Chemical storage areas • Mill reagents • Petroleum products • PCBs • Explosives 	<ul style="list-style-type: none"> • Make secure • Monitor stored supplies • Meet water quality criteria • Dispose of surplus chemicals off-site 	<ul style="list-style-type: none"> • Chemicals of all types to be recycled, returned to vendor, sold, or disposed of in an approved site
LAND USE ISSUES		
<ul style="list-style-type: none"> • Alternative uses • Productivity • Visual 	<ul style="list-style-type: none"> • Original or appropriate alternative use 	<ul style="list-style-type: none"> • Contour • Vegetate • Break and bury concrete • Restore natural drainage

The rehabilitation measures for physical and chemical stability and for land use are summarised in Table 7.10.

7.6.9 Chemical and Fuel Storage Areas

As chemicals and fuel are extensively used in most mining operations, and have commonly been found to contaminate the soils, an inventory of all the petroleum products and chemical storage areas and work areas should be made. The rehabilitation measures should be described for each storage and work area and should address the known or potential soil and water contamination.

Table 7.9. Rehabilitation Measures - Infrastructure

	Rehabilitation Objectives	Rehabilitation Measures
PHYSICAL STABILITY ISSUES		
<ul style="list-style-type: none"> • Roads <ul style="list-style-type: none"> - erosion - safety • Airstrips <ul style="list-style-type: none"> - erosion - safety 	<ul style="list-style-type: none"> • Control erosion • Make facilities safe 	<ul style="list-style-type: none"> • Remove culverts and make excavation stable • Remove all bridges and barricade approaches • Rip compact surfaces • Establish vegetation • Restore drainage patterns • Maintain necessary ditches, culverts and other facilities • Remove all elevated wires and poles • Ground all buried wires
CHEMICAL STABILITY ISSUES		
<ul style="list-style-type: none"> • Roads and airstrips <ul style="list-style-type: none"> - fuel or oil spills 	<ul style="list-style-type: none"> • Control flow to surface and groundwater 	<ul style="list-style-type: none"> • Rip compacted surfaces • Either treat and replace or dispose of in an approved site
LAND USE ISSUES		
<ul style="list-style-type: none"> • Roads and airstrips <ul style="list-style-type: none"> - productivity of land - visual impact • Power lines <ul style="list-style-type: none"> - visual impacts 	<ul style="list-style-type: none"> • Return to original or appropriate alternative use 	<ul style="list-style-type: none"> • Rip compacted surfaces • Establish vegetation • Remove all elevated wires and poles

7.6.10 Hazardous Waste Storage and Disposal

An inventory of all storage or disposal locations on site for hazardous waste and for toxic materials should be planned in detail. This aspect of rehabilitation and decommissioning is a very critical one if there are hazardous wastes on site. Due to these potential hazards, the proposed plan should outline in detail the storage locations and the proposed disposal methods. The continuing maintenance requirements and the anticipated security of the site that will be required must be clearly described.

Table 7.10. Rehabilitation Measures - Land Fill and Other Wastes

	Rehabilitation Objectives	Control Technologies
PHYSICAL STABILITY ISSUES		
<ul style="list-style-type: none"> • Landfill <ul style="list-style-type: none"> - erosion • Water treatment <ul style="list-style-type: none"> - sludge - erosion • Sewage lagoon <ul style="list-style-type: none"> - sludge - erosion • Contaminated fill <ul style="list-style-type: none"> -erosion 	<ul style="list-style-type: none"> • Control erosion • Prevent access 	<ul style="list-style-type: none"> • Provide erosion resistant cover • Stabilise slopes • Upgrade runoff diversion structures • Ditch/fence/berm • Sign post where hazardous facilities remain • Sewage sludge to soil amelioration
CHEMICAL STABILITY ISSUES		
<ul style="list-style-type: none"> • Landfill <ul style="list-style-type: none"> - flushing/leaching of metals or organics • Water treatment <ul style="list-style-type: none"> - sludge - remobilization of metals 	<ul style="list-style-type: none"> • Meet water quality objectives by: <ol style="list-style-type: none"> 1. Control reactions 2. Control migration 3. Collect and treat 	<ul style="list-style-type: none"> • Divert runoff with ditches or covers • Relocate to controlled disposal facility
LAND USE ISSUES		
<ul style="list-style-type: none"> • Productivity of land • Visual impacts 	<ul style="list-style-type: none"> • Return to appropriate alternative use 	<ul style="list-style-type: none"> • Where practical blend to match topography • Establish vegetation

7.7 EXERCICES

1. Which of the rehabilitation principles are:
 - a) concerned with human health and safety?
 - b) concerned with maintaining ecological health?
 - c) potentially required by regulation?
2. Where do the different principles fit into the different stages of the mining sequence for different types of mining?
3. Which of the principles require the preliminary study to have been carried out?

4. In addressing a rehabilitation plan, what are the critical criteria that must be addressed?
5. In developing a rehabilitation plan, what four components of the site must be considered?
6. What chemical control technologies can be applied to acid mine drainage, metal leaching, mill reagents?
7. What are the critical considerations in preparing a rehabilitation plan?
8. What should the contents of a rehabilitation plan be?
9. What are the physical, chemical and land use issues relating to underground mines?
10. What control technologies would you use to address the following physical stability issues in open-cast mines?:
 - Safety
 - Hazardous slopes
 - Water hazards
 - Failing slopes
 - Slope failure
 - Deep seated or overall slope failure
 - Erosion
11. What are some of the important factors in establishing mine rock or overburden piles?
12. Why is it necessary to have water management on a mine site?
13. What facilities for water management should exist on a site?
14. What are some of the most common contaminants carried by water as effluents from a mining operation?
15. What rehabilitation measures are necessary for the removal of roads, air fields and power lines?
16. How do regulations in your country determine rehabilitation objectives? What objectives has your company set itself in its environmental plan or policy?
17. Who is responsible for the rehabilitation plan? Who is involved in preparing and reviewing it?

Further exercises to be developed by the trainer.

References

For further reading on this subject the following texts are suggested. Additional references are to be found in Part IV Bibliography.

Barton-Bridges, J.P. and Robertson, A. MacG., 1989. Design and Reclamation of Mine Drainage. Canadian Land Reclamation Association and the American Society for Surface Mining and Reclamation, Calgary, Alberta

Environment Protection Agency of Australia, 1995. Rehabilitation and Revegetation. Part of the Best Practice Environmental Management in Mining series.

Feasby, D.G. and Tremblay, G.A., 1995. Role of Mineral Processing in Reducing Environmental Liability of Mine Wastes. Proceedings of the 27th Annual Meeting of the Canadian Mineral Processors, Ottawa, Ontario.

The International Journal of Surface Mining, Reclamation and Environment is a relevant, useful publication. Details are given in the "How to Use this Manual" section.

Peng, Syd S. And Harthill, Michalan, 1981. Workshop on Surface Subsidence due to Underground Mining

Puro, M.J. Kipkie, W.B. Knapp, T.J. MacDonald and Stuparyk, R.A., 1995. INCO's Copper Cliff Tailings Area. Proceedings of Sudbury '95 - Mining and the Environment, Volume 1, Sudbury, Ontario.

Warren, R.P., 1989. Mine Rehabilitation Handbook, Australian Mining Industry Council, ACT.

Chapter 7

Rehabilitation Planning

Prepared slides for overhead projection

Rehabilitation Planning

- **Principle of Rehabilitation**
- **Physical stability**
- **Chemical stability**
- **Critical considerations**
- **Rehabilitation plan**

Chapter 8

Monitoring

8.1 INTRODUCTION

Monitoring is intended to evaluate the effectiveness of current operations and progressive rehabilitation as well as closure and final rehabilitation measures. Monitoring will also provide the earliest possible warning if measures are unsuccessful or alternatively to verify whether the expected targets are being met. Data collected in a monitoring programme will also determine whether the single high values are within a normal range for the particular site being monitored. The monitoring must address physical stability, including the effects of static and dynamic conditions, and the chemical stability, which includes the prevention, migration and treatment control measures. Environmental impacts and the biological response also require monitoring on the site, in the downstream environment and in adjacent areas.

Monitoring should be carried out at an agreed frequency until the closure certificate is issued. It is very important that full records are kept of all physical activities at the mine in order to enable proper monitoring and rehabilitation. Monitoring and auditing should be seen as complementary activities, with auditing and monitoring activities being combined from time to time.

The monitoring programme should be well planned and should include the following items:

- purpose and objectives of the monitoring programme
- type and methods of monitoring to be carried out
- monitoring locations
- equipment and the instrumentation required
- frequency of monitoring and the expected duration of the programme
- quality assurance and quality control procedures
- methods to be used to inspect, record and evaluate the data
- parameters to be measured
- analytical detection limits of the techniques
- procedures for verifying the achievement of the expected conditions as originally planned in the rehabilitation plan.

In achieving an efficient monitoring programme, monitoring may involve one or all of three approaches; visual inspections, surveying and/or sampling and instrumentation.

- Visual inspections are qualitative observations for obvious conditions. Inspections also include simple quantitative measurements such as reading a measuring staff or a gauge in a stream.
- Surveying and sampling involves the measurement of a sufficient number of points to establish an area distribution of parameters such as a topographic survey or a stream water quality sampling survey.
- Instrumentation may include installed equipment for periodic reading or instrumentation for remote, intermittent or continuous data collection.

Monitoring stations should be established in or near all environmentally sensitive areas affected by the development programme and/or the rehabilitation programme, as well as at points where the mine operations are at risk. These individual stations may be of one or several types of facility. Complex projects or operations in sensitive areas will require many monitoring points. Physical stability should be monitored on each structure. For some facilities, the downstream stations should also measure sediment release. Monitoring stations for chemical stability should be established upstream of the site, within the site and downstream of the site for each component. Both surface water and groundwater flow should be measured.

A long-term monitoring programme, implemented during the development of the property and continued through closure, should after closure, decrease the frequency of sampling as the time after the decommissioning increases. If significant changes in environmental conditions are detected at any station then additional monitoring should be introduced. If there is an adverse impact, alternative control or treatment techniques must be designed, tested and implemented. The monitoring programme then has to be revised to monitor the success or weakness of the added new measures.

Current technology does not provide structures which can be expected to be effective for periods of hundreds or thousands of years. Therefore, periodic inspection and maintenance of such structures as tailings dams, covers over potentially acid generating waste or shaft caps should be monitored for an extended time after decommissioning.

Figure 8.1 shows an idealised mine site with typical areas of interest on a mine and the different monitoring stations that should be in place. It provides an example of the sensible placing of monitoring sites and stations.

All areas used for mining activities, including the downstream areas most likely to be affected should be included in the monitoring programme. The illustration shows an envelope for monitoring. Points at which water flows enter and exit the envelope are the upper most and lowest downstream water quality monitoring points. The upstream monitoring stations (UMS) provide background data on the quality and quantity of water entering the area. The downstream monitoring stations (DMS) are located where the water quality objectives are to be met. It is good practice to divide the site into a number of sub-sites, thus more easily locating the sources of contamination, once detected. The surface water exit stations on these sub-sites are shown as (SSMS). Between the DMS and SSMS

there may be a number of site monitoring stations (SMS) at locations where the combined effects of the sub-sites and the surrounding areas may be measured. Within each sub-site there may be a number of local measuring stations (LMS) at which the effects at various locations or structures can be monitored.

8.2 MONITORING PHYSICAL STABILITY

Both during operations and after decommissioning and rehabilitation all physical structures and features on the site should be monitored continuously for their stability. Many of the disasters on operating or abandoned mines are related to the failure of waste mine rock or tailings dumps. In the interest of operating safety, monitoring of dumps should be an integral part of the development and maintenance of any waste dump of significant height. Experience gained through operations show that dump failures do not occur without warning.

The indications can be detected from an interval of a few hours to a few days or weeks. If monitoring records of the rate of displacement show a trend of progressively faster rates, this should be taken as a clear warning of impending failure.

A failing tailings pond in which the tailings have become liquefied can easily engulf everything before it including buildings, people, animals and the landscape. Chemically, it can carry toxic chemicals and heavy metals that will contaminate and block water courses. In a mine waste rock dump failure at the crest will cause large fragments which can attain considerable velocity on their descent. For example, for a 200 metre high dump boulders may be travelling at velocities as high as 40 metres per second or 145 kilometres an hour. Physical stability issues and possible monitoring methods are summarised in Table 8.1.

Three basic types of monitoring can be undertaken: visual; surveying; and instrumentation.

8.2.1 Visual Monitoring

Visual monitoring may consist of inspection with supporting notes and/or photographs. Air photographs can also be used. It is important to note that the most effective form of monitoring is ground-based visual inspection and sampling on a regular basis.

8.2.2 Surveying

Surveying includes all types of physical measurements, such as topographic (geodetic) surveying across settling or moving areas, underground surveying for movement, flow measurements of moving water or deformation measurements of unstable dumps or pit slopes. Vertical and horizontal triangulation with electric distance measuring equipment and photogrammetric methods are also used.

8.2.3 Instrumentation

Instrumentation is generally applied to critical facilities such as tailing dams, covered waste piles and mine waste rock piles. This typically includes settlement gauges, inclinometers and piezometric ground water measurements.

In all cases instruments should be simple, robust, easy to install, durable and easy to read. The degree of their complexity depends on the purpose, the length of time an instrument is needed, and who will read and process this information. Also, the longer an instrument is needed the simpler and more durable it should be.

Improperly installed, unreliable, or malfunctioning instruments that produce erroneous data, can give rise to unwarranted worry and poor decisions. The most commonly used instruments are:

Water Level Meter

Ground water pressure, or pore water pressure, or the phreatic level is one of the most critical factors that has to be measured to determine the stability of a structure.

The simplest method of measuring water content of a dump or structure is by measuring the level of the water in the structure. This relates to the pore water pressure. A water level meter is used to measure depth of the water in wells, bore holes and standpipes.

Piezometer

Pore pressures related to both consolidation settlement and shear can be monitored with piezometers. A piezometer is a device that is sealed into the soil or the material to measure the water pressure around itself. Piezometers may be classified into two broad categories, those used in permeable ground and those used in ground with low permeability and low flow.

The first type is a standpipe version in which the ground water is allowed to rise in a vertical tube which leads to the surface.

The second type includes the pneumatic vibrating wire, or twin tube hydraulic piezometers which can be used through leads that do not have to rise vertically to the surface. These types of piezometers can be used to measure high pore water pressures that develop when soft, compressible, fine grained materials are loaded or sheared.

Figure 8.1 Examples of monitoring stations and areas

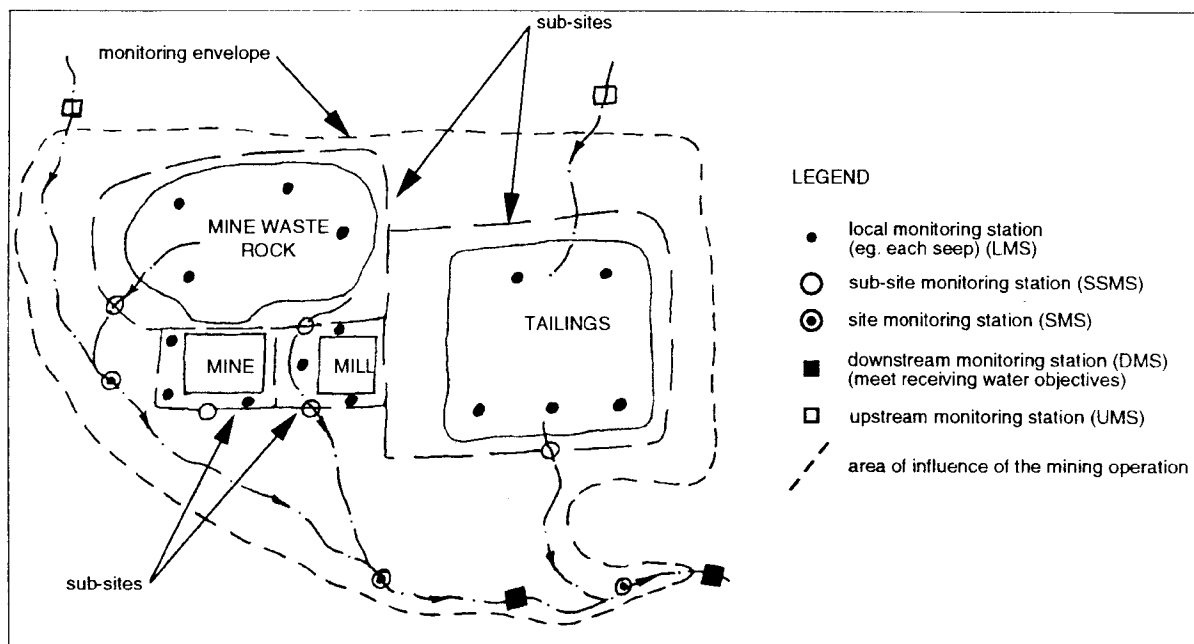

Table 8.1. Monitoring Methods for Physical Stability

MINE COMPONENT	ISSUES	POTENTIAL MONITORING METHODS
UNDERGROUND MINE		
<ul style="list-style-type: none"> ● Crown pillar/glory hole ● Shafts/adits ● Plugs 	<ul style="list-style-type: none"> ● Access ● Stability ● Water discharge 	<ul style="list-style-type: none"> ● Visual - inspect ditch/berm/fence/signs ● Visual - look for tension cracks & scarps, changes in drainage patterns ● Survey - displacements and settlements ● Instrumentation ● Visual - look for seepage ● Survey - monitor flow rate of leakage ● Instruments - V-notch, weirs, flow depth
OPEN PIT		
<ul style="list-style-type: none"> ● Slopes 	<ul style="list-style-type: none"> ● Access ● Stability 	<ul style="list-style-type: none"> ● Visual - inspect ditch/berm/fence/signs ● Visual - look for tension cracks at crest of slope and signs of new or ongoing failure ● Visual - look for gully erosion, alluvial fans; sample for suspended solids ● Survey and/or instrument - critical-rates of slope movement ● Instruments - settlement sensors, piezometers
ROCK & OVERBURDEN PILES		
<ul style="list-style-type: none"> ● Slopes ● Covers 	<ul style="list-style-type: none"> ● Access ● Stability <ul style="list-style-type: none"> - deep seated - surface slump - erosion ● Access ● Stability 	<ul style="list-style-type: none"> ● Generally not required ● Visual - look for tension cracks at crest of slope and signs of new or ongoing failure ● Survey and/or instrument - critical-rates of slope movement ● Instruments - piezometers - groundwater table ● Visual - look for failure ● Survey - measure rate of slope creep ● Visual - look for gully erosion, stability of vegetation ● Sample drainage for suspended solids ● Visual - inspect ditch/berm/fence/signs ● Visual - look for gully erosion, stability of vegetation ● Sample drainage for suspended solids ● Instrumentation - stakes to measure erosion
TAILING IMPOUNDMENT		
<ul style="list-style-type: none"> ● Tailings and/or cover ● Dams ● Underdrains 	<ul style="list-style-type: none"> ● Access ● Stability ● Stability ● Erosion ● Water discharge 	<ul style="list-style-type: none"> ● Visual - inspect ditch/berm/fence/signs ● Visual - look for gully erosion ● Sample drainage for suspended solids ● Instruments - piezometers ● Visual - look for tension cracks at crest of slope and signs of new failure ● Survey and instrument - critical-rates of settlement, seepage rates, internal deformation ● Instruments - piezometers for phreatic surface ● Visual - look for gully erosion ● Sample drainage for suspended solids ● Survey - discharge rate ● Instruments - flow measurements
WATER MANAGEMENT		
<ul style="list-style-type: none"> ● Ditches & Spillways 	<ul style="list-style-type: none"> ● Stability ● Water discharge 	<ul style="list-style-type: none"> ● Visual - look for ditch bottom and side slope erosion ● Visual - look for sediment, debris and blockage ● Instruments - flow measurements

Crackmeters and Extensometers

Deformation in an embankment or in the foundation, as a result of settlement and shear displacement, can be measured by extensometers. Movement between cracks on the surface of an embankment or structure can be monitored by various types of surface extensometers or crackmeters. However, the simplest and least expensive method, which is normally adequate, is by measuring change in distance and elevation between fixed stakes or points.

Settlement at depth may be measured by using a probe extensometer which is a device to measure distance between two or more points along a common access. Measuring points are identified either mechanically or electrically by a probe.

Inclinometer

Inclinometers are normally used to monitor slope movement in embankments or structures. The inclinometer probe is a gravity sensing device that measures the inclination with respect to the vertical as it passes along guides in a special tube installed in a bore hole.

Seals

In order to emplace instrumentation it is commonly necessary to seal the instruments in place. A sand/bentonite injector is used to emplace seals.

As tailing dams represent a major concern in the maintenance and monitoring of decommissioned sites, Table 8.2 summarises the diversity of instrumentation that is required for monitoring.

In water surveying, instrumentation is used for stream flow data collection to determine rates of flow and analysis for suspended solids in order to check for erosion rates.

8.3 MONITORING FOR CHEMICAL STABILITY

Monitoring for chemical stability consists of two parts, monitoring for leachate generation and monitoring for migration. In cases where leachate treatment is in progress then monitoring for efficiency of treatment will also be required.

Monitoring for chemical stability involves the collection and analysis of both surface water and groundwater samples. Water quality and water quantity measurements may be required at each monitoring station. The collection of water may utilise emergent seepage points, wells, piezometers or ditches. At some acid generating sites additional monitoring may be required and be comprised of gas measurements, such as for oxygen monitoring under tailings covers, or temperature measurements in rock piles and tailings which might indicate chemical activity.

Table 8.2. Instrumentation Monitoring for Tailings Dams

	Site Investigation	Construction	Operation	Long-Term Performance
• Groundwater level	• piezometers			
• Temperature	• thermistors	• thermistors	• thermistors	
• Seepage/internal erosion (piping)			• weirs • piezometers • visual	• weirs • piezometers • visual
• Settlement		• piezometers • surveying • extensometers • visual	• piezometers • surveying • extensometers • visual	• visual
• Stability		• piezometers • surveying • inclinometers • crack gauges • visual	• piezometers • surveying • inclinometers • crack gauges • visual	• visual
• Condition of filters and drains			• piezometers • visual	• piezometers • visual

Chemical reactions with geological materials cause dissolved solutes to migrate at different velocities than the groundwater. Therefore, dispersion alone is not enough to predict the migration of contaminant zones, or for performing pathway analyses at sites. To measure these data an in situ bio/geochemical monitor may be used. It can be permanently installed and could provide a continuous indication of remediation effectiveness. The chemical stability issues and the possible monitoring methods for decommissioned mines are summarised in Table 8.3.

The most important parameters that should be monitored are listed below. Depending on the characteristics of the mine site, it may be necessary to monitor for more or less parameters.

Table 8.3. Monitoring Methods for Chemical Stability

Mine Component	Issues	Potential Monitoring Methods
UNDERGROUND MINE		
<ul style="list-style-type: none"> • Crown pillar/glory hole • Shafts/adits • Plugs 	<ul style="list-style-type: none"> • Acid generation and/or leaching of metals • Mill reagents in backfill • Acid generation and/or metals migration 	<ul style="list-style-type: none"> • Underground drainage sampling and analysis • Sampling of downstream surface and groundwater drainage
OPEN PIT		
<ul style="list-style-type: none"> • Slopes • Groundwater discharge points 	<ul style="list-style-type: none"> • Acid generation and/or leaching of metals • Acid generation and/or metals migration 	<ul style="list-style-type: none"> • Drainage pit sampling and analysis • Sampling of downstream surface and groundwater drainage
ROCK & OVERBURDEN PILES		
<ul style="list-style-type: none"> • Slopes • Covers 	<ul style="list-style-type: none"> • Acid generation and/or leaching of metals • Acid generation and/or metals migration 	<ul style="list-style-type: none"> • Seeps: sampling and analysis • Rock pile: sampling and analysis • Sampling and analysis of downstream surface and groundwater
TAILING DEVELOPMENT		
<ul style="list-style-type: none"> • Tailings and/or covers • Dams 	<ul style="list-style-type: none"> • Acid generation and/or leaching of metals • Mill reagents in backfill • Acid generation and/or metal migration • Mine sludges in tailings 	<ul style="list-style-type: none"> • Runoff sampling and analysis • Tailing sampling and analysis • Seeps: sampling and analysis
BUILDINGS		
<ul style="list-style-type: none"> • Mill • Chemical Storage 	<ul style="list-style-type: none"> • Spill, leakage • Leakage • Tampering 	<ul style="list-style-type: none"> • Visual, sample if spill is suspected
WATER MANAGEMENT		
<ul style="list-style-type: none"> • Ditches • Spillways • Dams 	<ul style="list-style-type: none"> • Water quality change • Environmental impact evaluation 	<ul style="list-style-type: none"> • Sampling and analysis

Chemical Parameters to be Monitored

General Parameters	General Field Parameters	Trace Elements
Sodium	Alkalinity (CaCO ₃)	Aluminium
Calcium	Electrical conductivity	Antimony
Magnesium	pH	Arsenic
Potassium	Temperature	Bismuth
Carbonate	Turbidity	Cadmium
Chloride		Chromium
Sulphate	Nutrients	Cobalt
Bicarbonate	Ammonia	Copper
Fluoride	Nitrate	Iron
Hydroxide	Nitrite	Lead
Total dissolved solids	Phosphate	Manganese
Total suspended solids	Silica	Mercury
		Nickel
Cyanide	Radionuclides	Selenium
Free cyanide	²²⁶ Ra	Uranium
Cyanide-WAD	²²⁸ Ra	Zinc
Total cyanide		

8.4 MONITORING FOR ENVIRONMENTAL IMPACT

Rehabilitation environmental impacts and biological response should be monitored where conditions warrant. During the operation of the mine, biological surveys of the mine site and surrounding off-site locations should have been carried out in order to check for changes in the vegetation, in the wildlife habitat and in the aquatic habitat. These checks may indicate, for example, the subtle migration of acid drainage which might not be detected by an established monitoring system. Also, a situation might arise during a « first flush event » (i.e. the first load of pollutants entering the environment after a prolonged dry period) where acid products are released between the sampling times at the monitoring stations.

8.4.1 Revegetation

The success of a revegetation programme will be impacted by variations in the local ecological system that surrounds the mine site. For this reason, continued monitoring is necessary to determine the success of revegetation and the recovery of the site. Natural ecological effects will therefore have to be monitored to determine whether the revegetation programme is successful and is progressing to a desirable, sustainable vegetative cover. The types of effects include:

Depletion of Nutrients

This is particularly important when nutrients required have been added for the continued healthy, sustainable vegetative growth. If it is necessary to continue to fertilise after the establishment of the vegetation, the choice of technique was probably wrong and other amendments and species should be investigated.

Fires

Fires which occur during the early stages of vegetation development are of particular concern. The fires can reduce the beneficial effects of the vegetative cover and can alter the progress of desirable species development.

Drought

Drought can have similar effects as fire where the nutrients may be consumed and the vegetative cover and control is removed. The lack of vegetation, in both cases, will cause soil erosion.

Erosion

See Chapter 9.

Chemical Uptake

Chemical uptake can be a slow process dependent on the migration of salts through covers and through the root penetration rate. This can be either detrimental or beneficial to the vegetation, depending on the nature of the chemicals.

Species Invasion and Evolution

Burrowing animals can both benefit or inhibit the success of revegetation. They can assist in the aeration of the soil, carry seeds and bacteria or, conversely, penetrate a cover and cause the influx or exit of undesirable chemical elements.

In cases where environmental concerns remain, biological assessment should be continued until a stable environment is established.

8.4.2 Impact Offsite

The mine's environmental impacts offsite need to be monitored as well. The following are some of the more important issues that should be monitored:

- Movement of local people into the area
- Aquatic habitats
- Groundwater quality
- Stream water quality
- Foreign animals and vegetation

8.5 EXERCISES

1. Who is responsible for developing the monitoring programme?
2. With whom should the monitoring programme be discussed before it is finally approved?
3. What laboratory and technical services are required onsite to undertake a monitoring programme?
4. Over and above the parameters monitored by companies, what parameters should the government monitor?
5. When should the monitoring programme be reviewed, and by whom?
6. Where should results be kept, and to whom should they be reported? Who should prepare the monitoring programme report?
7. How are the monitoring programme and further rehabilitation action linked? What mechanism(s) are required to ensure that they are, in fact, linked?
8. Which staff are responsible for monitoring, and what training or qualifications should they have?
9. How is monitoring typically included in a site permit?
10. When should monitoring cease?

Further exercises to be developed by the trainer.

References

For further reading on this subject, the following texts are suggested. Additional references are to be found in Part IV.

Australian Environment Protection Agency, 1995. Environmental Monitoring and Performance. Part of the Best Practice Environmental Management in Mining series.

Rodrigue, D., Mailhiot, K., Hynes, T.P. and Wilson, L.J., 1995. Aquatic Effects Monitoring in the Mining Industry: Review of Appropriate Technologies. Proceedings of Sudbury '95 - Mining and the Environment, Volume 2, Sudbury, Ontario, Canada.

United Nations, 1996. Monitoring Industrial Emissions and Wastes. TR 27. UNEP IE and UNIDO.

Welsh, D.E., Campbell, D.B., Knapp, R., 1990. Mine Monitoring Manual. Section 4.2, Special Volume 42, The Canadian Institute of Mining and Metallurgy, Montreal, Quebec, Canada.

Chapter 8

Monitoring

Prepared slides for overhead projection

Monitoring

- **Monitoring physical stability**
- **Monitoring for chemical stability**
- **Monitoring for environment impact**

Instrumentation Monitoring for Tailings Dams

- **Groundwater level**
 - piezometers
- **Temperature**
 - thermistors
- **Condition of filters and drains**
 - piezometers

Instrumentation Monitoring for Tailings Dams

- **Stability**
 - **piezometers**
 - **surveying**
 - **inclinometers**
 - **crack gauge**
 - **visual**

Instrumentation Monitoring for Tailings Dams

- **Seepage / internal erosion (piping)**
 - weirs
 - piezometers
 - visual
- **Settlement**
 - piezometers
 - surveying
 - extensometers
 - visual

Chapter 9

Erosion Control

9.1 INTRODUCTION

Erosion on abandoned mine sites and some operating mines sites is probably the most debilitating of all perpetual disruptive forces. Because of the fine nature of the tailings at most mines, if there is not sufficient cover they can produce major health hazards. Apart from the fine particles and the impact on the respiratory systems of man and animals and upon vegetation, the residual chemicals often carried in the dust can also cause serious allergic reactions. In addition, dust cover can inhibit seed germination and growth.

In the case of water erosion an initially small seep can develop into major erosion on a tailings or a waste rock dump which can weaken the structure and subsequently become the cause for major failure. Water erosion can also be the agent for carrying toxic materials into other environments and thus also affect man, animal and vegetative life. Due to the problems of these two erosional forces this section is devoted to counteracting erosional activities as well as providing solutions to many erosional problems.

The control of the effects of both wind and water is essential, during a mining operation, in the period of rehabilitation and during the subsequent land use. Wind and water can radically effect the health of man, animals and plant life, both physically and chemically. It is therefore necessary to manage the effects of these agents as best as possible and implement the appropriate remedial works on sites when necessary.

The main objective of most rehabilitation programmes is to establish an appropriate cover of vegetation in order to stabilise the site and to control excessive erosion, which in turn will affect the state of the local ecosystem. Along with the establishment of an acceptable vegetation cover, there is a need to insure that the land forms or the structures are stabilised, otherwise the vegetation may not have an opportunity to be established.

Until adequate structural and vegetation conditions are stabilised and well established, there is a need to provide interim protection against both the effects of wind and water erosion. These protective measures, in many cases, may later translate into permanent measures.

9.2 WIND

The areas usually most susceptible to wind erosion are dunes, poorly vegetated semi-arid and arid regions, active tailings dumps, old tailings dumps, waste piles and denuded areas. In addition to mining the impact of human activities such as farming, through overgrazing and over cultivation, and poor practices in forestry have also created denuded areas.

The main impact of wind erosion on denuded areas is the reduction of the productivity of the soil. This may be through the removal of soil and from the drifting of relatively barren tailings and dust which can cover local vegetation and productive soils. In addition, wind erosion creates a dust nuisance and provides a vehicle whereby noxious

elements can be transported through the air and impact on human, animal and plant life. It will also create drifts that may disrupt water courses or access ways.

Most of the wind erosion material is deposited locally. However, if fine enough, wind eroded material can, under certain conditions, move great distances. This is particularly in the case areas where there is little vegetation as a result of natural conditions or conditions caused by human activities.

Wind can also act as a vehicle for transporting fine particles of dust which can cause respiratory problems. If present it will carry asbestos fibre, cyanide, both as cyanide dust and as hydrogen cyanide, and if adjacent to dry uranium tailings, will carry the decay products of uranium such as radon. All of these elements can be detrimental to humans, animals, fish and plant life.

The best means of countering wind erosion in the long term is a sustainable, stable cover of vegetation on stable ground. In the short term, while a permanent cover of vegetation is being developed there is a need for controlling wind erosion on the disturbed land where rehabilitation is still in progress.

Three methods are commonly used to control wind erosion on disturbed land. All are aimed at reducing the wind velocity near the soil surface. The three basic methods are:

- Protection of the soil surface by materials. These may be mulch, natural materials or synthetic materials.
- Maintenance of the soil surface in an erosion resistant condition.
- Reduction of the wind velocity across disturbed areas by the use of windbreaks.

9.2.1 Protection of the Soil by Materials

In most cases the use of mulch, other natural materials or synthetic materials may form an integral part of the revegetation programme. The objective is to establish a permanent protective cover that will be sustainable in the long term.

Mulch

In using mulch it is necessary to consider the following:

- **Availability of Material**

Particular attention should be paid to the use of waste or by-products, which require disposal. Both types may be available at low cost. Examples would be low grade peat, forest chips or debris, crop wastes, garden wastes, or hygienically segregated sanitary landfill. Table 9.1 gives a more extensive list of types of organic mulch for erosion control.

Table 9.1. Common Mulch

MULCH TYPE	INTENDED USE EROSION CONTROL
Straw (tonne/hectare)	1.2
Hay (t/ha)	1.2
Manure (t/ha)	12 - 16.5
Hardwood bark (m /ha)	74
Softwood bark (m /ha)	74
Hardwood chips (m /ha)	83
Softwood chips (m /ha)	83
Sawdust (m /ha)	170
Leaves (t/ha)	1.5
Wood-cellulose fibre (kg/ha)	551

After Slick & Curtis 1993

- **Seeding or Planting Methods**

Methods of seeding or planting may be integrated with the application of mulch such as hydroseeding for example. Hydroseeding, which is extensively used in North America, can be used very efficient. It involves the high pressure placing of straw or hay along with fertiliser and seeds onto the soil surface. Ideally, it should be carried out in the growing season when there is adequate rainfall in the more arid or semi-arid areas.

- **Rock or Resistant Mulch**

If total exclusion of activity from the property is not practicable or if the area is highly trafficked, rock mulch or similar resistant material may be used. This might include clinker, slag or non-mineralised country rock. In some cases fly ash may also be used providing it has been pelletised or agglomerated. The fly ash will also add nutrients to the soil.

- **Colour and Temperature**

In utilising any mulch, a word of caution is necessary. The effect of the colour of the mulch on the soil temperature can be a major problem. Dark coloured mulches can significantly raise the soil temperatures and light coloured reduce them. In hot areas the raising of the temperature of the soil can inhibit the development of any growth, and conversely the light colour in temperate climates can keep the soils at a lower temperature

than the surroundings and inhibit growth. Very simply, in endeavouring to establish vegetative cover, too high a temperature might even thermally damage seeds, and too low a temperature might stop germination altogether.

The Use of Obstacles

In arid and semi-arid areas and in areas where abandoned tailings dams represent a major source of dust, the creation of dimpling has been shown to inhibit wind erosion and to assist in revegetation. The dimples are created by using dumping equipment, such as trucks and loaders rather than bulldozers or scrapers, to place the overburden or top soil in contiguous heaps. This method is best suited to the tops of most tailings dumps and on slopes of 12 degrees or less. The dimpling effect not only inhibits the effect of the wind erosion, it also provides pockets on leeward slopes for the accumulation of seeds and allows bacteria and organic materials to accumulate and thus form nuclei for growth of vegetation (Figure 9.1).

Another method of creating a dimpling effect is the use of used vehicle tires from wheeled equipment. This works well and promotes the same effect as the dimpling. In these days of conservation and recycling the use of discarded tires can have a two-fold positive effect (Figure 9.2).

9.2.2 Erosion Resistant Methods for Soils

The maintenance of the soil surface in an erosion resistant condition from wind can be carried out in a number of ways.

Ploughing or Scarifying

If the soils are appropriate, scarify or plough the surface to a cloddy lumpy condition. The soil must have a certain percent of clay present in order to coalesce to hold the lumps together. It is, however, particularly difficult in sandy soils because sand particles do not easily adhere to each other. Considering that most soils under discussion are tailings derived, maintaining a cloddy surface may be difficult. Should there be a supply of slimes on the property or in the vicinity, the pumping of these slimes on top of the tailings may provide sufficient adherence to maintain a cloddy surface. A simple test to determine soil texture is given in Figure 12.1 in Chapter 12.

The Use of Water

If the soil surface is kept damp by the use of sprays, sprinklers or water bowsers, this will increase the aggregation of the particles and the resistance of the soil to wind erosion.

Figure 9.1 Dimpling Effect from Dumping

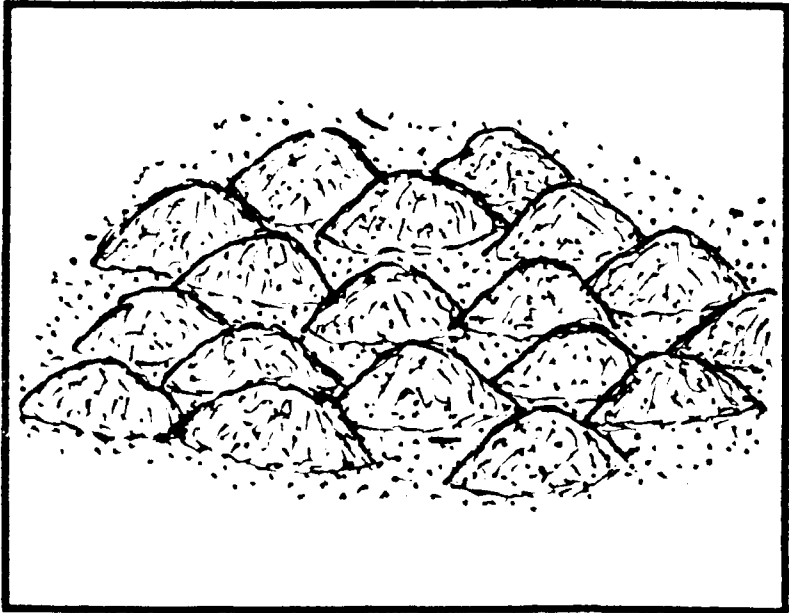
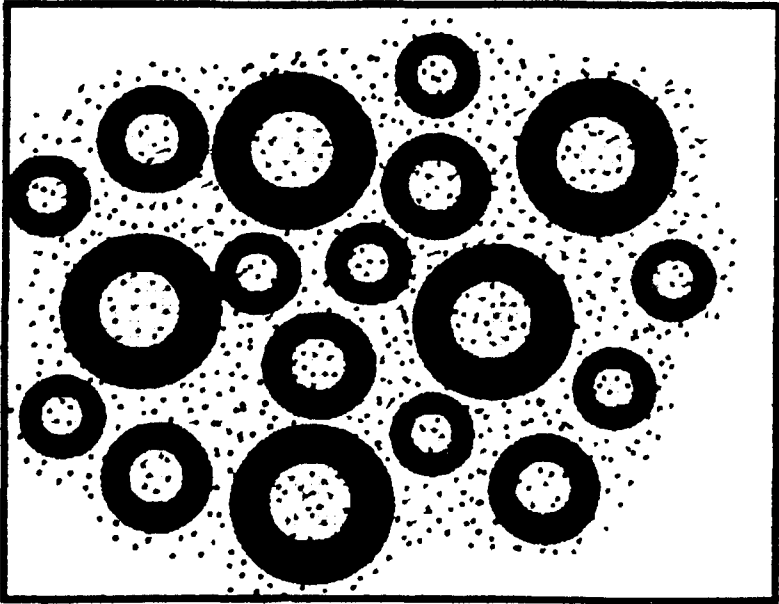

Figure 9.2 The Use of Discarded Vehicle Tyres



9.2.3 Wind Velocity Reduction by Windbreaks

Windbreaks may be rows of trees or shrubs planted at right angles to the prevailing or eroding winds. Artificial windbreaks, such as wood slat fencing or plastic mesh fencing can also be used as a temporary solution. When designing the establishment of windbreaks, a number of critical factors should be considered.

The Use of Trees or Shrubs

The trees or shrubs selected should be fast growing and hardy. In selecting fast-growing shrubs, care must be taken not to introduce noxious or unwanted weeds. Fast growing vegetation usually has a high rate of water consumption and commonly will deplete much of the ground water in the immediate vicinity. This may affect the ground water regime in adjacent areas. For these reasons, a knowledge of the vegetation used and its characteristics is necessary to select the right species. If the operator does not have this knowledge, it is strongly suggested that a knowledgeable horticulturist or forester be consulted.

Direction of the Critical Winds

Commonly, windbreaks should be placed at right angles to the direction of the prevailing winds. However, before deciding on the configuration of the windbreak, it is necessary to determine which of the daily or seasonal winds are initiating most of the dust problem or soil loss problem.

A wind rose diagram can be used to determine the wind intensities and directions, in order to better locate windbreaks.

Height and Spacing

On level ground protection will extend for a distance of approximately 20 times the height of the windbreak. This should determine the spacing between the rows of the windbreaks.

Permeability

A common error in the erection of windbreaks is if the barrier is not penetrable it creates major down drafts and up drafts in front of and beyond the windbreak, thus defeating the purpose of the windbreak. Ideally, windbreaks should have a permeability of approximately 40 per cent.

Figure 9.3 illustrates a non-recommended dense windbreak showing the path of the winds and Figure 9.4 illustrates a recommended permeable windbreak which permits a controlled flow of air, which also shows the path of the winds.

Figure 9.3 Type of Windbreak - NOT RECOMMENDED

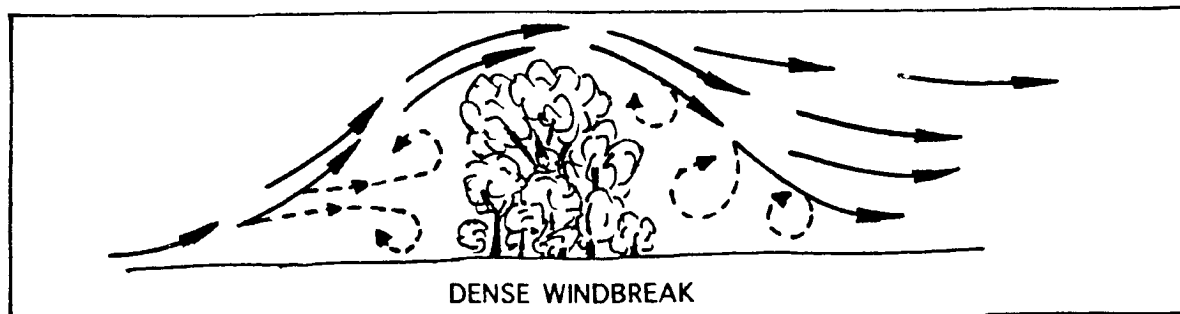
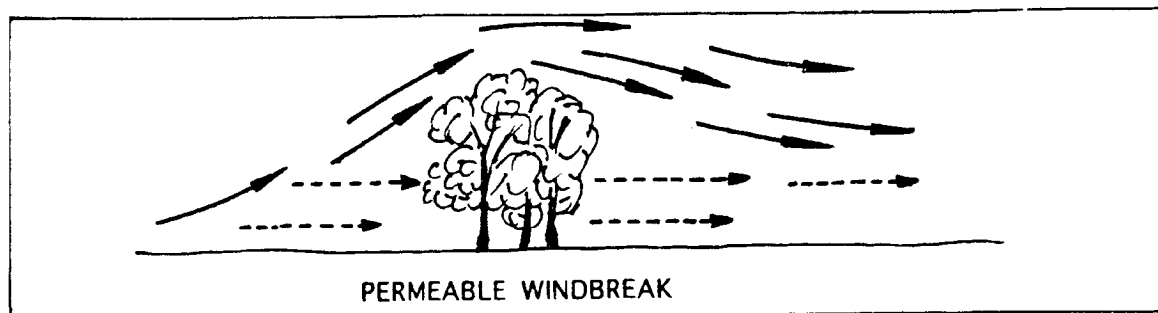

Figure 9.4 Type of Windbreak – RECOMMENDED



Length and Continuity

In constructing windbreaks, gaps are commonly established to gain access. If incorrectly constructed, the gap would defeat much of the purpose of the windbreak. Similarly, if the windbreaks are too short or too low to protect the affected area they would not accomplish their purpose. Either of these two errors will cause greater turbulence and greatly increase the wind speed, and could therefore aggravate the situation even further.

Since there is a need for access through windbreaks, gaps are necessary. The structure of this gap should be designed to protect the gap, to avoid wind funnelling and thus avoid an increase in the velocity of the wind. Figure 9.5 shows a situation where there is an unprotected gap in the windbreak. It also shows that the windbreak is too short to protect the whole of the disturbed area. The result is a high velocity turbulence that develops on either side of gap and around the ends of the windbreak. Through the gap itself and around the two ends, wind of a higher velocity will commonly occur.

Figure 9.6 shows three alternatives relative to the protection of the gap in the windbreak. As can be seen from the illustration, example (a) involves the planting of a short windbreak in front of the gap. Example (b) is a slanting row diagonally across the gap and example (c) is the slanting of vegetation itself within the gap. These illustrations do not represent all of the possibilities and are only shown as examples.

9.3 WATER

9.3.1 Introduction

Erosion by water is one of the most devastating natural activities both from the standpoint of the physical impact and as a carrier of unwanted and noxious materials (Table 9.2).

Water erosion is caused mostly by surface runoff from heavy rainfall or from excessive flow from a dam, either during the operation of the dam or after its failure. Water run off can also come from man-made and man-operated facilities, such as water treatment plants, water storage dams, tailing dams or from other man-made structures.

The impact of water erosion is also governed by the soil structure and the landscape configuration. The uptake of sediments cause rapid filling of tailings impoundments or dams, causing a rupture of the retaining structures.

Water erosion is not confined to those areas of heavy rainfall or temperate climate areas alone, it very commonly has a devastating impact on the local ecosystem in arid and semi-arid areas where high intensity, low frequency rainfall is common. It is critical that any plan to rehabilitate a site insures that there is a clear understanding of the water regime and the rainfall in that area.

Figure 9.5 Unprotected Gap - NOT RECOMMENDED

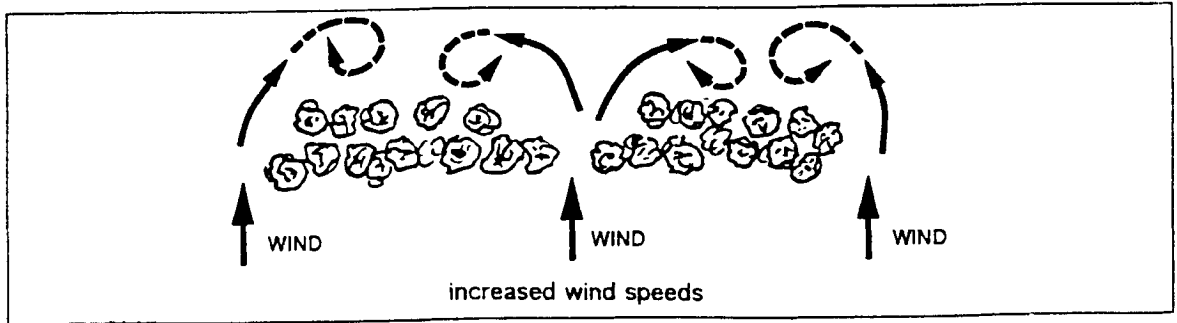

Figure 9.6 Staggered Gaps – RECOMMENDED

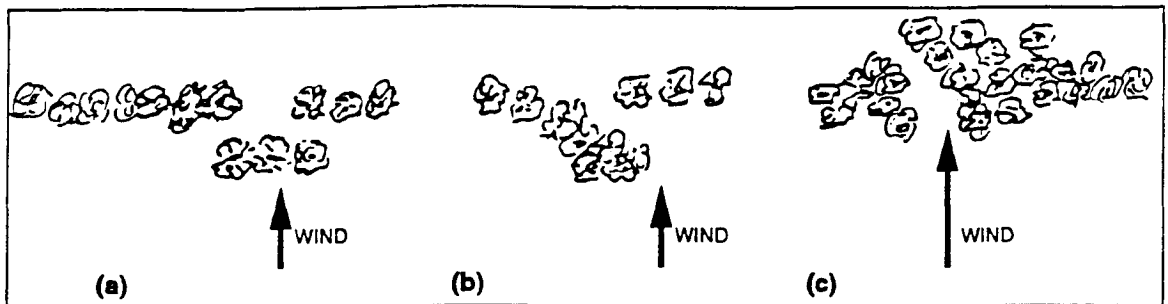

Table 9.2. Various Water Pollutants

Acids
Base metals (Heavy Metals)
Combination of pollutants
Cyanides
Mercury
Nitrogen
Oils
Organic reagents
Others- (Pesticides, Herbicides, Paints, Solvents & PCBs)
Suspended solids
Thiosulphate

Factors influencing runoff include:

- The intensity of the rainfall
- Size of the area of disturbance
- Size of the water catchment area
- Slope of the landscape
- Soil characteristics
- Land use at the time

Also important are the profile of the channels, whether man-made or natural, such as the inclination of the channel, its length and the cross-section.

The rehabilitation of a mine site or a dam site, either prior to failure or subsequent to failure, if properly planned, can manage all of these variables, except the intensity or the frequency of the rainfall.

There are four broad areas in which good management of these variables can be carried out. These are:

- Minimising the area of disturbance
- Managing the entry of water or run-off to the site
- Encouraging infiltration

- Managing the water leaving site so that damage will not be repeated downstream

9.3.2 Minimising Negative Impact

The following are guidelines that will assist in minimising the possibility of the negative impact at the site.

Site Plans

Regardless of whether the rehabilitation is the sequence to a mining operation or after an emergency has occurred and has been contained, a plan for the site restoration should be drawn up and carefully followed. Very often if this is not done, patchwork solutions commonly tend to create other hazards or disasters in the future. If changes are to be made, they should be made in the context of the whole plan.

Surveying

Once the site plan has been identified the area should be carefully surveyed. All construction and engineering structures must be compatible to the landscape and the ecosystem in which they are being constructed. The surveyor has a critical task as any errors in the survey may result in serious impacts.

Equipment Operators

It is very important to ensure the equipment operators understand the survey markings and that they do not exceed the limit of the work site at any time. The disturbance of survey markers can cause local problems and can affect the construction or rehabilitation.

Supervision

Close supervision of the operation should be carried out at all times. This should not be delegated to a junior staff member.

Penalties

Implement penalty clauses in agreements with contractors and employees who do not follow directions. As mentioned before haphazard work can jeopardise the site in the future.

Equipment

Ensure that the correct equipment is used to carry out the tasks. Use of both too heavy or too light equipment can have a detrimental effect and delay the completion of the work on the site.

9.3.3 Managing the Water on the Site

The location of all structures on the site should be laid out in the site plan so that rehabilitation can take place in an orderly manner. The construction of diversion channels and dams will effectively limit the entry of water to the site. Of note is the fact that these structures may be necessary prior to the major work on the site whether there has been a failure or whether it represents a potential hazard. It is as important to ensure that the diversion channels and dams, even though they may be temporary, must also be stable structures. The use of temporary materials is discussed in a later part of this chapter. When designing the water plan within the site, it is necessary to ensure that even though the soil erosion on the site may be decreased, poorly designed exits from the site can create major problems off site at the discharge points by causing erosion at those locations.

When there is a need to plan water diversion structures, the following should be taken into consideration.

Design Procedures

All the structures need to be designed to accommodate anticipated peak flows which would include a regional flood or probable maximum flood. It is essential to obtain the most up-to-date information and obtain the best assistance when designing permanent or temporary major structures, in particular where a breach or failure could cause a major or a minor safety hazard. It is essential that the computation of a design flood be undertaken by a professional engineer experienced in hydrology. Table 9.3 provides some guidelines for the construction of dams.

Where failure will not endanger life and will not cause significant economic or environmental damage, the structure may be designed according to standard engineering practices, that is the 100 Year Return Event.

When failure poses some degree of risk to public safety and may result in significant economic or environmental impact, the structure should be designed for greater return period events, such as 200 years.

If the failure may result in the loss of life or cause catastrophic environmental damage, the structure may have to be designed to withstand the Probable Maximum Event, or to provide for extreme return interval events such as 2 000 years plus.

The dams being discussed in this section are embankment dams. The fact that a 2000 year embankment dam is being considered is not unreasonable as there are Roman Dams which were constructed 1800 years ago which are still in place. As an example one such structure in Spain still provides water supply for Maretta.

Table 9.3 Minimum Design Inflow Floods for Dams

HAZARD POTENTIAL	SIZE		SIZE		SIZE	
	SMALL		INTERMEDIATE		LARGE	
	Height	Storage	Height	Storage	Height	Storage
	<7.5 m	<100 000 MI	7.5-15.0 m	100 000-1 000 000 MI	>15 m	>1 000 000 MI
Damage to Dam Only	25 to 50 year return		50 to 100 year return		100 to RF	
LOW						
<ul style="list-style-type: none"> Loss of life: None Property damage: Minimal to agriculture, other dams or structures not for human habitation. None to residential commercial, industrial or land to be developed within 20 years 	25 to 50 years return		100 to RF		RF to PMF	
SIGNIFICANT						
<ul style="list-style-type: none"> Loss of life: None expected Property damage: Minimal to agriculture operations, other dams or residential, commercial industrial or land to be developed within 20 years 	100 to RF		RF to PMF		PMF	
HIGH						
<ul style="list-style-type: none"> Loss of life: One or more Property damage: Extensive to agricultural operations, other dams or residential, commercial, or industrial development 	RF to PMF		PMF		PMF	

Ontario Ministry of Labour, 1982 Legend: 25 - 25 year return period flood
 RF - regional flood
 PMF - probable maximum flood

The choice of the design event or design flood depends on the size of the structure and the consequences of its failure. The design flood for a dam spillway or for a dam is determined on the basis of three principle factors:

- Dam height
- Dam storage capacity
- Hazard rating

Information needed to design properly major erosion control structures should include:

- Rainfall frequency and duration curves
- Catchment area size
- The runoff coefficient

A storm return period will need to be determined as part of the design criteria and should be done by a professional engineer.

The importance of good dam design, particularly when averting a hazard or repairing failed structures, is well illustrated in Smith's Book on the History of Dams by a code established by King Hammurabi in 1800 BC He stated, « If anyone is too lazy to keep his dam in proper condition and does not keep it so, if then the dam breaks and all the fields are flooded, then shall he in whose dam the break occurred, be sold for money and the money shall replace the corn which he has caused to ruin ».

Diversion Structures

In the construction of diversion structures to retain or divert runoff, contours should be graded to a moderate or gentle slope. The inclination of these slopes, for example, should be approximately 8 degrees, but would be dependent on the nature of the material in which the structure is formed. These structures should be designed to avoid scouring and erosion within the channel, otherwise they would deteriorate rapidly causing impact in other areas as well as on the site.

Morphology of Ditches or Waterways

The cross sections of the ditches and waterways should have gentle slopes and should ideally be parabolic in cross-section. Steep sided rectangular shaped cross sections should not be constructed as these can easily collapse by undercutting and thus disrupt the flow of water.

The slope of the ditch or channel should be constructed to ensure flow velocities which will not scour the channel. The slope of the longitudinal profile will be dependent on the nature of the soil on which the structure is being constructed. As a guide the maximum safety, a velocity of approximately 0.5 meters per second in easily eroded soils should be followed increasing to 1.0 meters per second for more erosion resistance soils. Where the channel has been grassed or covered by other vegetation these velocities can be doubled. Where flow velocities cannot be reduced to safe levels the channels should be protected by erosion resistant materials.

Protective Materials

Protective materials should be selected to match the expected life of the structure. Suitable materials include: concrete; riprap; synthetic membrane; plastic and rubber sheeting such as old conveyor belts; jute; mesh; hay bales; sandbags; cement in bags; and timber. The Figures 9.7 and 9.8 illustrate two methods of lining. Figure 9.7 gives a good example of the use of old conveyor belts to line a ditch. An old conveyor belt can also be used to divert water off the top of a tailings dump and avoid gullying. Figure 9.8 shows examples of using mesh which is placed or seeded and fertilised top soil, thus forming a protective permanent grass covered ditch. This type of ditch, however, must be considered with a certain amount of caution as when the grass grows it may tend to clog the ditch and therefore no longer serve as an effective channel.

In all cases when installing lining materials care should be taken not to undermine the material. Ensure there is continuous contact with the soil beneath the lining material.

Control structures should be located so that the runoff or water flow is easily diverted. The channel gradients should not be excessive and the need for protective measures within the channel or drain are minimised. Techniques for the discharge of water from small or temporary retention structures can be controlled using the methods shown in Figures 9.7 and 9.8.

When a safe discharge point is difficult to establish, the construction of either a wooden or plastic flume could be used to discharge the water to a protected drainage area or water body. Examples of structures that might be used are illustrated in Figures 9.9 and 9.10. Figure 9.9 shows use of a flexible plastic flume and Figure 9.10 shows discharge into protected drain or water course by means of corrugated metal or plastic pipe. These temporary structures should under no circumstances be left in place beyond their projected life, as they were designed and built as temporary structures and would deteriorate in a very short period of time.

In order to dissipate the energy of water flow and the control of water for temporary structures, materials such as hay bales can be used. For a short period of time, bales of hay, properly anchored and secured, have been found to work well for periods of from six to twelve months. This is illustrated in Figure 9.11 and Figure 9.12.

For heavier duty, temporary structures may be constructed of bags of sand or bags of cement which after placement solidify and may become semi-permanent structures. For these structures, because of their longer life span, sediment control features must also be built into the dam. The duration of these types of structures have been found to be successful for from one to five years. This technique is illustrated in Figure 9.13 and Figure 9.14.

For permanent structures, concrete buttresses, groynes, gabion baskets and armour stone are some of the materials used. Leakage from a dam may in itself not be critical, but consequent instability of the dam wall through percolation may result in failure. This will be further treated under Chapter 13, Slope Stability.

Figure 9.7 Example of the Use of Old Conveyor Belt to Line a Ditch

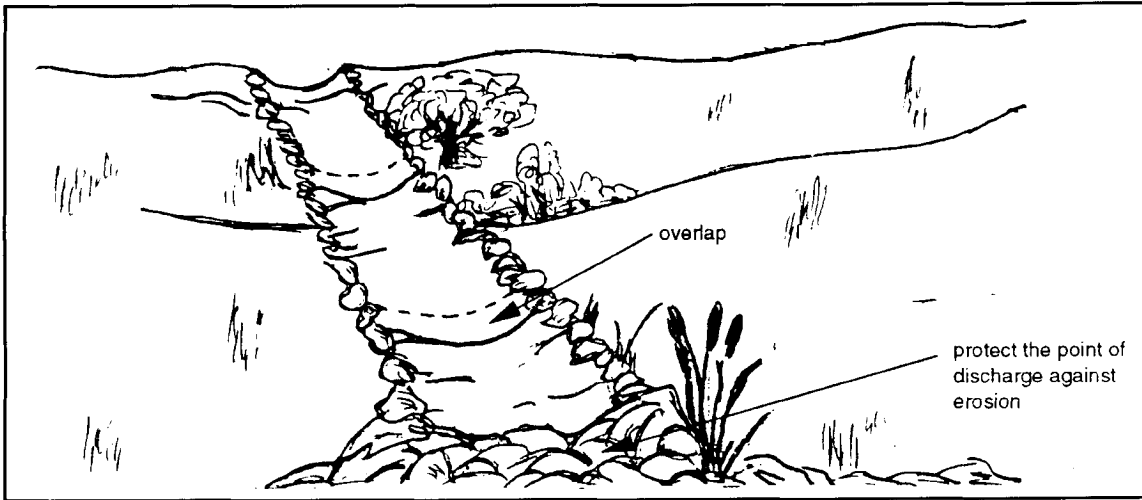

Figure 9.8 Use of Flexible Plastic Flume

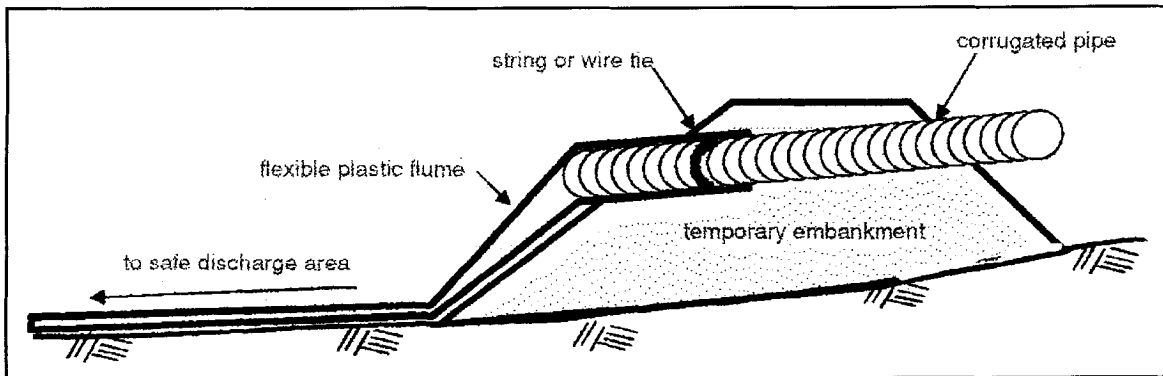

Figure 9.9 Discharge into Protected Drain or Watercourse (cross-section)

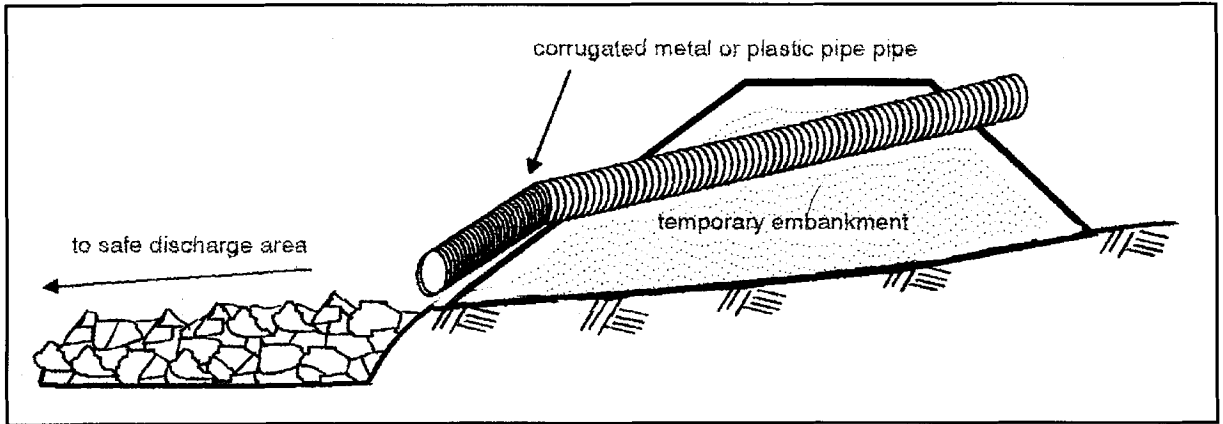

Figure 9.10 Discharge into Protected Drain or Watercourse (perspective view)

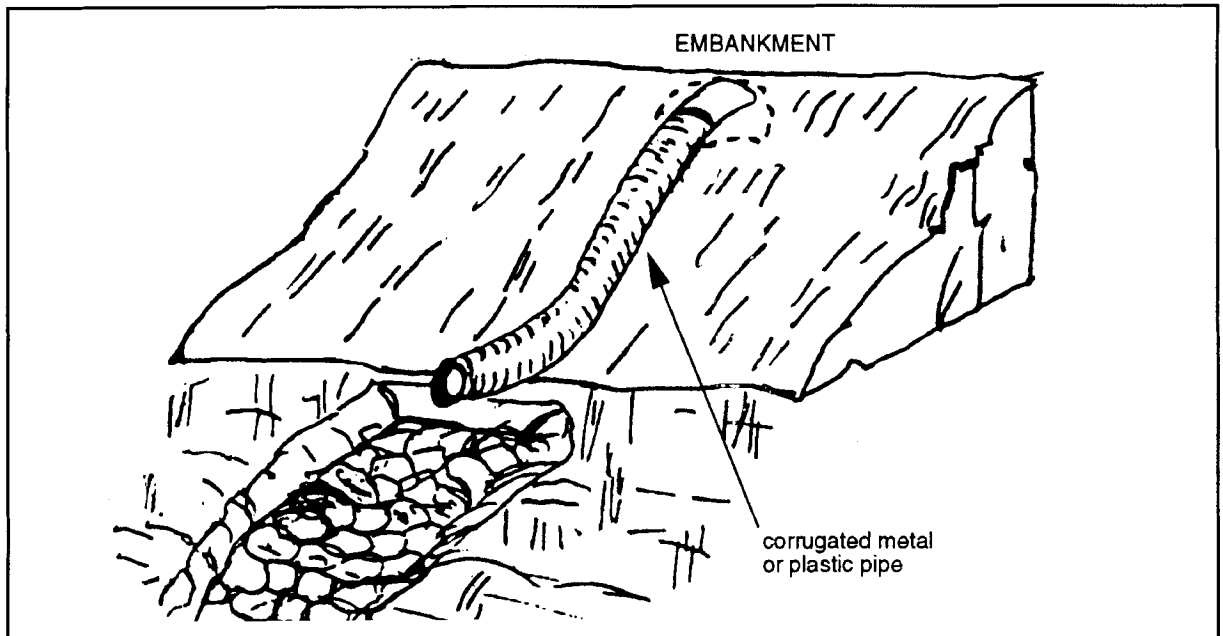

Figure 9.11 + 9.12 The Use of Hay Bales for Temporary Control

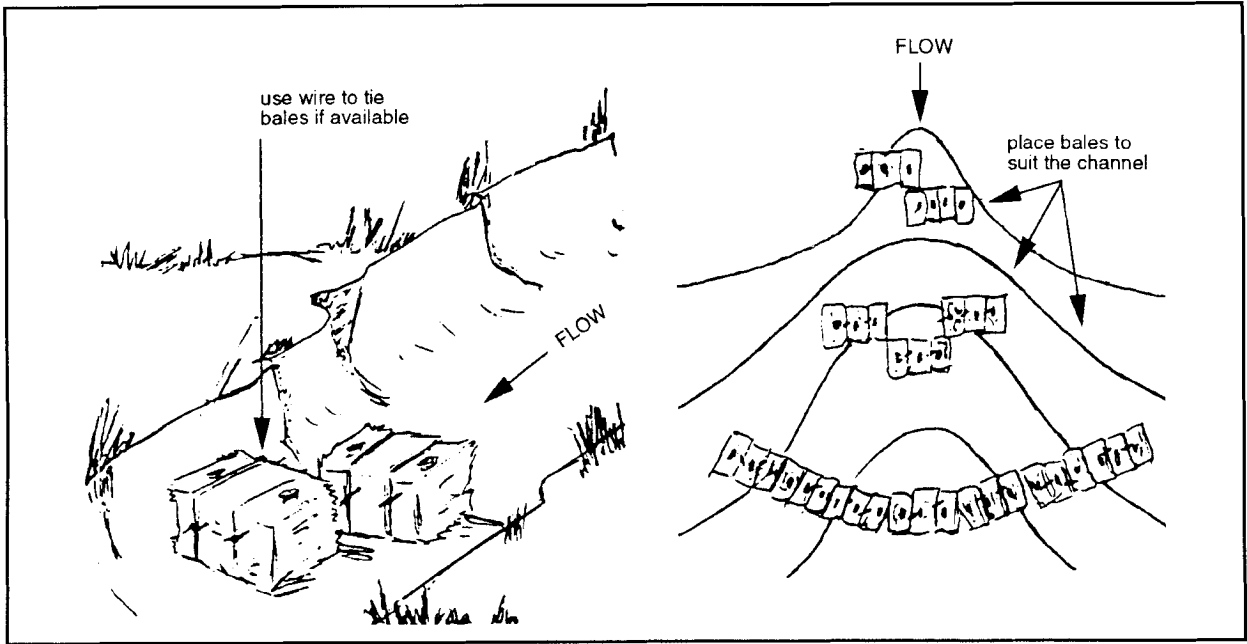

Figure 9.13 The Use of a "Sand Bag" as a Control Structure (plan view)

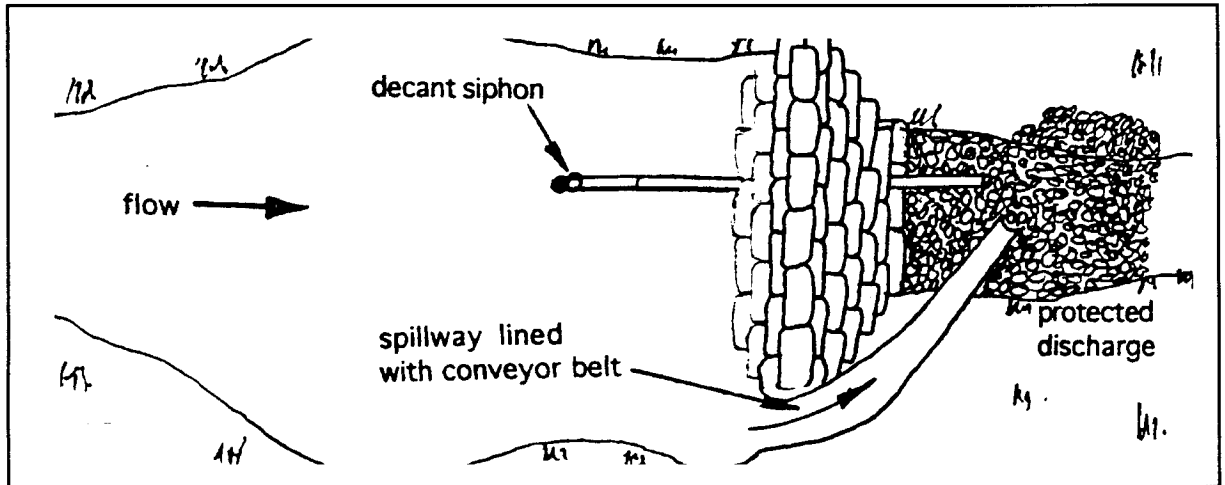
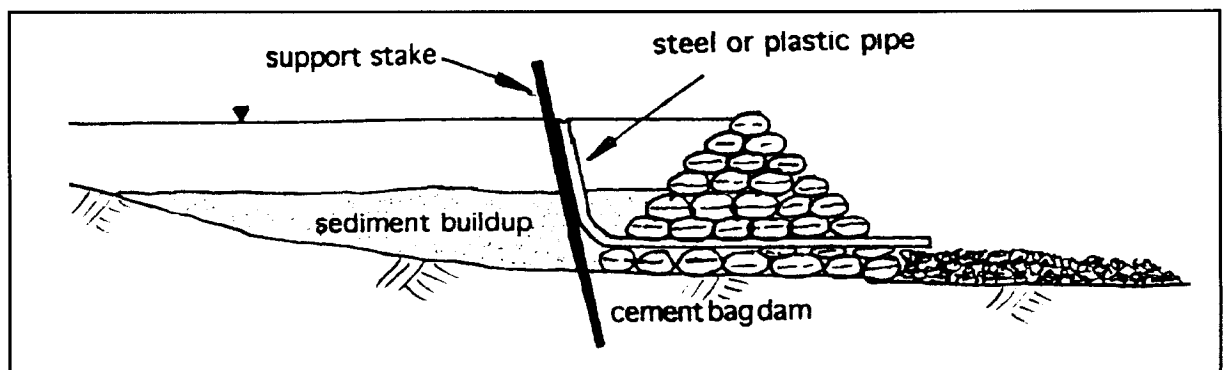

Figure 9.14 The Use of a "Sand Bag" as a Control Structure (cross-section)



A further technique to dissipate the energy from run-off is to retain vegetation buffer strips and if necessary install small barriers within the strips to collect sediment. This method is most appropriate where there is no well defined channel coming from the disturbed area. The ultimate out-flow is along a drainage ditch. Figure 9.15 illustrates this technique.

9.3.4 Managing the Water that Leaves the Site

Managed water whether diverted or leaving the site usually has an increase in rate of flow. Water leaving the site and entering the natural environment should therefore be monitored and controlled so as to avoid carrying an excessive sediment load. The water may also contain pollutants and may therefore contaminate the adjacent areas.

In managing the water both on site and leaving the site, the following considerations are of importance:

Approval

The diversion of water and the quality of the water leaving a mine site and entering the natural environment usually requires specific approval in most jurisdictions. Make sure that this approval is obtained before constructing diversionary structures or exit structures.

Sediment

To control the sediment in the water, dams are most commonly used to retain the sediment from the run-off.

In arid or semi-arid areas the sediment level in dams often builds very rapidly. This is because of the high intensity infrequent cycles of rainfall on areas that are usually poorly vegetated and susceptible to erosion. The dams and the spillways must therefore be designed to meet the majority of these events, otherwise there will be failure and possibly serious damage.

Once the sediment level reaches half the depth of the structure, the overall capacity is radically reduced and should be removed by dragline, back-hoe or scraper. Figure 9.16 illustrates the problem and Figure 9.17 illustrates the solution using a scraper.

Dam Discharge

An integral part of dam design and function is the design of the spillway and/or outlet pipes. In a settling dam the sediment free water will need to be discharged allowing capacity for subsequent flow. The draining of the clear water can be carried out either by a properly engineered spillway or by siphoning. In the case of siphoning, care must be taken in the placing of the siphon, as, if the sediment is to be removed mechanically, the siphon as a permanent structure that cannot be moved, and can easily be damaged. Even with the presence of a siphon in the dam, an appropriate, well engineered spillway should be constructed.

Figure 9.15 For Flow Control Retain Vegetated Buffer Strips

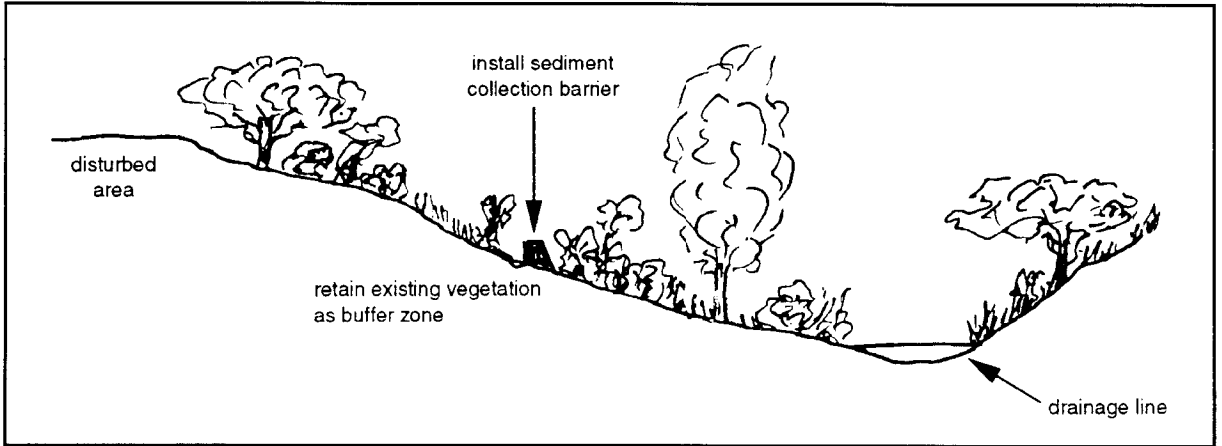

Figure 9.16 Settlement Dam with Siphon and Spillway with Sediment

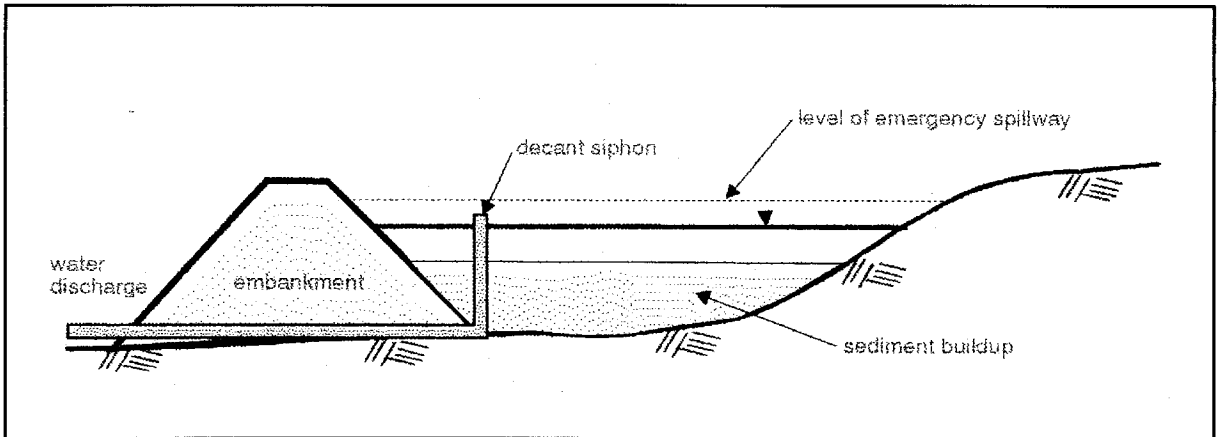
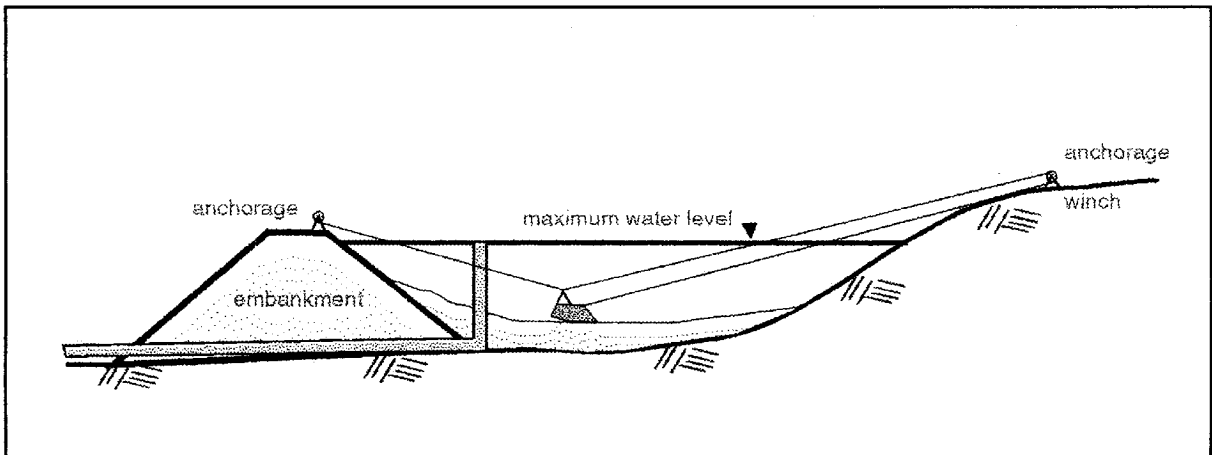

Figure 9.17 Sediment Being Removed by Scraper (Slusher)



In the overall design of the dam and the water discharge points, care must be taken to ensure that the energy generated by the outflow is safely dissipated.

Techniques to dissipate the energy include the construction of baffles, groynes and the placement of armour stone. These are permanent structures which are comprised of concrete, heavy gabion baskets of stone and large blocks of rock. Another technique to dissipate the energy of the discharge flow is to discharge into a suitably large body of water which has the capacity to absorb the discharge.

9.4 EXERCISES

EROSION (WIND)

1. What three methods are commonly used to control wind erosion on disturbed soils?
2. Give two examples of methods used to control wind erosion.
3. What is a Rose Diagram used for?
4. In establishing windbreaks, there are three factors, apart from wind direction, that have to be addressed. What are they and give sketches showing their use and where appropriate?

EROSION (WATER)

1. What factors influence run off?
2. What broad areas can the factors in Q-1 be managed?
3. In order to minimise further negative impact, what guidelines should be followed? What is the significance of each?
4. What are the principal factors in the design flood for a dam, and who should do it?
5. What is meant by the statement “a 100 year return event”?
6. What is meant by “Hazard Potential”? Give examples.
7. What information is needed to properly design major erosion control structures?

EROSION (PHYSICAL WATER MANAGEMENT)

1. What features should you design into diversion structures?
2. Give two economical examples of lining that can be used in ditches?

3. In dissipating energy,
 - (a) What materials can be used for small temporary structures?
 - (b) What materials can be used for large permanent structures?
 - (c) Give two examples of designs for dissipating energy.
4. (a) Sketch a cross-section of a settling dam showing all of its necessary features?
 - (b) At what point does the capacity of a settling dam diminish rapidly?

GENERAL

1. How does the monitoring programme contribute to erosion control?
2. How does mine planning contribute to erosion control?
3. Who is responsible for managing erosion control?
4. What facilities and services does a company need to have to provide effective erosion control?
5. How would you judge the success of an erosion control programme?
6. Which government agencies are interested in and able to provide advice on erosion control measures?
7. What role can the community play in helping to protect land from erosion?
8. Identify national publications dealing with erosion control in your country.

Further exercises to be developed by the trainer.

Chapter 10

Landscaping

10.1 INTRODUCTION

Rehabilitation is the reshaping and regrading of a site and to form it into a useful and acceptable landscape. The aesthetic aspects of the site are of third importance after safety and environmental impact. The stability of the site is paramount from the standpoint of safety and for the subsequent topsoiling and revegetation. If the site is constructed properly it not only contributes to the ease of its formation but also to the ease of subsequent maintenance.

10.2 PLANNING

When planning the final configuration of the landscape, the following are important:

- The future land use must be established
- The final landscape must be stable. In order to ensure this the erosion potential of the material on site has to be assessed. A geotechnical engineer's report may be required for this. Both steep and long slopes allow surface run-off to accelerate which commonly results in severe erosion. Gentle slopes, however, are less prone to erosion and vegetation can much more easily be established.
- The natural slopes in the area, which have evolved as a result of natural erosion processes, should therefore be studied and used as a guideline to determine the inclination of the constructed slopes.
- The size of the area to be rehabilitated.
- The drainage pattern for the specific site must be planned as part of the overall surface water regime. The drainage density of adjacent land areas are the main guide to the site requirements.
- The climatic conditions must be taken into consideration.
- The availability of material (topsoil and fill).
- The availability of the appropriate vegetation.
- Slopes should be designed to reduce the velocity of the run-off as the catchment area of the slope increases. Where the area of the site limits formation of a stable slope profile, contoured benches or similar erosion control methods may be required. Slopes with an overall convex profile should always be avoided. Figure 10.1 illustrates the configuration of the development of an ideal slope profile.

Figure 10.1. Ideal Slope Profile

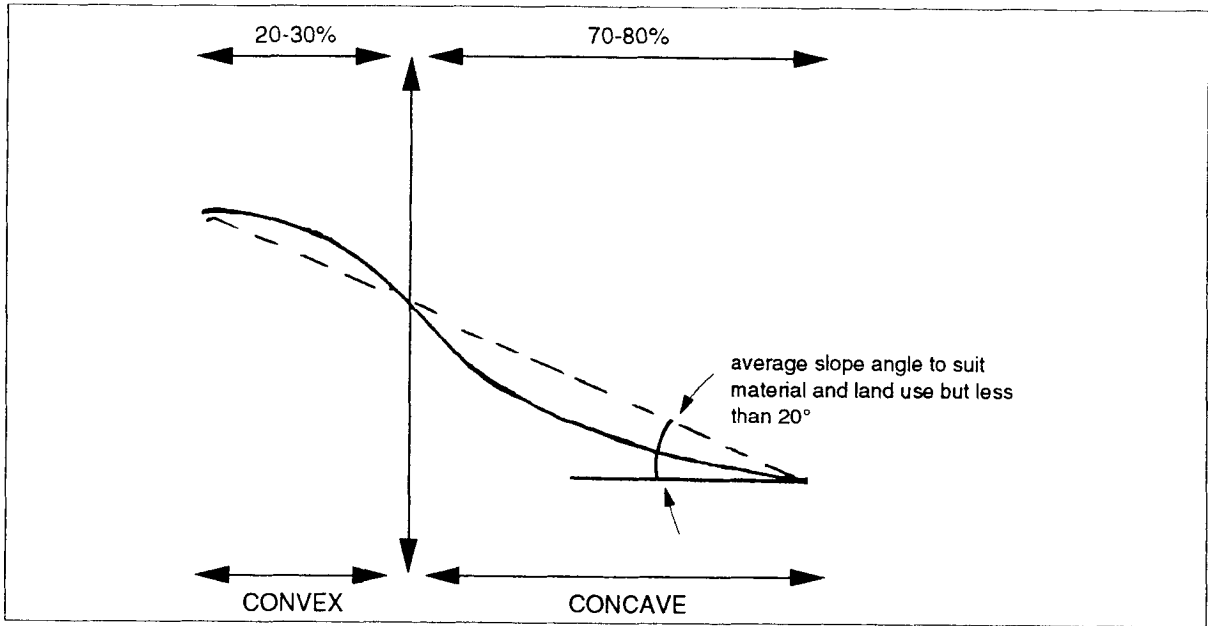

- Benches are best located in the middle of the slope. Where long slopes cannot be avoided several benches may be required. In such cases the slope and run-off characteristics must be considered. Table 10.1 provides a guide for maximum spacing between benches along a slope.

Table 10.1 Spacing Between Benches

SLOPE (degrees)	SPACING (metres)
7	0
7-9	100
9-11	80
11-13	60
13-14	40
17-21	30

- The site must be surveyed so as to maintain the contours. Where banks are graded to direct run-off to specific draw points be sure to ensure that run-off is dissipated or properly controlled. This was treated further under “water erosion” in Chapter 9.
- Open-cast mines with large volumes of overburden will normally require a drainage density that is higher than that which existed prior to the mining operation. To compensate for the increase in the gradient of the slopes, resulting from the removal of the material, the best approach is to design catchment areas that are relatively small and should not exceed 1 to 2 hectares if possible. This is also true for an area which has lost much material as a result of failure.
- If mining or a failure has resulted in an increased catchment area for an existing drainage basin that leads away from the site, additional downstream erosion control structures may be required or existing structures may need to be upgraded.

10.3 TECHNICAL GUIDELINES

- Topsoil will commonly not adhere to slopes that are steeper than 27 degrees. A conversion between degrees, percent and slope measure for gradient measurements is given in Figure 10.2.

- The maximum slope for mechanically spreading top soil is approximately 19 degrees.
- The maximum slopes considered suitable for land use are given in Table 10.2.

Table 10.2 Maximum Slopes for Land Use

LAND USE	SLOPE (degrees)
Forestry	38
Grazing	28
Pasture	15
Buildings & roads	12
cropping	Rotation 5
Housing	3

- Depending on the characteristics of the site, such as the geology, the nature of the soils and other site specific topographic features, more gentle slopes may be necessary.
- When using earth moving equipment on slopes the following are good guidelines:
 - Contour ripping is safe on slopes of up to 27 degrees.
 - Large bulldozers can usually push earth material up-slope on slopes of up to 22 degrees.
 - Agricultural machinery can be used on slopes up to 19 degrees.
- When contouring always rip and scarify precisely along the contour. This prevents inadvertently creating down slope channels.
- The contour line should be surveyed and marked by posts, if necessary.

Figure 10.2. Grade Comparisons and Conversion Chart

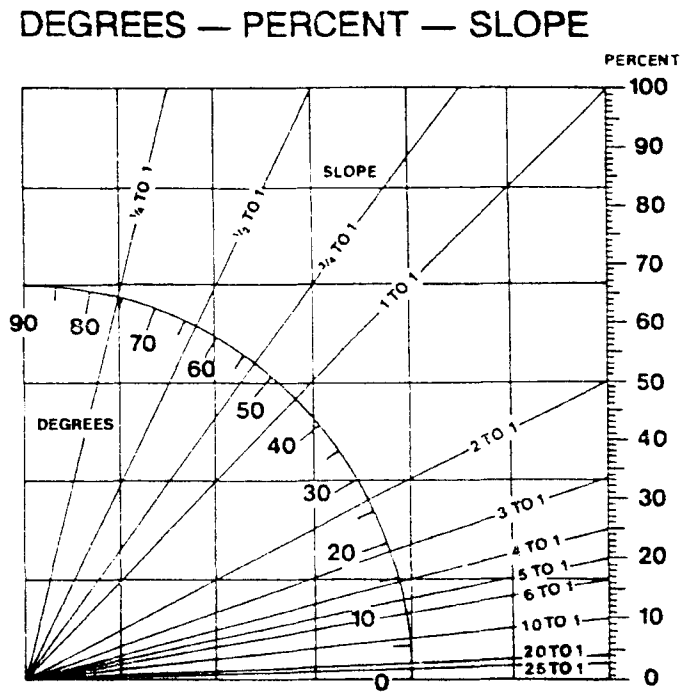

- The ripping should normally be as deep as is possible depending on the material, the equipment that is available and the sub-surface conditions. A ripping depth of 0.8 to 1.8 metres is a good guide. However, some subsoil conditions (e.g. where boulders are present) may not permit ripping to these depths.
- The spacing of the lines when ripping or scarifying should be such that they overlap one another.
- When soil conditions are wet, soil will not break up so avoid ripping and scarifying under wet conditions.

10.4 EXERCISES

1. What are the important criteria in planning the final configuration of the landscape?
2. What is the maximum slope for mechanically spreading topsoil?
3. When using earth moving equipment on slopes, what good guidelines should you use?
4. Give four examples of maximum slopes for land use.
5. Who should decide what is “useful and acceptable landscape”? What are the different roles of the government, the company and the community?
6. To what extent should final landscaping be addressed in mine planning?
7. Where should landscaping be included in the EIA process?
8. Are landscaping considerations important in the operation stage, or only at mine closure? Give reasons for your answer.
9. Compare the landscaping considerations for open pit rehabilitation with those for an overburden dump.
10. Discuss the landscaping considerations associated with various types of final land uses.

Further exercises to be developed by the trainer.

References

For further reading on this subject, the following texts are suggested. Additional references are to be found in Part IV.

Environment Australia, 1998. *Landform Design for Rehabilitation*. Part of the Best Practice Environmental Management in Mining series.

Peters, T.H., 1984. *Rehabilitation of Mine Tailings: A Case of Complete Ecosystem Reconstruction and Revegetation of Industrially Stressed Lands in the Sudbury Area, Ontario, Canada*.

Chapter 11

Topsoil Management

11.1 INTRODUCTION

Although vegetation can grow on various subsoils, topsoil is always essential in successful rehabilitation programmes, especially during the initial period of plant growth. Topsoil, contains nutrients and micro-organisms that are essential to plant growth and if they are lost then a sustainable vegetative cover will take a longer period to establish.

The subsoil conditions are of more importance in the long term in revegetation. If the subsoil lacks the nutrients or is unsuitable for long term growth the initial vegetation will die off in periods of from one to five years depending on the rate of penetration of the roots.

During the planning for re-vegetation in a rehabilitation programme, the following issues should be taken into consideration.

11.2 NATURE OF TOPSOIL

The term “topsoil” refers to the “A” horizon of the soil. It is usually darker than the underlying soil because of an accumulation of organic material. It usually represents the top 10 to 30 centimetres of soil and should be removed and stored before any development takes place. The most efficient method of soil removal is to double strip the topsoil. That is, to remove the top 10 to 15 centimetres of soil which contains the majority of seeds, nutrients and micro-organisms and store in a separate pile. Then remove the remaining topsoil to as much as 30 centimetres and store it elsewhere. These measurements are simply guidelines for soils in arid to semi-arid climates, as usually soils and subsoils are not thick in these environments. However, the technique of double stripping remains valid in all soils in any climate.

Care should be taken not to store topsoil for too long a period, as the biological components in the soil deteriorate very rapidly. The most satisfactory programme is if recovered (or imported) topsoil can be placed in an area awaiting rehabilitation quickly (i.e. within 12 months).

11.3 STOCKPILING OF TOPSOIL

It is best to reuse topsoil as soon as it has been removed, though it may sometimes be necessary to stockpile it. If the stockpiling of topsoil cannot be avoided then the following guidelines should be followed.

11.3.1 Reuse of Topsoil

Plan to reuse the topsoil as soon as is possible. As mentioned previously, the biological components will deteriorate over long periods of storage.

11.3.2 Manner of Storage

Do not store in large piles, store in low heaps no more than one to two meters high to best retain the organic components in good condition.

11.3.3 Revegetation of Stockpiles

Revegetate the stockpiles to protect the soil from erosion, to discourage weeds and to maintain the active populations of the beneficial micro-organisms. The use of legumes for this temporary vegetation is recommended as they will maintain the nitrogen content in the soil.

11.3.4 Locations of Stockpiles

The stockpiles should be located where they will not be disturbed by future mining activities or future development of buildings or infrastructure. Disturbing the topsoil can further damage the soil structure prior to final re-use.

11.3.5 Stripping of Soils

Soils should not be stripped when they are wet. This can lead to compaction and loss of the structure of the soil.

11.4 THE PLACING OF TOPSOIL

Before placing or respreading topsoil two factors must be considered:

- First, that the locations for the spreading of the available topsoil are compatible with the available topsoil.
- Second, that there is sufficient topsoil to complete the planned task.

The appropriate thickness of topsoil placed will depend on the site. From 0.2 to 0.3 metres of replacement soil is best where the underlying overburden material is not toxic to plant growth. If incompatible conditions exist, the depth of the overlay of topsoil may need to be increased and other measures taken to isolate offending material. This is treated in future sections in the discussion on toxicants.

11.4.1 Supplies of Topsoil

Where there are only limited supplies of topsoil the following should be considered. This is another reason why every task must first be properly planned.

Strip Placement

Topsoil and the vegetation should be laid in strips alternating with areas on which there has been no placement of topsoil. This will increase the coverage.

Other Supplies

With limited supplies of topsoil, an underlying layer of subsoil will commonly produce better results than a thin layer of topsoil alone. This will serve to “stretch” the supply of topsoil. Also, in the application of topsoil, even if there is very little available, the smallest quantities will commonly introduce essential micro-organisms and seeds into the growth region.

Borrow Topsoil

Stripping other areas, not yet scheduled for mining, may in some cases be justified. This is generally not recommended since rehabilitation of the borrow area must ultimately also be carried out. However, stripping topsoil in the advance of waste piles or tailings dams will provide a source of borrow material.

Import Topsoil

Importing topsoil from other sources of topsoil. In most cases this is not an economical method but may be necessary under some circumstances. In importing topsoil from other areas, undesirable weed species may be included in the soil and care must therefore be taken. In some areas fast growing weeds have been found to be useful, to bind soil to the rehabilitated slope. However, there must be a means to eradicate them subsequently to allow longer term establishment of a mixed vegetation ecosystem.

11.5 INAPPROPRIATE PLACEMENT OF TOPSOIL

As a general rule, it is recommended to avoid placing subsoil or topsoil near a surface which contains the following constituents:

11.5.1 Excessively Sandy Soils

That is, soils that have a sand or gravel content of 70% or more. However, where soils are excessively clayey, melding or mixing granular material with the clay material can produce an acceptable subsoil.

11.5.2 Extremes of pH

If material has a pH of less than 5 or a pH of more than 8.5, avoid or pretreat these areas.

11.5.3 Saline Soils

The material should not have a chloride content of 3% or more. If the soils contain more they should be treated in another manner prior to the laying of subsoil.

In the management of topsoil and species selection, it is sensible to seek the advice of professionals on the taking of soil samples and in the selection of suitable soil-testing techniques. There are standard procedures for many soil tests, and many government soil conservation or agricultural departments are often able to carry out routinely these tests. If using a private laboratory always ensure that the method of analysis is given with the results so that cross-checking can be carried out if necessary.

This section is devoted to the physical management of topsoil; the textural, chemical and biological management are treated in the chapter on Amelioration and Vegetation.

11.6 EXERCISES

1. How should topsoil be stripped, and why?
2. How would you manage stockpiles of topsoil?
3. Give three examples of inappropriate sites to place topsoil.
4. Who should make decisions on topsoil management?
5. How do topsoil conditions affect mine planning and operation?
6. What government expertise is available in your country?
7. What further treatment of topsoil is required to improve it?

Further exercises to be developed by the trainer.

References

For further reading on this subject, the following texts are suggested. Additional references are to be found in Part IV.

Australian Environment Protection Agency, 1995. Rehabilitation and Revegetation. Part of the Best Practice Environmental Management in Mining series.

McGinnes, S., Smith, K.V.L. and Atkinson, K., 1995. Stability of Industrial Mineral Soil Amendments Subject to Biological Degradation. Proceedings of Sudbury '95 - Mining and the Environment, Volume 3, Sudbury, Ontario, Canada.

Peters, T.H., 1984. Rehabilitation of Mine Tailings: A Case of Complete Ecosystem Reconstruction and Revegetation of Industrially Stressed Lands in the Sudbury Area, Ontario, Canada.

Sheehan, P.J., Miller, D.R., Butler, G.C. and Bordeau, P. (Ed) Affects of Pollutants on the Ecosystem Level. Wiley, New York, USA.

Wild, A. (Ed), 1988. Russel's Soil Conditions and Plant Growth, 11th Edition. Longman Scientific and Technical, Harlow, England.

Chapter 11

Topsoil Management

Prepared slides for overhead projection

Topsoil Management

- **Nature of topsoil**
- **Stockpiling of topsoil**
- **Placing of topsoil**
- **Inappropriate placement of topsoil**

Chapter 12

Amelioration and Vegetation

12.1 INTRODUCTION

The best cover for tailings and waste disposal sites, if possible, is a self-sustaining vegetative cover. Due to the high probability of the presence of contaminants, most tailings will require either physical changes or chemical changes or both in order to sustain a satisfactory plant growth.

Successful revegetation is dependent on well planned, competent site preparation. This normally requires a number of steps which have been discussed at some length in the chapters on Landscaping, on Erosion Control and on Topsoil Management. Some methods used to assist in developing a compatible environment for the establishment of vegetation are presented. Again, these represent examples and do not cover the full spectrum of techniques or methods available.

12.2 ASSESSMENT OF SOIL CONDITIONS

The rehabilitation of mine sites are always more successful if plant species which are indigenous to the site are selected rather than introducing exotic species which require major soil amendments. However, this may not always be possible on all tailings area due to their granular soil texture or chemical content. Consequently, tailings are often more difficult to revegetate. Therefore, it is necessary to assess carefully the soil conditions, to determine their physical and chemical deficiencies, so that the appropriate amendments and fertilisers may be applied.

12.2.1 Texture

Texture is the physical characteristic of the soil. It describes the content of sand, silt and clay-sized grains in the soil. The texture of the soil dictates the porosity and permeability of the soil which determines the retention and penetration of moisture, nutrients and the roots of plants.

A soil with predominantly sand has poor bonding, is susceptible to wind and water erosion, and does not easily retain moisture and plant nutrients.

Silty soils are finer grained, bond better and retain moisture and nutrients better than sand. However, when dry they are more susceptible to wind erosion because of their finer grain size.

Clay soils are very fine grained and easily compacted. When too fine grained, they have very low porosity and permeability. It is therefore not usually a good medium as a soil. According to Gartner Lee, the optimum mix for vegetation should be a soil with 20 to 30 percent clay, 30 percent sand and 40 to 50 percent silt.

Figure 12.1. Soil Texture Field Test**Moist Case Test**

Moist soil (may be dampened if necessary) is compressed in the clenched hand. The cast is then lightly tossed from hand to hand to assess its binding strength.

No cast	Sand
Weak cast (allows careful handling)	Silt
Strong cast	Clay

Ribbon Test

Moist soil is kneaded with the fingers and rolled into a cigarette shape. The soil is then squeezed out between the thumb and forefinger to form the longest, thinnest ribbon possible.

Unable to ribbon	Sand
Flakes instead of ribbons	Silt
Forms a long, thin ribbon	Clay

Feel Test

The soil is rubbed between the thumb and forefinger to gain a feel for its coarseness/fineness. The soil is then rubbed in the palm of the hand to dry it, and to separate and estimate the amount of individual sand particles. The sand particles are then allowed to fall off the hand and the amount of finer material remaining (silt and clay) is noted. Sand has a grainy feel; silt feels floury, while clay feels very smooth.

Grainy with no floury material	Sand
Very floury	Silt
Smooth	Clay

Shine Test

A small amount of slightly damp soil is rolled into a ball and rubbed once or twice against a knife blade or fingernail.

Unable to form ball	Sand
Able to form ball carefully (dull shine)	Silt
Very Shiny	Clay

After Garner Lee (1991)

A simple field test developed by Gartner Lee to determine the texture of the soil is outlined in Figure 12.1.

The addition of gypsum can also greatly improve the texture of the soil by reducing the crusting in hard setting soils. When gypsum is added, sodium ions replace calcium ions, which have the effect of improving the soil structure and texture, increase water infiltration and aeration.

The addition of gypsum can also reduce soil salinity by leaching.

Application rates when using gypsum as a soil ameliorant may range from 2.5 - 5.0 tonnes/hectare for slightly affected soils to 20 tonnes/hectare for strongly affected soils.

12.2.2 Determination of pH

The acidity or alkalinity of the soils is measured by the pH. It is very important to know the pH of the soil, as this will dictate the amendments necessary to provide an environment for sustainable vegetative growth. Nutrients present in soils and the amendments may not be available to the vegetation if the pH is too high or too low. For example, above pH 8 phosphate can combine with calcium to form an insoluble compound unavailable to plants and below pH 5 aluminium and iron may also combine with phosphate to form an insoluble compound.

12.2.3 Fertilisers

Before considering the use of fertilisers, field data have to be determined. These are the physical condition of the tailings, the soil concentrations of contaminating plant toxins and the salinity of the tailings. If these levels are unsuitable, no matter how much fertiliser is applied, little plant growth will occur.

Soil analyses, soil amelioration and pH correction must be completed prior to the assessment of fertiliser treatments. From the economic standpoint, a good understanding of the soils, prior to the application of fertiliser is necessary. This is because large amounts of nitrate, phosphate and potash may be needed and fertilisation may not therefore be a viable alternative.

Secondary plant nutrients sulphur, calcium and magnesium, and trace elements such as iron, manganese, boron, zinc, copper, molybdenum and aluminium are necessary for healthy plant growth.

12.3 THE INCORPORATION OF ORGANIC MATERIALS AND MULCHES

Table 12.1 gives a list of mulches and their application rates. Such materials can include segregated sanitary landfill material, sewage sludge, organic mulches, garden refuse, crop and farm refuse and fly-ash. The addition of these materials can improve the soil texture and the structure of the tailings, and sub-surface aeration and moisture infiltration and retention properties are also increased. With the addition of organic material, micro-organisms and bacteria are introduced too.

Organic materials and some vegetation has been found, by experimental work in South Africa and Australia, to react with and take up some heavy ions from the soil. Thus, they assist in the reduction of the toxicity of the soil. Fresh organic material should not be directly laid until it has had sometime to deteriorate and begin to decompose. The reason for this is that it commonly will absorb what nitrogen is available thus releasing phenols which might adversely affect plant growth. Mulches will not only inhibit wind and water erosion, but will make a major contribution to the composition of the soil as it decays.

Another technique to incorporate organic materials is to plant fast growing cereals and grasses such as legumes, rye, oats and alfalfa and then plough them in each year after growth. This has the effect of increasing the organic content of the soil. Over several years this will contribute to the development of a more fertile soil. Fly-ash, clinker and similar materials have also been used effectively on tailings surfaces.

12.4 THE CORRECTION OF pH

The prevention and management of the generation of acid drainage is treated in Chapter 15. What is being discussed here is methods that can be used to develop a compatible soil for the growth of vegetation. It is important to be aware of the fact that there are a limited number of plants that will survive in a soil that has pH 4.5 or less. It is therefore far better to attempt to raise the pH of the soil to above 4.5 and thus enable the selection of many more species for revegetation.

The most cost effective method for raising the pH is by the use of lime. The acid to base condition of the tailings will determine the amount of lime required. However, as a guideline the following application rates can be used for treating acid soils with a pH of 4.0 or above. Table 12.2 shows the rate of application of CaCO_3 equivalent for varying pH ranges.

Hydrated lime is faster acting than agricultural lime and some of the crushed limestones. It has from 50% to 100% greater neutralising capacity than agricultural lime or crushed limestone. Smelter slag is sometimes an alternative but it is slower acting in neutralising the material. If smelter slag is easily available it may represent an economic advantage over the use of other materials.

Table 12.1. Common Mulch Application Rates

Mulch Type	Intended Use	
	Seed Cover	Plant Mulch
Straw (tonne/hectare)	0.6 - 0.8	1.5
Hay (t/ha)	0.8	1.5
Manure (t/ha)	4 - 6	16.5 - 24.5
Hardwood bark (m /ha)	14	149
Softwood bark (m /ha)	14	149
Hardwood chips (m /ha)	15.5	166
Softwood chips (m /ha)	15.5	166
Sawdust (m /ha)	58	255
Leaves (t/ha)	1	2
Solid waste (t/ha)	8	---
Sewage sludge (t/ha)	76	---
Wood-cellulose fibre (kg/ha)	275	---

After Slick and Curtis 1983

Table 12.2. Lime Application Rates

pH	Tonnes/Hectare CaCO ₃ equivalent
6.0 - 5.5	2 - 5
5.4 - 4.6	6 - 9
4.5 - 4.0	10 - 13

12.5 THE APPLICATION OF FERTILISERS

Requirements for fertilisers may vary widely according to the conditions of the soil, climate, topography and intended future land use.

In arid or semi-arid environments most indigenous species are adapted to lower nutrient levels. Therefore, although fertilisers enhance their growth, care must be taken that they are not over stimulated. In temperate or high rainfall environments there is still need for caution, however, not as great as in semi-arid and arid climates.

Fertiliser needs are given according to the three major nutrients which are nitrogen (N), phosphorus as an oxide (P_2O_5) and potassium as an oxide (K_2O) usually referred to as « N P K ». The amounts are expressed as a ratio according to weight, therefore 6% N, 6% P_2O_5 and 6% K_2O is expressed as 6:6:6.

In addition, in applying the fertiliser as granules, unless it is watered shortly after application, the fertiliser can burn and so destroy the vegetation. A further word of caution, the over application or extensive application of commercial fertilisers may cause water pollution problems, particularly where the soils are sandy.

Although the principal nutrients are nitrogen, phosphorous and potassium; sulphur, calcium and magnesium commonly occur with them. There is also a need for minor or trace elements in small quantities, these elements can be very toxic if applied too extensively, or if the pH is either too high or too low. Of the three major nutrients nitrogen is the most important to successful plant propagation. Table 12.3 shows a selection of nitrogen, phosphorus and potassium sources used in the fertilisers.

The most beneficial fertilisers are organic fertilisers which include sewage sludge, garden mulch, crop mulch, manure and wood chips. As previously mentioned, in the use of freshly derived wood chips or vegetation, the wood must be allowed to start to deteriorate before being used, otherwise it will take up what nitrogen there may be in the soil. With the use of natural organic fertilisers there may still be a need for the addition of nitrogen in particular, and possibly, other major elements.

Care should also be taken to maintain the correct potassium content, since in coarse soils it is prone to be lost by leaching.

12.6 IRRIGATION

The use of forced leaching, particularly in arid or semi-arid areas, to decrease the content of salts, heavy metals, metal toxins and acid material in the tailings can help to improve the soil.

The existence of alkaline conditions or pH neutral conditions, below the surface in a tailings dump can enable the capture of heavy metals and the neutralisation of low pH leachate. In arid and semi-arid areas the irrigation can be carried out by sustained use of misting sprays prior to planting. In some areas where water is limited drip irrigation has had similar effects. However, drip irrigation is only effective in the immediate root zone.

Table 12.3. Nutrient Sources

Nitrogen	% N
Ammonium	33 to 34
Urea	45 to 46
Ammonium sulphate	20
Calcium nitrate	17
Sodium nitrate	16
Potassium nitrate	13
Phosphorus	% P₂O₅
Superphosphate	20
Triple superphosphate	44 to 46
Monoammonium phosphate	48 to 52
Diammonium phosphate (18-46-0)	46
Potassium	% K₂O
Potassium chloride (muriate)	60 to 62
Potassium sulphate	50
Sulphate of potash magnesia (11% Mg)	22
Potassium nitrate	44

After OMAF 1994

12.6.1 Capillary Intervention

In arid and semi-arid climates the transportation of salts and toxins to the surface of the tailings by capillary action can reduce the fertility of the emplaced topsoil. For this reason a layer of crushed waste rock should be placed over the tailings prior to the application of the topsoil. This can reduce or eliminate the capillary effect.

The crushed rock should be in the minus 10 millimetre to minus 20 millimetre range. The thickness of this rock layer should be approximately 0.35 metres. If waste rock is used it should be carefully analysed for toxins or for the acid producing minerals it may contain. Prior to laying the topsoil, a filter cloth should be laid to prevent the settling of the topsoil into the crushed rock, thus negating the effectiveness.

12.6.2 Encouraging Infiltration

Infiltration is most effectively achieved by ripping or scarifying the disturbed and/or compacted area. In addition to the increase in infiltration, the ripping and scarifying loosens soil that has become compacted, melds the topsoil to the subsoil, provides places for the seeds to lodge and to become partially covered. It also increases the volume of soil that is readily available to the roots of the vegetation and allows deeper root penetration.

12.7 SPECIES SELECTION AND PROVENANCE CONCEPT

The use of local indigenous species which are already adapted to the local soil conditions and climate is recommended. It must be remembered however, that because of the changes in the microbial community as a result of the disturbance of topsoil, the relationship between the new growing surface and the local indigenous plant life may have changed. There can be a wide range of tolerance within a single species as many indigenous plants are very adaptive.

The best ways to initiate species selection is by observing the indigenous plant species that have grown on disturbed adjacent areas. Also, observe the soil and drainage conditions in which the different local species have adapted and attempt to match these conditions on the mine site. Select plant species that produce sufficient viable seeds to be harvested economically and used in the same area. It is not wise to use seed from one area to revegetate another which has different conditions.

“Provenance” refers to the origin of a plant species. A decision needs to be taken as to whether to use only local provenances of species, or a wider range of indigenous species. On the one hand, using only local provenances will tend to preserve the genetic integrity of the area, using species that are best adapted to the local soils, climatic conditions and ecological processes. On the other hand, a wider range of provenances may be preferred on the grounds that conditions on a rehabilitated mine will always differ, to some extent, from the original conditions on the site, and the local provenances will not necessarily be those best adapted to the altered conditions.

On revegetating, trees and shrubs take longer to establish, therefore, the initial planting should concentrate upon cereals, grasses and legumes to start to stabilise the soil. The use of one species would develop a monoculture, therefore; several species should be used. When planting shrubs and trees, either seeding or seedling planting may be appropriate, depending on the site conditions. Seeding, however, may require two or three applications. The planting of legumes is always beneficial since they are typically good soil colonisers and usually improve the soil conditions by contributing nitrogen to the soil.

Table 12.4 is a guide to slope inclination, following the guidelines drawn from Gartner Lee. The stabilisation of steeper slopes can be achieved by jute netting or the erratic partial burial of branches or obstacles.

Table 12.4. Guidelines to Slope Inclination

SLOPE	GUIDELINES
26°	Maximum slope for vegetation that can reasonably be established and maintained Assuming ideal soil Assuming low erodibility
18°	Maximum slope for establishing acceptable vegetation Less than ideal soils Maximum for safe maintenance
14°	Optimum maximum slope for vegetation

12.8 SEEDS AND SEED COLLECTION

Seed collection and extraction, the storage of seeds and seed bed preparation, should all be carried out under the guidance of a competent, soil scientist or forester. This aspect of rehabilitation is best guided by experts. This also applies for planning the methods of planting whether by direct seeding or by the planting of seedlings.

12.9 EXERCISES

1. What is the relationship between this chapter, and others that cover topics related to vegetation?
2. Where can you obtain advice and information relevant to your local conditions?
3. Where can you find plant species for rehabilitation purposes, especially indigenous plants?

Further exercises to be developed by the trainer

References

For further reading on this subject, the following texts are suggested. Additional references are to be found in Part IV.

Australian Environmental Protection Agency, 1995. *Rehabilitation and Revegetation. Part of the Best Practice Environmental Management in Mining Series.*

Brooks, B.W., Peters, T.H. and Winch, J.E., 1989. *Preparation of a Manual of Methods Used in Revegetation of Reactive Sulphide Tailings Basins. Mine Environment Neutral Drainage (MEND) Programme Project. E.O. 88593*

Gentner, B.A. and Bengson, S.A., 1993. *Five Different Vegetative Stabilisation Methods Used on Copper Tailings in Central Arizona. Proceedings of the Tenth National Meeting of the American Society for Surface Mining and Reclamation, Spokane, Washington, USA*

Gregg, P.E.H., Steward, R.B. and Mason, K., 1995. *Pastoral Reclamation of Tailings and Overburden Material from a New Zealand Open Cast Gold Mine. Proceedings of Sudbury '95 - Mining and the Environment, Volume 3, Sudbury, Ontario, Canada*

McGinness, S., Smith, K.V.L. and Atkinson, K., 1995. *Stability of Industrial Mineral Soil Amendments Subject to Biological Degradation. Proceedings of Sudbury '95 - Mining and the Environment, Volume 3, Sudbury, Ontario, Canada*

Peters, T.H., 1984. *Rehabilitation of Mine Tailings: A Case of Complete Ecosystem Reconstruction and Revegetation of Industrially Stressed Lands in the Sudbury Area. Ontario, Canada*

Sheehan, P.J., Miller, D.R., Butler, G.C. and Bordeau, P., (Ed) *Affects of Pollutants on the Ecosystem Level. Wiley, New York, USA*

Slick, B. and Curtis, W., 1985. *A Guide for the Use of Organic Materials such as Mulches in Reclamation of Coal Mine Soils in the Eastern United States. United States Department of Agriculture. General Technical Report NE-98, Washington D.C., USA*

Winterhalder, Keith, 1995. *Approaches to Engendering Biodiversity in Tailings Revegetation. Proceedings of Sudbury '95 - Mining and the Environment, Volume 3, Sudbury, Ontario, Canada*

Chapter 12

Amelioration and Vegetation

Prepared slides for overhead projection

Amelioration and Vegetation

- **Assessment of soil conditions**
- **Incorporation of organic materials and mulches**
- **Correction of PH**
- **Application of fertilisers**
- **Irrigation**
- **Species selection and provenance concept**
- **Seeds and seed collection**

Chapter 13

Stability of Tailings Disposal Sites

13.1 INTRODUCTION

Proper rehabilitation requires a good understanding of the structures being rehabilitated. Thus this chapter gives an overview of the basics of tailings stability. It is **NOT** a technical guide. Reference should be made to some of the publications listed at the end if technical guidance is sought. It should further be noted that, while some specific criteria are quoted in parts of this chapter, each tailings disposal site should be subject to specific criteria determined by the particular site conditions.

In the past, economics was the dominant factor in mine waste disposal site design. Environmental and safety concerns at present are now the most important factors in establishing design criteria for acceptable long term performance. Depending on the safety and environmental concerns, long term may mean as long as 200-2,000 years after the mining operations have ceased.

Waste rock piles are commonly not prone to failure providing the inclination of the slope is calculated as having a factor of safety of more than 1.3. Where downstream damage could be high a factor of safety of 1.5 is more appropriate. For further information, see the chapter on disposal of waste rock.

A brief review of the techniques of dam construction will serve to focus the potential problems for rehabilitation. Tailings dams (also referred to as “tailings dam walls”, especially in South Africa) may be built of either tailings or imported materials. The two types are designed quite differently. Little attention was paid to the environment or to the concerns of rehabilitating the sites in the past. Two examples of old, hopefully not presently used, deposition methods of tailings are uncontrolled discharge into a lake, Figure 13.1, or over undulating ground, as illustrated in Figure 13.2. However, these types of disposal sites exist and it is incumbent on the mining industry and society ultimately to rehabilitate them and ensure that there is no long term contamination or safety hazard.

13.2 DAM SITING

The siting of a tailings dam must be chosen carefully so as to minimise environmental impacts. The following considerations must be taken into account:

- All legislation and regulations.
- Geology: the foundation must be strong enough to support the final impoundment.
- Topography.

Figure 13.1. Uncontrolled Discharge of Tailings into a Lake - NOT RECOMMENDED

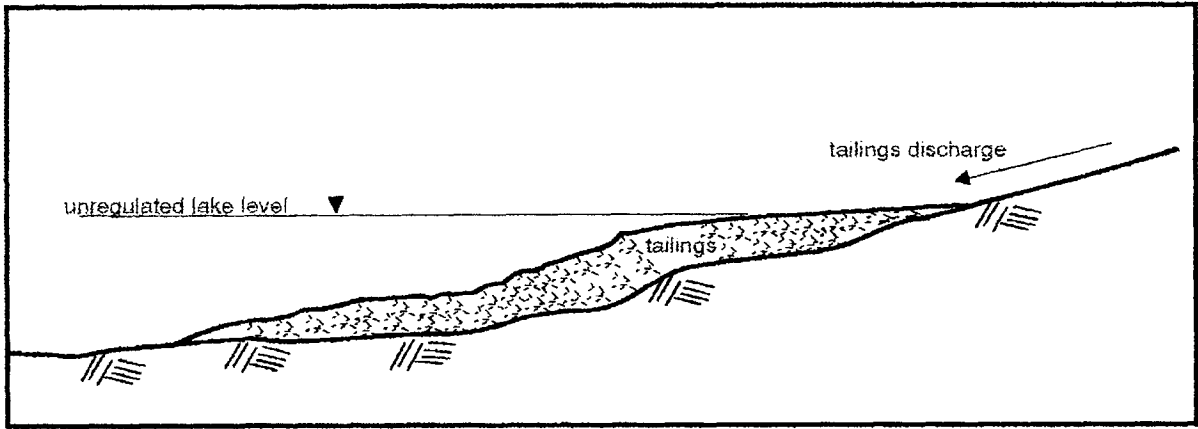
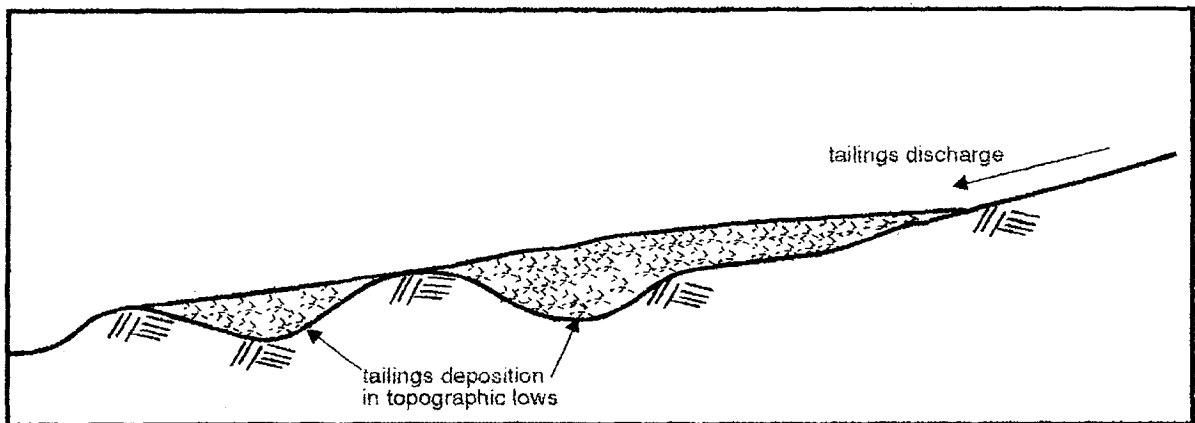

Figure 13.2. Discharge of Tailings over Undulating Ground - NOT RECOMMENDED



- Proximity of human settlements up until final rehabilitation: this is a health, safety and aesthetic consideration.
- Water impacts, both drainage to streams and rivers, and to groundwater.
- Nature of the tailings, with regard to their stability, chemical composition, and potential for forming dust.
- Local climate: temperature, rainfall, wind, evaporation.
- Cultural significance.

From an environmental perspective, the over-arching principle when choosing a site for a tailings dam is that it should be designed for closure from the outset.

13.3 DAM CONSTRUCTION

It is common practice for tailings dams to be constructed in stages to provide later for more capacity as it is required. This reduces the initial capital cost and spreads out the cash-flow over the life of the mine.

There are three basic methods of periodic stage construction, these are:

- The Upstream Method
- The Downstream Method
- The Centreline Method

These three methods are illustrated in Figures 13.3-5. The upstream method uses the least volume of material and the downstream method uses the greatest volume of material.

As shown in Figure 13.3 in the construction of the upstream method, this structure is built over previously deposited tailings which are susceptible to liquefaction and loss of strength under any major physical disturbance. This method is not recommended because of this inherent weakness.

In the construction of the downstream method, as illustrated in Figure 13.4, the structure can be completely built with engineered fill and it is probably the safest type of structure. The downstream method is the only method if the dam is to be a water retaining structure with a pond against it.

The centreline method is a compromise between the two methods and is best used as a remediation method for problems and failures which develop in the structure built by the upstream method or any other embankment dam failure.

Figure 13.3. The Upstream Method

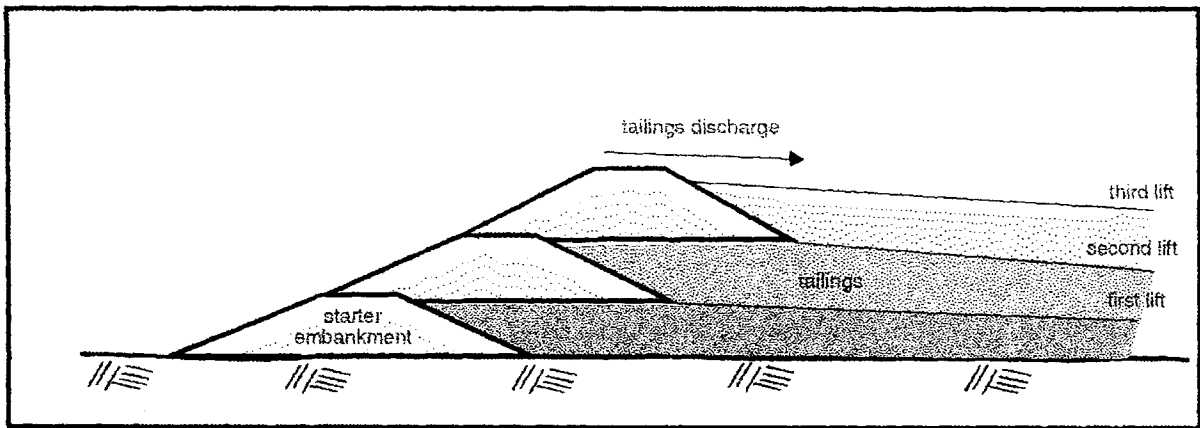

Figure 13.4. The Downstream Method

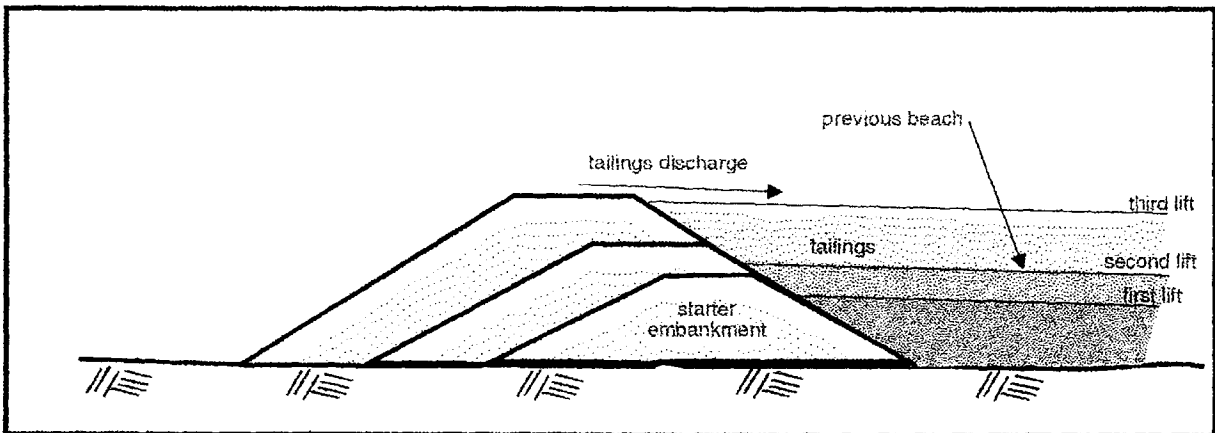
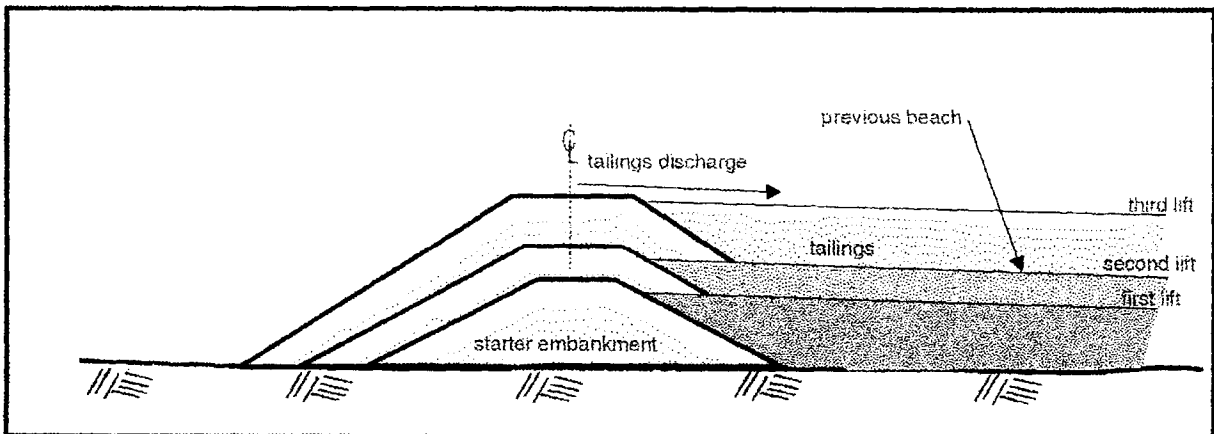

Figure 13.5. The Centreline Method



13.3.1 Methods of Deposition

There are many methods of deposition of tailings. The following is a brief review of a number of the techniques.

End Dump

Hydraulic end dump point discharge is the easiest and the least expensive to operate. The disadvantage is that the discharge velocity is high and it is difficult to build a uniform beach.

Spigotting

Spigotting is a common method to develop a uniform beach or to build an embankment with tailings. The discharge velocity is low and the coarse fraction stays at the top of the beach.

Thickened Tailings (Robinsky Method)

Thickened tailings allow a steeper beach to be developed. This may not be desirable, as with acid generating tailings, an exposed drained beach will remain, allowing oxidation. With this method there is less water for slurry, therefore there is less segregation on the beach. If however, tailings could be thickened enough to approximately 75% solids, then there would be no segregation on the beach at all. This technique is of interest, but at this time conventional thickeners or existing slurry pumping technology make it impractical. Furthermore, it only works well with certain tailings in certain climates, and is not generally accepted.

Thin Layer Spigotting

This method can be very effective in arid to semi-arid, warm climates. The technique is that a thin layer is allowed to dry and desiccate before placing the next layer. The big advantage is that desiccation reduces the volume and the water content of the tailings.

Cycloning

The advantages of cycloning is that the coarse and fine fractions can be separated. The coarse fraction can be used to build the outer embankment of the tailings dam and the fine fraction is then deposited within the impoundment. Using the cycloning technique any of the construction methods can be utilised.

13.4 INSTABILITY FACTORS

Instability in a dam can manifest itself in many ways, such as, seepage, slumping, slope failure, reduced free-board, inadequate decant or spillway capacity and overtopping of the dam wall or embankment.

Potential failure mechanisms include the following:

- Release of water:
 - overtopping (failed or plugged decant or spillway)
 - retrogressive erosion (runoff and surface drainage)
 - internal piping (erosion) in the embankment of foundation
- Overstressed foundation
- Liquefaction of tailings on loose fine grained embankment fill due to dynamic loading, e.g. earth tremors and explosions
- Slow release of contaminants into a surface stream or groundwater, particularly if tailings are acid generating (slow release should be considered a major risk even though it may not be a catastrophic failure mode).

The best parameters to monitor for determining the stability or potential problems in a dam are the following:

- ground water or pore water pressure
- seepage
- deformation of the structure as indicated usually by settlement

13.5 EXERCISES

1. How do tailings design aspects influence rehabilitation and vegetation?
2. How does the rehabilitation of the dam wall differ from the rehabilitation of the tailings behind it?

Further exercises to be developed by the trainer.

References

For further reading on this subject, the following texts are suggested. Additional references are to be found in Part IV.

Environment Australia, 1995. Tailings Containment. Part of the Best Practice Environmental Management in Mining series.

CANMET Pit Slope Manual, 1977. Energy Mines and Resources, Ottawa, Canada

Chamber of Mines of South Africa, 1996. The Engineering Design, Operation and Closure of Metalliferous, Diamond and Coal Residue Deposits.

Hoek, E., and Bray, J., 1981. Rock Slope Engineering, Institution of Mining and Metallurgy, London, UK

ICME/SIDA/UNEP, 1997. Proceedings of the International Workshop on Managing the Risks of Tailings Disposal.

ICOLD/UNEP, 1996. A Guide to Tailings Dams and Impoundments.

Lundgren, T., 1991. The Efficiency of Covering the Sulphitic Waste Rock in Bersbo Sweden. Second International Conference on the Abatement of Acidic Drainage. Montreal, Quebec, Canada.

Ontario Ministry of Labour, 1982. Guidance for Engineers and Inspectors - Tailings Dams and Related Structures, Ottawa, Canada

Penman, A.D.N. and Milligan, V., 1991. Longevity of Embankment Dams - Critical Review. Golder Associates, Mississauga, Ontario, Canada.

South African Bureau of Standards, 1998. Code of Practice for the Control of Mine Residue Deposits.

UNEP IE, 1996. Environmental and Safety Incidents concerning Tailings Dams at Mines. UNEP IE/UNEP-DHA Environment Unit.

Welsh, D.E., 1992. Mine Waste Management Practice, University of Queensland, Australia

Chapter 13

Stability of Tailings Disposal Sites

Prepared slides for overhead projection

Stability of Tailing Disposal Sites

- **Dam siting**
- **Dam construction**
- **Instability factors**

Chapter 14

Disposal of Waste Rock

14.1 INTRODUCTION

A common factor in mining operation is the production of large volumes of waste rock required to develop the site. This is because at most mine sites large amounts of uneconomic rock have to be removed to gain access to the ore.

As emphasised throughout this publication, the location and rehabilitation of waste disposal sites need to be planned as early as possible and definitely before the property is put into production. The ideal situation is to return the waste rock to areas where mining activity has finished. This is often not possible, however, particularly in underground operations, and the waste rock therefore has to be placed in a pile or prepared disposal site.

14.2 SITING

The siting of the disposal sites should be considered in the earliest plans. Features that should be taken into consideration include the accessibility and the distance from the workings whether a pit or a shaft. The areal extent of the ore body should also be known, so as not to have to move the disposed rock at a later date. Physical constraints such as transportation corridors, power lines or other area logistic features will also influence the location. Of prime importance is the future capacity of the disposal site. For this reason the topography should be carefully studied so that the construction of the site can take advantage of any topographic features. The surface area that will be affected in the development and operation of the mine and its subsequent rehabilitation are also controlling factors. In studying the topography of the area, the area of the watershed in which the operation lies must also be considered. In studying the watershed, data have to be collected on the hydrology and the hydrogeology to predict the likely volumes of water that may enter and leave the disposal site. The management of runoff and drainage often represents the largest problem to overcome in the operation and rehabilitation of the disposal sites. Acid mine drainage is covered in the following chapter.

The existing use of the area is also of importance as it relates to property ownership and to the mineral rights. The distance from residential habitation and areas of human activity are very important because of the public's concern about the environment and their possible critical views on the perceived impact of a disposal site.

14.3 STRUCTURE

When beginning the design of a disposal site, a detailed calculation is needed of the total volume of waste rock expected to be generated during the anticipated life of the mine. This is very critical in the design of the disposal site and its subsequent rehabilitation. In drawing up these plans, there is a need to include the slope profile and the control of water run-off on the local water regime. In planning for the future rehabilitation, waste disposal sites should be designed to have a slope of angles between 12 degrees and 20 degrees. This makes them far more amenable to subsequent rehabilitation, since vehicles can still traverse them and good drainage of the slopes can be obtained. The precise geological nature of the

waste rock will dictate the maximum stable slope angles of the disposal site, together with the topography and local climatic conditions.

Drainage control structures will be required in arid or semi-arid areas where rainfall, even if only occurring intermittently, is usually heavy and can cause serious erosion. A number of techniques have been developed in arid and semi-arid areas to provide increased protection against erosion, to increase the capture and infiltration of rainfall and to create protective sub-sites. With torrential rainfall, gully erosion is very common in unconsolidated material and it is therefore advisable to establish a drainage pattern which can control and divert this flow. One suggested method is to have a number of looping mounds (also called berms) about 1.5 metres deep and between 8 and 10 metres apart. This configuration would permit heavy equipment to cut these structures quickly and efficiently at a time when the area is needed for disposal of the waste material.

Figure 14.1 is an illustration of a pattern that can be developed. The interlocking and staggered off-set of each structure and mound reduces the energy of the run-off and so avoids channelling and gully formation in unconsolidated strata.

14.4 AESTHETICS

Waste material can be also used to screen operations from view. If unplanned or undertaken irresponsibly, it can also have a significant negative impact and could cause a considerable amount of unpleasantness with the authorities and local inhabitants. When planning for the development of a mine, directing the disposal site away from critical view points can provide a far more pleasant appearance. This is illustrated in Figures 7.1 and 7.2. In addition, waste disposal sites at mines can be very successfully used in screening the other facilities and operations of a mine.

Figures 14.2, 14.3 and 14.4 illustrate the development of a mine waste disposal site, using a reasonable slope inclination and carrying on progressive rehabilitation. In addition, if there is the necessity for the development of later lifts (also termed layers or levels), should the mine life be extended, and if there is a need for further waste rock to be disposed, it can be accommodated. Figures 14.2, 14.3 and 14.4 illustrate the progression of the development of a style of mine waste disposal that permits simultaneous, progressive rehabilitation.

The development of the disposal site is started with the first loads facing out toward the critical view point (Figure 14.2). It is deposited in the form of a crescent with a large vacant area in the centre. Prior to any deposition, the topsoil and sub-soil is stripped and stored in low heaps as close to the waste disposal site as is practicable.

In Figure 14.3 there is continuous internal filling in the interior of the structure, from the outer edges into the centre, with waste rock. Concurrently, progressive rehabilitation using the stockpiled soils takes place on the outward facing slopes.

The completed first lift of the disposal site is depicted in Figure 14.4, and the second lift is begun, also from the outward side inward to form a second crescent-like structure. At the same time progressive rehabilitation continues on all sides of the first lift beneath.

Where mine waste is a fine material, rock cladding is a common method used to stabilise the slope. It also reduces wind-blown dust and provides protective crevices in which vegetation can start to take root.

14.5 EXERCISES

1. When should the rehabilitation of rock piles commence vis-à-vis mine operation?
2. Examine and discuss the relevance of earlier chapters to the present one.

Further exercises to be developed by the trainer.

References

For further reading on this subject, the following texts are suggested. Additional references are to be found in Part IV.

Broman, P., Haglund, P., Lattssib, E., 1991. Use of Sludge for Sealing Purposes and Dry Covers - Development in Field Experiences. The Second International Conference on the Abatement of Acidic Drainage. Montreal, Quebec, Canada.

Hoek, E., and Bray, J., 1981. Rock Slope Engineering, Institution of Mining and Metallurgy, London, UK.

Piteau Associates, 1991. Mined Rock and Overburden Piles: Interim Guidelines - for Investigation and Design. Bi-Tech Publishers, Vancouver, British Columbia, Canada.

Figure 14.1. An illustration of a pattern that might be used to control torrential rainwater run-off

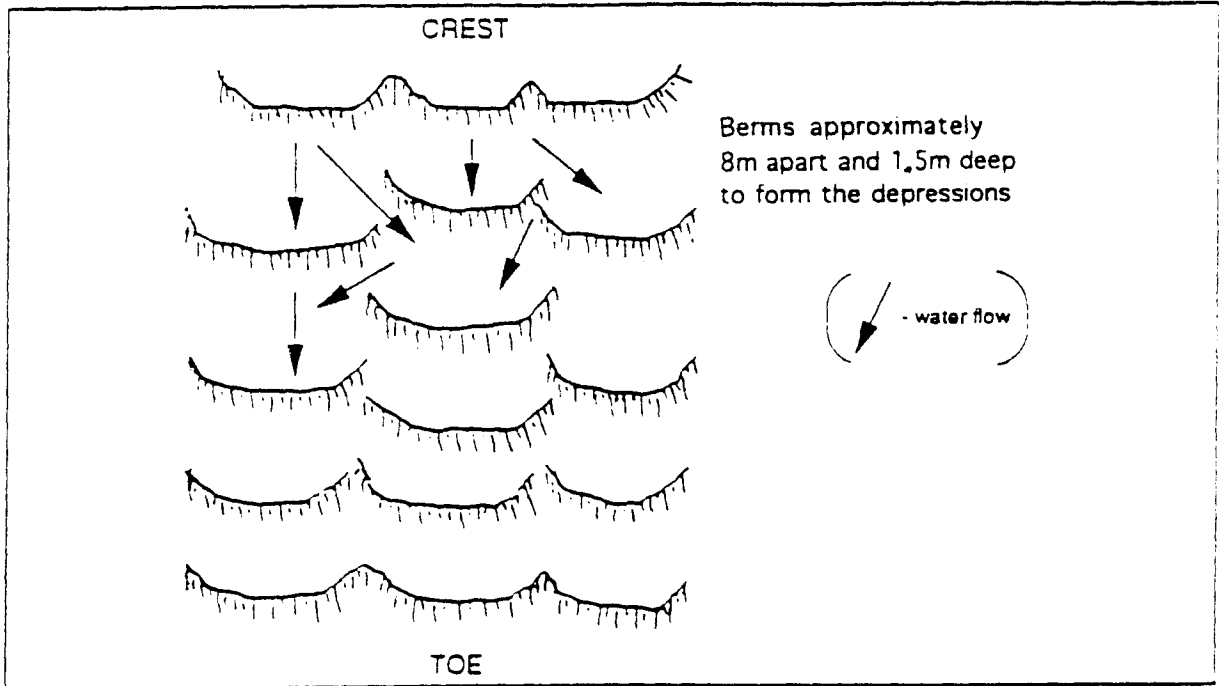

Figure 14.2. Outside faces dumped first

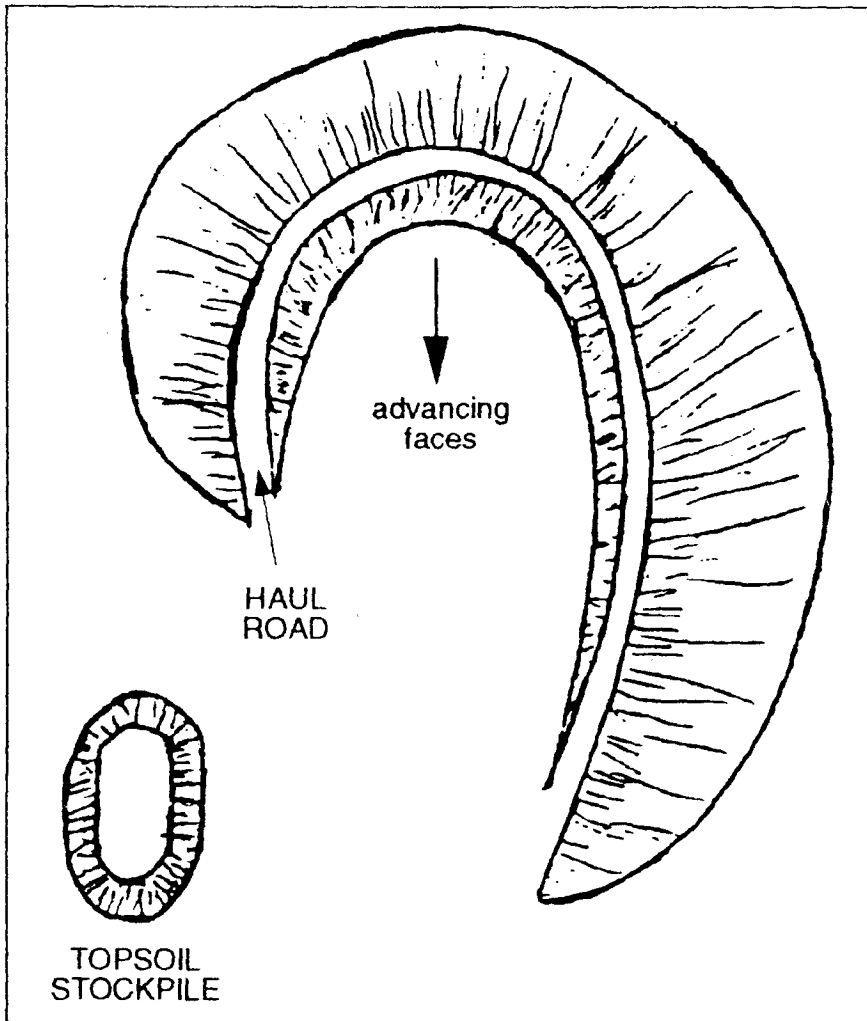

Figure 14.3. Continuous dumping, in filling the internal space with concurrent progressive rehabilitation on the outer slopes

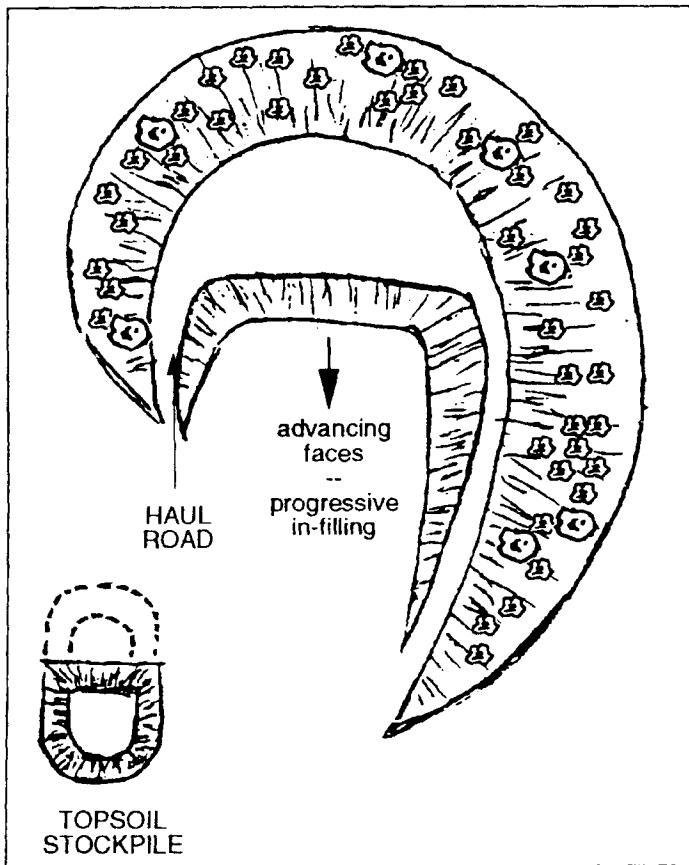
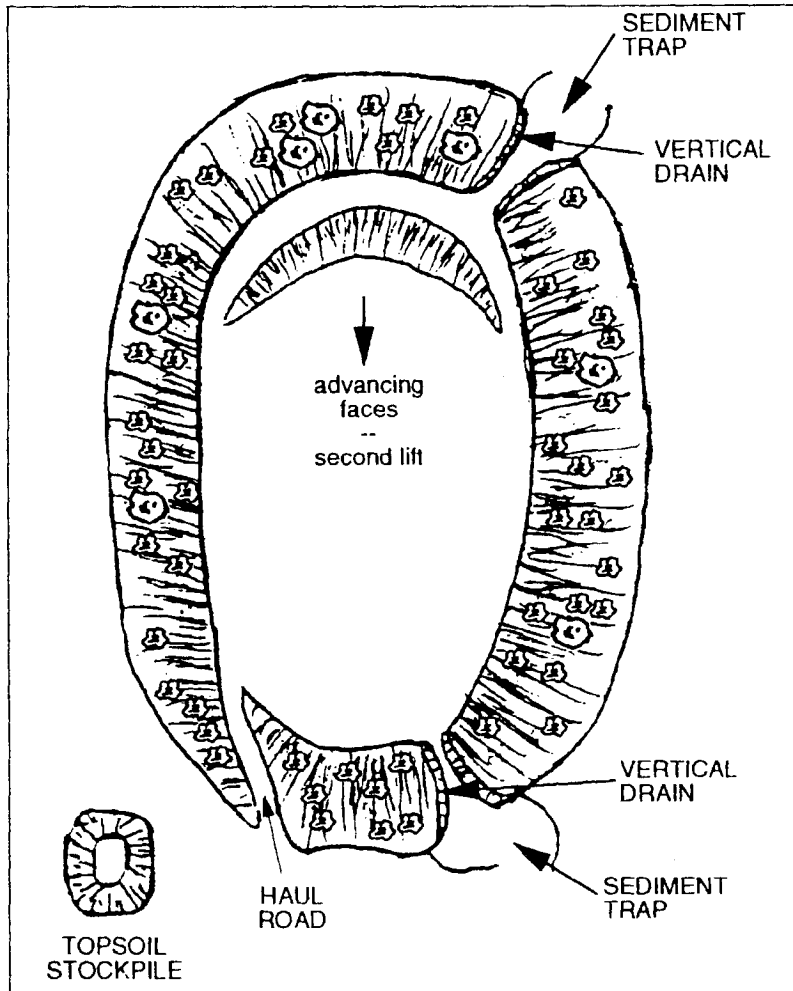

Figure 14.4. Illustrates the rehabilitated lower slopes and the start of the second lift



Chapter 14

Disposal of Waste Rock

Prepared slides for overhead projection

Disposal of Waste Rock

- **Siting**
- **Structure**
- **Aesthetics**

Chapter 15

Acidic Drainage

15.1 INTRODUCTION

Acidic drainage includes what is commonly called either acid mine drainage (AMD), acid rock drainage (ARD) and acid drainage as it occurs in nature by the oxidation of sulphide rich shales for example.

The single most difficult environmental problem in the metal mining industry is acid mine drainage. This is particularly true relative to the long term care and maintenance of both operating and abandoned mines. Many base metal, gold, coal and uranium mines contain sulphides which are not recovered either from the ore or from the host rocks. When sulphide minerals such as pyrite, pyrrhotite, arsenopyrite, are exposed to oxygen and water they oxidise and produce sulphuric acid which could dissolve toxic concentrations of heavy metals such as nickel, zinc, aluminium and lead.

At a pH of about 3.5, a naturally occurring bacteria, *Thiobacillus ferro-oxidans*, has a major impact on the production of acid in that it accelerates the acidification process by several orders of magnitude. In a transitional reaction the sulphide will initially be oxidised to an iron sulphate (salt), which is very noticeable as a light green or light blue to white coating or powder on the minerals or on the adjacent rocks. Due to the high solubility properties of the acid it will readily dissolve heavy metals and toxic elements and the effluent from the waste sites will be flushed into the downstream environment.

If the effluent is left uncollected or untreated the acidic drainage could contaminate ground water as well as surface waters in streams and water courses. This will impact vegetation, wildlife, fish and, if present, the human population as well. Acidic mine drainage is not only derived from sulphide containing tailings but is commonly generated by sulphidic waste rock piles. These waste piles are usually high mounds which provide the ideal conditions to promote acid generation because they are well aerated and serve as natural leaching piles.

Sulphidic mine waste rock and tailings continue to oxidise for many years after operations have ceased, and can possibly require expensive treatment virtually in perpetuity. Acid generating waste rock piles and tailings ponds have a major bearing on the site selection, design and decommissioning strategies of mine waste disposal facilities.

The problem of managing acid generating waste is of such high concern in Canada and North America that a co-operative programme called MEND (Mine Environment Neutral Drainage) has been established. This is a voluntary programme involving the Canadian Federal Government, eight Provincial Governments and 29 mining companies. At present, research into finding more economical and efficient ways of managing acid generating mine waste, is being sponsored by the three partners.

The management of acid mine drainage could represent the greatest cost component of any rehabilitation plan. Unfortunately, there are no simple solutions. Methods to manage acidic drainage will be discussed under the following categories:

- Early planning
- Perpetual treatment
- Inhibit or reduce the rate of oxidation
- Removal of the wastes from the mine site
- Tailings paste backfill at underground mining operations
- Biological treatment of effluent
- Co-disposal of tailings and waste rock

15.2 EARLY PLANNING

Once again, planning is essential if mining rehabilitation is to be efficient and cost effective. The best method known to date to inhibit oxidation is submergence below water. However, many existing waste dumps and tailings basins are not amenable to complete or even partial submergence. In any event, the raising of the water table within a disposal site should decrease the volume of potentially acid generating material and represents a partial solution to inhibiting acid generation.

The deposition of the sludge from the lime treatment plant and the decommissioning costs, may, if not properly planned, be even greater problems than the initial construction and operating costs of the mine. In the initial planning of the operation it therefore may be less expensive to locate the tailings at a further distance from the mill if they can be designed for subaqueous disposal.

The following are practices which can be implemented during operation which could further inhibit oxidation and acidic production in the waste piles:

- Waste rock can be compacted to reduce pore space and thus inhibit access to oxygen and moisture
- Impervious sloping soil or clay layers can be inserted into waste rock disposal sites. This will inhibit access to oxygen and moisture and encourage drainage to the perimeters, thus making it more efficient to treat the effluent, if necessary
- Some form of impervious cover will be required on reactive waste. Impervious covers are very expensive so the depth of waste should be maximised in order to reduce the surface area requiring covering.
- Place the most offensive high sulphur content material into low lying areas in tailings ponds so that it can be readily buried and submerged within the phreatic zone

- Waste structures, particularly on new properties, should be very carefully designed and managed so that they will not occupy large areas
- In order to restrict the spread of acid producing waste, waste for the construction of roads, dams and perimeter walls should be clean and not acid producing material. Consequently; the properties of mine rock waste have to be analysed prior to use.

15.3 PERPETUAL TREATMENT

Under this approach the tailings and waste rock piles are constructed with the intent of collecting and pumping the contaminated run-off and treating it in perpetuity. Conventional reclamation techniques, such as contouring for vegetation may be applied to stabilise the surface, but these do little to mitigate the acid generation and may also be affected by the generation of acid. If the infiltration of water can be reduced, the seepage will be reduced and there will be less treatment, which will reduce costs.

If large volumes of waste are produced this “do nothing” option of perpetual treatment can be very expensive. Proportionally, for a smaller operation, this approach would be comparatively more expensive.

Large quantities of lime are required to neutralise acid, which produces large volumes of low solids content sludges. When acidic drainage is neutralised metal hydroxides and gypsum precipitate out of solution to produce a sludge which typically ranges from 3% to 10% solids by weight. The sludge can be thickened by filters or in modified conventional thickeners to reduce the volume. Subsequently, it can be mixed with tailings and as most metal hydroxides are chemically quite stable they serve to help stabilise the tailings as a whole. This however, is an expensive procedure and it has been said that the volume of sludges may in fact, be higher than tailings at sites requiring perpetual treatment. However, although perpetual treatment may be expensive it still may be the most economical management option for some mines.

15.4 INHIBIT OR REDUCE THE RATE OF OXIDATION

It is not realistic to expect the elimination of all acid generation, but measures can be taken to reduce the rate of oxidation. The lower the rate of oxidation the less will be the potential environmental impact, and the less will be the annual management cost to manage the facility during operation and after decommissioning.

The following are some of the methods used to inhibit acid generation:

- Subaqueous deposition
- Dry impervious covers
- Dry pervious covers

- Water covers
- Chemical treatment
- Injection
- Alkaline buffering

15.4.1 Subaqueous

Potential acid generating mine waste contained in a saturated state will oxidise at a very slow rate and is normally not a net acid generator. Submergence, however, is not always available as a method because the natural topography might not be amenable to such a solution and because of climatic conditions, sufficient water may not be available. Regardless, a high phreatic surface should be encouraged to reduce the volume of acid generating mine waste above the water table. Possible scenarios of submergence are:

In-Lake Deep Water Tailings Deposition

The deposition of the tailings underwater in a natural lake or in a man made water body, is the most efficient method to inhibit the generation of acid. However, it is increasingly difficult in certain jurisdictions to obtain regulatory approval for disposal in natural lakes. Several sites for man-made tailings impoundment have received regulatory approval. Experimental work in both Sweden and Canada has shown that subaqueous disposal, in the long-term, does not seem to have a detrimental effect on either the water quality of the lake or on the biota of the lake. Figure 15.1 illustrates this method.

Due to the potential controversy associated with using natural lakes for subaqueous disposal, there is considerable interest in evaluating whether artificial basins offer similar advantages to natural lakes. This is of particular interest in that artificial basins in most cases would be much shallower.

Figure 15.1. Deep Water Tailings Disposal

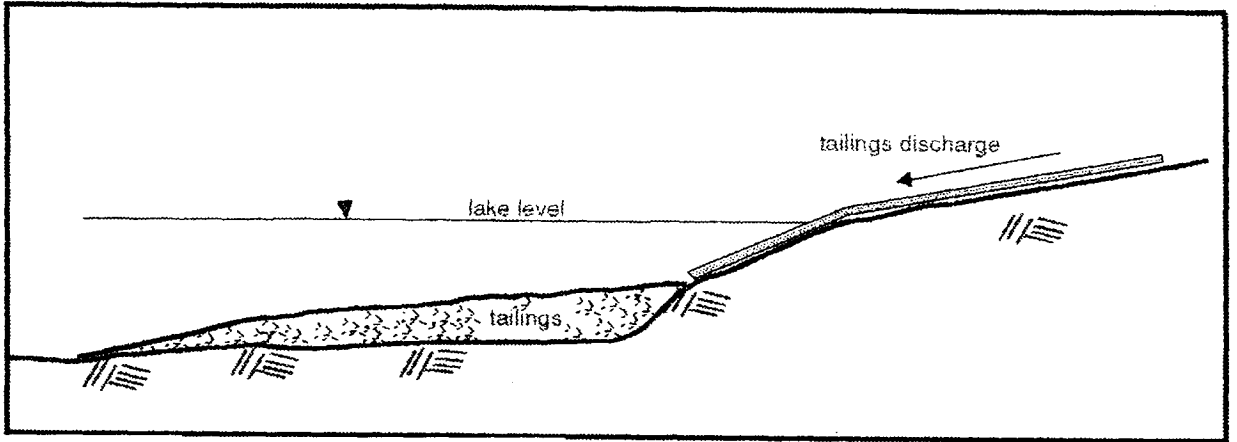

Figure 15.2 (a) Concept of Cross Valley Dam

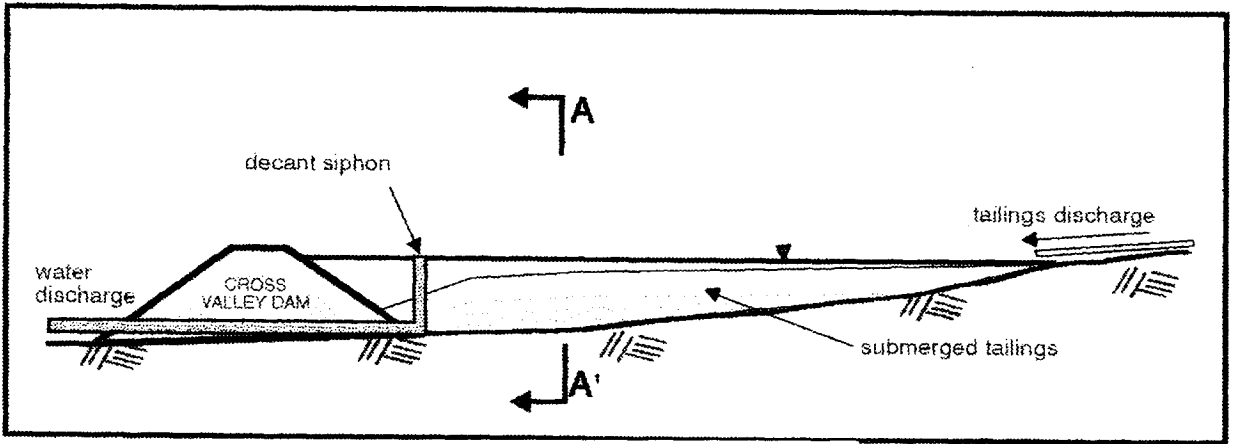
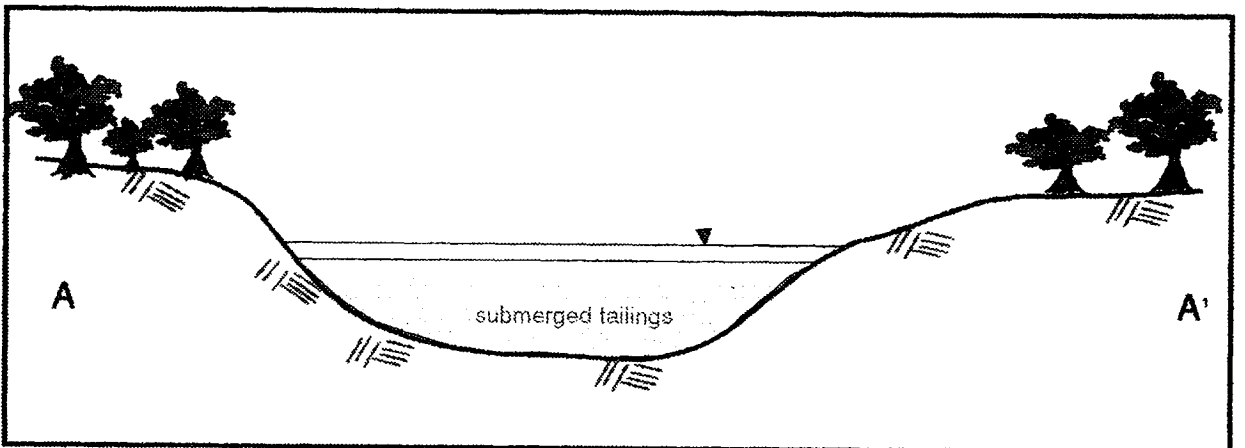

Figure 15.2 (b) Dam Cross Section A-A'



Man-Made Cross Valley Dam

The cross valley dam involves the creation of a man-made lake. The dam is designed with an embankment constructed to hold back a sufficient depth of water so that the tailings may be deposited under the surface of the water. Figures 15.2(a) and 15.2(b) illustrate this concept.

Fully Lined Ringed Tailings Facility

This scenario is most appropriate where topography has minimum elevations and the whole tailings dam is ringed by man-made embankments. In addition to being enclosed completely, the facility is fully lined. The nature of the lining is dependent on the porosity and permeability of the underlying soil. The lining may be a synthetic membrane or an impermeable clay if locally available. A new development are bentonite mats which swell to form an impermeable clay liner. The tailings are again deposited underwater and the water cover is maintained at all times. Figure 15.3 illustrates one of many methods of lining.

Side Hill Containment

The construction of a perimeter embankment adjacent to a topographic feature is a modification or adaptation of the fully lined ringed tailings facility. As in the previous structures the design and the engineering must be well planned and well constructed. The tailings in this facility, and those of the ringed facility, being submerged, will have a high water content. Therefore; the dams must be designed to prevent catastrophic failures. Figure 15.4 illustrates this approach.

Open Pit or Opencast Disposal

The deposition of the tailings and waste rock, at cessation of mining, into an abandoned open pit is a very viable alternative, particularly if the pit is located on the mine site and is not adjacent to any underground workings that are in operation. This also represents a method to prevent the generation of acid from the wall-rock of the open pit working itself. The deposition of the tailings with the water cover will ultimately prevent acid generation from the pit walls. Figure 15.5 illustrates this technique.

As a word of caution, when placing tailings or waste rock into an open pit, care must be taken to ensure that no potential ore is left in the pit.

Disposal of Acid Forming Waste In Flooded Abandoned Mines

This technique has been used with varying degrees of success. Insufficient work has been completed to make this method a viable alternative at this time.

Figure 15.3. Fully Lined Ringed Tailings Impoundment

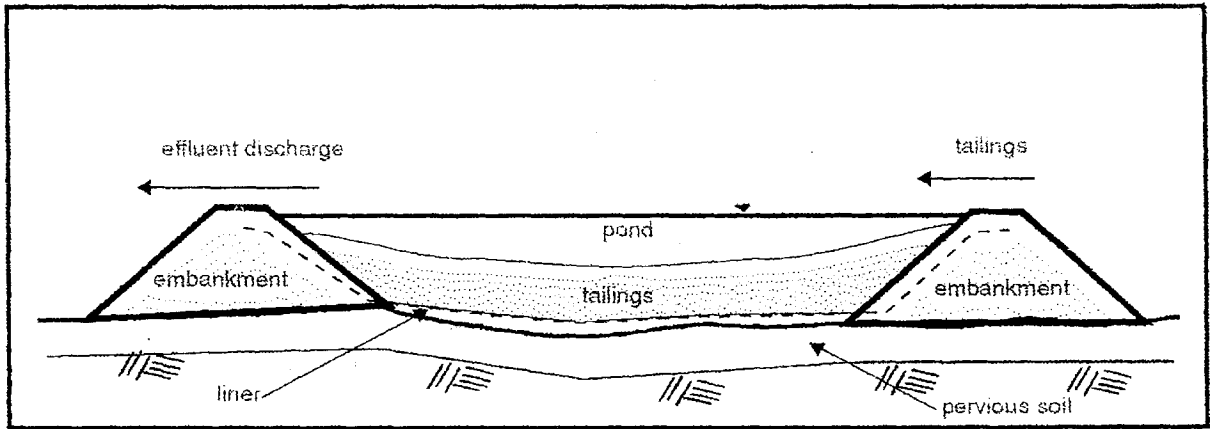

*

Figure 15.4. Side Hill Containment

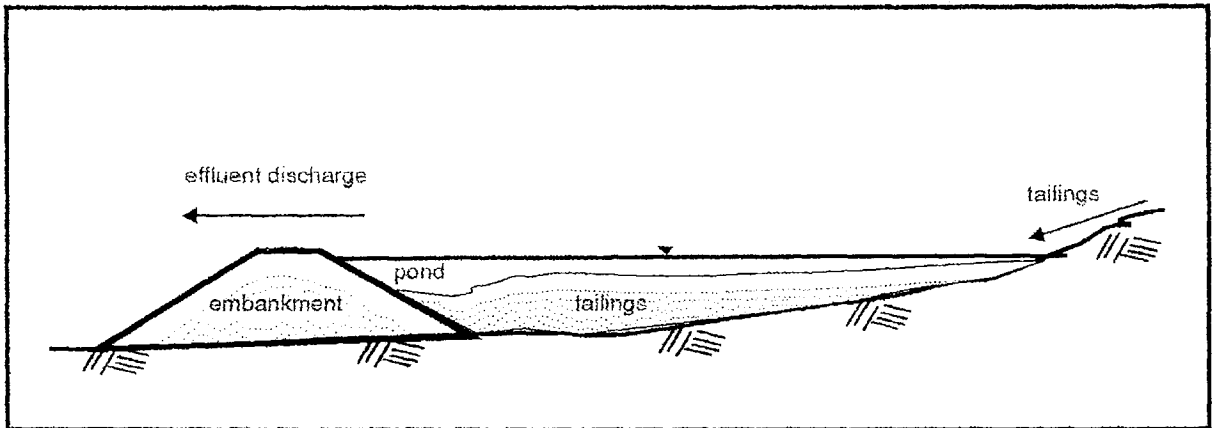
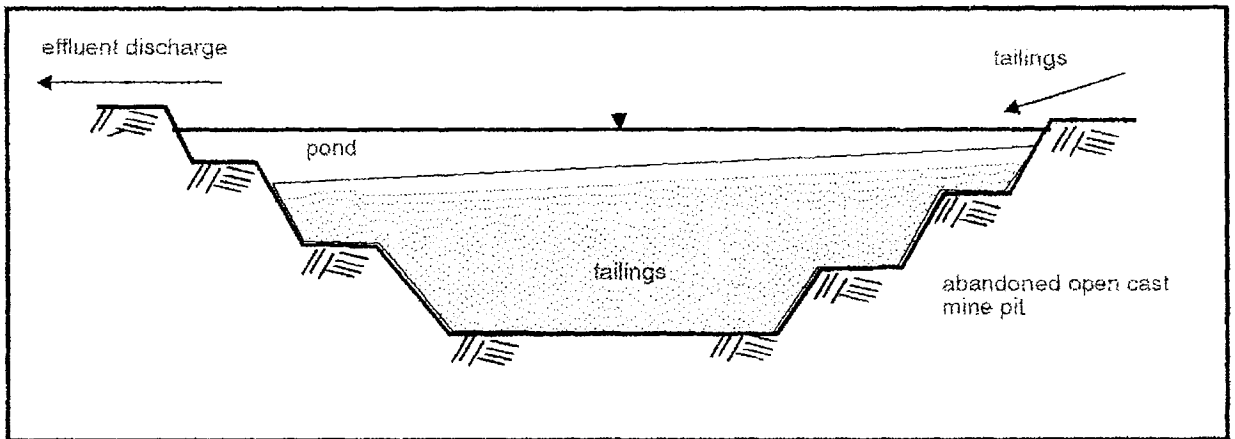

Figure 15.5. Deposition in an Open Cast Pit



15.4.2 Dry Impervious Cover Barriers

Dry covers inhibit the ingress of water and oxygen and can reduce the rate of release of acid from the potentially acid generating waste.

Potential dry covers include:

- Fine grained soil such as clay
- Bentonite and soil mixture
- Bentonite pads are a developing method that may have very positive results
- Synthetic geomembranes. This is probably an effective measure, but is expensive and its long term performance is not known.
- A cap of tailings composed of sulphide free rock produced by a separate flotation circuit in the mill. The circuit is specifically designed for this purpose. This method would be most appropriate towards the end of the mine life.
- Bacterial biofilms are at present being studied, but although originally thought to be feasible, they still need much research before there is sufficient data available on their suitability.

Impervious covers on tailings are expensive and may not be highly effective in the long term. They do leak and are susceptible to deterioration. When assessing any cover option, modelling the effectiveness of the cover to control water infiltration and oxygen diffusion is essential before any major investment should be undertaken.

Mine waste disposal sites by their very nature are far more difficult to cover. Where local impermeable soils are available an engineered soil cover may prove to be a very viable alternative. However, settlements caused by weathering of the rock can be a problem.

15.4.3 Dry Pervious Cover

Pervious covers are much easier to construct and to maintain than impervious covers. In warm, arid and semi-arid climates, or in basins with small watersheds, pervious covers have an advantage over wet covers, because evaporation of water is cut to a minimum.

Depending on the climatic conditions, pervious covers have to be quite thick, in the order of 2 metres or more, to accommodate fluctuating ground water levels during the dry periods and to minimise the adverse affect of evaporation losses due to capillary rise. A layer of coarse material inserted in a cover will minimise losses due to capillary action. A high water level in a pervious cover may only be maintained if the seepage losses out of the basin are less than the inflows. This has to be very carefully monitored. Figure 15.6 is an illustration of a multi-layered pervious cover.

15.4.4 Water Covers

Covers which include flooding or developing wetlands on tailings at decommissioning are only viable if enough water is available. Examples of total water covers is treated under 15.4.1.

Water from an external watershed may be required to maintain saturation during dry periods, but this is only viable if it is available by gravity drainage. External run-off from the tailings dam is not desirable during operations and should be diverted. After closure, however, the possibility of redirecting the water over the waste, as a source of water, may be an option.

15.4.5 Chemical Treatment

Chemical treatment has been found to either destroy the acid-producing bacteria or contribute to the coating of rock particles. The use of chemicals is only feasible in moist rock piles. Where used, the treatment is very expensive and only provides short-term protection from acid drainage.

Figure 15.6. Example of a Multi-Layered Pervious Cover

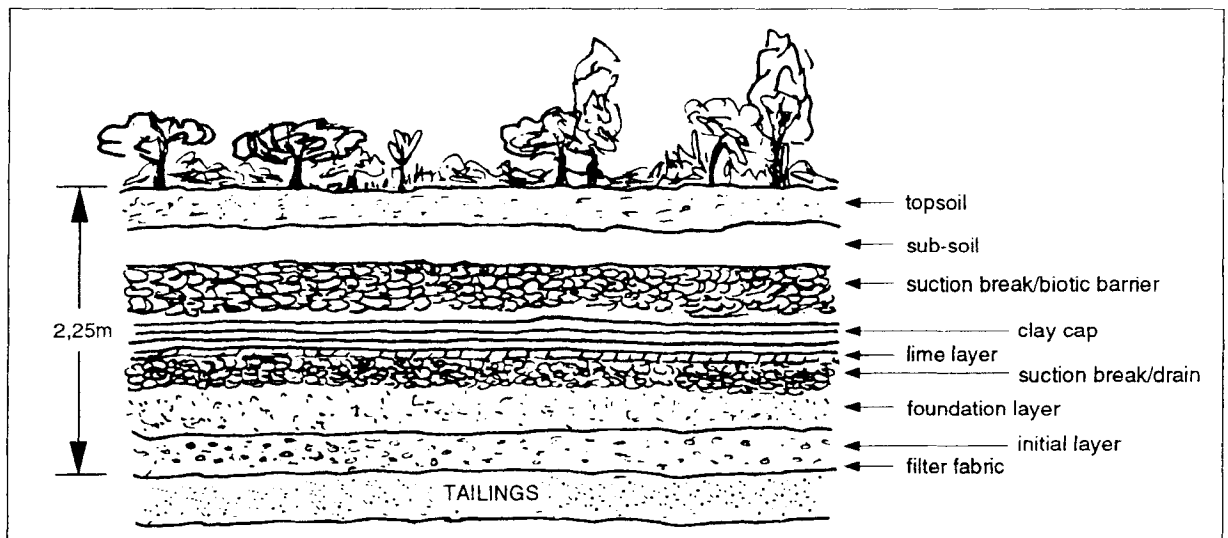

15.4.6 Injection

The injection of relatively impervious materials such as tailings or sludge, to plug the pore spaces of mine waste rock disposal sites, will inhibit the access of oxygen and water. Injection is only suitable for waste rock piles. Even then it is an unreliable and inconclusive method. The drilling of access holes for the injection of the material is difficult in rock piles. Not much is known about using sludge for injection into mine rock waste sites. The sludges that are introduced may in fact redissolve in a highly acidic environment.

15.4.7 Alkaline Buffering

Lime in its various forms can be added to both mine waste rock and to tailings to react with and neutralise the acid. One common procedure is the addition of lime to tailings in the mill. Other methods include lime rich slurry sprays, lime feeders into effluent streams and limestone trenches. All of these methods may only be viable if there is an economic supply of lime or limestone. Alkaline buffering in conjunction with a natural wetland has also been used to a limited extent.

If the acidity is high, then the addition of lime may be only partially effective and of limited short term benefit.

15.5 REMOVAL

Acid generating waste can be removed from the area and placed in mined out space, which after mining has ceased, is flooded. This requires careful planning. Waste rock could be put into an abandoned open pit and tailings into underground mined out stopes providing that part of the mine is no longer in operation. This method however, has the possible limitation that it cannot be carried out until the end of the mine life. This represents a problem in that the owners of the mine normally no longer have the available cash flow to carry out the operations and most of the necessary equipment has left the site. Furthermore, in the interim, remedial action is still required to control the acid generation during the operation of the mine.

Removal may not be as radical a solution as it would first appear, as it has been shown to be effective provided there is a location to which the material can be taken. On the other hand it is still difficult to guarantee the effectiveness of many of the other, as yet untried, techniques.

15.6 PASTE BACKFILL

During the preliminary planning, tailings should always be considered for use as structural backfill for underground mining operations. Traditionally, the coarse tailings fractions have been separated and placed in as hydraulic backfill. More recently, however, progress has been made in using the total tailings which are dewatered and placed as a dense paste backfill with concrete type pumps. Cement is added to the backfill for safety reasons, to

prevent the liquefaction of the hydraulic backfill where there are adjacent mining operations.

The advantages of paste backfill include its relative impermeability, which inhibits oxidation, as well as providing good structural support underground. Another advantage of using paste backfill is that up to 60 percent of the tailings are used, thus reducing the volume of acid generating material on the surface.

Paste backfill technology is still in the early stages of development but it may be an economical alternative to other types of backfill.

15.7 BIOLOGICAL TREATMENT

Biological treatment is still in a relatively early stage.

Wetlands can be developed downstream of acid producing waste to provide for biological extraction. The biological processes, which include both plants and algae, do not inhibit acid production but the process has demonstrated that biochemical processes can consume the acidity and take up the metals.

CANMET of Natural Resources Canada, the United States Bureau of Mines and the United States Forest Service have carried out extensive studies on wetlands. The apparent reaction is that the bacteria consumes the acid, thus chemically reducing the sulphates to hydrogen sulphide, which reacts with metals to form insoluble precipitates which can be reclaimed. The biological treatment is not a stand alone solution. It does not specifically inhibit acid generation but it causes the removal of contaminants from the acid solutions and allows them to be recovered.

This biological research is still very much in the early stage and the capacity of such systems are as yet to be determined. In colder climates the rate of reaction must be taken into consideration before these biochemical methods can be universally applied. Since it is not an expensive method it should always be considered in the suitable climate environment, and used in conjunction with other control methods to enhance the water quality at any site that has acidic mine drainage.

15.8 CO-DISPOSAL OF TAILINGS AND WASTE ROCK

Co-disposal of tailings and waste rock is only feasible where there is an abundance of waste rock. Theoretically, the pore spaces are reduced thus inhibiting the access of oxygen and water. Also a higher phreatic surface can be maintained because the permeability is reduced. These factors will reduce the rate of acid generation.

The tailings can be handled either dry or hydraulically. Filtering is expensive but the comparative cost of retaining dikes and water effluent management for a wet system should be modelled before decisions are made as to which technique is the most cost effective.

15.9 OTHER METHODS

Tailings, in particular, can be reprocessed, especially when an economic value can be determined. Old tailings piles commonly contain a high percentage of the valuable minerals, which were not recovered by former operations. New technology can now be used to recover minerals.

Approaches in changing the milling circuits include the addition of limestone to the head-feed of the primary circuit so that the tailings developed are thoroughly mixed. This will allow the sulphide to react with the limestone, thus inhibiting the generation of acid. The beneficiation circuit can be modified and the excess sulphide floated off and stockpiled for later disposal, while « clean » tailings are deposited at the tailings disposal site.

15.10 EXERCISES

1. Explain the process that creates acidic drainage.
2. How would you inhibit oxidation and acidic production in waste piles during the operation of a mine?
3. What is the best method for controlling the generation of acid, provided that the right circumstances are available?
4. What are the environmental pros and cons of sub-aqueous disposal of tailings, both in enclosed water bodies, and in the sea?
5. Apart from subaqueous disposal what are other methods that can be used to manage acidic waste? What are the pros and cons of each method?
6. Which of the methods outlined here are best for tailings which are likely to be reused in a foreseeable period of time?
7. In the case of perpetual treatment, who should be responsible for maintaining and monitoring treatment?
8. How do climatic conditions influence the generation of acid mine drainage?
9. What are the options for the rehabilitation of disposal areas still producing AMD? Refer to earlier chapters in answering this question.

Further exercises to be developed by the trainer.

References

For further reading on this subject, the following texts are suggested. Additional references are to be found in Part IV.

- Brant, David L., Ziemkiewicz, Paul F., Svonavec, John, 1995. Anoxic Limestone Foundation Drains for AMD Control in Coal Refuse Piles. Proceedings of Sudbury '95 - Mining and the Environment, Volume 2, Sudbury, Ontario
- Dave, Nand K. And Vivyurka, Albert J., 1994. Water Cover on Acid Generating Uranium Tailings - Laboratory and Field Studies. Third International Conference on the Abatement of Acidic Drainage, Pittsburg, Pennsylvania
- Environment Australia, 1997. Managing Sulphidic Mine Wastes and Acid Drainage. Part of the Best Practice Environmental Management in Mining series.
- Girtz, M.A. and Kleinman, R.L.P., 1986. Constructed Wetlands for Treatment of Acid Mine Drainage: A Preliminary Review, 1986 National Symposium on Mining Hydrology
- Landriault, D., Tenbergen, R., Pearson, J. and McIntosh, S., 1994. Paste Backfill System Designed for Operating Hardrock Mines. S.M.E. Annual Meeting, Albuquerque, New Mexico
- Mine Environment Neutral Drainage (MEND) program, Canada.
<http://mend2000.nrcan.gc.ca/>.
- Robertson, J.D., 1991. Subaqueous Disposal of Reactive Mine Waste: An Overview of the Practice with Case Histories. Second International Conference on the Abatement of Acidic Drainage. Montreal, Quebec
- Welsh, Donald E., 1992. Mine Waste Management Practice, University of Queensland, Australia

Chapter 15

Acidic Drainage

Prepared slides for overhead projection

Acidic Drainage

- **Early planning**
- **Perpetual treatment**
- **Inhibit or reduce the rate of oxidation**
- **Removal**
- **Paste backfill**
- **Biological treatment**
- **Co-disposal of tailing and waste rock**
- **Other methods**

Chapter 16

Tailings Rehabilitation

This chapter sets the scene as far as tailings rehabilitation is concerned. More detailed advice may be found in other chapters. An important consideration is that, while it may be desirable to recover tailings at a later stage in the mining process, this should not prevent tailings from being rehabilitated in the meanwhile.

16.1 OBJECTIVES

Tailings vary greatly in their physical and chemical properties and are usually difficult to stabilise and to vegetate. Therefore, there are no common standard procedures to rehabilitate them. Either following the procedures necessary to rectify a disaster, or during a mine operation, or considering rehabilitation of a hazardous problem site, the planning of the final rehabilitation must be carefully laid out. In the case of an operating mine, however, or a planned mine, the operation and the subsequent rehabilitation should have been all pre-planned.

The design and the construction of the dam, the supervision and maintenance should be carried out by professional geotechnical engineering staff.

With ultimate decommissioning and rehabilitation in mind, tailings dams should be:

- non-polluting while they are operating, as well as after the decommissioning of the site. This may require a water treatment plant both during and following the mine operation.
- structurally stable
- as far as is possible, resistant to erosion
- progressively maintained and rehabilitated during the operation of the dam. This will inhibit erosion
- planned to have an ultimate appearance and configuration that will be visually compatible with the surrounding landscape
- planned to have an adequate capacity to cope with the quantity of tailings expected throughout the mine life
- planned in consultation with the neighbouring community, which will, after all, have to live with the dam

The location, design and operation of the dam, and the progressive rehabilitation carried out during operation, will determine how quickly after closure and decommissioning rehabilitation can be completed. The importance of progressive rehabilitation must again be stressed. Rehabilitation is far more economical if carried out while there is equipment and personnel on site to undertake it.

Acid mine drainage, slope stability and structural stability are treated elsewhere in this manual.

16.2 REHABILITATION CONSIDERATIONS

The physical and chemical characteristics of the tailings material should be available, as these will dictate the extent to which vegetation and landscaping is practicable.

There are many features which may inhibit the development of vegetation on tailings dumps, all of which must be addressed in planning and designing the rehabilitation of the structure. The following are some of the characteristics which should be taken into consideration while planning and designing the rehabilitation programme:

- Community considerations and concerns, and ability to participate in rehabilitation and long-term maintenance
- The concentration of heavy metals and salts
- Extremes of pH
- A lack of essential plant nutrients
- A lack of microbiological organisms
- Natural availability of local plant species and fauna that might enter the site
- The texture and the structural characteristics of the soil which may limit aeration and infiltration
- The availability of sub-soil and soil which may be used to remediate the site
- Local climatic conditions (rain/temperature/wind)
- Geological conditions
- Particularly in arid and semi-arid, high temperature areas, the levels of reflected light or heat absorption on dark or light tailings can cause physiological stress to vegetation
- In arid and semi-arid areas both the adjacent tailings and denuded areas will probably cause physical damage by sand blast.

Table 16.1 incorporates many of the contaminants and hazardous materials which may be found in tailings. The treatment of these contaminants is described in the chapter on chemicals, heavy metals and toxic waste.

Table 16.1. Contaminants and Hazardous Materials Commonly Found in Tailings

Base Metals	Al, As, B, Cd, Cr, Cu, Fe, Hg, Mn, Mo, Ni, Pb, and Zn
Combination of Pollutants	Thiosulphates, nitrates, hydroxides, sulphates, etc.
Reagents	CN, organic reagents, oils.
Other	Pesticides, herbicides, paints, solvents, PCBs, etc.

Acid mine drainage (acidity and radioactive tailings) which commonly produce acid mine drainage and the daughter elements such as radon are treated in the chapter on Acid Mine Drainage.

The extent to which these problems exist for any specific site have to be determined.

16.3 PHYSICAL TREATMENT OPTIONS FOR TAILINGS REHABILITATION

Acid mine drainage is treated under Chapter 15 as a separate subject, therefore, permanent solutions to treating tailings chemically contaminated leachwater is not considered in this section. However, there are many options which exist to stabilise the exposed surfaces providing they are structurally stable and chemically amenable to rehabilitation.

16.3.1 Cladding

Rock cladding, or similar protective permanent armouring, to protect against wind erosion on sites where plant growth and the amelioration of tailings is impracticable or difficult, can be carried out provided sufficient rock is available to clad the surface. Care must be taken, however, that the cladding rock itself does not contain acid forming or noxious elements which would only increase the problems of rehabilitation.

Particularly in arid areas there are many plant species which will develop in terrain that are predominately covered by stone. In fact this cladding may, in some cases, assist in the establishment of some of the vegetation. The cladding, because of its rough surface, very commonly provides small depressions in which finer material accumulate along with spores, or transported seeds and bacteria. Provided that there is sufficient moisture for the species, vegetation can develop.

16.3.2 Capping

The principal purpose of capping the tailings is to prevent access of air and water, which lead to the generation of toxic leachate. Capping is used when the leachate cannot be contained effectively or recovered by some other technique. It is necessary to ensure that the cap is sufficiently thick so that the root system that may develop does not reduce the impermeability of the cap, thus destroying the purpose of the capping.

Although capping is site-specific, depending on the availability of materials, a common example of multiple layer impermeable capping is:

- First, the reshaping of the surface to provide controlled drainage away from the centre toward the periphery of the dam. This would involve contouring and gently inclined outward dipping slopes.
- Following re-contouring, a layer of compacted clay or similar impermeable material should be laid over the tailings to provide a surface for free drainage
- The thickness of this clay layer should be from 0.75 metres to 1.0 metres thick. This addition of a synthetic impermeable membrane may also be desirable beneath this clay
- Overlaying this, is a free draining rock layer to provide positive drainage away from the centre of the structure. This layer is composed of coarse grained material which has good porosity and permeability, and should be from 0.25 meters to 0.5 meters thick
- Overlying this free draining material, a filter cloth should be laid to stop the infiltration of fine material which would ultimately clog the free draining horizon
- This filter cloth is overlain by subsoil and then topsoil, if available
- The whole structure should be at least 2 metres thick. Figure 16.1 illustrates an example of impermeable capping.

16.4 VEGETATION

The ideal solution to the rehabilitation of tailings dams is to revegetate the site. It is important to establish a diversity of vegetation, preferably native species, if possible. Avoid planting that will produce one species alone as monoculture does not usually fit well with the natural environment. The system would not be ecologically balanced and would probably fail. When planning for the species selection for the revegetation, plant propagation tests in test plots and soil tests should be carried out prior to the final decisions. Careful attention should also be given to local animal species, and the likelihood of their gaining access to the site.

Figure 16.1. The Structure of an Impermeable Cap

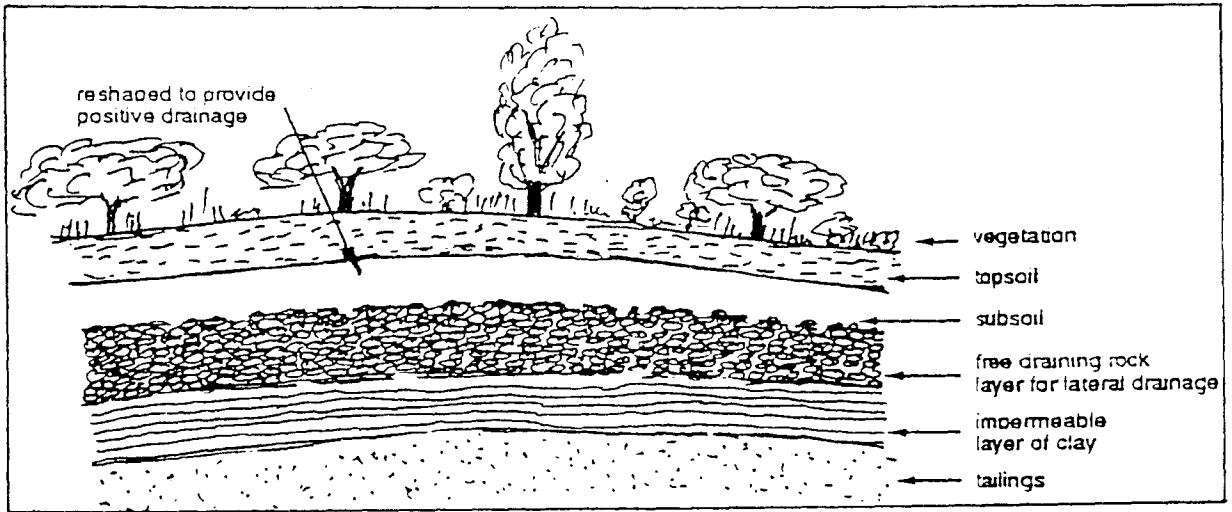

Further aspects of revegetation are included in the chapter on Amelioration and Vegetation.

16.5 EXERCISES

1. What criteria should apply to the final rehabilitation of a tailings dam?
2. Give some of the characteristics which should be taken into consideration while planning and designing a rehabilitation project.
3. What are the features (horizons) in a multiple layer impermeable capping?

Further exercises to be developed by the trainer.

References

For further reading on this subject, the following texts are suggested. Additional references are to be found in Part IV.

Environment Australia, 1995, 1997. Best Practice Environmental Management in Mining series.

- Managing Sulphidic Mine Wastes and Acid Drainage.
- Rehabilitation and Revegetation.
- Tailings Containment.

ICME/SIDA/UNEP, 1997. Proceedings of the International Workshop on Managing the Risks of Tailings Disposal.

ICOLD/UNEP, 1996. A Guide to Tailings Dams and Impoundments.

Lundgren, T., 1991. The Efficiency of Covering the Sulphitic Waste Rock in Bersbo Sweden. Second International Conference on the Abatement of Acidic Drainage. Montreal, Quebec, Canada.

Pennman, A.D.N. and Milligan, V., 1991. Longevity of Embankment Dams - Critical Review. Golder Associates, Mississauga, Ontario, Canada.

South African Bureau of Standards, 1998. Code of Practice for the Control of Mine Residue Deposits.

Stogran, S.W. and Wiseman, M.E., 1995. A Comparison of Organic and Inorganic Covers for Long Term Prevention or Amelioration of Acid Mine Drainage. Proceedings of Sudbury '95 - Mining and the Environment, Volume 2, Sudbury, Ontario, Canada.

Chapter 16

Tailings Rehabilitation

Prepared slides for overhead projection

Tailing Rehabilitation

- **Rehabilitation considerations**
- **Physical treatment options for tailings rehabilitation**
- **Vegetation**

Chapter 17

Chemicals, Heavy Metals and Toxic Mine Waste

17.1 INTRODUCTION

Mining activities use a variety of chemicals for the extraction, ore processing, water treatment and many other supporting activities. Additionally, some potentially hazardous chemicals or wastes are generated by the mining process - acid mine drainage and radioactive wastes are examples. Reference should thus be made to the chapter on acidic drainage.

Special measures are required to rehabilitate contaminated land, and reference should be made to specialist sources of information. Soil pollution may interfere with local land-use for many years. It is extremely costly to remove, certainly much more expensive than preventing the pollution in the first place. In teaching this chapter, further background material and resources may be found in the UNEP IE training resource package, "Risk Management of Contaminated Industrial Land".

Hazardous chemicals brought onto the site should be stored in secure facilities and in containers which do not deteriorate and which are suitable for the specific material. On the decommissioning of the mine and at closure, as far as possible, all unused chemicals should be returned to the suppliers or disposed of off-site at waste disposal facilities licensed to accept such materials. Some chemical wastes have to be disposed of on site, which has important implications for rehabilitation activities and post-closure use of the land.

17.2 PROCESSING CHEMICALS

Apart from the correct storage of the chemicals, a current inventory of all chemical substances used during the operation of the mine and also upon closure and rehabilitation must be kept.

It is appropriate here to examine the most common chemicals used in a mining operation. (Note that mercury is covered in a later section.)

17.2.1 Acid and Caustic Solutions

Acid and caustic solutions are used extensively for mineral processing along with other potentially hazardous materials which include oils, resins, paints, and flotation reagents

17.2.2 Cyanide

Cyanide is used in large quantities at most gold mines and is very reactive and highly toxic. Cyanide oxidises rapidly to more stable products which are fortunately non-toxic. Free cyanide is the most toxic form of cyanide. Complexed cyanide may be toxic to aquatic life and care should be taken that there is no run-off into rivers or lakes.

In disposing of cyanide, never bury cyanide tablets or powder. They may remain a potential hazard for many years if soil conditions remain dry and alkaline and there is no opportunity for oxidation. On closure, unused reagent should be returned to suppliers or returned to a licensed chemical treatment centre.

17.2.3 Flotation Agents

When processing is done properly, most flotation chemicals are absorbed on the surface of the minerals. Some may, however, remain in solution in the mill tailings. Most of the organic chemicals in solution in the tailings slurry are oxidised in the tailings ponds and are not found in the final effluent.

Holding tanks and piping for flotation chemicals should be designed to prevent spillage. As the toxicity of many flotation agents is not well known, though is thought to be low, they should be treated with respect, especially on closure of the mine. At that point, unused reagent should be returned to suppliers or returned to a licensed chemical treatment centre.

17.3 HEAVY METALS

Heavy metals on a site, which may have either been produced by the mining operation or alternatively occur naturally, may be mobilised to cause potential health and environmental problems in the overburden, in soils and in water. When acid mine drainage is detected as being present there is a high probability that there may be an abundance of heavy metals. Sulphuric acid derived from the oxidation of sulphides normally carries many heavy metals usually in fairly high quantities. As a great deal of attention is paid to the neutralisation, or the management, of acid mine drainage, which contains these metals, the neutralisation and the raising of the pH of the solution will precipitate most of these metals, most commonly as metallic salts. These salts would then become soluble and may enter the local water regime.

It is therefore, necessary to review the heavy metals which are detrimental to human, animal, plant and fish life.

17.3.1 Arsenic, Cadmium, Lead, Nickel, Manganese and Molybdenum

These metals are all potentially harmful to human life as they are bio-accumulative and relatively small dosages can seriously affect health. Also, with the addition of copper and chromium all are very detrimental to aquatic life.

17.3.2 Zinc, Lead, Aluminium, Boron and Iron

These metals may rapidly become available either in acid soils or as salts precipitated from neutralising acid solutions. They are all, to a greater or lesser extent, toxic to plant growth.

17.3.3 Mercury

Mercury is highly toxic as a liquid, a vapour and as organic complexes. It is bio-accumulative and is, therefore, a major health risk to workers who are handling it. The

detrimental effects on animals and humans are irreversible. Mercury can be absorbed through the skin, inhaled as a vapour or taken in by eating contaminated fish and drinking water.

Mercury is used extensively by small mines in some developing countries, and education of mine workers should be undertaken to inform them of its hazards and how to handle it safely.

Mercury can also cause major environmental damage to all types of animal and plant life. Residual mercury should be carefully collected and returned to the supplier. In addition, all purchases and uses of the mercury should be recorded.

17.3.4 Copper

The presence of copper is commonly toxic to most aquatic vegetation. Therefore, care must always be taken not to allow copper to enter drainage systems where there may be aquatic life. Other heavy metals, such as those listed in 17.3.1., contained in sediments, are not as soluble or as detrimental to aquatic life as is copper.

17.4 PETROLEUM PRODUCTS

The principal impact of petroleum products on the environment is in the mobilisation and maintenance areas of a mine. Very commonly these products leak or drop onto the soil, they then accumulate the soil, and if in large enough concentrations, create a toxic environment for plant and animal life.

In the past there have been two basic solutions to neutralising the impact of petroleum products. The first was to excavate contaminated soil at high expense and place it in a hazardous waste disposal site, of which there are very few, if any, in most countries.

Placing these contaminated soils in tailings ponds or waste heaps only complicates the management of their rehabilitation programme. The second method is to overlay the contaminated area by a thick layer of soil to insulate the hydrocarbons from the surface. This, however, can be a future problem as vegetation established on the overlying soil will have a root system that may ultimately penetrate through the overlay. This increases the possibility of rainwater enabling hydrocarbons to rise, and in some cases, leach out to affect surface or ground water sources.

A recently developed solution to the rehabilitation of petroleum contaminated areas is the use of bacteria. This method has been used in Ontario very successfully. It does not introduce exotic bacteria into the area but utilises highly concentrated solutions of local soil bacteria. The process is very quick acting but will probably have to be repeated several times before hydrocarbon concentrations in the soil are reduced significantly. The same technique is now being used extensively in Texas to clean up contaminated areas in oil fields.

17.5 SALTS

Salinity and alkalinity commonly occur together in arid and semi-arid soils and at mine sites highly saline concentrates often develop. In arid and semi-arid climates the upper level of saline soils commonly are less saline as a result of leaching. As mentioned under Chapter 15, the spraying or dripping of water into saline soils will improve the quality of the soil by decreasing the salinity and carrying the salt solution down the soil profile.

17.5.1 Treatment

Highly saline material can be treated in a similar way to acid mine drainage by placing a thick cap of stratified material and soils. This is the most appropriate method when the saline levels exceed 0.5% chloride.

Gypsum

One of the most effective soil structure ameliorants and treatments for salinity is the incorporation of gypsum into the soil. This can greatly improve the infiltration and the leaching of salts from the soil profile. For semi-arid and arid climates an application rate, for mildly affected soils, would be from 2.5 to 5.0 tonnes of gypsum per hectare. However, under severe conditions as much as 20 tonnes per hectare may be required.

Water Impoundments

The forming of water impoundments 30 to 40 centimetres high can enhance infiltration and the leaching of the salts. This technique has been very successfully used in agriculture. Providing the terrain is appropriate this method can be equally successful in mine site rehabilitation.

On recontoured slopes and terrain where there is an accumulation of salts, ridge ploughing to produce ridges twenty to thirty centimetres high along the contours enable a more rapidly leached root zone to be formed. Spacing of these ridges should be from one to two metres apart. Both hydroseeding and planting would be appropriate method of re-vegetation under these circumstances.

17.6 RADIOACTIVE WASTE

Radioactive wastes are derived from the mining and processing of uranium ores. Other sources of radioactive waste include contamination from radioactive sources used for monitoring purposes, and where radionuclides occur naturally with the ore being mined, such as some gold and mineral sands deposits. Radioactive wastes occur as gases, liquids and solids. There are certain characteristics which govern the choice of management procedures to be used. These are the toxicity, mobility, radioactive half-life and type of radioactive emission.

There are three basic principles employed in the disposal of radioactive waste:

- Dilution and dispersion of short-lived or very diluted radioactive wastes.
- Delay to allow decay, of very short-lived radioactive wastes, into non-radioactive species.
- Containment of long lived radioactive waste by such methods as water submersion and impervious covers.

17.7 OTHER WASTES

There are many other wastes on most mine sites, each of which need to be dealt with as appropriate. Amongst the most important are asbestos, polychlorinated biphenyls (PCBs), and lead-acid batteries.

Asbestos has been used extensively as an insulator and fire-retardant. The fibres cause lung problems and are carcinogenic. Electrical transformers manufactured prior to 1975 may have been filled with insulating oil containing PCBs. PCBs are toxic, accumulate, and are persistent in the environment. Lead has a variety of health effects, and should not be allowed to escape into the environment from batteries.

Each of these waste materials do not pose a danger unless they escapes to the environment. A procedure for dealing with them should be part of the mine's environmental management programme.

17.8 IMPLICATIONS FOR CLOSURE AND REHABILITATION

As was stated earlier, contaminated land is extremely expensive and complicated to rehabilitate. In view of this, the following considerations during the operation, closure and rehabilitation of a mine are very important:

- Wastes should not be spread over a large area, but kept in a minimum of discrete sites.
- Chemicals should be treated before disposal in well-defined sites. Contaminated soil should also either be treated and disposed of in defined sites, or sent off-site.
- The construction of disposal areas should protect against the infiltration of water, and the prevention of runoff or seepage to groundwater.
- Rehabilitation should ensure the long-term physical integrity of the site, including precautions against disturbance by trees and deep-rooted plant species.
- The area should either be made safe to permit safe after-use, or the land use should be carefully controlled to protect public safety.

17.9 EXERCISES

1. What are the implications of this chapter for monitoring programmes?

2. Which government department(s) and/or institutes should be consulted concerning acceptable contaminant levels in land being rehabilitated?
3. What rehabilitation considerations are important when stabilising cyanide-containing tailings deposits?
4. Briefly describe the environmental impacts that may be expected from contaminated land.
5. Find the concentration levels of those metals which are partially toxic to plant life. How does this affect revegetation efforts? What retreatment methods can be used to counter these toxicity effects?
6. Discuss the rehabilitation options for land contaminated by mercury from artisanal mining operations.
7. In view of the long-term persistence of many contaminants, what are the implications for rehabilitation and land after-use?

Further exercises to be developed by the trainer.

References

For further reading on this subject; the following texts are suggested. Additional references are to be found in Part IV.

British Medical Association, 1991. *Hazardous Waste and Human Health*, Oxford University Press, Oxford, UK.

Duffus, J.H., 1983. *Environmental Toxicology*, Edward Arnold, London, UK.

Environment Australia, 1997. *Hazardous Materials, Management, Storage and Disposal*. Part of the *Best Practice Environmental Management in Mining* series.

International Programme on Chemical Safety, ongoing since 1973. *Environmental Health Criteria*. These publications cover a wide range of elements and chemical compounds.

International Programme on Chemical Safety and Commission of the European Communities, 6 series, 1990 - 1991. *International Chemical Safety Cards*. Similar to the previous reference, but these cards give environmental, health and safety information in a condensed format.

International Programme on Chemical Safety (IPCS). *Concise International Chemical Assessment Document* series. A series of separate books for individual chemicals or classes of compounds.

UNEP IE, 1996. Risk Management of Contaminated Industrial Land. Training Resource Package.

UNEP IE, 1993. Managing Contaminated Land. Industry and the Environment, Vol. 16, No. 3.

UNEP IE/ILO, 1991. Environmental Aspects of Selected Non-ferrous Metals (Cu, Ni, Pb, Zn, Au) Ore Mining.

WHO (1993) Guidelines for Drinking-water Quality. Second Edition. Volume 1 - Recommendations. WHO, Geneva, Switzerland. ISBN 92-4-154460-0.

WHO (1996) Guidelines for Drinking-water Quality. Second Edition. Volume 2 - Health Criteria and Other Supporting Information. WHO, Geneva, Switzerland. ISBN 92-4-154480-5.

WHO (1997) Guidelines for Drinking-water Quality. Second Edition. Volume 3 - Surveillance and Control of Community Supplies. WHO, Geneva, Switzerland. ISBN 92-4-154503-8.

Chapter 17

Chemicals, Heavy Metals and Toxic Mine Waste

Prepared slides for overhead projection

Chemicals, Heavy Metals and Toxic Mine Waste

- **Processing chemicals**
- **Heavy metals**
- **Petroleum products**
- **Salts**
- **Radioactive waste**
- **Other wastes**
- **Implications for closure and rehabilitation**

Chapter 18

Adits and Shafts

18.1 INTRODUCTION

It is essential to secure all openings to the surface. These openings include adits, shafts, unstable ground and settling and collapsing surfaces. The principal objective is to prevent access by minimising the number of openings to the surface. Methods utilised are the plugging or sealing of openings where possible and economical, backfilling open pits where practicable and by stabilising the ground where feasible.

Before sealing off a shaft or an adit, consideration should be given to the possible need for future underground access particularly when no other workings exist in the area. Therefore, whenever possible obtain all information on the extent and design of the workings and the geological data and conditions. These data should be stored either with the proprietor company if active or, alternatively, if inactive or abandoned, with a government agency so that other people may have access to these data in the future. In addition, all information relative to the safety of the site should be easily available to the public or any interested party, especially when there is the possibility of mine gas, toxic water or acid water.

In arid or semi-arid areas in particular, it might be prudent to check the quality of the water for human consumption. If the mine begins to flood and the water is potable, the site may also represent a good source of water.

18.2 METHODS OF SECURING AND SEALING OPENINGS

The selection of the technique for securing openings will be dependent on the type of opening. In the case of settlement or crown pillar failure the cause and configuration of the cavity will indicate the method used. In many cases adits and shafts cannot be immediately sealed. If this is the situation it is necessary to install a safety fence and to seal off the area as best as possible. This safety enclosure should be monitored and maintained until such a time as the opening has been permanently sealed.

18.2.1 Surface Covers and Caps

Covers will help prevent unauthorised or accidental access and illegal dumping. The cover should be of such a structure, when permanent, that it will not fail or collapse on loading. Concrete caps on shafts should rise above the ground level to avoid accidental loading and should be constructed with reinforced concrete supported around the collar of the shaft by solid unweathered bedrock. Covers should be sufficiently large to prevent burrowing around the sides by illegal entrants. It is not recommended that heavy steel plates be used, as these can be easily removed.

18.2.2 Backfilling

Providing there is sufficient material, that is considered clean, backfilling is the simplest and most economical method of sealing a shaft. It is also dependent on the depth and diameter of the shaft. Before carrying this out the base of the shaft should be stabilised. Clean, hard, free draining rock should be used and the shaft filled to a depth of at least five

times the diameter of shaft with this material. This is to provide a free flow of subsurface water should there be a need.

Abandoned shafts should not be used as disposal sites for rubbish, chemical residues or any substance that will react with the water and contaminate the ground water or the water regime in the area.

18.2.3 Shaft and Adit Plugs

The common denominator in the installing of a plug is that all of the concrete should from one continual pour if possible, otherwise, interfaces will develop which could form lines of weaknesses in the plug and thus accelerate its deterioration.

Shaft Plugs

Shaft plugs should be constructed below the level of weathered bedrock and even though plugged with concrete should still be capped and backfilled. The plugs need to be water tight and designed to accommodate the permeability, elasticity and compressive forces of the adjoining bedrock and/or the accumulated water. It is essential that a shaft plug be properly designed and put in place by a competent professional engineer. Figure 18.1 illustrates the placement of a shaft plug.

Adit Plugs

Adit plugs should be a concrete continuous pour and ideally should be anchored into the adjacent wall-rock or bedrock. Prior to installing the audit plugs a detailed survey of the ground conditions should be made and any loose or highly altered wall rock removed. If the altered rock is extensive another location for the plug should be found. Examples of two types of adit plugs shown in Figure 18.2 and Figure 18.3.

Even though adit plugs have been placed it is prudent to collapse or cave entrance for safety measures and to allow for ease of landscaping in rehabilitation.

18.3 CROWN PILLARS

As crown pillars represent one of the greatest potential hazards to the public in the future, additional efforts should be made to record and make available all data pertaining to crown pillars. This should include the location, the thickness, the size and the shape of the pillar. In addition its depth below the ground surface and the composition and depth of overlying materials should be recorded. Also, information on the overlying geology and soils, any man-made support, and the location of nearby buildings and other structures should be included.

It is not always possible to stabilise an area underlain by a crown pillar. Many attempts have been made to stabilise the underlying excavation by pouring gravel, sand and rock into the cavity, but in most cases, unless the volume of the cavity is known, this is a

futile task. Furthermore, if the fill is too fine it can easily be washed away or eroded by groundwater.

18.4 EXERCISES

1. Sketch the features of plugging a shaft.
2. Sketch one example of an adit plug.

Further exercises to be developed by the trainer.

References

For further reading on this subject, the following texts are suggested. Additional references are to be found in Part IV.

Hustrulid, W.H. (Ed), 1982. *Underground Mining Methods Handbook*. Society of Mining Engineers, New York, USA

National Coal Board Production Dept., 1975. « *Subsidence Engineers' Handbook* » 2nd (revised) Edition, London, UK

Peng S.S. and Harthill, M., 1981. *Workshop on Surface Subsidence Due to Underground Mining*

Figure 18.1. Shaft Plug

This figure illustrates the placing of the shaft plug, the backfill and the shaft cap anchored into the unweathered bed rock.

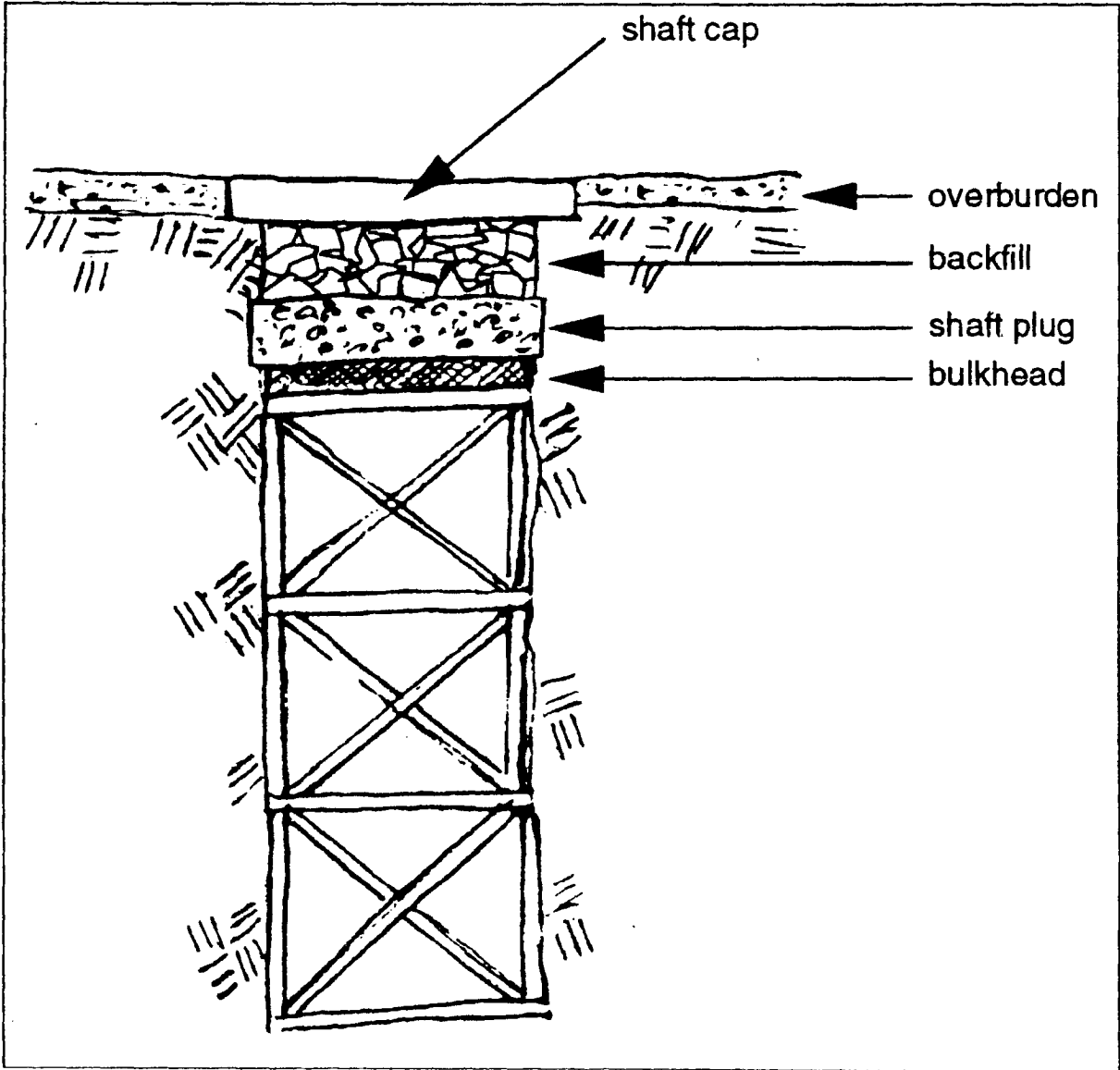

Figure 18.2. Adit Plug

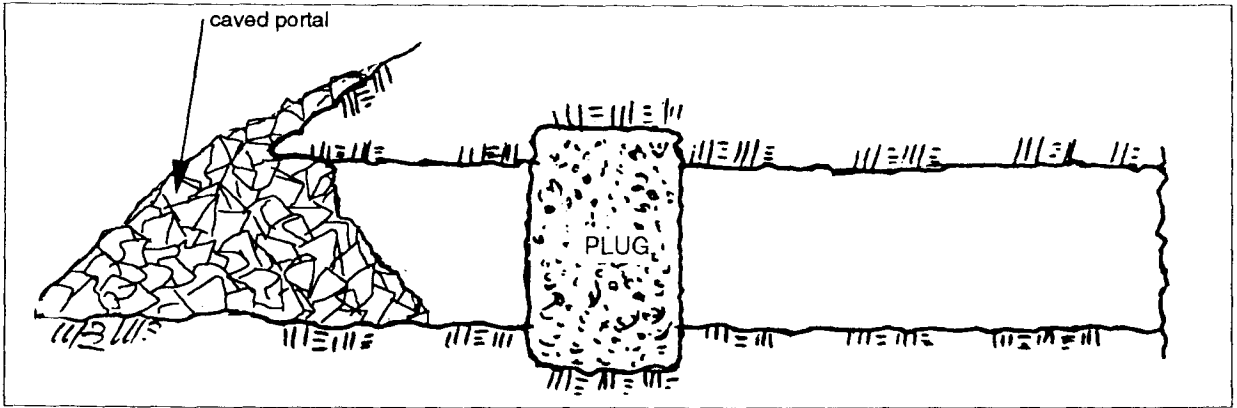
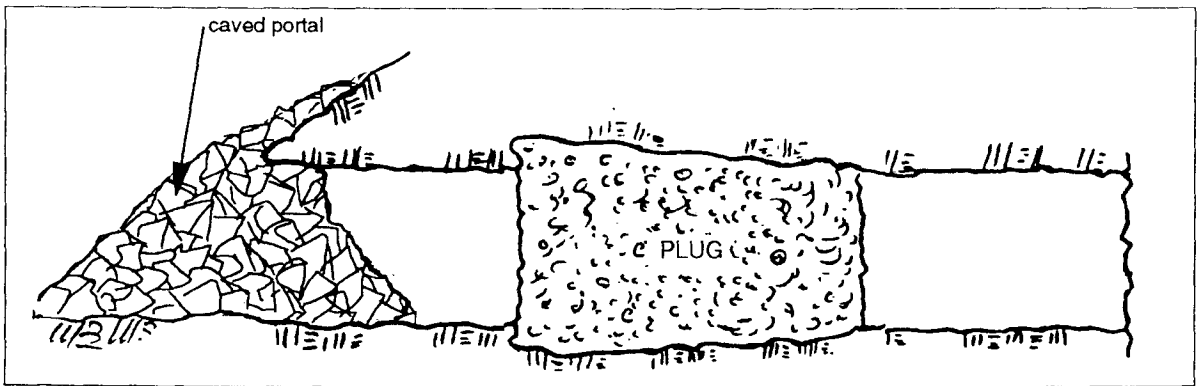

Figure 18.3. Configuration of a Tapered Plug



Chapter 18

Adits and Shafts

Prepared slides for overhead projection

Adits and Shafts

- **Methods of securing and sealing openings**
- **Crown pillars**

Chapter 19

Buildings and Infrastructure

19.1 INTRODUCTION

The rehabilitation of buildings, roads, power lines and other infrastructure should form part of the initial operating plan and as such can become part of the progressive rehabilitation programme.

19.2 BUILDINGS

Depending on the anticipated mine life, buildings may be constructed to last a few years or several decades.

19.2.1 Short Term Structures

Those buildings which are designed for short term use should preferably be prefabricated buildings which are easily dismantled and removed at the time of decommissioning and closure. Short term structures should be totally removed from the site during rehabilitation. They may also be placed in an approved disposal location or site such as in deep trenches or in open pits. The materials should be of such a nature that they will not contaminate the ground water regime and should be completely covered and the area vegetated.

As an alternative the temporary prefabricated structures can be dismantled and the bulk of the materials removed from the site. As with permanent structures, if there are concrete pads or permanent structures, they should be broken up, and removed and buried in an appropriate disposal site.

19.2.2 Long Term Structures

It may be feasible to put these buildings to other uses after closure. This would depend on their location and their previous use. If of no other use, they should be dismantled, the materials either shipped off-site or buried in approved disposal sites. Like the short term structures, concrete pads, pillars and walls should be demolished and deposited or buried. The site should then be ripped or scarified and revegetated.

19.3 POWER LINES

Unless there is a government requirement that they should be left in place, power lines should be incorporated into the original operating plan with a view to ultimate rehabilitation. During the planning stage and the subsequent construction, excavation and the clearing of vegetation should be kept to a minimum. If surface access is necessary, where possible, much of the vegetation should remain undisturbed so as to encourage rapid re-vegetation of the access routes.

Ensure that at the time of decommissioning, all cables, towers and guys are removed and that concrete slabs and footings are broken up and buried in an appropriate disposal site.

The technique that has been used with considerable success in Canada has been the use of helicopters for the installation of power lines. As a result no roads or tracks were necessary and no major route construction was needed to put the towers in place. Helicopters have also been used for the decommissioning of the sites, all the materials were removed by helicopters and the subsequent abandoned site revegetated by seeding from the air.

If access routes or trails were necessary for the construction programme or for the de-commissioning, these should be ripped and reseeded.

19.4 ROADS

Roads and tracks can have a significant impact on the local terrain. Their design and the construction of the roads must be part of the initial plan, with a view to their subsequent rehabilitation. In arid and semi-arid areas, where vegetation is sparse, the design of the road should be planned so that it avoids as much as possible disturbing the vegetation and the landscape features. In addition, if feasible, reduce the line-of-site or critical view impact by introducing gentle curves. In the operating plan, roads should fit the topography so as to keep to a minimum unnecessary earth moving for road cuttings and earth embankments. Avoid water courses and steep side-slopes, where gullying may become a problem. There is a temptation in arid and semi-arid terrain to start parallel roads or tracks if the original road becomes difficult to negotiate. Management should endeavour to prevent this and should know the penalties that may be imposed for this form of environmental damage.

In arid and semi-arid climates, where rainfall is heavy and intermittent, drainage in flat-lying areas is by sheet flow. It is important, therefore that in the construction of the roads, provision for the passage of run-off onto and from roads be made, without causing serious erosion. In areas that contain slopes, the drainage from up-slope should be diverted and the discharge from the road or track controlled so that the water does not cross the road. Avoid gullying and erosion. Drainage from the road should be dissipated from the surface of the road by out sloping the camber and providing side drains or flat drains. At discharge points of these drains protection must be provided to avoid unnecessary erosion.

The ripping, to loosen the compaction prior to seeding and the spreading of topsoil, will serve to discourage unauthorised access and will facilitate revegetation. Where construction of the road has been by cut and fill, and there is the potential for unstable slopes, the area should be re-contoured using the fill material that was used in the original construction of the road.

Properly designed roads that are to be left should be basically stable. Where barriers are necessary, gates, fences, large rocks or heaps of ground should be constructed and should have an appearance compatible with the surrounding landscape. All culverts and drains should be removed and as much of the original drainage as possible re-established.

Ensure that the rehabilitation is well planned and that the progress of the rehabilitation is such that rehabilitation equipment, such as earth moving equipment, hydroseeders and land maintenance equipment can access the work areas before routes are destroyed or cut off.

Prior to rehabilitation, management should ensure who will continue to maintain permanent roads once the mine has been closed.

19.5 EXERCISES

1. Consider the policy implications of burying construction debris and equipment.
2. What chemical contamination is likely to be associated with different types of building infrastructure?
3. How much of the rehabilitation programme can be implemented progressively during the operational stage of the mine?

Further exercises to be developed by the trainer.

Chapter 19

Buildings and Infrastructure

Prepared slides for overhead projection

Buildings and Infrastructure

- **Buildings**
- **Power lines**
- **Roads**

Part III

Representative Case Studies in the Country of “Udanax”

Chapter 20

The Country Context

The case studies presented here relate to the mining problems of a fictitious country – Udanax*. They have been designed to complement the main body of the training manual by creating a scenario that illustrates many of the problems that will need to be solved by users of the manual. Trainers and trainees are encouraged to think freely in a situation where they are not constrained by the practical problems that bedevil rehabilitation, such as financial, political and time constraints. Having said this, these case studies are intended to prepare trainees to work in real-life situations. There is plenty of room to expand the case studies, and trainers are encouraged to develop the scenario further and prepare additional exercises, especially to bring out issues and topics of particular concern and interest to trainees.

20.1 INTRODUCTION

The situation in Udanax is as follows: Consciousness of environmental abuse and pollution has been growing steadily in the country. However, there is still relatively little reliable documentation, and opinion is divided over how serious the issues really are.

There have been some attempts by authorities to control all types of pollution, but they have not been systematic, and results have not been satisfactory in all instances.

There is a growing conservation movement in the country and a keen interest in restoring disturbed lands.

Of particular concern have been the highly impacted disturbed land that has come about as a result of past mining practices. The present operating mining companies have been told that they now have to conform to new mining legislation. This law (known as the « Mining Act ») not only includes a requirement for a rehabilitation plan for ultimate closure but also that progressive rehabilitation needs to be undertaken on the presently operating properties. For those mines which have not as yet gone into operation, there is the requirement to have an operating plan and rehabilitation plan approved before they go into production.

Prime Minister Albuk Nahk has been made aware that many abandoned mining structures are collapsing, and are hazards to the population. Also, the Prime Minister, through his Ministry of International Affairs, has been told that the continuing export of the country's "dirty" minerals is under scrutiny. Some multinational manufacturing companies are becoming conscious of maintaining their own environmental image and will eventually cease to purchase metal products from countries with irresponsible environmental practices.

Owing to these concerns, the Prime Minister commissioned a task force headed by a Deputy Minister to investigate the situation and provide recommendations. The task force comprised representatives from the Ministries of the Environment, Mining, Agriculture, Health, Labour, Industry, Transport and Energy. The mining and manufacturing industries, conservation groups, environmental groups and the general public made submissions to the task force.

- The details of the country of Udamax are an extension of those given in “Hazardous Waste : Policies and Strategies”, UNEP 1994
- The task force recommended that a new mining law be drawn up as soon as possible to address three prime factors: first, the health and safety of the population; second, the environment; and third, ultimate land use. The legislation was to give much broader powers to the relevant government officials and would complement existing legislation covering the environment, occupational health and safety, air, water and transport.

20.2 NATIONAL PROFILE

20.2.1 Geographical

Area:	700,000 km ² ; 1100 km of coastline
Terrain:	undulating to flat, with higher elevations to the south
Climate:	temperate to hot
Rainfall:	Monsoonal: dry for 8 months, wet for 4 months
Population:	20 million, six cities with a population above 200,000 8% of the population belongs to poor minority groups.

20.2.2 Resources and Urban Services

Minerals and Energy:	substantial minerals, oil, gas, coal, though little detailed exploration carried out
Agricultural Land:	moderate productivity and diverse, extensive irrigation along the Udanax, Xan, Isos, Pantum and Yeo Rivers
Water Supply:	limited surface and groundwater
Transport:	good network between major towns and cities
GDP:	144 000 million pesos, 7200 pesos (US\$ 1800) per person (see Table 20.1)

20.2.3 Economics and Industry

Energy and resource based, with heavy industry, some light manufacturing, and service industries represented. Extensive trade and commerce with foreign countries.

Agriculture is predominantly in the centre and north of the country, with many export crops based on irrigated production of fruit, vegetables and livestock. Fisheries are an export industry with plentiful stocks in the Sea of Udan. Some over-fishing is occurring in the Bay of Naxis.

Mining represents 7.9% of the GDP, and the export of refined metal is a major source of foreign currency. The fabrication of metal products is being promoted by the government in order to expand the economy by extracting greater value from the country's natural resources.

Most manufacturing activity is concentrated in the three main towns (Udanax City, Port O’Cobo and Sonax). Petroleum production and refining is primarily in the dry interior of the country around Daxon. Agriculture is mostly near the coastal strip, and along the main river valleys where irrigation water is available. Mining operations are spread throughout the country with operations in both the temperate and the arid to semi-arid zones (Figure 20.1).

Industry output is shown in Table 20.1, employment is shown in Table 20.2 and total mineral production in Table 20.3. These data were supplied by the Ministry of Industry and the Ministry of Employment. Table 20.4 shows the pro rata apportionment of the mineral production which was achieved by the five leading mining companies in Udanax. The listing that follows contains some information about the owners of each mine, the location of the mines (see also Figure 20.1), their expected reserves and their working history:

Table 20.1. Main Origins of Gross Domestic Produce (in million Pesos)

Agriculture	11,823
Building & Public Works	18,198
Communications	886
Hydrocarbons	48,191
Industry	14,574
Mining	11,399
Other Branches	9,816
Services	5,436
Trade	16,876
Transport	6,504
GDP	143,703

Exchange Rate 4 Udanax Pesos = 1 US Dollar

Figure 20.1. Map of Udanax

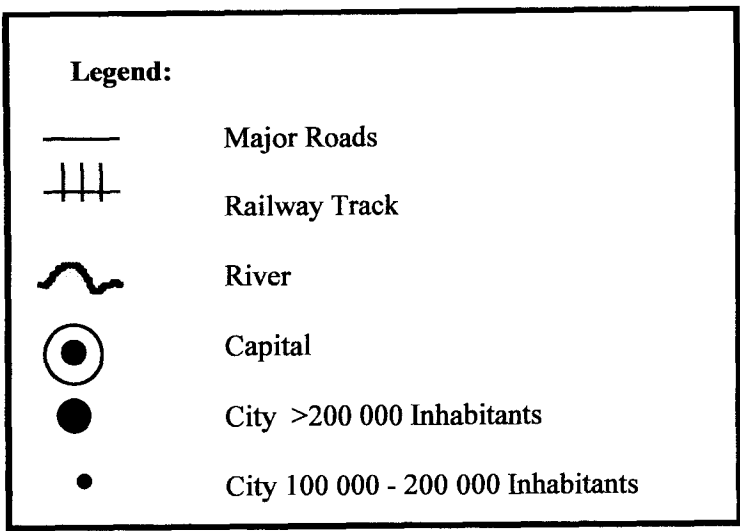
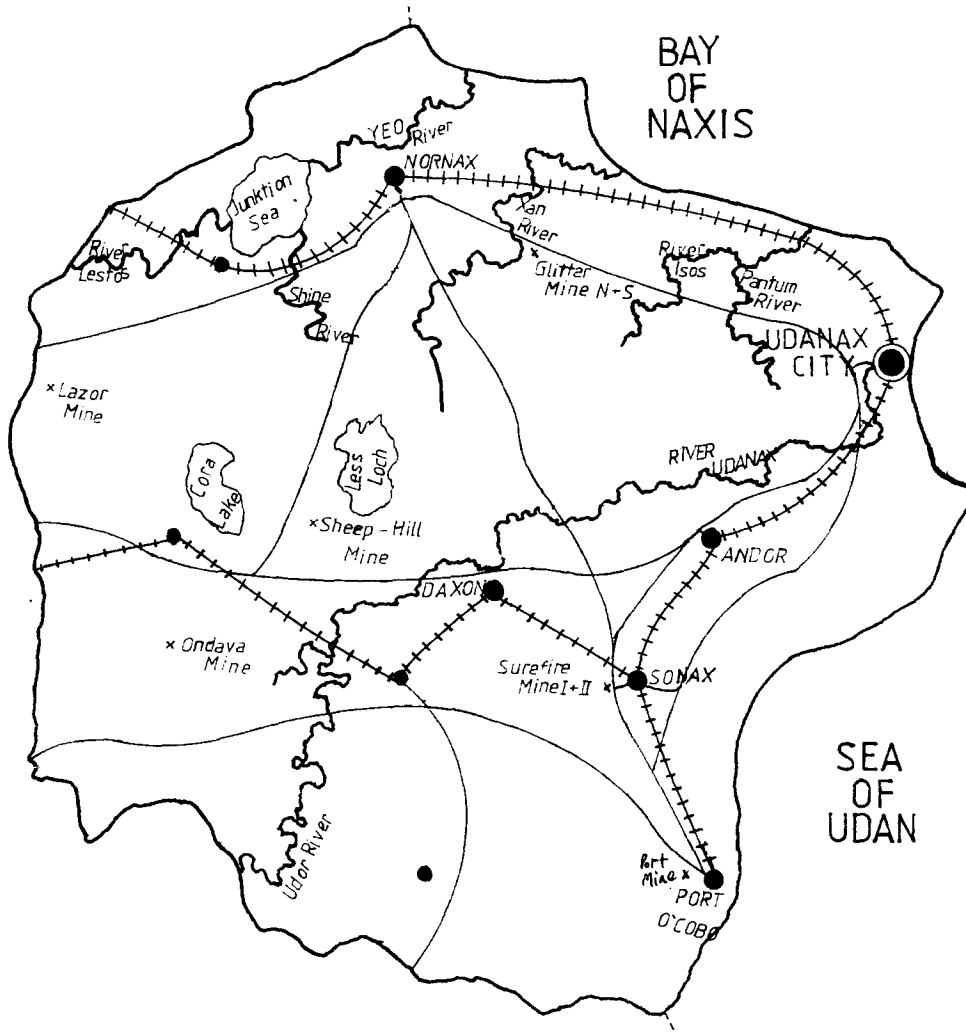

Table 20.2. Structure of Employment

% OF TOTAL	
Agriculture & Fishing	40.1
Commerce	11.1
Construction	2.9
Electricity, Gas, Water	0.3
Government, Community, Social and Personal Services	29.9
Manufacturing	10.2
Petroleum, Mining & Quarrying	1.9
Transport	3.6
TOTAL	100.0

Table 20.3. Mineral Production Per Annum

Copper, kg	2,662,740
Gold, g	1,265,530
Lead, kg	952,240
Silver, kg	2,950
Zinc, kg	2,210,520
Iron ore, tonnes	1,920,000
Potash, tonnes	70,120
Salt, tonnes	115,850

Table 20.4. Mineral Production Split by Company

Company	Copper (kg)	Gold (g)	Silver (kg)	Lead (kg)	Zinc (kg)	Iron Ore (t)
Exploration Ltd.				952 240	2 210 520	
Ondava Mining Co.	2 662 740		2 950			
Int. Overseas Inc.		765 330				
Harpers Iron Ltd.						956 000
Paddington Mining		500 200				876 000
Total	2 662 740	1 265 530	2 950	952 240	2 210 520	1 920 000

Exploration Ltd.

- International consortium with mines across the world
- Owner of the Glitter Mine North and South
- Located approximately 150 km south-east of Nornax in northern Udanax
- Active since 1950
- Glitter Mine North abandoned since 1980
- Glitter Mine South was opened in 1979
- Expected reserves for Glitter Mine South:
⇒ lead: 1 004 480 kg
⇒ zinc: 4 421 040 kg
- Surface area of mining: 2.4 km²

Ondava Mining Co.

- Government owned mining company, based in Udanax City
- Owner of the Ondava Mine
- Ondava Mine is located 100 km to the south of Cora Lake
- Active since 1984
- Expected reserves:
⇒ copper: 15 966 440 kg
⇒ silver: 17 700 000 kg
- Surface area of mining: 1.1 km²

International Overseas Ltd.

- International company specialised in gold and silver exploration
- Owner of Surefire I and II
- Located on the outskirts of Sonax
- Surefire I was closed in 1972
- Surefire II used since 1970
- Expected reserves for Surefire II:
⇒ gold: 5 358 710g
- Surface area of mining: 1.92 km² - Surefire I and 1.6 km² - Surefire II

Harpers Iron Ltd.

- Partly owned by the government, located in Sonax
- Owner of Lazor Mine
- Located close to the western border
- Active since 1981
- Expected reserves:
⇒ iron ore: 4 780 000 tonnes
- Surface area of mining: 0.96 km²

Paddington Mining

- Private company located in London, UK
- Owner of Sheep Hill and Port Mines
- Port Mine is located on the outskirts of Port O’Cobo
- Active from 1950 to 1958. Reopened in 1997
- Expected reserves:
⇒ gold ore: 10 128 000 g
- Surface area of mining: 0.5 km²
- Sheep Hill Mine is located 20 km to the south-west of Less Loch
- Active since 1979
- Expected reserves:
⇒ iron ore: 13 064 000 tonnes
- Surface area of mining: 1.47 km²

20.2.4 Administration

Government

Udanax has a constitutional monarchy with a prime minister and parliament. There are four provinces with governors and provincial parliaments; and 31 local government authorities. Many national regulations, including air and water quality standards, are enforced by local government officials.

Administration

The national government has thirteen ministries comprising development, industry, mining, health, labour, defence, environment, energy, transport, agriculture, finance, foreign affairs and internal affairs. Many ministries have provincial offices to implement procedures and regulations in the field.

20.2.5 Technical Services

Udanax has three universities (The National University of Udanax at Andor, Nornax Agricultural University, and Technology and Marine College at Port O’Cobo) and their research teams are interested in marine pollution, mine rehabilitation and climate and environment change. Engineering departments occasionally help industries with production problems. Several engineering consultants have offices in the country. They have been mostly involved in mineral exploration, development and rehabilitation, and in plant design and operation.

20.2.6 Environment

The Ministry of Environment is responsible for enforcing the environmental legislation and regulations. Regional offices are responsible for matters which are not of national or international importance, and local authorities take care of water and air quality, waste disposal and land use decisions within their jurisdictions. Emission standards are set nationally, but lower level authorities may set higher standards if they choose. EIAs must be carried out for all significant projects, with the Minister having the final say in a dispute. The government is very concerned to raise the standard of living within the country, and thus the Ministries of Development and the Environment have quite a stormy relationship.

Background data which is useful when judging the sensitivity of the ecology of Udanax to chemical pollution is shown in Table 20.5. Information concerning the vegetation in Udanax is given in Tables 20.6 - 8. Since Udanax is an imaginary country, any resemblance between the flora names and the names of flora in other countries is entirely coincidental.

20.2.7 Mining Legislation

As a result of the recommendations of the Prime Minister’s task force on disturbed mining land and mining operations, the Ministries of Mining and Environment prepared jointly new mining legislation that includes stronger requirements for environment protection, including rehabilitation. The new law will apply to developing, operating and abandoned mines. The draft legislation has been discussed with various government ministries, the mining industry, conservation groups, other industries, the agricultural sector and representatives from the provinces. The mining legislation will apply in parallel to existing environmental regulations on water and air pollution, and on EIA for mining projects.

Table 20.5. Environmental Sensitivity: Udanax

Coastline	1100 km
Estuaries	250,000 ha
Agricultural Land	200,000 km
% Irrigated	10% i.e. 2,000 km
Ground Water Quality	Mostly good, but some aquifers are beginning to deteriorate as a result of mining and other industries
Surface Water Quality	Some waters close to heavy industry and mining are already polluted
Marine Water Quality	Polluted near harbours; otherwise OK
Industry Adjacent To - Urban Areas	Yes, light & heavy industry & mining
Agricultural Land	Yes, mining & some heavy industry
Coastline, Wetlands	Yes, smelters, refineries, mining and heavy industry
Transport Through Urban Areas	Yes
Important National Species Of - Land Animals	No
Migratory Birds	Yes
Fish & Other Marine Species	Yes, including some rare species

SOURCE: Department of Biology, National University of Udanax

Table 20.6. Shrubs in Udanax

SPECIES	MOISTURE	FERTILITY
Grey Dogwood	Dry to Mesic	Medium
Pussy Willow	Wet	Low to Medium
Red-Osier Dogwood	Moist to Wet	Low to High
Speckled Alder	Moist to Wet	Low
Common Juniper	Dry	Low to Medium
Alder	Wet to Mesic	Low
Choke Cherry	Dry to Mesic	Medium to High
Nannyberry	Moist to Wet	Medium
Highbush Cranberry	Moist to Wet	Medium to High
Sumac	Dry	Low to Medium
Hawthorns	Dry to Mesic	Medium to High
Raspberry	Dry to Mesic	Low to High
Currant	Mesic	Medium to High

Table 20.7. Forbs in Udanax

SPECIES	MOISTURE	FERTILITY
Clover	Dry to Mesic	Low to Medium
Birdsfoot Trefoil	Dry to Mesic	Low
Strawberry	Dry to Mesic	Medium
Canada Blue Grass	Wet to Moist	Medium
Tall Fescue	Dry to Mesic	Low
Creeping Red Fescue	Dry to Mesic	Low
Millet	Dry to Mesic	Low
Bent Grasses	Dry to Moist	Low to Medium
Wild Rye	Dry to Moist	Low to High
Rye Grain	Dry to Mesic	Low
Alsike Clover	Dry to Mesic	Low to medium
Timothy	Dry to Mesic	Low to Medium

Table 20.8. Trees in Udanax

SPECIES	MOISTURE	FERTILITY
Red Maple	Moist to Wet	Medium
Black Locust	Mesic to Dry	Low
Balsam Poplar	Dry to Wet	Low to High
White Birch	Mesic	Low
Trembling Aspen	Dry to Moist	Low to Medium
Eastern Red Cedar	Dry	Low to Medium
Tamarack	Moist to Wet	Medium to High
White Spruce	Moist to Wet	Low to Medium
Black Spruce	Moist to Wet	Medium
White Pine	Dry to Mesic	Low to Medium
Jack Pine	Dry	Low
Red Pine	Mesic to Dry	Low to Medium
White Cedar	Dry to Wet	Low to Medium
Red Cedar	Dry to Mesic	Low to Medium

Note: "mesic" means "moderate".

After OMNR 1988

The Legislation

As regards site rehabilitation, the draft legislation requires the following:

- Preliminary Study prior to any major disturbance by mining activities of the land/water base. Major disturbance in advanced exploration is defined as removal of 500 tonnes or stripping of more than 2,500 square meters.
- If the mine goes to production, an Operating Plan must be prepared and adhered to.
- Before mine development or production can begin, a Rehabilitation Plan must be submitted by the company and approved by the Director of Rehabilitation in the Ministry of Mining.
- Prior to approval, the Rehabilitation Plan has to go to public review, and be endorsed by the Ministries of Environment, Labour and Mining.
- The company must undertake progressive rehabilitation in accordance with the Rehabilitation Plan unless for technical reasons the Director has approved an exception.
- An annual review of progress of safety of tailings dams and dump sites, and of rehabilitation is required by the Ministry of Mines.
- The plan may be amended at any time but must obtain approval for any changes from the Director, in consultation with the Ministries of Environment and Labour.
- If a company contravenes the Act it is subject to a fine of up to 120,000 pesos per day while in contravention
- Where significant land is disturbed, a security deposit fund is required, and it is held by the government. The funds can be used by the government to ensure that the site is appropriately rehabilitated should the operator default in the rehabilitation for whatever reason. If there are funds remaining after successful completion of the rehabilitation, they will be returned to the operator with accrued interest.
- For the owner of an abandoned mine, the same rehabilitation planning is required under the same conditions as an operating or closed-out mine. If an owner cannot be found, the property becomes the obligation of the state, which may either confiscate the site or place a lien against the property for the cost of the work done to rehabilitate it.

20.3 EXERCISES

1. Discuss the priority that mine site rehabilitation probably has in the minds of:
 - politicians
 - mining industry managers
 - local people near mines
 - inhabitants of Udanax City
2. Discuss, from your own background knowledge, the importance that public involvement and administrative transparency has in development decisions in Udanax. How will this affect the rehabilitation of individual properties?
3. Where in Udanax would be located the information, expertise and knowledge that is required for site rehabilitation? Prepare a list of such support services, and discuss how capacity could be strengthened in order to provide a better service to the entire mining sector.
4. There is no mining industry forum in Udanax where a common approach or policy on rehabilitation can be discussed by companies. Discuss how to create such a forum. Prepare a draft policy by the forum on rehabilitation, including abandoned sites.
5. On which mining sites in Udanax could cyanide contamination be expected?
6. Which of the mines are likely to require tailing dams?
7. What possible impacts on occupational health may be caused by the exploration of minerals by the companies already present in Udanax?
8. Do the environmental impacts caused by each of the mining companies differ from one another? Explain in which cases and how they differ.
9. Discuss the different expenditures for site rehabilitation that may be necessary for each company.
10. Review critically the draft legislation proposed by the task force from the point of view of:
 - effectiveness in achieving satisfactory rehabilitation
 - administrative burden to the government
 - cost of compliance
 - public participation
11. Discuss how the legislation should be implemented in the field.
12. Discuss and proposed the criteria or conditions under which the proposed security deposit will be refunded in full.

Further exercises to be developed by the trainer.

Chapter 21

Surefire Mine Tailings Site I

21.1 BACKGROUND

The Surefire mine is on the outskirts of the town of Sonax in southern Udanax. The disused tailings impoundment is 22 metres high with a slope inclination of from 1.5H:1V to 2H:1V, and overlooks two settlements which together contain 250 residences. The nearest houses are less than 80 metres from the base of the slope.

Between 1912 and 1972, 58 million tonnes of tailings were deposited over an area of 192 hectares. The area surrounding the tailings is flat and there was no habitation in the immediate vicinity during the operation of the mine (Figure 21.1).

From preliminary examination it has been determined that the dam was built by the upstream method with spigotted tailings which were not controlled by any design criteria, thus producing a loosely packed mixed grain size material.

Figure 21.1. Location of Tailings Relative to Housing

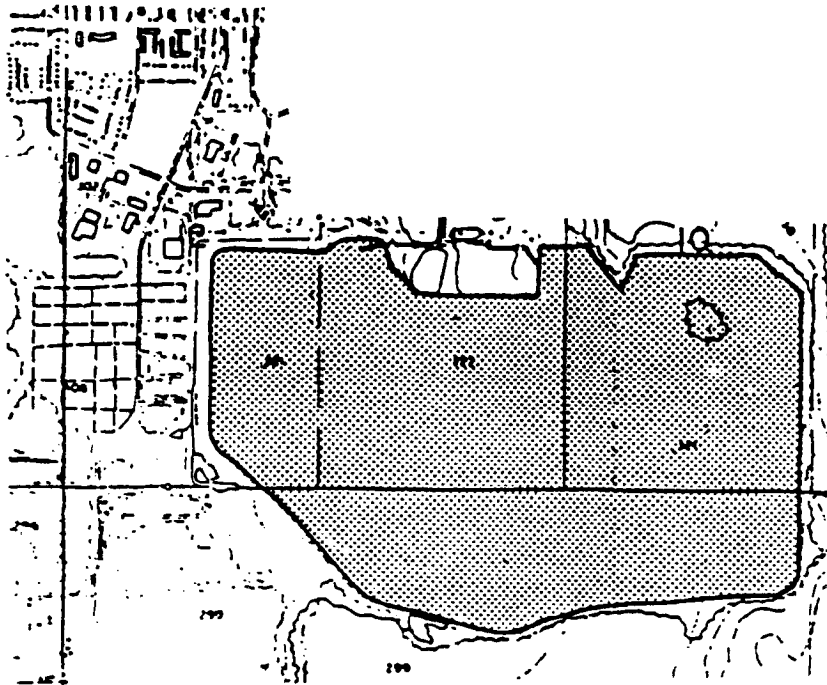

21.2 TAILINGS DAM

There is water seeping from the toe of the slopes and sand boils near the toe are common. This seepage combined with internal piping and the surface runoff has caused the formation of deep gullies and rotational slips on the slope. The gullies extend to roughly half of the dam elevation and are progressing to the crest. There is a marshy, swampy area at the base of the dam, with numerous tamarack trees, separating the site from the residences.

There is also evidence of buried timbers within the dam. These timbers act as pathways for water and weaken the structure. This provides further evidence that there was little thought in the planning and operation of the structure. The decant towers once used to drain the tailings pond have been blocked for a long time. There are no spillways to drain the ponded waters on the upper surface of the dam. These ponds recharge the phreatic level within the tailings, and further act to destabilise the dam.

In addition, there are many longitudinal and transverse cracks on the top near the crest of the dam as well as some slumping along the perimeter of the dam.

Another problem is that many of the local children play on the slopes, despite warning signs and attempts to fence the site. In rehabilitation efforts, this must also be taken into consideration.

21.3 TAILINGS SURFACE REHABILITATION

The situation at the site is clearly very serious. Once the most serious problems have been addressed, it will be necessary to rehabilitate the tailings impoundment. The following information is relevant to that task.

With the removal of the ponds from the surface of the tailings, except for two swampy, marshy areas, it is also necessary to contour and vegetate the upper surface and the slopes. The flatter slopes will reduce the flow velocities of surface runoff thus reducing erosion and gulying effects. To ensure the long term stability of the perimeter slopes and their suitability for the establishment of vegetation, it will be necessary to landscape the steeper parts. An analysis of the tailings on top of the disposal site and on the slopes shows that there is very little nutrition or organic matter in the tailings. However, there are no toxic chemicals or elements present either.

21.4 EXERCISES

1. Should the tailings dam fail and the tailings liquefy, what would happen?
2. Why is this site particularly dangerous?
3. Evaluate the hazards and risks pertaining to the Surefire Mine Tailings Site I.

4. Drawing on your answer to question 3, what would be **your** actions, in order of priority, in response to what you have seen of the site. In particular, what would you do to enlist the assistance and co-operation of the neighbouring community in addressing the problems here. Assume that you have just discovered it. Do not assume that you are an expert in tailings management (unless of course you do have expertise in this area).
5. Unless you or a member of your team is an expert in ameliorating a dramatic situation such as this, you will have to call in experts. In which fields would they have expertise? At what point would you call them in?

This manual has been designed for general rehabilitation practitioners, not experts in any particular field. Thus you probably do not have the expertise required to handle a tricky situation such as the one outlined here. However, you should probably have views on what could be done to address the problems here, and you should therefore attempt the questions that follow.

6. In considering all the factors that could cause major failure of the dam, what would be your first priority to stabilise the dam?
7. Supposing you have selected the removal of the ponded water on the dam, how would you go about removing the water?
8. On the accompanying contour map, sketch the best plan in your opinion for draining the ponds.
9. In constructing the ditches and spillways and remembering they will have a relatively strong flow of water, how would you design them?
10. Once you have drained the ponds, how would you determine how successful you have been in lowering the phreatic level? Describe your procedure.
11. If the walls of the dam fail, from the information that you have been given about the site, what would be the nature of the catastrophe?
12. Along the perimeter and near the crest on top of the dam, a number of features were observed. These were longitudinal cracks, transverse cracks and slumping. What do these features indicate and if they are not rectified what would be the results?
13. What other features on the site would indicate weak or unstable foundations?
14. With this obvious, unstable, dangerous slope, how would you proceed to stabilise it, give reasons for each step?
15. In revegetating the tailings, what are the sequence of steps that should be taken?
16. Assuming that you have managed to safely stabilise the tailings impoundment, describe the monitoring programme you will set up. Give details for what parameters you will monitor, how often and how far into the future.

Further exercises to be developed by the trainer.

Chapter 22

Ongoing Rehabilitation at Port Mine

This case study¹ examines only a few aspects of rehabilitation. Trainers may well want to, and should feel at liberty to, further develop it by bringing out aspects of tailings dam management and rehabilitation, cyanide residues and risks, etc.

22.1 BACKGROUND

Port Mine is on the outskirts of Port O’Cobo. It is an underground gold mine, with the primary remaining parts of the orebody located beneath the western suburbs of the town. The mine was run by the government in the 1950’s, and was reopened by a small mining company, Paddington Mining, when it was privatised in the late 1990s. Paddington also own Sheep Hill Mine.

The residents of those suburbs are wealthy by Udanaxian standards, and are very concerned about the value of their properties and the quality of their environment. Several leading members of the community live there, so they have a strong influence over the town administration. While the community was initially opposed to the reopening of the mine, the owners have developed a good relationship with them, through having paid careful attention to their concerns.

Being close to the sea, the mine site is quite windy. It experiences a higher than average rainfall.

22.2 SITING AND NOISE CONTROL

As the existing shaft was unsuitable for safety reasons, the initial challenge for the company was to find an acceptable location for a new shaft. Several options were investigated before Vodon valley was chosen. Although not the shortest or cheapest access route to the orebody, it was decided to take a less direct route in order to minimise disturbances from the mine’s operations. The advantage of Vodon valley is that, while it is only 300 m from a residential area, the shaft headgear is hidden from the houses by a small hill and a 100 m strip of black spruce trees.

Noise is naturally a big concern for the environmental managers at Port Mine. They have considered four main options for controlling noise at the operation:

1. muffling the machinery;
2. modifying the machinery;
3. operating the machinery only during the day; and

¹ This case study draws heavily on an article in the Australian Minerals & Energy Environment Foundation’s *Groundwork*, Vol. 1 No. 2, December 1997. Used by permission.

4. using waste rock to increase the barrier between the community and the mine.

22.3 WATER MANAGEMENT

By considering water management as an integral part of the mine from the planning stage, the landscape was utilised in a way that required a minimum of engineering. While the settling ponds, dam and wetlands were artificially created by the company, they all now function so effectively that physical maintenance is rarely required.

There are three settling ponds, which are used as the first step in removing the mine water's principal impurities, iron, arsenic and manganese. Eventually, one of the ponds will become an evaporation basin. When the sludge in the ponds dries, the metals become fixed.

Upon leaving the settling ponds, water flows into a constructed dam, which serves as a wetland. Several species of reeds and rushes were introduced there when the dam was constructed. The dam's primary function is as a sedimentation pond for clay particles suspended in runoff from the mine site. After rain, the dam water can be highly turbid, but the clay particles are precipitated almost immediately owing to the high levels of calcium and magnesium in the water.

From the dam, the water flows down a steep channel to a much larger constructed wetland. The stream is lined and the flow is interrupted with branches cut from tamarack trees. The wetland is the mine's last means of cleaning its water before it leaves the site. It serves as a settling area, natural metals removal area and flood protection zone.

The water flows from the wetland into the Vodon river. At this point it generally meets statutory requirements without needing further treatment.

22.4 REVEGETATION

Even though the mine is still in its early stages, some areas are already being revegetated. The trees and shrubs in these areas were planted as tubestock along ploughed rows to facilitate rapid establishment. There is no natural seed stock in the topsoil as the site was overgrown by alien species when it fell into disuse. Various fast-growing species adapted to the local, wet climate are being planted.

22.5 EXERCISES

1. What are likely to be the twin advantages of the hill and trees that lie between the mine and the neighbouring community?
2. Consider the various options for controlling noise at the mine. Discuss their pros and cons.

3. What do you think is the reason behind converting a settling pond into an evaporation basin?
4. What would you do with the sludge that accumulates in the evaporation basin?
5. Apart from aesthetic reasons, why were reeds and rushes planted around the dam?
6. Why do you think the stream from the dam to the wetland was lined? Why were branches placed across it?
7. Discuss the shortcomings of the procedure used to revegetate the mine site. Why do you think this procedure was chosen? What longer term solution could be used in tandem with this procedure?
8. “The owners have developed a good relationship with [the community], through having paid careful attention to their concerns.” How would you go about establishing these concerns initially, and staying in touch with the community throughout the life of the mine?
9. Prepare the outline of the mine’s monitoring programme. Ensure that it is specific to Port Mine. Include physical (including tailings dams), chemical and environmental impact monitoring.
10. Examine what the company will need to do about closure of the mine, from planning through to actual closure, especially in the context of the tunnels being underneath Port O’Cobo. Ensure you give attention to post-closure land use.

Further exercises to be developed by the trainer.

Chapter 23

Tailings Dam Failure at Glitter Mine North

23.1 BACKGROUND

23.1.1 Tailings Dam Failure

In October, 1994, a major tailings dam failure occurred at an abandoned mining property, the Glitter Mine, located approximately 150 km south-east of Nornax in Northern Udanax. A map of the mine site is shown in Figure 23.1. The dam failure resulted in a massive mud slide of liquefied tailings material which flowed through the breach in the dam, across forested country, engulfed 22 residences, severed a major road, a local road, and deposited sediments into Oxan Creek. The tailings then flowed east approximately 1.5 km into the Xan River. The tailings destroyed a 1 km section of the main Highway P4 and deposited large quantities of tailings along the creek bed. Fortunately, no one was killed in the incident. The depths of the tailings were variable with the maximum recorded being 12 meters. The volume of the tailings released was estimated to be 350 000 cubic meters.

The tailings spill created a plume of finer sized material in the Xan River, which travelled at a rate of approximately 0.5 km an hour, eventually reaching over 100 km. past the town of Woodville on the Xan River. The plume of material in the river had concentrations of lead, cyanide and arsenic, all of which exceeded the acceptable water quality standards.

23.1.2 Mining and Tailings Operations

It is understood that the tailings area (Lagoon I) was operated up until about 1961 as a gold mining operation. The mining operations were finally shut down and abandoned in 1980. As a result of a subsequent survey of the mine site, it was determined that there was approximately 4.0 million tonnes of tailings in storage at the site (in Lagoons 1, 2 and 3) and covered approximately 30 hectares.

The tailings site for Lagoon I was selected to allow tailings to flow from the south and west perimeter towards the east and into a small lake. The perimeter tailings dams along the south side of the tailings area appear to have been constructed by the "Upstream Method". The remaining walls of the dam of Lagoon I, which are approximately 8 meters to 10 meters in height, do not appear to have any special under drainage or protective features.

23.1.3 Probable Factors Causing Failure

It was determined that the factors which probably caused the tailings dam failure was that the outlet to the lake was blocked. The outlet is a small creek located to the east of the outlet of the tailings area at the south-east end of the lake.

Figure 23.1. Glitter Mine Site

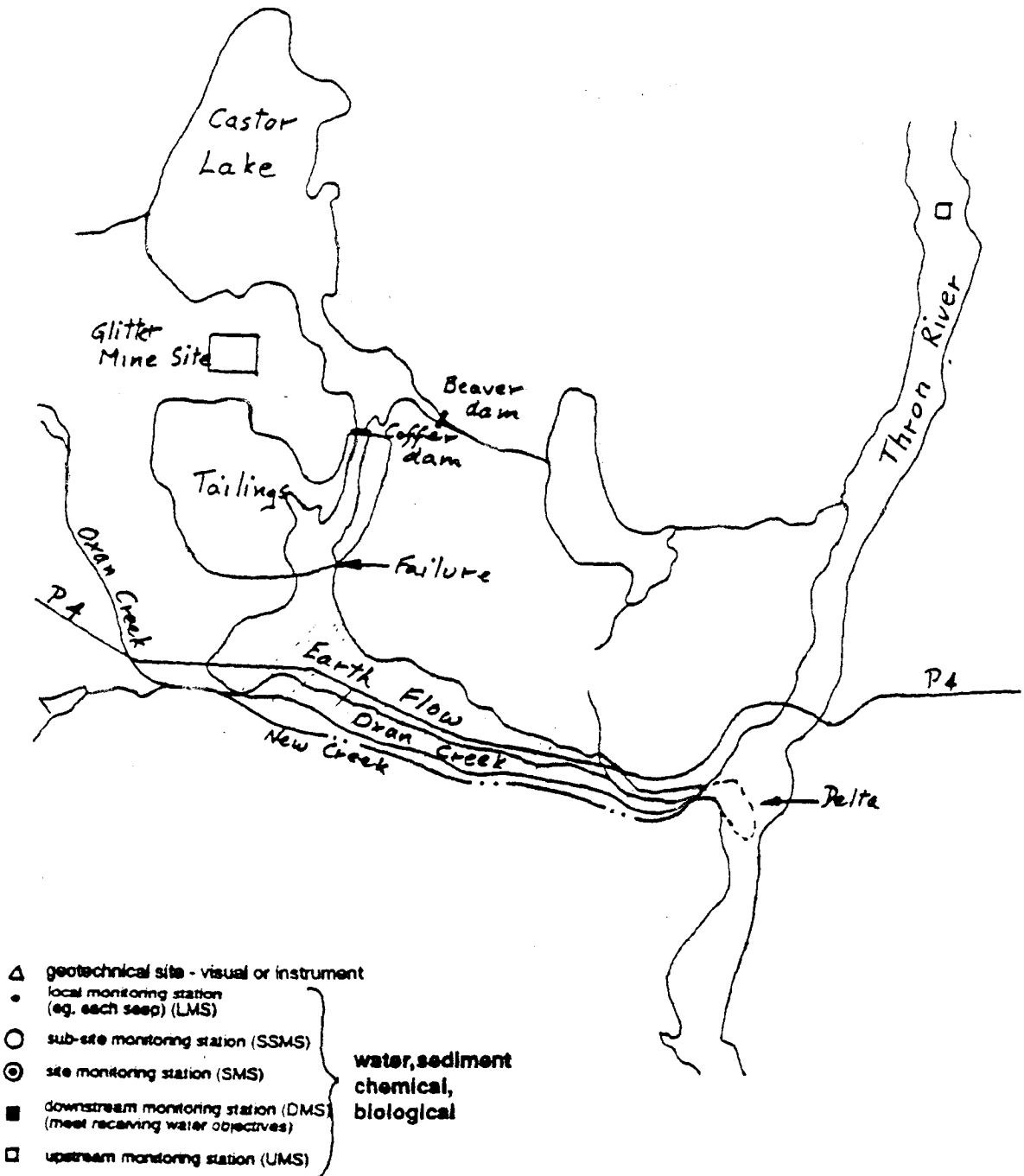

Over the years since closure, the natural dams from fallen trees were probably progressively built in stages, gradually increasing the level of the lake. It is estimated that the lake level may have risen by as much as 2 meters or more since closure. As a result, instead of the tailings depositing in the lake, the lake encroached upon the tailings area thereby raising the overall phreatic level within the tailings.

Above normal precipitation during the month of October 1994 caused overtopping of the lowest part of the dam crest causing a breach in the south-east corner of the tailings area. This overtopping of the water resulted in rapid erosion of the tailings along the dam face with the width and the depth of the resultant gully increasing progressively as increasing volumes of water from both the dam and the lake passed through the breach. With the increasing flow and a high pore water pressure, liquefaction of the stored tailings material occurred producing a major mud slide of tailings through the breach and down the slope towards Oxan Creek to the south. The tailings flow, through the breach continued, supplemented by the waters of the lake. No temporary emergency measures could be undertaken to control the outflow, until the level of the lake was lowered sufficiently to reduce the flow through the breach.

It was essential to put in place temporary control structures to stop the flow of tailings into Oxan Creek and the Xan River. The buildings had been totally destroyed and the reconstruction of the highway could not be undertaken before the outflow of tailings and water were stabilised. These temporary measures were also to eliminate the possibility of another similar tailings dam failure at the same site, given the original construction of the dam was very inferior and not constructed to current acceptable engineering standards.

23.2 TAILINGS DAM

23.2.1 Restoration Philosophy

After an inspection of the tailings and adjacent areas were undertaken, and a review of the reasons for dam failure, two possibilities for the remediation of the site were considered:

1. Restoration of the tailings area to the original state.
2. Modification of the tailings site to eliminate future potential dam failures.

Remediation of Tailings Area to the Original State

Remediation of the tailings area to the original condition would include removing of the blockages at the lake outlet, to control lake levels, and the rebuilding of the breached portion of the tailings dam which would include suitable under-drainage measures.

The factors to consider are:

- The original tailings dams were not constructed to current acceptable engineering standards.

- The sidewalls of the breached section indicated that there were no internal drainage measures within the dam walls.
- The relative density of the sand tailings in the structural outer shell is considered to be loose.
- The downstream slope of the southern impoundment dams is not overly steep, generally ranging from 5H:1V to approximately 10H:1V.
- It was observed that suspended solids, picked up by surface runoff from the tailings area, tended to settle out at the entrance to the lake, rather than remaining in suspension.
- If the tailings area was restored, such that the water level within the tailings area was allowed to rise to a high enough elevation to enable runoff to flow by gravity to the lake, the eventual phreatic surface, within the tailings area and perimeter dams, would increase to a level that existed at the time of the dam failure.

Modification of Tailings Area

After all factors are considered the modification of the tailings area represents the best option. The construction of a permanent filter dam and the maintenance of pond levels within the tailings area as low as possible represents the most favourable alternative for both short and long term stabilisation of the site. Also, provided that the opening to the lake remains permanently blocked with a suitable dam, such that only minor seepage flows enter the tailings area, the only major water source within the tailings watershed would be due to local surface runoff and groundwater. The maintenance of low pond levels relates to levels at or near the base elevation of the tailings dam. Ponds upon the tailings would only serve to aggravate the pore water problem.

This option provides a filter dam, located across the breach, designed to trap suspended solids while permitting discharge water flows at basically the same rate as inflow into the tailings area. The crest of the filter dam would also act as an emergency overflow spillway to handle extreme runoff events. There would be a small holding pond immediately upstream of the dam. The short detention period would settle out the coarser solids and some of the finer particles in suspension. The retained water would be allowed to filter through the dam. As this pond would be serving as a settling pond it would require clearing out periodically.

Under extremely high flood conditions, or an unexpected emergency event the dam should be capable of being overtopped without danger of failure, thus allowing the safe release of excessive flow.

23.3 TAILINGS SURFACE REHABILITATION

As part of the stabilisation of the tailings area, it is essential that the surface of the tailings area be reshaped to create a gently contoured surface sloping towards a depression and pond in front of the filter dam. Recommended slopes should range between 5H:1V and 10H:1V except in the breached area where side slopes of 4H:1V are acceptable. Flatter slopes will reduce the flow velocities of surface runoff thus reducing erosion and gullying effects, as well as ensuring the long term stability of the slopes, and their amenability to the establishment of vegetation. Long term rehabilitation of the slopes by surface revegetation or riprap is the objective. It is recommended that a detailed grading plan be prepared defining the desired contoured surface prior to any implementation of the landscaping and revegetation programme.

The sequences of activities to achieve this programme include landscaping, site preparation, surface protection during the establishment of vegetation and soil amelioration.

23.4 ACIDIC DRAINAGE

While investigating the site, it was discovered that one section contained sulphide tailings that are acid generating. Due to the failure in the main part of the tailings these sulphide tailings may in the future erode into the adjacent rehabilitated recontoured portion of the disposal site.

It therefore became necessary to implement remedial procedures. These tailings cannot be submerged because of the danger of raising the phreatic level. This leaves a number of choices. These are to transport the tailings to an appropriate designated site or to cover them. Alternatively, to transport them elsewhere is not a viable option because of the large volume involved and the lack of a nearby appropriate certified site. It is therefore necessary to cover them.

There are three options for covers, each with their own assets and drawbacks. There is the simple cover, the complex cover and the composite cover.

23.5 OXAN CREEK AND FORESTED AREAS

The flow of the liquefied tailings covered 150 000 square meters which included Oxan Creek, the adjacent forested areas and a number of residences. The depth of the tailings has a minimum thickness of 2 meters. The width of the flow is half a kilometre wide narrowing down to 100 meters where it enters the Xan River, where it forms a delta and the plume downstream. It follows the old course of the Oxan Creek and one kilometre of Highway P4.

There are a number of options to restore the flow of water down Oxan Creek which has a large watershed and is a perennial stream. The options are:

23.5.1 Option 1.

Excavate the bed of Oxan Creek and restore the old water course, remembering that the tailings are deep and over one and a half kilometre long.

23.5.2 Option 2.

Excavate a new channel outside the tailings but parallel to them.

23.6 MONITORING

As a result of the failure a certain amount of contamination was introduced into the area. In addition, because of the failure the physical characteristics of the site need to be monitored, both the new and the old features.

23.7 EXERCISES

1. Why, in your opinion, did the dam fail so easily?
2. How was it determined which method was used in constructing the dam? It was not in the records of the mining company.
3. The investigators reported that there were no special under-drainage or protective features on the dam walls. What would you look for if you were an investigator?
4. Would you need to use any instrumentation to arrive at that decision?
5. What would be the initial effect of the encroaching water raising the phreatic level in the tailings?
6. Which are the points at which temporary remedial measures should be put in place to control the outflow?
7. What are the specific problems at each location?
8. What method can be used to stop the solid flow of the liquefied tailings and yet allow for the draining away of the water? Describe the structure?
9. In considering remediation of the tailings to the original state, there are a number of factors to be considered. Review the following factors and give your opinion as to whether they are positive or negative.

The factors to consider are:

- The original tailings dams were not constructed to current acceptable engineering standards.
- The sidewalls of the breached section indicated that there were no internal drainage measures within the dam walls.
- The relative density of the sand tailings in the structural outer shell is considered to be loose.
- The downstream slope of the southern impoundment dams is not overly steep, generally ranging from 5H:1V to approximately 10H:1V.
- It was observed that suspended solids, picked up by surface runoff from the tailings area, tended to settle out at the entrance to Castor Lake, rather than remaining in suspension.
- If the tailings area was restored, such that the water level within the tailings area was allowed to rise to a high enough elevation to enable runoff to flow by gravity to Castor Lake, the eventual phreatic surface, within the tailings area and perimeter dams, would increase to a level that existed at the time of the dam failure.

10. From these data would you recommend restoring the site to its original configuration?
11. How would you maintain the settling pond?
12. Under extremely high flood conditions or emergencies, how would the excessive flow be safely released. Also what protective features would be built into the structure?

TAILINGS SURFACE REHABILITATION

13. What type of equipment would you use for the landscaping, recognising that cost is a factor?
14. Recognising that not all parts of the site are amenable to vegetation, what techniques would you use to inhibit wind and water erosion?
15. Recognising that tailings are relatively sterile, give examples of preparing a “soil” for revegetation?
16. In selecting vegetation for rehabilitation, what are the most appropriate species?

ACIDIC DRAINAGE

17. The composite or multi-layered cover is the only appropriate solution to contain the acid generating sulphide tailings at this site. Graphically illustrate the features of a composite cover and explain the function of each layer?

OXAN CREEK AND FORESTED AREAS

18. There are two principal options to restore the stream flow on Oxan Creek. These are stated in 23.5.1. and 23.5.2. in the text. In your opinion which is the best option, taking into consideration cost, materials handling, erosion and contamination? Give both the pros and cons for your decision by describing what activities would be necessary in each case?

MONITORING

19. As both chemical and physical monitoring are necessary to protect the integrity of the site and the surrounding areas, on the attached map locate the extent of the monitoring envelope, the monitoring points and stations. In each case state the name of the station (if applicable), the function, and the method used to collect the data?

Further exercises to be developed by the trainer.

Part IV

Bibliography, Answers to Exercises and Annex

Chapter 24

Bibliography

The following are the primary references consulted during the preparation of this Manual. This naturally does not represent a complete list of all references which relate to mine rehabilitation.

Abaza, H., 1993. *Appraisal Methodology for Sustainable Development Projects. Environmental Economics and Natural Resource Management in Developing Countries.* World Bank, Washington, D.C., USA.

African Development Bank, 1995. *Environmental Guidelines for Mining Projects.*

Boer, B., 1994. *International Strategies for Implementing Sustainable Development: The Roles of National State and the Local Governments in Translating Grand Strategy Into Action,* *Williamette Law Review.*

Brooks, B. W. Peters, T.H. and Winch, J.E., 1989. *Preparation of a Manual of Methods Used in Revegetation of Reactive Sulphide Tailings Basins. Mine Environment Neutral Drainage (MEND) Programme Project. E.O. 88593, Canada.*

Canadian Dam Safety Association, 1994. *Dam Safety Guidelines (Draft).*

CANMET Pit Slope Manual, 1977. *Energy, Mines and Resources, Canada.*

Carl Duisberg Gesellschaft (CDG)/United Nations, 1994. *Mining and Environment Protection, Environmental Impact Assessment and Pollution Control Training Manual.* Harare, Zimbabwe.

Chamber of Mines of South Africa, 1989, *Handbook of Guidelines for Environmental Protection - Volume 2. The Vegetation of Residue Deposits Against Water and Wind Erosion.* Johannesburg, South Africa.

Chamber of Mines of South Africa, 1989, *Handbook of Guidelines for Environmental Protection -Volume 3. The Rehabilitation of Land Disturbed by Surface Coal Mining in South Africa.* Johannesburg, South Africa.

Chamber of Mines of South Africa, 1996. *Handbook for Environmental Protection - Volume 1. The Design, Operation and Closure of Metalliferous and Coal Residues.* Johannesburg, South Africa.

Chow, V.T., (Ed), 1964. *Handbook of Applied Hydrology,* McGraw-Hill Inc., USA

City Resources (Canada) Inc., 1988. *Cinola Gold Project Stage II Report, Volume V: Environmental Research and Special Studies.*

Economopoulos AP (1993) *Assessment of Pollution Sources of Air, Water and Land Pollution. Part 1 - Rapid Inventory Techniques in Environmental Pollution.* WHO/PEP/GETNET/ 93.1-A. WHO, Geneva, Switzerland.

Environment Australia, 1995 - ongoing. *Best Practice Environmental Management in Mining.*

- Environment Canada, 1987. Mine and Mill Wastewater Treatment, EPS 2/MM/3, Canada.
- Gartner Lee Limited, 1991. Manual for Establishing Vegetation of Landfills of Ontario. Ministry of Environment R.A.C. Project 307C, Canada.
- Hilditch, T.W., Sinclair, G.A. and Hughes, C.P. 1988. Rehabilitation of Pits and Quarries for Forest Rehabilitation; Ontario Ministry of Natural Resources, Canada.
- Hoek, E. and Bray, J., 1981. Rock Slope Engineering, Institution of Mining and Metallurgy, London, UK.
- Hustrulid, W.H. (Ed), 1982. Underground Mining Methods Handbook. Society of Mining Engineers, New York, USA.
- International Chamber of Commerce, 1991. Guide to Effective Environmental Auditing.
- International Chamber of Commerce, 1991. Business Charter for Sustainable Development.
- International Council on Metals and the Environment and United Nations Environment Programme Industry and Environment office, 1996. Case Studies Illustrating Environmental Practices in Mining and Metallurgical Processes. ISBN 92-807-1558-5.
- International Council on Metals and the Environment, 1998. Environmental Charter.
- International Council on Metals and the Environment, United Nations Environment Programme Industry and Environment office, World Bank and United Nations Conference on Trade and Development, 1994. Development, Environment and Mining: Enhancing the Contribution of the Mineral Industry to Sustainable Development.
- International Council on Metals and the Environment, United Nations Environment Programme Industry and Environment office and Swedish International Development Co-operation Agency, 1997. Proceedings of the International Workshop on Managing the Risks of Tailings Disposal.
- International Organisation for Standardisation, 1996. ISO 14001: Environmental Management Systems - Specification with guidance for use.
- Klugman, M.A., 1994. Mine Environmental Management and Protection. Zimbabwe School of Mines Curriculum, Bulawayo, Zimbabwe.
- Laubscher, D.H., 1981. Selection of Mass Underground Mining Method, Design and Operation of Caving and Sublevel Stoping Mines, Society Mining Engineers., New York, USA.
- Lindsley, R.K., Kohler, M.A., and Paulhust, J.L.H., 1975. Hydrology for Engineers, 2nd Ed, McGraw-Hill Inc., USA
- Minerals Council of Australia, 1996. Code for Environmental Management.

- Mining Association of Canada, 1995. Environmental Management Framework and Policy.
- Murray, D., 1977. Reclamation of Vegetation. Pit Slope Manual Supplement 10-1. CANMET Report 77-31, Energy, Mines and Resources, Ottawa, Ontario, Canada.
- National Coal Board Production Dept, 1975. "Subsidence Engineers' Handbook" 2nd (revised) Edition, UK.
- Nolan, Davis and Associates, 1987. Study of Acid Waste Rock Management at Canadian Base Metal Mines. Prepared for CANMET, Energy, Mines and Resources, Ottawa, Ontario, Canada.
- Ontario Ministry of Agriculture, Food and Rural Affairs, 1994. Production Recommendations for Nursery and Landscaped Plants. Publication 383, Canada.
- Ontario Ministry of Agriculture, Food and Rural Affairs, 1994. Recommendations for Turfgrass Management. Publication 384, Canada.
- Ontario Ministry of Labour, 1982. Guidance for Engineers and Inspectors - Tailings Dams and Related Structures, Canada.
- Ontario Ministry of Natural Resources, 1987. Rehabilitation of Pits and Quarries for Fish and Wildlife, Canada.
- Ontario Ministry of Natural Resources, 1987. Sand and Gravel Pit Rehabilitation in Northern Ontario, Canada
- Ontario Ministry of Northern Development And Mines, 1992. Rehabilitation of Mines Guidelines for Proponents, Canada.
- Ontario Ministry of the Environment, 1990. Guidelines for the Decommissioning and Cleanup of Sites in Ontario, Canada.
- Piteau Associates, 1991. Mined Rock and Overburden Piles: Interim Guidelines - for Investigation and Design. BiTech Publishers, Vancouver, British Columbia, Canada.
- Richards IG, Palmer JP, Barratt PA (1993). The Reclamation of Former Coal Mines and Steelworks. Studies in Environmental Science 56. Elsevier, Amsterdam, The Netherlands. ISBN0-444-81703-4.
- Ritcey, G.M., 1989. Tailings Management Problems And Solutions - In The Mining Industry. Elsevier, Amsterdam, The Netherlands.
- Schramm, G., and Warford J., 1989. Environmental Management and Economic Development. World Bank, Washington, D.C., USA
- Slick, B. and Curts, W., 1985. A Guide for the Use of Organic Materials as Mulches in Reclamation of Coal Minesoils in the Eastern United States. United States Department of Agriculture, General Technical Report NE-98, USA.

- South African Bureau of Standards, 1998. Code of Practice for the Control of Mine Residue Deposits.
- South African Department of Minerals and Energy, 1992. *Aide-Mémoire* for the Preparation of Environmental Management Programme Reports for Prospecting and Mining.
- U.S. Bureau of Reclamation, 1976. Design of Gravity Dams, U.S. Government Printing Office, Washington, D.C., USA
- U.S. Bureau of Reclamation, 1987. Design of Small Dams, U.S. Government Printing Office, Washington, D.C., USA.
- United Nations Environment Programme Industry and Environment office, 1991. Environmental Aspects of Selected Non-ferrous Metals (Cu, Ni, Pb, Zn, Au) Mining - A Technical Guide. TR 5.
- United Nations Environment Programme Industry and Environment office, 1991. Hazardous Waste: Policies and Strategies - Training Manual. TR 10.
- United Nations Environment Programme Industry and Environment office, 1993. Environmental Management of Nickel Production - Technical Guide. TR 15.
- United Nations Environment Programme Industry and Environment office, 1994. Environmental Management of Mine Sites - Training Manual. UN DDSMS and UNEP IE, TR 30.
- United Nations Environment Programme Industry and Environment office and International Commission on Large Dams (ICOLD), 1996. A Guide to Tailings Dams and Impoundments: Design, Construction, Use and Rehabilitation. Bulletin 106.
- United Nations Environment Programme Industry and Environment office, 1996. Industry and Environment Emission Standards & Guidelines Information Clearinghouse (IE-ESGIC). Vol. IIIa Iron & Steel Industry Air Emission Standards; Vol. IIIb Iron & Steel Industry Effluent Discharge Standards.
- United Nations Environment Programme Industry and Environment office, 1996. Risk Management of Contaminated Industrial Land - Training Manual.
- United Nations Environment Programme Industry and Environment office, 1997. Environmental Management System Training Resource Kit. UNEP IE/ ICC/FIDIC.
- United Nations Environment Programme Industry and Environment office, 1997. Mining and Sustainable Development. Industry and Environment Vol. 20 No. 4.
- United Nations, 1992. Mining and the Environment - The Berlin Guidelines. The International Round Table, June 1991, Mining Journal Books, London, UK.
- United Nations, 1993. Environmental Protection Guidelines. United Nations Revolving Fund for Natural Resources Exploration, New York, USA.

- United Nations, 1994. Environmental Guidelines and Emission Standards for Mine Operations For Developing Countries. Mineral Resources Branch, EPSD, Department of Development Support and Management Services, New York, USA.
- United Nations, 1994. Environmental Guidelines for Mining Operations. United Nations Department of Development Support and Management Services and the United Nations Environment Programme, New York, USA.
- United Nations, 1995. Control of Water Pollution Caused by Mining Activities in Southeast Asia. UNEP/University of Malaya.
- United Nations, 1995. Mining: Metallic Ores and Minerals: Principles of Environmental Enforcement. UNEP IE/US EPA/WWF/SEDESOL/VROM.
- United Nations, 1996. Monitoring Industrial Emissions and Wastes. TR 27. UNEP IE and UNIDO.
- United Nations, 1997. Environmental Policies, Regulations and Management Practices in Mineral Resources Development in Asia and the Pacific. UNESCAP/UNCTAD.
- United Nations, Department of Public INFORMATION, 1992. Earth Summit: Agenda 21. The United Nations Programme of Action from Rio, New York, USA.
- Vandre, B.C., 1980. Stability of Non-water Impounding Mine Waste Embankments, USDA Forest Service, Intermountain Region Ogden, Utah, USA.
- Vick, S.G., 1990. Planning, Design, and Analysis of Tailings Dams, Bi-Tech Publishers Ltd. Vancouver, British Columbia, Canada.
- Walters, W.H. and Skaggs, R.L., 1984. Effects of Hydrologic Variables on Rock Riprap Design for Uranium Tailings Impoundments, Pacific Northwest Laboratory Report NUREG/CR-3752, PNL-5069, U.S. Nuclear Regulatory Commission, Washington, D.C., USA.
- Warren, R. P., 1989. Mine Rehabilitation Handbook, Australian Mining Industry Council, Canberra ACT, Australia.
- Welsh, D.E., 1989. Planning, Design and Operation of Tailings Facilities. Canadian Mining Journal, Don Mills, Ontario, Canada.
- Welsh, D.E., 1992. Mine Waste Management Practice, University of Queensland, Australia.
- Wishmeier, W.H. and Smith, D.D., 1978. Predicting Rainfall Erosion Losses - A Guide to Conservation Planning, USDA Handbook 537, USA.
- Zimbabwe Ministry of Environment and Tourism, 21994. Environmental Assessment Policy in Zimbabwe. Harare, Zimbabwe.

Chapter 25

Model Answers to Exercises

Note that there are not answers to every question.

Chapter 2: THE MINING SEQUENCE

3. Preliminary Study:

- Started during preliminary exploration
- Completed during deposit evaluation

Operating Plan:

- Started during deposit evaluation
- Completed during early production
- This plan is dynamic and may continue through the life of the mine.

Rehabilitation Plan:

- Started during deposit evaluation
- Completed at end of operation as it too is a dynamic plan.

Chapter 4: OCCUPATIONAL HEALTH AND THE MINING PROCESS

1. Drilling and conveyer equipment, locomotives, trucks, loaders and excavators, grinding mills and air compressors. Hand pneumatic tools are the main source of vibration.
2. The regulatory standard in many countries is 85 dB. The 85 dBA is regarded commonly in some countries as the “acceptable risk” for occupational exposure to noise.
3. There are already some risks of hearing losses at 75 dBA.
4. In underground mines, the adjacent rock walls, the intake air, the machinery and the workers themselves are the main sources of heat. In opencast mines, the direct exposure to the sun and to the cold are main thermal impacts to the mine workers.
5. For acclimatisation to enable their bodies to adapt physically to the lower oxygen pressures.
6. Excavation, drilling, conveying, waste rock piles, tailing dams, unsurfaced haul and access road, and beneficial process (i.e. crushing process).
7. Especially as a result of waste dewatering leading to the exposure to wind of fine, dry material on the surface. Windy weather may lead to “dust storms”.
8. Hazardous components like lead and nickel, which are very toxic and also free crystalline silica, cadmium and arsenic associated with gold in sulphide ores can be found on some

mining activities. Usually the dust mainly consists out of the compounds which are mined.

9. Carbon monoxide binds strongly to haemoglobin and that prevents the oxygenation of the blood. The result is headaches, dizziness, drowsiness and may lead to unconsciousness or even death.
10. Ingested cyanides is used for extracting gold for instance. It can penetrate through the skin and reacts aggressive to the respiratory system when inhaled.
11. As many as 45 different metals are suspected to affect health.
12. Manganese.
13. Temperature and humidity, presence of stagnant water, scrap food and lack of hygiene.
14. The respirable fraction of the dust (1 - 5 μ m particle diameter). This size characterisation allow their penetration and deposition in pulmonary spaces which may lead to fibrogenic effects, local irritation along the respiratory system and/or lung cancer.
15. Changing to slower running equipment, altering the design, construction or installation improving maintenance replacing compressed air powered equipment by electrical devices using properly designed air silencers, resilient mountings isolating the source by enclosure of noisy and/or vibrating fixed equipment increasing the noise and vibration absorption between the source and the listener by locating noisy or vibrating activities as far as possible from areas of potential nuisance and by, in the case of noise, erecting some form of screening structure between the source and the listener screens used in practice include walls, waste banks and trees.
16. To detect early changes in his or her physical and mental state of health.

Chapter 6: OPERATION PLAN FOR ACTIVE MINES

1.
 - Schedule of Operations
 - Mining Activities
 - Mine Development Rock, Ore and Concentrate Management
 - Milling Processes
 - Tailings Disposal and Impoundment
 - Water Management and Treatment
 - Solid Waste Management
 - Chemicals and Fuel Storage
 - Buildings and Infrastructure
 -
2.
 - The expected duration of advanced exploration activities.

- Long term projections of development.
 - The expected schedule of development of the major features in the development of the mine, such as open pits, tailings dams, rock and overburdened piles, mine and mill buildings, road, power lines and other infrastructures.
 - Modifications that might be made to existing water courses. This is very important.
3. By developing towards the critical view point the exposed pit face can be rehabilitated progressively. By developing away from the critical viewpoint, the working pit face is always in sight and can only be rehabilitated at the completion of operations.

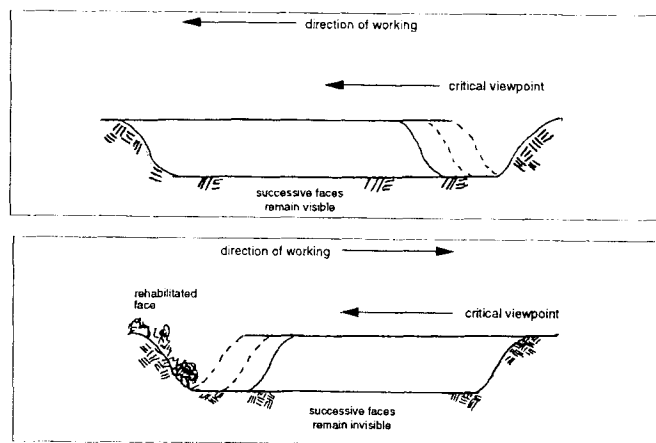

- 4.
- The projected annual milling rate over the proposed mine life
 - The process flow sheet
 - The list of reagents used
 - The water balance for the mill
 - The characteristics of the process and tailings
 - The particle size distribution and morphology of the tailings
 - The chemistry of the tailings. Whether they may be acid generating
 - The various types of tails and the tonnages of each type of tailing
 - The residues in the mill tailings
 - The amounts that will be placed in surface impoundments
 - The amounts that are to be used as mine backfill.

Chapter 8: REHABILITATION PLANNING

- 4.
- The ability to meet expected environmental conditions.
 - The cost effectiveness of the program.
 - The certainty of the present technology and its anticipated long term performance.
 - The maintenance and monitoring requirements.

5.
 - The physical stability.
 - The chemical stability.
 - The environmental impact.
 - The future land use.

6.
 - Control of Reactions.
 - Control of Migration.
 - Collection and Treatment.

7.
 - Land use.
 - Topography.
 - Hydrology and Hydrogeology.
 - Plant and Animal Life.

8.
 - Schedule.
 - Site Security and Safety.
 - Mine Workings
 - Underground Workings.
 - Open Cast Workings.
 - Mine Development Rock and Overburden Piles.
 - Tailings Impoundment.
 - Water Management and Treatment.
 - Buildings, Equipment and Infrastructure.
 - Land Fill, Waste Disposal.
 - Chemical and Fuel Storage Areas.
 - Hazardous Waste Storage and Disposal.

9.
 - Openings to surface (shafts, raises, stopes, portals to adits and declines).
 - Surface disruption (caving, collapse of crown pillars).
 - Surface disturbance (subsidence).
 - Barrier pillars stability, hazardous to neighbouring operations.
 - Acid drainage and leaching of minerals.
 - Seepage of mill reagents from backfill.
 - Productivity and aesthetics.
 - Drainage interrupted.
 - Ground water lost.

10.
 - Ditch and berm all access routes.
 - Fence, and sign post, if necessary.
 - Provide emergency access to water.

- Slope stabilisation where practicable.
- For potentially unstable slopes, either stabilise by flattening slopes or constructing toe berm.
- Restrict access with ditch/berm and, if necessary, fence and sign post.
- Establish vegetation or place riprap rehabilitate for fish, waterfowl, wildlife habitat.

11.

- Site selection to avoid low strength foundations.
- Internal drains to prevent water table rise.
- Construct in lifts to achieve flatter slopes.
- Covers to control infiltration of water.
- Ditches for water management.
- Bulldoze crest, if required, to flatten slope.
- Construct toe berm to stabilise slope and to flatten inclination.
- Collect sediment in ponds.
- Establish vegetation or riprap, where required.
- Monitor.

12.

- Implement permanent control measures.
- Flood to control reactions.
- Pre-treatment - removal of deleterious material for controlled disposal elsewhere or blending with alkali material to mitigate acid drainage.
- Cover to control acid reactions and/or migration using inert material or bog.
- Ditch to divert run-off.
- Collect and treat - Active Treatment to be Avoided Where Possible.
- Do not construct with materials which are potential acid producers or are leachable.
- Decontaminate and/or remove acid generating or leaching materials.

13. To ensure that water on and around the site is controlled for the benefit of the mining operation, and the surrounding environment.

14. This involves the storage, the conveyance and the treatment of the water used on site and also the diversion, discharge and treatment of excess water.

15. Water management facilities at mine sites include structures such as dams, spillways, diversion ditches, culverts, pipelines, pumphouses, milling plants, settling ponds and dewatering systems.

16.

- Cyanide and other mill reagents.
- Suspended solids as fine particles.
- Acid mine drainage, from the oxidation of sulphide materials.
- Residues from blasting agents, such as nitrates.
- Ammonia.
- Suspended or dissolved heavy metals.

- 17.
- Remove culverts and make excavation stable.
 - Remove all bridges and barricade approaches.
 - Rip compact surfaces.
 - Establish vegetation.
 - Restore drainage patterns.
 - Maintain necessary ditches, culverts and other facilities.
 - Remove all elevated wires and poles.
 - Ground all buried wires.
 - For chemical contaminants either treat or remove and dispose of in an approved site.

Chapter 9: EROSION CONTROL

- 1.
- Protection of the soil surface by materials. These may be mulch, other natural materials or synthetic materials.
 - The maintenance of the soil surface in an erosion resistant condition.
 - Reduction of the wind velocity across the disturbed areas by use of windbreaks.
2. All of the following are options:
- Mulches - types of mulch
 - Use of obstacles - dimpling mechanism
 - Scarifying - condition of soils
 - Use of water - sprays or bowsers.
3. A wind rose diagram may be used to determine the wind intensities and directions in order to locate necessary wind breaks.
4. (a) Height and spacing
(b) Permeability

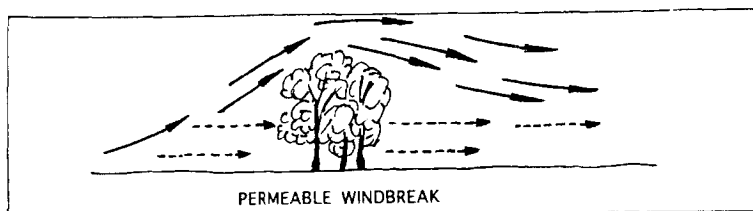
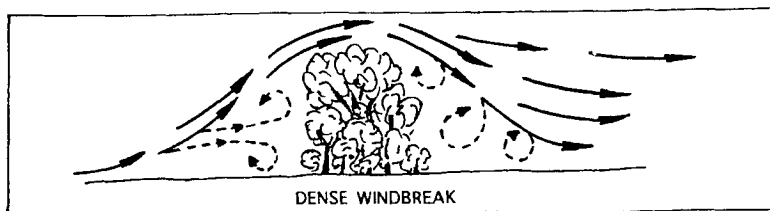

(c) Length and continuity.

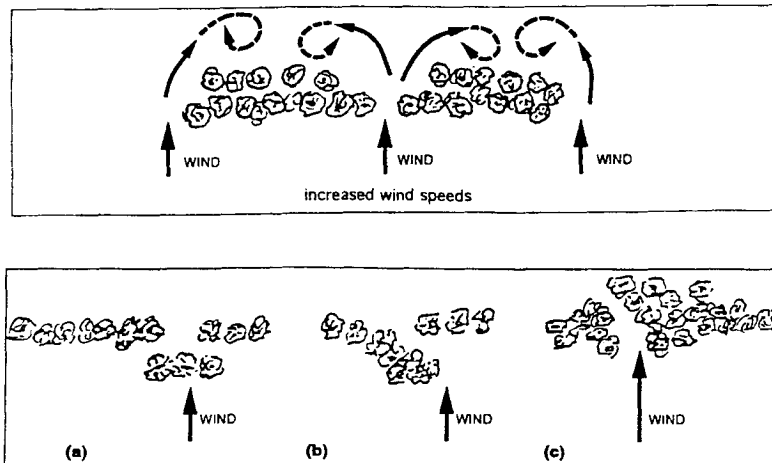

EROSION (WATER)

1. Factors influencing runoff include:

- Intensity of the rainfall
- Area of disturbance
- Size of the catchment area
- Slope of the landscape
- Soil characteristics
- Land use at the time

2.

- Minimising the possibility of inadvertent further negative impact.
- Managing the entry of water or runoff to the site
- Encouraging infiltration
- Managing the water when leaving the site, so that damage will not be repeated downstream

3.

- Site Plans: Should be part of the whole, avoids patchwork decisions and projects.
- Surveying: Establishes the site in the context of the overall surroundings. Ensures accuracy in implementation of plans by engineering and construction.
- Equipment operators: Make sure they know what they are doing.
- Supervision: Should be senior, competent personnel.
- Penalties: To ensure personnel and contractors undertake the project correctly.
- Equipment: Use the correct equipment.

4.

- Dam height
- Dam storage capacity

- Hazard rating
 - A qualified, certified, professional engineer, experienced in hydrology.
5. This is the calculated worst flood that could occur once every 100 years. This does not mean that only one flood of this magnitude would only occur once in a 100 years.
6. Hazard Potential is usually classified in three categories, low, significant and high. Each is defined by the impact of the disaster as it affects loss of life and property damage.
- Low Hazard Potential
Loss of life: None
Property damage: Minimal to agriculture, other dams or structures not for human habitation. None to residential, commercial industrial or land to be developed within 20 years.
 - Significant Hazard Potential
Loss of life: None expected
Property damage: Minimal to agriculture operations, other dams or residential, commercial, industrial development or land to be developed within 20 years.
 - High Hazard Potential
Loss of life: One or more
Property damage: Extensive to agricultural operations, other dams or residential, commercial, or industrial development.
- 7.
- Rainfall frequency and duration curves
 - Catchment area size
 - The runoff coefficient

EROSION (PHYSICAL WATER MANAGEMENT)

- 1.
- Graded to moderate or gentle slopes
 - Inclination of slope should be approximately 8 degrees dependent on soil
 - Avoid scouring and erosion
 - Cross sections of ditches should ideally be parabolic
 - Depending on the nature of the soils the maximum safety velocity should be from 0.5m/sec., to 2.0m/sec., for more resistant soils.
- 2.
- Old conveyor belts
 - Hemp or jute mesh
 - Riprap

3. (a) Hay bales, sand bags, bags of cement, riprap
(b) Concrete, gabion baskets, groins, armour stone
(c) Examples:
(d)

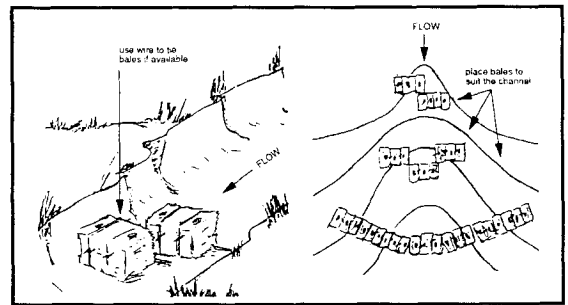
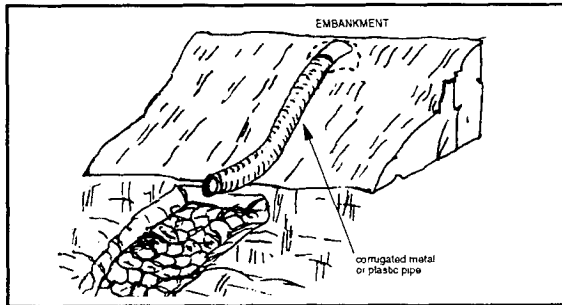

4. (a)

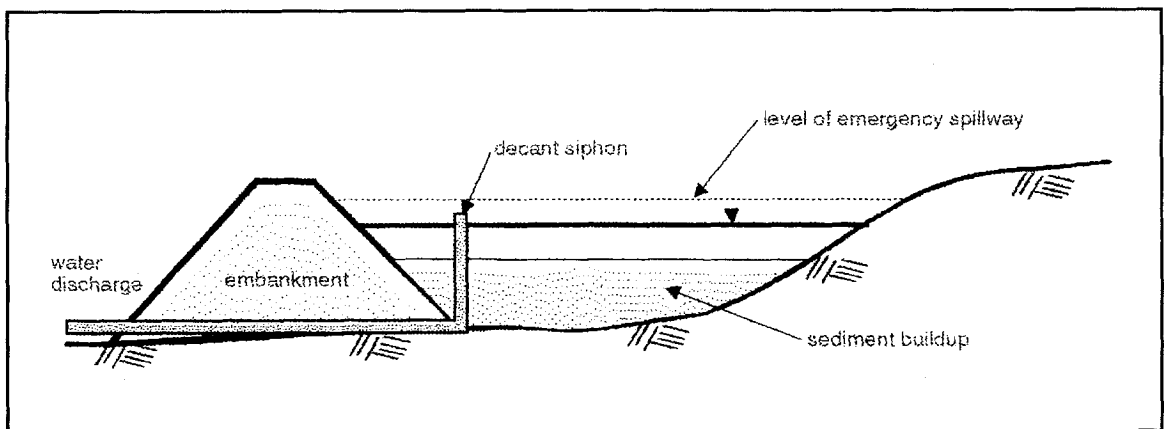

- (b) 50%

Chapter 10: LANDSCAPING

- 1.
- Future land use
 - Final landscape must be stable
 - The size of the area
 - The drainage pattern
 - The climatic conditions
 - Availability of material (e.g. topsoil)
 - Availability of appropriate vegetation
 - Reduce slopes in unconsolidated materials
 - Redesign catchment areas if necessary
2. 19 degrees

3.
 - Contour ripping is safe on slopes of up to 27 degrees
 - Large bulldozers can usually push earth material up-slope on slopes of up to 22 degrees
 - Agricultural machinery can be used on slopes up to 19 degrees
4. Maximum Slopes for Land Use.

<u>LAND USE</u>	<u>SLOPES/DEGREES</u>
Forestry	38
Grazing	28
Pasture	15
Buildings & Roads	12
Rotation Cropping	5
Housing	3

Chapter 11: TOPSOIL MANAGEMENT

1.
 - Remove the upper or 10 to 15 cm first because it contains the majority of seed, nutrients and micro-organisms.
 - Remove the next layer, up to 30 cm and store elsewhere.
2.
 - Do not store for too long, reuse as soon as possible.
 - Do not store in large piles.
 - If not used immediately, revegetate.
 - Locate away from activity as disturbance can damage the soil structure.
 - Do not strip when wet.
3.
 - Excessively sandy soils.
 - Soils with extremes in pH (<5 & >8.5).
 - Saline soils.

Chapter 15: ACIDIC DRAINAGE

1. The presence of the bacteria *Thiobacillus ferro-oxidans* accelerates the acidification by several orders of magnitude. The process is transitional with the sulphide oxidised to an iron sulphate and the subsequent reaction producing sulphuric acid.

2. Waste rock can be compacted to reduce pore space and thus inhibit access to oxygen and moisture. Impervious sloping soil or clay layers can be inserted into waste rock dumps. This will inhibit access to oxygen and moisture and encourage drainage to the perimeters, thus making it more efficient to treat the effluent if necessary.

Because some type of impervious cover will likely be required on reactive waste, the depth of waste should be maximised in order to reduce the area. Impervious covers are very expensive. Place the most offensive high sulphur content material in low lying areas in tailings ponds so that it can be readily buried and submerged within the phreatic zone.

Waste structures, particularly on new properties, should be carefully designed and managed so they will not occupy large areas.

3. Aqueous submergence of tailings in a lake, the sea, a man made dam or impoundment or an abandoned opencast mine.

5.

- Do nothing, only rely on perpetual care after closure, which may be a bigger and more expensive operation than the mining operation itself.
- Inhibit or reduce the rate of acid generation by:
 - The placing of dry impervious covers
 - These covers are expensive
 - May not be highly effective in the long term
 - They do leak and are susceptible to deterioration

 - The placing of dry pervious covers
 - They are easy to construct
 - Cut down evaporation in arid climates
 - Usually retain a high phreatic level and cuts down on fluctuating water levels

 - Chemical Treatment
 - Expensive
 - Does not appear to do what it was developed for

 - Injection of tailings or sludge
 - Only feasible in rock piles
 - Drilling access holes difficult
 - Results have been unreliable and inconclusive

 - Alkaline buffering with lime or limestone
 - Mixed with head feed has been successful
 - Slurry sprays have been successful, however, need a good source of slurry
 - Lime feeders have been successful, but require a cheap source of lime or limestone

 - Removal of acidic waste piles
 - Only feasible if there is a nearby alternative dumping location
 - Underground deposition. Only feasible after closure of the mine.

- Paste backfill underground
- Limited volume - 60%
- New but good method may develop further
- Also, if mixed with cement provides underground support
- Relatively impermeable

- Biological treatment
- Not a stand alone procedure
- Useful if used in conjunction with another effluent treatment method
- Has good potential for future, particularly in warm climates

- Reworking old tailings
- Can be self-supporting or profitable

Chapter 16: TAILINGS REHABILITATION

1. Dams should:

- Be non-polluting while they are operating as well as after the decommissioning of the site, this may require a water treatment plant both during and following the operation.
- Be structurally stable.
- As far as is possible, be resistant to erosion.
- Progressive rehabilitation should be a planned and required function during the operation of the dam. This will inhibit erosion.
- Be planned to have an ultimate appearance and configuration that will be visually compatible with the surrounding landscape
- Be planned to have an adequate capacity to cope with the tailings throughout the mine life

2.

- The high concentration of heavy metals and salts
- Extremes of pH
- A lack of essential plant nutrients
- A lack of microbiological organisms
- The texture and the structural characteristics of the soil which may limit aeration and infiltration
- The availability of sub-soil and soil which may be used to remediate the site
- Particularly in arid and semi-arid high temperature areas, the levels of reflected light or heat absorption on dark or light tailings can cause physiological stress to vegetation
- In arid and semi-arid areas both the adjacent tailings and denuded areas will probably cause physical damage by sand blast

3.

- First, the reshaping of the surface to provide controlled drainage away from the centre toward the periphery of the dam. This would involve contouring and gently inclined outward dipping slopes
- Following recontouring, a layer of compacted clay or similar impermeable material should be laid over the tailings to provide a surface for free drainage
- The thickness of this clay layer should be from 0,75 metres to 1,0 metres thick. This addition of a synthetic impermeable membrane may also be desirable beneath this clay
- Overlaying this is a free draining rock layer to provide positive drainage away from the centre of the structure. This layer is composed of coarse grained material which has good porosity and permeability, and should be from 0,25 metres to 0,5 metres thick
- Overlaying this free draining material, a filter cloth should be laid to stop the infiltration of fine material which would ultimately clog the free draining horizon
- This filter cloth is overlain by subsoil and then topsoil if available.

Chapter 18: ADITS AND SHAFTS

1.

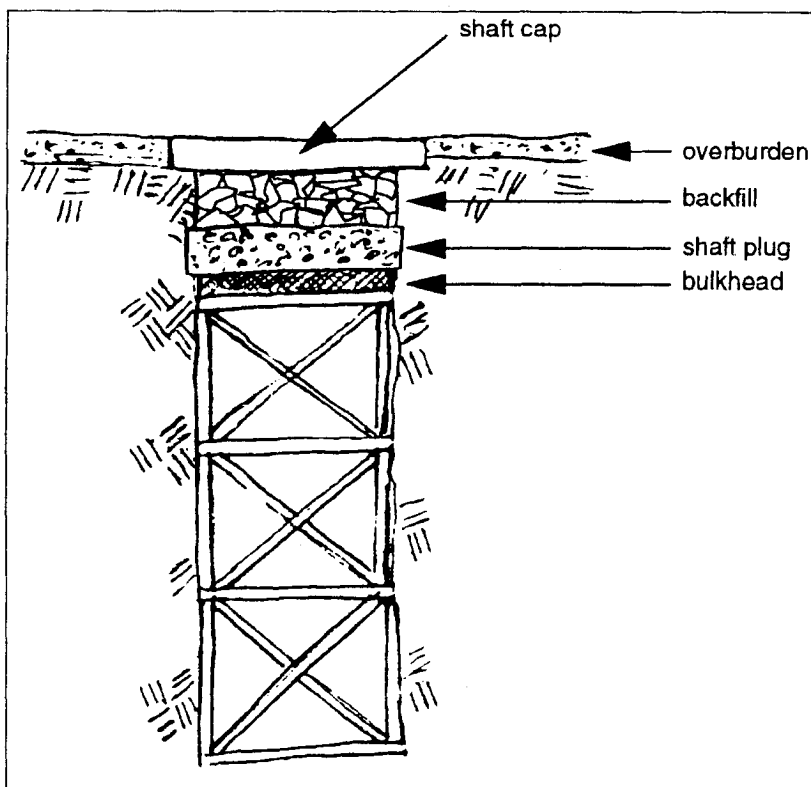

2.

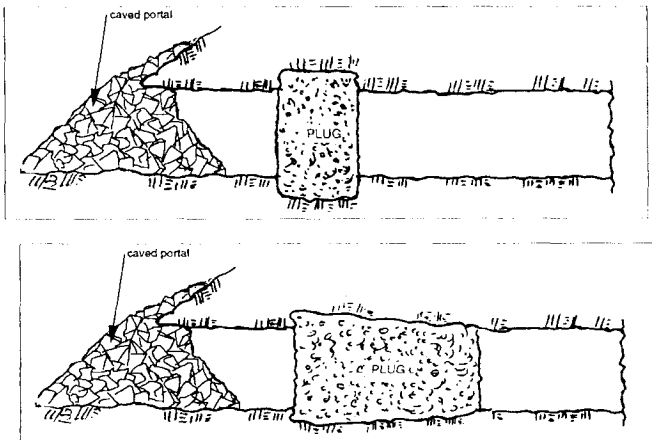

Chapter 21: SUREFIRE MINE TAILINGS SITE I

1. There is no natural obstacle that would stop the outflow and hundreds of people would be in jeopardy. Before a disaster occurs it is essential to remedy the situation.
2. If the dam failed, it would have the potential to destroy lives and property. The close proximity to housing, the size of the tailings dam, the volume of water stored on the upper surface, coupled with potential earthquake loadings or a large rainstorm event make this site very dangerous.
3. In addressing a potential catastrophe of this magnitude, it is necessary to prioritise the hazards that may occur and their impacts. Naturally, the most threatening should be addressed first, but lesser failures could also cause considerable damage and possibly death. The safety of the people living near the tailings impoundment must be ensured as a very urgent priority, outweighing all rehabilitation considerations. The most important hazard is thus catastrophic failure of the tailings dam. Other hazards include slow flow of tailings into human settlements, injury to children playing on the site and chemical and particle contamination of ground and surface water.
4. Measures to ensure that people, including children, cannot enter the site must be taken immediately.

Then steps must be taken to remove people from danger. They are unlikely to want to move away, despite the great danger they face if they do not. Thus a programme of community consultation will be required in order to demonstrate the urgency of the situation and persuade people to move. The UNEP APELL (Awareness and Preparedness for Emergencies at Local Level) programme is appropriate. Information may be found at: <http://www.natural-resources.org/environment/docs/pdfs/apell.pdf>. Specialists in community consultation may be required.

Experts in soil mechanics and/or tailings rehabilitation should be called in as soon as possible to remedy the situation. Once the tailings impoundment has been made safe, which will take quite a while, rehabilitation can get under way. It must be emphasised

that catastrophic failure of the dam would cause terrible harm, first to people, then to the environment, and this should be addressed first.

- 5. This question has been answered in the answer to question 4.
- 6. The removal of the ponded water on the upper surface of the dam.
- 7. By the development of ditches and spillways to drain the ponds.
- 8.

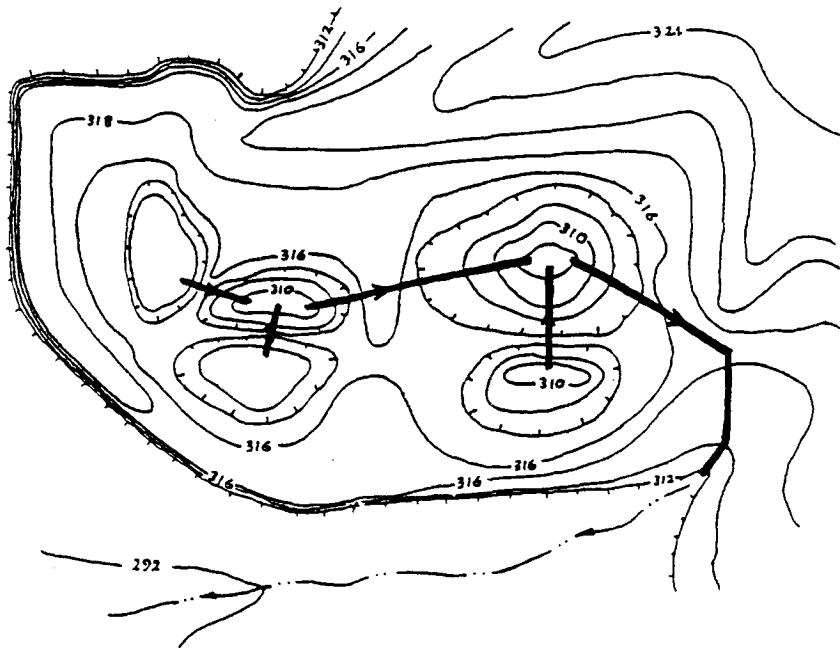

9.

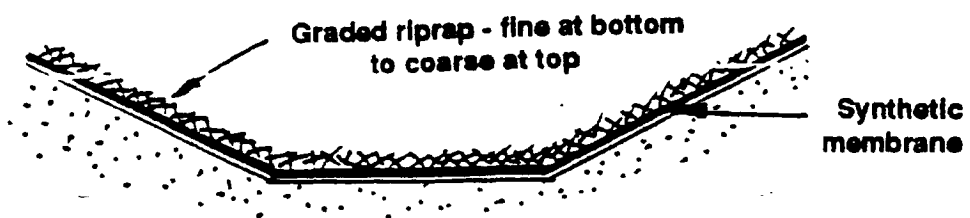

Gradient in the ditch should not exceed 3H:1V because of the soft nature of the tailings.

- 10. By measuring pore water pressures in the tailings and by determining the phreatic level.

By using piezometer which is an instrument that when sealed into the soil or tailings can measure the pore water pressure around itself.

A number of holes on the top of the tailings will need to be drilled in which to insert the piezometer to make the measurements. These would be both areally placed and be of differing depths.

11. Because of the high phreatic level, the looseness of the tailings and the availability of a large volume of surface water, the liquefaction of the tailings would take place and an earth flow would occur.
12. Longitudinal cracks, which are roughly parallel to the crest, indicate the instability of the crest of the slope, that is that the factor of safety is less than one and depending on the sensitivity of the tailings and the pore water pressure a simple or a deep seated rotational slip is liable to happen. The presence of seepage and sand boils also indicates the instability of the slope, in that there is internal piping and high pore water pressure.

Transverse cracks, which run roughly at right angles to the crest, and slumping usually indicate weak or unstable foundations.

13. The presence of swampy and marshy ground at the toe of the slope.

14. Step 1:

Compact as much as possible the swampy ground at the toe of the slope by placing a gravity berm a short distance (10-15 metres) out from the toe. This is to both stabilise the weak foundations and place a counter balance, or resisting force, to the possibility of a deep rotational slip. To apply even pressure, a geosynthetic membrane should be placed on the ground before the rock, which would form the berm. In placing the rock berm, individual lifts should not exceed 0.5 metres and each should be compacted before the application of the next lift.

Step 2:

The crest of the slope must be resloped or lowered by pushing the material downslope and filling between the berm and the toe of the dam to reduce the inclination to at least 3H:1V to 4H:1V.

Step 3:

The slope while being resloped must be compacted as the resloping is in progress, so as to ultimately have a stable packed regular slope.

15. Step 1:

Before any amelioration or vegetation takes place, a detailed sampling programme should be undertaken to determine the physical and chemical nature of the tailings.

Step 2:

As there is little nutrition or organic material in the tailings, organic mulch, such as hay and fertiliser, should be applied. This should be scarified or ploughed in.

Step 3:

Geomats or erosion control mats composed of straw or coconut fibre in a biodegradable mesh should be laid on slopes to inhibit erosion and provide a seed bed.

Step 4:

As there are differences in conditions on the site, appropriate vegetation should be selected for each condition remembering that there should be a diversity of species.

Step 5:

Based on the guidelines for revegetating in Udanax the following species could be used:

- In wet to moist areas: - red maple, balsam poplar, willow speckled alder; grey dogwood, nannyberry, cat tails; Canada bluegrass, bent grasses, wild rye.
- In mesic areas: - tamarack, white cedar, balsam poplar, white birch; choke cherry, hawthorn, currant; timothy, clover, creeping red fescue, wild rye, trefoil.
- In dry areas:- red cedar, jack pine, red pine, poplar, black locust; juniper, sumac; clover, wild rye, perennial rye, alsike clover, trefoil.

NOTE: In order to check the students' full knowledge, reference should be made to Tables 20.6-8, as only a selection of species is listed here.

Step 6:

Because of their rapid growth and their density, alders may also be used as a barrier for human penetration on the slopes.

Chapter 22: ONGOING REHABILITATION AT PORT MINE

1. They will act both as sound and sight barriers.
2. Muffling the machinery is likely to adversely affect the performance of the machinery. Reduced efficiency means higher fuel consumption, which is itself an environmental impact. However, as a short-term measure, this might be necessary.

Modification of the machinery will probably void its guarantee. Presumably the manufacturers built the machinery the way they did for good reasons.

Working limited hours is a good solution, though not for the long-term, as it may well not be economical when commodity prices are low, and it will still affect people at home during the day.

Building a waste rock barrier is a long-term solution. As it requires the accumulation of sufficient waste rock, it is not an immediate solution. However, as a "permanent" structure, provision should be made in the EMP to rehabilitate it when the mine closes. Perhaps it will be left behind, but the issue needs to be addressed.

3. The settling pond will be converted into an evaporation basin to prevent the accumulated sludge from being washed away with the runoff water.
4. One solution would be to combine the dried sludge with sand, and use the mixture as backfill underground. Not only does this remove the sludge from the surface, but it has environmental and safety benefits for the mining operation. You can probably think of additional applications.
5. They remove metals from the water both directly and by providing a habitat for bacteria that remove metals.
6. The stream from the dam to the wetland was lined to reduce erosion. Branches were placed in the stream for the same reason, and also to aerate the water. Aeration helps the water biologically, and aids in the oxidation and precipitation of metal salts still in the water.
7. On a cleared area in a mine site, the roots of the trees and shrubs will tend to grow along the ploughed lines. Thus the vegetation will not be stable in strong winds. However, owing to community concerns, there was pressure on the mine to demonstrate their commitment to ongoing rehabilitation efforts. Scattering seeds outside the ripped lines is a slower, but more effective solution in the longer term.

Chapter 23: TAILINGS DAM FAILURE AT GLITTER MINE NORTH

1. The Upstream Method was used. The method involves progressive lifts being built on previously deposited tailings which are mixed grain size, poorly compacted and subject to liquefaction.
2. It was determined by investigators, after the failure. The fact that it was determined that the Upstream Method was used indicated that the dam was not designed or built with properly engineered fill.
3. Sandboils, piping, sediment carrying seepage to indicate internal erosion.
4. No, the inspection would be a visual inspection to determine these features.
5. A rise in the phreatic level would increase the pore water pressure which could increase the possibility of liquefaction of the tailings.
6. There are two:
 - (a) Between Castor Lake and the tailings
 - (b) At the breach in the tailings.
7.
 - (a) At the Lake outlet there is a need for a coffer or control dam to control the flow of water onto the tailings.

- (b) The problem at the breach is the continued flow of liquefied tailings. Some method must be put in place to stop the liquefied tailings and yet to allow the excess water to drain away before permanent remediation can be undertaken.
8. The construction of a temporary filter dam which will hold the solids and allow the water to flow through. The dam is constructed of coarse material, such as mine rock and coarse gravel with a geotextile filter fabric placed on the upstream wall and protected by riprap.
9. (In considering remediation of the tailings to the original state, there are a number of factors to be considered. Review the following factors and give your opinion as to whether they are positive or negative.

The factors to consider are:

- The original tailings dams were not constructed to current acceptable engineering standards.
 - The sidewalls of the breached section indicated that there were no internal drainage measures within the dam walls.
 - The relative density of the sand tailings in the structural outer shell is considered to be loose.
 - The downstream slope of the southern impoundment dams is not overly steep, generally ranging from 5H:1V to approximately 10H:1V.
 - It was observed that suspended solids, picked up by surface runoff from the tailings area, tended to settle out at the entrance to Castor Lake, rather than remaining in suspension.
 - If the tailings area was restored, such that the water level within the tailings area was allowed to rise to a high enough elevation to enable runoff to flow by gravity to Castor Lake, the eventual phreatic surface, within the tailings area and perimeter dams, would increase to a level that existed at the time of the dam failure.)
10. No.
11. By the use of a dragline, scraper or small bulldozer to clean it out on a regular schedule.
12. The filter dam, being lower than the adjacent impoundment dam walls would act as a spillway.

In designing and constructing the filter dam, a protective rock cap would be installed, the adjacent side walls would be protected by riprap and riprap would be placed on both the upstream and downstream shells.

TAILINGS SURFACE REHABILITATION

13. The equipment already on site during its down times. Also, recognising that the inclination of the planned slopes will allow the use of all types of earth moving equipment from heavy to light.
14. The use of rock cladding or riprap for heavy traffic areas and ditches or drains.
The use of old tires or dimpling for wind erosion.
The use of geomats.
The use of geosynthetic liners or old conveyor belts for retarding gullying.
The use of artificial windbreaks such as snow or sand fencing.
15. The application of organic mulches such as hay, garden waste, forest land field waste, manure, wood chips, etc.
16. The indigenous or local species usually are the most appropriate. A diversity of species should be used rather than a single species, as a monoculture seldom sustains a permanent growth.

ACIDIC DRAINAGE

17.

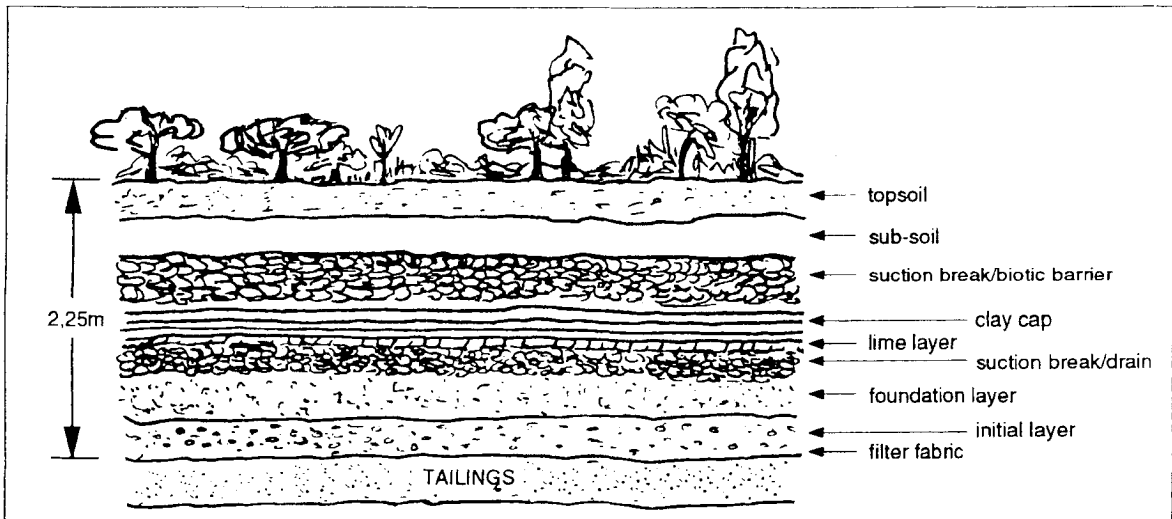

OXAN CREEK AND FORESTED AREAS

18. The correct option is Option 2.

Option 1 would require the excavation of large tonnages of tailings which would be costly. It would require a site on which to place the tailings, thus introducing another

potential costly activity. No matter how well contained, the tailings on each side of the channel would continue to leach pollutants into the stream.

Option 2 would require the excavation in bedrock and would form a very stable channel. There would be no leakage of contaminants from the tailings into the stream. The channel would be engineered and not subject to subsequent erosion back into the tailings.

MONITORING

19.

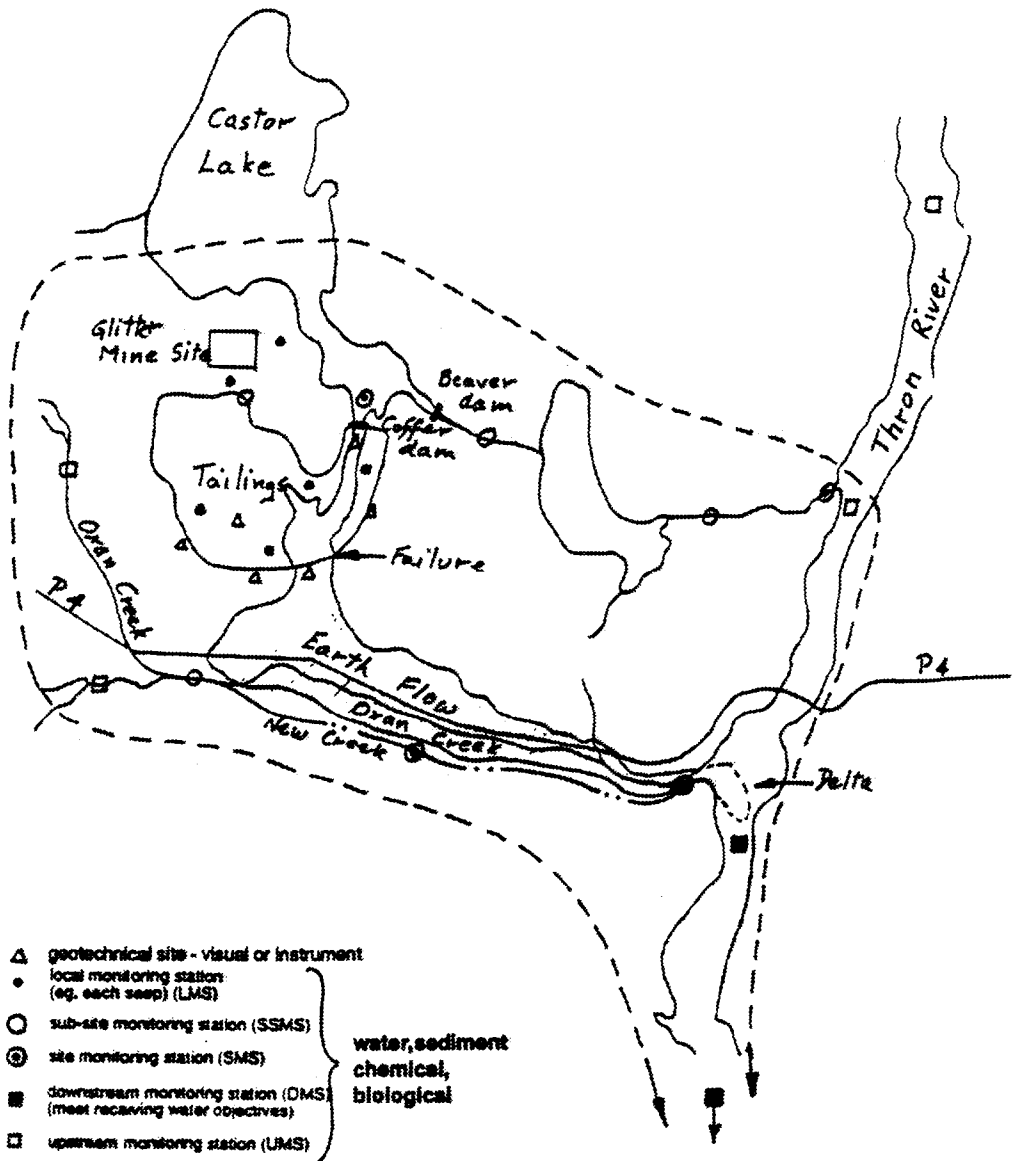

ANNEX

Examples of Environmental Legislation and Related Issues

(with special reference to Zimbabwe)

1. AUSTRALIAN LEGISLATION

1.1. New South Wales (NSW)

Mining and exploration companies tended to avoid NSW in the 1980s, due in part to the strong environmental legislation which had been enacted in the 1973 Mining Act and Coal Mining Act. Section 7 of these Acts contains provisions related specifically to protection of the environment.

For example, the Minister in deciding to grant a mining claim, lease or coal concession, "shall take into account the need to conserve and protect the flora, fauna, fisheries, scenic attractions and features of architectural, archaeological, historical or geological interest,..... and may cause studies including environmental impact studies to be carried out".

Conditions may be inserted in a mining lease relating to the conservation and protection of the above items. Conditions may also be inserted relating to:

- The reinstatement, levelling, regrassing, reforesting and contouring of any part of the mined area that may have been damaged or deleteriously affected by mining operations
- The filling-in, sealing or fencing-off of excavations, shafts and tunnels.

Before the advent of environmental legislation, due to community concern about certain types of mining in the 1960s, the Mines Department imposed various controls which were the forerunners of regulations. It's therefore interesting to compare NSW with Zimbabwe which is currently at this very stage. The Mines and Minerals Act does not contain comprehensive environmental regulations but the Ministry has started to impose controls and conditions on specific projects.

1.1.1. Procedure in Obtaining Authority to Mine in NSW

Once a mineral deposit has been proved up and is viable, the following procedure usually takes place. A mining lease is applied for. This entails, inter alia, placing an advertisement in a national and local newspaper indicating the location, by a plan, and the mining method to be adopted. This allows affected "stakeholders" to become aware of the application.

In NSW there is an umbrella piece of legislation known as the Environmental Planning and Assessment Act which requires proponents of any significant development project to obtain development consent from the local council. If the project is a "designated development", then the application for consent must be accompanied by an Environmental Impact Study. Any mining project which will disturb over 2 hectares of land is captured by this requirement. The EIS is normally displayed for 30 days to

allow the input of the community. The Council, with the advice of the Minister of Environment and Planning and the Department of Mineral Resources, when weighing the merits of the proposal, takes into account any submissions from the public.

Once the EIS is approved, the granting of the mining lease can take over a year. There are numerous (up to 13-) conditions attached to the lease designed to protect the environment relating to:

- Methods and controls related to opencast and underground mining
- Progressive rehabilitation
- Protection of rivers and other bodies of water
- Protection of fences, power lines, etc.
- Prevention of soil erosion
- The lodgement of security deposits which can be reviewed from time to time

A mining company also has to obtain approval from the Pollution Control Commission in the form of Clean Air, Clean Waters and Noise Control licences as well as a licence to pump water from the Department of Water.

From time to time, the mining company will have to submit an "Environmental Management Plan" to the Mines Department, which is normally a condition of the mining lease.

The approval process was lengthy. Procedures have improved in recent years and “fast-tracking” is common for important new projects. Planning focus meetings and other procedures have reduced the delay from application to mine development to less than six months. Exploration activities have “boomed” in recent years and major new mines have commenced, indicating that even though relatively stringent environmental regulations are in place, because they are clear and do not result in unnecessary delays, they are not a major impediment to development.

1.2. Queensland

Queensland and Western Australia once enjoyed a reputation as the preferred states to explore and mine. The governments recognised the importance of mining and were not prepared to implement mine environmental legislation. This has changed. Each state now requires mining companies to demonstrate responsible environmental management practices before, during and after mining.

The amended Queensland Mineral Resources Act 1989, strengthened the requirements for environmental protection in mines. The Queensland Department of Resource Industries adopted in 1992 an environmental policy for mining which incorporated the setting of rehabilitation bond securities, for a self-regulating, incentive based regulatory system. The objectives of the policy include:

- The achievement of acceptable post-disturbance land use

- A stable post-disturbance landform
- Preservation of down stream water quality

The policy applies to existing mines and new projects. Before a mining lease is granted for a project, the applicant has to prepare an environmental impact study describing the existing environment and the impacts expected from the operation. An Environmental Management Overview Strategy (EMOS) is then required which addresses environmental protection and mine rehabilitation over the life of the project and extends to the completion of rehabilitation of disturbed land. The strategy is based on practical options and demonstrated practice or research and includes costing, implementation and monitoring provisions.

The EMOS is related to a series of Performance Criteria which the mine can achieve from a conceptual "we will achieve an acceptable post-disturbance land-use, etc.", (category 6) to a demonstration that progressive rehabilitation and monitoring of environmental issues have been successfully carried out (category 1). The original EMOS is replaced by a "Plan of Operations" once the mine is operating.

The self-regulating part of the policy comes in the form of the security deposits, a most controversial aspect of mine environmental legislation. The EMOS and the later Plan of Operations will indicate

the level of disturbed ground on the mining lease. The security relates directly to this area. As the company achieves the categories of Performance Criteria, the security deposits decrease. For example, at Category 6 a mine has to submit 100% of the security, once it has achieved Category 1 only 25% is needed. A security deposit can be a million or more Australian dollars, the savings are therefore significant.

The policy is new and time will tell whether the industry can work practically within the rules and whether the government is able to cope with the massive load of environmental documents from the 1000 or so operations in the state.

2. ONTARIO LEGISLATION

The new Ontario Mining Act was proclaimed on June 3, 1991. The act introduces a new way of doing business relative to rehabilitation for the mining industry in Ontario. The act requires rehabilitation of all disturbed mining lands. To formulate and write the act a task force comprised of members of various government ministries, the mining industry, conservation groups, the general public, other industries and the agricultural sector was formed.

The exercise went through a two stage process. First, a "Green Paper" was produced, published and provided to any member of the public to make comments. After the input from the public the final act was

written by the same cross-section of stakeholders as comprised the original task force. The following is a brief summary of the contents of the act.

2.1. The Legislation

The ultimate objective of this legislation is self-regulation. The legislation requires the following:

- Preliminary Study or Environmental Impact Assessment prior to any major disturbance of the land/water base. Major disturbance in advanced exploration is defined as removal of 500 tonnes or stripping of more than 2,500 square meters.
- There are to be public notices and meetings throughout the life of the project operation
- If the property goes to production, an Operating Plan must be prepared and adhered to
- Before production can begin, a Closure (Rehabilitation) Plan must be submitted and approved by the Director of Rehabilitation
- The plan must be approved by experts from the Ministries of Mines, Environment and Energy, Natural Resources and Labour. Memoranda of Agreement have been drawn up between the Mines Ministry and the other three Ministries.
- Prior to approval, the Closure Plan has to go to public review
- Progressive rehabilitation must be undertaken at all times unless for technical reasons the Director has approved an exception
- An annual review of progress of operations and rehabilitation

is required

- The plan may be amended at any time but must obtain approval for any changes from the Director
- The operator must obtain the necessary permits from other Ministries, but under the terms of the Memoranda of Agreement, this can be done through the “One Window” approach
- The operator must adhere to all standards such as water quality, air emissions, effluents, safety, noise, etc.
- If an operator contravenes the Act they are subject to a fine of up to C\$30,000 per day while in contravention
- The approval requires the payment into a financial assurance fund held by the government. This is to ensure that the site is rehabilitated by a third party, if necessary, should the operator default in the rehabilitation for whatever reason. If there are funds remaining after successful completion of the rehabilitation, they are returned to the operator with the accrued interest
- With abandoned mines, should an owner be found, rehabilitation is required under the same conditions as an active or closed-out mine. If no owner is found the property becomes the obligation of Ontario who may either confiscate the site or place a lien against the property for the cost of the work done to rehabilitate it.

3. MINE ENVIRONMENTAL LEGISLATION IN AFRICA

3.1. South Africa

The Minerals Act, 1991, was implemented “to regulate the orderly

utilisation and the rehabilitation of the surface of land during and after prospecting and mining operations...". Following this was the concept of Integrated Environmental Management, designed to ensure that the environmental consequences of development are understood and adequately considered in the planning process. This was applied to the mining industry via the Environmental Management Programme Report (EMPR). The EMPR document is similar to an Environmental Impact Assessment report and includes the following:

- To meet the environmental requirements of the Mineral Act
- To provide a single document that will satisfy various authorities concerned with the regulation of the environmental impacts of mining
- To describe how the environmental impacts will be managed
- To describe how mine closure can be achieved.

A guideline to the preparation of the EMPR has been produced by the Department of Mineral and Energy Affairs and now every mine in South Africa is currently preparing or has already prepared an EMPR.

3.2. Namibia

The government of Namibia has implemented an Environmental Assessment Policy which requires proponents of prescribed activities to undertake environmental impact assessment before approval for the project is granted. The prescribed activities include "mining, mineral extraction and mine beneficiation".

3.3. Ghana

Guidelines are proposed to control the environmental impact of mining in Ghana. The guidelines are divided into three parts:

- Exploration, mining, mineral processing and decommissioning
- Environmental impact assessment
- Environmental action Plan

The proposed guidelines appear to be extremely comprehensive but at this stage they have not been officially promulgated.

It should be noted here that these three countries are characterised by a dominant large-scale mining sector with very few small scale miners, which is the reverse of the Zimbabwean situation.

4. MAJOR MINING ACTIVITIES IN AUSTRALIA AND THEIR ENVIRONMENTAL IMPACTS

4.1. New South Wales

Coal. The coal industry is the single largest export earner in Australia and in 1992-93 earned Z\$40 billion in revenues out of a minerals industry total of Z\$180 billion. In NSW the industry is highly mechanised with 8 opencast mines producing over 3 million tonnes of coal per annum and 22 underground mines producing over one million tonnes. By contrast, Wankie Colliery produced about 4,7 million tonnes from its opencast and 0,7 million from underground

operations in 1992-93.

The opencast mines are the major environmental impacts and are mostly located on grazing land. The mines are also close to one of Australia's top wine producing regions.

The major environmental effect from underground mines is in ground subsidence that has caused serious problems in residential areas and roads.

Base Metals. Broken Hill, since 1883, is the centre of silver, lead and zinc mining in NSW. The legacy of mining is evident in the black slag dumps, numerous headframes, and old and current slimes dams. Dust is a major environmental problem with severe dust storms until the 1970s, due to extensive deforestation to feed the lead smelters and for domestic fuel. A "regeneration area" or belt of greenery was established from 1980 and this, together with revegetation of the slimes dams, has helped to arrest the dust problem.

Gold. NSW was from the 1850s an important global producer of alluvial gold. Gold mining today is dominated by opencast workings with the major problems being disposal of waste rock and slimes.

Beach Sand Mining. Until the late 1970s, when most the mines were sterilised by the creation of new National Parks, NSW was the

largest producer of rutile, zircon, ilmenite and monazite in the world. Even though mining companies demonstrated that the rehabilitated mined areas were in many cases superior to the original, they are still opposed by a significant proportion of the population.

Gemstones. NSW is the world's largest producer of sapphire from alluvial mining. The major environmental impacts here are the protection of water quality and the preservation of superior agricultural land. The world's best black opal is mined at Lightning Ridge mainly by small scale underground methods. Unprotected open shafts are the major environmental hazard.

4.2. Queensland

Mining operations in Queensland are similar to NSW and often on a larger scale. There are massive opencast coal mines in central Queensland, some are operated by BHP. There is much gold mining mainly by opencast. Mount Isa, still a smelter town, is now a larger producer of base metals than Broken Hill. The world's largest magnesite mine has recently opened near Rockhampton.

4.3. Western Australia

Gold drives the West Australian economy. Ten years ago, Australia's annual gold production was the same as Zimbabwe's, around 15 tonnes. Now the production is over 250 tonnes while Zimbabwe's has stayed at around 15 tonnes. The majority of the increase has come

from WA. The boom came from the discovery of low grade halo deposits around old workings. Also, advances in geochemistry which can detect gold levels as low as PPB, major "virgin" deposits have been found.

Most of the mines are far from human habitation. The major environmental impacts include the disposal of wastes, high mortality rate of birds on the slimes dams, and the effect on the ground water levels as most companies source water from underground supplies.

Iron Ore. WA is one of the world's largest and most efficient producers of iron ore. The mines are remote, in the far North West of the state. Due to lack of rainfall the stabilisation and revegetation of waste dumps are a significant environmental problem.

Bauxite is mined in relatively wet areas covered by the rare jarrah forest. The mines are required to return the mined out areas back to jarrah which has been done quite successfully.

Diamonds. The world's largest diamond mine is Argyle in the far north of WA with an annual production of 40 million carats, of mainly industrial diamonds. It is extremely remote and the environmental impact of the site is mainly visual.

Beach Sands. A number of large scale dredging operations are

taking place. Major concerns are the integrity and quality of the underground water supplies and revegetation of coastal landforms.

4.4. Northern Territory

The north of the country is sparsely settled. A recent ruling by the courts stated that land titles, especially in the Northern Territory can now be vested in the Aboriginal population if it can be demonstrated that they have had a continuous connection with that land. What this means for mining is that the local Aboriginal population have the power of veto over mining.

The Kakadu Wetlands are also important as far as the environment and mining are concerned as in 1992 the Federal Government vetoed the mining of Coronation Hill within the Kakadu National Park. The deposit was in heavily degraded country and contained gold and platinum group metals worth around US\$2 billion. It was a political decision to soothe minority interest groups located in the capital cities. It remains one of the most controversial political decisions every made in Australia.

There is an active mining industry in the Northern Territory. It has two producing uranium mines and the significant environmental issues are pollution of surface and underground waters and the disposal of waste. The Australian government has adopted a uranium "policy" which only allows 3 mines to operate at any one time. As

the mines are opencast the presence of radon gas is not an issue.

The Territory also has gold mines and bauxite mines.

4.5. Tasmania

Mining has been very important to the economy of this state. Base metals, tin and iron ore are still being mined but at a reduced level. Most of the mines are located on the very wet west side and thus water pollution is a major issue.

5. CURRENT MINING AND ENVIRONMENTAL ISSUES IN AUSTRALIA

Mining is at the crossroads in Australia. There is now powerful legislation in all states and territories requiring mining companies to protect the environment. Mining companies are aware of this and are taking steps, and have done so in NSW for 20 years, to carry out responsible environmental management practices.

Within the industry there are now the environmental professionals who work as employees, consultants and contractors for the companies or government authorities that monitor and regulate them.

Small scale mining, with few exceptions such as the opal industry, do not have money or the skills to carry out the required studies themselves.

Other big losers are those mines situated near urban populations. The classic example is the East Coast beach sand mines..

Most Australians are urbanised and enjoy the benefits that the mining industry brings but are generally opposed to mining in the country. The media, in over the past 20 years, have been antagonistic towards the mining industry. The mining industry is now actively disseminating information on mining throughout schools and other forums. If the industry is to survive it must win the propaganda "war".

Clearly, one of the reasons that Zimbabwe and other locations are attractive to companies like BHP (platinum), Delta Gold/Masasa Mines (platinum, gold and diamonds), Auridiam (diamonds) is that there are still large areas of Zimbabwe available for prospecting. If a mineable deposit is found, it is most likely that this deposit can be mined. There is no guarantee of that happening in Australia at present.

6. ZIMBABWE MINE ENVIRONMENTAL MANAGEMENT PRACTICES

The year - 1992. The location - the majority of mine sites in Zimbabwe. The question to mine management - *"What environmental management practices are being implemented at your mine?"* The response - *"We have environmental control measures in place to ensure the health and safety of our underground workers, such as good ventilation, effective dust suppression, effective waterblasts and so*

on". "But what about the environment itself?" "Well we participate in the annual Natural Resources Board (NRB) mine dump competition."

This, with a few notable exceptions, seemed to be the state of environmental awareness among mine managers just a few years ago. A similar lack of awareness was prevalent in government. For example, the Department of Mining Engineering within the Ministry of Mines is charged with the responsibility of inspecting mines in accordance with the Mines and Minerals Act and its regulations. It restricted itself to matters of occupational health and safety and usually left environmental issues such as revegetation of waste dumps to other agencies such as the Natural Resources Board. The Ministry had established, in 1988, the Mine Ventilation and Environmental Control Centre, but its ambit was also restricted to occupational health and safety matters.

6.1. Problems from the Past in Zimbabwe

Mining in Zimbabwe has disturbed a relatively small area, estimated in 1993 at around 0,02% of its surface area. Nevertheless, the localised environmental impact has been severe as a result of some of these mining activities as evidenced by the following:

- **Pollution of Surface or Ground Water.** From process chemicals such as cyanide, mercury, xanthates, etc. and from acid mine drainage and heavy metals.
- **Airborne Dust Emissions.** From dumps, crushing and screening

plants, haulage, etc.

- **Airborne Gas Emissions.** From refineries, collieries, roasting plants, etc.
- **Human and Animal Exposure to Toxic Chemicals or Substances**
- **Soil Erosion and Siltation of Rivers.** From unstable dumps, gold panning, tree removal, river diversions, etc.
- **Destruction of Habitat for Vegetation and Wildlife.** From mining and processing operations and influx of human population including poaching, etc.
- **Alteration in Watertable.** From opencast, strip or alluvial mining and excessive pumping from aquifers.
- **Adverse Effects of Blasting.** Flyrock, ground vibration, noise and blast overpressure.
- **Unprotected Mine Shafts and Openings.**
- **Surface Subsidence.** From caved or collapsed stopes, crown pillar failure or worked out coal sections.
- **Exposure to Unwanted Noise.** From mineral processing, blasting
- **Visual Aspects.** Quarries, dumps, etc.
- **Special Problems.** Revegetation of dumps, spontaneous combustion of coal, etc.

6.2. The Exceptions

There are exceptions to this rule of environmental non-awareness in the past. One example is the Wankie opencast coal mine where progressive rehabilitation has been employed for a number of years.

The mine was one of the first to engage specialist environmental consultants who instituted revegetation trials at the mine six years ago. The early success of the rehabilitation program has been demonstrated by the establishment of a diverse mix of indigenous plants and bird and mammal population in the revegetated areas.

Some gold mines have put considerable resources into revegetating their tailings dumps. As far back as 1957 it was reported that the Golden Valley Mine in Kwe Kwe was testing the efficacy of rubber bush on its dump. A variety of exotic and indigenous grasses and tree species have been used over the years with varying success. Base metal mines such as Epoch Nickel and Mhangura Copper Mines have also been successful in dump revegetation, both using Port Jackson "Willows", actually an acacia or wattle species, not a willow, and the use of domestic refuse with considerable success.

A common thread in these success stories seems to have been the personal interest in environmental issues shown by a senior mine official, usually the mill superintendent, rather than from a specific corporate environmental policy.

7. EXISTING ZIMBABWE ENVIRONMENTAL LEGISLATION

The Ministry's Department of Mining Engineering has been responsible for the control and regulation of occupational health and safety on mines. Work practices have been regulated by the *Mining (Management*

and Safety) Regulations, 1990 and the Explosive Regulations, 1989.

There are references in the Mining Regulations to practices which may be classified as environmental protection or management including fencing of shafts and open excavations (Section 18), preventing surface subsidence (S19), surface deposition of coal and other wastes where there are "cracks or subsidence" (S20), precautions when using cyanide and other chemicals (S21,S22), precautions when treating arsenic ores (S23), prevention of escape of "poisonous or injurious substance" (S24), slimes and tailings dams and dumps to be constructed so as not to "endanger life or limb" (S25), drainage structures (S26), precautions against flooding of tailings dams and workings (S27), and precautions against dust (S71).

The closest reference in the *Mines and Minerals Act* to mine rehabilitation is a requirement for a miner to fill in or otherwise make safe all shafts and excavations (S252) before the Mining Commissioner will issue a "quittance certificate". The miner may also remove buildings and machinery from the mining location (S250). The owner or occupier of the land may object if the shaft protection is inadequate. The maximum penalty for non-compliance with these sections is Z\$200.

The closest reference to an Environmental Impact Assessment report is a requirement for a "siting of works" plan before erecting or constructing any works at the mine (S222). The Mining Commissioner

must notify affected stakeholders and relevant government officials of the receipt of the plan. Objections to the proposal are invited and the Mining Commissioner can conduct a hearing in an effort to resolve any concerns and he/she may approve the plan, approve the plan subject to amendment or refuse approval. It is possible for a miner to carry out various works before a plan is submitted including residences, roads and dumps.

Other legislation involving “environmental” issues which affect mining operations in Zimbabwe include:

- *The Hazardous Substances and Articles Control Act, 1972*, administered by the Ministry of Health also deals with the use and control of hazardous substances on mines.
- *The Mining (Health and Sanitation) Regulations, 1977*, administered by the same Ministry makes provisions for adequate hygiene in and about mines.
- *The Mining (Alluvial Gold) (Public Streams) Regulations (1991)* deals with small scale gold panning and places restrictions on the miner and the minimum distance he/she can work from a river bank”.
- *The Water Act (1976)* makes provision for the prevention of water pollution and the preservation of water resources and is controlled by the Ministry of Lands, Agriculture and Water Development.
- *The Natural Resources Amendment Act (1975)* deals generally with the conservation of natural resources and is administered by the Natural Resources Board.

- The *Atmospheric Pollution Prevention Act (1971)* is the responsibility of the Ministry of Health and is concerned with the prevention and control of air pollution by gases, dust, fumes and smoke.
- The *Forest Act (1949)* is designed to protect forests and trees and is controlled by the Forestry Commission.
- The *Parks and Wildlife Act (1975)* is administered by the Department of the National Parks and Wildlife and deals with the preservation of plants and animals, including specially protected animals and indigenous plants.
- The *National Museums and Monuments Act (1972)* provides for the protection of sites of historic or cultural interest.

The legislation is fragmented and incomplete. There is no requirement for a mine to be completely rehabilitated during the life of the mine or after closure. There is no requirement for an EIA to be submitted and approved before a mine commences. It is inefficient for so many government agencies to be monitoring a mining operation, particularly when the resources of government are being stretched to the limit. Finally the clear unambiguous environmental policies which new investors look for are not present.

8. FUTURE MINE ENVIRONMENTAL LEGISLATION AND ENVIRONMENTAL MANAGEMENT PRACTICES IN ZIMBABWE

There are very strong forces at work which are forcing all industries

in Zimbabwe, including the mining industry, to adopt responsible environmental management practices. These forces include:

- A worldwide awareness of the environment and realisation that the mining resources are finite and must be better managed.
- The commitment of the Government of Zimbabwe to the UNCED process and the incorporation of Environmental Impact Assessment requirements into the second Five-Year Development Plan. The Ministry of Environment and Tourism's Interim EIA policy is a product of that commitment.
- Various reports by SADC and others highlighting deficiencies in environmental management in Zimbabwean mines.
- Recent massive investments in several new mining projects.
- The unprecedented exploration taking place and soon to take place with large areas now covered by Exclusive Prospecting Orders.
- A requirement of international loan agencies such as the International Finance Corporation and the Africa Development Bank for mining loan applications to be accompanied by environmental impact assessment studies.
- Adverse international publicity as a result of global mine environmental incidents, such as the extensive pollution from the ZCCM copper operations in Zambia.

3.1. Industrial Initiatives

The local mining industry has responded to the above by:

- The formation of an environmental sub-committee of the Chamber

of Mines

- Development of corporate policies on environmental management.
- The appointment of senior managers responsible for environmental affairs, separate from health and safety
- The appointment of in-house, qualified environmental specialists or the engagement of environmental consultants to review the environmental aspects of company operations, advise on revegetation, advise on the stability of waste and slime dumps and carry out research into the use of advanced rehabilitation techniques such as hydromulching and other measures
- The preparation of closure and environmental management plans

The larger companies, with their greater resources are the leaders in these innovations. It remains to be seen whether these firms will succeed in encouraging other companies, both large and small, to improve their environmental performance. Self-regulation is being encouraged in environmental matters in other parts of the mining world but although desirable, it is probably an unattainable objective for a developing nation like Zimbabwe.

8.2. Ministry Initiatives

The Ministry of Mines instituted its environmental program about two years ago. A structured approach was adopted with the following aims and objectives. The initiatives had to:

- Be consistent with the Ministry's policies of promoting the

responsible development of the country's mineral resources to ensure a healthy and vibrant mining industry.

- Ensure that the country's natural resource assets are not degraded by exploration, mining or mineral processing activities.
- Encourage new investment in exploration and mining from both existing mining companies as well as foreign investors.
- Be consistent with the recently announced EIA policy of the Ministry of Environment and Tourism.
- Avoid duplication in regulation and monitoring with other government agencies.
- Take cognisance of the formal small scale mining industry.
- As far as possible encourage self-regulation in the industry.
- Consistent with the principles of smaller, more efficient government, ensure as far as possible that control of all mining activities including environment management, remains within the the ambit of Ministry of Mines.

The Ministry has accordingly, over the last two years, implemented the following initiatives:

- A set of practical environmental management guidelines.
- An environmental management policy containing, *inter alia*, the need for environmental impact assessment for significant, new projects or significant expansions to existing operations and a future requirement for environmental management plans for all significant existing operations.

- Training courses in environmental management practices for mine inspectors.
- Pre-development, on-site meetings between proponents and government officials to discuss the environmental management aspects of the proposal.

8.3. Environmental Management Guidelines for Mining and Exploration in Zimbabwe

The guidelines are designed to assist mine operators in the implementation of responsible environmental management practices. The guidelines cover the whole range of mining activities in Zimbabwe.

Each mine is unique with a distinct set of environmental issues. For this reason the guidelines have been kept as general as possible without the specifics demanded by legislation. They were designed to be a "first step" in creating environmental awareness and in improving environmental management performance at each mine.

The guidelines have been produced in consultation with the Chamber of Mines, mining houses, the Ministry of Environment and Tourism, University of Zimbabwe and officers of the Ministry of Mines and drawn on local experience and similar practices elsewhere. The guidelines were designed to offer assistance to mine management and there is no legislative compulsion for their adoption. They are not

“set in concrete” but are meant to be a dynamic, evolving document which can be amended or added to as and when appropriate.

8.4. The Environmental Management Policy

The environmental management policy was developed by the Ministry's Department of Mining Engineering, the department responsible for regulation of mines in Zimbabwe. It consists of a “package” of initiatives which will enable the department to respond more effectively to environmental issues in the mining industry.

The policy itself consist of three parts:

- A mission statement
- Environmental impact assessment reports and environmental management plans
- The guidelines referred to above.

8.4.1. Mission Statement

“The Department of Mining Engineering is committed to the safe and efficient extraction of the mineral resources of Zimbabwe and the promotion of responsible environmental management practices, consistent with the national policy of sustainable development of Zimbabwe's valuable natural resource base”.

8.4.2. Environmental Impact Assessment

In 1994, the Ministry of Environment and Tourism (MET) adopted an

Environmental Impact Assessment (EIA) policy requiring proponents of new "major" activities in Zimbabwe to consult with it to determine if the activity will require the preparation of an EIA document. The list of "prescribed activities" is comprehensive and diverse and as far as the mining industry is concerned includes "mineral prospecting, mineral mining, ore processing and concentrating and quarrying".

The Ministry of Mines believes it has a role to play in this process and as part of its policy it is supporting the national EIA policy. The Ministry's policy includes a "check list" of items to be included in a mining EIA and recommends that companies consult with the Ministry before the study is undertaken. Again, there is no compulsion for compliance but it is our belief that the Ministry, with its expertise in mining matters, can provide material assistance to companies involved in the EIA process.

To distinguish between very small scale and other forms of mining, a "major" mine or quarry is defined as one in which more than 10 000 tonnes of ore or rock are mined or milled or a surface area of more than two (2) hectares is disturbed each year.

It is proposed that new small workings will need to complete a brief "Statement of Environmental Effects" which will include a brief description of the project, any environmental hazards

identified and their mitigation, and a plan showing the location of all works, rather than a full EIA.

The purposes of an Environmental Impact Assessment are to:

- Identify any environmental constraints on a mining development in a particular location.
- Provide the basis for a plan for environmental management and protection.
- To ensure that the decision maker(s), and the community are fully informed of the nature of the development, its impact on the environment and the nature of the mitigating measures proposed.

The information contained in the EIA should provide the Ministry with a clear understanding of the mining proposal and its potential impacts and should include:

- A description of the project
- A description of the existing environment
- An analysis of the likely environmental impacts and the measures to be taken to minimise the impacts
- Details of future environmental site monitoring

The information should be clear, succinct and objective and should be supported where appropriate by maps, plans and photographs.

8.4.3. Environmental Management Plans

Experience elsewhere has shown that companies tend to outlay considerable resources in preparing an EIA. Once approval has been given, the EIA is filed away and environmental matters are quickly forgotten. The information in the EIA should be the basis of the environmental management operating plan (EMP). An EMP compliments the EIA and reflects changes made in mine planning and operations over time and the environmental impact. It also indicates progress in mine rehabilitation and includes the results of environmental monitoring programs on any potential pollution problem areas. It will include the latest thinking on mine closure options.

It is proposed in the policy that major current mines will be requested to prepare and submit EMPs, commencing in 1996. The EMP will be a dynamic document and updates to the plan will be required from time to time. The cycle will be contingent on Departmental staff resources being available to review the documents, inspect the sites and provide feedback to the mine operators. Again, the policy includes a guide to the preparation of the plan.

8.4.4. Training Courses in Environmental Management for Mines Inspectors

It is all well and good for the Ministry to initiate an environmental

management policy and better if all participants in the industry voluntarily adopt the spirit of the policy and the industry becomes self-regulating. The environmental mission statement would than have been fulfilled. However, this will not happen and some members of the industry will ignore or flout the recommended practices. Others, particularly small workers, may not understand the policy and it is therefore necessary for government to assist and advise in this regard.

Governments worldwide are tending to become smaller and more efficient and it is believed that the most efficient way for government to monitor environmental performance is for mines inspectors to perform this function as part of their routine inspectorial duties. Specialist advice from other government agencies such as the Department of Water Resources and the Natural Resources Board will be needed from time to time.

With the assistance of Canadian funding, the Ministry is developing a short course training program in environmental management for mines inspectors. This course will be held in Bulawayo, with a local course content for all government mines inspectors, engineers and technicians. The course will be designed specifically for Zimbabwean conditions. Visits to mines exhibiting both good and poor examples of environmental management will be a feature of the course. The first course will commence in August, 1995.

8.4.5. Pre-Development Site Meetings

The concept of these meetings is well established in Australia and Ontario, Canada, and allows the company to present details of the mining project and measures to protect the environment at a gathering of all affected government departments and members of the community. The concept has been successfully trialled in Zimbabwe at the BHP Hartley Platinum Project and included representatives from the Ministry of Mines, Ministry of Environment and Tourism, Natural Resources Board, and the Department of Water Resources. Depending on the location, additional invitees may include Agritex, National Parks and Wildlife Management and the Forestry Department. Attendance can also be expanded to other affected groups including local councils, farmer's organisations, local chiefs and even groups perceived to be opposed to mining. Rio Tinto's recent presentations to the Wildlife Society on its exploration work in Hwange National Park is an excellent example of a mining company not afraid to inform the public about its environmental programs.

9. THE FUTURE

9.1. Ministry of Environment and Tourism

Apart from the EIA policy mentioned earlier, the Ministry of Environment and Tourism has issued a "public discussion document" on "Environmental Assessment in Zimbabwe". In this document a number of preferred positions are stated, one of which is that, in

order to mandate environmental assessment, the Ministry should “develop a new environmental management act”. This new Act “would also permit the definition of needed areas of precedence over existing legislation, with corresponding amendments of such existing legislation - e.g. Mines and Minerals Act”.

The existence of a good mining law is one of the essential ingredients required by mining companies when considering investment in a foreign country. The law must give companies reasonable access to prospective ground and security of tenure if an ore deposit is discovered. The Mines and Minerals Act is able to provide both and it is one of the principal reasons for the significant levels of foreign and local investment in the industry at present. The provisions of the Act allows exploration activities to be carried out over most of the prospective areas of Zimbabwe. In comparison, 23% of Australia has now been sterilised or is unavailable for exploration. That is equivalent to over 4,5 times the total area of Zimbabwe. The result is that Australians, which rely on the jobs and downstream benefits of mining, and the world, which requires it minerals, will never know if a major resource is present within that 23% or not.

It can be argued that sound land use decisions should be based on as much information as possible and this includes knowledge on mineral occurrence. Should large areas of Zimbabwe be similarly reserved from exploration, the country may miss out on discovering another

Hartley Platinum or similar world class resource.

This not to say that there are no areas of environmental sensitivity in Zimbabwe. Clearly there are many areas of great scenic beauty, of cultural and historical significance, and with unique wildlife and vegetation communities which should be protected. However, exploration techniques are now so advanced that geologists and geophysicists can obtain much information about the mineral potential of an area without using environmentally unfriendly methods. Furthermore, if a viable deposit is found in a "sensitive" area the onus will be on the company to prove via the EIA process that it can be mined without creating long term environmental damage. If it cannot do so then it can be argued that the project should not proceed. If approval is obtained, the preparation of rehabilitation plans, company-initiated environmental monitoring and auditing and regular monitoring by government official will reduce the environmental risk.

9.2. New Environmental Regulations

Rather than weakening the Mines and Minerals Act, which has been suggested in some quarters, why not strengthen it by addition regulations which will compel mining companies to protect the environment? The Ministry of Mines has now started the process of preparing draft environmental regulations as the final step in the structured approach outlined earlier. Regulations will give "teeth"

to the policy and guidelines and will be further insurance that environmentally-sensitive areas of the country will be protected.

There are a number of models from industrialised countries such as the USA, Canada and Australia that Zimbabwe could use as a basis for its legislation. South Africa has the Mineral Act, No. 50 of 1991 as well as a requirement for all mines to submit environmental management program reports (EMPR). Namibia has the Minerals (Prospecting and Mining) Act, 1991, certain sections of which are devoted to environmental protection. Ghana has developed its own set of mining environmental guidelines. Countries in South America or Asia have mine environmental legislation which may be a model Zimbabwe.

However, none of these can be simply adopted and applied to the local context. Lessons and experiences from these Acts should be considered but whatever Act is proclaimed for Zimbabwe it must be relevant to practices within the Zimbabwean mining industry. It must recognise the importance of a healthy and vibrant industry to the continued socio-economic development of the country and it must protect its valuable natural resource base.

10. THE FUTURE ROLE OF THE MINES INSPECTORATE IN ENVIRONMENTAL MANAGEMENT

You might ask, why should mines inspectors get involved in

environmental issues? Why can't that be left to the ecologist or environmentalists? The reason is that environmental matters are inextricably linked to the mining and metallurgical processes as you have already heard on a number of occasions throughout this course. Let's look at the Wankie Colliery Company's strip mining operation. The major environmental issues here are the progressive dumping of overburden by the dragline and the covering of this with the inert supplementary stripping material and reshaping with bulldozers to avoid both large holes in the ground and to suppress spontaneous combustion. This is progressive mine rehabilitation and involves the scheduling and availability of equipment. This is not the job of an ecologist. Of course a specialist will be needed to advise on the optimum mix of fertiliser, soil conditioners and seed to ensure a stable vegetative cover.

Governments world wide are tending to become leaner and more efficient. A similar trend is occurring here in Zimbabwe, we have to learn to do more with less. There has to be less duplication of services and overlapping of duties. You are all aware of the high cost of money for small and medium scale businesses to enable them to borrow to finance expansions or even working capital. It is the emergent indigenous business person who is being hit particularly hard. There has been talk in recent times of governments have to reduce expenditure. At the moment, it is a massive 46% of GDP, a figure of 25% of GDP has been suggested as a target. What this means

is that all government departments will need to trim down. In the case of the Ministry of Mines it means that it is unlikely that there will be massive recruitment for new positions, in fact those vacant posts may never be filled. But hopefully, there will be sufficient funding to do the mines inspectorate duties in a better manner. This translates to more routine inspections, as well as ensuring that all aspects of the mining or exploration operation are scrutinised at the one time. The environment is one such important issue.

At present there is no clearly defined role for any government official as far as environmental management inspections on mines in concerned.

Let us examine each Ministry or Department and their present role.

10.1. Ministry of Mines

As we have heard in a previous lecture there are assorted references to environmental management in both the Mines and Minerals Acts and the Mine (Management and Safety) Regulations.

Now my question to you all is when did you last specifically check environmental matters already included in legislation? It has probably been a while and that is understandable because the major role of the mines inspectorate in Zimbabwe has been on health and safety matters not environmental protection.

The closest reference to an Environmental Impact Assessment report is a requirement for a "siting of works" plan before erecting or constructing any works at the mine (S222).

Again, how many new mining projects both large and small scale have not proceeded in Zimbabwe due to concerns about the environment? I believe it is imperative that new mining projects both large and small take cognisance of the impacts that the operations will have on the environment. The siting of works plan is a good first step but it doesn't go far enough in this age of environmental awareness. Environmental impact assessment reports should be submitted, so that government agencies, local residents, the general public and the mining companies themselves are aware of environmental impact.

10.2. Ministry of Environment and Tourism

This Ministry has promulgated its Environmental Impact Assessment Policy which requires proponents of new "major" activities in Zimbabwe to consult with it to determine if the activity will require the preparation of an EIA document. An important point to note here is that there is no compulsion on mining companies to submit the EIA, it is a government policy not a regulation. An "Environmental Assessment Act" is in the process of being drafted but this is some time off. The Ministry doesn't

have its own inspectors for environmental monitoring and as far as can be ascertained does not intend to employ such personnel in the future. The thrust of a recently published position paper on environmental impact assessment is that there should be a form of environmental auditing built into the EIA process which puts the onus on industry and not on the government for the monitoring.

10.3 Department of Natural Resources

This department has a field services branch with officers who travel the country ensuring that no breaches are made to the provisions of the Natural Resources Act. The Department encourages responsible environmental practices at mines and each year hosts the Annual Mine Dump competition. Its officers visit mine sites from time to time and reports on environmental practices are made. Because the inspectors are not mining trained, some of the reports are technically inaccurate.

10.4. Department of Water Resources

Officers of this department visit mines to check on the compliance with the Water Act, 1976. One of the more recent problem areas involved an officer who insisted on prosecuting the managing director of a company for an acid mine drainage problem which dated back to a mine which started in 1903. The official did not understand mining nor was he interested in learning the situation

10.5. Ministry of Health

Officers of this ministry are involved with a number of acts that relate to mining. However, mines inspectors should have the skills to advise on any breaches of these Acts, and call for assistance from the Ministry of Health if necessary.

Mine managers are extremely busy people. They do not want to be visited by inspectors of NRB one day, mines inspectors the next, health officials the next, local council the next and so on. We believe that the inspectorate should have the major responsibility for environmental matters. If a problem exists and it is the area of responsibility of NRB, health, etc., the inspector should notify the sister agency and inform them of the measures taken to rectify the problem or refer the problem to the appropriate Ministry.



United Nations Environment Programme
Industry and Environment Centre
39-43 quai André Citroën
75739 Paris Cedex 15
France
Tel: 33 1 44 37 14 50
Fax: 33 1 44 37 14 74
e-mail: unepie@unep.fr
<http://www.unepie.org>

World Health Organisation
European Centre for Environment and Health
(ECEH)
Rome Operational Division
Solid Waste Programme
Via Francesco Crispi, 10
I-00187 Rome
Italy
Tel: 39 6 48 77 51
Fax: 39 6 48 77 599
e-mail: ecehr@who.it

