



SOLID WASTE MANAGEMENT

UNITED NATIONS ENVIRONMENT PROGRAMME



CalRecovery
INCORPORATED

Copyright © United Nations Environment Programme, (2005)

This publication may be reproduced in whole or in part and in any form for educational or non-profit purposes without special permission from the copyright holder, provided acknowledgement of the source is made. UNEP would appreciate receiving a copy of any publication that uses this publication as a source.

No use of this publication may be made for resale or for any other commercial purpose whatsoever without prior permission in writing from the United Nations Environment Programme.

Disclaimer

The designations employed and the presentation of the material in this publication do not imply the expression of any opinion whatsoever on the part of the United Nations Environment Programme concerning the legal status of any country, territory, city or area or of its authorities, or concerning delimitation of its frontiers or boundaries. Moreover, the views expressed do not necessarily represent the decision or the stated policy of the United Nations Environment Programme, nor does citing of trade names or commercial processes constitute endorsement.

ISBN: 92-807-2676-5

Solid Waste Management

(Volume I)



PREFACE

The collection, transport, treatment, and disposal of solid wastes, particularly wastes generated in medium and large urban centres, have become a relatively difficult problem to solve for those responsible for their management. The problem is even more acute in economically developing countries, where financial, human, and other critical resources generally are scarce.

One important contribution to the difficulties related to waste management is that which can be achieved by providing objective, reliable, and useful information to professionals in developing countries and to those from industrialized countries who may be called upon to provide assistance to those countries.

Although several publications deal with a variety of topics in the field of solid waste management, most of these documents have been published to address the needs of industrialized nations. Only a few documents have been specifically written to provide the type of information that is required by those in developing countries. Consequently, the UNEP, IETC published the *International Source Book on Environmentally Sound Technologies for Municipal Solid Waste Management* (1996). Similarly, the authors of this document prepared a book entitled *Solid Waste Management for Economically Developing Countries* (1996), which has undergone some revisions. The need was identified to update both documents once again. To maximize the use of limited available resources, it was decided to combine information from both documents, update some of the information as needed, and convert the two publications into a single document that could best serve the needs of developing countries.

This publication has been prepared primarily for two audiences: 1) decision-makers and policy makers, and 2) professionals involved in the management of solid wastes. The information in the publication would also be useful to students in environmental engineering. The material is presented such that most chapters need not be read in any particular sequence. However, if a formal class is based on the book, the chapters should be covered in sequential order.



Luis F. Diaz
President, CalRecovery, Inc.



Per Bakken
Director, IETC

Solid Waste Management:

(Volume I)

TABLE OF CONTENTS

ACKNOWLEDGEMENTS	xvii
------------------------	------

Part I - Principles of Solid Waste Management

CHAPTER I. INTRODUCTION	1
A. Definition of developmental status	1
B. Characteristics of solid waste in developing countries	1
C. Importance of a sound solid waste management program	2
C1. ENVIRONMENTAL and health impacts	3
C2. EPIDEMIOLOGICAL studies	3
D. Recovery and utilisation of resources	4
E. Scope and organisation of the book	4
F. References	6
CHAPTER II. FRAMEWORK FOR MANAGEMENT OF SOLID WASTE	7
A. Integrated waste management	7
A1. ELEMENTS of a waste management system	7
A2. WHAT is integrated waste management?	7
A3. IMPORTANCE of an integrated approach	8
A4. METHODS for integrating a waste system	8
A5. WASTE management hierarchy as a key element of 8 integrated solid waste management	8
B. Stakeholders	9
B1. RESIDENTIAL waste generators	9
B2. BUSINESS waste generators	9
B3. PUBLIC health and sanitation departments	10
B4. PUBLIC works departments	10
B5. NATURAL resource management agencies	10
B6. NATIONAL or state/provincial environmental ministries	10
B7. MUNICIPAL governments	10
B8. REGIONAL governments	10
B9. PRIVATE sector companies	10
B10. INFORMAL sector workers and enterprises	11
B11. NON-GOVERNMENTAL organisations	11
B12. COMMUNITY-BASED organisations	11
B13. POOR and residents of marginal and squatter areas	11
B14. WOMEN	11
C. Cost and cost recovery	12
C1. FEES and charges	12
C2. STRUCTURING financing for waste management systems	13

C3. STRATEGIES for cost containment and enhanced efficiency.....	13
D. Other important issues and strategies	15
D1. UNDERSTANDING characteristics of waste generated.....	15
D2. MAJOR differences between industrialised and developing countries.....	15
D3. IMPROVING management capabilities.....	16
D4. PUBLIC involvement.....	16
D5. SPECIAL wastes	16
D6. WASTE reduction	26
D7. SYSTEMS of waste reduction.....	28
D8. PRIORITIES for cities of developing countries.....	29
E. Summary.....	29
F. Reference.....	30
CHAPTER III. WASTE QUANTITIES AND CHARACTERISTICS	31
A. Introduction.....	31
B. Quantities and composition.....	32
B1. PROCEDURES	32
C. Other characteristics	39
C1. BULK density.....	39
C2. SIZE distribution	40
C3. CHEMICAL/thermal properties	43
C4. MECHANICAL properties.....	43
D. References.....	48
CHAPTER IV. STORAGE AND COLLECTION	51
A. Introduction.....	51
A1. LOW coverage in the provision of services	51
A2. APPLICATION of inappropriate technology	51
A3. TENDENCIES to acquire imported equipment	52
A4. INADEQUATE resource mobilisation.....	53
A5. INAPPROPRIATE methods of finance	53
B. Overview of present situation	53
C. Problems of storage and collection.....	55
D. Components of refuse collection.....	56
D1. SOURCES and characteristics of the refuse	57
D2. FREQUENCY of collection	59
D3. COMMUNAL storage.....	59
D4. HOUSE-TO-HOUSE collection.....	59
D5. COST	60
E. Methods of refuse storage	60
E1. DOMESTIC and commercial wastes	60
F. Communal storage methods.....	65
F1. DEPOTS.....	65
F2. ENCLOSURES	66
F3. FIXED storage bins.....	66
F4. SECTIONS of concrete pipe.....	67
F5. METAL drums	68
F6. PORTABLE bins	69
F7. CONCLUSIONS regarding communal waste containers	70
F8. CAPACITY margins.....	71

G. Collection vehicles	71
G1. HANDCARTS	72
G2. PEDAL tricycles.....	75
G3. ANIMAL carts.....	77
G4. MOTORIZED tricycles	77
G5. TRACTOR and trailer systems	78
G6. LIGHT commercial trucks	79
G7. FORE and aft tipper.....	80
G8. CONTAINER-HOIST	81
G9. VEHICLE standardisation.....	81
H. Access and point of collection.....	82
H1. DETACHED dwellings	82
H2. MULTI-FAMILY dwellings	83
H3. SINGLE-ROOM dwellings	83
H4. MARKETS	83
H5. ACCESS for trailer or container exchange	84
H6. NARROW paths/alleys	84
I. Basic collection systems	84
I1. COMMUNAL collection	85
I2. BLOCK collection	86
I3. KERBSIDE collection	86
I4. DOOR-TO-DOOR collection	86
I5. EVALUATION of basic systems	87
J. Primary and secondary collection.....	88
J1. SHORT-HAUL transfer.....	88
J2. COMPARATIVE labour and vehicle productivity	90
J3. SHORT-HAUL transfer station facilities	90
J4. LEVEL sites.....	91
J5. COMBINED transfer stations and district depots	91
K. Large-scale transfer stations	91
L. Transfer station planning and design	94
L1. SITE selection.....	94
L2. DESIGN of structures	94
L3. TRANSFER operations and plant layout.....	95
L4. CONCLUSIONS.....	107
M. Costs of solid waste collection.....	108
M1. SYSTEM costs.....	108
M2. COLLECTION from communal containers	111
M3. KERBSIDE and door-to-door collection.....	111
M4. OPERATION of collection vehicles in relay	113
M5. OPTIMISATION of vehicle routes	114
M6. COSTS of alternative systems	114
N. References.....	117
CHAPTER V. STREET CLEANING.....	119
A. Introduction.....	119
B. Types of street wastes	121
B1. WASTES generated by natural causes	121
B2. WASTES generated by traffic	121
B3. WASTES generated by the public	122

C. Manual street cleaning	122
C1. EQUIPMENT	122
D. Mechanical sweeping	123
E. Design of sweeping systems	125
E1. VEHICLES	125
E2. SCHEDULING	126
E3. ORGANISATION of manual sweepers	126
E4. TRANSFER facility	127
F. Litter bins	127
F1. DESIGN of litter bins.....	127
F2. SITING and emptying.....	128
G. Legislation	128
H. Reference	129

Part II - Processing and Treatment

CHAPTER VI. MATERIALS RECOVERY AND RECYCLING	131
A. Introduction	131
B. Manual separation	132
C. Mechanical separation	133
C1. SIZE reduction.....	133
C2. AIR classification	143
C3. SCREENING	146
C4. MAGNETIC separation.....	149
C5. ALUMINIUM and glass separation	152
C6. DRYING and densification	152
D. Design of processing facilities	152
D1. GENERAL design concepts	152
D2. FACILITY for processing source-separated MSW	159
D3. FACILITY for processing mixed waste	163
D4. CONCLUSIONS	165
E. Yard waste and food waste processing	166
E1. YARD waste	166
E2. FOOD waste.....	171
E3. COMPOSTING of mixtures of yard and food wastes	172
E4. PRECAUTIONS	173
F. Processing and recycling construction and demolition debris	173
F1. CONCRETE.....	174
F2. TECHNOLOGIES	174
F3. STATUS of concrete recycling	175
F4. REPRESENTATIVE projects.....	175
F5. SUMMARY and conclusions	179
G. References	180
CHAPTER VII. USE OF WASTE-DERIVED ORGANIC MATTER AS A SOIL AMENDMENT	183
A. Introduction	183
B. Utilisation of raw organic waste	183
B1. PREPARATION	183

B2. PARTICLE size	183
B3. DEHYDRATION	184
B4. EXAMPLE of direct application	184
C. Evaluation of direct application	185
C1. ADVANTAGES	185
C2. DISADVANTAGES.....	185
D. Economics	186
E. Use of composted waste	186
E1. DESCRIPTION of product	186
E2. APPEARANCE	187
E3. PRODUCT specifications	187
E4. GRADING the product	188
E5. METHOD of applying	189
E6. LOADING rate	189
F. Benefits from the application of compost to the soil	192
G. Limitations to the application of compost to the soil	193
G1. PUBLIC health	194
G2. TRANSPORT and application mechanics	194
H. References	195
CHAPTER VIII. COMPOSTING	197
A. Introduction.....	197
B. Definitions.....	197
B1. DEFINITION in the strict sense	197
B2. ECOLOGICAL definition	198
C. Active organisms.....	198
C1. VERMICULTURE	198
C2. INOCULUMS.....	199
D. Process factors.....	200
D1. NUTRITIONAL factors	200
D2. ENVIRONMENTAL factors.....	203
D3. AERATION.....	205
D4. OPERATIONAL parameters.....	207
E. Technology.....	213
E1. PRINCIPLES	213
E2. EQUIPMENT	213
E3. BIOFILTERS	214
E4. SYSTEM selection decision factors	216
F. Types of compost systems.....	216
F1. WINDROW systems	216
F2. IN-VESSEL reactors.....	225
G. Marketing and distribution of compost.....	229
G1. POTENTIAL markets	229
G2. SELLING price	230
G3. MARKET development.....	231
G4. PRODUCT distribution and transport.....	232
H. References	233

CHAPTER IX. SINGLE-CELL PROTEIN AND ETHANOL PRODUCTION.....	237
A. Introduction.....	237
A1. EXPLANATION of the concept	237
A2. HISTORICAL development.....	237
A3. APPLICABILITY to developing countries.....	238
B. Hydrolysis	238
B1. PRINCIPLES of hydrolysis	238
B2. ACID hydrolysis	239
B3. ENZYMATIC hydrolysis	240
B4. PRODUCTION system.....	243
C. Single-cell protein	244
C1. INDIRECT vs. direct production.....	246
C2. HARVESTING.....	249
C3. EQUIPMENT requirements and costs.....	250
D. Ethanol production.....	251
E. References.....	251
CHAPTER X. TYPES OF WASTE-TO-ENERGY SYSTEMS.....	253
A. Introduction.....	253
B. Incineration and refuse-derived fuel production.....	253
B1. FUEL characteristics	253
B2. INCINERATION.....	255
B3. REFUSE-DERIVED fuel production	256
C. Thermal gasification and biogasification	256
D. References.....	257
CHAPTER XI. BIOGASIFICATION	259
A. Introduction.....	259
B. Principles	259
B1. DEFINITIONS	259
C. Process description	260
C1. MICROBIAL ecology of the stages	261
D. Process rate limitation factors	263
D1. ENVIRONMENTAL factors.....	263
D2. PERFORMANCE factors.....	268
D3. FACTORS in the form of elements or compounds	268
E. Parameters.....	269
E1. GAS production and composition.....	269
E2. DESTRUCTION of volatile matter	272
E3. VOLATILE acid content	272
E4. HYDROGEN ion concentration	272
E5. BUFFERING capacity	273
E6. REMEDIAL measures	273
F. Operational procedures.....	273
F1. MIXING	273
F2. LOADING.....	276
F3. DETENTION time	276
F4. STARTING a digester.....	278

G. Digester construction design principles.....	279
G1. CONVENTIONAL digestion systems	279
G2. HIGH-RATE digestion systems	279
G3. “CONTACT” digestion systems	280
G4. HEATING the digester	280
G5. SMALL-SCALE digester design and construction.....	281
H. End products of the biogasification process.....	285
H1. PROPERTIES of the biogas	285
H2. BIOGAS purification.....	285
H3. USE of purified gas	287
I. Residues.....	287
I1. SUPERNATANT	287
I2. SLUDGE (biosolids).....	288
J. Feasibility considerations.....	289
J1. LARGE-SCALE undertakings	290
J2. SMALL-SCALE undertakings	291
K. References	292

CHAPTER XII. PRODUCTION OF REFUSE-DERIVED FUEL (RDF).....295

A. Background	295
B. RDF characteristics	298
C. Use of RDF.....	299
D. Presence of contaminants.....	299
E. Beneficiation of RDF.....	300
E1. HEATING value	300
E2. MOISTURE content	301
F. Precautions.....	301
G. Summary	301
H. References	302

CHAPTER XIII. INCINERATION AND THERMAL CONVERSION303

A. Incineration	303
A1. INTRODUCTION	303
A2. PRINCIPLES.....	303
A3. TYPES of incinerators.....	304
B. Pyrolysis.....	313
B1. PRODUCTS	314
B2. TECHNOLOGY	315
B3. PYROLYSIS-PRODUCED gas	317
C. Precautions	319
D. References.....	320

Part III - Final Disposal

CHAPTER XIV. SANITARY LANDFILL.....323

A. Introduction.....	323
B. Basic principles	323
B1. DEFINITION.....	323

B2. PLANNING for a landfill	324
C. Landfill processes	324
C1. PHYSICAL	324
C2. CHEMICAL	325
C3. BIOLOGICAL	325
C4. IN-PLACE density and settlement	327
D. Types of solid wastes.....	328
D1. SIGNIFICANCE of waste types	328
D2. ACCEPTABLE wastes.....	328
D3. UNACCEPTABLE wastes	329
D4. SPECIAL wastes	329
E. Quantity and composition of the wastes	329
F. Site selection.....	330
F1. INTRODUCTION.....	330
F2. USEFUL lifespan and area of site.....	330
F3. TOPOGRAPHY	333
F4. SOILS.....	334
F5. GEOLOGY	336
F6. HYDROGEOLOGY	336
F7. PHYSIOGRAPHIC setting	337
F8. GEOLOGY and soil characteristics	338
F9. VEGETATION	341
F10. SITE access and transport	342
F11. LAND use	342
F12. ECONOMIC considerations in site selection	343
F13. DECISION-MAKING process	343
G. Landfill technology	344
G1. INTRODUCTION	344
G2. CELL design and construction	345
G3. BOTTOM liner.....	348
G4. DAILY, intermediate, and final covers	348
G5. CUSTOMISED methods of construction and use after completion	354
G6. CO-DISPOSAL of special wastes	354
G7. HAZARDOUS wastes (secure landfill)	355
H. Development of the landfill.....	357
H1. TERRAIN upgrading.....	357
H2. ROADS.....	357
H3. MEASUREMENT of weight (scales)	358
H4. UTILITIES	359
H5. STRUCTURES.....	359
H6. FENCING.....	359
I. Operation	360
I1. INTRODUCTION	360
I2. GENERAL operating procedures	360
I3. SELF-HAUL	366
I4. SALVAGE/scavenging.....	367
I5. WASTE receipt and vehicle routing	368
I6. SPECIFIC operational procedures in a sanitary landfill.....	368
J. Water management	375
J1. SURFACE water.....	375
J2. GROUNDWATER	375
J3. WATER balance and the formation of leachate	376

K. Liners	380
K1. SOIL liners	380
K2. FLEXIBLE membrane liners	383
L. Leachate collection and treatment	384
L1. INTRODUCTION	384
L2. PREREQUISITES	384
L3. LEACHATE collection systems	385
L4. DESIGN of the leachate collection system.....	386
L5. REMOVAL and storage of the leachate	386
L6. LEACHATE management alternatives.....	387
L7. EVAPORATION	387
L8. RECIRCULATION and recycling.....	387
L9. TREATMENT	388
M. Management of landfill gas	390
M1. ORIGIN, composition, and volume of gases.....	390
M2. GAS generation.....	390
M3. VOLUME (yield).....	392
M4. DISPOSITION of the landfill gas.....	394
M5. COLLECTION, upgrading, and utilisation of landfill gas	395
M6. USE of landfill gas in some developing countries.....	399
M7. ECONOMIC feasibility factors associated with landfill gas recovery.....	400
N. Equipment	400
N1. BASIC concepts	400
N2. FACTORS	401
N3. FUNCTIONS served by equipment	402
N4. EQUIPMENT types: descriptions and specifications	403
N5. INSPECTION and maintenance.....	409
O. Provision for material recovery	410
O1. INTRODUCTION	410
O2. PROBLEMS due to scavenging	410
O3. ESTABLISHMENT of scavenging site	410
O4. MANAGEMENT of scavenging activity	411
O5. SUPERVISION and procedures.....	411
P. Environmental monitoring	412
P1. GROUNDWATER.....	412
P2. SURFACE water	415
P3. LANDFILL gas and migration.....	416
Q. Uses of completed landfills	416
Q1. GEOTECHNICAL problems	416
Q2. POTENTIAL hazards	417
Q3. RECOMMENDATIONS for construction on completed fills	418
Q4. POTENTIAL uses	419
Q5. REHABILITATION of existing facilities.....	420
R. Economics	421
R1. BACKGROUND	421
R2. LANDFILL costs vs. total cost of solid waste disposal	422
R3. EFFECT of processing on cost of waste disposal	422
R4. CAPITAL and operating costs.....	423
R5. LANDFILL cost models.....	423
R6. LANDFILL equipment costs	426
S. Public participation	427
S1. INTRODUCTION.....	427

S2. PRINCIPLES of public participation.....	428
S3. DISSIPATION of opposition.....	428
S4. OBJECTIVES of public participation.....	430
S5. ADVANTAGES associated with public participation.....	430
S6. PARTICIPANTS.....	431
S7. EXTENT of public input in relation to stage of project development.....	431
S8. CONCLUSIONS.....	431
T. References.....	432

Part IV - Key Non-Technical Considerations

CHAPTER XV. REGULATORY AND ECONOMIC INSTRUMENTS FOR SOLID WASTE MANAGEMENT.....	439
--	------------

A. Introduction.....	439
B. Responsibility for regulatory and economic instruments.....	440
B1. NECESSARY conditions.....	440
B2. NEEDED research.....	440
C. Useful regulatory and economic mechanisms.....	441
C1. REGULATORY mechanisms.....	441
C2. ECONOMIC mechanisms.....	443
D. References.....	446

CHAPTER XVI. FINANCIAL ARRANGEMENTS FOR SOLID WASTE MANAGEMENT.....	447
--	------------

A. Introduction.....	447
B. Financing capital investment costs.....	447
B1. RESERVES.....	447
B2. BONDS.....	447
B3. LOANS/grants.....	448
B4. DONATIONS.....	449
C. Financing operating and maintenance costs.....	449
C1. FINANCING methods.....	449
C2. COSTS of solid waste service.....	450
C3. RESPONSIBILITY for service delivery.....	451
D. Financing waste management services for marginal areas.....	451
D1. SERVICE alternatives.....	452
E. The role of the private sector.....	453
E1. CONTRACTING.....	453
E2. FRANCHISE.....	454
E3. OPEN competition.....	455
E4. VENDOR/operator equity investment.....	455
F. Financing considerations and requirements.....	455
F1. SELECTION of financing method.....	455
F2. VIABILITY of the project.....	455
F3. RELIABILITY of waste supply.....	456
F4. SERVICE agreement.....	456
F5. SALES of materials and/or energy.....	456
F6. AVAILABILITY of final disposal site.....	456
F7. LEGAL authority.....	456

F8. PERMITS	456
F9. AGREEMENTS	456
F10. FINANCING process	457
F11. OWNERSHIP	457
G. The impact of resource recovery on financing	457
H. References	458

CHAPTER XVII. POLICY ALTERNATIVES FOR IMPROVING SOLID WASTE MANAGEMENT

A. Introduction.....	461
B. Decision-making.....	461
C. Financial aspects	461
C1. BUDGETARY issues	461
C2. BUDGETARY reform.....	462
C3. DEVELOPMENT of a financial base.....	462
C4. EFFECTS of financial resources	463
C5. DATABASE needs	463
C6. COST containment via design of collection service	464
C7. PROCUREMENT.....	464
C8. EQUIPMENT bid document: preparation and precautions.....	465
C9. COSTS apportionment.....	465
D. Human resources	466
D1. PERSONNEL requirements	466
D2. FIELD supervision of collection service personnel	466
D3. ATTITUDE, morale, and motivation of personnel	466
D4. PUBLIC health inspectors.....	467
E. Political issues.....	467
E1. AUTHORITY	467
E2. PUBLIC education.....	468
E3. STATUS and resulting problems.....	468
E4. POLITICAL factor.....	469
E5. ROLES of the political leadership	469
E6. CENTRALISED policy coordination	470
F. Conclusions	470
G. References	471

CHAPTER XVIII. MANAGEMENT INFORMATION SYSTEMS.....

A. Introduction.....	473
B. Evaluation of performance	474
C. Indicators.....	475
C1. GENERATION.....	475
C2. ONSITE storage.....	476
C3. COLLECTION and transport	476
C4. PROCESSING and resource recovery.....	476
C5. FINAL disposal	476
C6. ADMINISTRATION.....	477
D. Establishment of the management information system	477
D1. ORGANISATION	477
D2. DATA collection	478
D3. STORAGE and processing.....	478

E. Conclusions.....	479
F. References.....	479

Appendices

APPENDIX A. PUBLIC HEALTH ASPECTS.....	481
APPENDIX B. CHARACTERISTICS OF COMPOSTED YARD WASTE.....	493
APPENDIX C. PERFORMANCE INDICATORS FOR SOLID WASTE SERVICES.....	495
APPENDIX D. COSTS OF SOLID WASTE MANAGEMENT TECHNOLOGIES.....	503
BIBLIOGRAPHY.....	505
GLOSSARY	515

ACKNOWLEDGEMENTS

This publication was prepared through a collaborative effort by several institutions and individuals. The project was co-funded by the UNEP IETC (Osaka, Japan) and CalRecovery, Inc. (Concord, California, USA).

Responsibility for design, writing, and editing of the document was in the hands of the authors of the book: Dr. Luis F. Diaz, Mr. George M. Savage, and Ms. Linda L. Eggerth. The authors are particularly grateful to the following persons, who provided insightful comments in their review of the new publication:

- Ms. Lizette C. Cardenas, Executive Director, Solid Waste Management Association of the Philippines
- Dr. Virginia W. Maclaren, Associate Professor, Department of Geography and Program in Planning, University of Toronto, Canada
- Ms. Jenny Tan, Project Manager, Centre for Environmental Technologies, Malaysia

Part I

Principles of Municipal Solid Waste Management

CHAPTER I. INTRODUCTION

A. Definition of developmental status

The status of development of a country may be categorised in several ways. With respect to its impact on solid waste management, in this publication status of development is categorised on the basis of availability of economic resources and on degree of industrialisation. Status of economic development is more a measure of the permanent economic framework than of the existing condition of the economy (recession vs. prosperity). In this document, the emphasis is on solid waste management in a setting that is primarily non-industrial. Such management is adapted to the nature and quantities of waste generated and to the availability of technology for handling and processing characteristic of non-industrial settings. Degree of industrialisation is measured in terms of extent of mechanisation and availability of technological resources. Justifiably or not, the terms “developed” and “industrialised” occasionally are used synonymously.

Because of localised changes in degree of development within each country, it is difficult to apply a single developmental category as far as solid waste management is concerned. For example, a large urban community (typically the capital city and surrounding area) in a developing nation may be in a stage of development that is well above that of the rest of the nation. On the other hand, these communities are not entirely immune to the limitations imposed by the status of the nation.

In this document, the authors have made an effort to incorporate in each section a range of coverage that encompasses the range of development that is typically found in economically developing nations without resorting to repetitive descriptions of technologies that do not vary substantially with scale of operation or degree of sophistication.

It is important to note that although the information presented in this document is applicable primarily to developing countries, some of it may also be applicable to a nation in transition or even to a developed or industrialised nation.

B. Characteristics of solid waste in developing countries

“Municipal solid waste” (MSW) is a term usually applied to a heterogeneous collection of wastes produced in urban areas, the nature of which varies from region to region. The characteristics and quantity of the solid waste generated in a region is not only a function of the living standard and lifestyle of the region's inhabitants, but also of the abundance and type of the region's natural resources. Urban wastes can be subdivided into two major components -- organic and inorganic. In general, the organic components of urban solid waste can be classified into three broad categories: putrescible, fermentable, and non-fermentable. Putrescible wastes tend to decompose rapidly and unless carefully controlled, decompose with the production of objectionable odours and visual unpleasantness. Fermentable wastes tend to decompose rapidly, but without the unpleasant accompaniments of putrefaction. Non-fermentable wastes tend to resist decomposition and, therefore, break down very slowly. A major source of putrescible waste is food preparation and consumption. As such, its nature varies with lifestyle, standard of living, and seasonality of foods. Fermentable wastes are typified by crop and market debris.

The primary difference between wastes generated in developing nations and those generated in industrialised countries is the higher organic content characteristic of the former. The extent of the difference is indicated by the data in Table I-1, in which is presented information relative to the quantity and composition of municipal solid wastes generated in several countries.

Table I-1. Comparison of solid waste characterisation worldwide (% wet wt)

Location	Putrescibles	Paper	Metals	Glass	Plastics, Rubber, Leather	Textiles	Ceramics, Dust, Stones	Wt (g)/cap/day
Bangalore, India [1]	75.2	1.5	0.1	0.2	0.9	3.1	19.0	400
Manila, Philippines [2]	45.5	14.5	4.9	2.7	8.6	1.3	27.5	400
Asunción, Paraguay [2]	60.8	12.2	2.3	4.6	4.4	2.5	13.2	460
Seoul, Korea [3]	22.3	16.2	4.1	10.6	9.6	3.8	33.4 ^a	2,000 ^a
Vienna, Austria [4]	23.3	33.6	3.7	10.4	7.0	3.1	18.9 ^b	1,180
Mexico City, Mexico [5]	59.8 ^c	11.9	1.1	3.3	3.5	0.4	20.0	680
Paris, France [4]	16.3	40.9	3.2	9.4	8.4	4.4	17.4	1,430
Australia [7]	23.6	39.1	6.6	10.2	9.9		9.0	1,870
Sunnyvale, California, USA [6]	39.4 ^d	40.8	3.5	4.4	9.6	1.0	1.3	2,000
Bexar County, Texas, USA [6]	43.8 ^d	34.0	4.3	5.5	7.5	2.0	2.9	1,816

^a Includes briquette ash (average).

^b Includes "all others".

^c Includes small amounts of wood, hay, and straw.

^d Includes garden waste.

Wastes generated in countries located in humid, tropical, and semitropical areas usually are characterised by a high concentration of plant debris; whereas those generated in areas subject to seasonal changes in temperature or those in which coal or wood are used for cooking and heating may contain an abundance of ash. The concentration of ash may be substantially higher during winter. Regardless of climatic differences, the wastes usually are more or less contaminated with nightsoil. These differences prevail even in wastes generated in large metropolitan areas of a developing country.

Ideally, solid waste should not contain faecal matter or urine, and the mixing of these materials with household waste should be prohibited by law. However, enforcement difficulties, combined with variations in way of life, necessitate some tolerance in this matter. Solid waste collection in a manner satisfactory with respect to environmental health is made difficult when human excretory wastes are mixed with household wastes. Handling of pathological wastes, abattoir wastes, industrial wastes, and similar materials, in association with household wastes, also should not be permitted. Nevertheless, it is important to keep in mind that despite all precautions, some pathogens and chemical residues inevitably will be present in the waste.

C. Importance of a sound solid waste management program

In an attempt to accelerate the pace of its industrial development, an economically developing nation may fail to pay adequate attention to solid waste management. Such a failure incurs a severe penalty at a later time in the form of resources needlessly lost and a staggering adverse impact on the environment and on public health and safety. The penalty is neither avoided nor lessened by a resolve to do something about the waste at a later time, when the country may be in a better position to take appropriate measures. This is true because, as is indicated by the data in Table I-1, the rate of waste generation generally increases in direct proportion to that of a nation's advance in development. Nor is the penalty lessened by the faulty rationalisation that advances in

developmental status have higher priority than maintenance of a liveable environment. The greater the degradation of the environment, the greater is the effort required to restore its good quality. In summary, the effort to preserve or enhance environmental quality should at least be commensurate with that afforded to the attainment of advance in development.

C1. ENVIRONMENTAL and health impacts

The organic fraction of MSW is an important component, not only because it constitutes a sizable fraction of the solid waste stream in a developing country, but also because of its potentially adverse impact upon public health and environmental quality. A major adverse impact is its attraction of rodents and vector insects for which it provides food and shelter. Impact on environmental quality takes the form of foul odours and unsightliness. These impacts are not confined merely to the disposal site. On the contrary, they pervade the area surrounding the site and wherever the wastes are generated, spread, or accumulated.

Unless an organic waste is appropriately managed, its adverse impact will continue until it has fully decomposed or otherwise stabilised. Uncontrolled or poorly managed intermediate decomposition products can contaminate air, water, and soil resources.

C2. EPIDEMIOLOGICAL studies

Studies have shown that a high percentage of workers who handle refuse, and of individuals who live near or on disposal sites, are infected with gastrointestinal parasites, worms, and related organisms [8]. Contamination of this kind is likely at all points where waste is handled.

Although it is certain that vector insects and rodents can transmit various pathogenic agents (amoebic and bacillary dysenteries, typhoid fever, salmonellosis, various parasitoses, cholera, yellow fever, plague, and others), it often is difficult to trace the effects of such transmission to a specific population.

Due to the implementation of modern solid waste management practices, both the public health and the quality of the environment are benefited directly and substantially.

A modern solid waste management program can be implemented for a reasonable cost. This is an important fact because there are ample known situations where solid waste management costs in developing countries are high and the level of service low. But, if the underlying reasons for these situations are analysed, then one can see in many cases that cost-effective waste management systems would result if the identified deficiencies in the systems were remedied.

For example, in some developing countries, municipalities spend a disproportionate amount of financial resources on certain solid waste services, in particular waste collection and sweeping. In the past, a common approach to curing poor service provision was to simply expend more capital (e.g., the acquisition of additional equipment, design and construction of facilities, etc.) without also addressing and remedying inefficiencies inherent in the system. Unfortunately, high capital investment in the solid waste management sector in many developing countries does not necessarily lead to improvements in the quality of service. On the other hand, substantial improvements can be achieved in many cases by making low-cost, or sometimes no-cost, modifications in the existing system, with the focus being on increasing system efficiencies. Examples of such improvements are the efficient design of collection routes, modifications in the collection vehicles, reductions in equipment downtime, and public education, (e.g., education and communication leading to the production of less waste and the reduction of litter).

D. Recovery and utilisation of resources

For several reasons, resource recovery is a major element in solid waste management in developing nations. Reclaimable inorganic components (metals, glass, plastic, textiles, and others) traditionally have been recovered mostly by way of unregulated manual scavenging by private individuals (typically known as the “informal” sector). In recent years, the trend is to formalise and mechanise scavenging through the establishment of material recovery facilities (MRFs) [6]. Reuse and recovery of the inorganic components of the waste stream is an important aspect of waste management.

Special attention is given to organic (biodegradable) residues since, in the majority of developing countries, these residues constitute at least 50% of the waste (by weight). The resource recovery aspect regarding the organic component is threefold:

1. The component can be used in agriculture as a soil amendment through composting.
2. Its energy content can be recovered either biologically or thermally. Biological energy recovery is by way of methane production through anaerobic digestion. Thermal recovery is by way of combustion to produce heat.
3. The organic content can be hydrolysed either chemically or enzymatically to produce a sugar. The sugar can be used as a substrate for ethanol fermentation or for single-cell protein production.

Of the three applications, use in agriculture is the most practical. Although dating back many years, methane production (“biogasification”) has only recently begun to receive serious attention as a potential alternative source of energy. Many hurdles, primarily economic in nature, must be surmounted before either single-celled protein production or ethanol fermentation become a practical reality.

An accurate knowledge of the quantity and composition of the waste input is essential to the success of a resource recovery undertaking. The composition and constancy of the amount of the input must be assured. Obviously, it would be sheer foolishness to attempt an operation of any practical size without having an assured supply of raw material. Not only must the constancy of the supply be assured, it must always be available at a reasonable cost. Additional requirements are adequate economic and qualified human resources.

As far as economically developing nations are concerned, with rare exception, adequate economic resources would preclude processes such as hydrolysis and perhaps large-scale anaerobic digestion in a reactor. These processes depend upon relatively expensive sophisticated equipment. On the other hand, composting can range from the composting carried out by individual homeowners to that undertaken by municipalities. Equipment for composting need not be sophisticated.

Last but not least, the availability, size, and continuity of a market or some form of demand for the reclaimed resource must be determined, lest recycling become merely a prelude to landfilling.

E. Scope and organisation of the book

The book is organised into two volumes. In Volume I, it is further divided into four parts, four appendices, and a bibliography and glossary. The contents of each of the four parts are summarised below:

- Part I deals with the principles of solid waste management. Including the Introduction, it consists of five chapters that collectively cover framework for management of solid waste, waste quantity and characteristics, storage and collection, and street cleaning.
- Part II deals with processing and treatment. The eight chapters include recycling, agricultural utilisation of the organic components, and biological and thermal recovery of energy. Composting is explored in detail.
- Part III is concerned with final disposal. Its single chapter covers sanitary landfilling.
- Part IV consists of four chapters and deals with non-technological matters: regulatory and economic instruments, financial aspects, policy alternatives, and management information systems (MIS).

The appendices of the publication include supporting and additional information related to public health, compost characteristics, performance indicators, and costs of solid waste management technologies.

Volume II describes solid waste management in several geographical regions around the world, and provides contact information for each region. *Volume II is included on a CD in the inside cover of Volume I.*

Thus, the publication covers the principal elements of solid waste management planning and implementation that would be appropriate for developing nations. Both non-technical and technical issues are discussed in detail since the planning and implementation of solid waste management systems necessarily involves an understanding of both sets of issues. Since the waste stream in developing countries is largely organic in nature, use of organic waste in agriculture and composting receive considerable attention.

The primary emphasis of this book is on the management of solid waste in an urban setting. The urban setting may be a small municipality, any intermediate size community, or a large metropolitan area. In some cases, technological aspects could be extrapolated to rural settings.

The publication is directed toward individuals who are responsible for solid waste management or have a significant role in it. The intent is to acquaint such individuals with available options and to supply background information needed to arrive at decisions that are in keeping with the country's cultural, economic, and technological conditions. Consequently, the information is geared more toward decision-making than to detailed engineering design of specific facilities at particular places. Detailed engineering design demands input by competent professionals specifically well versed in solid waste management and in sympathy with the special needs of the community seeking their professional aid. This is particularly true when the scale of a project exceeds a few tons of waste per day. Although detailed engineering design is not the focus of this publication, for many of the technical subjects covered in the publication, fundamental scientific and engineering principles are described. Consequently, the reader is exposed to the basic relationships between performance and operating conditions and can use the basic principles to analyse solid waste management systems based on a particular set of circumstances.

As the Introduction comes to a close, the authors would like to emphasise that the management of solid wastes is a difficult problem that need not be made more difficult by unnecessarily using complex (high)-technology. The avoidance of unnecessary high technology is critical to successful solid waste management in the low technology economies of developing nations. Importation of complex equipment and technology should be kept to a minimum. Too frequently, a technology that may be considered low technology and readily applicable in one country may

be too sophisticated and otherwise unacceptable in the country doing the importing. This statement applies not only to methods of disposal but also to the collection of wastes and even to the devices for storing them.

F. References

1. Nath, K.J., "Solid Waste Management in the Present Indian Perspective", proceedings of ISWA 1993 Annual Conference, Jönköping, Sweden, September 1993.
2. Diaz, L.F. and C.G. Golueke, "Solid Waste Management in Developing Countries", *BioCycle*, 26:46-52, September 1985.
3. Japan International Cooperation Agency, *Master Plan and Feasibility Study on Seoul Municipal Solid Waste Management System in the Republic of Korea*, Draft Final Report, Tokyo, Japan, 1985.
4. Scharff, C. and G. Vogel, "A Comparison of Collection Systems in European Cities", *Waste Management & Research*, 12(5), October 1994.
5. CalRecovery, Inc., *Criterio de Diseño - Planta de Selección y Recuperación de Subproductos de los Residuos Sólidos Municipales*, prepared for Mexico City, Mexico, December 1992.
6. CalRecovery, Inc., *Handbook of Solid Waste Properties*, Governmental Advisory Associates, Inc., New York, New York, USA, 1993.
7. Morwood, R., "Australian Waste Management - Towards 2000", *Proceedings of 32nd Annual International Solid Waste Exposition*, SWANA, San Antonio, Texas, USA, August 1994.
8. Cal Recovery Systems, Inc., Norconsult A.S., and Engineering-Science, *Metro Manila Solid Waste Management Study - Review of Existing Conditions*, May 1982.

CHAPTER II. FRAMEWORK FOR MANAGEMENT OF SOLID WASTE

A. Integrated waste management

This document is organised by waste management topics, which range from waste characteristics, to collection, to landfilling, and to public education and information management. Although these topics are discussed in detail later in the publication, some are also discussed generally in this chapter in the context of their relevance and application to supporting the basic framework for solid waste management. Specifically, this section discusses the relationships among the key topics covered in this book. Understanding these relationships is a key element in successfully achieving integrated waste management -- a single, overall approach to managing waste in a city, town, or region.

A1. ELEMENTS of a waste management system

A comprehensive municipal solid waste management (MSWM) system includes some or all of the following activities:

- setting policies;
- developing and enforcing regulations;
- planning and evaluating municipal MSWM activities by system designers, users, and other stakeholders;
- using waste characterisation studies to adjust systems to the types of waste generated;
- physically handling waste and recoverable materials, including separation, collection, composting, incineration, and landfilling;
- marketing recovered materials to brokers or to end-users for industrial, commercial, or small-scale manufacturing purposes;
- establishing training programs for MSWM workers;
- carrying out public information and education programs;
- identifying financial mechanisms and cost recovery systems;
- establishing prices for services, and creating incentives;
- managing public sector administrative and operations units; and
- incorporating private sector businesses, including informal sector collectors, processors, and entrepreneurs.

A2. WHAT is integrated waste management?

Integrated waste management is a frame of reference for designing and implementing new waste management systems and for analysing and optimising existing systems. Integrated waste management is based on the concept that all aspects of a waste management system (technical

and non-technical) should be analysed together, since they are in fact interrelated and developments in one area frequently affect practices or activities in another area.

A3. IMPORTANCE of an integrated approach

An integrated approach is an important element of sound practice because:

- Certain problems can be more easily resolved in combination with other aspects of the waste system than on their own. Also, development of new or improved waste handling in one area can disrupt existing activities in another area unless changes are handled in a coordinated manner.
- Integration allows for capacity or resources to be optimised and, thus, fully utilised; there are frequently economies of scale for equipment or management infrastructure that can be reached only when all of the waste in a region is managed as part of a single system.
- An integrated approach allows for participation of public, private, and informal sector participants, in roles appropriate for each.
- Some waste management practices are more costly than others, and integrated approaches facilitate the identification and selection of low-cost solutions. Some waste management activities cannot bear any charges, some will always be net expenses, while others may produce an income. An integrated system can result in a range of practices that complement each other in this regard.
- Failure to have an integrated system may mean that the revenue-producing activities are “skimmed off” and treated as profitable, while activities related to maintaining public health and safety fail to secure adequate funding and are operated at low or insufficient levels.

A4. METHODS for integrating a waste system

Planners can work toward integrated systems in a number of ways. The first task is to consider all aspects of the formal part of the waste system within one framework and to produce a plan based on the objectives of the entire system. One of the foundations of the framework for modern, integrated solid waste management systems is the solid waste management hierarchy, which specifies the precedence that should be given to key waste management activities that affect waste generation, treatment, and disposal. The hierarchy is discussed in more detail in the following section.

Second, in terms of jurisdictional and staffing issues, is putting all waste-related functions under the same division or agency, which is an important means of achieving integration. A third way of facilitating coordination and assessing trade-offs among all aspects of a waste management system is to create integrated financial structures that, for example, use disposal fees to finance materials recovery or public education. More broadly, it is important to assess all MSWM system costs, as well as identify opportunities for generating revenues.

A5. WASTE management hierarchy as a key element of integrated solid waste management

The waste management hierarchy is a widespread element of national and regional policy and is often considered the most fundamental basis of modern MSWM practice. The hierarchy ranks waste management operations according to their environmental or energy benefits. In virtually all countries, the hierarchy is similar to that shown in Table II-1, with the first entries having higher priority than those below them.

Table II-1. Solid waste management hierarchy

- Prevent the production of waste, or reduce the amount generated.
- Reduce the toxicity or negative impacts of the waste that is generated.
- Reuse in their current forms the materials recovered from the waste stream.
- Recycle, compost, or recover materials for use as direct or indirect inputs to new products.
- Recover energy by incineration, anaerobic digestion, or similar processes.
- Reduce the volume of waste prior to disposal.
- Dispose of residual solid waste in an environmentally sound manner, generally in landfills.

The purpose of the waste management hierarchy is to make waste management practices as environmentally sound as possible. The waste management hierarchy has been adopted in various forms by most industrialised countries. Its principal elements are also included in international conventions and protocols, particularly those dealing with the management of toxic or hazardous wastes, and in regional attempts to develop a coordinated policy on the reuse of various byproducts of waste management processes.

The hierarchy is a useful policy tool for conserving resources, for dealing with landfill shortages, for minimising air and water pollution, and for protecting public health and safety. In many developing countries, some aspects of this hierarchy are already in place, since traditional practices revolving around waste prevention, reuse, and recycling are prevalent.

At the same time, it should be recognised that all waste management practices have costs, as well as benefits. This means that the hierarchy cannot be followed rigidly since, in particular situations, the cost of a prescribed activity may exceed the benefits, when all financial, social, and environmental considerations are taken into account.

B. Stakeholders

Appropriate practice in waste management systems necessitates clear delineation of jurisdiction and responsibility, with all stakeholders participating in system design, and with those affected, at every level, aware of the lines of accountability.

Governments will generally have final jurisdiction and responsibility for overall policy and for management of the MSWM system, whether or not the government itself is performing the waste management functions. The following participants all have some important relation to waste management and, in some cases, significant levels of responsibility for policies or operations.

B1. RESIDENTIAL waste generators

Local residents' preferences for particular types of waste service, their willingness to source separate recyclable materials, their willingness to pay for the service, and their capacity to move waste to communal collection points all have an impact on the overall waste system. Incentives can affect residents' preferences and behaviour.

B2. BUSINESS waste generators

Businesses also produce waste, and the business sector can become a significant player in the waste management system, particularly, as is increasingly the case, when businesses must pay directly for their waste service. As with residents, incentives can play an important role in shaping behaviour.

B3. PUBLIC health and sanitation departments

The maintenance of public health and sanitation is an important public responsibility and, especially in developing and transition countries, is usually under the jurisdiction of the municipal public health department. In an integrated system, this department often has inspection and enforcement responsibilities, but is not directly involved in collection or disposal operations.

B4. PUBLIC works departments

These local government units most often have operational responsibility for waste collection, transfer, treatment, and final disposal. Frequently, however, the collection of recoverable materials or management of private contractors is the responsibility of a different department, often creating conflicting goals and activities that work against each other.

B5. NATURAL resource management agencies

These agencies often have responsibility at the local or regional level for activities relating to materials recovery or composting. This splits these activities away from waste management functions, resulting in poor integration. Sound practice most often means putting all of the functions under the same agency or department.

B6. NATIONAL or state/provincial environmental ministries

Overall, waste management policy generally is established at these levels. With respect to materials recovery policies, there is less policy-making at this level in developing countries. Sound practice includes not only setting policies, but putting programs in place to implement them and to establish integration consistent with the policies.

B7. MUNICIPAL governments

In most countries, city or town governments have overall responsibility for waste management operations -- ensuring that collection takes place and that the collected materials are delivered to processors, markets, or disposal facilities. Financing for vehicles, crews, and other equipment usually is provided by the municipal government, which is ultimately responsible for the entire process.

B8. REGIONAL governments

Regional bodies or large city governments often have responsibility for landfills, incinerators, composting facilities, or the like, particularly in countries where there is a shortage of disposal space at the local level. Regional governments in charge of these facilities generally have access to a stream of revenues from fees paid by waste collection companies for disposal.

B9. PRIVATE sector companies

Private sector companies tend to be involved in collection of waste, in street sweeping, in the recovery of materials, and, increasingly, in the construction and operation of landfills, incinerators, and compost plants, as concessionaires or contractors from the responsible government authority. Unlike governments, private companies do not have any direct responsibility for maintaining public sanitation or health, so their involvement is limited to functions in which they can make a profit. If there is no stream of revenue, it is not reasonable to expect private sector involvement.

The necessary revenue stream, however, can come from direct charges or allocations from government.

B10. INFORMAL sector workers and enterprises

In developing countries, but also to a significant extent in industrialised and transition countries, individual workers and unregistered, small enterprises recover materials from the waste stream, either by segregated or specialised collection, by buying recyclable materials, or by picking through waste. These workers and enterprises clean and/or upgrade and sell the recovered materials, either to an intermediate processor, a broker, or a manufacturer. Informal sector workers sometimes manufacture new items using the recovered materials, making, for example, gaskets and shoe soles out of discarded tires.

B11. NON-GOVERNMENTAL organisations

Non-governmental organisations (NGOs) are yet another set of participants in the waste management field. NGOs often have a mission of improving the environment or the quality of life for poor or marginalised groups; as part of this mission, they may stimulate small-scale enterprises and other projects. Since waste materials represent, in many cases, the only growing resource stream, these organisations frequently base their efforts on extraction of certain materials not currently being recovered and processing them to add value and produce revenue. In Latin America, a number of composting projects were started this way.

B12. COMMUNITY-BASED organisations

In a number of locations where there is insufficient collection or the neighbourhood is underserved, community-based organisations take an active role in waste management operations. These organisations, which are smaller in scale or local NGOs, may form primarily as self-help or self-reliance units, but they may, over time, evolve into service organisations that collect fees from their collection clients and from the sale of recovered materials. NGOs working with informal workers and community-based entrepreneurs often seek recognition for these organisations as part of the waste management system.

B13. POOR and residents of marginal and squatter areas

Waste service, much like other public services, frequently follows political power and clout, leaving the residents of poor and marginalised areas with inadequate service (or no service at all), dirty streets, and the continual accumulation of refuse and faecal matter on the streets and in other public areas. Very often, these people have the greatest need for improved or expanded waste service.

B14. WOMEN

Waste handling disproportionately touches the lives of women, particularly in some developing and transitioning countries. Women often collect the waste and set it out or move it to community transfer areas. Women are far more likely to be involved in materials recovery than in other comparable types of physical work. This is perhaps because they are in daily contact with the waste in their homes, and perhaps because women tend to be among the most marginalised groups of some societies.

C. Cost and cost recovery

Since proper waste collection and disposal are necessary to maintain the cleanliness and public health of a community, these services benefit both the generators and the community as a whole. In this context, proper waste collection includes both regular collection service and cleanup of wastes that generators have disposed in an unacceptable manner (i.e., litter).

Not all “waste” is considered to be waste by everyone, however. Scavengers and small-scale recyclers successfully extract value from other people’s wastes. This process can potentially be managed so that the informal sector often involved in such activities complements ongoing institutionalised waste collection, rather than interfering with it. As discussed in this document, there are serious health and social problems associated with scavenging, but the point is that much “waste” actually has value to someone. Those who remove recoverable materials from the waste stream are reducing the waste disposal costs of the whole community. In industrialised countries, there is now an increasing awareness of the value of sorting out the reusable and recyclable components of the solid waste stream.

In the end, though, some quantities of waste must be collected and disposed, and this service must be paid for in some manner. Additionally and depending on local circumstances, other waste management services may require funding in some form, including public education and processing of waste for recovery and reuse of recyclable materials.

C1. FEES and charges

Until recently, in most countries, especially developing countries, countries in transition, and European social democracies, the management of waste has been considered to be the responsibility of government, financed by general revenues. In recent years, partly as a result of austerity and structural adjustment policies and pressures from multilateral financial institutions, and partly as a result of pressures to limit taxes, governments have increasingly focused on identifying specific revenue sources for waste management. This has led to a series of innovations relating to fees and charges for waste collection and disposal.

C1.1. Charging directly for waste service

One approach to the financing of waste systems is to obtain payment from those who benefit from the service. On the simplest level, waste generators benefit from collection service, and there have been some attempts, particularly in North America, to get households to pay directly for their own waste removal on the basis of how much waste they are setting out. The system of unit fees for waste removal works well and represents sound practice when individuals want to get rid of their waste and can afford the fees. It works poorly when people are too poor to pay fees, when the fees are simply too high, or when there are ready alternatives and no controls for disposing of wastes, such as by throwing them into the countryside.

Fees can be used to finance waste collection or other aspects of the waste system. Fees can also be used as incentives to generators to create less waste.

C1.2. Indirect charges

In some locations, charges for waste are linked to other public services that people are willing to pay for, such as water or electricity. Including waste charges in water and (if present) sewer charges allows some cost recovery; studies have shown that water and electrical energy consumption are rough indicators of waste generation.

C1.3. Incentives and penalties

Charges and fees can also be used as incentives to encourage “good behaviour” and to discourage “bad behaviour”. For example, the price of disposal can be increased and the cost of materials recovery subsidised to give people incentives to source separate. In some instances, fines can be used to discourage illegal dumping.

C2. STRUCTURING financing for waste management systems

Sound practice in financing waste management systems usually entails differing treatment of fixed costs and variable costs. Fixed costs, which establish waste or materials collection, processing, or disposal capacity, may be paid from general tax revenues. The rationale for this is that there are benefits to all members of society for having the overall solid waste management system in place. Once societies reach a certain level of sophistication, they may be able to recover a certain portion of fixed costs from commercialised collection, processing, and disposal operations, and not rely solely on general tax revenues to fund these activities.

Variable costs can appropriately be paid from direct or indirect fees, thereby being linked to the activities giving rise to the costs in the first place.

One key to developing sound cost recovery systems is tracking all costs accurately. A surprising number of municipal governments do not actually know the total costs of collection or disposal, so they have no basis on which to set or defend fees. Establishing well functioning, transparent, full-cost accounting systems should be a high priority wherever they do not yet exist.

C3. STRATEGIES for cost containment and enhanced efficiency

This section discusses some examples of practices that can result in improved financial management and cost recovery.

C3.1. Privatisation

Pressures on government to reduce taxes, while increasing and improving levels of service, are leading to an exploration of privatisation as an option for waste management functions. Privatisation can take various forms. A government can award a contract to a private firm for specified MSWM services; it can contract with a private firm to construct a waste management facility, which the firm may subsequently own or operate; it can license a private firm to carry out MSWM activities and recover its costs directly from those served; or it can allow qualified firms to participate in open competition.

Certain functions in municipal solid waste lend themselves well to being privatised, while in other cases sound practice will almost always involve government control and operation.

Privatisation tends to work well in the following areas:

- collection of waste or recyclables -- payment to the private contractor is based either on total waste collected or on number of households in the service area;
- construction of waste facilities;
- operation of transfer stations, compost facilities, incinerators, or landfills under contract to a public-sector entity;

- development of private waste facilities, once the price for landfilling has risen to a level where other strategies become cost competitive; and
- in circumstances where there is sufficient government infrastructure to manage a competitive bidding process, to contract with the private firm, to monitor its work, and to hold the private firm accountable for adequate performance of tasks.

Privatisation does not usually work well:

- in small or sparsely populated areas, since there usually is insufficient earning potential due to low waste volumes;
- when the government entity with jurisdiction is too small or too politically weak to be able to manage the contracting processes effectively;
- when badly designed; for example, if there is little no monitoring and enforcement of contract terms; or
- as a substitute for government responsibility, such as if a private firm were to be hired to monitor compliance with environmental regulations by other private firms.

C3.1.1. Importance of competition in privatisation

A key issue in privatisation of municipal solid waste management is the role and management of competition. This is particularly important in developing countries, where the private sector, both informal and formal, may not be sufficiently mature to offer effective competition.

Competition may improve a privatised waste function. Competition promotes good performance by private contractors, since their desire to maintain a contract is a powerful incentive for performing well. Competition is healthy:

- at the time of bidding or contract negotiation;
- to ensure that the full range of services is available;
- when it is well managed through contracting, granting of concessions, or franchising; and
- to prevent formation of monopolies.

At the same time, there are limits to the effective use of competition in solid waste management. One such limit is in the collection of wastes from households -- “unbridled” competition, though avoiding monopoly, can drive up prices because of the high costs of numerous low-volume operators. In such instances, using a competitive process to select a single operator for a period of time may be a better alternative.

It is, of course, advisable to introduce new approaches with care so that they do not unwittingly kill off marginal, informal sector activities best viewed as complements to the formal waste management system.

C3.2. Support for small-scale enterprises

Recognition of and support for small-scale and informal sector waste-related enterprises is a significant element of sound practice, especially in developing countries, and to a lesser extent in

transition and industrialised countries as well. These businesses usually remove materials from the waste stream, at low cost, saving the government money. Disruption of their operations can increase the burden on public works and sanitation budgets significantly.

In recent years, a number of projects have attempted to gain official recognition for these enterprises, to institutionalise their market niche, and to shelter their operations from disruption during waste system upgrading and modernisation. This has been done by:

- awarding or arranging contracts between informal sector enterprises and the city or formal private sector collection companies;
- organising cooperatives;
- providing equipment, supplies, clothing, gloves, and shoes, or even vehicles, to improve working conditions; and
- designing new waste facilities to include rather than exclude these operations.

Taking these and other steps to support small and informal enterprises generally improves efficiency and cost effectiveness while supporting subsistence activities and an important economic niche.

D. Other important issues and strategies

D1. UNDERSTANDING characteristics of waste generated

An important element in improving waste management systems is the need to attune chosen technologies to the character of the waste that is generated in a particular location. If wastes are wet and dense, as they are in most developing countries, buying compactor trucks will often be a waste of money. If wastes have low calorific value, it will not be possible to incinerate them without using supplementary fuel. If considerable amounts of toxic waste have entered the general municipal solid waste (MSW) stream, leachate from dumps will be particularly dangerous. On the other hand, if a portion of the waste stream consists of organics or can be easily separated into organics and non-organics, composting may become a viable waste management strategy.

D2. MAJOR differences between industrialised and developing countries

One theme that appears consistently throughout this book is the enormously different conditions in which industrialised and developing countries must work to solve MSWM problems. Developing countries often have:

- low labour costs and extreme shortages of capital, which together call for low-tech solutions to MSWM problems;
- a waste stream dominated by organic waste, which means that: a) incineration is difficult unless undertaken in conjunction with a program that achieves source separation of organics, and b) composting is especially important if large amounts of waste are to be diverted from landfills;
- a complex informal sector that is very active in the collection, separation, and recycling of waste;

- significant mixing of industrial hazardous wastes with MSW;
- few people who are adequately trained in solid waste management activities, and a high proportion of the urban population with low levels of education; and
- inadequate physical infrastructure in urban areas, which makes collection of waste particularly difficult.

At the same time, it should be recognised that there are also similarities between industrialised and developing countries with regard to MSWM issues. In neither case does the public want MSWM facilities near residential areas and, in both cases, the amount of waste being generated is increasing. In both industrialised and developing countries, adopting an integrated approach to waste management is important. Related to this, people throughout the world are recognising the importance of waste reduction as the first stage of the waste management hierarchy and as an essential element of MSWM. Methods of waste reduction are described in more detail in the last part of this chapter.

D3. IMPROVING management capabilities

In many instances, particularly in developing countries, the greatest impediments to efficient and environmentally sound handling of MSWM issues are managerial, rather than technical. Improving the operational and management capabilities of individuals and institutions involved in MSWM at the local level is therefore extremely important. For this reason, this book considers these issues in two of the topics addressed: management and planning, and training.

Even with new efforts to make funds available for MSWM activities, it is certain that funds will at least appear to be insufficient for the foreseeable future. Managers must therefore be attuned to every opportunity to use their resources more efficiently.

D4. PUBLIC involvement

The public can play a role in promoting efficient, financially sound, technically competent management of waste issues by demanding accountability from the MSWM system. Although in many countries the public has long grown accustomed to having low expectations of government, the pressing and very visible problems brought about by the absence of effective MSWM systems may inspire stronger demands for good performance from public managers and any private companies with whom they work.

Public education is important in achieving the goal of public involvement. This book includes a section on public education for each of the regions.

D5. SPECIAL wastes

Special wastes are those types of solid waste that require special handling, treatment, and/or disposal. The reasons for separate consideration include: 1) their characteristics and quantities (either or both may render them difficult to manage if they are combined with “typical” municipal solid waste); or 2) their presence will or may pose a significant danger to the health and safety of workers and/or the public, to the environment, or both.

Some examples of special types of wastes are given in Table II-2. These wastes are very different from each other, so they should be managed and handled separately if feasible. Typically, in developing countries, special wastes are set out for collection, collected, and/or disposed along with wastes from commercial businesses and residential generators. Ideally, these wastes should

not enter the municipal solid waste stream, but quite frequently they do, particularly in developing countries.

Table II-2. Examples of types of special wastes

- Pathological or infectious medical waste from hospitals, clinics, and laboratories
- “Hazardous” waste in the household waste stream (e.g., oil-based paints, paint thinners, wood preservatives, pesticides, household cleaners, used motor oil, antifreeze, batteries)
- Discarded tires
- Used oils
- Electronic waste (e-waste)
- Wet batteries
- Construction and demolition debris
- Municipal wastewater treatment (sewage) sludge, septage, and slaughterhouse wastes
- Industrial hazardous waste, and some types of industrial solid waste (e.g., metal cuttings from metal processors or cannery waste)

Special wastes can cause significant health and environmental impacts when managed inadequately. Persons that may come into direct contact with the wastes, such as waste collectors and scavengers, may be subject to significant health and safety risks when exposed to some types of special wastes, e.g., industrial hazardous waste. Toxic components of these wastes can enter the environment, for example, poisoning surface and groundwater bodies. Hazardous wastes can also degrade MSW equipment used to manage solid waste (e.g., collection vehicles), or the performance of the equipment.

Special wastes are discussed in this document because of the potential negative effect that they can have on the MSWM system. Still, it is important to point out that this section only superficially reviews the topic of special wastes. If the reader is involved in any part of the management process for special wastes, further additional reference materials and training are extremely important.

Proper management of special wastes is quite difficult in most developing countries, particularly in those countries where regular MSW is not managed adequately. Three issues are usually always relevant: 1) the party or organisation responsible for managing special wastes is seldom clearly identified and the necessary entity may not even be in existence; 2) available resources to manage solid waste are scant and priorities have to be set; and 3) the technology and trained personnel needed to manage special wastes are seldom available.

In the absence of countervailing reasons, the development of sound practices in the management of special wastes should follow the integrated waste management hierarchy applied in other areas of MSWM, i.e., waste reduction, minimisation, resource recovery, recycling, treatment (including incineration), and final disposal. As with the management of other types of MSW, the proper application and programmatic emphasis of this hierarchy to special wastes depends on local circumstances (e.g., available technologies, waste quantities and properties, and available human and financial resources).

Effective management of special wastes begins with an assessment of their potential impacts on human health and safety and on the environment. The environmental benefits of properly handling hazardous wastes can be very large, since in some cases small quantities of hazardous wastes can cause significant damage. However, even though all hazardous wastes present some risks, the quantities are not always sufficient to warrant separate collection and disposal. As points of reference, Organization for Economic Co-operation and Development (OECD)

guidelines and US environmental regulations specify minimum quantities of material that need special treatment as “hazardous waste”. Obviously, specific decisions regarding the management of special wastes will necessarily depend on the capabilities of individual countries to carry out such programs.

A number of alternatives for handling of special wastes have been or are in the process of being devised in response to the various needs of developing and industrialised countries. These practices are summarised in this section for the most frequently encountered special wastes.

D5.1. Medical waste

Medical waste is one of the most problematic types of wastes for a municipality or a solid waste authority. When such wastes enter the MSW stream, pathogens in the wastes pose a great hazard to the environment and to those who come in contact with the wastes.

Wastes generated within health care facilities have three main components: 1) common (general) wastes (for example, administrative office waste, garden waste and kitchen waste); 2) pathogenic or infectious wastes (these types also include “sharps”); and 3) hazardous wastes (mainly those originating in the laboratories containing toxic substances). The quantity of the first type of general wastes tends to be much larger than that for the second and third types.

Segregation of medical waste types is recommended as a basic waste management practice, as indicated in Table II-3. However, thorough separation is possible only when there is significant management commitment, in-depth and continuous training of personnel, and permanent supervision to ensure that the prescribed practices are being followed. Otherwise, there is always a risk that infectious and hazardous materials will enter the general MSW stream.

Table II-3. Recommended methods for managing medical waste

<p>Source separation within the health care facility</p>	<ul style="list-style-type: none"> • Isolates infectious and hazardous wastes from non-infectious and non-hazardous ones, through colour coding of bags or containers • Source separates and recycles the relatively large quantities of non-infectious cardboard, paper, plastic, and metal • Source separates compostable food and grounds the major fraction of organic wastes and directs them to a composting facility if available • Includes and is characterised by thorough management monitoring program
<p>Take-back systems</p>	<ul style="list-style-type: none"> • Where vendors or manufacturers take back unused or out-of-date medications for controlled disposal
<p>Tight inventory control over medications</p>	<ul style="list-style-type: none"> • To avoid wastage due to expiration dates (a form of waste reduction)
<p>Piggy-back systems for nursing homes, clinics, and doctors' offices</p>	<ul style="list-style-type: none"> • Can send respective wastes for treatment to proper health care waste treatment facilities using health care waste collection and transport systems located in the vicinity
<p>Treatment of infectious waste through incineration, or by disinfection</p>	<ul style="list-style-type: none"> • Includes autoclaving, chemical reaction, microwaves, and irradiation • In the case of incineration, the processing may be performed within the premises of the health care facility (onsite) or in a centralised facility (offsite). An incinerator is difficult and expensive to maintain, so it should be installed in a health care facility only when the facility has sufficient resources to properly manage the unit. Otherwise, a centralised incinerator that provides services to health care facilities in one region or city may be more appropriate. Regardless of location, the incinerator must be equipped with the proper air pollution control devices and operated and maintained properly, and the ash must be disposed in a secure disposal site. In the case of disinfection, residues from these processes should still be treated as special wastes, unless a detailed bacteriological analysis is carried out.
<p>Proper disposal of hospital wastes</p>	<ul style="list-style-type: none"> • In many developing countries, none of the treatment systems discussed in this table are widely available, so final disposal of infectious and hazardous components of the wastes is necessary. Since in many developing countries there are no landfills specifically designed to receive special wastes, infectious and hazardous health care wastes normally are disposed at the local MSW landfill or dump. In this case, close supervision of the disposal process is critical in order to avoid exposure of scavengers to the waste. Final disposal should preferably be conducted in a cell or an area specially designated for that purpose. The health care waste should be covered with a layer of lime and at least 50 cm of soil. When no other alternative is available for final disposal, health care wastes may be disposed jointly with regular MSW waste. In this case, however, the health care wastes should be covered immediately by a 1 m thickness of ordinary MSW and always be placed more than 2 m from the edge of the deposited waste.

D5.2. Household hazardous waste

Households generate small quantities of hazardous wastes such as oil-based paints, paint thinners, wood preservatives, pesticides, insecticides, household cleaners, used motor oil, antifreeze, and batteries. Examples of such wastes are shown in Figure II-1. It has been estimated that household hazardous waste in industrialised countries such as the United States accounts for a total of about 0.5% (by weight) of all waste generated at home [1]. In most developing countries, the percentage probably is even lower.



Courtesy: CalRecovery, Inc.

Figure II-1. Examples of household hazardous wastes

There are no specific, cost-effective, sound practices that can be recommended for the management of household hazardous wastes in developing countries. Rather, since concentrated hazardous wastes tend to create more of a hazard, it is best to dispose of household hazardous wastes jointly with the MSW stream in a landfill, where the biological processes tend to exert a fixating effect on small amounts of toxic metals, while other toxic substances are diluted by the presence of MSW or are broken down into less toxic intermediates during the process of decomposition in the fill.

When resources are available (typically in industrialised countries), appropriate methods and necessary conditions for separation of household hazardous wastes from the rest of the MSW stream include those given in Table II-4.

D5.3. Used tires

The management of used tires poses a potential problem for even the more modern MSWM systems, for reasons related both to the tires' physical properties and their shape. Tires are composed primarily of complex natural and synthetic rubber compounds, both of which have substantial heating value, and various other materials. The recovery of rubber from used tires can be very energy-intensive, and such processing may generate hazardous substances and other

types of process residues. Illegal stockpiles of used tires can create substantial land use problems, harm the environment, and serve as breeding grounds for insects and other small animals that harbour pathogens that are detrimental to human health. Stockpiles can self-ignite and cause fires that are very difficult to control, resulting in negative human health and environmental impacts.

Table II-4. Methods and conditions for promoting the separation of household hazardous wastes (HHW) in industrialised countries

- The priority waste streams for separation are identified with reference to the damage that they may cause when released into the environment, and with reference to the type of disposal that would be available if the waste were not separated. For example, the separate collection of mercury-based batteries might be a priority if the primary means of waste disposal was incineration, a process ill suited to ease of control of mercury emissions.
- Frequent public education and convenient collection service are required for successful HHW source-separation programs.
- Notification at the point of purchase, or on the packaging, that certain consumer items contain dangerous or hazardous materials necessitating special handling and disposal practices.
- Utilisation of point-of-purchase take-back systems for those items that can be collected using such systems, such as used batteries, discarded medicines, and used oil.
- Emphasis placed at the policy and program levels on redesigning consumer products to make them less dangerous or hazardous (such as reducing or eliminating the mercury content in batteries).
- Personnel handling HHW must receive initial and subsequent training, but do not necessarily have to be licensed or trained chemical technicians.

When whole tires are disposed in a landfill, they often rise to the top and make it difficult to maintain the soil cover over the wastes. When dumped illegally, tires can become breeding grounds for mosquitoes and other forms of life that can spread disease, such as dengue. Some appropriate methods of managing used tires are described in Table II-5. The informal sector oftentimes serves as a means to reuse or recycle used tires.

D5.4. Used oil

Used oils are generated primarily in gas stations and in mechanics' shops. These oils generally are discharged in the most convenient location and frequently enter the sewage system, causing problems in the treatment plants or in the receiving bodies of water. When oil is collected haphazardly as part of the MSW stream, it causes problems at the landfill and often becomes part of the landfill leachate. Some recommended methods of managing used oils are described in Table II-6.

Table II-5. Appropriate methods for managing used tires

- **Reuse** through retreading for extended service; shredding and grinding for use in road paving material; and cutting them up for use as padding in playgrounds and buffers on railway tracks. It should be noted that processing of tire materials must be conducted under controlled conditions, as it generates dust and buffings, which may be carcinogenic to workers and are potentially dangerous when released.
- **Thermal destruction in cement kilns** with subsequent energy recovery. This process requires cement kilns, adapted to receive solid fuels. This form of final disposal of tires has been shown to be practical in both industrialised and developing countries.
- **Processing in pyrolytic reactors.** Emissions control systems are critical as organic vapours are generated. As a result, the process can be relatively expensive and will usually become cost effective only when the accumulation of tires becomes a hazard due to potential fires or expensive due to conflicting land use.

Table II-6. Some methods of managing used oil

- **Re-refining into lubricating oil.** Processing used oil for reuse as a lubricating agent is a good method of managing used oil. However, one potential hazard associated with such processing is that the residues from re-refining may be deposited in the MSW stream or in drains. Education must be utilised to explain the problems caused by this casual, improper method of disposal. Ideally, residues should be burned in a cement kiln equipped with the proper type of pollution control systems. When this is not possible, residues should be placed in sealed containers and placed in a special area at the landfill disposal site.
- **Use as a fuel.** Used oil has considerable value as a fuel due to its high specific energy content. However, combustion of used oil can result in emissions of heavy metals into the environment if the combustion system lacks suitable environmental control equipment. When used oil is used as a cement kiln fuel, an added measure of pollution control is achieved by virtue of the fact that the heavy metals present in the oil are absorbed into the cement matrix.

D5.5. Electronic waste (e-waste)

During the last few years, there has been a substantial reduction in the cost and a commensurate increase in the availability and usage of a variety of electronic products. Although the list of relatively new products is long, some of the most common products include personal computers, printers, monitors, television sets, and cellular telephones. As the usage of these and similar products increases, a large number of them are replaced and disposed each year. Improper treatment and unsafe final disposition of these materials has resulted in several problems, which have far reaching implications. One key problem is that related to the fact that most electronic products contain several types of hazardous materials, such as mercury, arsenic, lead, cadmium, and others. If the electronic products are improperly treated or discarded along with the general municipal solid waste, the hazardous materials in the products can be released and result in negative impacts to the public health and to the environment.

One practical solution to the management of e-waste involves the implementation of segregated collection and adequate processing. Current methods for the treatment of e-products include mechanical and chemical processing of the products for the recovery of valuable materials and the removal and/or reduction of the toxicity of the residue.

D5.6. Wet batteries

Used wet batteries are typically generated by car maintenance facilities and vehicle battery suppliers. This type of battery contains acid and lead, both of which are hazardous to humans and to the environment if not properly managed. Environmentally acceptable processing of wet batteries for materials recovery requires trained and experienced facility personnel. Recycling of batteries typically involves draining and neutralisation of the acidic liquid, and recovery of the lead in a non-ferrous foundry.

D5.7. Construction and demolition debris

Construction and demolition (C&D) debris are generated regularly in urban areas as a result of new construction, demolition of old structures and roadways, and regular maintenance of buildings. These wastes contain cement, bricks, asphalt, wood, metals, and other construction materials that are typically inert. In many cases, the biological inertness of C&D debris means that it can be disposed in landfills with lesser restrictions than those required for MSW, which has substantially higher biodegradable content and potential for polluting the environment. However, it must be pointed out that C&D debris may contain some hazardous materials, such as asbestos and PCBs, although this circumstance is most probable in the case of industrialised countries. Very large volumes of demolition waste are generated during natural disasters (earthquakes, floods, typhoons, and others) and during wars.

City authorities need to protect against disposal of these wastes in the streets and on vacant lands, since these locations can become illegal, uncontrolled dumps with their attendant negative consequences. On the other hand, disposal of C&D debris in MSW landfills can be costly and a poor use of landfill capacity. Thus, other alternatives to disposal of C&D may be warranted and should be considered in any event. Processing and recycling, as shown in Figure II-2, are alternatives.



Courtesy: CalRecovery, Inc.

Figure II-2. Storage of construction and demolition debris at a processing facility

Sound practices for the management of C&D wastes are based on the concept of prevention, reuse, and recycling of waste. When these practices cannot be implemented, proper disposal must be considered. Since these wastes are primarily inert or they can be processed to be so in some cases, they can be used for fill, for example in former quarries, as road base, or in coastal cities, to gain land at the ocean front or for the construction of levees. Some sound practices for diverting C&D debris from landfill disposal are described in Table II-7.

Special landfill sites for the final disposition of construction and demolition landfill sites are also an option. Siting of these landfills is less difficult than for regular MSW landfills since the potential environmental impact in the majority of cases is relatively small.

Table II-7. Sound practices for diverting construction and demolition debris from landfill disposal

- Waste prevention can be promoted through **inventory control and return allowances for construction material**. This ensures that unused materials will not get disposed of unnecessarily.
- **Selective demolition**. This practice involves dismantling, often for recovery, of selected parts of buildings and roadways before the main demolition (wrecking) process is initiated.
- **Onsite separation systems**, using multiple smaller containers at a construction or demolition site to store sorted recyclable materials, as opposed to gross disposal of mixed materials in using a single roll-off or compactor.
- **Crushing, milling, grinding, and reuse of secondary stone, asphalt, and concrete materials**. These materials can be processed to conform to a number of standards for construction materials. Recovery and reuse of these types of materials is facilitated by the existence of approved specifications for road construction materials and by governmental procurement policies that promote or stimulate purchase of recyclable materials.

D5.8. Bulky metallic waste

Bulky metallic waste is composed of metallic objects that occupy large volumes (e.g., greater than 1 or 2 m³) and are composed of high-density material, either when encountered singularly or in combination. Examples of bulky metallic waste are old vehicle bodies, structural steel, large metallic appliances, and discarded fabricating equipment. The most prevalent material of construction for bulky metallic waste is steel, although other types, such as aluminium, are also encountered to a lesser extent. This type of waste is considered a special waste because it is difficult to handle, process, and dispose using the more common and conventional municipal solid waste management equipment. Special, large-capacity equipment is normally required to collect, process, and dispose of bulky metallic waste. Also, much of bulky metallic waste is potentially recyclable. However, the feasibility of recycling is a function of the costs of processing, availability of markets, transportation costs, etc. An example of bulky metallic waste is given in Figure II-3.

Management of bulky metallic waste is a particularly difficult problem for rural and isolated communities (e.g., remote islands) because of limited space for storage and/or disposal, limited financial resources, and long distances to recycling markets.

D5.9. Municipal wastewater treatment (sewage) sludge, septage, and slaughterhouse wastes

Municipal wastewater treatment (MWWT) sewage sludge (biosolids) is generated as a consequence of processing municipal wastewater for safe discharge to the environment. The

sludge is composed of the semi-solid or solid residues remaining after processing of wastewater. Septage, on the other hand, is the material pumped from septic tanks serving residences. Both MWWT sludges and septage contain large quantities of pathogenic organisms, and they often contain chemical contaminants, as well, if liquid discharges at the source are not pre-treated before disposal into the sewer. These materials, therefore, require proper treatment and disposal.



Courtesy: CalRecovery, Inc.

Figure II-3. Bulky metallic waste being loaded for transport to market

Slaughterhouse wastes can be used to produce ingredients in the manufacture of soil amendment, animal feed, and glues. The traditional methods of sun-drying, breaking up bones manually, composting in pits (sometimes with the addition of household organics), and steam digestion carry various types of health risks, and cannot be considered acceptable practices.

Small-scale aerobic composting of animal wastes, including manures, hide scrapings, and tannery and slaughterhouse wastes, can also produce a soil amendment, but carries some risks in terms of spreading pathogens if the wastes are not properly sterilised. All of these activities generate leachate and the associated unpleasant odours, and are typically associated with poor working conditions and risks to worker health, but may be profitable and provide subsistence income. Appropriate methods of management of these types of materials could involve introducing technical and health improvements, rather than entirely eliminating the activities themselves. Other appropriate methods of management are described in Table II-8.

D5.10. Industrial waste

The collection of industrial waste typically is not under the jurisdiction of municipal authorities in industrialised countries. However, in developing countries, where proper industrial waste management systems are not in place, such waste often enters the MSW municipal solid waste stream.

Waste generated from industrial sources can have non-hazardous and hazardous components, with non-hazardous waste usually representing the greater part of the volume. The hazardous component of this waste, while generally being relatively small in volume, can pose significant environmental and public health problems.

Table II-8. Practices for reducing and handling sewage sludge and septage

- **Preventing the generation of large volumes of sludge**, through separation of sewers and storm drainage systems.
- **Minimisation of reliance on centralised sewage systems**, through the installation of onsite treatment of human waste and household wash water, when feasible.
- **Land application**, but only when very frequent sludge testing shows that metal, salt, nitrogen, etc. contents are within tolerable limits, and when the administering authority has the resources and commitment to maintain high standards for monitoring and testing. In practice, this will mean that in many situations the safety of land application is questionable as a viable and appropriate method of management.
- **Treatment such as drying, liming, composting**, or co-composting with yard waste or organics, followed by land application. These methods are designed to return the organic matter in the waste to the land. As indicated above, however, certain constituents of the sludge can make land application inadvisable.
- **De-watering and disposing in landfills**. It is important to note that sludges should be de-watered as much as practical before entering a landfill in order to avoid the production of large volumes of leachate.

Appropriate methods for the proper management of hazardous industrial wastes vary substantially, depending on the specific quantities and characteristics of the waste, cost of management, local regulations, and other factors. The planning and design of methods and facilities for managing industrial hazardous waste are beyond the scope of this publication. The Bibliography, however, includes a useful work by Batstone, et al., which can be used as a general reference. In any case, best waste management practices incorporate separation of hazardous industrial waste from MSW. In those cases where municipal authorities are forced to provide a temporary solution for the disposal of hazardous waste, specially designed cells should be provided within the municipal landfill. These cells must be isolated so that scavengers cannot come into contact with the hazardous waste.

D6. WASTE reduction

The logical starting point for the proper management of solid waste is to reduce the amounts of waste that must be managed, either informally managed within the generator's site or formally (externally) managed by another entity once the waste is discarded by the generator. Thus, the reduced waste quantities do not have to be collected or otherwise managed.

As used in this document, the term "waste reduction" means reduction, or in the limit, prevention, of waste at the source or potential of generation. Waste reduction includes reuse of wastes within a generator's site or related sites (e.g., reuse of industrial scrap in the manufacture of products), or reuse of materials in essentially their current form by a similar group (e.g., reuse of secondhand clothes). Waste reduction includes reduction in quantities or in toxicity of waste. Methods of waste reduction include preventing the generation of waste in the first place.

Reduction of waste is a primary element of solid waste management hierarchies, promoted by a number of international, regional, and national agencies or organisations. A number of economically developing countries have solid waste management hierarchies that list reduction of

waste as the highest priority among the generic methods to manage solid waste (other generic methods include, but are not limited to, recycling and land disposal). This hierarchy follows that enumerated in Agenda 21, the agreement reached among participating nations at the United Nations Conference on Environment and Development in Rio de Janeiro in 1992. In particular, Chapter 21 of Agenda 21 emphasised that reducing wastes and maximising environmentally sound waste reuse and recycling should be the first steps in waste management. At the World Summit on Sustainable Development held in Johannesburg in 2002, these principles of Agenda 21 were reaffirmed. Additionally, the Summit advocated an increased urgency and effort to accelerate implement the principles.

D6.1. Importance of waste reduction

In affluent countries, the main motivations for waste reduction are frequently related to the high cost and scarcity of suitable sites associated with the establishment of new landfills, and the environmental degradation caused by toxic materials in the deposited wastes. The same considerations apply to: 1) large metropolitan areas in developing countries that generally are surrounded by other populous jurisdictions, and 2) isolated, small communities (such as island communities). However, any areas that currently do not have significant difficulties associated with the final dispositions of their wastes disposal pressures can still derive significant benefits from encouraging waste reduction. Their solid waste management departments, already overburdened, are ill-equipped to spend more funds and efforts on the greater quantities of wastes that will inevitably be produced, if not otherwise controlled, as consumption levels rise and urban wastes change.

D6.2. Key concepts in municipal waste reduction

Action for waste reduction can take place at both the national and local levels. At the national level, some strategies for waste reduction include:

- redesign of products or packaging;
- promotion of consumer awareness; and
- promotion of producer responsibility for post-consumer wastes.

At the local level, the main means of reducing waste are:

- diversion of materials from the waste stream through source separation and trading;
- recovery of materials from mixed waste;
- pressure on national or regional governments for legislation on redesigning packaging or products; and
- support of home composting, either centralised or small-scale.

D6.3. Building on what is working

As explained in the following paragraphs, people in many developing countries already carry out significant waste reduction practices. In designing strategies for further waste reduction, the first principle should be to build on what exists and appears to be working. In general, sound practices for the majority of cities and towns in the developing world rest upon:

- facilitating the existing private sector (formal and informal) in waste reduction where current practices are acceptable, and ameliorating problems encountered by all relevant stakeholders through access to capacity-building, financing, and education; and
- designing such assistance to be an integral component of the strategic plan for municipal solid waste management.

Developing a feasible strategic plan requires an understanding and assessment of local practices in waste reduction, waste recovery, and recycling.

D7. SYSTEMS of waste reduction

D7.1. Industrialised countries

Perhaps in no field of municipal solid waste management are the differences between the industrialised countries and the developing countries so apparent as in waste reduction and materials recovery. Rising overall living standards and the advent of mass production have reduced markets for many used materials and goods in the affluent countries whereas, in most of the economically developing countries, traditional labour-intensive practices of repair, reuse, waste trading, and recycling have endured. Thus, there is a large potential for waste reduction in economically developing countries, and the recovery of synthetic or processed materials is now being emphasised. Public or consumer financing of the full range of initiatives for waste reduction (from changes in manufacturing and packaging, to waste reduction audits to identify waste reduction opportunities) are practiced by several affluent industrialised countries.

One of the main motivations, from the point of view of municipal authorities, is to reduce materials that must be collected and deposited in landfills. At the national level, under the concept of producer responsibility, governments have created agreements and legal frameworks designed to reduce the generation of waste. For instance, industry is given responsibility for achieving certain levels of packaging reduction goals of a certain percentage within a given time period.

D7.2. Developing countries

In many developing countries, waste reduction occurs naturally as matter of normal practice because of the high value placed on material resources by the people, as well as other factors. Consequently, reuse of a variety of materials is prevalent. The motivations for materials reuse in developing countries include: scarcity or expense of virgin materials; the level of absolute poverty; the availability of workers who will accept minimal wages; the frugal values of even relatively well-to-do households; and the large markets for used goods and products made from recycled plastics and metals. Wastes that would be uneconomical to recycle or of no use in affluent societies have a value in developing countries (e.g., coconut shells and dung used as fuel). If one takes into account the use of compost from dumps sites as well as materials recovery, in countries like India, Vietnam, and China, the majority of municipal wastes of all kinds are ultimately utilised.

Waste reduction that could be achieved by legislation and protocols (such as agreements to change packaging) is not, at present, a high priority in these countries, although some are now moving in this direction. Because unskilled labour costs are low and there is a high demand for manufactured materials, manufacturers can readily use leftovers as feedstock or engage in waste exchange. Residuals and old machines are sold to less advanced, smaller industries. Public health is benefiting from plastic and boxboard packaging that reduces contamination of foods, and much of the superior packaging is recovered and recycled.

In offices and institutions, cleaners and caretakers organise the sale of paper, plastics, etc. At the household level, gifts of clothes and goods to relatives, charities, and servants are still significant in waste reduction. All cities and towns have markets for used goods. However, the greatest amount of materials recovery is achieved through networks of itinerant buyers, small- and medium-sized dealers, and wholesaling brokers. The extent to which the waste trading enterprises are registered (“formalised”) varies in developing regions: in Latin America and Asia, there is more formal registration than in Africa. The system is adaptive to market fluctuations, as the lowest level workers form a dispensable labour cushion: they must find other work, if they can, when there is reduced demand for the materials that they sell.

From the point of view of waste reduction, the traditional practices of repair and reuse, and the sale, barter, or gift-giving of used goods and surplus materials are an advantage to the poorer countries. Quantities of inorganic post-consumer wastes entering the MSW stream would be higher if these forms of waste reduction did not exist.

D8. PRIORITIES for cities of developing countries

The hierarchy advocated in many industrial countries with high standards of living (with waste reduction given highest priority) may not be appropriate for most communities of less developed countries. Rather, the first priority in most cases should rest with identifying methods to divert organics from entering the municipal solid waste stream, which then requires organised collection and other forms of management. The reason is that organics are usually the largest component of MSW and the greatest reduction in wastes for collection and disposal can be achieved by diverting this component of the waste stream.

Due to lack of development of manufacturing capacity in most developing countries, waste reduction in that sector is not as important as it is in industrialised countries. Nevertheless, developing countries need to be alert to the growth of wasteful practices that may result from modern industrial processes and new modes of consumption. With reference to the latter, for instance, increased usage of and reliance upon thin plastic film for packaging can lead to increased littering of this material, which, if not controlled, can eventually clog surface drainage systems and pollute rivers and other bodies of water. Implementing legislation and incentives at the national level is one potential means of properly dealing with materials that may pose special problems related to management of litter and to adverse environmental consequences of disposal.

E. Summary

The range of issues to be considered in designing a well functioning MSWM system can be overwhelming, even to planners who have considerable resources available. In most of the world, where such resources and expertise are scarce, MSWM issues are even harder to resolve. MSWM, despite its prominent position as an urban problem, is not the only problem competing for the attention of urban managers. Its low status as a field of work has meant that MSWM issues often receive less attention than other urban problems.

The keys to making progress in this field lie in these areas:

- responsible planning and design of an integrated MSWM system, which works to reduce the quantity of waste generated and to handle waste in a coordinated fashion. Essential to this is understanding the nature of the wastes generated.
- adoption of new strategies for revenue generation that move away from sole reliance on a government-owned and -operated MSWM system. In many cases, a balanced mix of public

and private systems can lead to a waste management system that is more flexible and efficient than a wholly publicly-owned and operated system.

- incorporation of small-scale enterprises and the informal sector into the MSWM system; and
- installation of a system of accountability and responsibility at the local level. Residents and businesses can be motivated to act responsibly in MSWM issues. But, most importantly, accountability entails significantly improving the training and capabilities of the managers and planners responsible for the MSWM system.

F. Reference

1. CalRecovery, Inc., *Characterization and Impacts of Nonregulated Hazardous Waste in the Solid Waste of King County*, prepared for Puget Sound Council of Governments, Seattle, Washington, USA, December 1985.

CHAPTER III. WASTE QUANTITIES AND CHARACTERISTICS

A. Introduction

The range of the numerical values presented in Chapter I (Table I-1) illustrates the wide variation that can be expected to exist between countries with respect to the quantity and composition of waste generated. On the other hand, careful scrutiny of the data indicates that despite the variation, three general trends do exist. The first trend is in quantities. It suggests that increases in per capita waste generation parallel increases in degree of economic development. The second trend concerns the concentration of paper in the waste stream. According to the data, the development of a country is closely accompanied by an increase in the concentration of paper in the waste. The third, and perhaps the most important, trend concerns biological solid waste and relates to the quantity of putrescible matter and ash. According to the data in Table I-1, the amounts of putrescible materials and ash in MSW generally decrease as the development of a country advances.

The variation and trends in quantity, composition, and other characteristics of urban waste are not confined to the national level. Indeed, they persist even at the community level. The persistence is due to the fact that the characteristics of the waste stream are affected by an array of factors. Ranking high among these factors are degree of industrialisation, extent and nature of socioeconomic development, and the climate.

Both short-term (e.g., seasonal) and long-term (e.g., 5-year periods) variations in characteristics occur in the case of solid waste; thus, the need for measurements. Two examples of long-term and significant changes in the composition and bulk density of the waste stream of the United Kingdom (UK) are illustrated in Figures III-1 and III-2, respectively. The historical trends shown for the UK are similar to those of many economically developing countries, except shifted forward in time by 40 to 60 years.

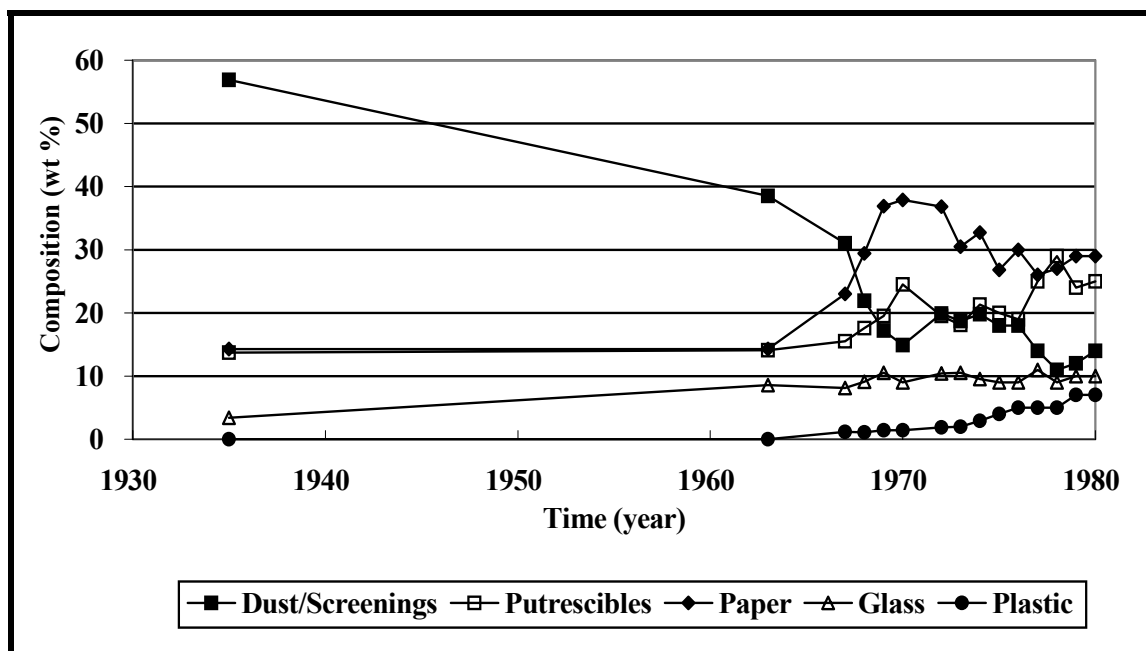

Source: Reference 14.

Figure III-1. Historical changes in MSW composition in the United Kingdom

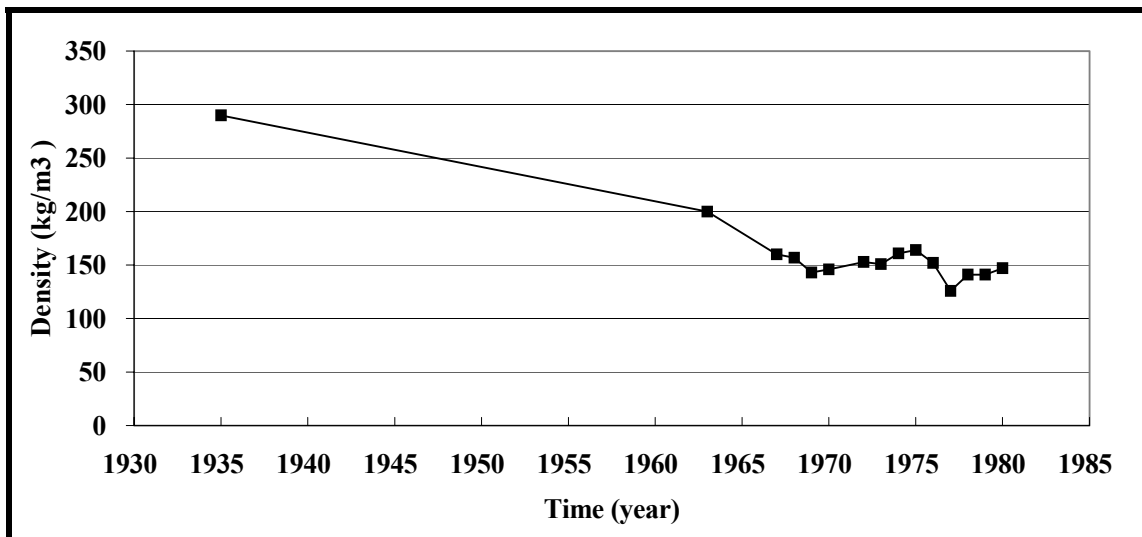

Source: Reference 14.

Figure III-2. Historical changes in MSW bulk density in the United Kingdom

Despite the obvious fact that a thorough understanding of the characteristics of the waste is requisite to making rational decisions in solid waste management, it remains a prevalent practice to pay little heed to conducting a comprehensive and accurate survey of quantity and composition. Instead, reliance is had on some inaccurate method, especially the traffic count. Although traffic counts, if coupled with estimates of volume, may give an indication of the quantities being disposed; strictly speaking, they serve to ascertain solely that which is implied by the term -- namely, the number of vehicles entering the disposal site.

Rigorous, scientifically performed studies of waste quantities and characteristics are required to proper design, operate, and monitor solid waste management systems.

This chapter is concerned primarily with describing important waste characterisation parameters, and methods of determining them, so that designers can have a firm foundation to plan and implement waste management systems. The parameters and methods of determination are described in the following sections.

B. Quantities and composition

Quantity and composition surveys have an essential role in determining the dimensions of the key elements in solid waste management. A list of such elements would certainly include method and type of storage, type and frequency of collection, crew size, method of disposal, and degree of resource recovery. The utility of the surveys extends not only to the evaluation of present conditions, but also to the prediction of future trends. Consequently, frequent and ongoing surveys are the mainstays of a successful solid waste management program.

Surveys either of quantity or of composition must take into consideration scavenging and illegal dumping.

B1. PROCEDURES

B1.1. Quantities

Several methods are available for determining the quantity of wastes that require disposal. The accuracy of the results depends upon the method followed.

Perhaps the only means of arriving at an accurate estimate of the quantity of wastes is one that involves weighing each vehicle and its load of wastes as it enters the disposal site. The approach involves the use of a weighing scale sufficiently large to accommodate vehicles of all sizes that come to the site. Several types of scales can be used. For example, the scales may be permanently installed, or a portable version may be used. The authors have not encountered difficulties in the use of portable scales. The portable scales are equipped with load cells that can be powered by either direct or alternating current. Of course, tare weight (weight of the empty vehicle) also must be determined. An example of a collection vehicle being weighed using a set of portable scales is shown in Figure III-3. A sample data sheet for a weight survey is presented in Figure III-4.

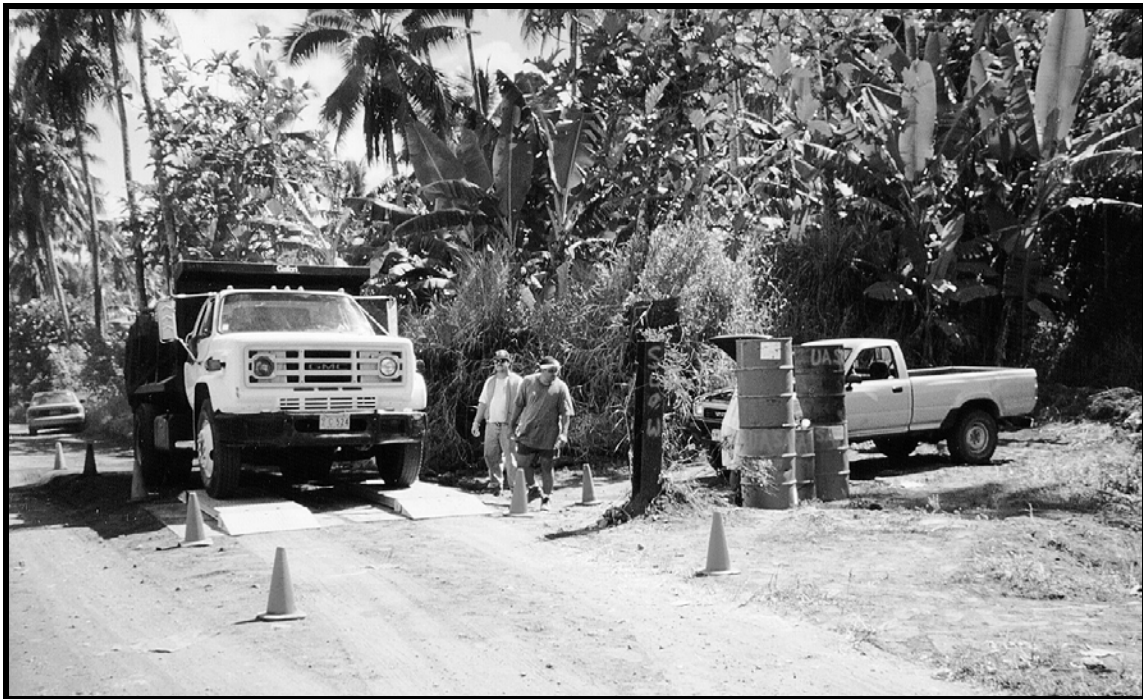

Courtesy: CalRecovery, Inc.

Figure III-3. Collection vehicle being weighed on a set of portable scales

To account for changes due to seasonal or other temporal factors, the weight survey should be conducted for a minimum two-week period, at either two or four intervals distributed throughout the year.

If circumstances make it unfeasible to weigh every loaded refuse vehicle, then recourse can be had to a procedure that entails the weighing of a few randomly selected incoming vehicles. To arrive at the total input, the sample weights are multiplied by the number of loads per day. Although results obtained by such a modified weight survey may be less accurate than those obtained by weighing each vehicle, they are better than those obtained without recourse to any actual weighings.

The third and final method to be described herein is the least accurate of the three in terms of results obtained. It involves the collection of the following data: 1) average density of waste, 2) number of loads collected per day, and 3) average volume per load. The latter quantity is obtained by measuring the vehicle body. The total daily weight is the product of all three, i.e., density, volume, and number of loads per day. For example, if the density is 300 kg/m^3 , the average vehicle volume is 4 m^3 , and the total number of loads per day is 100, then the total daily input to the disposal site is 120 Mg.

At times, the degree of the accuracy required may be beyond that attainable with any one of the three preceding methods. Instances in which such a high degree of accuracy would be a necessity are the determination of the extent of storage needs, the required capacity of a transfer station, or the potential for resource recovery. The deficiency as far as the three cited instances are concerned arises from the fact that the methods are based only on those wastes that are brought to a recognised disposal site. They do not take into account the wastes disposed elsewhere.

Generator			Weight/Volume				Self-Haul Wastes							
							Self-Haul Vehicles					Waste Categories		
Residential	Commercial	Industrial	Gross Weight (kg)	Tare Weight (kg)	Capacity of Vehicle (m ³)	Volume of Waste (%)	Pickup Truck	Other Truck	Auto-mobile	Hand-cart	Other	Yard Waste	C&D ^a	Other ^b
Recorded by: _____							Date: _____							

^a C&D = Construction and demolition debris.
^b "Other" - describe.

Figure III-4. Sample data sheet for a weight survey

A means of determining the real total generation, i.e., wastes brought to the disposal site plus wastes destined for disposal elsewhere, is to multiply the per capita rate of generation (e.g., kg/cap/day) by the number of individuals in the generation area (e.g., community, nation). A difficulty with this approach is that any attempt to reach a truly representative number for the per capita generation rate would be beset with many difficulties. Obviously, it would be physically and economically unfeasible to measure each individual's output even in a small, highly organised community. Consequently, resort must be had to sampling at the generation source.

Rather than attempt to carry on such a sampling program on a large scale, in terms of practicality and economic feasibility, it is better to set up a modest program in which special sampling areas are selected and defined. In setting up areas, care should be taken that all socioeconomic groups are represented. Each participating household in the sampling area is provided with a container of some sort, perhaps a plastic bag, in which the day's output of wastes is placed, as shown in Figure III-5. Each day, the containers are collected and tagged by the agency making the study and are transported to a central point to be weighed, and the weights and other information (e.g., number of individuals in the household, social status) are recorded. Ideally, the containers should be collected daily and the participant be supplied with a new (i.e., empty) container only when the filled one is collected, as shown in Figures III-6, III-7, and III-8. Samples should be collected for at least a 10-day period.



Courtesy: Alternativa

Figure III-5. Distribution of plastic bags for waste characterisation program



Courtesy: Alternativa

Figure III-6. Collection of bags



Courtesy: Alternativa

Figure III-7. Determination of total weights



Courtesy: CalRecovery, Inc.

Figure III-8. Bags used to determine quantity of waste generated

To ensure full cooperation, the sampling program and the rationale behind it should be fully explained to the participants. An individual best qualified for such a task would be a local social worker.

By reconciling the numbers obtained from a weight survey at the disposal site with those based on per capita generation as determined through sampling, it is possible to arrive at an estimate of total waste generation that is sufficiently accurate to meet most needs, whether they be for facility and equipment design or for waste management planning. Table III-1 presents estimated quantities of waste collected (expressed in kg/cap/day) in various cities.

B1.2. Composition

A full knowledge of the composition of the wastes is an essential element in: 1) the selection of the type of storage and transport most appropriate to a given situation, 2) the determination of the potential for resource recovery, 3) the choice of a suitable method of disposal, and 4) the determination of the environmental impact exerted by the wastes if they are improperly managed.

A reasonably realistic estimate of the composition of a community's waste output requires an analytical period of two weeks' duration, repeated two to four times per year. During the two weeks, samples are taken from the collection vehicles at the disposal site. All types of municipal wastes should be sampled, i.e., residential, commercial (offices and markets), and light industrial. The ratio of the number of samples of each type of waste to the total number of samples should be the same as that of the quantities of each type to the total quantity disposed. For example, if

the output of residential waste is ten times greater than the combined commercial and light industrial wastes, then the number of samples of residential wastes should be ten times that of the other two combined.

Table III-1. Estimated quantity of waste collected in various cities and countries

Location	Estimated Quantity (kg/cap/day)^a
India	0.3 to 0.55
Bolivia	0.3 to 0.6
Guatemala City, Guatemala	0.3 to 0.6
Lima, Peru	0.3 to 0.8
Philippines	0.4
Asunción, Paraguay	0.46
Malaysia	0.5
Uruguay	0.5 to 0.9
Tegucigalpa, Honduras	0.52
Rio de Janeiro, Brazil	0.54
Jakarta, Indonesia	0.6
Buenos Aires, Argentina	0.6 to 1.0
Mexico DF, Mexico	0.68
San Salvador, El Salvador	0.68
San José, Costa Rica	0.73
Papua, New Guinea	0.8
Santiago, Chile	0.9 to 1.2
Caracas, Venezuela	0.91
Fiji	0.91
Japan	0.91
Singapore	1.0
Vienna, Austria	1.18
Antigua	1.25
Guam	1.35
Paris, France	1.43
Hong Kong	1.68
Australia	1.87
Seoul, Korea	2.0
New Zealand	2.0

Sources: References 9-11, 15, 16.

^a Ranges indicate data collected from different cities in the country or from different sectors in a city.

Regarding sample size, the minimum weight per sample should be on the order of 100 kg. If the sample size is too small, the possibility of obtaining a representative sample is lessened. On the other hand, accuracy is not improved sufficiently to warrant taking samples greater than 100 kg in size [1].

To reduce the magnitude of errors arising from moisture change and from decomposition, analysis of the samples should be begun within two to three hours after collection.

A sample data sheet developed for the conduct of compositional studies in the United States is shown in Figure III-9. Because the data sheet shown in the figure is very comprehensive, it may

be modified as needed. Indeed, in some countries, it may not be necessary to sort the refuse into every category shown in the figure. For example, mixed paper, newspaper, and cardboard can be combined under the single category of paper. To carry out the analysis, the wastes in the samples are sorted according to the categories listed in the selected data sheet. In the sorting process, each type of waste is placed in its appropriate container (see Figure III-10). At the completion of the sorting, each container and its contents are weighed (gross weight). Gross and tare (empty container) weights should be recorded. The difference between the two weights is the net weight of the individual components.

Sample #	Start Weight		Date	Recorded by	
CATEGORY	Gross Weight	Container Type/Tare	CATEGORY	Gross Weight	Container Type/Tare
Paper			Other Organic		
(a) Corrugated/Paper Bags			(a) Food		
(1) Uncoated Corrugated			(b) Yard/Landscape		
(2) Coated Corrugated			(1) Leaves/Grass		
(3) Brown Paper Bags			(2) Prunings/Trimmings		
(b) Newspaper			(3) Branches/Stumps		
(c) Office Paper			(c) Ag. Crop Residues		
(1) White Ledger			(d) Manures		
(2) Coloured Ledger			(e) Wood		
(3) Computer Paper			(f) Textiles		
(4) Other Office Paper			(g) Tires		
(d) Mixed Paper			(h) Remainder/Composite		
(1) Magazines/Catalogues			Other Inorganic		
(2) Phone Books/Directories			(a) Inerts		
(3) Other Mixed Paper			(1) Rock		
(e) Remainder/Composite			(2) Concrete		
Glass			(3) Brick		
(a) Clear Bottles/Containers			(4) Soil & Fines		
(b) Coloured Bottles/Containers			(5) Asphalt		
(1) Green Bottles/Containers			(6) Gypsum Board		
(2) Brown Bottles/Containers			(b) Remainder/Composite		
(c) Flat Glass			HHW & Special Waste		
(d) Remainder/Composite			(a) Household Hazardous		
Metal			(1) Paint		
(a) Ferrous Metals			(2) Automotive Fluids		
(1) Tin/Steel Cans			(3) Batteries		
(2) Other Ferrous			(4) Remainder/Composite		
(b) Non-Ferrous Metals			(b) Special Waste		
(1) Aluminium Cans			(1) Ash		
(2) Other Non-Ferrous			(2) Biosolids		
(c) White Goods			(3) Industrial Sludge		
(d) Remainder/Composite			(4) Treated Medical Waste		
Plastic			(5) Bulky Items		
(a) HDPE			(6) Remainder/Composite		
(1) Natural HDPE			Mixed Residue		
(2) Coloured HDPE			Comments: (continue on reverse side if needed)		
(b) PET					
(c) Film Plastic					
(d) Other Plastic					
(1) PVC					
(2) PP					
(3) PS					
(e) Remainder/Composite					

Figure III-9. Sample waste composition data sheet

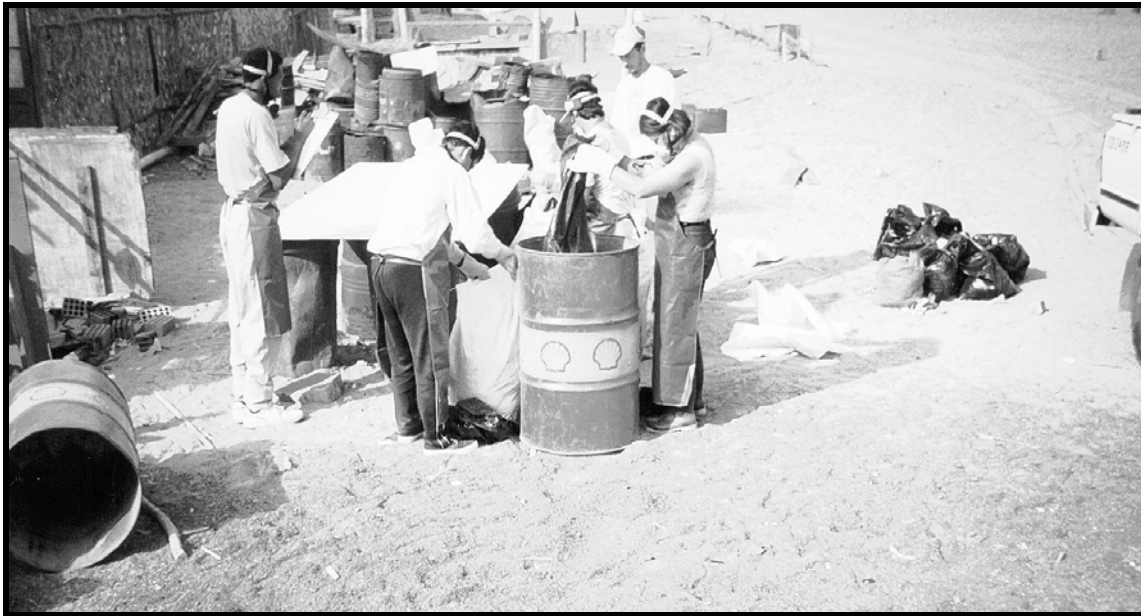

Courtesy: Alternativa

Figure III-10. Waste composition analysis in a peri-urban area

C. Other characteristics

In addition to analysing for composition, it is recommended that the sampling program include provisions for determining moisture content, bulk density, and particle size distribution. The measurement of these three properties is especially recommended if no prior scientific waste characterisation study has been performed locally. These particular characteristics have a substantial influence on determining: 1) wastes that will be difficult to manage, 2) proper and best methods for storing, collecting, processing, and disposing of the wastes and 3) marketability of potentially recoverable materials. In addition to the moisture content, particle size, and bulk density, a knowledge of several other properties of solid waste are also required for properly planning, designing, and operation waste management programs. Among such other properties are chemical/thermal and mechanical analyses.

Moisture Content

The moisture content is determined as follows: The sample is weighed as received (“wet weight”). It is then allowed to stand until it is air-dry, i.e., its moisture content is in equilibrium with that of the ambient air. The percent moisture content is then obtained through the following formula:

$$\text{Moisture Content (\%)} = \frac{W_w - W_D}{W_w} \times 100$$

where:

- W_w = wet weight of sample, and
- W_D = dry weight of sample.

C1. BULK density

The bulk density can be measured by filling a container of known volume with wastes and then weighing the loaded container, as shown in Figure III-11. (The container should be constantly shaken during filling.) The bulk density is calculated by dividing the net weight of the refuse

(weight of loaded container minus weight of empty container) by its volume. The result is expressed as kg/m^3 . Bulk densities obtained in various countries are presented in Table III-2. In addition, bulk densities of various types of wastes are given in Table III-3. For comparison purposes, the densities of virgin materials are presented in Table III-4.



Courtesy: CalRecovery, Inc.

Figure III-11. Determination of bulk density

C2. SIZE distribution

Size distribution may be determined with the use of a set of manually manipulated screens. The screens should have square openings, particularly those with large openings, and the sizes of the openings included in the set should be 100, 50, and 25 cm. The screens, particularly those with large openings, can be easily made with lumber and wire, as shown in Figures III-12 and III-13. The sample size should range from 150 to 300 kg.

Table III-2. Bulk densities of residential wastes for various countries

Country	Density (kg/m ³)
United Kingdom	150
United States	100
Egypt	330
Nigeria	250
Singapore	175
Tunisia	175
Bangladesh	600
Burma	400
India	400 to 600
Indonesia	400
Mexico	300 to 500
Nepal	600
Pakistan	500
Paraguay	390
South Korea	200 to 450
Sri Lanka	400
Thailand	250
Tanzania	330

Sources: References 3, 4, 6.

Table III-3. Typical bulk densities of mixed MSW and various components of MSW

Component	Density (kg/m ³)
MIXED SOLID WASTE	
Mixed MSW	
Loose	90 to 178
After dumping from compactor truck	207 to 237
In compactor truck	297 to 416
In landfill	475 to 772
Shredded	119 to 237
Baled	475 to 712
Mechanically-Recovered Fractions (Loose)	
dRDF	481 to 641
Aluminium scrap	224 to 257
Ferrous scrap	369 to 417
Crushed glass	1,042 to 1,363
Powdered RDF (Eco-Fuel)	417 to 449
RECOVERED MATERIALS	
Loose	
Corrugated	16 to 32
Aluminium cans	32 to 48
Plastic containers	32 to 48
Miscellaneous paper	48 to 64
Garden waste	64 to 80
Newspaper	80 to 112
Rubber	209 to 258
Glass bottles	193 to 305
Food waste	353 to 401
Tin cans	64 to 80
Densified	
Baled aluminium cans	193 to 289
Cubed ferrous cans	1,042 to 1,491
Baled corrugated	353 to 513
Baled newspaper	369 to 529
Baled high grades	321 to 465
Baled PET	209 to 305
Baled HDPE	273 to 385

Source: Reference 8.

Table III-4. Bulk densities of virgin materials

Component	Density (kg/m³)
Wood	593
Cardboard	689
Paper	705 to 1,154
Glass	2,501
Aluminium	2,693
Steel	7,855
Polypropylene	898
Polyethylene	946
Polystyrene	1,042
ABS	1,026
Acrylic	1,186
Polyvinylchloride (PVC)	1,250

Source: Reference 8.

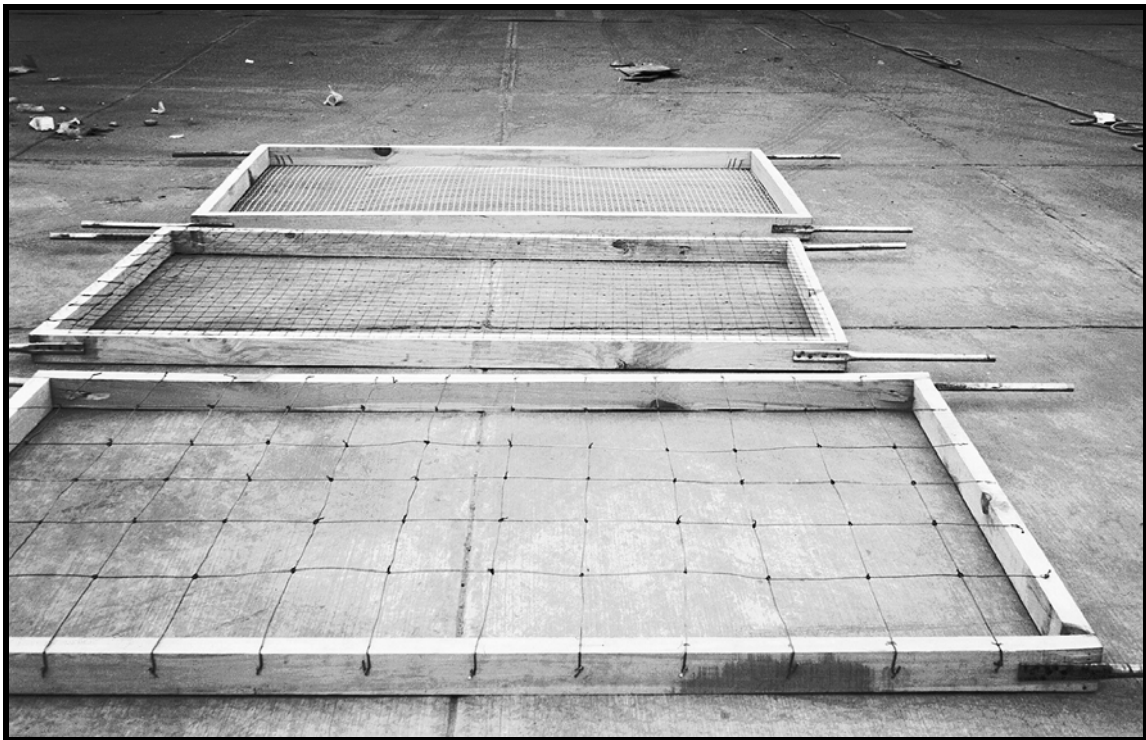

Courtesy: CalRecovery, Inc.

Figure III-12. Screens specifically made to determine size distribution of waste



Courtesy: CalRecovery, Inc.

Figure III-13. Testing of the screens by crew members

Representative waste from the sample is placed on the largest of the screens (100 cm). The screen is shaken until particles of refuse no longer pass through the openings. Material remaining on the screen (oversize) is collected and weighed. The material that has passed through the screen (undersize) is placed on the screen with the 50-cm openings, which is shaken as in the preceding step. The process is repeated until all three screens have been used. The fractions that are sized are weighed, and the weight values are used to plot a size distribution curve. Typically, the size distribution is plotted as cumulative percent passing versus screen size. A sample data sheet is shown in Figure III-14. Sample size distribution curves for some waste components generated in the United States are shown in Figure III-15, and those for wastes generated in Mexico City in Figure III-16.

C3. CHEMICAL/thermal properties

Determination of chemical/thermal properties of solid wastes or its components would be necessary in order to ascertain the most appropriate type of treatment. These analyses must be conducted by a reliable laboratory. The authors generally rely on either governmental laboratories or universities to perform the work. Typical analyses include moisture and ash contents; calorific value; and the concentrations of carbon, nitrogen, hydrogen, oxygen, and some heavy metals if there are reasons to suspect that they may be present. The results of analyses conducted in various countries are presented in Table III-5. Additional properties of MSW and its components can be found in Reference 13.

C4. MECHANICAL properties

Despite the fact that the proper design of processing plants as well as final disposal facilities should include a thorough understanding of the properties of refuse and its components, this requirement has, up until recently, been ignored. Perhaps this can be explained by the absence of

reliable information readily available in the literature. This problem is particularly more pronounced in economically developing countries. Mechanical properties are especially important in the design of sanitary landfills and ancillary systems. This section presents the results of analyses carried out using raw (fresh) MSW, fractions of MSW, as well as landfilled MSW generated in industrialised countries in Western Europe. Due to the sharp differences in the composition and characteristics between these wastes and those from economically developing countries, it is recommended that the data presented in these sections be used simply as references and modified to suit the conditions of the particular location.

Date:			Sample Wet Weight:		
Location:			Sample Dry Weight:		
Sample No.:			Moisture Content:		
Type of Material:			Type of Generator:		
Screen Size	Gross Weight Retained by Screen	Tare Weight	Net Weight Retained by Screen	% of Feed on Bottom Screen	Cumulative Wt % Passing Bottom Screen
Total Sample Weight:					

Figure III-14. Sample data sheet for size distribution analysis

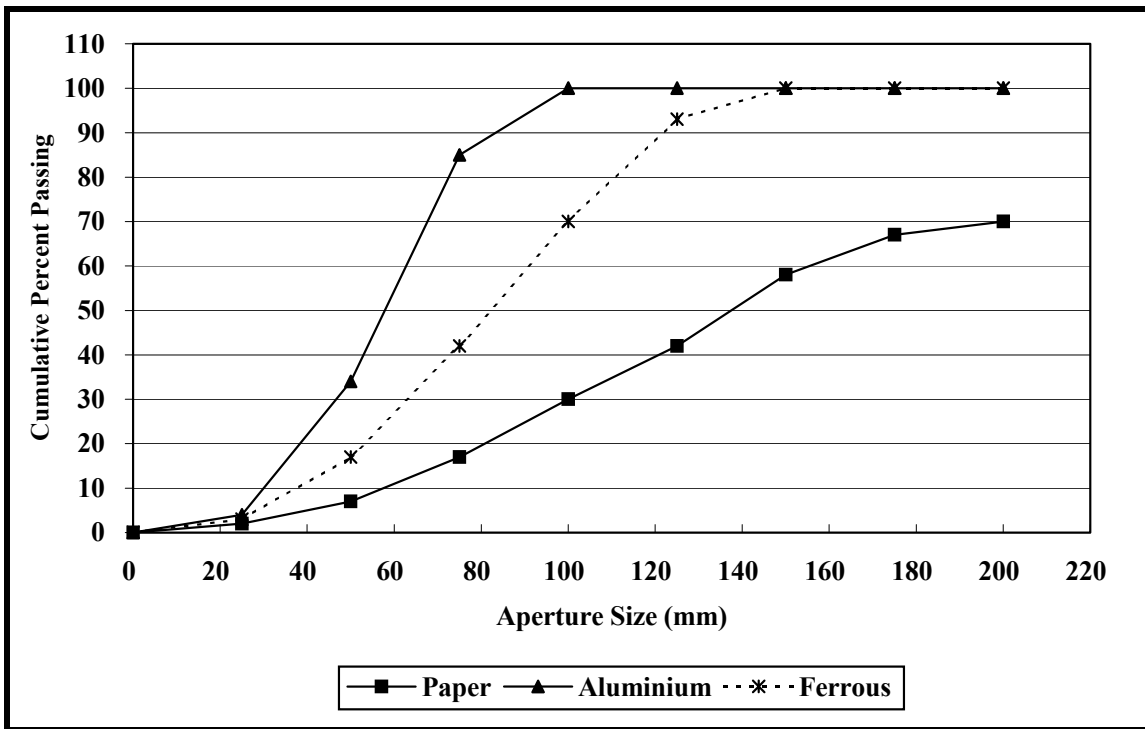

Source: Reference 2.

Figure III-15. Sample size distribution of raw MSW components in the United States

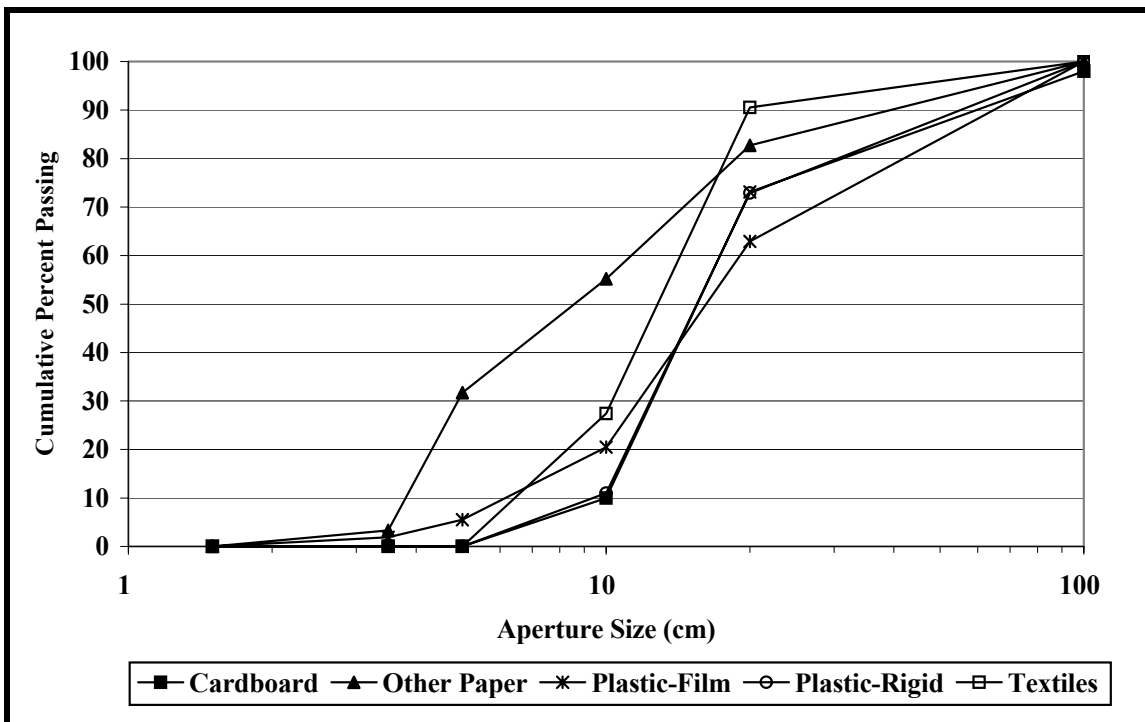

Source: Reference 5.

Figure III-16. Sample size distribution of MSW components in Mexico City

Table III-5. Physical and chemical characteristics of residential wastes from various countries

Location ^a	M.C. (%)	VS (%)	Ash (%)	C (%)	H (%)	N (%)	P (%)	Cl (%)	S (%)
Manila, Philippines	42.6	33.8	23.6	18.3	2.2	0.24			
Mexico City, Mexico	50	32.5	33	15	1.5	0.9			
Calcutta, India	42	32	26	18	N/A	0.55	0.55		
Seoul, Korea	44.2	17.7	38.1	8.9	1.2	0.47		0.22	0.04

Sources: References 4-7.

^a Summer, medium-level residences.

C4.1. Stress-strain

The results of triaxial compression tests conducted on raw MSW and on mixtures of MSW and incinerator bottom ash are given in Figure III-17. As shown by the curves in the figure, ash has a considerable impact on the behaviour of refuse.

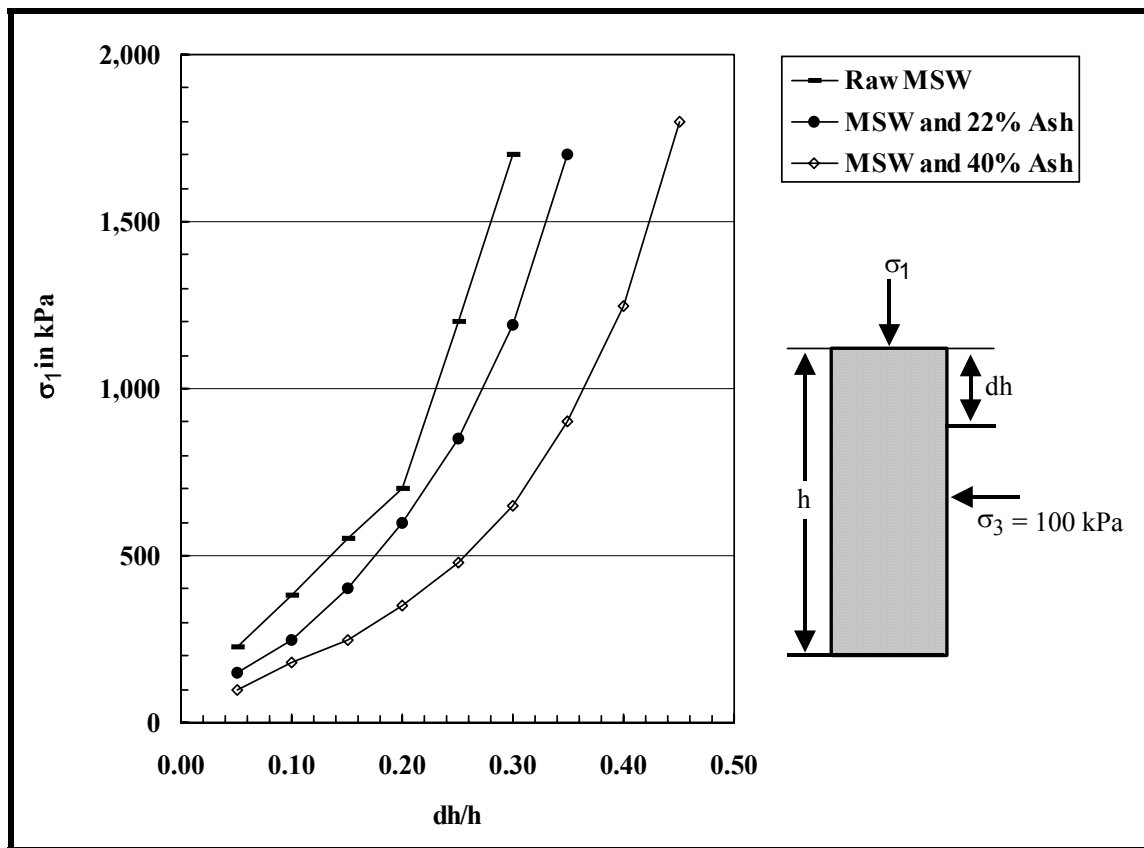

Source: Reference 10.

Figure III-17. Stress-strain curves for MSW samples

C4.2. Relationship between stress and dry density

The results of laboratory tests to ascertain the impact of normal stress on the dry density of different types of refuse are presented in Table III-6. The data in the table demonstrate that the samples of degraded refuse have substantially higher densities than the samples of fresh refuse.

C4.3. Absorptive and field capacities

Tests have been carried out using a large-scale compression cell to determine several hydrogeological and geotechnical properties of refuse. The results of these analyses are useful in the evaluation of leachate management systems. The tests to determine the absorptive and field capacity of the samples are presented in Tables III-7 and III-8, respectively.

Table III-6. Impact of normal stress on the dry density of refuse

Normal Stress (KN/m ²)	Dry Density (Mg/m ³)			
	Raw ^a Refuse	Residual ^b Refuse	Decomposed ^c	Mined ^d
100	0.54	0.58	0.89	
200	0.64	0.65	0.95	1.04
300	0.72	0.72	1.01	1.00
400				1.10

Source: Reference 11.

^a As collected, without separation.

^b Without "organic" components.

^c Raw refuse after 1.5 yr of degradation in piles.

^d Excavated from landfill after 5 yr.

Table III-7. Absorptive capacity of refuse

Material	Initial Moisture Content (% wet wt)	Initial Field Capacity (% dry wt)	Absorptive Capacity (L/Mg wet wt)
Raw refuse	34	112	393
Raw refuse	35	102 ^a	332
Shredded refuse	28.8	141	718

Source: Reference 12.

^a Field capacity at stress of 40 kPa.

Table III-8. Field capacity of refuse as a function of stress

Applied Stress (kPa)	Shredded Refuse		Unprocessed (Raw) Refuse ^a	
	Dry Density (Mg/m ³)	Field Capacity (% dry wt)	Dry Density (Mg/m ³)	Field Capacity (% dry wt)
Initial	0.25	141	0.33	N/D ^b
40	0.29	115	0.39	102
87	0.35	103	0.43	101
165	0.43	76	0.49	88
322	0.53	64	0.62	73
600	0.60	60	0.71	61

Source: Reference 12.

^a Moisture content = 102% on a dry weight basis.

^b N/D = Not determined.

D. References

1. Diaz, L.F., G.M. Savage, and C.G. Golueke, *Resource Recovery from Municipal Solid Wastes: Vol. I, Primary Processing*, CRC Publishers, Inc., Boca Raton, Florida, USA, 1992.
2. Diaz, L.F., G.M. Savage, L.L. Eggerth, and C.G. Golueke, *Composting and Recycling Municipal Solid Waste*, Lewis Publishers, Ann Arbor, Michigan, USA, 1993.
3. Diaz, L.F. and C.G. Golueke, "Solid Waste Management in Developing Countries", *BioCycle*, 26:46-52, September 1985.
4. CalRecovery, Inc., *Metro Manila Solid Waste Management Study - Waste Stream Characterization*, prepared for Ad Hoc Committee, Republic of the Philippines, May 1982.
5. CalRecovery, Inc., *Criterio de Diseño - Planta de Selección y Recuperación de Subproductos de los Residuos Sólidos Municipales*, prepared for Mexico City, Mexico, December 1992.
6. Nath, K.J., "Solid Waste Management in the Present Indian Perspective", proceedings of ISWA 1993 Annual Conference, Jönköping, Sweden, September 1993.
7. Japan International Cooperation Agency, *Master Plan and Feasibility Study on Seoul Municipal Solid Waste Management System in the Republic of Korea*, Draft Final Report, Tokyo, Japan, August 1985.
8. CalRecovery, Inc., *Conversion Factor Study - In-Vehicle and In-Place Waste Densities*, prepared for California Integrated Waste Management Board, USA, March 1992.
9. CalRecovery, Inc., *Solid Waste Management Options in American Samoa*, prepared for National Renewable Energy Laboratory, March 1994.
10. Grisolia, M., Q. Napoleoni, and G. Tancredi, "Contribution to a Technical Classification of MSW", *Proceedings of the Fifth International Landfill Symposium*, Volume II, Cagliari, Italy, 1995.
11. Kolsch, F., "Material Values for Some Mechanical Properties of Domestic Waste", *Proceedings of the Fifth International Landfill Symposium*, Volume II, Cagliari, Italy, 1995.
12. Beaven, R.P. and W. Powrie, "Hydrogeological and Geotechnical Properties of Refuse Using a Large Scale Compression Cell", *Proceedings of the Fifth International Landfill Symposium*, Volume II, Cagliari, Italy, 1995.
13. CalRecovery, Inc., *Handbook of Solid Waste Properties*, Governmental Advisory Associates, Inc., New York, New York, USA, 1993.
14. World Health Organization, Regional Office for Europe, *Urban Solid Waste Management*, edited by Institute for the Promotion of International Health Actions (IRIS), Copenhagen, Denmark, 1991.
15. Morwood, R., "Australian Waste Management - Towards 2000", *Proceedings of 32nd Annual International Solid Waste Exposition*, SWANA, San Antonio, Texas, USA, August 1994.

16. Scharff, C. and G. Vogel, "A Comparison of Collection Systems in European Cities", *Waste Management & Research*, 12(5), October 1994.

CHAPTER IV. STORAGE AND COLLECTION

A. Introduction

Storage and collection of waste are some of the more visible signs of successful or unsuccessful solid waste management systems. If successful, the result is clean surroundings and good public sanitation; if unsuccessful, litter and poor public sanitation are everywhere self evident to the knowledgeable observer. Good public sanitation begins with a properly designed and operated waste storage and collection system. The institution of successful storage and collection systems in developing countries requires not only a knowledge of appropriate technologies and operating practices, but also recognition of the types of problems faced by these countries relevant to storage and collection.

Before a presentation is made on the technical methods associated with waste storage and collection, a brief discussion of some of the more critical problems associated with the poor performance of the waste collection service in developing countries is given. A number of factors contribute to the relatively low level of waste collection service that is common in many developing countries. Some of these factors are financial, institutional, technical, and social ones.

A1. LOW coverage in the provision of services

In most situations evaluated by the authors, the urban poor receive minimal, if any, solid waste collection services. Even when collection service is provided in poor or marginal areas, the level (i.e., quality and coverage) of service is much lower than that made available to middle- and high-income areas. For instance, in La Paz, Bolivia, one report estimated that a very small percentage of the waste generated in poor neighbourhoods was collected in 1986; whereas, about 60% to 80% of the waste was collected in upper-income residential areas [1]. Similar situations have been observed throughout large metropolitan areas in Latin America, Africa, and Asia. Clearly, the communities inhabited by high-density, low-income populations have a great need for quality collection services.

Several reasons exist for the poor levels of service generally achieved in low-income communities. Two of the more important reasons are: 1) the communities usually evolve without any type of planning and, thus, it is difficult for collection vehicles to reach them; and 2) since these communities often are illegal settlements, they generally do not pay any municipal taxes.

A2. APPLICATION of inappropriate technology

The use of inappropriate technology for the collection of wastes in developing countries is a common problem. A waste collection vehicle that has been designed to accommodate a particular type of waste may not be able to properly collect and transport another type of waste. Vehicles that are designed to operate in low-density urban areas with wide, well-paved roads do not perform to the same level of service and in the same manner in locations with narrow, poor quality roads and with a high-density population. Generally, communities strive to standardise their collection vehicles assuming that similarity will result in cost-efficient operation and maintenance. This standardisation has resulted in the exclusion of large areas of cities from collection service. Vehicle design standards based on the requirements of the middle- and high-income areas rarely are suited to the needs and conditions of low-income areas.

In industrialised countries, where the economic lifetimes of collection vehicles are 5 to 8 years and preventive maintenance is practiced fastidiously, the cost of maintenance alone generally is

only a small fraction of the costs associated with ownership and operation of a collection vehicle. On the other hand, this condition is not prevalent in developing countries, where collection vehicles commonly are kept well beyond their useful economic life even when maintenance costs and downtime are sufficiently high to warrant vehicle replacement. We have observed that in many cities in developing countries, the collection fleet is comprised of vehicles that are on the order of 10 to 15 years old. In some cases, such as that in Chittagong, Bangladesh, some of the collection vehicles were more than 30 years old. Obviously, the continued use of vehicles beyond their economic life has a serious negative impact on the efficiency and reliability of the collection system [2].

Inappropriate technology also is reflected by the incorrect balance between labour and equipment, or by poor selection of low-technology equipment. This situation also leads to inefficient and costly collection processes. An excellent example of inappropriate application of low technology is the interface between handcarts or tricycles and motorised vehicles. In many locations, basic collection is carried out in handcarts. Once full, the carts are taken to a specific location, where the waste is discharged on the ground. The waste eventually is transferred onto motorised transport vehicles by means of rakes, baskets, and shovels. In low-income developing countries, vehicle costs as well as fuel costs generally are high, while labour is relatively inexpensive. In these situations, the application of labour-intensive methods would result in optimum system cost efficiency and high vehicle productivity. On the other hand, in middle-income countries (i.e., economies in transition), we have found that it is necessary to conduct a careful, thorough analysis in order to determine the optimum level of mechanisation.

In some situations, inappropriateness might be related to the fact that the collection equipment cannot be properly maintained under the conditions in which it is operated. Generally, in most developing countries the resources allocated to maintenance are grossly inadequate. Thus, the specification of equipment that requires continuous and precise maintenance procedures, as well as the use of imported spare parts, will result in extraordinarily high maintenance expenses and long periods of downtime.

Another important, and often overlooked, aspect of equipment and system selection is the almost complete lack of consideration (and in some cases understanding) of cultural and socioeconomic conditions of the country. Consideration must be given to the behavioural responses of the public with respect to the planned collection equipment and system. The neglect of cultural and socioeconomic considerations has oftentimes led to the application of equipment and systems that have not been accepted by the population that they were intended to serve and, thus, the systems failed in a relatively short period of time.

A3. TENDENCIES to acquire imported equipment

In developing countries, municipal revenue generally is only 1% to 5% of the base available in industrialised countries. Consequently, internal revenue for the financing of capital equipment is limited. This shortage of revenue is further exacerbated in the case of procurement of foreign equipment and vehicles. Instead of the use of or reliance on foreign equipment and systems, improvements in solid waste collection services in developing countries, in many cases, can be best promoted through improvements in the system of municipal finance, through the application of labour-intensive methods, and through the development of local capability for manufacturing vehicles and equipment.

Generally, the ratio of external funds to national funds for capital investments is high. In many cases, the foreign exchange component of the costs of solid waste projects averages about 50% of the total costs. However, heavy reliance on external funding, inevitable as it may seem if progress

is to be achieved in the short-term, probably is not a wise alternative for long-term development. In most cases, efforts should be made to complement external funding with sufficient levels of internal funds.

For solid waste projects in developing countries, the level and degree of use of appropriate technology can be gauged by the level of foreign exchange component. Projects that rely too heavily on foreign exchange are usually too capital intensive. In addition, in the long-term, these projects may have difficulties in obtaining the sources of foreign exchange necessary for the operation and maintenance of the vehicles and equipment.

A4. INADEQUATE resource mobilisation

In most situations, waste management services are financed through revenue obtained from property taxes. Unfortunately, the systems for collection of municipal taxes generally are outdated, poorly administered, and inefficient, and the rate of collection is extremely low. The relatively low levels of funds obtained from the taxes normally are used for programs that are considered the most critical and that provide services to only portions of the municipality. Low-income communities, especially in marginal areas, generally receive limited or no collection services.

A5. INAPPROPRIATE methods of finance

Due to the severe duty, mechanical equipment used for the collection of waste has a relatively short lifespan, on the order of 5 to 8 years. The higher end of the range is achieved by conscientiously following recommended levels of maintenance. Nevertheless, in most cases, developing countries finance the acquisition of waste collection equipment using medium-term and long-term loans (i.e., 20 to 30 years). In addition, representatives from developing countries do not ensure that the particular municipality will have sufficient sources and levels of revenue to service the loan. The potential of a shortfall of revenues is particularly high when the collection service is to be provided to a large area of low-income population. Although low-income areas typically are in dire need of basic municipal services, the residents of these areas typically have the lowest capacity to pay for the services. Failure to assess the capacity of some municipalities to generate sufficient revenue, and their ability to service their debt, has left municipalities without prospects for adequately operating, maintaining, or replacing equipment.

B. Overview of present situation

The following is a brief overview of the methods of storing and collecting wastes that are commonly used by a large number of developing countries.

The average quantity of municipal solid waste generated throughout Latin America, Asia, and some countries in Africa is on the order of 400 g/cap/day. This is approximately 30% to 40% of the daily per capita waste generation in the United States and in western European countries. Furthermore, it has been estimated that about 30% to 50% of the wastes generated in developing countries are never collected. Uncollected wastes accumulate in vacant lots or are simply discharged into bodies of water. Because of improper disposal and excessive littering, in many instances, the burden of waste collection is transferred from the collection system to the street cleaning system.

Typical productivity of a refuse collection worker in developing countries (defined as total weight of waste collected by the entire system, divided by the number of collection workers) is approximately 250 kg/day. Average expenditure (at 2002 price level) on solid waste

management, including street cleaning and final disposition, ranges from about US\$1/cap/yr to nearly US\$5/cap/yr.

In many cities in Asia, most domestic and light commercial wastes are stored in communal containers. The wastes are delivered to the containers by the users. Several types of communal containers are used. Containers usually are made from either steel, concrete, or wood; are equipped with lids; and have a capacity ranging between 1 and 2 m³. Portable steel bins have a capacity of about 100 L. Spacing of communal containers is determined primarily by their capacity. The authors have observed that, in most situations, communal containers lead to a series of problems. In some instances, the containers are overfilled or waste is discharged around them. In others cases, the containers are disturbed by scavengers or by animals. In Latin America, domestic and light commercial wastes are stored in a variety of individual containers.

Compactor vehicles are not, as yet, very common in developing countries, although they are now used in several of the large cities. The vehicles that typically are used for the collection of refuse from communal sites are open bodies on standard commercial chassis. Some of the vehicles commonly used for waste collection include the typical dump truck and side-loaders with curved sliding shutters. Both of these units are equipped with hydraulic tipping gear. Only in a few cases have we observed the use of low-loading chassis. Trucks with low-loading chassis eliminate the need to have a crew member stationed in the back. An inexpensive and useful vehicle used in some cities in Southeast Asia is a two-wheel trailer towed by a standard farm tractor. The trailer is low, can be loaded from the side, and is covered.

The collection of wastes from house to house is not well established. Containers of a standard size rarely are used. In several cities, the use of baskets, plastics bags, and kerosene or lard containers is fairly common. In some cases, the bins are kept permanently on the curb outside the house. In other cases, the baskets and other containers are put outside only during the period when kerbside collection is expected or when the collection crew announces its arrival.

Most vehicles are not equipped with tipping gear to discharge the load of wastes. Loading the vehicles usually is a cumbersome process of either filling baskets or similar containers, carrying them to the vehicle and handing them to a person on the vehicle, or using a shovel to load the wastes directly onto the collection vehicle. The vehicles usually are manually unloaded at the disposal sites. Manual unloading of the vehicles takes a considerable amount of time and leads to congestion at the disposal sites.

Another system of house-to-house collection used in developing countries involves the use of handcarts. The handcarts have a capacity of about 1.5 m³. In some cases, the handcarts deliver the materials directly to a collection truck, while in others the wastes are taken to a large communal container or to a transfer station. The latter two approaches are relatively common in large cities in the People's Republic of China.

Industrial wastes generated in large cities and metropolitan areas generally are collected along with the municipal wastes.

The recovery of materials from wastes (scavenging) is practiced throughout the developing world. This type of resource recovery usually is labour-intensive and begins at the point of generation where householders keep reusable materials such as newspapers, glass containers, and cans for their own use or for sale to individuals who ply the streets buying different types of scrap materials. Communal bins generally are searched by scavengers. Scavenging is continued by the refuse collectors and by scavengers at the disposal site.

C. Problems of storage and collection

Most of the problems associated with the storage and collection of solid waste in developing countries can be summarised as follows:

- Large numbers of open communal storage sites and unofficial dumps encourage the breeding of flies and rodents.
- Methods of collection often result in workers coming into direct contact with wastes that sometimes contain faecal matter.
- Collection vehicles generally are too old and too few in number. This problem is primarily due to poor maintenance and the lack of a vehicle replacement policy.

In many cities, the work of refuse collection vehicles is impeded by extremely dense traffic and/or areas where the roads are too narrow to allow passage of motor vehicles. It is common for the residents of these areas to be ignored, leading to the dumping and accumulation of wastes in empty lots or on the banks of streams or drainage canals.

Most of the cost of refuse collection is incurred in the form of manual labour, acquisition of motor vehicles, and operation and maintenance of the vehicles. Economically developing countries have the advantage of low wages, and it is reasonable to suggest that the cost of manual labour can be sustained. Motor vehicles, however, present serious problems. Because of their cost, imported vehicles are difficult to purchase. The difficulty lies in the limited availability of foreign exchange.

Climatic conditions, such as those in tropical areas (high heat and humidity), often dictate certain standards of service in order to protect public health and safety, and the environment, e.g., daily collection of refuse. Daily collection obviously is more costly to provide than the once-a-week service typically provided in North America and in Europe.

In many cases, the management of solid wastes in developing countries is also constrained by social and religious factors. Many families live in crowded conditions in one room, leaving little or no space to store waste. There may also be religious beliefs that forbid the storage of waste within a dwelling.

Many cities lack a network of district depots that could serve as central points of service, offices for district supervisors, and transfer points for wastes collected in small vehicles.

A large portion of the motor vehicles in use has high sidewalls of 2 m or more. Consequently, the loading of waste is a two-person process, i.e., collectors have to stand on the truck to receive the containers passed up to them from personnel located at ground level.

Many vehicles used for collection do not have tipping gear for emptying the load of waste. The lack of tipping equipment leads to loss of time due to manual unloading. Most loads of waste are not covered, resulting in spillage and litter.

Some of the most immediate needs for collection that have been identified include:

- more efficient vehicle design, based to the extent possible on local manufacturing capacity;
- enclosure of wastes at all stages of storage and collection to reduce health risks to the public and to workers;

- use of labour-intensive systems;
- efficient use of motor vehicles in order to achieve high productivity and to minimise the number of vehicles required;
- provision of decentralised control by using district depots with offices and enclosed transfer points; and
- efficient management structure, supported by trained personnel.

D. Components of refuse collection

A refuse collection service requires vehicles and labour. In order to deploy the vehicles and workers efficiently, a clear understanding of the three main components of refuse collection is necessary:

1. travel to and from the collection area;
2. the collection process (transfer of the wastes from storage to collection vehicles, and travel between successive collection points); and
3. the delivery process (transport of the contents of the vehicle to the processing or the disposal site).

During non-working hours, collection vehicles should be kept in a garage with enclosed parking space. The distance between the garage and the collection area should be kept to a minimum because time spent travelling to and from the collection area is not productive. In the case of motor vehicles, this requirement may have to be balanced against the need to centralise facilities for maintenance and fuel supplies, and to centralise the allocation and control of drivers and vehicles.

The slow speed of animal carts and handcarts requires the provision of closely spaced district depots. District depots also are efficient tools for the control of the collectors.

The many methods of transferring wastes from storage to the collection vehicle fall into the following three main categories:

1. Direct emptying of a portable storage container into the vehicle, normally used when the vehicle can be positioned close to the containers.
2. Emptying of a portable storage container into a transfer container (usually a larger container or basket), which is then emptied into the storage compartment of the vehicle; the large container is normally used when the location of the storage container is a long distance from the route of the vehicle in order to avoid non-productive time.
3. Transfer of loose wastes stored on the ground, which usually requires that the wastes be raked or shovelled into the vehicle.

These three categories have been presented in descending order of level of effort required. Thus, the first is the most efficient in terms of labour and vehicle productivity; it is also the method that maintains human contact with the wastes to a minimum.

Travel time between successive collection points depends, first of all, upon the distance between them. When collection points are located some distance apart (as is the case with large communal

storage sites), travel by motor vehicle will be at normal road speed and the collectors will ride on the vehicle. This is an efficient method of transporting the workers between sites.

However, when collection is from house to house, the collectors generally walk the short distances between containers and the collection vehicle correspondingly moves slowly and at intervals. For this element of travel, the motor vehicle is not used efficiently. The vehicle incurs heavy wear on the clutch and transmission, as well as high fuel consumption. Handcarts and animal carts are much more efficient in this situation, because they can operate at their optimum speeds and no energy is used while they are stationary.

For collectors walking from house to house, the distance to be walked is proportional to the number of people in a team. A single individual walks from one house to the next. In a three-person team, each person collects from every third house; thus, labour productivity declines as team size increases. On the other hand, vehicle productivity increases with team size since the vehicle is loaded more quickly.

In the delivery process, a full vehicle usually travels at normal road speed from the last collection point to the processing or disposal site. This represents maximum productivity for the vehicle, but lost time for the collectors if they accompany it. Handcarts and animal carts are inefficient for this operation because of their slow speeds and limited capacities.

The following conclusions can be drawn:

- Minimum physical infrastructure for waste collection includes a central garage, with parking space for motor vehicles, and district depots for assembling and controlling collectors, handcarts, and animal carts. The locations of the depots should minimise travel time between depot and working area.
- Systems that provide for the direct emptying of portable storage containers into a vehicle offer the highest productivity and the lowest health risk to workers.
- Large teams yield low labour productivity and high vehicle productivity in the direct collection of wastes from residences.
- Handcarts and animal carts may be more efficient than motor vehicles for the house-to-house collection activities.
- Motor vehicles are usually the most efficient means of transport of full (large) loads from the last collection point on a collection route to the processing or disposal site.

D1. SOURCES and characteristics of the refuse

Solid waste generation is a relentless, continuous process. Nearly every member of the population generates wastes of one kind or another. Despite the successful use of pneumatic transfer (i.e., air conveyance) in underground pipes at several residential developments in the United States, Europe, and Japan, this method certainly is not practical for the collection of solid wastes in economically developing countries. This means that refuse collection in developing countries must be regarded as a batch process, or a series of batch processes, whereby wastes are stored at the point of origin for a certain period of time before being transferred to a vehicle.

The main sources of solid wastes for which a municipality normally assumes the responsibility of collection are residences, commerce, light industry, and public institutions, as well as refuse

swept from the streets. Residential wastes usually account for about 50% to 80% of the total quantities of wastes generated by the aforementioned sources.

The main components (e.g., paper, glass, etc.) of solid wastes are similar throughout the world. However, the proportions of each component vary widely from country to country, from city to city, and even within a city. The results of waste characterisation analyses are presented in Table IV-1. The analyses, carried out in accordance with the methodology described in Chapter III, very clearly show the variations that exist.

The data in the table generally demonstrate that as the concentration of paper in the waste increases, the per capita rate of generation also increases. The relation is not entirely straightforward because of the substantial variations in the concentrations of ceramics, dust, and stones among the locations shown in the table.

Generally, there are local variations in waste generation, and the proportions of constituents change over weekly and seasonal cycles. Weekly variations are related to the pattern of work and leisure. Seasonal cycles are impacted by climate, seasonal food products, and sometimes by fuel residues (i.e., ash) arising from space heating in winter.

Table IV-1. Quantity and composition of municipal solid waste^a in some developing countries (% wet wt)

Material	Ulaanbaatar, Mongolia [9]	Quezon City, Philippines [10]	Olongapo City, Philippines [5]	Lima, Peru [5]	Buenos Aires, Argentina [11]
Putrescibles	24.0	52.0	44.4	34.3	30.5
Paper	12.9	17.1	17.5	24.3	22.9
Metals	2.5	3.2	3.1	3.4	5.1
Glass	6.4	3.1	2.0	1.7	2.8
Plastics, rubber, leather	13.1	22.0	8.7	2.9	14.6
Textiles	4.4	0.3	2.9	1.7	2.5
Ceramics, dust, stones	36.7	2.3	21.4	31.7	21.6
Wt/cap/day (kg)	0.33	0.55	.44	0.96	3 to 1.0

^a Based on actual measurement; percentages may not sum to 100.0 due to round-off error.

The amount of work involved in refuse collection depends upon the type, weight, and volume of wastes generated; the number of collection points from which the wastes must be removed; the type of storage containers; and the type of collection equipment.

The role of bulk density in determining the volume to be stored and collected is demonstrated by the fact that a low-income dwelling, having daily collection, generates about 4 L of waste. On the other hand, a North American dwelling would generate about 120 L, with a collection frequency of once per week.

The higher rate of residential occupancy in economically developing countries helps to reduce the number of collection points. However, the fewer number of collection points is far outweighed by the usual need to provide more frequent collection service.

The use of communal containers under some conditions could conceivably reduce the total number of collection points. This simplifies the organisation of the collection activity, but may cause problems related to public health and safety, the environment, and convenience of use.

D2. FREQUENCY of collection

The necessary frequency of collection is governed by a number of factors, including: characteristics of the wastes, climate, type of storage (communal or individual), and degree of involvement by householders. Frequency of collection also has a substantial bearing on the cost of collection.

The concentration of putrescible matter in wastes generated in economically developing countries usually is high. Putrescible materials serve as breeding media for flies and are potential sources of foul odors. The eggs of the housefly can hatch in as little as one day. However, the larvae feed for about five days before pupation, which takes an additional three days. The total period to reach maturation may be as little as seven days in tropical countries. A weekly collection, therefore, prevents the production of adult flies in the stored wastes, provided that the larvae are unable to migrate from the container. On the other hand, decomposition of the wastes becomes noticeable during the first two to three days of storage. Consequently, aesthetic standards may be a more critical factor than the lifecycle of the fly.

D3. COMMUNAL storage

The design of communal storage facilities must take into consideration climatic conditions. Climate is important because decomposition of organic matter proceeds much more rapidly in a hot environment than in a temperate one.

When communal storage is used, loss of living space or unacceptable hygienic conditions in the premises is not a problem since the occupants can deliver the wastes to the communal site as frequently as necessary. On the other hand, potential problems are transferred from the domicile to the communal storage site because there generally is no control exercised over proper containment of the wastes, nor over the age of the wastes deposited there. In the event that the wastes have been kept at the premises for several days, the wastes may already be infested with fly larvae. Controlling the migration of larvae from a communal site generally is a much more difficult problem than in a single residence that stores waste in a small container with a lid. To prevent the breeding of flies, the frequency of collection for systems using communal storage ideally should be either daily or at least three times per week, and the storage containers should have lids.

D4. HOUSE-TO-HOUSE collection

In this type of collection system, the general design of the dwelling or building plays a major role in the frequency of collection. Dwellings with relatively large open areas rarely have any problems with the storage of wastes in enclosed containers for periods of up to a week. For example, there are several areas in the United States that have sub-tropical climates, but where weekly waste collection is quite common. This frequency is acceptable only because the following two conditions are satisfied: space is available for storing the container outdoors, and containers are equipped with well-fitting lids to prevent unpleasant odors from escaping and to prevent access by insects and other animals. In addition, the majority of dwellings are equipped with garbage disposal units for the disposal of kitchen wastes by way of the sewer system.

At the other extreme is the small apartment where the only space in which a waste container can be stored is in the working area of the kitchen. Aesthetic standards and space limitation combine

to impose a maximum storage period of 24 hours. Under such conditions, it is necessary to either provide daily collection from each apartment or provide a communal container.

Small shops and large markets where stalls are rented present a similar problem. Daily collection usually is necessary for the shops. On the other hand, market stalls may need collection service several times a day.

In developing countries, the population density of large areas of the major cities is much higher than that in most industrialised countries. In these densely populated areas, external sites for storage of waste usually are lacking. Therefore, the collection frequency for these areas may need to be on a daily basis.

The extent to which statutory duties are imposed upon residents may affect frequency of collection. Where there is a duty to place the domestic container at the kerbside, frequency of collection must be high enough to limit the weight and size of the container to the lifting capacity of an elderly person. Where “block collection” has been instituted (whereby residents deliver their wastes to the vehicle, which stops for a short time at each road intersection), the constraint on weight and volume assumes greater importance because of the longer distance the wastes must be carried.

D5. COST

The unit cost (US\$/Mg) for the manual collection of wastes increases rapidly as the frequency of collection is increased. This is due to the fact that the key parameters that determine the level of effort for a collection route are: 1) the total number of containers to be emptied, and 2) the total distance to be walked and driven among them. These parameters are almost constant for frequencies between one and seven days. In this case, the main variable becomes the weight of the filled containers; therefore, as the frequency increases, the total weight collected decreases and the unit cost increases.

When all the factors are taken into consideration, the following general conclusions emerge:

- Communal containers preferably should be picked up on a daily basis, or at least three times per week.
- Twice-per-week collection is adequate for dwellings having outside storage space, provided that closed, portable containers are used.
- Dwellings and buildings that lack outside storage space should have daily collection, unless communal containers are provided.
- Because frequent collection generally implies high cost, unconventional systems and transport methods may need to be employed to maintain the costs at a minimum level.

E. Methods of refuse storage

E1. DOMESTIC and commercial wastes

The variables that impact the volume required for the storage of domestic wastes are: individual rate of waste generation, number of individuals living in the premises, and frequency of collection. Based on an average of six persons per family, the probable range required for storage in many economically developing countries is as follows [4]:

Collection Frequency	Minimum Volume (L)	Maximum Volume (L)
Daily	4	10
Twice/wk (maximum 4 days)	20	50

The following types of storage containers are available in most countries:

- Plastic buckets (with lids), with capacities between 7 and 10 L, provide sufficient volume for the storage of domestic wastes generated by a family of six for daily collection (see Figure IV-1).
- Plastic bins (with lids), with capacities between 30 and 60 L and equipped with handles, are suitable for a twice-per-week collection.
- Galvanised steel or plastic bins (with lids), with a capacity between 50 and 70 L, are necessary when collection is twice per week from high-income groups, or for daily collection from stores and commercial establishments. Bins of this size are more expensive than the smaller sizes because they are required to have a relatively long lifespan. Steel bins (such as shown in Figure IV-2) should be galvanised after manufacture and plastic bins should be made of high-density polyethylene (HDPE), or plastics of similar characteristics.



Courtesy: CalRecovery, Inc.

Figure IV-1. Plastic buckets typically used for storage



Courtesy: CalRecovery, Inc.

Figure IV-2. Galvanised waste containers (50 to 70 L)

- Disposable plastic bags have a number of advantages. However, cost would be a constraint if the bags are purchased. In economically developing countries, where annual expenditure on refuse collection per family may be on the order of US\$15, the supply of 150 bags/yr, even at the very low cost of US\$0.10/bag, would cost US\$15/family/yr. In many cases, the plastic bags supplied at supermarkets and stores are used for storage and disposal of the wastes (Figure IV-3).
- Other items commonly used for the storage of wastes include cardboard boxes, kerosene cans, and containers made out of truck tires, as shown in Figure IV-4.

An indication of the variety and number of containers used by various types of families in Metropolitan Manila, Philippines can be gained by the data presented in Figure IV-5. The data summarise the results of analyses carried out in low-, middle-, and high-income areas of Metro Manila [3].



Courtesy: CalRecovery, Inc.

Figure IV-3. Plastic bags used for storage of wastes



Courtesy: CalRecovery, Inc.

Figure IV-4. Waste container made from a truck tire

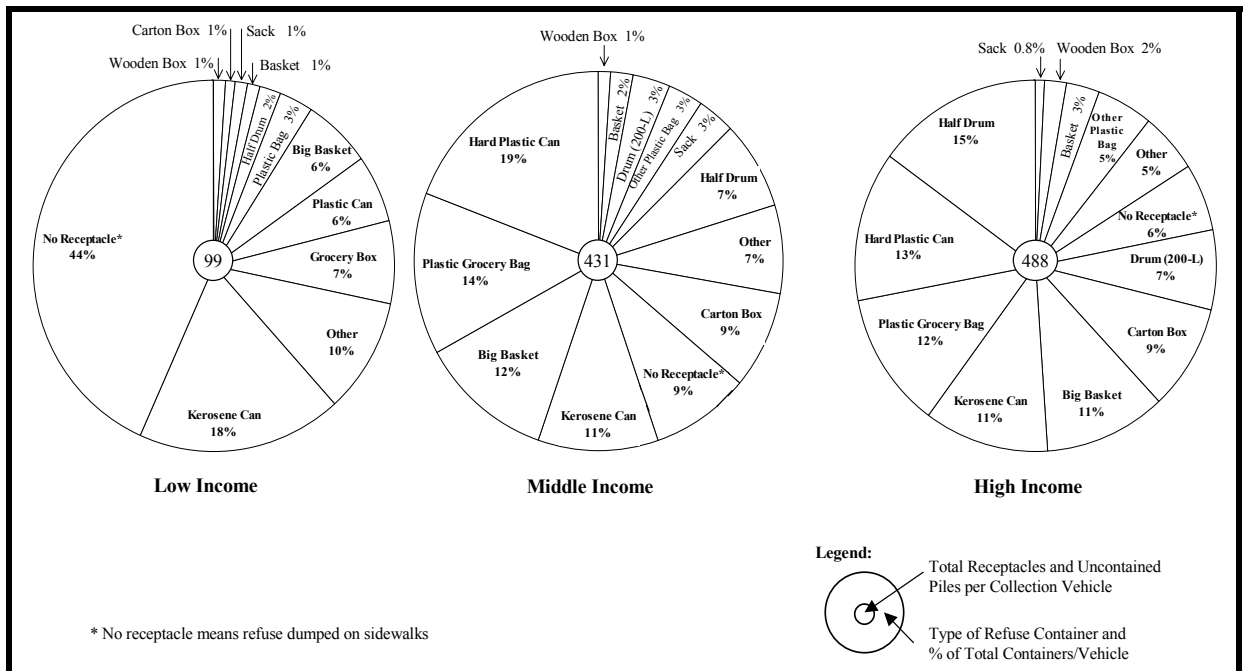

Source: Reference 3.

Figure IV-5. Typical refuse receptacles used within a service area in Metro Manila, Philippines

The problems associated with the provision of standard bins in densely populated, poor areas should not be underestimated. Some of the difficulties include:

- the organisation, distribution, maintenance, and replacement of the bins if they are supplied by the municipality;
- diversion of bins from their intended use (e.g., used for the storage of food or water); and

- loss of containers by theft and when residents move from one location to another.

It is likely that in some areas these problems would be extremely difficult to solve and that the only feasible solution would be in the form of improved standards of communal storage. The use of standardised containers with a capacity of 50 to 70 L is an acceptable method of communal storage at premises subject to inspection and control. Such premises include: shops and market stalls, multiple-dwelling units, schools, hotels, offices, and small industries.

One of the strongest arguments for imposing a standardised container is that it is a necessary foundation for the achievement of maximum productivity in manual collection.

Based on the preceding information, the following general conclusions emerge:

- The use of one type of standardised container in densely populated areas may not be practical.
- A bucket with a lid may be a suitable storage container for most families, but the provision of buckets may have to be voluntary and should be encouraged by public education.
- When the conditions are such that the quantity of wastes generated by residences reaches a level that requires containers exceeding about 25 L of daily capacity, the financial and organisational abilities of the municipality may be adequate to enforce the use of standardised containers.
- Because of the physical limitations on a refuse collector's lifting ability, the use of covered containers of a maximum size, probably from 50 to 70 L for high-density areas, should be enforced for certain types of wastes (i.e., institutional and multi-dwelling wastes). This type and volume of container combines hygienic storage with low collection cost. The exception would be in the situation where total generation is so large as to justify mobile storage containers (drop boxes) of very large capacity (i.e., 30 to 40 m³).

F. Communal storage methods

A refuse collection service generally evolves in the following manner. Initially, wastes are discarded indiscriminately in the streets, rivers, canals, vacant lots, and similar locations. Later, specific locations at which householders deposit their wastes evolve or are imposed. These storage sites are nuisances, particularly to people who live adjacent to them. These sites can be eliminated only by the universal use of household waste storage containers, a solution that is not practical in some areas. In their attempts to alleviate the problems of communal storage, local authorities throughout the world have devised several methods for partially or entirely enclosing wastes. Some of these methods include: depots; enclosures of timber, steel, brick, or concrete; fixed storage bins; sections of concrete pipe; 200-L drums; and portable steel containers [4].

F1. DEPOTS

A depot typically consists of a single-story building about the size of a large garage or the ground floor of a multi-purpose building. Depots commonly are used for storage of domestic and commercial wastes in a number of cities. Many depots are sited on the perimeter of densely populated areas, and residents, shopkeepers, sweepers, and private collectors deliver the wastes to them. The capacity of such depots may be as great as 25 m³. Such large storage places are suitable for very densely populated areas; otherwise, convenience to the user and reasonableness of collection costs are sacrificed.

Waste storage depots solve some of the problems normally associated with communal storage, such as: the wastes are protected from rain, and scavengers and animals can be prevented from gaining access to them because the size of the installation is large enough to justify placing personnel to exercise continuous control over the depot.

The most difficult problem normally associated with the use of depots is their siting. The land area occupied by the depots described in the previous paragraphs is equivalent to that of a large shop. In addition, the location must be on a road sufficiently wide for vehicle access. Generally, such sites are difficult to find and very costly to acquire.

The major criticism of the depots is the manner in which they are operated. Typically, the wastes are discharged on the ground and, thus, the process of collection involves filling baskets that are then carried to a vehicle. This is a dirty and unhealthy procedure for the collectors, who are brought in direct and continuous contact with the wastes.

One possible solution to this problem is to modify the design of the depots to allow the placement of trailers or exchangeable containers into which wastes can be emptied directly by the users.

F2. ENCLOSURES

An enclosure is probably the most common communal storage method in Asia. The main feature of an enclosure is a wall made out of timber, corrugated steel sheet, brick, or concrete, and having a roof. The wall contains the wastes and screens them from view and the wind. Enclosures can have capacities from 1 to 10 m³. At the minimum rate of waste generation, an enclosure having an average throughput of 2 m³/day would serve about 2,000 people. Enclosures usually are located along the roadside, or at the boundary of an open space. The wall around the enclosure usually is designed to have one or more openings through which people can enter to throw their wastes on the ground. The openings are also used by collection workers to remove the wastes in baskets or similar containers. The objections to this type of storage are:

- users tend to throw wastes just inside the entrance, where a pile builds up and ultimately blocks access to the main storage area;
- rain, animals, flies, and scavengers have free access;
- the collection process is dirty and non-hygienic; and
- the enclosures are sometimes used for urination and defecation by animals and humans.

F3. FIXED storage bins

This type of container usually is built from concrete blocks. It differs from the screened enclosure in that it has no entrance for the user. The walls are of a suitable height that users can drop wastes over the wall (1.2 to 1.5 m) into the storage area. The capacity of the bins is rarely more than about 2 m³. A service opening is provided in one wall, sometimes covered by a flap, through which the collectors rake out the wastes. This type of container is shown in Figure IV-6.

Similar rectangular or cylindrical structures fabricated of steel are also used as fixed storage bins. The smallest bins (capacity of about 300 L) are equipped with hinged lids on top and an extraction opening at the bottom. The lids play a substantial role in meeting the primary objectives of communal storage, i.e., the exclusion of animals, insects, and rain. Unfortunately, this device does not keep human scavengers from accessing the waste for the purpose of salvaging materials.



Courtesy: CalRecovery, Inc.

Figure IV-6. Fixed storage bin in Bangladesh

The main objection to using these containers is having to extract the waste by raking it through an opening at ground level. The wastes generally become entwined and compacted and, in practice, their removal through the relatively small aperture is very difficult. Usually, the collectors must climb inside the bins and fill their baskets from the top of the pile. In this process, the collectors come into close contact with the wastes. Sometimes, the flaps covering the extraction opening break off, and then the contents flow out from the opening. The resultant outflow encourages people to discharge their wastes on top of the overflow.

F4. SECTIONS of concrete pipe

One of the key problems of communal storage is that of provision of suitable and adequate storage volume. The required storage volume, in turn, is a function of population density and per capita generation, as well as distance of the storage site from the waste generator. Unless communal storage sites are located within a relatively short distance from the potential user (e.g., within 120 m), people will be tempted to dispose of their wastes at an illegal site that is closer to their homes. For areas of low population density, a need exists for communal containers that have a relatively small volume and are low cost. To meet this need, some communities have adapted short lengths of concrete pipe to this purpose. The most common size of concrete pipe is about 1 m in diameter; the common length is 1 m or less. This provides a volume of approximately 300 L when the pipe is located on a flat area. Although such a container is very sturdy and satisfies the basic need to provide a specific location for wastes, it fails in almost every other aspect, i.e.:

- The wastes are exposed to view.
- The wastes are accessible to flies, rats, domestic animals, and scavengers.
- When the pipes are sited on unpaved surfaces, fly larvae can migrate, pupate, and hatch.

- The wastes have to be removed by means of a rake. This is very strenuous work in an uncomfortable position, and puts the worker in close contact with the wastes.

F5. METAL drums

The metal drum, in particular the 200-L drum, is probably the type of solid waste container most widely used throughout the developing world for communal storage of wastes. The drum used for this purpose usually is a waste product, and has been previously used for the distribution of oil, solvents, or similar materials. Three strong benefits are attributable to the 200-L drum -- it is cheap, readily available, and relatively portable. Drawbacks include the usual lack of a lid, its weight, and its propensity to rust, particularly in moist and salt air climates.

The extent to which a metal, 200-L drum is portable depends upon the weight of the wastes contained within it. The drum itself weighs between 16 and 18 kg. Refuse generated in some areas can have a wet density of about 500 kg/m³. Under these conditions, the total weight of the drum and its contents would be on the order of 110 kg. On the other hand, in the case of light packaging wastes, the gross weight may be less than 70 kg. Even at the lower end of these weight ranges, a full 200-L drum should always be lifted by two people, because of the awkward size of the drum and the lack of handles. At the maximum of the weight range, the drum cannot safely be carried long distances, but it can be rolled on the bottom rim and emptied by two people. The use of 200-L drums for waste storage has been strongly discouraged in the United States by the U.S. Environmental Protection Agency, because the drums are detrimental to the health and safety of collectors, as well as to the general public, and they contribute to lower collection efficiency and higher costs. Most of the difficulty stems from their weight and absence of lids. The drums rarely are used in the United States and have been replaced in most instances by lighter plastic and lightweight, galvanised steel containers of 120 L capacity, with secure lids.

With respect to collection efficiency and cost, small portable containers are feasible in the United States and most countries in Western Europe. However, there are many other countries in the world where 200-L drums would greatly increase collection efficiency and may offer some advantages over present storage and collection methods. Some of the advantages include:

- labour cost would be less than that of loading by shovel or by basket,
- vehicle cost would be reduced as a result of a faster rate of loading,
- health risks to residents would be reduced by preventing migration of fly larvae, and
- health risks to workers would be reduced by avoiding skin contact with wastes.

A major disadvantage of using the 200-L drum is its excessive weight when fully loaded. Lifting and emptying these heavy loads represents a substantial risk of injury to the collector. However, if the collection frequency is designed such that the drums are only partially full, then the risk of injury is reduced. Another disadvantage exists in those cases where the drums are used without lids. In such cases, rainfall can substantially increase the gross weight of the drums. The authors have observed that in locations where there is excessive rainfall, the bottoms of the drums are perforated with several holes, which allow excess moisture to drain. This practice and resulting drainage has obvious implications concerning the health and safety of the public and pollution of the environment.

A few cities have demonstrated that it is possible to use 200-L drums with reasonable success. In most of these cases, the standard of management by the local authority has been high. Some of the key management programs that have been instituted include:

- the drums have been painted both inside and outside for durability and aesthetics;
- locations have been carefully selected and, where necessary, paved and provided with partial fencing;
- excess capacity has been provided to avoid overflow;
- damaged bins are quickly replaced; and
- collection is conducted on a frequent basis (e.g., daily) in order to maintain the weight of the loaded drum to a safe level.

An example of this application in American Samoa is shown in Figure IV-7.

In all cases in which 200-L drums have been used with success, the standards of human behaviour with respect to waste management and of public cooperation were fostered by the government and were above average. This experience demonstrates that when local authorities set a high standard of service, even at low cost, residents will respond by cooperating with the system.



Courtesy: CalRecovery, Inc.

Figure IV-7. Communal storage containers used in Pago Pago

F6. PORTABLE bins

The conventional steel (or plastic) bin of between 70 and 120 L, typically used in industrialised countries for storage of wastes generated by single-family residences, can also be used for communal storage where generation is low and collection frequency high. Galvanised bins having a capacity of about 100 L, with well-fitting lids, have been observed in Southeast Asia, where

each container serves up to 10 families. This, of course, appears to be an excellent solution in terms of hygienic storage, collection efficiency, and the health of residents and workers. On the other hand, this solution requires a significant initial expenditure by the local authority and a very high level of public cooperation. Some cost savings may be achievable by cutting 200-L drums in half and equipping them with legs and lids such as that shown in Figure IV-8.



Courtesy: CalRecovery, Inc.

Figure IV-8. Half-drum (100-L) used as communal container (in foreground)

The types of problems likely to be encountered with the use of portable bins include:

- loss or destruction of bins during use,
- loss or destruction of lids,
- rusting of bins if constructed of steel,
- traffic accidents caused by bins rolling into the road, and
- excessive weight of a loaded bin.

Community metal bins have been successfully used in part of the City of San José, Uruguay. The city placed about 200 2-m³ metal bins every 100 m. The bins were emptied by means of a front-end loader.

F7. CONCLUSIONS regarding communal waste containers

In most situations, particularly in tropical regions, the collection frequency should be often, i.e., daily or several times per week. In addition, every type of communal container should be thoroughly cleaned from time to time and covered if at all possible in order to provide the

greatest degree of health and safety to the public, and of protection to the environment. Systems that do not permit thorough cleansing, such as storage in concrete pipes, should not be adopted.

A review of the methods described in the preceding sections indicates that waste managers in developing countries have, thus far, been unable to arrive at a complete solution to the problem of communal storage. Of all the methods considered, only the 200-L steel drum is inexpensive to install and maintain, offers low collection cost, and provides a tolerable level of health protection to residents and workers. The risk of injury to the workers due to lifting may be overcome by cutting off the top half of the drum. However, the cut edge represents a different type of injury risk. Despite the benefits, the manner in which the drums are normally used for waste storage in developing countries results in rusting and dented drums, a visually unsatisfactory condition that is oftentimes scorned by residents and governmental authorities alike.

F8. CAPACITY margins

The design and selection of containers requires that an allowance be made for a margin of capacity over the average rate of waste generation. This allowance is necessary because the cycle of production varies from day to day. For example, holidays and short periods after them usually give rise to significant surges in waste generation.

When the collection service is provided on a daily basis, it is advisable to allow up to 50% excess capacity above the average generation rate in order to keep containers from overflowing. If the collection service operates only six days/wk, at least 100% over-capacity is necessary in order to contain two days of waste production.

In the case of communal containers, it may be prudent to provide a minimum of 100% margin even for daily service. Such a policy is particularly helpful where 200-L drums are used, because the average drum would then be only partially filled prior to collection. The excess capacity also reduces exposure of the wastes to view or to scavengers.

G. Collection vehicles

The collection of refuse involves all of the steps necessary for transferring the solid wastes from the storage point to the place of treatment or disposal. The process involves emptying the storage container into a vehicle in which the wastes are transported. The collection service may be designed in different ways and can use several transport methods. Transportation methods range from handcarts to 30-Mg vehicles. Solid waste collection is a very costly service and traditionally has been the most expensive phase of waste management. Every jurisdiction should carefully evaluate types of vehicles and collection methods in order to select the system that is most appropriate to local conditions in terms of quality and efficiency of service and cost of operation.

Local conditions vary widely; for example, 1 Mg of municipal wastes in Latin America may occupy a volume of 1 to 2 m³. On the other hand, 1 Mg of municipal wastes from the United States may occupy a volume of 8 m³. Daily collection in many developing countries involves a volume-to-dwelling ratio of less than 8 L. Typical weekly collection in the United States requires the removal of more than 100 L/dwelling. Wages in the United States are so high that it generally costs more to employ a worker than to operate a compactor vehicle, including amortisation but excluding driver labour. In most countries in Asia and Latin America, the cost of operating a simple 5-Mg collection vehicle may be 10 to 15 times higher than the cost of employing one person. For these reasons (and others previously mentioned), vehicles and systems used in industrialised countries may be entirely inappropriate for use in a developing country.

The work performed by a refuse collection vehicle can be divided into two main phases. The first phase, while the vehicle is stationary during loading of waste, represents lost time for the prime mover. The second phase, which is spent travelling at normal road speed with a full load, represents efficient use of the prime mover. Thus, to achieve maximum productivity in terms of load transported per unit of distance (Mg/km), the loading time must be kept to a minimum. If the collection unit can be divided into the two parts (the prime mover and the body), loading time can be eliminated by providing an extra body that can be loaded while the other one is transported to the disposal site. If the prime mover can be used solely for the transport of full trailers loaded in its absence, it will be fully employed in travelling. In suitable conditions, it is possible to transport two or three times the weight per day that could be achieved by a conventional vehicle. Those conditions can be: at large sources, such as markets, where a trailer can be sited permanently and used as the container for the market; and in areas where the wastes from multiple small sources, such as dwellings, are collected by other means, such as handcarts, and brought to the trailer.

This chapter presents a partial listing of various types of refuse collection vehicles. At the present time, most of the vehicles manufactured for waste collection are designed for conditions prevalent in industrialised countries. In particular, the designs are based on low-density wastes (i.e., about 130 to 190 kg/m³), which must be compacted 4 to 1 in order to achieve a reasonable payload. In order to meet the conditions of developing countries, the listing includes many types of vehicles not used in industrialised countries. Some of these vehicles were used in the United States and in Europe several decades ago, but are no longer manufactured. The designs of these vehicles do, however, represent a period when some industrialised countries had wastes of high density (similar to those currently generated in some developing countries) and when mechanisation was of lesser importance. Some of the designs discussed herein may be relevant to the needs of developing countries. The following goals are applicable to collection vehicles of all types:

- The load of waste should be thoroughly covered during transport; this is particularly important for motor vehicles travelling at 30 km/hr or more.
- The loading height of vehicles receiving the contents of containers emptied manually should not exceed 1.6 m.
- The body of a vehicle should have power-operated or hand-operated tipping gear, or a power-operated ejection plate, unless the load of waste is carried in portable containers.
- If the vehicles used for primary collection are handcarts or those drawn by an animal, the vehicles should receive the same standards of mechanical design as motor vehicles, including the use of bearings for the wheels, and rubber or pneumatic tires.

G1. HANDCARTS

Handcarts are almost universally used in developing countries for street sweeping because they cause minimum obstruction to traffic and their capacity is sufficient to keep a sweeper busy for up to two hours. Handcarts, as shown in Figure IV-9, also are used in developing countries for daily house-to-house collection -- in particular, collection along very narrow streets that are inaccessible to motor vehicles. Typically, the handcarts have open boxes that are attached to the frame, which means that the only way of transferring the contents to a larger vehicle is to discharge the wastes on the ground and use a shovel or a basket for reloading, as shown in Figure IV-10. This procedure, of course, is a wasteful use of labour and increases vehicle idling time.

Thus, one of the more important design features of a cart is to ensure that the load is carried in one or several containers that can be lifted off the cart and emptied directly into a larger vehicle. This requirement can be met by building the cart in the form of a light framework of tubular steel or angle with a platform on which four or six 70-L bins can be carried. For instance, in Mexico, handcarts are used that are comprised of a platform, supported by four small wheels and carrying one or two 200-L metal drums (see Figure IV-11). As previously mentioned, a problem with containers of this type and capacity is that two men are needed to safely empty the loaded drums into a vehicle.



Courtesy: CalRecovery, Inc.

Figure IV-9. Handcart with box body



Courtesy: CalRecovery, Inc.

Figure IV-10. Emptying of wastes from handcart for reloading into larger collection vehicle



Courtesy: CalRecovery, Inc.

Figure IV-11. One-bin handcart (100- to 200-L capacity)

For the daily collection of refuse from house to house, one 6-bin handcart load, such as that shown in Figure IV-12, would be sufficient for about 50 dwellings (8 L/dwelling/day). One collector would be able to serve between 200 and 300 dwellings/day. At a density of 500 kg/m^3 , the net weight per load would be about 200 kg. This is well within the capacity of the average collection worker to push, provided that the wheels and bearings are of good design. The typical radius of operation of a handcart is about 1 km and, thus, frequent transfer points must be provided.

G2. PEDAL tricycles

Pedal tricycles equipped with a box carrier in front, commonly used in Latin America and in Asia, can be adapted to carry wastes. Unfortunately, their volumetric capacity is less than that of a handcart. Pedal tricycles reduce travelling time and can, therefore, operate over a larger radius than a handcart. Refuse collectors can serve about 200 dwellings/day using tricycles. Productivities on the order of 0.5 to 0.9 Mg/ worker/day have been achieved in paved, residential areas in Lima, Peru. A modified pedal tricycle used for the collection of non-pathogenic wastes in a hospital in Bangladesh is shown in Figure IV-13.

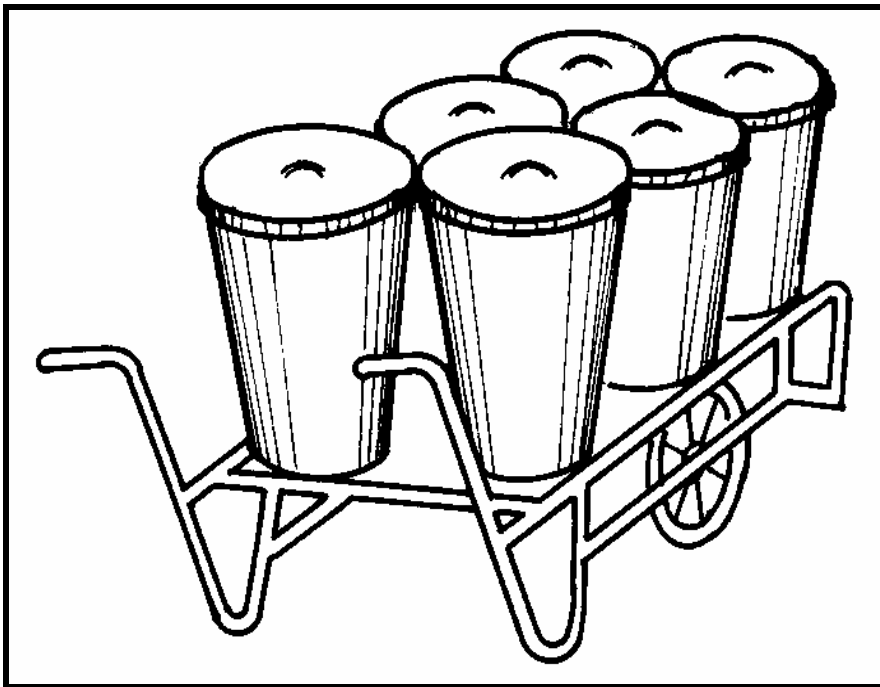

Figure IV-12. Six-bin handcart (300- to 500-L capacity)



Courtesy: CalRecovery, Inc.

Figure IV-13. Modified pedal tricycle used for waste collection

G3. ANIMAL carts

Horses were widely used in North America and in Europe for door-to-door refuse collection up until World War II. Horses, mules, donkeys, and other animals are used for waste collection in several countries around the world. A typical cart is shown in Figure IV-14. The capacity of draught animal carts generally ranges between 2 and 4 m³. In some cases, the carts are equipped with bodies that can be tipped, by either pivoting the body or by using a manually-operated worm and nut mechanism. Animal carts have the following advantages: no consumption of fossil fuels, very low capital and operational cost compared with motor vehicles, and very quiet operation.



Courtesy: CalRecovery, Inc.

Figure IV-14. Typical animal cart used for waste collection

The low speed of animal carts limits their effective radius of operation to about 3 km. In streets with heavy traffic, animal carts may interfere with motorised traffic. Animal carts can and do operate in conjunction with a two-level transfer station in which they tip their loads directly into a large motor vehicle. Some cities in Asia have successfully operated this system and have taken advantage of both methods of transport: animal carts for the slow “stop-and-go” portion of the operation and motor vehicles for “high-speed” transport from the collection point to the distant final disposal site.

However, despite their popularity, more attention needs to be paid to the design of the carts. Ideally, animal carts should have bodies fabricated from steel and mounted on pneumatic tires. The carts should be low-loading, fitted with sliding shutters, and equipped with manually-operated tipping gear.

G4. MOTORISED tricycles

The two-stroke, three-wheel motorcycle is a very common means of transportation in several developing countries and is a viable alternative for waste collection. A sketch of a motorised tricycle is shown in Figure IV-15. The tricycle can be fitted with a high-level tipping body of

about 2 m³ capacity while retaining a low-loading line. The motorised tricycle is in common use in several cities in Asia, particularly in the old sections of the cities where the streets are too narrow to allow passage of larger vehicles. Its relatively high speed gives this system an operating radius of about 10 km. However, the tricycle does not operate well on rough, unpaved roads such as those in marginal areas or those that typically lead to disposal sites. If the road system to the disposal site is inadequate, tricycles should discharge at either transfer facilities or processing plants.



Figure IV-15. Light motorised tricycle (about 2 m³ capacity)

G5. TRACTOR and trailer systems

The agricultural tractor is one of the most utilised motor vehicles for collecting waste in economically developing countries. A tractor has several advantages over other types of motorised vehicles. Some of these advantages include: relatively low capital cost, capacity to transport a large load relative to energy use, readily available maintenance facilities, manoeuvrability on a landfill due to large tires and high torque, and ability to use the power take-off to operate hydraulic tipping gear on a trailer. Despite its relatively low road speed (about 20 km/hr), tractors offer one of the least expensive methods of motor transport of solid wastes, up to a trailer capacity of about 6 m³.

There are a number of types of agricultural tractor-trailer systems: mini-agricultural tractors or jeeps can be used with shuttered side-loading trailers up to 4 m³; full-size agricultural tractors can be used with trailers up to 6 m³; and articulated semi-trailers are available with capacities up to 30 Mg for long-distance transfer. An example of a tractor-trailer system is presented in Figure IV-16.

The agricultural tractor with trailer often is used as a single unit for the collection of refuse from houses or communal storage points. This combination also has substantial potential as a transfer unit because of the ease with which the tractor can be separated from the trailer.



Courtesy: Alternativa

Figure IV-16. Agricultural tractor with trailer

G6. LIGHT commercial trucks

This type of vehicle is available almost worldwide. It is primarily designed for the transport of construction materials. However, it is also widely used for the collection of wastes from communal sites. The body of the truck is usually made of steel, with a flat platform equipped with hinged sides and tail-boards about 40 to 60 cm high. The volume of the truck is usually about 5 to 6 m³ and is suitable to carry high-density materials such as bricks and aggregates. One of the major disadvantages of the vehicle in its standard form is that it is rarely able to carry its rated payload of solid wastes. Even high-density wastes piled on the vehicle would be unlikely to exceed 4 Mg. It is, therefore, common practice to extend the height of the sideboards in order to increase the volumetric capacity. This practice, however, makes it necessary to either use ladders to load the vehicle or to place workers inside the body to receive containers handed up to them by collectors.

The advantages of this type of truck are the following: it is relatively inexpensive, it is sturdy and easily obtainable, it has good ground clearance, and it performs well on rough roads.

In applications involving the collection of solid wastes, the truck should have a carrying capacity of at least 2 m³/Mg. In addition, the loading height should not exceed 1.6 m.

There are some modifications that can be made to a conventional light commercial truck that enable these requirements to be met without complex mechanisation of the body. Some of these modifications include:

- Reduction in the height of the chassis by using wheels of a diameter smaller than standard. This change, however, would result in the reduction of both the maximum permissible load and ground clearance.

- Use of full forward control (cab-over engine) to increase space on the chassis for the body.
- Extension of rear overhang.
- Use of a long wheelbase.

The application of these design modifications allows the use of an enclosed body. The body could have a capacity of about 8 m³ without exceeding the desired loading height of 1.6 m. The most common type of body having these design features is the side-loader. The side-loader has three or four loading apertures along each side. The apertures can be closed by means of sliding shutters. The shutters are usually plain sheets of metal running in grooves. The load can be distributed within the body by the use of rakes. During the final stages of loading, the waste can be piled against closed shutters along one side. Because of the potential difficulty of unloading, it is advisable to equip these vehicles with hydraulic tipping gear.

G7. FORE and aft tipper

This design appeared in the mid-1930s and was used in Europe until about ten years ago. Its distinguishing feature is that the body can be tipped two ways: toward the front of the body during the loading process and toward the rear for unloading. This relatively simple mechanism achieves a result similar to the hydraulic ram at the rear of a compactor vehicle. However, the compression effect is much lower than that obtainable with the compaction unit. The forward tipping operation may be required about 12 times per load. A suspended barrier inside the body prevents the wastes from falling back after tipping. This type of vehicle utilises body capacities of about 12 m³.

This design approximates that of a compactor and is suitable for densities from 250 kg/m³ and upward. The vehicle can be built on a standard chassis with normal wheel diameter, and presents few maintenance problems. A schematic diagram of the fore and aft tipper is shown in Figure IV-17.

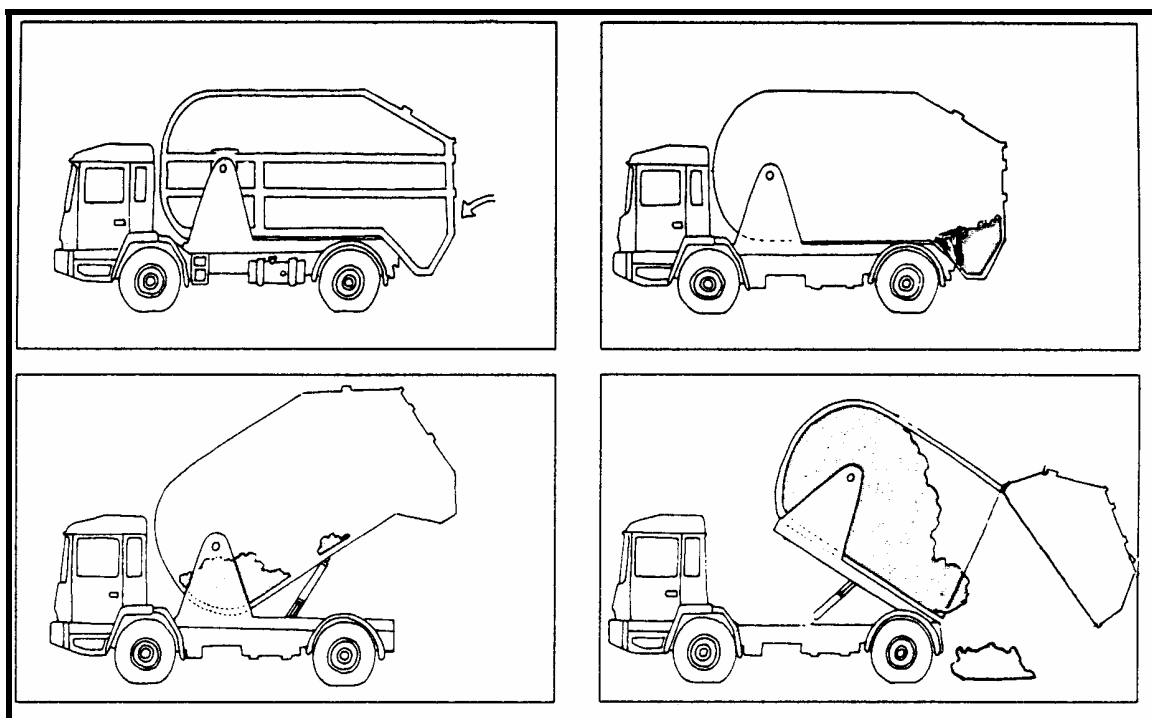

Source: Reference 8.

Figure IV-17. Schematic diagram of fore and aft tipper

G8. CONTAINER-HOIST

This unit utilises a standard commercial chassis (in the range of 5 to 10 Mg) equipped with two hydraulically-operated lifting arms. The arms are used to lift metallic containers on or off the floor of the vehicle. The containers have a capacity of 3 m³ or more. The containers can be tipped to discharge their contents while in position on the vehicle.

The container-hoist is a viable alternative to tractor-trailer units; it is cheaper, faster, and less liable to be damaged by vandalism than the tractor-trailer units. On the other hand, the cost of a container vehicle is about twice that of an agricultural tractor and in many cases the container transports a considerably smaller load than that possible using a tractor-trailer.

The main reason for the relatively low payload appears to be that the container vehicles are manufactured to collect and transport wastes that have a relatively high bulk density. It is not advisable that developing countries implement container systems based on capacities on the order of 3 to 4 m³.

G9. VEHICLE standardisation

In the conduct of several projects throughout Asia, Africa, Latin America, and the Caribbean, the authors have observed that a large number of countries have mixed vehicle fleets and extremely low vehicle serviceability. In fact, in extreme situations, the authors have observed municipalities that own and operate vehicles that require metric tools and vehicles that require English tools. In some instances, the serviceability is as low as 50% to 60%. These two factors may be related to one another. If many different models of vehicles or vehicles of different manufacturers compose the collection fleet, it is extremely difficult (and costly) to maintain an adequate stock of spare parts. Consequently, vehicles may be off the road for long periods of time while replacement parts are purchased and delivered, sometimes through a centralised purchasing organisation. In fact, it is very common in developing countries to see a large number of vehicles broken down and used as sources of spare parts. The use of a centralised purchasing organisation may cause additional delay by requiring competitive bidding for even minor items.

Inventory control can be simplified and availability of spare parts improved by standardising the fleet. Furthermore, major spare items (engines, transmissions, axles, and hydraulics) can be kept in stock. These spare items are used to replace defective parts in a vehicle, which can then be put into service within a few hours. The items that have been removed can subsequently be repaired at leisure.

Standardisation, however, does not imply that the same type of vehicle should provide service to every area in a community. As mentioned previously, low-income areas may require different types of vehicles.

Compactor vehicles are not considered in this chapter for the following reasons:

- Compaction ratios achieved with wastes from industrialised countries (with initial densities in the range of 130 to 190 kg/m³) vary from 2:1 to 4:1, the final density in the vehicle being about 400 to 550 kg/m³. Wastes in most developing countries have an initial density similar to that of compacted industrialised wastes.
- The compaction mechanism imposes a need for additional maintenance facilities that may not be readily available in some cities.

- Compactor vehicles usually need to be imported, which may lead to problems in foreign exchange and acquisition of spare parts.
- The compaction mechanism substantially increases fuel consumption.
- The capital cost of a compactor vehicle is significantly greater than that of a conventional truck.

H. Access and point of collection

Thus far, the two main elements of a refuse collection system have been considered: storage and collection. These elements are linked at the collection point. The location of the collection point is conditioned by several factors. Some of these factors include: physical characteristics of the buildings, access to the buildings and width of roads, and the share of the work of refuse collection carried out by the householder.

The system for storing solid wastes and the provision of access to the storage point for refuse collectors must be given careful consideration at the design stage of any building. In some countries, city planning and building regulations deal with waste storage and often require that plans for all new buildings be submitted for approval to the department responsible for solid waste services. However, in most countries there has been little, if any, regulation of this type, and every city contains several structures for which it is very difficult to devise a satisfactory storage and collection method. In this section, we review the main problems associated with access to the points for refuse collection. Standards for building construction have an impact on frequency of collection, vehicle type and size, and the number and type of duties that have to be imposed upon the householder.

H1. DETACHED dwellings

Detached dwellings are ideal units for the storage and collection of wastes. The container can be kept outside the house, in the open air. Collection frequency is not critical if the container is impervious and has a lid. Under these conditions, a collection frequency of once or twice weekly would be adequate.

Unless there are compelling financial reasons or resource recovery (recycling) goals, it is unnecessary to impose duties on the householder, other than to require him or her to carry the storage container to a designated collection location. The collector can enter the backyard or garden, carry out the container, empty it, and return it to its normal position. This activity, as opposed to collection at the roadway, increases the time and, therefore, the overall cost of the collection process.

It is essential for tropical countries to have a frequency of collection that takes into account the composition of the wastes, the rate of decomposition of putrescible matter, and the type of storage container. It seems to be generally assumed that the collection frequency of once or twice per week, which is widely used in the United States and in Europe, is due to the temperate climate. However, some portions of these countries also have very hot and humid climates. Therefore, it is arguable that the low collection frequency in the United States and Europe is acceptable also because of the high standards of solid waste storage, which prevent odour emission and access by insects and other animals. Thus, in terms of minimising collection frequency and costs, one of the more important problems for some developing countries is that of attaining nuisance-free waste storage. In those cases where the wastes are not or cannot be properly stored, collection frequency in the range of daily to three times per week may be required to minimise nuisances, to protect the public health and safety, and to protect the environment.

Separate dwellings can range in size from a small cottage to a luxurious villa. In most cases, there is flexibility regarding the types of collection methods that are technically feasible. However, cost is likely to be the main criterion in the selection of vehicles and methods.

H2. MULTI-FAMILY dwellings

Generally, apartments have only one entrance. In this situation, it is possible to provide door-to-door service to each residence. Collectors have been observed to carry large, strong plastic sacks or large, light bins for waste collection into apartment buildings. The collector goes to the door of each apartment, knocks, and waits until the waste is brought out. The waste is then emptied into the collector's container. The container generally is large enough to contain the wastes from several apartments. This process reduces the number of trips that the collector must make to the vehicle.

In some locations, multi-story apartment buildings have balconies at the rear that can be reached by an external staircase. In these circumstances, a full collection service is possible if the solid waste storage container is kept on the rear balcony.

Alternatives for the collection of wastes from multi-family dwellings include either a series of small bins or a large container for communal use. In either case, the frequency of collection from apartment buildings should be daily or every other day because of the limited storage space in the apartments and the likelihood that communal storage may be improperly operated.

H3. SINGLE-ROOM dwellings

It is relatively common that in the very poor areas of many large cities, a single room may be used for cooking, eating, and sleeping. This room may be part of a large dwelling unit, or one of a large group of temporary or permanent shacks. In both situations, the storage of wastes on the premises for more than a few hours is obviously a problem.

In the absence of any private space where a waste container can be kept, public space must be made available. Thus, in these conditions, the most feasible alternative is the provision of communal containers in the streets. The container kept in the dwelling unit should be emptied on a daily basis.

A system of small communal containers spaced not more than 100 m apart is better than a system where large containers are located at greater intervals. Closely spaced containers are more likely to be used. Ideally, communal containers should be placed on paved streets that are sufficiently wide for accommodating a motor vehicle. Small containers, on the other hand, can be moved on hand trolleys to the nearest road.

H4. MARKETS

Most, if not all, cities in developing countries have at least one central market. The size of the market generally is a function of the size of the city. In some cases, one market attracts people from several kilometres away. The market typically has a large number of stalls placed closely together. The stalls face narrow passages that are usually thronged with pedestrians and littered with wastes. Generally, sweepers bring the wastes from the passages to a central storage point, which typically is a large pile on the ground. From time to time, a waste collection crew and vehicle collects and disposes the piles of waste.

In some of the modern markets, every stall is provided with a waste bin of about 50 to 70 L. The stalls are serviced by a sweeper with a cart who exchanges empty bins for full ones, and then empties the bins into a large container stationed in an area immediately adjacent to the market.

A high percentage of the wastes generated in markets is organic and readily biodegradable.

H5. ACCESS for trailer or container exchange

Several types of sources usually generate sufficient quantities of wastes to justify the use of a trailer or a large container for central storage of wastes. Some of these sources include: hospitals (not pathological waste), hotels, factories, office complexes, and some apartment buildings.

The layout and the location of the storage areas need careful planning in order to service the full trailer or container with minimum effort and to avoid interfering with traffic flow. Some of the key factors that should be considered include: the site should be located on an internal road of the source's premises in order to avoid the need for complex vehicle manoeuvres on a main thoroughfare, and the site should have extra space in which the empty trailer or container can be placed. In order to facilitate the collection process, a straight-through approach to the trailer or container location is an advantage.

H6. NARROW paths/alleys

Several countries have very old city centres and marginal areas where paths are too narrow to allow access by motor vehicles. This has been one of the main reasons for the continuing use of large communal sites in developing countries.

Narrow alleys, sometimes only a meter wide, are also a characteristic of marginal (slum) areas. Their inaccessibility to conventional collection methods has sometimes caused such areas to be entirely denied collection services, with the consequence that wastes are disposed in ditches, canals, and rivers.

Daily collection from these areas, where population density is very high, is essential not only for the protection of the immediate population, but also out of concern for the health of the community as a whole.

The use of manually operated carts is one obvious solution to the access problem. The carts can be used for door-to-door service, or for servicing small communal containers. Sometimes, however, such communities are established on steep hillsides, such as the one shown in Figure IV-18. Collection of waste on steep inclines may be accommodated by the use of animals of burden (mules, donkeys, llamas) equipped with containers in which the wastes can be carried.

I. Basic collection systems

Essentially, there are four basic collection systems, depending upon the level of effort required on the part of the generator. The types of systems are: communal, block, kerbside, and door-to-door. Communal storage and collection may require delivery of the wastes by the generator over some distance. In block collection, the generator delivers the wastes to the vehicle at the time of collection. In kerbside collection, the generator sets out the full container and later retrieves it. In door-to-door collection, the collector enters the premises, and the generator basically is not involved in the collection process. A description of each one of these systems is presented in the following paragraphs.

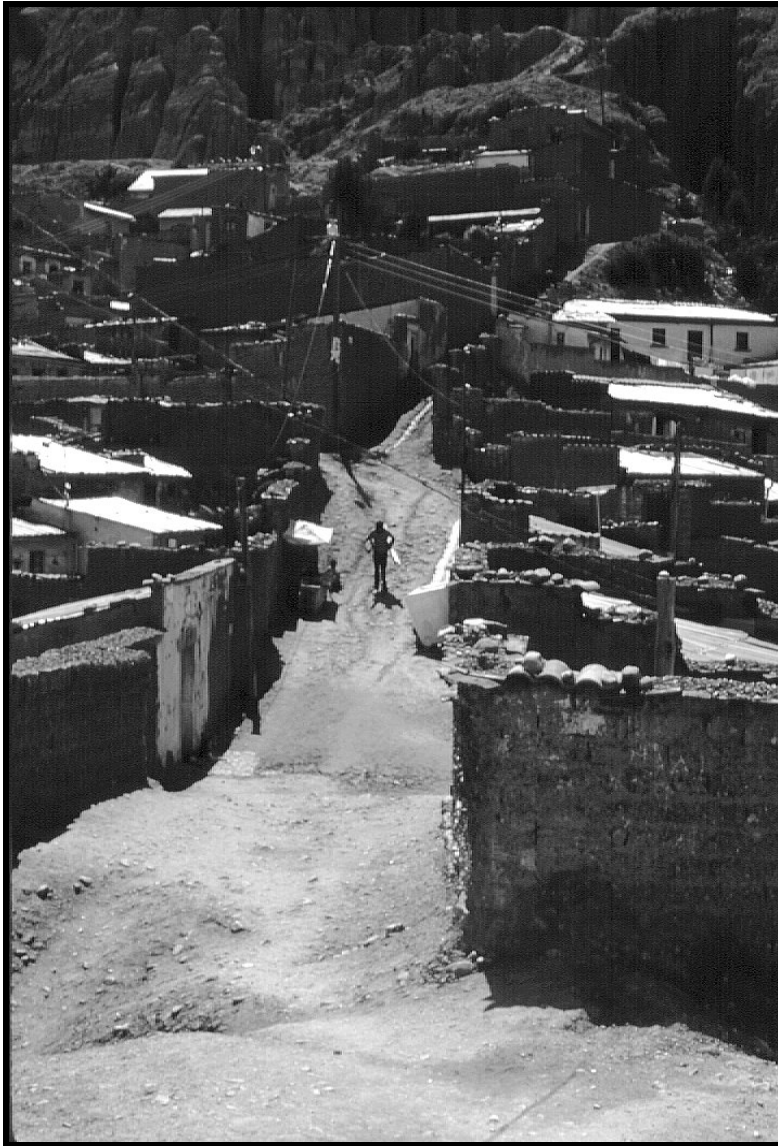

Courtesy: CalRecovery, Inc.

Figure IV-18. Human settlement located on steep terrain

II. COMMUNAL collection

The planning and organisation of refuse collection is greatly simplified by the use of large communal storage sites. Although the use of large communal sites may seem to be a fairly inexpensive and simple solution, it may transfer much of the burden of refuse collection onto the street cleaning service and actually increase total costs. It is less expensive to collect refuse directly from a residence or business than to sweep it up from the streets.

The use of large, widely spaced communal storage sites generally fails because the demand placed on the generator goes beyond his willingness to cooperate. If communal storage sites are going to be used, the storage points should be at intervals convenient to the generators.

Large masonry enclosures, as well as small concrete bins, are inefficient in the use of labor and vehicles. As previously indicated, wastes have to be manually removed from these types of containers by rake or shovel and basket. This is a relatively slow process and vehicle waiting time during the loading process is excessively non-productive. In addition, the idle collection vehicles impede other traffic in the street. The following performances have been recorded: 1.4 Mg/worker/day and 7 Mg/vehicle/day for masonry enclosures, and 1.2 Mg/worker/day and 6

Mg/vehicle/day for concrete pipes. Drums having a capacity of 200 L are not an ideal solution; however, two workers can generally empty them into vehicles with a low load line. The use of 200-L drums increases collection performance to about 5 Mg/worker/day and 10 Mg/vehicle/day.

I2. BLOCK collection

In this system, a collection vehicle travels a regular route at a frequency of two to three times per week. The vehicle stops at all street intersections, and a bell is rung. At this signal, the residents of all the streets leading from that intersection bring their containers of waste to the vehicle and hand them to the crew to be emptied. Typically, a driver and a crew of two are sufficient for this type of system since they do not need to leave the vehicle to perform collection of the waste.

Block collection should be operated frequently; otherwise, the quantity of wastes to be carried to the vehicle may require more than one trip or may be beyond the carrying capacity of some of the residents. This method of collection has a significant advantage over kerbside collection since the containers are not left out on the street for long periods of time while awaiting the arrival of the collection vehicle.

Block collection is operated in some cities in Latin America. The results of a study carried out in Mexico City indicated that it took about 2.5 hr to service approximately 840 dwellings. The route was 2.7 km long, and each dwelling delivered about 4.3 kg. The performance achieved by this system was about 3.5 Mg/worker/day and 7.0 Mg/vehicle/day [4].

I3. KERBSIDE collection

This system of collection requires a regular frequency and a fairly precise schedule, for optimal efficiency and convenience. Residents must place their containers on the curb before the time of collection and remove the containers after they have been emptied. It is important that the containers be of a standard type. If standard containers are not used, it is likely that wastes will be set out in any type of container such as baskets or cardboard boxes, or even in piles. Under these conditions, the wastes may be scattered by animals and wind, thus making the collection process very inefficient. In developing countries, kerbside collection is not entirely satisfactory. Some of the problems associated with kerbside collection include: the contents of the containers may be sorted by scavengers; and the containers may either be stolen, overturned by animals, or left on the street for long periods of time.

However, kerbside collection is unavoidable for collection of waste from some types of structures, and it is one of the least expensive methods of house-to-house collection. A high labour productivity can be achieved when the rate of waste generation is high and collection infrequent. For example, in one city in the United States, a one-person crew collects up to 10 Mg/day (400 dwellings at an average of 25 kg/dwelling). In most economically developing countries, however, the rate would be lower since the average quantity of waste collected per dwelling is much less than in the United States.

I4. DOOR-TO-DOOR collection

In this system, the householder does not participate in the collection process. The collector enters the premises (backyard or garden), carries the container to the vehicle, empties it, and returns it to its usual place. This system is costly in terms of labour because of the high proportion of time spent walking in and out of premises and from one dwelling to the next. However, in some situations, it is the only satisfactory system.

The main difficulty with door-to-door waste collection in developing countries is that vehicle productivity would be less than that in Europe or the United States if the collection frequency were high. Since one of the main objectives in developing countries is to achieve high vehicle productivity, door-to-door collection by the conventional western method of heavy reliance on motor vehicle and crew is very unlikely to be a viable system unless the collection frequency is about once a week. This may not be feasible in countries with tropical climates unless high standards of waste containment at the place of generation are practiced and enforced.

15. EVALUATION of basic systems

The evaluation of collection systems involves a number of considerations. One of the more important considerations is the average population or number of dwellings serviced per collection vehicle. If the productivity is examined on the basis of population served, the values around the world exhibit a wide range, about 3,000 to 20,000 persons served per collection vehicle, as shown by the data in Table IV-2. Many factors, as described in this chapter, govern vehicle productivity.

Table IV-2. Collection vehicle efficiency

Location	Population Served per Vehicle
Nigeria	20,000
Norway	5,000
Spain	8,000 to 10,000
Tunisia	6,000
Turkey	5,000 to 12,000
Latin America	7,000 to 10,000
Western Pacific Islands	8,000 to 14,000
United States	3,000 to 5,000

Sources: Reference 7 and CalRecovery, Inc.

An example of an evaluation of collection productivity is demonstrated by the presentation of the data in Table IV-3. The table presents a comparison of productivity for both labour and equipment for various types of collection systems in terms of weight collected (kg/day). In this particular case, the weight generated per dwelling is assumed to be 2 kg/day. This generation rate is equivalent to about 330 g/person/day for a family of six.

Table IV-3. Productivity evaluation of basic collection systems^a

Method	Productivity						
	Frequency	Quantity/ Point (kg)	No. of Crew	No. of Dwellings		Quantity (kg)	
				Worker/ Day	Vehicle/ Day	Worker/ Day	Vehicle/ Day ^b
Door-to door	once/day	2	6	160	960	300	2,000
Door-to-door	every 4 days	7	6	140	840	1,000	6,000
Door-to-door	once/wk	14	6	120	720	1,700	10,000
Kerbside	once/day	2	4	300	1,200	600	2,400
Kerbside	every 4 days	7	4	250	1,000	1,800	7,000
Kerbside	once/wk	14	4	200	800	2,800	11,000
Block	every 2 days	4 ^c	2	850	1,700	3,500	7,000
Communal enclosures	once/day	3,000	5	700	3,500	1,400	7,000
Communal concrete bins	once/day	300	5	600	3,000	1,200	6,000
Communal 200-L drums	once/day	50	2	2,500	5,000	5,000	10,000

^a Based on waste generation of 2 kg/dwelling.

^b Rounded to nearest 500 kg.

^c Per dwelling.

The data in Table IV-3 indicate that, in general, under similar circumstances: 1) communal storage systems based on portable containers would probably offer the highest productivity, 2) block collection at two-day intervals offers moderate productivity and avoids the problems that arise with communal storage or kerbside collection, and 3) door-to-door collection by a motor vehicle and a large crew may be the least productive system for a developing country if daily service is required. This system may be acceptable in selected areas if a frequency of twice per week is feasible and adopted.

J. Primary and secondary collection

J1. SHORT-HAUL transfer

Short-haul transfer is a system that divides refuse collection into two phases, primary and secondary.

J1.1. Primary collection by handcart

Primary collection (from door to door) is carried out using a small non-motorised vehicle, such as a handcart or animal cart. When full, the primary collection container is emptied directly into a large motor vehicle that is utilised solely for the high-speed transport of full loads. A unit that works well in developing countries is one that uses between two and six detachable bins. Carts of this design were used in some cities in Europe in the late 1940s for the collection of kitchen wastes for processing into animal feed.

J1.2. Secondary collection by tractor-trailer

The performance of this system can be evaluated by assuming that trailers have a capacity of 6 m³ and that they are exchanged when full by an agricultural tractor. The tractor then takes the trailers to the disposal site. A tractor can travel at an average speed of 15 km/hr.

The number of trailers required for this type of service depends primarily upon population density. One trailer exchanged 6 times/day could support 40 collectors, serving a population of about 45,000. However, because of the limited operating range of a handcart, this 40-man unit must be kept within an area of about 1 km². Thus, in this example, if the population density is lower than 45,000 people/km², it is likely that more than one trailer transfer point will be required. Two transfer points, each having a trailer exchanged 3 times/day, would enable the tractor and 40 collectors to cover an area of 2 km², with a population density of 21,500 people/km².

In the first case, the theoretical trailer requirement would be two per tractor, one stationary (at the transfer point), and the other being towed. In the second case, the number of trailers would be three per tractor. One tractor would be located at each of the two transfer points and one would be towed. In practice, it usually is necessary to provide surge capacity at a transfer point, since the rates of handcart collection and trailer exchange are not continuously in balance. The number of trailers should be determined as follows: 1) optimum population density, 3 trailers/tractor, 2 at each transfer point; or 2) half optimum population density, 5 trailers/tractor, 2 at each transfer point.

The minimum population density for which handcarts could reasonably be used is on the order of 7,000 people/km². Each square kilometre would require six collectors and one trailer per transfer point. Surge capacity would not be necessary and, thus, the ratio of trailers to tractors would be 7:1 -- 6 trailers at transfer points and 1 being towed.

In general, the use of short-range transfer based on handcarts is applicable to the following conditions: low per capita generation of wastes, high-density wastes, high population density, and low wage rates. In situations where one or more of these conditions are absent, the principle of transfer may still be valid, but it may be necessary to employ vehicles of larger capacity.

J1.3. Primary collection by animal cart or motorised tricycle

The basic assumptions for evaluating the performance of these systems are given in Table IV-4. The data show that the productivity of a motorised tricycle is higher than that of an animal cart.

Table IV-4. Collection by animal cart or motorised tricycle^a

Alternative	Average Speed (km/hr)	Travel Time (min)	Total Time/Load	Quantity (kg/day)	Productivity	
					Weight (kg/worker/day)	Dwellings (No./worker/day)
Animal cart	3	40	5 hr, 12 min	875	437	219
Motorised tricycle	20	6	4 hr, 38 min	1,050	525	262

^a Vehicle capacity is 700 kg (350 dwellings).
Time/load, 2 crew at 40 dwellings/worker/hr is 4 hr, 22 min.
Distance is 2 km; time to unload is 10 min.

J1.4. Secondary collection from transfer station

The main advantage provided by the use of animal carts or small, motorised vehicles in a solid waste management system is a wider range of operation than handcarts. The use of an animal cart is just as slow as that of a handcart, but the volumetric capacity of the vehicle is so much greater than that of the handcart that only two trips to transfer would be necessary, instead of four or

more with a handcart. Thus, the animal cart would spend a higher proportion of the day in productive collection. The small motor vehicle has both greater capacity and higher speed.

The use of animal carts and small, motorised vehicles, instead of handcarts, enables transfer stations to be much more widely spaced, and to serve greater populations or areas having low-density populations. For animal carts, one transfer station per 5 km² would give a round trip distance of about 2 km. A much larger area could be served by motorised tricycles.

The process of transferring waste from an animal cart or a small motorised collection vehicle into a transfer trailer is much more complex than a process that employs the use of small handcart containers. The reason is that the process involves the manual emptying of a substantial volume of waste from a relatively large container (at least 2 m³) into the transfer trailers.

J2. COMPARATIVE labour and vehicle productivity

The productivity of short-haul transfer equipment is presented in Table IV-5. It is important to point out that although the values in the table are based on actual experience, it is unlikely that the same values will be found in most situations, due to the wide variations that occur throughout the world in the determining factors. Some of the more important factors are:

- waste generation per capita and average family size,
- density of wastes at source,
- population density,
- labour rates,
- costs of animal carts and motor vehicles,
- fuel cost, and
- cost and availability of land for transfer stations.

Table IV-5. Productivity of short-haul transfer

Alternative	Productivity	
	Mg/Worker/Day	Mg/Vehicle/Day
Handcarts	0.40	14
Animal carts	0.44	25
Pedal tricycles	0.5 to 0.9	8 to 12
Motorised tricycles	0.53	25

J3. SHORT-HAUL transfer station facilities

Short-haul transfer stations fall into two main categories: 1) level sites, where transfer usually is carried out by manually emptying small containers of waste; and 2) split-level sites, where loads carried by small vehicles are unloaded directly into large vehicles by taking advantage of gravity.

Vehicles used for secondary collection at transfer stations fall into the following main groups:

- trailers (usually about 4 m³), towed by an agricultural tractor;

- semi-trailers having capacities of 15 m³ or greater;
- open-top vehicles with extended sides to provide capacities of at least 12 m³;
- containers of 8 m³ or greater capacity, carried by vehicles of 5-Mg capacity or more; and
- containers of 15 m³ or higher capacity, carried by roll-on vehicles.

J4. LEVEL sites

In its simplest form, this type of transfer station consists of a parking space onto which a trailer or truck is placed. However, it is desirable to enclose the space for reasons of aesthetics, cleanliness, and security. When handcarts or tricycles are used for primary collection, their contents can be discharged at a height of 1 m or more into larger containers.

J5. COMBINED transfer stations and district depots

There are many advantages in building a combined transfer station and depot in areas where a transfer station serves a population in the range of 20,000 to 50,000. For a population in this range, there would probably be between 40 and 150 labourers employed for refuse collection, street cleansing, and ancillary services.

If a district depot is included in the system design, it should provide the following facilities: 1) sanitary facilities for workers (i.e., lockers, toilets, showers); 2) shops equipped with basic items such as brooms, shovels, cleaning materials, lubricants, and similar items; 3) parking facilities for hand trucks for sweepers and, if appropriate, refuse collectors; and 4) an office for a supervisor.

K. Large-scale transfer stations

In developing countries, the cost of solid waste collection typically is a disproportionate percentage of the revenue available to municipalities. Although labour rates in developing countries are relatively low, the cost of equipment and the cost of fuel usually are higher than in industrialised countries.

As background for this section, typical ranges of costs of collection are tabulated in Table IV-6 for countries categorised by level of economic development. Also shown in the table are quantities of solid waste and certain unit parameters (i.e., per capita) that are relevant to understanding and comparing the costs of collection around the world. The inordinately high cost of solid waste collection in developing countries is attributable primarily to the following conditions:

- poor supervision, labour management, and training in solid waste management;
- non-productive staff;
- inadequate education and discipline of the citizenry;
- inappropriate type and size of collection equipment;
- incorrect crew size and inappropriate shift duration;
- harsh driving conditions at the disposal sites;
- lack of sufficient numbers and of appropriate types of storage containers at collection points;
- inadequate maintenance of equipment;
- long distances to disposal sites (i.e., lack of transfer stations); and
- lack of systematic collection routes.

Table IV-6. Waste generation and cost of waste collection in regions with different levels of economic development (2003)

Parameter	Low Income	Middle Income	High Income
Waste generation (kg/cap/day)	0.3	0.5	2.0
Collection cost (US\$/Mg)	15 to 40	25 to 75	75 to 150
Collection cost (US\$/cap/yr)	2 to 4	5 to 14	55 to 110
Income (US\$/cap/yr) ^a	500	3,000	25,000

^a Average income based on selected world development indicators in Reference 7.

The period of time involved in transporting solid wastes over long distances, combined with the lack of transfer stations, can have a significant negative impact on the total cost of collection. In situations where 30 minutes or more are required to haul waste from the terminal point of the collection route to the disposal site, the total cost of collection and haul can be on the order of 30% to 50% higher than that of a system that incorporates one or more transfer stations into the system.

Long distances to the disposal site and the absence of transfer stations can also lead to negative environmental impacts. If the disposal site is located a long distance away from the point of generation, the waste management system is subject to inefficiency and to undesirable or illegal disposal of wastes by those frustrated by the great distance to the disposal site, i.e., wastes will be dumped at locations closer to the point of generation because of convenience.

Typically, the justification for a transfer station is that it will result in a reduction in the total cost of collection and haul and that it will offer convenience to the service area(s), i.e., the nearby station can be used directly by private citizens and businesses as a disposal location instead of the less attractive alternative of driving to a remote disposal site. The savings in total cost are due primarily to the shortened haul distance from the collection area to the disposal site (since a transfer station has been substituted for the disposal site) and the fact that collection vehicles (as opposed to transfer vehicles) are not suited for, nor are they technically or financially efficient in, long-haul, high-speed applications. Also, in some cases an increase in payload per vehicle, in-vehicle waste density, or both can be realised since transfer vehicle volumetric capacities can be

several times that of collection vehicles and the wastes can be compacted at the transfer station using compaction equipment.

Despite the fact that the implementation of a transfer system offers potential cost savings over the long term, the system requires additional investments, such as the construction of a transfer station and materials handling equipment. The investment associated with these activities must be recovered, or monetary losses will be incurred as a consequence of the transfer operation.

The capital investments that are typically necessary to implement a transfer system include, but are not limited to: land, structures, utilities, and fixed and rolling equipment. In addition to the capital investments, the transfer system will have operational expenses, including maintenance, associated with the transfer station and also with the hauling of transferred waste to the disposal site.

In many developing countries, the prevalent situations for considering transfer stations are two. One situation is where a remote disposal site of large capacity exists, and the issue is whether or not the integration of a transfer station into the solid waste management system would result in lower overall collection and disposal costs. In this situation, the cost of the existing system of collection and haul is compared to that for the system modified to include a transfer station. The cost comparison is typically conducted on the basis of cost per unit weight of waste collected (e.g., US\$/Mg), where the unit cost is composed of amortised capital component and of operating expenses. Due to the relatively large capital expense of a transfer station and to the sensitivity of the unit cost to haul distance, the unit cost (i.e., US\$/Mg/km) of a transfer station operation is high when the hauling distance from the station to the disposal site is short. However, the unit cost decreases to an asymptotic (i.e., minimum) value as the distance between the transfer station and the disposal site increases. In the United States, the cost benefit of a transfer station is typically realised when the distance from the centroid of the wasteshed is in the range of 20 to 40 km from the disposal site. However, the reader is cautioned that a cost-benefit analysis of a transfer station in a developing country must be conducted using the local conditions, e.g., local labour rates, fuel prices, construction costs, etc., and must not use “rules of thumb” developed for different countries and circumstances.

The second situation regarding transfer stations that is relevant to developing countries concerns the siting of a new disposal facility and the use of a transfer station. Examples of this situation would be the use of a remote sanitary landfill to replace an open dump, or the need to use a remote disposal site because the existing and nearby site is reaching capacity. For either example, the boundary conditions listed below apply in many cases:

- The potential location of the transfer station is known with some degree of certainty.
- A level of acceptable solid waste collection service and of expense exists, and the siting of a new disposal facility requires the use a transfer station. However, the overall cost of the collection, haul, and disposal system cannot exceed the current cost of the waste management system.

For the analysis, the current (or future) cost of the existing collection and haul system is equated to the estimated cost of collection and haul for an alternative system that includes a transfer station. Haul distance serves as the key variable in determining the breakeven distance from the potential new transfer station to the remote disposal site. Several conditions must be specified in order to perform the analysis. They include the existing cost of collection and of haul, amortised capital cost, and operating cost of the new transfer station and hauling subsystem; the capacity and payload of the transfer vehicles; fuel usage and cost; driving speed; and quantities of waste

collected and hauled. The results of the analysis are particularly sensitive to labour rates, cost of fuel, and vehicle speed. The latter parameter (speed) is a function of road conditions, speed limits, and traffic conditions.

If a transfer station is constructed and operated as part of a solid waste management system, it opens up the possibility of establishing a combined transfer station/resource recovery facility. The main objective of the resource recovery portion of the facility would be to recover materials that would be used near the facility (i.e., recyclable materials, organic matter, RDF). Therefore, only those materials that have no market or use would have to be transferred for long haul and disposal. The implementation of a system of this type could lead to additional cost savings since less waste would ultimately be hauled from the transfer station to the disposal site than in the case of no recovery of resources. However, an added layer of analysis is required in order to determine the type and degree of appropriate processing, as well as the overall arrangement and the cost of the combined facility.

L. Transfer station planning and design

The primary technical considerations for a transfer system include: site selection, design of structures (e.g., building enclosures), and transfer operations and plant layout. A discussion of each follows.

L1. SITE selection

Ideally, a transfer station should be located such that unit cost is minimised as a function of travel time of the collection vehicle to the transfer station and time required for the transfer vehicle to travel from the transfer station to the disposal site. In a large service area, such as that in Mexico City, this analysis may result in the need and selection of multiple sites for waste transfer points. This type of analysis can be conducted by means of mathematical models. Operations research techniques can be used to determine the optimum number and location of transfer stations. In practice, only a limited number of sites will be feasible, due to a number of factors such as access, topography, cost, and environmental acceptability.

Experience, however, has demonstrated that the siting of any solid waste facility cannot depend solely on technical and economic analyses, but must include public participation in the selection process.

L2. DESIGN of structures

The types of structures used to house a waste transfer operation range from none at all (open-air) to large, enclosed concrete and metal buildings. Open-air transfer stations work well in rural areas with dry climates. Rural areas with wet weather can utilise a small shelter over the unloading area, loading area, or both.

Most transfer station buildings in developing countries are fabricated of sheet metal, concrete, or brick. The specific type of design and landscaping is a function of location, i.e., locally available materials, available financial resources, and local preferences.

Transfer station buildings typically are equipped with water sprays and/or systems for controlling air emissions such as dust, motor vehicle exhaust, and doors. The building should include offices and facilities for the workers, e.g., restrooms, showers, etc. Designs of transfer stations in the United States incorporate viewing areas so that public education and public relations' campaigns can be conducted from those areas.

The station should also be equipped with at least one truck scale for weighing inbound and outbound wastes. An inbound weigh scale is important for managing the operation and for levying disposal fees. Large, modern transfer stations also incorporate truck scales in the locations where the long-haul transfer vehicles are loaded. This design permits loading of the vehicles to their maximum allowable payloads, thus optimising the cost of transport of waste to the disposal site.

L3. TRANSFER operations and plant layout

The operation of a transfer station can be divided into the following phases: unloading, loading, transport, and discharge. The design concepts for transfer systems are described under each of the main phases.

L3.1. Unloading

This phase involves the unloading of collection vehicles and, if necessary, temporary storage of wastes. The following two basic alternatives can be utilised for the unloading phase: collection vehicles can either unload directly into containers, or into a storage area or pit. The wastes can then be loaded from the storage area into transfer vehicles, as described below.

L3.1.1 Direct unloading

A system that uses direct unloading involves the discharge of the wastes from the collection vehicles directly into transfer vehicles or the vehicle loading systems (e.g., compactors), i.e., the design does not incorporate a waste storage area as part of the system. Direct unloading requires a two-level arrangement. In this arrangement, the collection vehicles drive up a ramp to the upper level in order to discharge their contents through a chute into either a transfer vehicle or a loading system installed on the lower level, as shown in Figure IV-19. As an alternative to gravity loading, a direct loading system can also employ a wheeled loader to push the wastes directly into the transfer vehicles.

One of the basic requirements of the direct unloading system is that either the transfer vehicles in operation must keep pace with the frequency of arrival of collection vehicles at the transfer station, or extra transfer vehicles must be purchased for use as temporary storage. These operational alternatives support the efficient coordination of incoming and outgoing wastes and, thereby, avoid delays in the unloading of collection vehicles and the resultant delays in the collection operations. Such logistical coordination is difficult to achieve in a large-scale system (i.e., large processing capacity) where there is a steady flow of collection vehicles entering the transfer station and periods of high frequencies of unloading of delivered waste. Therefore, the direct unloading system generally is implemented only as a small-scale system, such as a neighbourhood transfer station in a small city, or a rural transfer station. In these situations, the quantity of waste handled at the transfer stations would be on the order of 200 to 300 Mg/day. If the transfer station is one of large processing capacity (i.e., greater than 200 to 300 Mg/day), provision should be made for a sufficient number of spare transfer vehicles to ensure that the delivering collection vehicles are not delayed unduly due to the inability of the transfer facility to load out the waste in a timely manner.

One of the main advantages of the direct unloading system is that it involves a small capital investment in terms of civil works. Since a pit to store the wastes is excluded in the direct loading system, in order to result in a simple facility and to save expense, the size of the building can be small. Furthermore, investment in specialised systems to control doors and insects under such

conditions can usually also be small, since substantial doors and prevalence of insects generally are associated with storage of waste.



Courtesy: CalRecovery, Inc.

^a Ramp to upper level shown in background to the right; hopper and loading system shown in the centre; transfer trailer shown in left foreground.

Figure IV-19. Two-level transfer station^a

On the other hand, a major disadvantage associated with the direct unloading system is that it requires that the fleet size of transfer vehicles (and associated loading systems) be sufficiently large to keep pace with the unloading requirements of the collection fleet. Under most conditions, particularly in residential areas, collection vehicles operate by design, by regulation, or by policy during a limited timespan each day (usually early in the morning). Filling the collection vehicle can take from one to five hours, depending on capacity, route size, the method of loading from the collection points, and speed and distance from the disposal facility. In most cities, the majority of collection vehicles arrive at the transfer station within a 2- to 3-hr time period. This is demonstrated by the data presented in Figure IV-20 for a transfer station in Mexico City, Mexico. Therefore, the size of the transfer fleet, in a direct unloading system, would have to meet those peak periods of waste delivery.

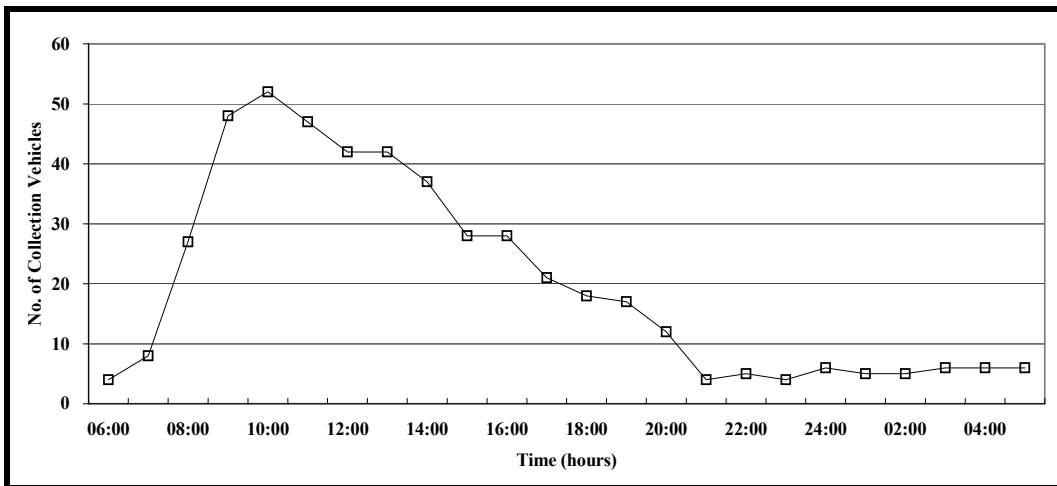
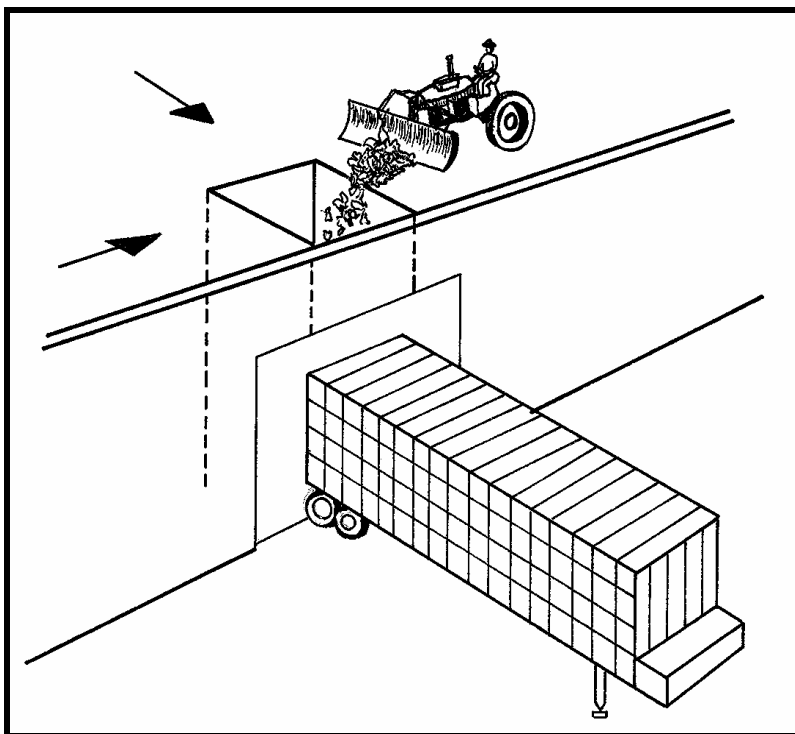

Figure IV-20. Frequency of arrival for collection vehicles at a transfer station

L3.1.2. Unloading to storage

As the phrase implies, a system that utilises unloading to storage involves collection vehicles discharging into a storage area. From the storage area, wastes are subsequently loaded into transfer vehicles. The storage area may consist of a platform located on the same level as that of the unloading area, in which case only a two-level design is required, as shown in Figure IV-21. If large processing rates of waste are required, the storage area may consist of a pit located below the unloading level and above the level on which the transfer vehicles are loaded. In this case, a three-level arrangement is required. The storage area is commonly designed to contain the highest (peak) quantity of waste generated in one day. An example of a three-level design is shown in Figure IV-22.



^a In this type of transfer station, incoming solid waste is stockpiled on the floor during peak delivery periods and is then loaded into the stationary compactor hopper with a front-end loader.

Figure IV-21. Two-level transfer station design ^a

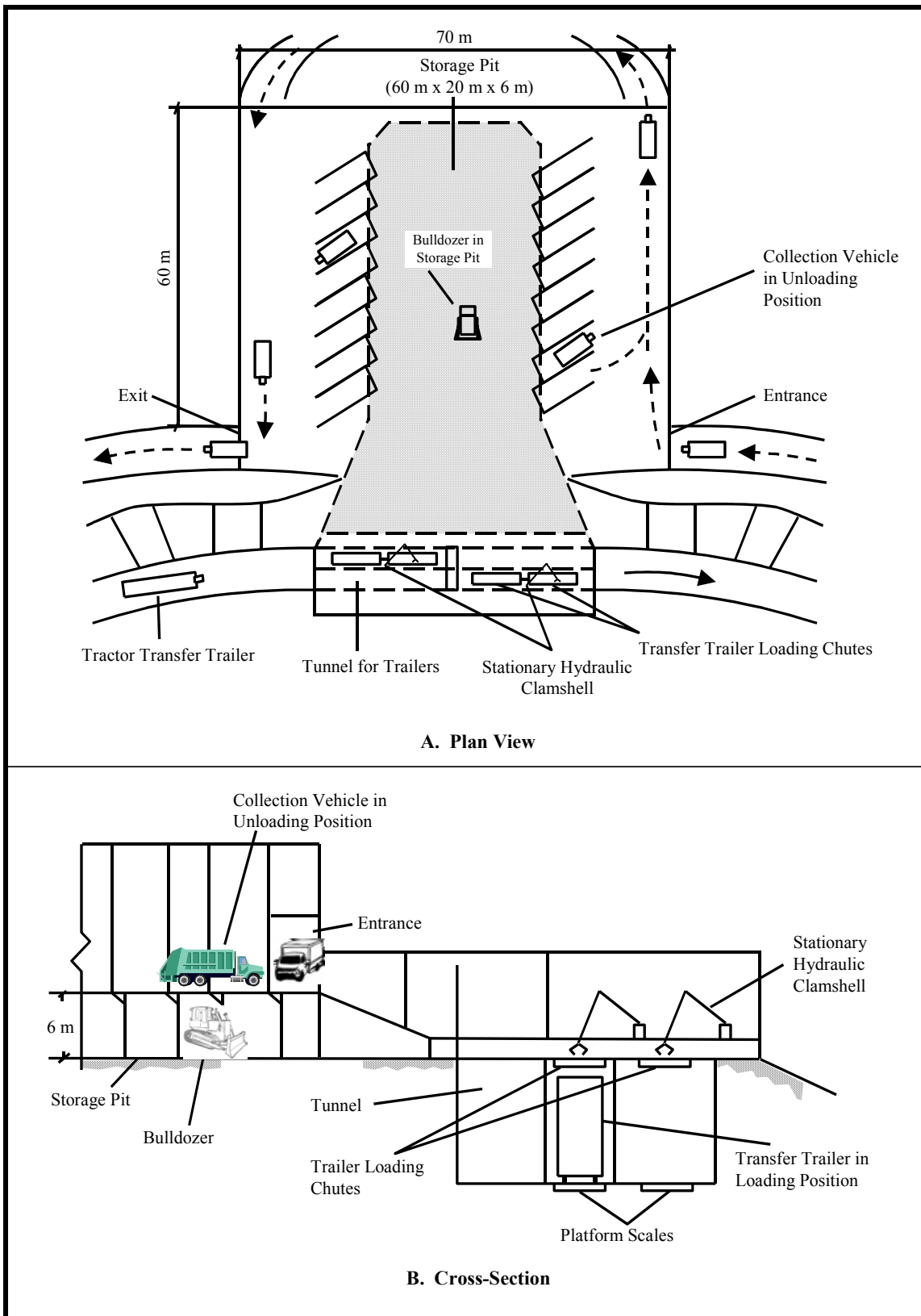

Figure IV-22. Enclosed large-capacity (2,000 Mg/day) storage-load transfer station

In another type of unload-to-storage system, the material is discharged from the collection vehicles, and is loaded into a hopper or onto a conveyor that transports the waste into a transfer vehicle situated at the same level (see Figure IV-23). If the waste is unloaded into a storage pit, the waste can be picked up and loaded into the transfer vehicles by an overhead crane or pushed into the vehicles by a bulldozer. The overhead crane generally is mounted on tracks over the storage pit and is provided with a clamshell or grapple bucket. The operator of the crane or of the bulldozer visually inspects the waste during operation to segregate any materials that are difficult to handle, potentially hazardous, or could damage the transfer vehicle during loading.

The use of an overhead crane for loading transfer vehicles should be carefully evaluated since it requires an adequate structural support. In addition, in the event that the crane breaks down and spare parts are not locally available, the station would essentially be shut down to operations if a contingency plan is not available. In developing countries, spare parts for a bulldozer and front-end loader are more likely to be readily available than those for an overhead crane.

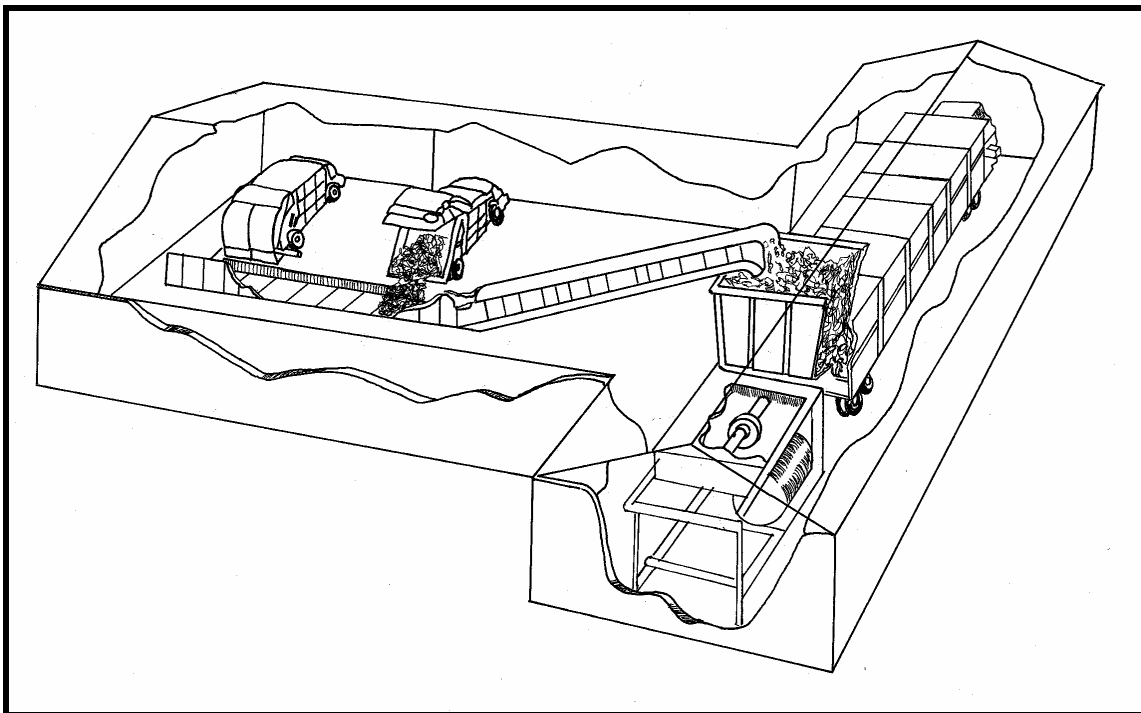

Figure IV-23. Single-level transfer station design in which an inclined conveyor is used to charge the stationary compactor hopper

A system that has provision for the storage of waste upon its delivery to a transfer station supports the optimal operation of the collection process. As previously indicated, waste collection typically is conducted in the morning, when ambient temperatures in many developing countries are relatively low and road traffic is light. The use of a storage system at a transfer station allows collection vehicles to discharge their contents during the morning periods, when waste collection is most likely to take place.

Similarly, the system of unloading to storage allows the transfer process to operate under conditions optimal to its nature. In this particular case, transfer operations can take place at night or at times when road traffic is relatively light. Furthermore, this system allows for a longer period of transfer operation than that of unloading directly from collection vehicles. For example, even though collection of waste commonly takes place between 6:00 am and 2:00 pm, and unloading of the collection vehicles at the transfer station generally occurs between 8:00 am and 4:00 pm, loading of the transfer vehicles and haul of the waste to the disposal facility can take

place over a full 24-hr period. This advantage of the system of unloading to storage may result in improved collection service and lower costs than a transfer system that would employ a direct loading system and operate under similar conditions.

L3.2. Loading of transfer vehicles

This portion of the process involves the loading of waste into transfer vehicles. There are several systems that support this application. Some of the more common ones are described in the following paragraphs.

L3.2.1. Direct loading to transfer vehicle

In this particular system, the waste discharged from collection vehicles or from the storage area drops (by gravity) through a hopper directly into an open-top transfer vehicle. A crane may be mounted at the top of the hopper and used for distributing the load evenly within the transfer vehicle.

L3.2.2. Loading by stationary compactor

In this system, waste drops through a hopper into a stationary compactor. The compactor, mounted on the floor of the lower level of the transfer station, contains a hydraulically-driven ram. The ram pushes the waste from the compactor's receiving chamber into the storage chamber of the transfer vehicle. In this system, the chamber of the transfer vehicle must be adequately reinforced to withstand the pressure created by the compacted waste (see Figure IV-24).



Courtesy: CalRecovery, Inc.

Figure IV-24. Transfer trailer being loaded by a compactor

The primary purpose of the stationary compactor is to densify the waste for hauling. Achieving a high rate of compaction allows the use of fewer transfer vehicles than would be possible in the case of uncompacted waste, all other conditions being equal. However, the chamber of the transfer vehicle must be reinforced to withstand the high pressures created by the compaction of

the waste. Thus, the net vehicle weight of transfer vehicle may be greater than would be the case for a transfer vehicle having a chamber designed for uncompacted waste. The upshot is that net payload of waste could be less in the case of using a compaction station than if wastes were transported in loose form.

L3.2.3. Loading by pre-load compactor

In this system, the waste drops through a hopper into a “pre-load” compactor. In this type of system, the pressure of compaction is applied in a chamber that is remote from the chamber of the transfer vehicle that ultimately will receive and haul the waste. The compactor is mounted on the floor of the lower level of the transfer station and contains a hydraulically-driven ram. The ram pushes the waste from the compactor's receiving chamber into a second chamber, i.e., the compaction chamber. The compaction chamber is reinforced to absorb the pressure exerted by the compacted waste and sized to form a compacted mass that fits within the chamber of the transfer vehicle. Once the compacted mass is fully formed, it is forced from the compaction chamber into the chamber of the transfer vehicle. Since the transfer vehicle does not receive compaction forces, it does not need to be heavily reinforced. Vehicles used with the pre-load compaction system are similar in design to those used with the systems that do not employ compaction (i.e., systems that employ either a bulldozer or crane). The main difference is that the vehicles, in the case of a pre-load compactor system, are loaded through the rear of the trailer, as opposed to loaded through the top.

L3.2.4. Direct loading to self-contained compaction vehicle

In this design, waste is discharged from the tipping area into a trailer that possesses its own compactor (i.e., a self-contained compaction vehicle). A ram, mounted at the front of the body of the trailer, pushes and compacts the waste toward the rear. The same ram used for compacting the waste also is used to discharge the material from the trailer at the disposal site. This system requires that the body of the trailer be suitably reinforced to take the full force applied by the ram.

The characteristics of the waste generated in the area must be carefully considered in the selection of a loading system. For instance, the feasibility of using any type of compaction is affected by the composition, bulk density, and moisture content of the incoming waste. As previously indicated, as a general rule, the lower the income level of a country, the higher the concentration of putrescible matter, moisture, ash, and dirt in the solid waste. Furthermore, the lower the level of income of the country, the less likely the possibility of finding low-density packaging materials. Therefore, in general, the lower the level of income, the higher the density of the waste. In low-income developing countries, loose (i.e., uncompacted) municipal wastes have a bulk density of about 300 to 600 kg/m³. In middle-income developing countries, the density of loose waste is in the range of 200 to 300 kg/m³. In industrialised countries, on the other hand, the density of loose waste is typically on the order of 100 to 150 kg/m³.

Despite significant disparities in the density of loose waste between developing countries and industrialised countries, compaction mechanisms in collection vehicles and those installed at transfer stations produce compacted waste of similar density. The compacted densities achieved in low-income countries are slightly higher than those in industrialised countries (i.e., 550 kg/m³, compared to 450 kg/m³, respectively). This is probably due to the initial moisture content of the wastes, i.e., 30% to 70% in developing countries, compared to 25% to 35% in industrialised countries.

Load bearing limitations and maximum vehicle dimensions established by local and national design standards for roads and bridges are factors that influence the technology for loading at

transfer stations. In the United States, design standards specified by the federal government for bridges built by the government limit gross vehicle weight to about 33 Mg and 5 axles. In addition, no axle may carry more than 7 Mg. However, some of the states allow higher vehicle weights on their roads and bridges.

Many developing countries have adopted standards for road and bridge design that are similar to those in the United States. Consequently, the standards in those countries limit gross vehicle weight to about 33 Mg on 5 axles, with no axle carrying more than 7 Mg. Early in the process of planning a transfer station, the designer should identify vehicle standards and determine whether or not bridges and roads along the proposed transportation route are designed to meet the standard.

If the largest volume transfer vehicle available or manufactured can be filled so as to achieve the allowable gross load limit without compaction of the waste, there is probably little economic justification for using smaller volume vehicles and compacting the waste. In the analysis of the potential benefits of compaction of waste, the capital and operating costs for large-volume transfer vehicles used for hauling uncompacted waste should be compared to the costs of small-volume vehicles transporting either compacted or loose waste. In addition, the incremental cost due to compaction should be added to the capital and operating costs of the fleet hauling compacted wastes.

The total costs associated with loading and transporting the wastes should be thoroughly analysed in order to select the most cost-effective alternative. Small differences in operating cost between the alternatives might prove to be significant if the travel time from transfer station to disposal site is substantial. Countries that are largely dependent on costly fuel (e.g., those dependent upon imported fuel) may achieve greater economy by compacting the loads of waste prior to haul. Similarly, in locations where the salaries of the drivers for transfer vehicles are relatively high, as is the case in most industrialised countries, there may be a greater need to maximise vehicle productivity by compacting loads.

The design or selection of the loading system must take into consideration the level of skill of the workforce. Generally, in comparison to simpler systems of loading that do not utilise compaction, loading systems that employ compaction require a higher level of skill to operate and maintain. Additionally, careful consideration must be given to the type and number of spare parts necessary to keep the equipment in operation. The need for spare parts can be a deciding factor in some developing countries, especially in locations where restrictions on imports exist due to limited foreign exchange.

Most transfer stations that incorporate storage areas into their designs provide for continuous inspection of the waste before loading. Inspection is necessary in order to prevent the loading of heavy items (such as engine blocks and large pieces of concrete) that might damage the floor of the transfer vehicle. Transfer stations that utilise stationary or pre-load compactors are the only systems in which waste is dropped into a receiving chamber rather than into a transfer vehicle. Therefore, these two types of transfer systems reduce the potential for damaging the floor of the transfer vehicles.

As the name implies, the self-contained compaction system incorporates the compaction unit on the transfer vehicle. Consequently, the weight of the transfer vehicle is greater than that of any of the other loading systems. Self-contained compaction units might be appropriate in waste management systems that utilise several small transfer stations served by a fleet of transfer vehicles. Self-contained compaction systems may also be used at small transfer stations that lack a source of power for operating a stationary ram compactor or a pre-load compactor. Similar to

the other compaction systems, the operation and maintenance of the compactor mechanisms require special mechanical skills and adequate stocking of spare parts in order to maintain high levels of system availability.

In addition to cost, several other factors must be taken into consideration in order to determine the most feasible transfer system. Some of these factors include noise and dust generation, traffic, and aesthetics. These factors require that a certain amount of qualitative judgment be exercised in order to assign them a value relative to cost.

Selection of the most cost-effective transfer system generally requires an analysis of the disposal system as well a determination of the compatibility among the collection system, transfer system, and existing disposal system.

L3.3. Transport

In this section, the discussion is limited to transfer stations in which collection vehicles discharge their loads into large-capacity transfer vehicles. Small waste transfer systems, in which collection workers use pushcarts, tricycles, or animal carts to transfer waste into a motorised vehicle, are discussed elsewhere.

The vehicles discussed in this section are truck tractors used to pull trailers of various designs.

L3.3.1. Open-top trailers

As their name implies, these trailers are open at the top and are equipped with doors at the rear. Once full, the waste in the trailer is covered with a net or tarp to prevent spillage during transport. Open-top trailers are loaded from the top by gravity feed through a hopper or opening. The trailers can also be loaded from the rear by means of the pre-load compaction loading system (see Figure IV-25).



Courtesy: CalRecovery, Inc.

Figure IV-25. Typical open-top trailer used in Mexico City, Mexico

L3.3.2. Closed-top trailers

These trailers have a top, sidewalls, and doors at the rear. Closed-top trailers typically are loaded by pre-load compactors. The untied “bale” of waste is forced (extruded) from the compactor into the trailer.

L3.3.3. Compactor-compatible closed-top trailers

These trailers have a top, sidewalls, and doors at the rear. Closed-top trailers that are compatible with compactors are loaded by the system described above, and the top and siding of the unit are reinforced to be able to withstand the compaction forces.

L3.3.4. Self-contained compaction trailers

These trailers are closed at the top, except for an opening used to receive waste near the front. The trailers have sidewalls and doors at the rear. The movable bulkhead is mounted at the front of the trailer and pushes waste from the front toward the rear. The sidewalls, top, and rear doors are reinforced to be able to support the forces applied by the waste as it is compacted by the movable bulkhead. The bulkhead is also used for discharging the waste at the disposal site by pushing the waste out the rear of the unit.

As previously indicated, the allowable load limit used in the design of roads and bridges varies from country to country. Generally, the limit fluctuates between 32 and 42 Mg (gross vehicle weight). The most typical value used in developing countries is 33 Mg gross vehicle weight. The weight of an average truck tractor capable of pulling 33 Mg is about 6 Mg.

The weight of the trailer is a function of the material from which it is manufactured and of the extent of reinforcing provided. Most trailers used to transfer waste have vertical sidewall bracing. In the case of the design of trailers that will be subjected to the forces exerted by the waste as it is compacted, the spacing of the bracing may be closer than when the trailers are loaded by gravity with uncompacted waste. In addition, when the trailers are designed to withstand compaction forces, the areas that are prone to receiving the greatest force must be designed with horizontal sidewall bracing.

Trailers are commonly made of either steel or aluminium. The weight of aluminium trailers is generally 15% to 30% less than that of steel trailers with comparable volumetric capacity. For example, the weight of an empty 75 m³ open-top aluminium trailer is about 5 Mg, and that of a steel trailer is about 6 Mg.

An empty, self-compacting steel trailer weighs significantly more than a compactor-compatible steel trailer of the same volume. For example, a 75 m³ self-compacting steel trailer weighs about 13 Mg; whereas, a compactor-compatible steel trailer weighs about 8 Mg.

Aluminium trailers, since they are lighter, can carry a heavier payload than steel trailers of similar volume. However, the cost of aluminium trailers is 40% to 60% higher than that of steel trailers. Furthermore, aluminium trailers are more costly to repair than steel trailers because the welding of aluminium requires considerable skill, and welding materials are more costly. In addition, aluminium is more brittle and has a lower yield strength than steel; consequently, aluminium is more likely to crack or tear.

In order to determine whether or not aluminium trailers are more cost effective than steel, the incremental vehicle productivity of the aluminium trailers must be assessed versus their higher purchase price and potentially higher operation and maintenance costs. There are very few

developing countries that have the capability of manufacturing aluminium trailers. On the other hand, there are several developing countries that have the capability of manufacturing steel trailers. Consequently, for these countries, a comparative cost analysis of aluminium versus steel trailers must take into consideration the foreign exchange component of purchasing aluminium, as well as any shipping and customs duty charges. In situations where locally manufactured trailers are not available, consideration should be given to local assembly of imported components in order to optimise trailer costs.

Transfer stations can also be designed to simply load containers (e.g., roll-off boxes) rather than to load trailers designed to be pulled by truck tractors. The containers can then be loaded onto a roll-on tilt frame chassis of a truck tractor, on flatbed freight cars, or on barges.

L3.4. Discharge

This phase involves the unloading of the wastes from transfer vehicles at the disposal site. A discharge system may either be self-contained (i.e., part of the transfer vehicle) or external (i.e., located at the disposal site). The discharge systems described in this section are self-contained, with the exception of an external system known as the mobile tipper. A description of each of the main types of discharge systems is presented in the following section.

L3.4.1 Push-blade

The push-blade discharge system consists of a single, tilted blade, sized to fit within the trailer body. The blade travels from the front of the vehicle toward the rear, in order to force the waste out of the vehicle. The blade is pushed by either one or two hydraulic cylinders mounted between the blade and the front of the trailer. In order to discharge its load, the transfer vehicle is driven onto the landfill area and backed up to the working face, the rear doors are opened, and the load is forced out by the blade. The push-blade system is compatible with closed-top trailers that have been loaded by stationary compactor or pre-load compactor systems.

L3.4.2. Live-floor

The live-floor discharge system consists of a series of longitudinal slats mounted on tracks in the floor of the trailer. The tracks move sequentially and alternately in a reciprocating motion to “walk” the load out of the trailer; thus, the use of the term “live-floor”. Hydraulic cylinders mounted below the floor induce the unloading motion. In order to discharge its load, the transfer vehicle is driven onto the landfill area and backed up to the working face, the rear doors are opened, and the load is discharged by the live-floor. The live-floor system is compatible with open- and closed-top trailers, as well as with the following loading systems: direct, stationary compactor, and pre-load compactor.

L3.4.3. Frame-mounted tipper

This system uses two hydraulic cylinders mounted on the frame of the trailer to tip the waste out of the vehicle. The cylinders lift the front of the trailer chamber such that the inclination of the body, combined with the weight of the load, causes the material under gravitational force to slide out the rear of the unit. In order to discharge its load, the transfer vehicle is backed up to the working face, the rear doors are opened, the trailer is tipped by means of the hydraulic system, and the load is discharged. The tipping system is compatible with open-top trailers that have been loaded by direct dumping from collection vehicles into the trailers and with closed-top trailers that have been loaded by pre-load compactor.

L3.4.4. Mobile tipper

Unlike the systems discussed in the previous paragraphs, the mobile tipper is not a self-contained (i.e., trailer mounted) discharge system. The mobile tipper is a machine mounted on a track. The track is located near the working face of the landfill and is used for tilting and emptying the transfer vehicles. Typically, the transfer vehicle is driven onto the mobile tipper and the vehicle's rear doors are opened. Hydraulic cylinders lift the front of the tipper's platform, along with the transfer vehicle. The weight of the load causes it to slide out through the rear opening of the trailer. A bulldozer, stationed near the rear of the mobile tipper, pushes the discharged load away, making sufficient room for discharging the next load. The mobile tipping system is compatible with open-top trailers, which have been loaded by direct dumping from collection vehicles, and with closed-top trailers, which have been loaded by pre-load compactor.

In general, the push-blade discharge system takes up more space within a trailer than a live-floor system. In a 75 m³ trailer, a push-blade discharge system would occupy about 7.5 m³, or about 10% of the trailer's space. On the other hand, a live-floor system would occupy less than 1.5 m³ (about 2%) of the trailer's space.

The push-blade discharge system weighs more than the live-floor system. Push-blade systems are built from steel or aluminium. A steel push-blade, sized to fit a 75 m³ trailer, weighs about 3 Mg; whereas an aluminium push-blade system of comparable performance weighs about 2 Mg. An aluminium live-floor system, sized to fit a 75 m³ trailer, weighs about 1.5 Mg; a steel live-floor system weighs about 2 Mg.

There is little difference in unloading time between the push-blade and the live-floor ejection systems. Both systems unload within several minutes. The live-floor system has an advantage over the push-blade system in terms of minimising space occupied within the trailer and weight. This advantage makes the live-floor discharge system popular in North America. On the other hand, the push-blade system is easier to maintain and repair than the live-floor; this advantage results in the popularity of the push-blade discharge system in some developing countries. Several developing countries are capable of manufacturing push-blade trailer systems, whereas, to the knowledge of the authors, the live-floor system is not manufactured in any developing country at the present time.

The self-contained tipping system does not appreciably add weight to or consume space within the transfer vehicle. However, unless the ground conditions at the working face of the landfill are relatively dry, level, and compacted (a condition that seldom exists in most landfills in developing countries), the self-contained tipping system is potentially dangerous. The authors are aware of some cases in which large trucks with tipping systems have become unstable while elevating the loaded trailer or when the trailer is in an elevated position during the wet season when high winds, heavy rains, or muddy landfill conditions are present. Under similar site conditions, this stability problem and hazard is much less in the case of a mobile tipper discharge system. The mobile tipper system consists of a track-mounted, relatively strong and stable lifting structure that incorporates outriggers at both ends of the platform to provide additional stability to the tipping system.

The mobile tipper allows a transfer vehicle to transport maximum payloads since the vehicle does not have to accommodate the weight and space of a self-contained discharge system. In terms of an analysis of costs and benefits of a mobile tipping system versus a self-contained system, the capability of transporting more waste per vehicle must be compared with the total cost of owning and operating the mobile tipper. Mobile tippers appear to be economically justifiable in situations

where the travel time to the landfill is high (well over an hour each way) and where the load limits of the roads and bridges are low and strictly enforced.

For any potential cost effectiveness of the mobile tipper discharge system to be assured, there must not be any queuing of transfer vehicles at the disposal site waiting for emptying by the mobile tipper. It takes an average cycle time of 6 minutes for a trailer to be driven onto the mobile tipper, have its contents discharged, and be driven off the tipper. Therefore, a mobile tipper typically can discharge about 10 transfer trailers per hour.

One way to avoid any queuing of transfer vehicles is to put into effect a shuttle system. In a shuttle system, the tractor truck leaves a fully loaded trailer at the disposal site and takes an empty trailer. The loaded trailers usually are connected to an off-highway tractor (also called a yard goat) to be shuttled to the mobile tipper for discharge of the loads. An analysis of the cost of operating the mobile tipper would need to take into consideration the additional cost of owning and operating the off-highway tractors, as well as the cost of acquiring some spare trailers. The spare trailers are necessary in order to make sure that empty trailers are always waiting for incoming truck tractors.

There does not seem to be a substantial difference in the operation and maintenance requirements of the various discharge systems. All systems utilise moving parts that either tip, push, or walk (via reciprocation) the load of wastes out of the trailer. Generally, the moving parts are driven by the power take-off, and hydraulic pumps and cylinders.

L4. CONCLUSIONS

The main objective for the implementation of a transfer system is to establish efficient collection, transport, and disposal systems and, thus, conserve resources. Transfer stations should only be implemented when the cost of direct haul in collection vehicles is higher than the combined cost of supplemental haul in large transfer vehicles and the cost of the supporting infrastructure necessary at both the transfer station and the disposal site.

In a developing country, a typical collection vehicle carries a load of 2 to 5 Mg and has a crew of 1 driver and 2 or 3 workers. On the other hand, a transfer vehicle carries a load of 20 to 25 Mg and has a crew of only 1 driver. Consequently, the unit cost per kilometre (US\$/Mg/km) for bulk transport should be substantially less than that for direct haul. The type and degree of savings in collection and transportation costs due to the implementation of a transfer station depend not only on the costs of transportation, but also on all of the costs associated with the operation of the transfer system, e.g., unloading, storage, loading at the transfer location, and discharge of transferred wastes at the disposal site.

Every aspect of the transfer station must be designed such that optimal savings can be attained. Local conditions will play a dominant role in the determination of which type of transfer system(s) will be more cost effective. The composition, density, and moisture content of the wastes will affect the decision regarding the need for a loading system that provides compaction of the wastes. The available area for the transfer station and the frequency of arrival of collection vehicles will be major determinants in the assessment of the need for a waste storage system at the station. The distance to the disposal facility, the cost of fuel, weight limits, and wages for transfer vehicle drivers are some of the more important local factors that will govern the decision of whether or not to make the greater capital investment in systems that yield maximum waste payloads.

In summary, before a final decision is made with regard to the implementation of a transfer system, the conduct of a thorough analysis of costs is essential, including the costs associated

with owning and operating alternative types of transfer station systems. The various costs of alternative systems for unloading, loading, transport, and discharge must be normalised in terms of unit cost (i.e., US\$/Mg) in order to determine the optimum system under local conditions. Although unrelated to costs, but intimately related to overall feasibility of a transfer system, the site selection process should include the participation of members of the public.

M. Costs of solid waste collection

Collection of solid waste is a key element of any modern solid waste management system, and its importance is also reflected by the fact that collection generally is the costliest subsystem of a waste management system. Consequently, a good understanding of the actual costs involved in providing collection service is very important in the planning and implementation of the service. Furthermore, an accurate determination of collection costs allows: 1) selection of the least cost option, 2) adequate budgeting, and 3) determination of tariffs or user fees. The major components of waste collection are those associated with vehicles and labour. Therefore, the total cost of collection is affected by the degree of mechanisation, the ratio of imported equipment to that manufactured locally, and the degree of labour intensity required for the types of storage containers and vehicles employed in the system.

During the initial stages in the design of a collection system, it is necessary to establish the criteria to be used for selecting the system. The criteria should allow for an objective comparison between alternatives. Until recently, selection of the most cost-effective alternative was based solely on financial analyses. Financial analyses do not reflect the relative amounts of the resources that are used in a waste collection system. Financial analyses include price distortions due to government policies concerning or affecting interest rates, loan maturities, and subsidies. For example, many developing countries are severely affected by the availability of foreign exchange. Financial analyses do not take into consideration the quantity of foreign exchange available to the country. Consequently, the authors recommend that economic analyses be conducted, rather than financial analyses, to determine the “true” least-cost collection option. In the following section, a description is provided of: 1) the major cost elements that must be considered in determining the overall costs of the collection system, 2) the use of economic analysis for purposes of determining the least-cost option, and 3) the use of financial analysis for the establishment of user fees.

M1. SYSTEM costs

The costs associated with waste collection consist of the following major components: 1) planning and design, 2) labour and equipment, and 3) garage and supporting facilities (e.g., transfer stations). Each of these components is discussed in the following sections.

M1.1. Planning and design

Planning and design of waste collection systems must be carried out by professionals who are knowledgeable in waste management practices. These professionals should be assisted by other professionals such as economists, mechanical and civil engineers, and sociologists. In addition, these individuals should obtain technical support for the collection of data on quantity and composition of the wastes, as well as on physical, chemical, and other properties of the waste stream. In general, however, the cost of planning and design should be moderate and should be on the order of 1% to 5% of the overall capital cost. The cost of design of civil works for garage and other facilities, in general, should not exceed 8% of the capital cost of the facilities.

M1.2. Labour and equipment

The type of equipment used in the collection process includes vehicles and storage containers (for residential, commercial, and industrial wastes). Operating costs for the collection process include: labour (both skilled and unskilled); fuel, oil, and other fluids; maintenance of vehicles and containers; management and administrative overheads; debt service; and insurance and tax for the vehicles. The cost of labour should include fringe benefits. Fringe benefits usually are on the order of 20% to 40% of basic wages (i.e., salaries). Overhead for management and administration varies widely from one municipality to another. A list of the major cost elements involved in the purchase and operation of waste collection equipment is presented in Table IV-7.

M1.3. Garage and auxiliary civil works

The costs associated with the construction and operation of a garage and auxiliary civil works include the following components: land and civil works, tools and equipment, and operation and maintenance costs for the facilities and equipment. A listing of the major cost elements associated with owning and operating garage facilities and auxiliary civil works is presented in Table IV-8.

Table IV-7. Major capital and operating cost items for collection equipment

Item
Collection vehicles
<ul style="list-style-type: none"> • Primary • Secondary • Other
Vehicles for supervisors
Trailers
Containers
Bins
Labour
<ul style="list-style-type: none"> • Skilled • Unskilled
Fringe benefits
Repair and maintenance
<ul style="list-style-type: none"> • Vehicles (about 15% to 20% of purchase price per year) • Trailers (about 8% to 10% of purchase price per year) • Bins (about 5% to 10% of purchase price per year)
Depreciation (over 5 years)
Interest
Administrative overhead (about 15% of direct labour costs)
Tax, insurance, licenses

Table IV-8. Major capital and operating cost items for garage and auxiliary civil works

Item
Land
Site preparation
Civil works
Utilities
Engineering (about 2% to 5% of construction costs)
Contingencies (about 5% to 10% of construction costs)
Labour
<ul style="list-style-type: none"> • Skilled • Unskilled
Overhead
Operation and maintenance
Insurance
Utilities
Fuel
Supplies and outside services
Tools and equipment

M2. COLLECTION from communal containers

In most developing countries, the size of waste collection crews is generally two to eight workers. In this section, we discuss key factors that determine optimum crew size and, therefore, optimum cost.

In many situations in developing countries, enclosures for the storage of solid wastes are located at ground level and contain between 500 and 1,500 kg of wastes. Typically, the wastes are transferred into the vehicles by means of shovels, rakes, and baskets. In this method of collection, the limit on crew size is determined by the maximum number of labourers that can collectively empty a basket into the vehicle. Within that limitation, every additional crew member adds an equal amount of productivity. Crews in this instance typically consist of six workers. Generally, the enclosures are located several hundreds of meters apart. Furthermore, the process requires that the workers be transported between sites. In practice, therefore, available space on the vehicle for transport of the crew could be the limiting factor on crew size.

In those cases where cylindrical concrete bins for waste storage are located alongside the road, the number of workers that can simultaneously transfer wastes from the bins to smaller containers used to load the collection vehicle is constrained by the diameter of the bin. Typically, only one or two workers can work within the bin at the same time. Therefore, considering the amount of work involved in filling and carrying the baskets, the largest number of workers that can be effectively employed is between three and six.

If single, 200-L drums for waste storage are placed at certain intervals on the road or street, the maximum practical crew size is two. The number of crew members would have to be increased by one or two if the collection vehicle is of the type having an open top with very high sidewalls. The additional crew members would be stationed in the body of the vehicle to assist in lifting and emptying the containers handed to them by the workers at the street level.

In block collection of solid wastes, it is rarely necessary to use a crew of more than two, since the crew's only task is to stand at the rear of the vehicle and empty containers handed to them by the residents.

M3. KERBSIDE and door-to-door collection

In the case of the analysis of kerbside and of door-to-door collection systems, the process of determining the most cost-effective crew size is more complex than that for collection systems that utilise communal container storage. For door-to-door collection in a residential area of single-family dwellings, the basic work elements for a two-person crew, working both sides of the road, are as follows: 1) walk into the backyard and pick up the full container, 2) carry the container to the collection vehicle and empty it, 3) return the empty container to its original location, 4) walk back to the road, and 5) walk to the next house on the same side of the road.

In the case of a crew using four workers (two workers for each side of the road), the time required to walk to the next house to be serviced is essentially doubled, since both workers on one side of the road must walk the frontage distance of two houses, instead of one.

A second factor that impacts selection of this type of collection system is that the greater the crew size, the longer the distance over which the crew is spread at any one time while the vehicle remains stationary. Thus, the larger the crew, the more time that will be spent either walking toward the vehicle or waiting with the container for the vehicle to come within a reasonable walking distance.

Collection from only one side of the street sometimes is necessary when traffic is heavy or the street is extremely wide. In fact, there are some operators of waste collection systems in industrialised countries that do not collect on both sides of the street due to safety factors. When collection is carried out from only one side of the street, every worker increment above a single collector causes a disproportionate increase in labour time in terms of waste collection productivity, with the result that productivity per labour unit decreases and labour cost per container emptied increases.

In the case of kerbside collection, the frontage walked constitutes a much greater proportion of total work content and, thus, the incremental reduction in labour productivity is more rapid than in the case of door-to-door collection. Vehicle productivity, however, follows the opposite pattern; the greater the crew size, the larger the number of containers that can be emptied per unit time and, therefore, the larger quantity of wastes that can be collected per unit time.

Thus, for every situation there is an optimum crew size that achieves the lowest total cost of collection. There are several factors that determine optimum crew size. Some of these factors include: physical layout of the collection area, distance to be walked for the various activities of the collection process, the type of system used (door-to-door or kerbside), traffic and parking patterns and conditions, local wages, and cost of vehicles.

In most cities, it is possible to define different types of collection areas (e.g., areas with wide streets and those with narrow streets), each of which would require a particular number of collection crew members in order to optimise productivity and cost. Typically, in a particular city, the costs of collection vehicles and labour wages are constant. However, these costs may vary within a country and from one country to another. For these reasons, it is generally advisable to carry out time-and-motion studies in every city under consideration for a new or improved collection system in order to determine, within a reasonable level of accuracy, optimum crew size for collection areas defined within a certain set of conditions, e.g., narrow, winding streets with hilly terrain and wide, straight streets with flat terrain.

The route or portion of a route selected for time-and-motion studies should be sufficiently long to provide work between one and two hours. In addition, during each test, the crew should be accompanied by a supervisor who will record the total number of containers emptied and the elapsed time between the starting and finishing points. In the case of routes designed for working a single side of the street, crews of 1, 2, 3, and 4 personnel should be used on successive occasions for the purpose of determining the optimum crew size. For routes designed for working on both sides of the street, crews of 2, 4, and 6 should be used in the test. It is also recommended that each test be repeated at least four times; each time the members of the crew should be different in order to account for and balance out individual worker characteristics.

In order to determine the optimum crew size, the unit costs for collection labour and for collection vehicles must be examined as part of the analysis. To demonstrate this type of analysis, a hypothetical example for a collection system using bins and typical productivities for crew and vehicles is given in Table IV-9. The data shown in the table illustrate the important influence of the ratio of cost of labour to operating cost of collection vehicles on the determination and optimisation of collection costs.

**Table IV-9. Impact of cost ratio of labour to vehicle on collection cost
(units of national currency)**

No. of Crew	Productivity		Low Wage Rate ^a Cost/Bin			High Wage Rate ^b Cost/Bin		
	Bins/ Person-hr	Bins/ Vehicle-hr	Labour	Vehicle	Total	Labour	Vehicle	Total
2	30	60	0.66	1.60	2.26	3.32	1.60	4.92
4	25	100	0.80	1.00	1.80	4.00	1.00	5.00
6	20	120	1.00	0.77	1.77	5.00	0.77	5.77

^a Low Wage Rate: 1 person-hr = 20, 1 vehicle-hr = 100.

^b High Wage Rate: 1 person-hr = 50, 1 vehicle-hr = 100.

In Table IV-9, a breakdown of the unit costs of collection (i.e., cost/bin) is shown for two categories of wage rates (low and high, respectively). The results shown within each category are based on a low and high wage rate of 20 and 50 currency units, respectively. The hourly cost of the collection vehicle is normalised to 100 currency units. These relative rates are fairly typical for several developing countries.

A curious effect of a high ratio of wage cost to vehicle cost is observed in some locations in the United States, where one person-day may cost 140% of one vehicle-day. The result of this high ratio is that in some cities, the optimum crew size using a 15 m³ compactor vehicle is one crew member (i.e., the driver).

M4. OPERATION of collection vehicles in relay

In some situations, it may be advisable to consider the use of more than one vehicle per collection crew. This situation can occur if the vehicle is very slow, as in the case of an animal cart, and if the disposal site is remote from the collection location.

When the time required to deliver a load to the disposal site and to return to the collection area is approximately equal to the time required to load a vehicle, then a 2:1 relay system (i.e., two vehicles to one crew) enables the crew to be continuously employed throughout the workday. If only one vehicle is used, the crew would be employed for only about half the time. A 2:1 relay system requires staggered starting times for the drivers of the vehicles.

Working in relays in the situation described above achieves maximum labour productivity. However, some of this advantage is lost due to a reduction in output toward the end of the day, as a result of fatigue of the collection crews. Crews working in a single vehicle system benefit from the periods of rest observed during the trip to and from the disposal site. The result is a higher average rate of productivity during the lesser number of hours during which they are effectively collecting wastes, when compared to crews operating in a relay system when all other conditions are similar.

One advantage of relay systems is that they help to maintain reliability of service. In the event of a breakdown of one vehicle, work can proceed and the day's task can be completed by using a single vehicle and by working longer hours.

Since a relay must be operated to a precise timetable if it is to achieve its aim of continuous productive employment for the collectors, it requires high standards of supervision and of discipline.

M5. OPTIMISATION of vehicle routes

A large number of municipalities in developing countries do not have specific routes for waste collection. Typically, collection vehicles are assigned general areas and the specific routes to be followed are left to the discretion of the drivers. This manner of operation often results in routing that is convenient to the collection crew but not optimum in terms of technical and financial efficiency of collection. There are several approaches available for designing collection routes, depending on the complexity of the situation. Some of these approaches include: 1) heuristic, 2) deterministic, and 3) heuristic-deterministic. In the heuristic method, the system of assigning routes simply is based on experience of the service supplier and, therefore, the solution obtained will be reasonable but may not be optimum. In the deterministic method, a model is developed and by using a computer, an optimum solution for the routing is calculated. In the heuristic-deterministic method, a number of possible alternatives are first identified and then, for a set of defined constraints, the optimum solution is determined.

M6. COSTS of alternative systems

In this section, we present the results of the type of analysis that should be carried out in order to compare the feasibility of implementing a particular type of collection system. The results are given in Tables IV-10 and IV-11 for refuse collection service using a 10-Mg diesel truck and a farm tractor, respectively. The values shown in the tables are, of course, based on a number of assumptions. The assumptions used in the analyses are also shown in the tables. Although the assumptions used are fairly typical and realistic for many situations, the values of the parameters can fluctuate widely from country to country. It is important to note that, in many municipalities, the amount of time spent by administrators, supervisors, and mechanics on the operation and maintenance of a particular type or piece of equipment is not known and, consequently, judgments must be made, or the necessary data collected in order to produce accurate estimates.

As shown in Tables IV-10 and IV-11, the results of the analyses ultimately are normalised to a unit cost (i.e., US\$/Mg). The results of this particular set of analyses indicate that, for the specific conditions given in this evaluation, the unit cost for collection is between US\$27 and US\$49/Mg, depending upon the type of collection service. In this analysis, the alternative that results in the lowest cost is the system that uses a 10-Mg diesel truck. As previously indicated, factors other than unit cost also influence the final selection of the specific type of collection system.

The unit cost and productivity of collection systems vary widely around the world, and the variation illustrates the impact of site-specific conditions on collection. An example of the variation is given in Table IV-12. The data presented in the table can be used as one basis of comparison once costs and productivities are estimated for a given location.

Table IV-10. Example of cost analysis for refuse collection using a 10-Mg diesel truck (2003, US\$/yr)

Operation and Maintenance		Assumption	Annual Cost
Capacity (m ³)		10	
Useful life (years)		10	
Interest rate (%/yr)		15	
Capital cost (\$)		76,000	
Spares (15% of capital cost in \$)		11,000	
Total capital investment (\$)		87,000	
No. of shifts/day		1	
Operating schedule (hr/yr)		2,080	
No. of trips (trips/shift)		4	
No. of loads (loads/shift)		3.6	
Density of refuse (Mg/m ³)		0.3	
Vehicle productivity (Mg/day)		10.8	
Amortisation (interest, useful life)			17,000
Maintenance (9% of capital cost)			7,800
Taxes, registration, insurance (3% of capital cost)			2,600
Subtotal Operation and Maintenance			27,400
Personnel		Rate	Annual Cost
No.	Type		
1	Drivers	5,300	5,300
2	Collectors	4,000	8,000
3	Helpers	2,500	7,500
0.3	Mechanics	6,000	1,800
0.3	Supervisors	6,600	2,000
	Subtotal		24,600
	Fringe benefits (15% of salaries)		3,690
	Administration (20% of salaries)		4,920
	Subtotal Personnel		33,210
Total Operation and Maintenance			60,610
Quantity Collected (Mg/yr)			2,246
Unit Cost (average US\$/Mg)			27

Table IV-11. Example of cost analysis for refuse collection using a 50-kW farm tractor (2003, US\$/yr)

Operation and Maintenance		Assumption	Annual Cost
Capacity (m ³)		8	
Useful life (years)		15	
Interest rate (%/yr)		15	
Capital cost (\$)		100,000	
Spares (15% of capital cost in \$)		15,000	
Total capital investment (\$)		115,000	
No. of shifts/day		1	
Operating schedule (hr/yr)		2,080	
No. of trips (trips/shift)		3.5	
No. of loads (loads/shift)		3.15	
Density of refuse (Mg/m ³)		0.3	
Vehicle productivity (Mg/day)		7.56	
Amortisation (interest, useful life)			19,300
Maintenance (9% of capital cost)			10,400
Taxes, registration, insurance (3% of capital cost)			3,500
Subtotal Operation and Maintenance			33,200
Personnel		Rate	Annual Cost
No.	Type		
1	Drivers	5,300	5,300
2	Collectors	4,000	8,000
6	Helpers	2,500	15,000
0.3	Mechanics	6,000	1,800
0.3	Supervisors	6,600	2,000
	Subtotal		32,100
	Fringe benefits (15% of salaries)		4,800
	Administration (20% of salaries)		6,400
	Subtotal Personnel		43,300
Total Operation and Maintenance			76,500
Quantity Collected (Mg/yr)			1,572
Unit Cost (average US\$/Mg)			49

Table IV-12. Unit cost and productivity of collection in various countries

Economic Status	Geographical Region	Urban Population	Collection Cost (US\$/Mg)	Mg/Vehicle
Developing	Latin America, Turkey, Nigeria	> 1,500,000	10 to 30	10 to 15
	Tunisia, Turkey, Western Pacific	< 250,000	20 to 35	4 to 5
Industrialised	Spain	50,000 to 250,000	60 to 80	6 to 15
	Denmark, United States	50,000 to 1,000,000	100 to 130	6 to 8

Sources: Reference 6 and CalRecovery, Inc.

N. References

1. Diaz, L.F., *El Manejo de Residuos Solidos Urbanos en La Paz y sus Areas Marginales*, prepared for Foster Parents Plan International, Rhode Island, USA, 1986.
2. United Nations Centre for Human Settlements (Habitat), *Development Planning Programme for Peshawar - Solid Waste Management Project Preparation*, Draft Final Report, Nairobi, Kenya, January 1988.
3. CalRecovery, Inc., *Metro Manila Solid Waste Management Study: Draft Final Report, Volumes I and II*, prepared for Metropolitan Waterworks and Sewerage System, Manila, Philippines, July 1982.
4. Flintoff, F., *Management of Solid Wastes in Developing Countries*, WHO Regional Publications, South-East Asia Series No. 1, Second Edition, World Health Organization, 1984.
5. Diaz, L.F. and C.G. Golueke, "Solid Waste Management in Developing Countries", *BioCycle*, July 1987.
6. The World Bank, *Municipal Solid Waste Management Study for the Mediterranean Region, Synthesis Report*, September 1992.
7. The World Bank Group, *World Development Report 2000/2001*, Oxford University Press, Inc., New York, New York, USA, August 2000.
8. United Nations Centre for Human Settlements (Habitat), *Refuse Collection Vehicles for Developing Countries*, Nairobi, Kenya, undated.
9. CalRecovery, Inc. (L.F. Diaz and L.L. Eggerth), *Waste Characterization Study: Ulaanbaatar, Mongolia: Winter-Summer 2002*, Final Report, prepared for WHO/WPRO, Manila, Philippines, August 2002.
10. Republic of the Philippines, *Waste Characterization Study for Quezon City*, Draft, June 2003.
11. CalRecovery, Inc., *Results of Waste Characterization Study for the Metropolitan Region of Buenos Aires: Conducted in January and February 2001*, prepared for CEAMSE, February 2001.

CHAPTER V. STREET CLEANING

A. Introduction

Street sweeping is one facet of a solid waste management system in which public education and public relations play critical roles. Unfortunately, very little information is available in the literature on the various aspects associated with street sweeping. The wastes deposited on the streets create a negative visual impact, particularly on visitors, and thus indirectly affects the economy of the city.

In many cities, particularly the small ones in economically developing countries, only the paved streets are swept. Since not all of the streets are paved, a relatively high portion of the city does not receive street sweeping services. Views of typical streets in marginal and low-income areas are shown in Figures V-1 and V-2.

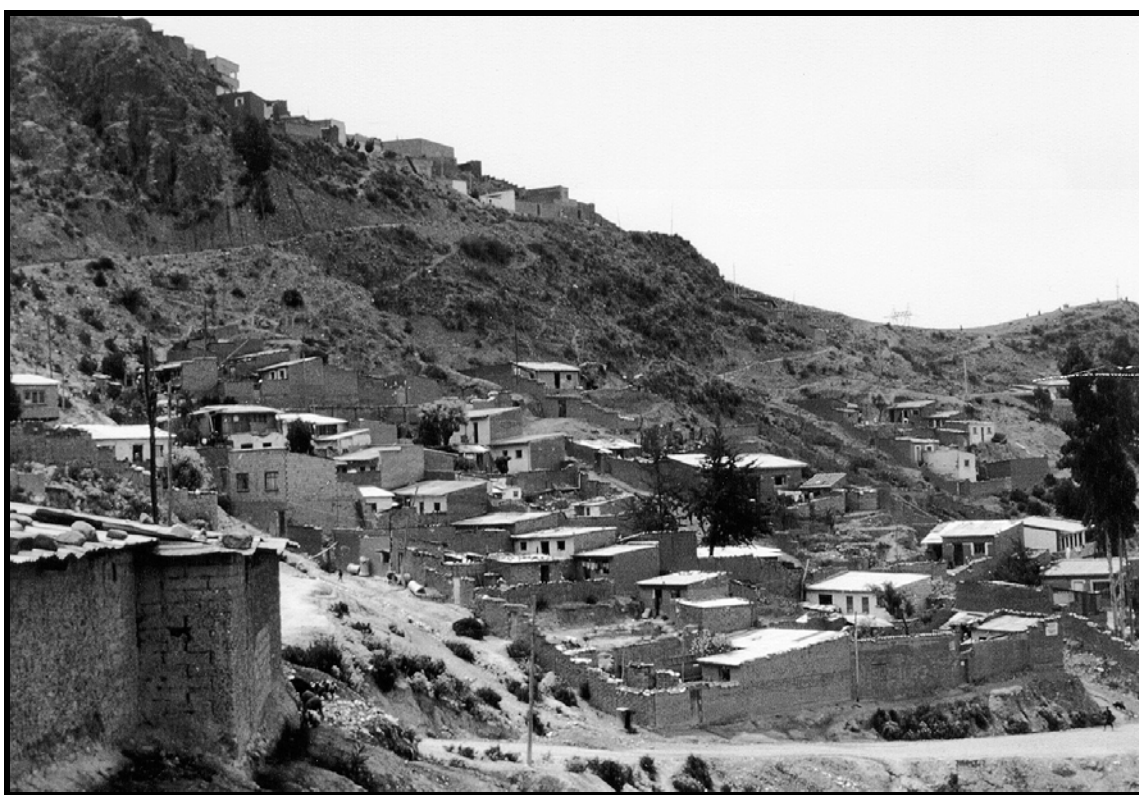

Courtesy: CalRecovery, Inc.

Figure V-1. Unpaved streets in marginal area in Latin America

A considerable amount of the work associated with street sweeping is due to inappropriate behaviour on the part of the public, such as discarding litter in the street. Additionally, in many cities in developing countries, particularly in medium- and low-income areas, a high proportion of street wastes is generated from deficiencies in the refuse collection system. Due to the poor coverage of the collection system, a number of people opt for discarding their wastes in the street or in vacant lots. In essence, this situation merely transfers the responsibility for removing the wastes from the refuse collection crew to the sweeping crew. Other causes that lead to the large quantities of litter that may be observed in some cities in developing countries are: improper or no cleanup activities after completion of public works projects, inadequate or inappropriate species of plants and trees selected for urban landscaping, erosion of soil from vacant lots and unpaved streets, inefficient or non-existent storm drainage systems, accumulation of construction

materials as well as construction debris on the streets, and spillage of wastes set out for collection by either scavengers or animals. It is fairly common for the collection system in large metropolitan areas to conduct special operations to remove wastes from well known illegal disposal sites. Obviously, the costs involved in collecting wastes that have been scattered in the street are considerably higher than the costs of collecting the wastes by means of conventional containers.



Courtesy: CalRecovery, Inc.

Figure V-2. Narrow and steep “street” in a low-income area

Despite the fact that municipalities may spend approximately 10% to 20% of their budgets on street cleaning and sweeping, the process is not normally optimised. There are several types of tools, equipment, and methods (both manual and mechanical) available for street cleaning. Because of the tasks and costs involved in the process, street cleaning is also a system in which there are opportunities for savings by simply improving the efficiency of the process.

The primary objectives of policies associated with a street cleaning system should be: 1) the provision of efficient, cost-effective waste collection services from the source, 2) reduction of street litter through regulation, public education, and enforcement, 3) the use of systems that achieve high labour productivity, and 4) the design and use of effective tools and equipment.

B. Types of street wastes

For purposes of solid waste management, street wastes can be classified into three main categories, depending upon the type of generator. The classification is as follows: 1) wastes generated by natural causes, 2) wastes generated by road traffic, and 3) wastes generated by the public (behavioural wastes) [1]. A discussion of each type follows.

B1. WASTES generated by natural causes

As the name implies, these wastes are generated by natural phenomena and are difficult to avoid. They include dusts blown from unpaved areas, and leaves and flowers that fall from trees and plants in the community. Since wastes produced by natural events cannot be avoided, the method of management must be control, for example, the use of such measures as planting of vegetation and other artificial methods to prevent erosion in empty lots, planting of adequate trees and vegetation as wind breakers, and careful selection and regular maintenance (e.g., pruning) of the trees planted in the city.

The result of poor stormwater management and high rainfall leading to the accumulation of sand, mud, rocks, and other debris in a city in Latin America is shown in Figure V-3.



Courtesy: CalRecovery, Inc.

Figure V-3. Impact of poor stormwater control on street sweeping

B2. WASTES generated by traffic

Motor vehicles can generate a relatively high proportion of street wastes. Motor vehicles deposit dirt and mud, as well as oil and rubber on the roads. Particulate matter from diesel emissions also accumulates on streets, trees, and building surfaces, creating a public nuisance. In addition, in developing countries, it is common to transport materials in vehicles that are uncovered, and there can be accidental spillage of a vehicle's load. Additionally, animals drawing vehicles can deposit excrement on the road surface. Mud is often carried out of construction sites, adhered to the tires

of motor vehicles, and subsequently deposited on adjacent roads. In general, traffic wastes are unavoidable; however, it is possible to control them through public education and the promulgation of appropriate rules and regulations. Regulations requiring that loads be covered to reduce spillage and that vehicles be properly cleaned before leaving muddy construction sites can positively contribute toward the reduction of wastes generated by traffic.

B3. WASTES generated by the public

There are two major sources of wastes generated by the public: 1) litter thrown onto the streets by pedestrians, and 2) residential and commercial wastes swept or discarded from private premises.

As previously indicated, a large fraction of these wastes can be controlled, provided that an efficient and reliable refuse collection service is in operation and that litter bins are provided for use by pedestrians. These two conditions should be complemented by a continuous program of public education, combined with strong legislation and enforcement procedures. Another potential solution to reducing the amount of litter is to offer a free or relatively inexpensive program to collect non-conventional wastes such as construction and demolition debris, tree trimmings, and others.

C. Manual street cleaning

The design of a conventional street includes three distinct surfaces: a roadway for vehicular traffic, a gutter, and a sidewalk on both sides of the street for use by pedestrians. The sidewalks are slightly elevated and are separated from the roadway by a curb and gutter. The gutter is the lowest part of the road structure and serves to control, collect, and direct stormwater to a drainage location or system. The gutter is provided with outlets or discharge points at certain intervals to prevent stormwater from accumulating on the roadway.

Typically, it is not necessary to sweep the surface of a roadway. The reason is that vehicular traffic usually generates turbulent forces that are sufficient to direct dust and litter from the crown of the road toward the gutters. Consequently, in most places, the process of street sweeping consists of cleaning the sidewalk and the gutters. In some cities, such as is the case in Montevideo, Uruguay, it is traditional to wash the sidewalks. This tradition, of course, results in another set of problems.

Usually the wastes that accumulate on the sidewalks consist primarily of light materials (i.e., leaves, paper, plastic, matches, and cigarettes) and some dust. On the other hand, a relatively high concentration of heavy materials and dust has the tendency to accumulate in the gutters. Consequently, the tasks for cleaning each one of these surfaces are different.

Although these principles apply to most streets of a typical city, the quantity and types of wastes generated varies in proportion to the level of human activity and the public's sense of civic duty. Therefore, the required frequency of sweeping can fluctuate from several times a day to once a week.

C1. EQUIPMENT

The typical equipment used for manual street cleaning includes: brooms, shovels, and handcarts.

C1.1. Brooms

There are two general types of brooms used for street sweeping, depending upon the type of material used for their manufacture. The first type is that made from long fibres and formed into a

bunch (this type is commonly used in Asia, although they are also used in some areas in Latin America). The second type is that in which bunches of filaments are inserted into a wooden section (about 10 cm by 10 cm in cross section and 40 to 50 cm long); this section is attached to a wooden pole. Due to the fundamental differences in their design and the type of materials used for their manufacture, each type of broom is used differently. The broom made from long fibres has the length and flexibility to allow the user to take long strokes without the fibres exerting high pressure on the ground. These characteristics make this type of broom an excellent tool for sweeping litter and leaves from unpaved surfaces. On the other hand, the stock broom is pushed ahead of the sweeper. The sweeper uses short strokes to push the litter in front of him. The filaments in this type of broom are shorter and stiffer than those of the bunch broom; therefore, this broom generally is used to remove materials that have the tendency to adhere to the surface of streets. Depending upon the width of the stock and the stiffness of the filaments used, these brooms are excellent tools for collecting dust and sand.

Stock brooms of about 30 cm filled with a natural fibre have been widely used in the United States and in Europe for sweeping gutters. Recently, synthetic fibres such as polypropylene have replaced some of the natural fibres.

Consequently, a sweeper should be equipped with two types of brooms, one for the gutter and one for the paved areas.

C1.2. Shovels

The function of the shovel is to pick up the material that has been swept into a pile with the broom for placement in a container. The main type of shovel that is used for this purpose is a large straight-blade shovel made of plastic or metal. Metal shovels are heavier than plastic ones but tend to last longer and are more versatile, particularly to remove materials adhered to the paved areas.

C1.3. Handcarts

Handcarts are widely used for street sweeping throughout the world. A description of handcarts is provided in another section. Street sweepers usually modify the equipment they are provided with to suit their needs. Various types of carts observed by the authors in economically developing countries are shown in Figure V-4.

C1.4. Additional equipment

All sweepers should be provided with uniforms, gloves, safety equipment, and, in some instances, plastic bags. In some locations, it may be necessary that the sweepers use a cutting tool to remove weeds and brush.

D. Mechanical sweeping

The majority of mechanical sweepers are mobile units that use a vacuum system to collect the waste materials. Generally, the suction action is complemented by one or more rotating brushes for dislodging residues that adhere to the surface of the road. There is a wide range of mechanical sweepers. They vary in size from very small units controlled by a pedestrian, to large mechanical sweepers mounted on a vehicular chassis. The large mechanical sweepers generally are equipped with an auxiliary engine to generate the vacuum and, in some cases, are fitted with a hose that can be controlled by an operator to pick up refuse from areas that are difficult to reach (i.e., dry leaves from drainage ditches). The operating speed of the smallest machines is about 2 to 3

km/hr, that of the largest sweepers is 10 km/hr or greater. Mechanical sweepers are efficient for the collection of light litter, fine dust, and sand from roadways.



Figure V-4. Samples of some handcarts used for sweeping in developing countries

The conditions typically found in economically developing countries limit the role of mechanical sweepers to that of simply supplementing manual sweeping. Mechanical sweepers normally are found in the large metropolitan areas of developing countries. The degree to which mechanical sweepers are utilised for a specific application should be based on thorough analyses of advantages and disadvantages, as well as the costs associated with using them as opposed to using manual sweepers. In addition, mechanical sweepers have the tendency to be extremely

maintenance-intensive units. The internal mechanisms may be damaged in the process of collecting large objects illegally disposed on the streets. Consequently, these machines should be supported by well equipped maintenance facilities stocked with a complete inventory of replacement parts.

E. Design of sweeping systems

The typical task of a manual sweeper can be divided into two main phases: 1) sweeping and loading the wastes into a storage container, and 2) transporting the full container to a transfer point where it can be emptied. In terms of efficiency, the first activity is productive while the second is not. The second activity is not productive because the time used in transporting the container for unloading is time that is not spent performing the main task of sweeping. Similarly to the waste collection phase of waste management, one of the main objectives in designing a system for manual sweeping is to maintain the total amount of time spent on transport to a minimum. This objective can be accomplished in either of two ways: 1) minimising the distance over which the collected wastes have to be transported, or 2) providing the maximum size of receptacle for the wastes that are collected.

E1. VEHICLES

One of the most appropriate solutions to maintaining the time spent on transporting wastes to a minimum is by equipping the sweeper with a cart and a sufficiently large container. The gross weight of the cart when loaded may be as much as 200 kg if the terrain is relatively level, and less in hilly districts.

In order to keep the total efficiency relatively high, the design of the cart should avoid the need to empty its contents on the ground at the transfer point. Emptying swept up litter onto the ground prior to transferring it is fairly common in several regions around the world. Besides the potential negative environmental impacts, this process results in the time-consuming task of having to load the wastes either into another container or into a vehicle. One potential solution is to design the cart such that the container can be removed and emptied by the sweeper into a temporary storage or transfer facility. Some of the most important design features of a handcart are:

- the frame should be made out of light tubular metal supporting a platform on which are placed one or more portable containers;
- the wheels should have a large diameter, with rubber tires, preferably pneumatic, using ball or roller bearings (to reduce friction);
- the containers should have a capacity of 50 to 80 L each, depending on the density of the wastes; and
- the frame should be equipped with brackets to accommodate the ancillary equipment (brooms and a shovel).

In some cases, teams of three to five individuals are used. In this situation, a vehicle with a capacity larger than 50 L is necessary. Possible alternatives include the use of animal-drawn carts or a small motor vehicle. One important criterion for this option is that the vehicle follows the sweepers relatively closely because piles of sweepings that are left unattended are likely to be scattered by traffic or wind.

E2. SCHEDULING

The planning of an effective manual sweeping system requires the classification of streets, or sections of streets, according to the required frequency of sweeping. The classification can be done based on location, level of traffic, type of surface, character of area (e.g., commercial, residential), and others. The following is a typical method of classification:

Class	Character of Street	Frequency of Sweeping
1	city centre shopping	5 x daily
2	market areas	5 x daily
3	city centre, main streets	2 x daily
4	suburban area shopping	2 x daily
5	city centre, minor streets	1 x daily
6	suburban main streets	1 x daily
7	residential streets, low-income	3 x weekly
8	residential, high-income	1 x weekly

Frequency requirements and classification systems should be determined by each municipality based on time and motion studies, and site visits. The results of the studies will indicate the length of street that a person can sweep at the required frequency. For example, time and motion studies may show that for Class 1 streets, one sweeper can be assigned between 250 and 300 m/workday, while for Class 8 the length may be as great as 5 km. On the basis of this information, a city can be divided into routes for sweepers that will result in fairly uniform workloads, despite great differences in the lengths to be covered [1].

Besides the frequency, the time of the service should be carefully defined to avoid traffic, parked vehicles, and pedestrians. Night or early morning hours, particularly in non-residential areas, seem to be the most appropriate times.

Sweepers generally work 8 hours each day. In many instances, the shift begins as early as 3:00 or 4:00 am. Most sweeping stops 5 to 6 hours later (to avoid traffic) and resumes at about 2:00 pm until the shift is completed.

E3. ORGANISATION of manual sweepers

The organisation of manual sweepers usually requires the establishment of depots. The depots can be used for managing the sweepers, for transferring the wastes that have been collected, and for providing a certain amount of comfort to the workers. The depot should include the following facilities: an office for the supervisor or foreman, an area where sweepers report to work, a parking area for the handcarts, storage for tools and equipment, a transfer area for the waste materials that have been collected, bathrooms, lockers, and a resting area.

Each depot should be located such that the distance travelled by the sweepers is kept to a minimum. If it is not possible to establish district depots, then the sweepers usually are requested to report to a central facility to collect their equipment. The sweepers are then transported to and from their respective routes. The alternative solution is to have the sweepers store their equipment in a nearby park or municipal facility so that they do not have to travel long distances to report to work. However, a supervisor would have to check each day to make sure that the employees have indeed reported to their assigned area.

Sweeping is a strenuous activity, and can be dangerous if it is incorrectly scheduled or improperly assigned. This is particularly the case when sweepers are assigned to clean roadways at night that are travelled by vehicles moving relatively fast. In addition, personnel selection sometimes is inadequate, and oftentimes older members of other solid waste management divisions (e.g., collection crews) are transferred to sweeping duties. The physical condition and age of the sweepers obviously impact the efficiency of the system.

E4. TRANSFER facility

The design of a street sweeping system, particularly in large metropolitan areas, should include transfer facilities. The transfer facilities should be located within a reasonable distance of each route. As previously indicated, the transfer facility would ideally be located in the same parcel as the district depot. This location would allow for almost continuous supervision of the site and thus avoid its use as a disposal facility for residential or commercial wastes. There are several designs that can be adopted for a transfer facility. Brief descriptions of some of the most common systems currently in use are presented. One system calls for the use of a trailer having capacities of 5 to 8 m³. This trailer would be exchanged two to four times per day. The other system requires the use of steel containers, with a capacity of about 4 to 5 m³ and exchanged four to five times per day. The third alternative relies on the use of exchangeable bins so that the sweepers can remove the full ones and replace them with an empty one at the transfer facility. This design requires that a vehicle and a crew be assigned the task of collecting the contents of the full bins at regular intervals throughout the day.

In the event that it is not possible to build or establish a transfer facility, it is possible to schedule a vehicle to collect the wastes from the sweepers. The success of this system depends upon careful routing and the development of fairly precise schedules for both the sweepers and the vehicles. The application of this system offers the advantage that the sweepers are able to devote their entire time to sweeping and, thus, can achieve a high efficiency. The system does not eliminate the need for other facilities such as rest areas and storage areas for carts.

In quest for reaching high levels of productivity, some municipalities have instituted a system whereby the sweepers are provided with plastic bags, which are used as inserts in their bins. Once filled, the bags are removed, tied, and placed in pre-arranged locations to be picked up by a collection crew. Disadvantages of this option include the relatively high cost of purchasing the plastic bags, as well as the environmental impact of disposing of the plastic.

In other locations, such as that shown in a marginal area in La Paz, Bolivia, the sweepers collect the debris on a tarp. The tarp (including its contents) is tied around the sweeper's back to move from street to street. Sweepers in the process of cleaning a street are shown in Figure V-5. Eventually, the sweepers unload the wastes in pre-determined locations for collection by conventional vehicles.

F. Litter bins

Litter bins constitute a basic requirement for the control of litter. The bins should meet the following criteria: 1) practical and inexpensive design; 2) spaced at convenient intervals; 3) emptied frequently; and 4) easy to empty, clean, and repair or replace.

F1. DESIGN of litter bins

Litter bins should be made of non-flammable materials because cigarettes are often thrown into them. Consequently, some types of plastics cannot be used for this application.

The bins should include an outer casing of standard colour and lettering, and an insert that can be easily removed for emptying. The size of the bin is a function of location, spacing, and frequency of emptying. The normal maximum size should be about 100 L. The top aperture of a litter bin should be partly covered to avoid the loss of contents in high winds and also to prevent the placement of oversize objects.



Courtesy: CalRecovery, Inc.

Figure V-5. Labourers in the process of sweeping unpaved street using bunch brooms

F2. SITING and emptying

Placement or siting of litter bins can be based on the classification of the streets (i.e., location, level of traffic, etc.). Small bins can be attached to lighting posts, street signs, or similar units. Large litter bins should be mounted on the sidewalk, although this requirement can be costly and results in obstructions. It is important to design the units so that they can be fastened to something in order to avoid theft and vandalism. At the same time, the design should be such that they can be rapidly disconnected for emptying.

Small bins could be emptied by sweepers, whereas the large ones should become part of a route for a special collection vehicle. It is important to plan the location of the bins, to keep track of their condition for repair or replacement, and to assign responsibility for their emptying.

G. Legislation

A large percentage of street litter is generated due to the lack of public education and inappropriate behaviour. Consequently, legislation can play an important role in achieving high standards of cleanliness and reducing the total workload of sweeping. The following types of legislation can make substantial contributions to the reduction of street wastes:

- Reduction in dirt and mud: Require that builders and contractors provide facilities for cleaning the tires of vehicles leaving the site to avoid deposit of mud on adjacent roads. In addition, dust control measures within the site should be enforced.
- Reduction of street litter: Establish regulations that prohibit sweeping of refuse from a house, shop, or other premises onto public pavement. In addition, establish a set of fines for dropping litter in a public place.
- Reduction in traffic wastes: Require that vehicles cover their loads. Establish a system of fines for failure to secure or cover a load.
- Control the type of vegetation that can be planted on or near the streets.
- Regulate the management of construction materials, as well as the disposal of construction and demolition debris.
- Require the maintenance of vacant lots (walls, cleanup, fencing, etc.).

It should be kept in mind, however, that most types of regulations or legislation will not be successful if they are not properly enforced, well understood, and accepted by the majority of the public. Consequently, legislation should be preceded by the introduction of a good waste management system and efficient services. In addition, the legislation should be complemented by a comprehensive public education campaign to enlist cooperation.

H. Reference

1. Flintoff, F., Management of Solid Wastes in Developing Countries, WHO Regional Publications, South-East Asia Series No. 1, World Health Organization, New Delhi, India, 1976.

Part II

Processing and Treatment

CHAPTER VI. MATERIALS RECOVERY AND RECYCLING

A. Introduction

The processing of mixed wastes and of source-separated wastes to recover materials involves a series of unit processes. The number of unit processes depends upon the degree of source separation of the wastes, as well as the types of materials to be recovered. In this chapter, waste processing facilities are discussed that process mixed municipal solid waste (MSW), source-separated materials, or both.

The nature and design of each unit process accommodate the physical and chemical characteristics of the particular materials or types of materials for which each is intended. Because most discarded materials have certain characteristics in common, basic processing principles (e.g., those pertaining to size reduction, air classification, and screening) usually are non-specific with respect to the materials in a category. However, the details of equipment design, size, degree of complexity, and cost of individual unit processes are strongly influenced by the nature and utility of the material to be recovered, and the extent and degree of source separation. The gradation also depends upon the function being served, e.g., recovery from the waste stream, readying the recovered material for reuse.

The basic types and principles of unit processes are described and discussed in the first part of this chapter. The discussion of unit processes is in the general sense. Therefore, the discussion focuses on mixed waste of which source-separated materials are a subset. Subsequently, the design of processing systems is discussed, i.e., the arrangement and sequence of unit processes to attain particular goals. This discussion includes the design of systems to process source-separated materials.

In this chapter, unit processes include both manual and mechanical processes. Mechanical processes include electromagnetic, fluid dynamic, pneumatic, and others. Of the categories of unit processes applicable to waste processing, those related to physical separation and removal from the waste stream of a particular type of material or mixtures of types of materials are the cornerstones of process design. The unit processes involving separation differ from the other unit processes in that they can be either manual or mechanical, or a combination of the two.

Resource recovery (primarily through scavenging) plays an important role in the economies of developing nations and in the economies of thousands of families. However, in most developing countries, the working conditions of scavengers are substandard. The following sections are presented in the hope that the concepts will be used to design systems in which the working conditions of the scavengers are substantially improved.

Some of the processing concepts and system designs described in this chapter have been instituted in industrialised countries and are predicated on the delivery of relatively clean mixtures of source-separated recyclable materials (e.g., containers or yard debris) to the processing location. The collection of source-separated materials and the mechanical and manual processing of them are popular and pervasive in many areas of North America. However, this method of collection and processing of wastes may not be readily instituted as a new system in developing countries, nor readily incorporated into the existing waste management systems. Economical institution of these recycling systems in North America has been a challenge as systems based historically on mixed waste collection and disposal are converted to an equal emphasis or greater emphasis placed on recycling. The problem of instituting similar recycling

programs in developing countries in an economical manner is several-fold worse due to lack of, and competition for, financial resources.

The feasibility of processing source-separated materials has a partial grounding in the need for separation of materials by the generator and the storage of the materials on the generator's premises. To fulfil this need, not only must the generator be motivated and trained in the separation of materials, but he or she must also have a separate container and space to store it. In North America, in many cases, the containers are provided at no cost to residential generators, as part of the motivational process. The supply of containers to householders in developing countries, the additional storage space requirement, and behaviour modification are among the reasons that collection and processing (the subject of this chapter) will have limited application in the short term for many developing nations.

Also confounding the feasibility and application of the processing of source-separated materials in developing nations is the circumstance that some of the highly mechanised designs presented in this chapter may be too costly and complex for many communities. However, despite the current limitations of applicability of highly mechanised designs, the concepts and designs are presented in this chapter for completeness and because the design process is relevant to less complex source separated programs, e.g., waste separated into wet (i.e., putrescible) and dry (i.e., non-putrescible) fractions. Communities in some developing countries are testing or have instituted forms of wet/dry collection and processing of wastes, e.g., Guatemala and the Philippines.

B. Manual separation

In the case of mixed waste processing, bulky items (appliances, furniture, etc.) and specified contaminants (e.g., hazardous waste) generated in some of the industrialising economies can be, and oftentimes are, manually removed from the waste prior to mechanical processing. With few exceptions, a completely manual separation of materials from mixed waste beyond this initial separation is reserved for small operations, i.e., less than 20 Mg/day. Manual separation is also applicable to the removal of contaminants from source-separated materials. (Here, "contaminants" refers to components other than the materials specified for separate collection.)

Ranges of sorting rates and of recovery efficiencies can be established that cover the usual set of operating conditions at processing facilities. Ranges for selected material categories are presented in Table VI-1.

Table VI-1. Manual sorting rates and efficiencies

Material	Sorting Rate (kg/hr/sorter)	Recovery Efficiency (%)
Newspaper ^a	700 to 4,500	60 to 95
Corrugated ^a	700 to 4,500	60 to 95
Glass containers ^b (mixed colour)	400 to 800	70 to 95
Glass containers ^b (by colour)	200 to 400	80 to 95
Plastic containers ^b (PET, HDPE)	140 to 280	80 to 95
Aluminium cans ^b	45 to 55	80 to 95

^a From a paper stream of predominantly one or two paper grades.

^b From a processing stream of predominantly metal, glass, and plastics.

Equipment involved in manual separation of materials usually includes a sorting belt or table, which contains a mixture of materials. Workers (“sorters”) are stationed on one or both sides of the belt or table. Hoppers or other receptacles for receiving removed items are positioned within easy reach of the sorters.

The design of processes that rely on manual separation requires a good understanding of basic principles of time and motion, of the composition of the waste, and of the comfort and safety requirements of the sorters. The application of simple, labour-intensive designs does not imply a disregard for safety and environmental control within the facilities.

The incorporation of manual separation into the design of resource recovery facilities is presented elsewhere in this chapter.

C. Mechanical separation

Mechanical separation usually involves the use of several types of unit processes, five of which are size reduction, screening, air classification, magnetic separation, and non-ferrous (e.g., aluminium) separation [1-5]. Table VI-2 lists unit processes relevant to separation, as well as most of the types of mechanical unit processes that have been incorporated into waste processing facilities implemented to date.

Table VI-2. Mechanical unit processes used in waste processing facilities

• Size reduction	• Glass separation
• Air classification	• Non-ferrous separation
• Screening	• Densification
• Magnetic separation	• Conveyors

The sequence of the processes for mixed waste processing varies, although either size reduction or a preliminary screening (trommel) usually is the first step. Process design is described later in this chapter. The intent of this section is to present a brief overview of the equipment; in-depth discussions can be found in Reference 1.

C1. SIZE reduction

The term “size reduction” has a number of synonyms in solid waste management, including “shredding” and “grinding”. The term “shredding” has been widely adopted in reference to size reducing mixed waste. In the case of processing source-separated materials, size reduction using granulators and grinders is sometimes practiced for certain types of plastics and for glass, respectively.

Size reduction usually is an essential step in mechanical processing of mixed wastes. The operation reduces bulky items to particles, the sizes of which are compatible with the processing equipment. Size reduction also brings about a degree of uniformity in terms of the maximum particle size of the diverse components or of particle size distribution of the incoming waste stream. This uniformity is a requirement of some mechanical sorting systems [1].

Since source-separated materials typically have a relatively small maximum particle size, a narrow particle size distribution, or both, they do not generally require size reduction prior to entering mechanical or manual sorting systems. In many system designs, some form of size reduction of the sorted materials is exercised after sorting to prepare the materials for marketing.

Coarse or primary shredding, usually to a maximum particle size of about 10 cm, is typical of many mixed waste processing facilities. Secondary and even tertiary shredding are introduced whenever a particle size significantly smaller than 10 cm is specified (e.g., the production of a refuse-derived fuel of small particle size [4]). Other circumstances that may dictate a small particle size are the recovery and processing of ferrous metals, aluminium, plastic, and glass in order to meet user specifications.

C1.1. Types of shredders

The hammermill is a type of high-speed shredder frequently used for size reducing solid waste [3,6]. Low-speed, high-torque; flail mill-type shredders; and shear shredders are also used in some cases for size reducing solid waste. However, the utilisation usually is for coarse shredding.

C1.1.1. Hammermills

Hammermills can be divided into two generic types on the basis of orientation of the rotor -- namely, horizontal and vertical. Both types have hammers that rotate within the shredder and cause particle size reduction through collision with the infeed material. The hammers may be mounted to the shredder rotor in a fixed or freely swinging manner. The horizontal swing hammermill is commonly used in mixed waste processing. Its principal parts are the rotor, hammers, grates, frame, and flywheel. Its rotor and flywheel are mounted through bearings to the frame. A set of grate bars or cages through which size-reduced materials exit the machine is held in the bottom of the frame. A diagrammatic sketch of a horizontal hammermill is shown in Figure VI-1.

In a horizontal hammermill, designed for mixed waste processing applications, the rotational speed of the rotor is usually in the range of 1,000 to 1,500 rpm. Objects to be size reduced are introduced into the infeed opening of the machine. They then interact with the hammers and each other until at least one of their dimensions reaches a size small enough for the particle to fall through the grates at the bottom of the machine.

Residence time of the material in the mill and the size distribution of the size-reduced product are largely determined by grate spacing. Other factors that affect product size distribution are feed rate, moisture content, and hammer speed (i.e., velocity of the tip of the hammer).

A diagrammatic sketch of the vertical type of hammermill is presented in Figure VI-2. As is indicated in the figure, the axis of the rotor is in the vertical position. The infeed material drops parallel to the shaft axis and is exposed to the action of the rotating hammers. It is shredded by the time it is discharged at the bottom of the machine. A photo of a commercial horizontal hammermill, including the infeed hopper, is shown in Figure VI-3, with the hammers exposed for maintenance.

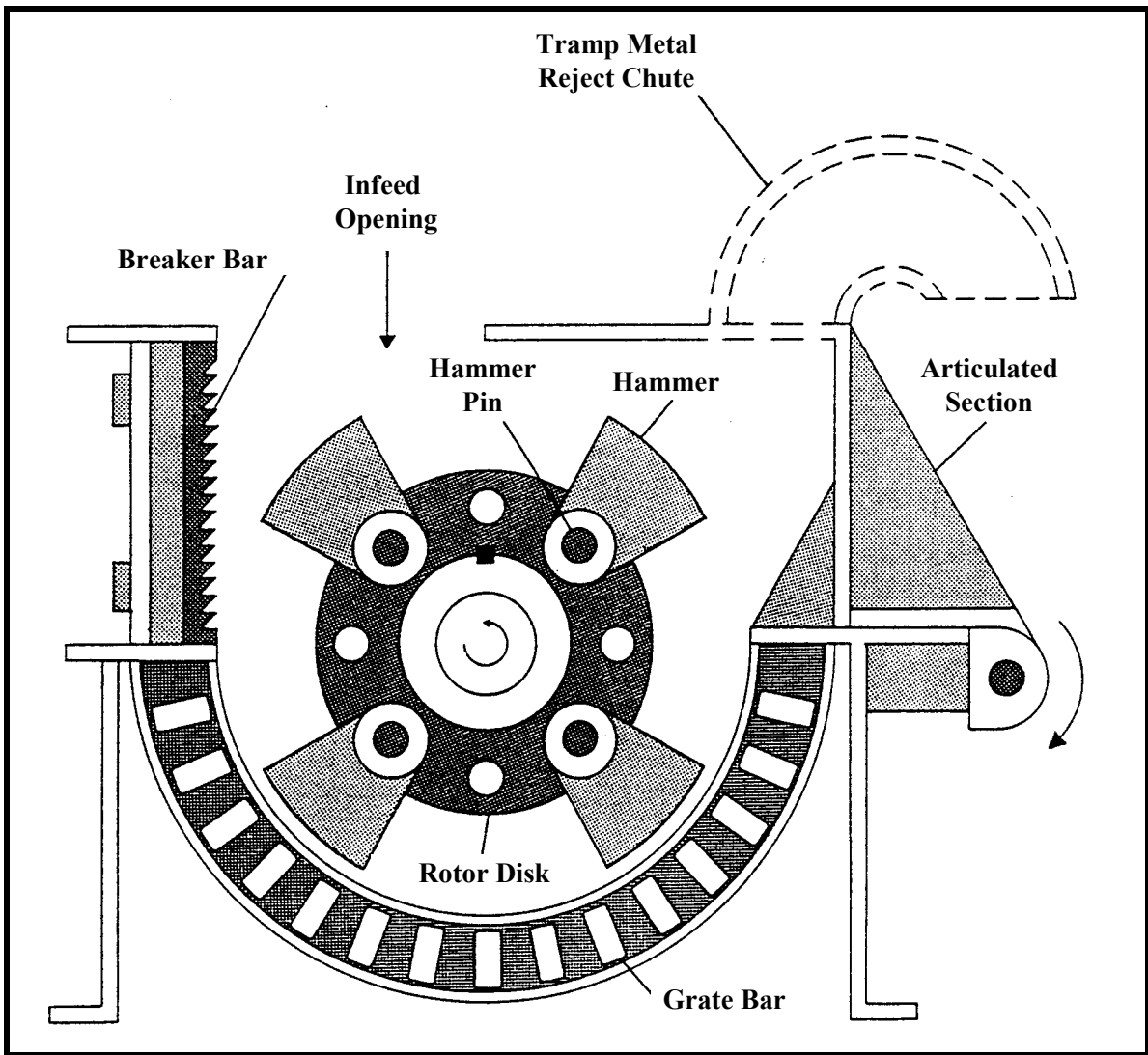

Figure VI-1. Cross-section of a horizontal hammermill

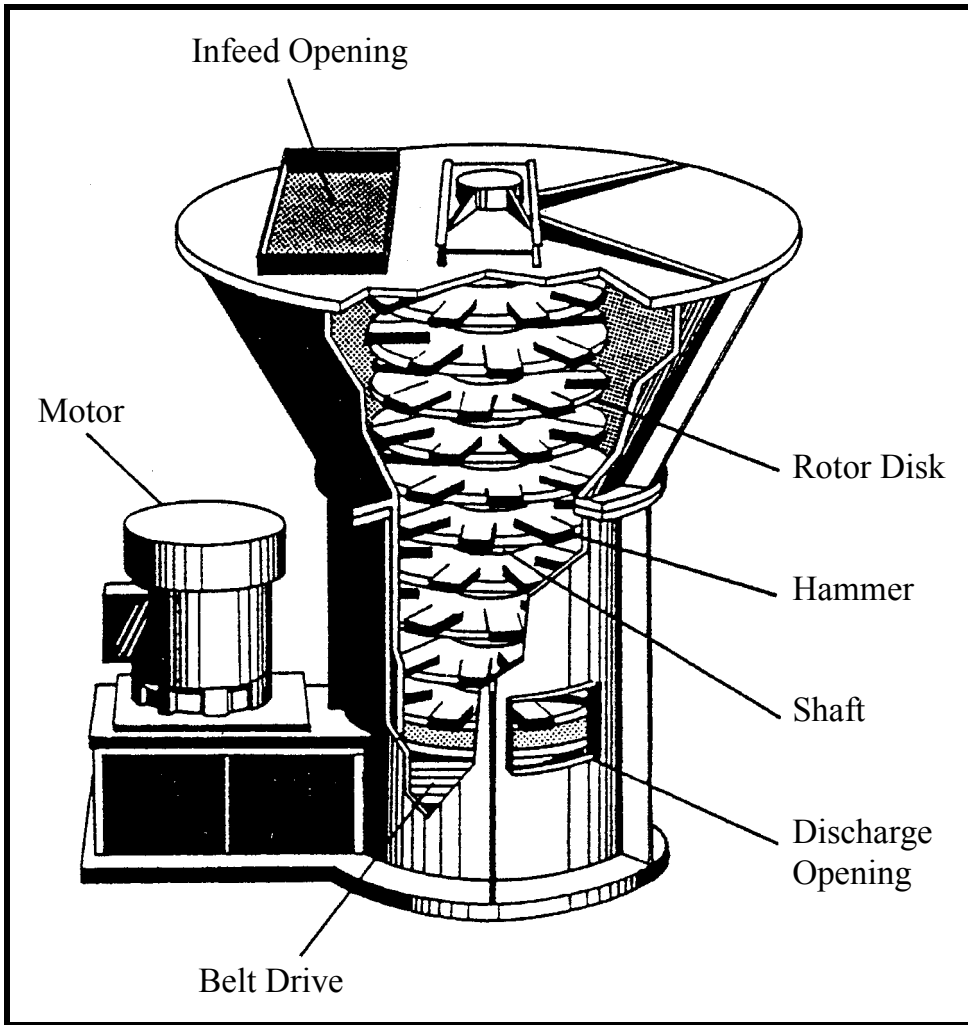

Figure VI-2. Vertical hammermill



Courtesy: CalRecovery, Inc.

Figure VI-3. Commercial horizontal hammermill (centre, shown in opened position) with feed chute (top centre) and electric motor (lower right)

Because the task performed by both the horizontal and the vertical types of hammermills is so rugged, maintenance of the shredders is an important consideration. To minimise downtime and maintenance labour, the following items should be incorporated into the overall design of shredding operations:

- equipment for accessing and servicing the rotor, hammers, and grates (if any);
- welding equipment for resurfacing hammers and other wearing surfaces, and welding facilities that include a properly designed ventilation system;
- adequate lighting for the safe performance of maintenance operations;
- moveable scaffolding or permanent walkways about the shredder to permit easy access to all pieces of equipment that may require maintenance;
- adequate space around the shredder to accommodate the removal and installation of grate bars, hammers, and other parts;
- dust control system;
- explosion and fire control systems;
- equipment for raising and lowering heavy parts such as hammers, grates, etc.; and

- an inventory of the manufacturer's recommended spare parts, including those that are required for bearing and rotor replacement or overhaul, and for the removal and reinstallation of hammers, liners, wear plates, breaker bars, and grate bars or cages.

C1.1.2. Shear shredders

As mentioned earlier, the “shear” shredder is also used to size reduce mixed waste. This size reduction device is characterised by its high torque and low rpm. A drawing of a shear shredder is presented in Figure VI-4. As shown in the figure, the unit consists of two horizontal, counter-rotating shafts. Each shaft contains cutters to tear and shear the material. In shear shredders, shear and deformation are the primary mechanisms of particle size reduction. The cutters typically operate within a range of 20 to 70 rpm. Because of the shearing action and high torque, shear shredders are commonly used to size reduce items that are difficult to shred, such as tires. They generally perform poorly when fed long, pliable, stringy materials, which tend to wrap around the cutter shafts.

C1.2. Characteristics of size-reduction processes

Size reduction of solid waste and its components is an energy- and maintenance-intensive operation. Energy requirements for size reducing some solid waste fractions in one type of hammermill shredder are indicated in Figure VI-5. In the figure, specific energy (i.e., kWh/Mg processed) is plotted as a function of degree of size reduction. Degree of size reduction (z_0) is defined as unity minus the ratio of characteristic product size (x_0) to the feedstock characteristic size (f_0) [3]. The characteristic particle size is the screen size on a size distribution curve corresponding to 63.2% cumulative weight passing. (Values of z_0 of zero and unity refer to no size reduction and infinite (though not achievable in practice) size reduction, respectively.) The curves in the figure clearly demonstrate that composition of the material influences the energy requirements for size reduction. For example, screened light fraction (primarily paper and plastic) requires more energy (on a unit basis) to achieve a given degree of size reduction than does mixed waste.

Energy requirements for the size reduction of mixed waste vary depending on the type and design of the size reduction equipment. The requirements for size reducing mixed waste to various product sizes using different types of horizontal hammermills are illustrated in Figure VI-6. The curves shown in the figure are the results of the field testing of a variety of size-reduction devices. Evident from the figure is the fact that the energy requirement increases dramatically if product sizes less than 1 to 2 cm are required. In terms of average gross power requirements for shredding mixed wastes, the requirement is calculated as the product of the specific energy requirement and the average design throughput, with an appropriate assumption to accommodate for the power needed to freewheel the machine. Average gross power requirements are shown as a function of nominal size of shredded product in Figure VI-7.

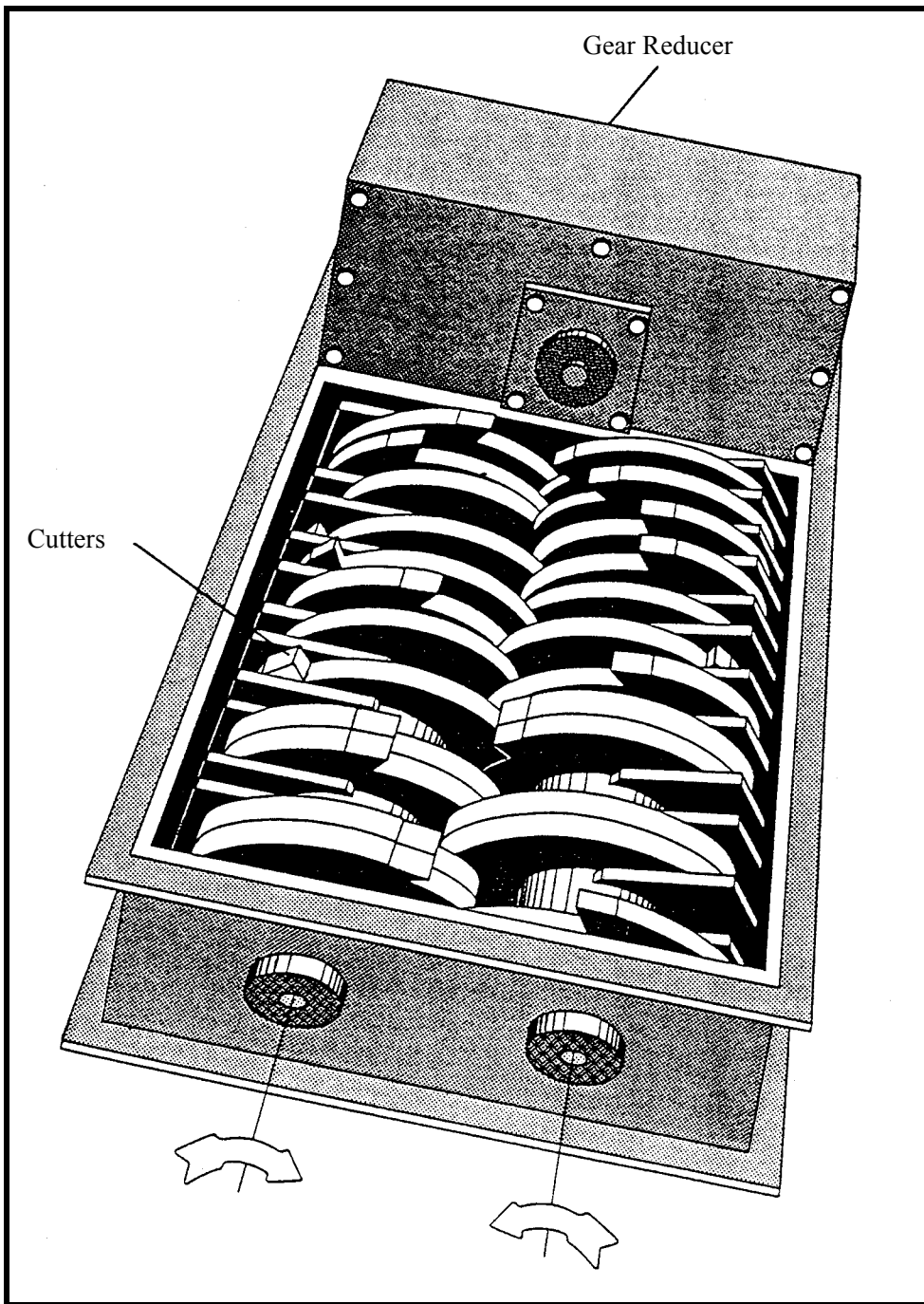
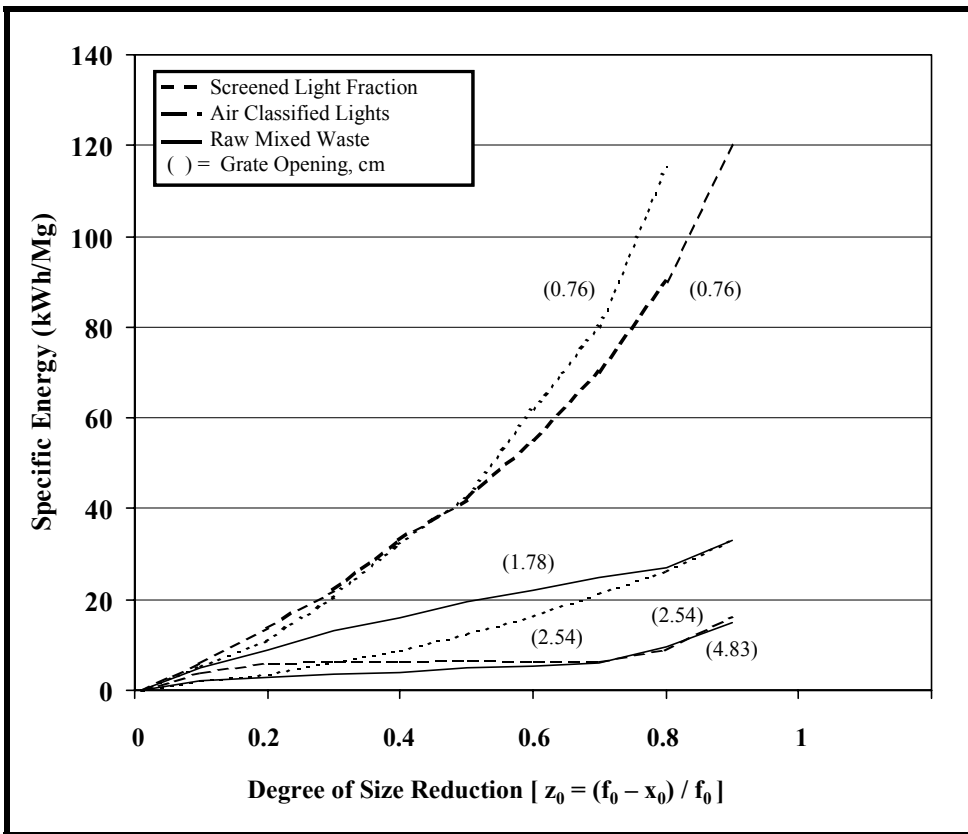
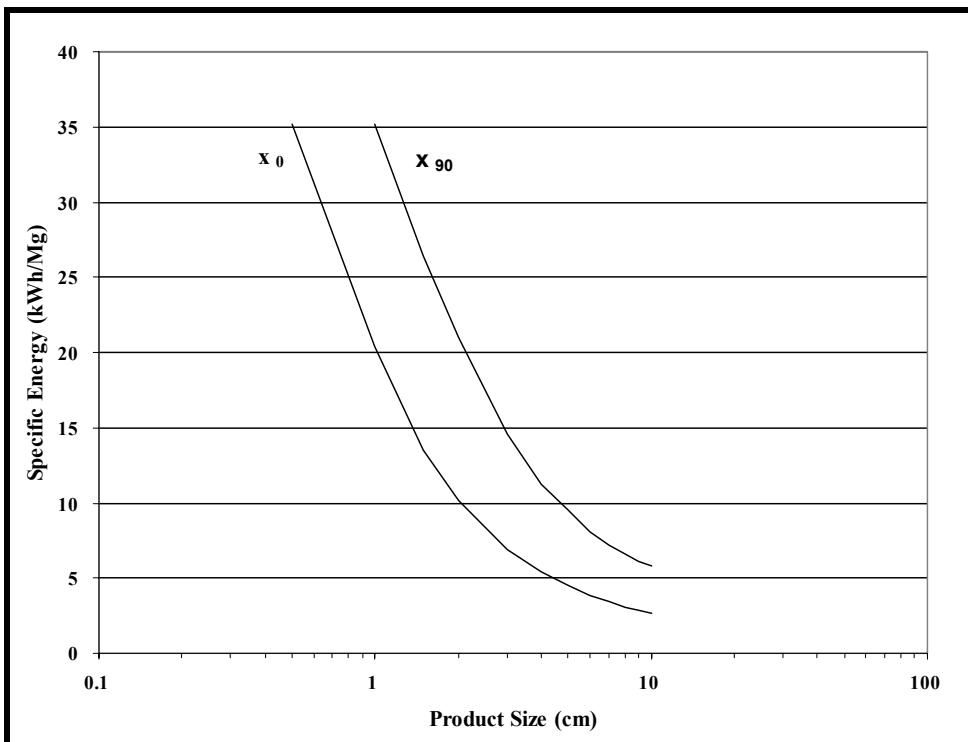

Figure VI-4. Diagram of a shear shredder



Sources: References 1, 3.

Figure VI-5. Energy requirements for various solid waste fractions using a 187 kW horizontal hammermill



Sources: References 1, 3.

Figure VI-6. Specific energy requirements (wet wt basis) for size reduction of mixed waste as a function of product size

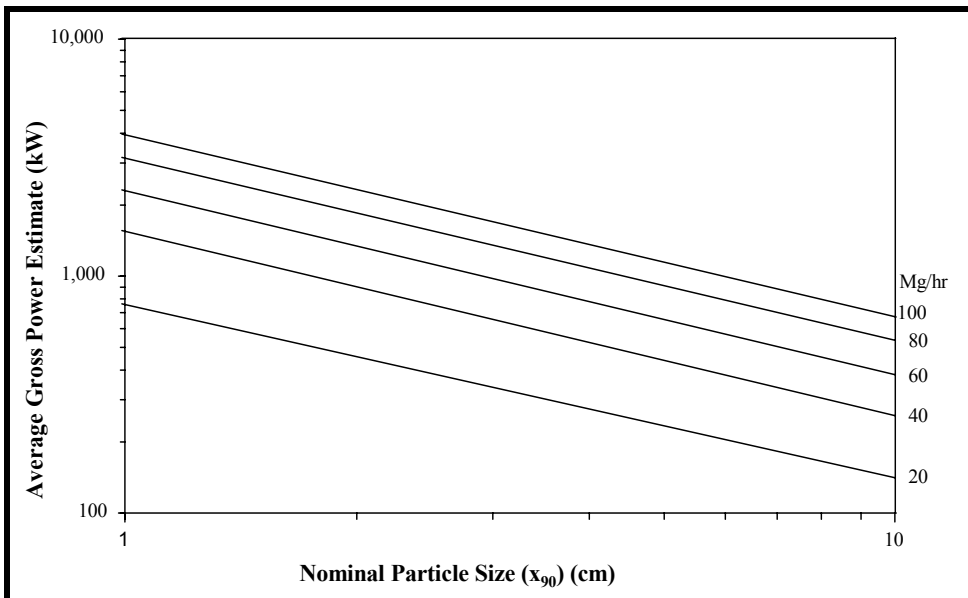

Sources: References 1, 3.

Figure VI-7. Average gross power requirements for size reduction of mixed waste as a function of throughput (Mg/hr) and nominal size of product given free wheel power/gross power = 0.1

Hammer wear represents a substantial operating element and expense of size reduction of solid waste. Wear of other parts, such as the rotor and wear plates, also represents a cost, but to a somewhat lesser degree than that associated with hammer wear. However, wear and its associated costs can be controlled if the properties of the waste, operating characteristics of the size-reduction device, and metallurgy of the hammers and other wearing surfaces are taken into consideration.

Selection of the base (parent) metal for the hammer and hardfacing metallurgy based on the properties of the feedstock and on operating conditions can minimise hammer wear. As illustrated in Figures VI-8 and VI-9, for the size reduction of mixed waste using vertical and horizontal hammermills, relatively hard surface materials have been shown to exhibit substantially less wear than softer (and often standardly supplied) commercial metallurgical formulations for base hammer material and for hardfacings.

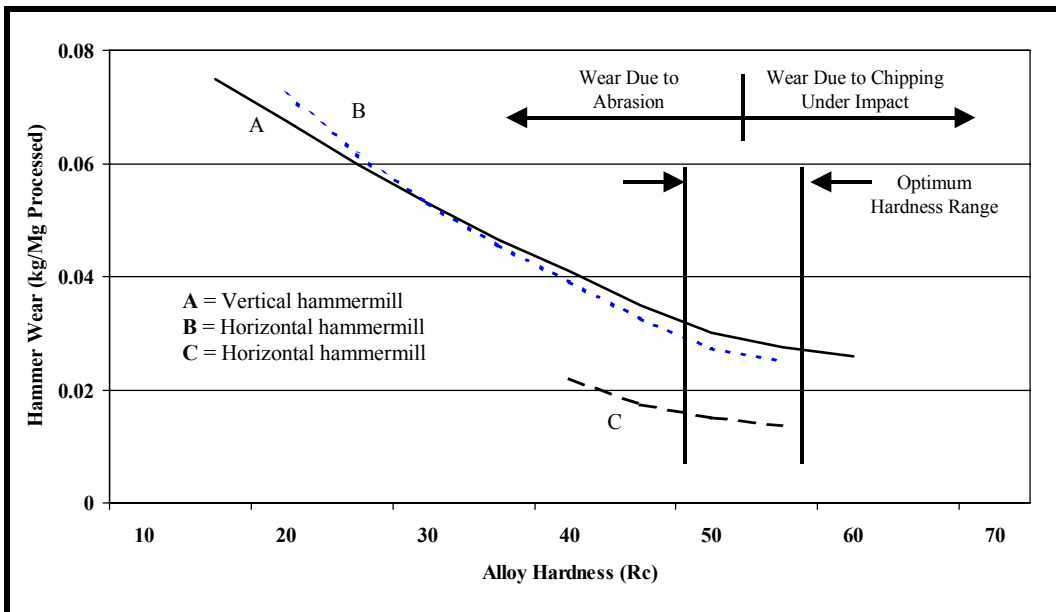

Source: Reference 3.

Figure VI-8. Hammer wear associated with size reduction of mixed waste as a function of alloy hardness (Rockwell "C", R_c)

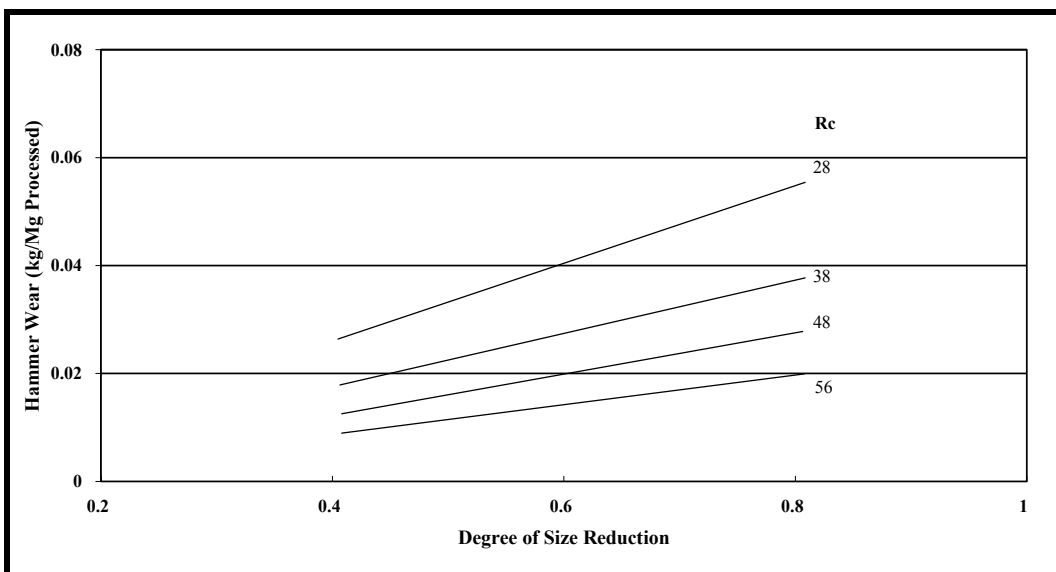

Source: Reference 3.

Figure VI-9. Hammer wear associated with size reduction of mixed waste as function of alloy hardness (Rockwell "C", R_c) and degree of size reduction

C2. AIR classification

Air classification is a process of separating categories of materials by way of differences in their respective aerodynamic characteristics. The aerodynamic characteristic of a particular material is primarily a function of the size, geometry, and density of the particles. The process consists of the interaction of a moving stream of air, shredded waste material, and the gravitational force within a confined volume. In the interaction, the drag force and the gravitational force are exerted in different directions upon the particles. The result is that waste particles that have a large drag-to-weight ratio are suspended in the air stream, whereas components that have a small ratio tend to settle out of the air stream. The suspended fraction conventionally is referred to as the “air-classified light fraction” and the settled fraction is termed “air-classified heavy fraction”. The confined volume in which the separation takes place is called an “air classifier”.

In air classification of shredded mixed MSW, the paper and plastic materials tend to be concentrated in the light fraction, and metals and glass are the principal components of the heavy fraction.

Since the density of a material (e.g., paper) is not the only characteristic of a particle that affects the air classification process, fine glass particles, by virtue of their high drag-to-weight ratio, may appear in the light fraction. On the other hand, flat, unshredded milk cartons or wet cardboard may appear in the heavy fraction. Moisture affects the separation of the various components, as a result of its influence on the density of a material. The influence can be particularly pronounced in the case of paper where its density can approach that of typically denser components, such as food waste that normally would report to the heavy fraction.

Air classifiers may be one of a number of designs. The three principal groups of designs (horizontal, inclined, and vertical) are diagrammed in Figures VI-10, VI-11, VI-12, and VI-13. All three require appurtenant dust collection, blower, separator, and control facilities [1]. Typical operating and performance characteristics of air classifiers in the production of refuse-derived fuel from mixed MSW are given in Table VI-3.

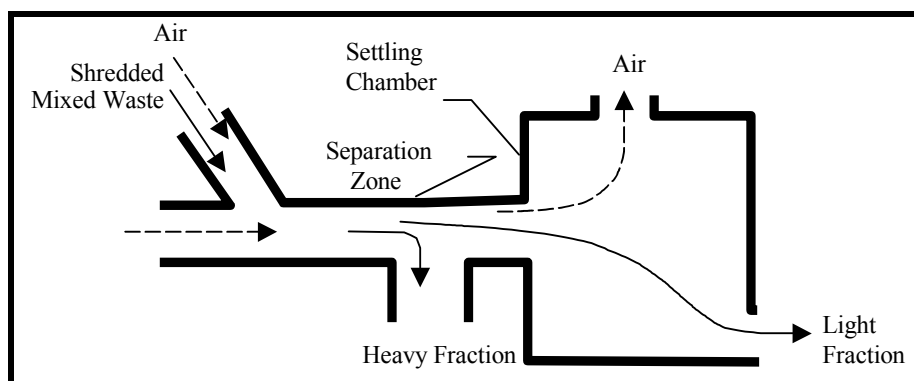

Figure VI-10. Horizontal air classifier

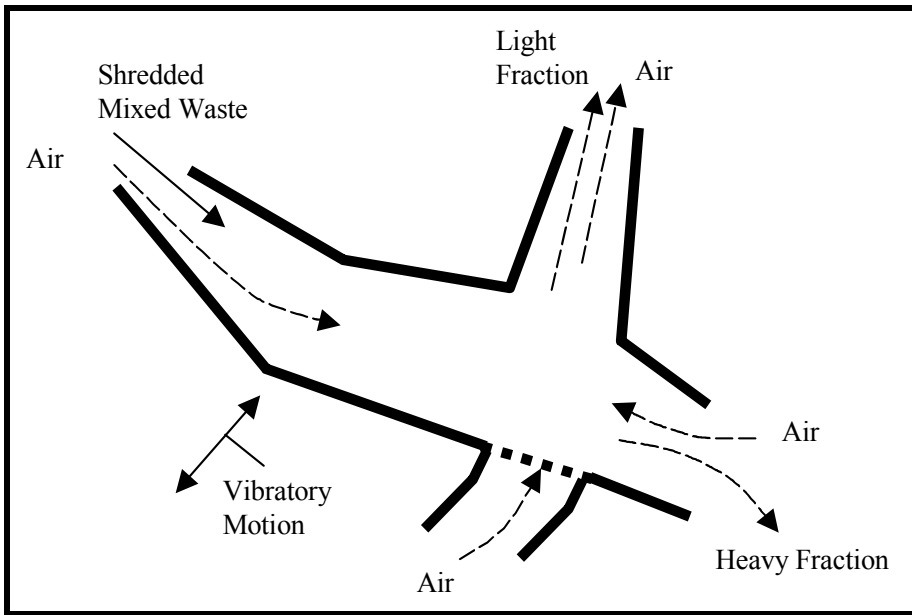

Figure VI-11. Vibrating inclined air classifier

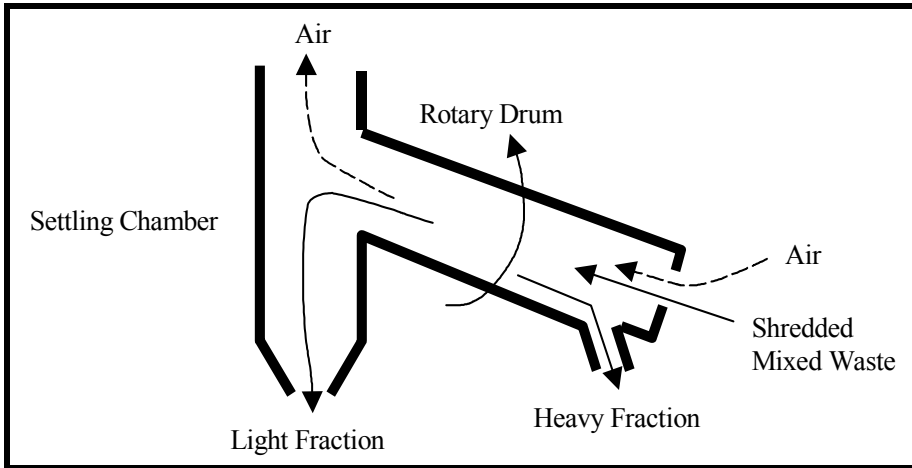

Figure VI-12. Inclined air classifier

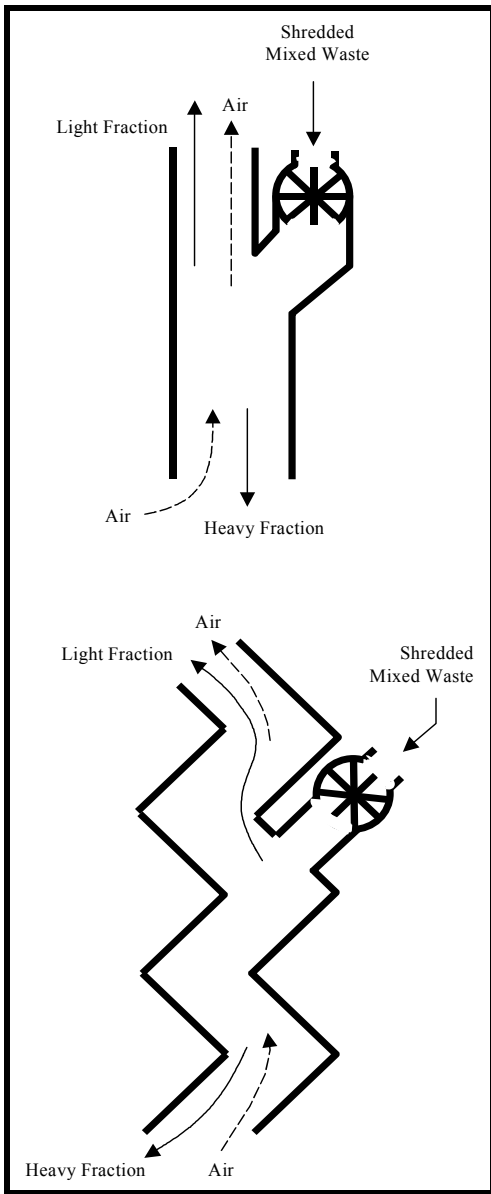

Figure VI-13. Types of vertical air classifiers

Table VI-3. Typical operating and performance characteristics of air classifiers used for recovery of refuse-derived fuel

Parameter	Typical Range
Paper and plastic in heavy fraction (%)	5 to 30
Light fraction composition (%)	
Ferrous metals	0.1 to 1.0
Non-ferrous metals	0.2 to 1.0
Fines	15 to 30
Paper and plastic	55 to 80
Ash	10 to 35
Percent of component retained in light fraction	2 to 20
Ferrous metals	45 to 65
Non-ferrous metals	80 to 99
Fines	85 to 99
Paper and plastic	45 to 85
Net specific energy ^a (kWh/Mg)	1 to 11
Column loading (Mg/m ² /hr)	5 to 40

Sources: References 1, 2.

^a i.e., excludes freewheeling energy.

The velocity of the air stream required to lift a particle in a vertical column (e.g., a vertical air classifier) must exceed a minimum value, termed the floating (or terminal) velocity. The floating velocity is a function of a number of parameters. The influence of the parameters on the floating velocity is illustrated in Table VI-4 for a variety of waste components. For a fundamental treatment of the theory of air classification, see Reference 1.

Air classification can have an advantageous effect on the output of other separation unit processes. As an example, the quality of the magnetically recovered ferrous fraction can be substantially improved by removal of residual paper and plastic in an air classifier. Similarly, a version of an air classifier can be used to clean up the mixed non-ferrous material generated by eddy current processing in the removal of non-ferrous metals. In the two applications, air classification serves respectively to: 1) remove light organic matter entrained with the ferrous metal; and 2) separate light aluminium from heavier aluminium castings, copper, bronze, etc.

C3. SCREENING

Screens are used for achieving efficient separation of particles through dependence on differences between particle sizes with respect to any two dimensions. Assuming 100% screening efficiency, the separation results in a division of the feedstock into at least two size fractions, one of which has a minimum particle size larger than that of the individual screen openings and the second, a maximum particle size smaller than that of the openings. The first group is retained on or within the screen. This fraction is termed “oversize”, and its constituent particles become “oversize particles”. The second fraction passes through the openings and accordingly is termed “undersize”, and its constituent particles become “undersize particles”.

Screens may also be used to separate the feed stream into streams corresponding to three or more size classes. In such cases, several screen surfaces of different size openings are fitted in series in the frame of screening equipment.

Table VI-4. Typical floating velocities for various components of shredded mixed waste

Waste Component	Moisture Content (%)	Density (kg/m³)	Particle Geometry	Typical Floating Velocity (m/sec)
Paper				
Newsprint	10	560	Flake	0.9
	40	840	Flake	1.1
Ledger	10	758	Flake	1.1
	40	1,138	Flake	1.3
Corrugated	10	192	Flake	3.5
	40	320	Flake	4.4
Linerboard	10	650	Flake	1.8
	40	974	Flake	2.2
PE coated	10	746	Flake	3.0
	30	1,066	Flake	3.5
Plastic				
PE film	3	912	Flake	4.4
PE rigid	3	912	Irregular	8.7 to 15.3
Wood				
Lumber	12	480	Splinter	2.2 to 8.5
	30	603	Splinter	2.5 to 9.9
Plywood	12	552	Flake	5.9
Textile	5	242	Flake	2.3
Rubber	3	1,773	Irregular	18.0
	3	1,773	Flake	8.4 to 12.0
Aluminium				
Sheet	0	2,688	Flake	2.4 to 4.6
	0	2,688	Irregular	9.8 to 44.2
Can	0	58	Cylinder	6.6
Ferrous				
Sheet	0	7,840	Flake	4.0 to 5.9
	0	7,840	Irregular	16.6 to 75.0
Can	0	144	Cylinder	9.9
Glass	0	2,400	Irregular	2.9 to 22.5

Predominantly three types of screens are employed by the solid waste industry for sizing particular fractions of processed and unprocessed mixed waste and of source-separated materials. The three types are the vibratory flat bed screen, the disc screen, and the trommel screen. Of the three, the trommel has proven to be quite effective and efficient for processing mixed waste and other mixtures where large, flat particles (e.g., paper) and aggregate-type particles (e.g., crushed glass) must be separated. Hence, it is a commonly used type of screen. In the case of size classification of source-separated materials, vibratory flat bed and trommel screens are feasible and used in a number of facilities. The size classification of waste feedstocks that possess components with similar particle size distributions or that contain materials that can sandwich smaller particles and, therefore, impede their flow through the apertures of the screen surface requires tumbling in order to be efficient.

C3.1. Trommel

The trommel is a downwardly inclined, rotary, cylindrical screen. Its screening surface is either a wire mesh or a perforated plate. An illustration of a trommel screen is presented in Figure VI-14. The trommel can be used to process raw mixed waste prior to size reduction (“pre-trommeling”), as well as to process shredded mixed waste (“post-trommeling”). With either option, the characteristic tumbling action imparted by the rotating screen results in efficient separation [7,8].



Courtesy: The Heil Company.

Figure VI-14. End view of a trommel screen

The tumbling action efficiently separates adhering items, “sandwiched” undersize particles, or an item from its contents. The tumbling action is essential in the screening of mixed waste because of the need for a high degree of screening efficiency, coupled with a minimum of screening surface. An example of the greater screening efficiency achieved by a trommel screen, in comparison to that of a vibratory flat bed screen, is given in Figure VI-15.

When installed ahead of the primary shredder, the trommel can be designed to achieve one or more of the following four objectives: 1) the removal of most of the fine abrasive inorganic materials, such as dirt and stones; 2) the tearing and opening of bundles of paper and bags of waste; 3) a coarse separation of metal, glass, and plastic containers from corrugated, ledger, and newspaper; and 4) elimination of the passage of materials through the shredder that already meet the maximum particle size specification of the shredder discharge product. In meeting the latter objective, wear on shredder components and size reduction energy requirements are minimised, and a primary shredder of smaller capacity can be used in the system. If installed downstream of the primary shredder, the trommel can be designed to remove pulverised glass, dirt, heavy food particles, and other organic materials; an important function for certain recovery applications. Because the shredded particles of mixed waste generally have lesser weights than those of raw mixed waste, a smaller and lighter trommel can be used than if raw mixed waste is screened.

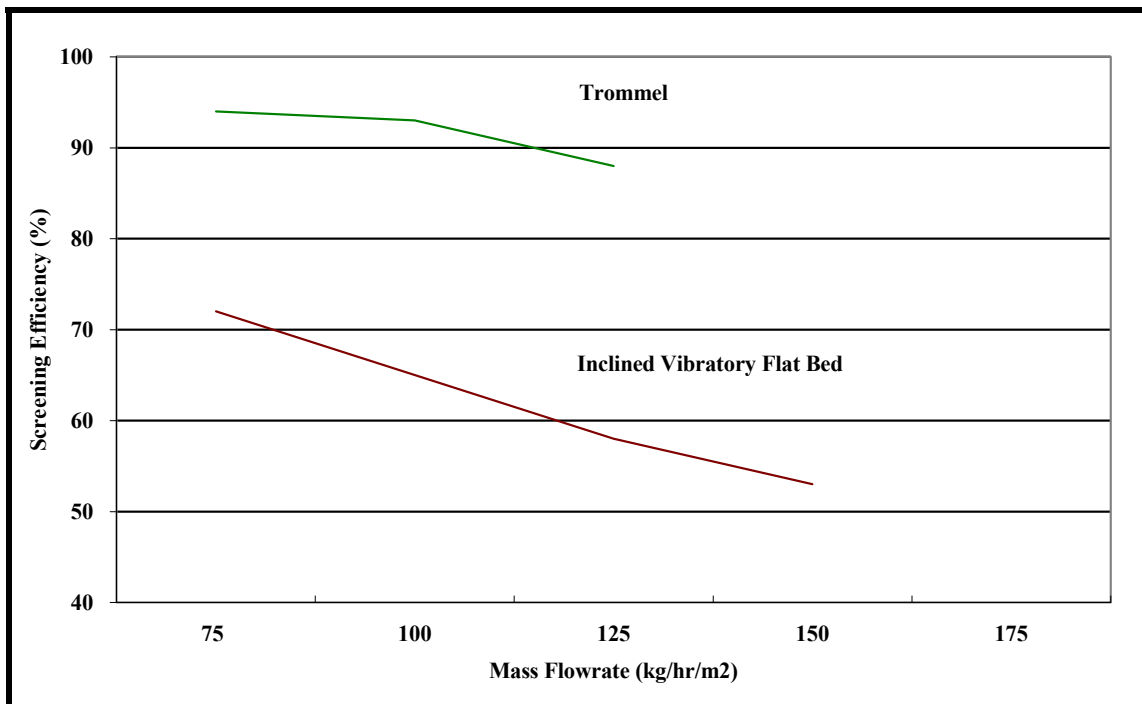

Sources: References 1, 7.

Figure VI-15. Screening efficiency of two types of screens processing air classified light fraction

C3.2. Disc screen

Disc screens have been employed in many waste processing facilities. The predominant applications to date are effecting the separation of inorganic materials from refuse-derived fuel fractions, from paper materials, or from wood waste. A disc screen consists of a number of evenly spaced shafts in a horizontal plane fitted with discs such that their interference patterns form openings through which the undersize material will flow. All of the shafts rotate in the same direction, thus carrying infeed material from one end of the screen to the other. The discs can be of a number of geometries (e.g., circular, oblong) in order to impart tumbling of the particles. The tumbling is less rigorous than that obtainable with a trommel screen. An illustration of a disc screen is shown in Figure VI-16.

C4. MAGNETIC separation

Magnetic separation is a process used to segregate magnetic (i.e., ferrous) metal from a mixture of different types of materials, e.g., mixed waste or commingled metal, glass, and plastic containers [1,2,8]. The process is technically simple and of relatively low cost.

Magnets used in the separators may be either permanent or electromagnetic. Magnetic separators are available in three configurations -- namely, magnetic head pulley, drum, and magnetic belt. The magnetic head pulley-conveyor consists of a magnetic pulley that serves as the head pulley of a conveyor. In its operation, the material to be sorted passes over the magnetic pulley, and the magnetic particles are pulled part way around the rotating pulley while the non-magnetic particles follow a separate unrestrained ballistic path.

In the case of the drum magnet, the electromagnetic assembly usually is mounted inside the rotating drum where the assembly remains stationary. The drum magnetic assembly can be installed in either overfeed or underfeed applications (as illustrated in Figure VI-17).



Courtesy: Rader Resource Recovery, Inc.

Figure VI-16. Disc screen

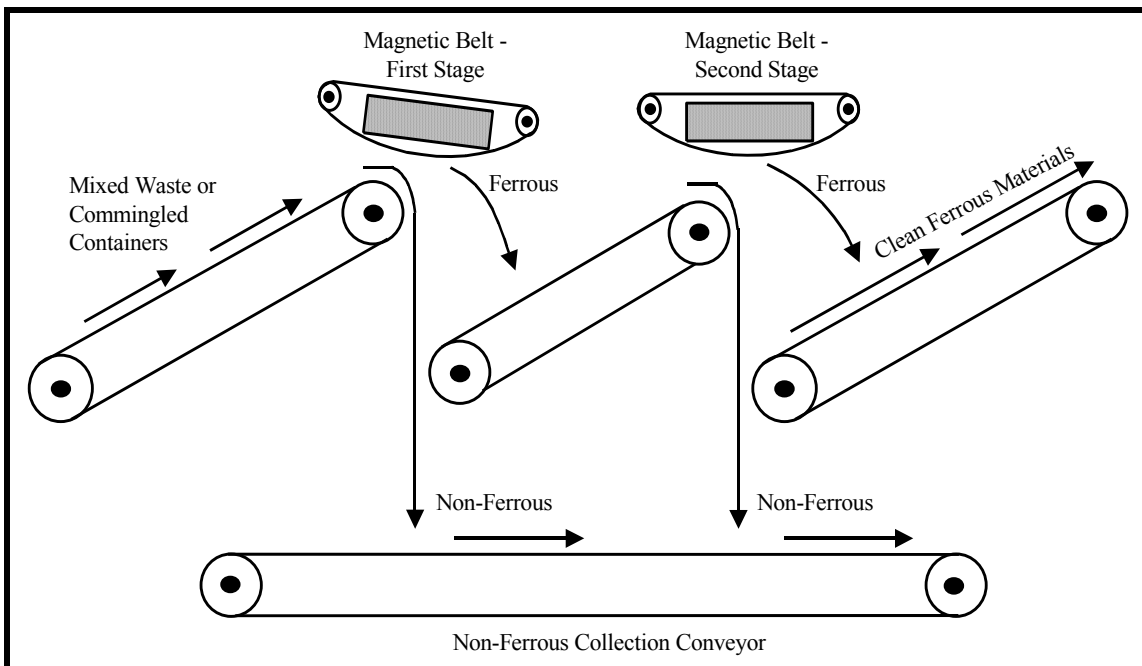

Figure VI-17. Multiple stages of magnetic separators



Courtesy: CalRecovery, Inc.

Figure VI-18. Magnetic belt

The magnetic belt consists of a stationary magnetic assembly that is mounted between the head and tail pulleys. In contrast to the in-line configuration that applies to drum and magnetic head pulleys, magnetic belt pulleys can be positioned in-line or perpendicular to the flow of material, although the in-line configuration generally is the more efficient. Magnetic belts perform their task by attracting the magnetic particles and carrying them away against the belt surface while the non-magnetic particles fall away under the influence of gravity in another direction. An example of a magnetic belt is shown in Figure VI-18.

In terms of yield, the recovery of magnetic metal per unit weight of magnetic metal in shredded mixed waste typically is about 80% for a single-stage of magnets. The recovery of ferrous metals from the heavy fraction separated through air classification of shredded mixed waste generally is on the order of 85% to 90%. The reason for the higher rate of recovery in the latter case is that the majority of the light contaminants (e.g., paper and plastic), which normally comprise a substantial concentration in mixed waste, are removed during air classification. This reduces substantially the burden depth of the process stream and subsequently reduces carryover of ferrous particles in the non-ferrous heavy stream during magnetic separation. Higher rates of recovery can be achieved through the use of multiple stages of magnetic separation, as shown in Figure VI-17.

The quality of ferrous scrap recovered from mixed waste by a magnetic separator placed directly downstream of primary size reduction equipment generally is inferior to that of scrap removed by a magnetic separator located downstream of other operations designed to remove light contaminants. The reason for the improvement in quality is that paper, plastic, rags, and other contaminants that otherwise might cling to or be entrapped by the ferrous scrap or be carried over with the metal, would have been removed by screening and air classification prior to the exposure of the mixed waste to the magnet. If a single magnetic separator is used on a stream containing a substantial concentration of light materials, an air classifier usually will be required to remove paper and other light materials from the ferrous fraction in order to recover a marketable product.

C5. ALUMINIUM and glass separation

Several technologically complex processes have been utilised or proposed for non-ferrous and glass separation. The predominant non-ferrous metal represented in the waste stream is usually aluminium, and it is oftentimes a target for recovery. In the case of aluminium, heavy media and eddy current separation are possibilities. Of these two processes, eddy current separation is, at present, the more commercially feasible. Separation is brought about by the ejection of aluminium particles (and potentially other non-ferrous metals, if present) from a moving waste stream due to the force exerted on the metallic particles as they pass through an electromagnetic flux generated by the equipment. Contamination of aluminium recovered by the eddy current separator by other non-ferrous (ONF) metals is primarily a function of the concentration of ONF in the feedstock stream, size distribution of the types of materials in the feedstock stream, and the operating conditions of the eddy current separator.

Froth flotation and optical electronic sorting have both been used for glass removal. Neither of these technologies has been shown to be economical. Efficient and highly productive mechanical processes for separation of aluminium and of glass (by colour or mixed colour) are costly and complex [1].

C6. DRYING and densification

Thus far, drying has been utilised at only a few facilities that recover a processed fuel, e.g., fluff refuse-derived fuel or densified refuse-derived fuel. The objective of drying is to provide a higher quality waste-derived fuel. Because of the cost of the process and the limited success attained, drying has not generally been included in recent material processing systems. Densification, baling in particular, has been effectively used to reduce landfill requirements, and to cut transportation and disposal fees. (Tipping fees, in some cases, are charged by the cubic meter and not by weight.) Because of the relatively limited processing capacity and the need to process the feedstock to an exceedingly fine particle size, densification by way of briquetting, pelletising, or cube formation apparently is impractical for all but a few operations. Densification is used primarily for the production of a solid fuel from the light (i.e., combustible) fraction of MSW or from different paper fractions. Such fuels have been termed densified refuse derived fuel, or dRDF. An example of equipment to produce dRDF is shown in Figure VI-19. Densification also is used to package aluminium beverage containers and steel beverage and food containers for certain market.

D. Design of processing facilities

D1. GENERAL design concepts

The design of a successful processing facility should incorporate certain concepts, among which are the following: 1) reliance upon proven technologies (appropriate to the particular location) and fundamental principles of engineering and science; 2) consideration given not only to the characteristics of the waste from which the desired materials are to be recovered, but also to the specifications of the recovered materials; 3) preservation or improvements to the quality of the recovered material; 4) processing flexibility to accommodate potential future changes in market conditions; 5) recovery of the largest percentage of materials that is feasible given the conditions that apply to the recovery project, and 6) protection of the workers and of the environment.

Design concepts pertaining to operation include provisions for: 1) receiving mixed waste, source-separated materials, or both; 2) accommodating the various types of vehicles that deliver wastes to the facility, as well as the frequency of the deliveries; 3) relying upon manual labour when

current automation technology is lacking, unproven, or marginally effective; and 4) storing of materials.

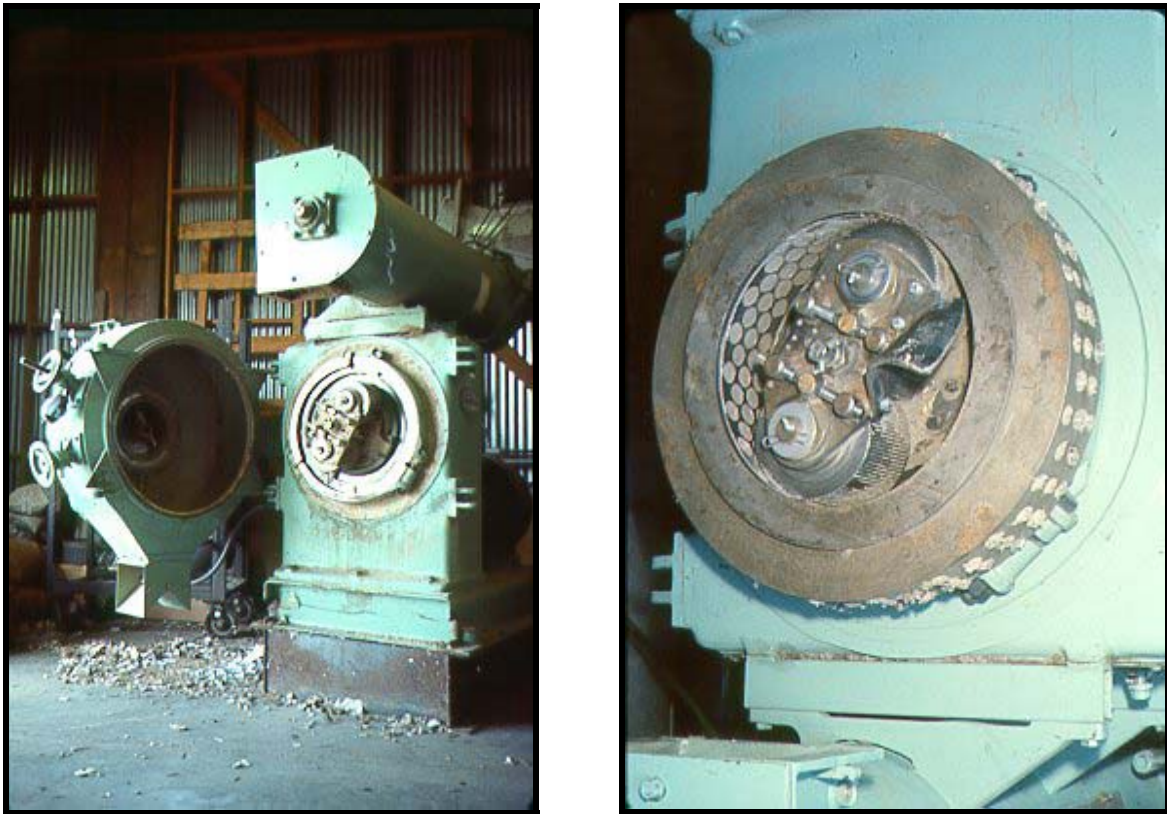

(Courtesy: CalRecovery, Inc.)

Figure VI-19. Pellet mill used to produce dRDF (left photo shows equipment with extrusion die removed; right photo shows closeup of roller and die assembly)

Additional operation-oriented features are: definition of throughput capacity (present and future), required availability, and desired redundancy for the system. Throughput, availability, and redundancy are critical factors in the design of any unit process or processing system. Unfortunately, however, many waste processing facilities are designed and built without due consideration of these factors.

- **Throughput:** A good understanding of the quantity and composition of the feedstock to be delivered to the facility allows for determining the size, type of equipment, hours of operation, quality of recovered products, expected revenue, and other items.
- **Availability:** Availability is the percentage of time that a particular piece of equipment (or system) is “available” to perform the task for which it is intended. In the simplest terms, the availability of a process system is the product of the availabilities of each piece of processing equipment of which the system is composed. The importance of analysing the availability of a process design cannot be overemphasised -- particularly in waste processing facilities, which are maintenance-intensive. Usually, waste processing facilities cannot be easily shut down without upsetting the solid waste management system.
- **Redundancy:** Redundancy is related to availability. Redundancy of equipment is one method of increasing system availability. A certain amount of redundancy is usually built into a design to allow for stoppages (scheduled or unscheduled) in a particular piece of equipment or processing line. Although redundancy is required to maintain continuity in a particular

process, it has the effect of increasing capital costs. Consequently, redundancy in waste processing design often is ignored or minimised in order to maintain costs to a minimum.

Low availability and the lack of redundancy are two factors that have played key roles in the closure or inefficiency of waste processing facilities throughout the world. These factors are particularly important in waste processing due to the lack of reliable, quantitative information on the performance of equipment and the systems used.

A fundamental consideration in the overall design of a processing facility is whether or not the input municipal solid waste (MSW) is mixed (not separated prior to collection) or is source separated. Obviously, mixed MSW contains many types of materials (i.e., components) with varying particle size distributions. Conversely, source-separated wastes refer to wastes that have been separated into individual components (e.g., tin cans) at the site of generation and are kept separated throughout collection and transport. In practice, the term has been broadened to include components in commingled form, i.e., specified mixtures of a few individual categories. An example of a commingled group is one consisting of metal and glass containers, or one composed of metal, glass, plastic containers, and paper grades.

In a properly implemented program, source-separated recyclable materials are accompanied by less contamination in the form of food wastes and other objectionable materials than would accompany them in municipal mixed waste. It follows that, if all other conditions are similar, the lower degree of contamination significantly raises the percentage recovery of materials in the form of products and raises the quality of the products.

A variety of material categories serve as feedstocks for processing facilities designed to deal with source-separated materials. Individual categories (e.g., tin cans or glass containers) may be delivered singularly or in commingled forms. The design of the physical layout of the processing facility and selection of equipment is primarily a function of: 1) the quantities, composition, and properties of each of the feedstock streams that will enter the facility; and 2) the market specifications of the recovered products. Other design considerations include the potential need for, and the benefits of, processing flexibility. Flexibility includes the provision of producing more than one marketable form for a particular material type, e.g., baled and granulated forms of high-density polyethylene (HDPE). An illustration of applicable design considerations and processing alternatives for a variety of source-separated processing facility feedstocks, whether delivered in individually segregated or various commingled forms, is provided in Table VI-5.

Several unit processes can be used for processing of materials, as discussed earlier in this chapter. The variety of processing equipment reflects the variety of the forms of the feedstocks, of feedstock composition, and of market specifications that may apply to a particular project. Equipment is also required for environmental control, for processing control, and for documentation (e.g., weigh scales), as illustrated in Table VI-6.

The selection of unit operations, operating conditions, and processing line configurations requires careful analysis in terms of recovered product qualities and waste diversion (from landfill) criteria [23]. Processing may support recovery of materials for re-manufacturing (e.g., container glass and aluminium beverage containers), for use as a solid fuel (e.g., refuse-derived fuel), or both. Additionally, processing may be required to reduce the organic content of wastes that require land disposal, e.g., in Europe [21,22].

The processing of materials, and the recovery and preparation of end products to market specifications, is a complex undertaking and requires a substantial effort if high efficiency and production rates are the system design objectives. One of the reasons is the sheer number of

factors that must be considered and optimised. A partial listing of important factors and their implication to processing system design is given in Table VI-7.

Table VI-5. Typical design considerations and processing alternatives for facilities that process source-separated feedstocks

Collection Category	Basic Feedstock	Tipping Floor	Sorting Conveyor (or room)	Interim Storage	Preparation for Shipping	Finished Product Storage
Newspaper	Newspapers, Kraft bags, rotogravure, some coated grades	Hand pick contaminants	Hand pick contaminants	Accumulated in bins or bunkers before being selectively conveyed to baler	Baler	In stacks or bales on processing floor or stacked in transport vehicle
			Infeed Conveyor			
Commingled containers	Tin, bi-metal, and aluminium cans; plastic and glass containers; contaminants	Hand pick contaminants	Hand pick contaminants; magnetic separator for ferrous	Broken glass recovered as undersize mixed-colour fraction	Separate aluminium and plastic from glass	
	Sort Method	Bale	Biscuit	Shred	Air Classify	Store
Ferrous (bi-metal)	Magnetic and/or manual separation of tin cans and bi-metal (if required)	With baler	With can densifier	With can shredder	NA ^a	Convey shredded cans to outside transport vehicle, or bales or biscuits in stacks on processing floor, outdoors, or in a transport vehicle
Ferrous (tin cans)	Magnetic and/or manual separation of tin cans and bi-metal (if required)	With baler	With can densifier	With can shredder	To remove labels	Convey shredded cans to outside transport vehicle, or bales or biscuits in stacks on processing floor, outdoors, or in a transport vehicle

Table VI-5. Typical design considerations and processing alternatives for facilities that process source-separated feedstocks (cont.)

Aluminium	Eddy current apparatus separates aluminium from non-metals	Flatten With can flattener	Transfer Pneumatically convey to outside transport vehicle	Bale With baler	Biscuit Compress in a densifier	Store On processing floor, outdoors, or in a transport vehicle
Collection Category	Basic Feedstock	Interim Storage	Perforate	Bale	Store	
Plastic (PET)	Pneumatic and/or manual sort of PET	In overhead hoppers	Drop from overhead hopper or pneumatically convey to perforator	Mechanically or pneumatically from perforator to baler	On processing floor or outdoors in transport vehicles	
Plastic (HDPE)	Manual sort of HDPE	In overhead hoppers	Drop from overhead hopper or pneumatically convey to granulator	Mechanically or pneumatically convey to baler	Granulated in gaylords on processing floor before loading into transport vehicle, baled in stacks on processing floor or outdoors in transport vehicles	
Glass	Optical automatic sort or hand sort by colour	With glass crusher	Remove paper labels, metal lids, and other contaminants by screen and/or air classifier		In bunkers for loading by front-end loader, or in overhead bins for selectively conveying to transport vehicles	
Plastic (HDPE and PET)	Manual sort of each type of resin					

Sources: References 9, 10, 18.

^a NA = not applicable.

Table VI-6. Specific types of fixed equipment applicable to waste processing facilities

Material Handling Equipment
Belt conveyor
Screw conveyor
Apron conveyor
Bucket elevator
Drag conveyor
Pneumatic conveyor
Vibrating conveyor
Debugger
Separating Equipment
Magnetic separator
Eddy current device (non-ferrous separator)
Disc screen
Trommel screen
Vibrating flat bed screen
Travelling chain curtain
Air classifier
Size Reduction Equipment
Can shredder
Glass crusher
Plastics granulator
Plastics perforator
Densification Equipment
Can densifier/biscuiter
Can flattener
Baler
Environmental Control Equipment
Dust collection system
Noise suppression devices
Odour control system
Heating, ventilating, and air conditioning (HVAC)
Other Equipment
Fixed storage bin
Live-bottom storage bin
Floor scale for pallet or bin loads
Truck scale
Belt scale

Table VI-7. Some factors affecting process design and efficiency

Factor	Design Implication
Market specifications	Loosely constrained specifications generally result in percentage yields that are higher than those for tightly constrained specifications for the end products.
Contamination of incoming materials	The greater the degree of feedstock contamination, the lower the percentage yield of product for a given set of end product specifications under similar operating conditions.
Glass breakage	Broken glass containers are more difficult to sort than unbroken containers.
Relative quantities per sorter	Over a given period of time, the greater the number of units and/or components a sorter must separate from a mixture, the greater the rate of error and, conversely, the lower the recovery rate.
Equipment design	The proper design of conveyors and separation equipment for the types and quantities of materials handled directly affects recovery rates. For example, an excessive bed depth of commingled containers on a conveyor can substantially limit the manual or mechanical recovery efficiency of any given component.
Human factors	Providing a clean, well lighted, well ventilated environment in which to work with particular attention to worker training, safety, health, and comfort are conducive to high recovery rates.

Waste processing facilities, particularly in economically developing countries, typically involve substantial manual sorting as primary and secondary separation operations. Manual sorting obviously is a labour- and time-intensive activity. In fact, in industrialised countries, a substantial portion of a facility's operating costs can be associated with sorting labour. Sorting rates and efficiency are influenced by a number of factors, including the type and form of material to be segregated and degree of contamination and of commingling.

In addition to labour for sorting, the staff of processing facilities usually includes operators of fixed and rolling equipment and maintenance personnel. Sorting labour can be a substantial portion of the operating staff, sometimes 50% to 75% in those systems designed to recover several types of materials. Processing facilities also require office staff that may include one or more of the following: plant manager, weigh master, bookkeeper, clerk, custodian, etc. Typical staffing levels for facilities that process source-separated materials are illustrated in Table VI-8 for throughput capacities of 500, 1,000, and 2,000 Mg/wk.

Special consideration should be paid to space allocation for storage of materials during facility design. Storage areas include those allocated for tipping floor storage of delivered materials and for storage of recovered end products. The usual tendency is to underestimate space requirements, with the potential results being: 1) loss of processing flexibility; and 2) unprotected storage of materials (outdoors) because of lack of adequate storage space indoors. Some general guidelines for space allocation for facilities that process source-separated materials are presented in Table VI-9. The guidelines are not meant to be a substitute for a detailed engineering analysis that considers actual throughputs and other project-specific criteria.

Table VI-8. Typical staffing requirements for facilities that process source-separated materials

Personnel	Facility Throughput (Mg/wk)		
	500	1,000	2,000
Office	2 to 3	3 to 4	5 to 6
Operational			
Foreman/machine operator	1 to 2	2 to 3	3 to 4
Sorters	8 to 16	10 to 18	15 to 26
Forklift/FEL operators	2 to 3	3 to 4	5 to 6
Maintenance	1	2	4
Totals	14 to 25	20 to 31	32 to 46

Table VI-9. Floor area guidelines (m²) for facilities that process source-separated materials

Area Use	Facility Throughput (Mg/wk)		
	10	100	500
Tipping floor			
2-day capacity	300	750	3,000
Processing	600	2,000	5,000
Storage			
7-day capacity	100	875	3,500
14-day capacity	175	1,750	7,000

Facilities that process source-separated materials can easily recover 80% or more of the marketable grades of metals, glass, plastics, and paper from an input consisting of commingled and segregated components and the incidental contamination that typically accompanies the targeted materials. On the other hand, facilities that process mixed waste usually recover only about 10% to 25% of the wastes in the form of marketable materials. (The composition of the wastes and the available markets for secondary materials determine the feasible overall recovery percentage.) However, the addition of processing operations to produce refuse-derived fuel (RDF) or a feedstock for composting can increase the recovery capability to 75% to 85%.

Two designs have been selected as examples of the influence of source-separated and of mixed MSW input on processing facility design. Both designs have been reported in detail in Reference 10.

D2. FACILITY for processing source-separated MSW

The first example is a 125 Mg/day facility designed for processing source-separated materials from residential generators. For the example, it is assumed that 25% of the recyclables arrive at the facility in pre-segregated, single form (e.g., tin cans), and that the remaining 75% are commingled. A process flow diagram for the paper processing line in the facility is shown in Figure VI-20. Figure VI-21 is a process flow diagram for a container processing line in the same facility. The flow diagrams also serve as mass balances, showing the mass flow rate of the various recyclables introduced into the system and discharged from it. Both flow diagrams illustrate provisions for redundancy in receiving, sorting, and processing.

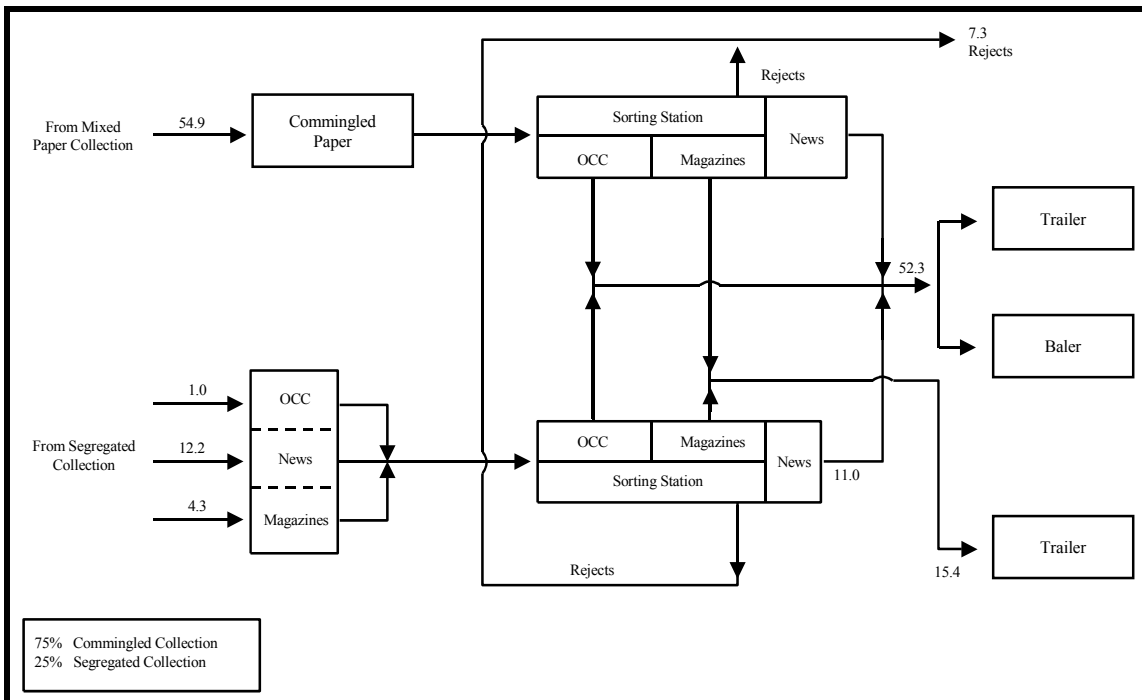

^a Design capacity = 75 Mg/day.

Figure VI-20. Paper processing line at a source-separated processing facility^a

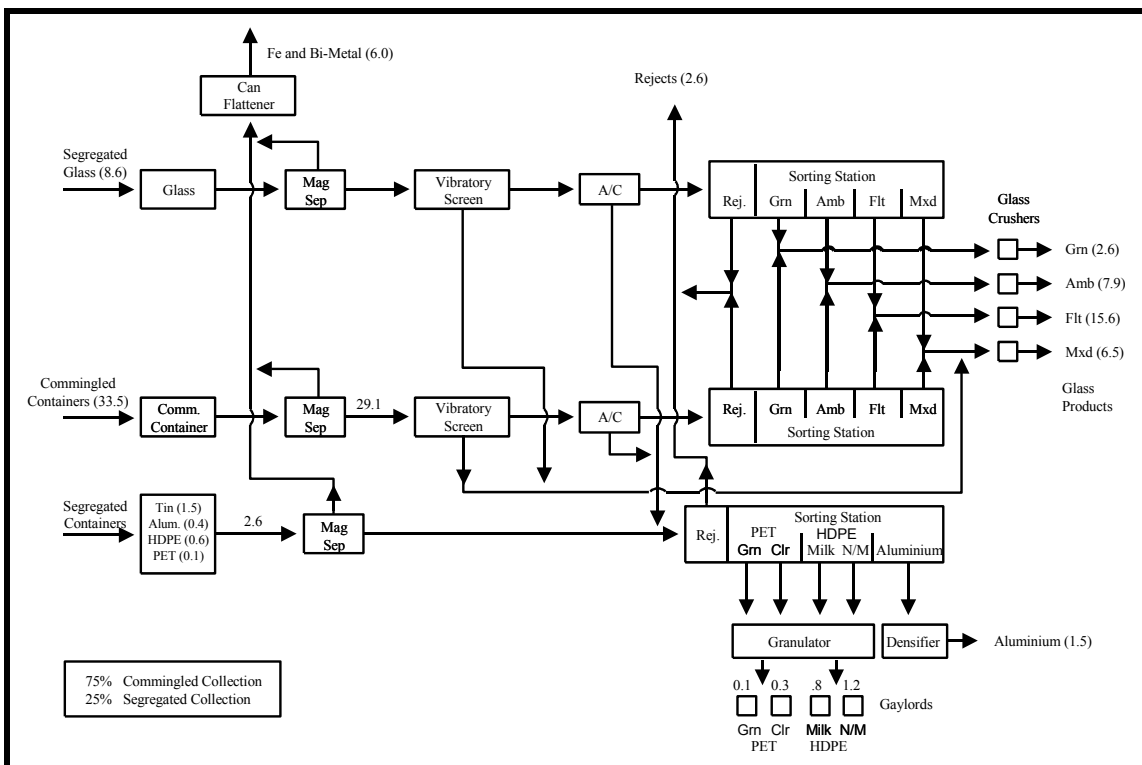

^a Design capacity = 45 Mg/day.

Figure VI-21. Container processing line at a source-separated processing facility^a

Breakage and contamination generally account for about 2% to 12% of the material introduced into such a system. Glass breakage during the collection process and during processing at the facility results in the loss of small particles of glass as residue. This residue is lost if a market for mixed coloured cullet cannot be found.

The level of contaminants must not exceed the limits allowable by the market agreements. Common contaminants involved in facilities designed to process paper and paper products include: 1) corrugated and magazines that have been intermingled with the residential newspaper prior to or during collection; and 2) low-grade paper (e.g., envelopes with “windows”) that has been mixed with commercial high-grade paper before or during collection.

A plan view of a facility designed to accommodate the processing lines diagrammed in Figures VI-20 and VI-21 is presented in Figure VI-22. The tipping floor and product storage areas are sufficiently large to provide for at least one day of storage for all materials. The facility also incorporates extensive redundancy and flexibility into the two lines. For example, as shown in Figure VI-22, the tipping floor for the paper fraction has two receiving pits, each of which serves a processing line that could process either the entire anticipated input of mixed paper, or the entire anticipated input of segregated paper. Thus, each pit serves as a 100% backup for the other.

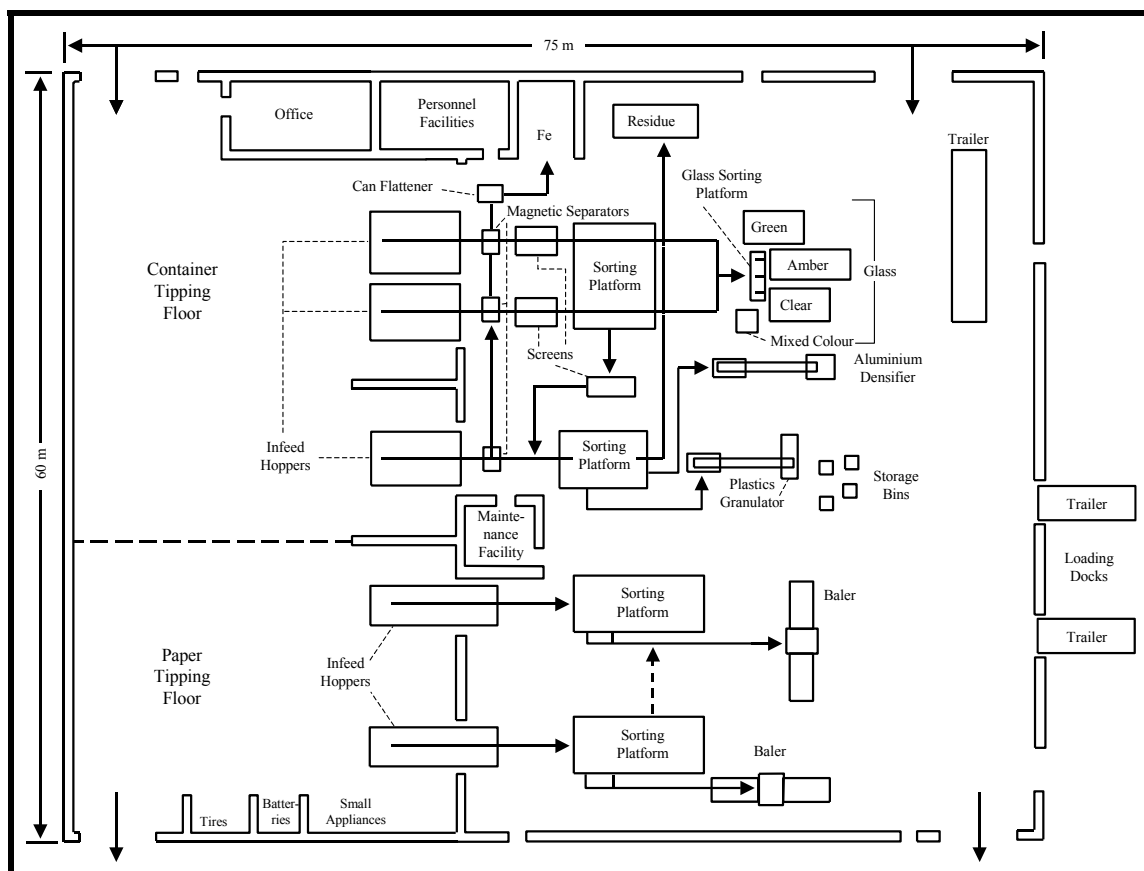

Figure VI-22. Example plan view of facility that processes source-separated materials

The tipping floor for containers has three receiving pits. Two of the pits and their associated processing lines are completely redundant, in that each pit and associated line can process either the entire anticipated input of mixed containers or the entire anticipated input of segregated containers. The third line is intended solely for handling segregated plastic and aluminium containers.

An example of a tipping floor of a source-separated materials processing facility is shown in Figure VI-23. Source-separated paper is shown stored to the left of the infeed conveyor in the figure, while source-separated but commingled rigid containers are shown stored to the right.



Courtesy: CalRecovery, Inc.

Figure VI-23. Example of a tipping floor and stored materials at a source-separated processing facility

Some source-separated materials processing facilities use elevated sorting conveyors and stations to segregate the different types of rigid containers (tin cans, glass bottles, etc.) from a mixture of commingled containers. An example is shown in Figure VI-24.



Courtesy: CalRecovery, Inc.

Figure VI-24. Example of a rigid container processing line at a source-separated processing facility

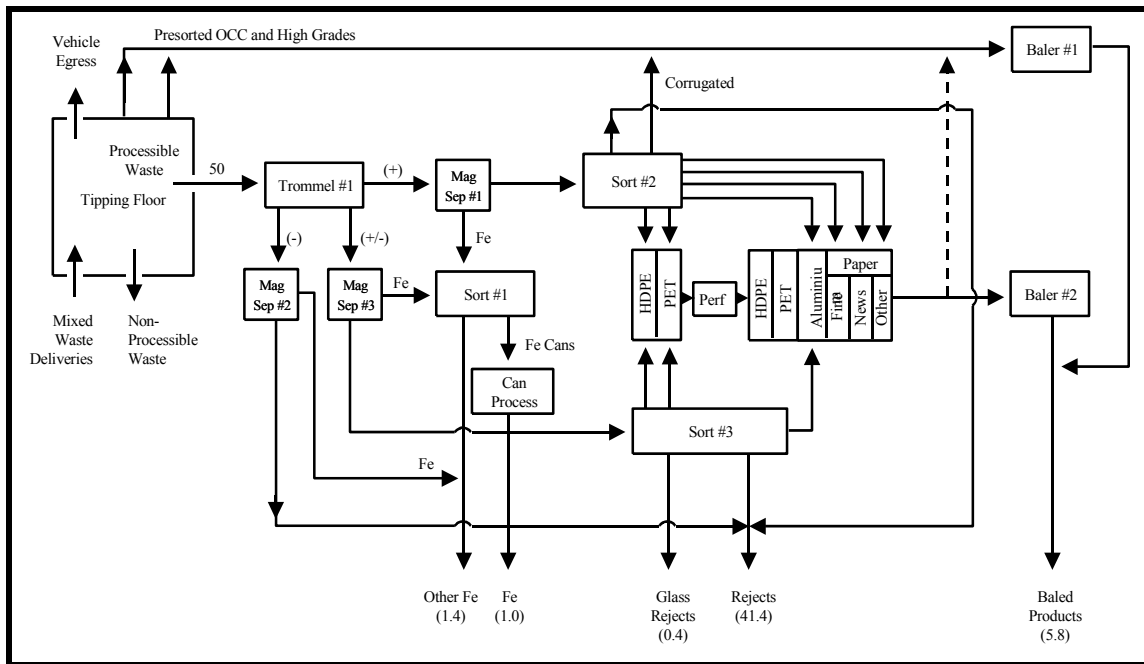

Figure VI-25. Example flow diagram for a mixed waste processing facility (Mg/hr)

D3. FACILITY for processing mixed waste

An example of a flow diagram of a 50 Mg/hr mixed waste processing system is depicted in Figure VI-25. The system is designed to recover recyclable materials (including ferrous, plastics, aluminium, and several grades of paper) from mixed MSW. In order to optimise the recovery of marketable secondary materials, the processing system relies upon mechanical and manual separation. In the example, the design permits the recovery of approximately 15% of the input mixed waste in the form of marketable grades of recyclables. Wastes are assumed to be delivered to the facility by means of conventional refuse collection vehicles and transfer trailers.

The design of the facility, and its operation, includes the use of wheel loaders and a picking crane to remove large, heavy objects and other non-processible items from the incoming mixed waste before it is introduced into the processing equipment. Non-processible items typically include stringy plastic materials, long lengths of pipe, large automotive parts, carpets, etc. Additionally, wheel loaders are used to segregate corrugated and other marketable wastepaper grades from incoming loads consisting predominantly of paper materials. When a sufficient amount of corrugated or other paper grades has been removed and has been accumulated on the tipping floor, the material can be transferred directly to a baler, thereby bypassing the mixed waste processing equipment.

In the design illustrated in Figure VI-25, mixed waste is fed into a two-stage primary trommel. Ferrous metal is segregated from the first-stage trommel undersize by passing it by a magnetic separator. Residue from this processing is routed to the output residue stream. The second-stage undersize stream from the primary trommel is passed through a magnetic separator, whereby ferrous metal is removed and conveyed to a manual sorting station. The sorting station receives ferrous metal that has been magnetically removed from the trommel oversize and second-stage trommel undersize fractions. Ferrous cans are sorted from other ferrous materials and are discharged into a can processing subsystem, e.g., can flattener. The resulting ferrous product is of high purity.

After its exposure to magnetic separation, the primary trommel oversize stream is conveyed to a second sorting station where HDPE, PET, aluminium, cardboard, and various paper grades are

separated manually. The separated materials are baled using one of two balers. One of the balers is always available as a processing redundancy.

HDPE and PET containers, aluminium containers, and some high-grade paper are manually sorted at a third sorting station. This station receives undersize fraction from the second stage of the primary trommel subsequent to ferrous removal. Residue from the third sorting station is combined with the other residue streams, and the resultant stream exits the facility as process residue.

Manual sorting is relied upon as the last step to beneficiate plastics and aluminium because it is an effective means for recovering the various types of plastic and aluminium containers in pure forms. Also, in most economically developing countries, manual sorting provides an opportunity for employment development. While the use of mechanical and electro-mechanical systems for separating different types of plastics and aluminium materials has some commercial history, the technologies be too complex for most applications in developing countries.

About 85% of the incoming mixed waste in the example is generated as process residue. The residue, in some cases, is predominantly combustible or biodegradable organic material. Unless the residue is processed for use in energy recovery or is converted into a feedstock for composting, it must be landfilled. However, under some conditions, integration of the organic residue with refuse-derived fuel recovery can reduce the quantity of the residue stream to about 15% to 25% of the input mixed wastes. In some locations, the high moisture content of process residue renders it suitable for composting. Photographs of a materials recovery facility capable of processing about 1,500 Mg/day of mixed waste, designed by the authors for a Latin American city, are shown on Figures VI-26 and VI-27.



Courtesy: CalRecovery, Inc.

Figure VI-26. View of the tipping area for a mixed waste processing facility



Courtesy: CalRecovery, Inc.

Figure VI-27. Partial view of sorting area

D4. CONCLUSIONS

The design of a waste processing facility involves two key determinations. One is the definition of the form and composition of the delivered feedstock -- source-separated recyclables vs. mixed municipal solid waste. A second determination is the required extent of recycling or waste diversion from land disposal. Diversion rates of 10% to 20% may be attainable through a residential and commercial source-separation program for various paper grades and glass, metal, and plastic containers. On the other hand, the inclusion of mixed waste processing and source-separated yard waste processing may be required if the diversion goal is 20% or greater. Of course, in both cases, markets must be available for the recovered products.

The design of processing facilities must recognise that the delivered waste will inevitably be contaminated with materials other than those specified. This inevitability will exist regardless of the degree to which the incoming waste stream is specified to be presorted at the waste generator site. In facilities in the United States handling residential source-separated materials, process residues typically are 2% to 12% of the quantities processed. In addition, mixed waste processing facilities in the United States commonly remove 2% to 5% of materials as non-processible wastes. The levels of contamination and of non-processible wastes generally are greater in developing countries. Manual and mechanical sorting are used to remove contaminants and non-processible wastes.

Additionally, each piece of mechanical processing equipment may extract material other than the desired product(s). The extraneous material may become entrapped or entrained with the desired separated material and may have to be manually removed to achieve high levels of product purity. Generally, the amount of marketable materials that can be recovered from a mixed waste processing facility in a developing country ranges from 12% to 15% of the input waste (by weight). This excludes the materials that are recovered during the collection process.

More detailed presentations on the design of processing facilities for source-separated materials and for mixed waste are given in References 18 and 1, respectively.

E. Yard waste and food waste processing

A waste processing facility can include an accommodation to receive and process segregated yard and food wastes. A discussion of these materials and their processing is presented here. Chapters VII, VIII, and IX present information that complements the following discussion.

E1. YARD waste

“Yard waste” is taken cumulatively to mean the variety of wastes of plant origin that are produced during the course of gardening, landscaping, and general maintenance of grounds. Sources of yard waste may be residential, commercial, institutional, and industrial sectors. Institutional sources include parks, public gardens, and landscaping (initiation and maintenance) of public properties. The composition and quantities of yard waste are influenced predominantly by geographical location, population density, and seasonality. Residential sources include single-family residences and multi-family units (e.g., apartments). Residential units in rural settings can be expected to generate more varied and larger amounts of yard waste than those in suburban areas -- and far more than those in densely populated urban cities. Volumes and types generated in institutional and commercial park settings are fairly similar. Not to be overlooked is kerbside landscaping, of which trees are major constituents.

Although the generation of yard waste may be relatively small in small municipalities in economically developing countries, the quantity of yard wastes generated in large metropolitan areas is substantial.

E1.1. Types of yard waste

The principal types of yard waste of concern in solid waste management are: 1) fallen leaves (especially from deciduous shrubs and trees); 2) discarded herbaceous plants or plant trimmings; 3) trimmings from large shrubs, ornamentals, and trees; and 4) grass clippings. These types of yard waste differ one from the other with respect to physical and chemical properties and to biodegradability. For example, the fallen leaves collected in autumn contain large concentrations of carbon and very little nitrogen. The structure and the carbon-to-nitrogen ratio of freshly discarded “green” herbaceous plants and their trimmings are conducive to rapid decomposition, whereas those of mature ones are not; for example, the higher lignin content of large tree branches compared to that of growing twigs. Approximate concentrations of nitrogen in some selected constituents of yard waste (grass clippings, leaves, and wood), along with those of some other organic materials for the purpose of reference, are listed in Table VI-10. The nitrogen content of yard waste depends upon the relative concentration of each of the types of yard waste present in it. The usual proportions of the components in the United States are such that the nitrogen content of yard waste is likely to be within the range of 1.5% to 2.0% [12]. These characteristics influence the ease and type of management of the yard wastes.

Ranges of concentrations of metals in plants and yard waste are presented in Table VI-11. Concentrations of metals, of microorganisms of public health significance, and of plant nutrients in composted yard waste produced at two particular sites are listed in Appendix A (in Tables in A-1, A-2, and A-3, respectively).

Table VI-10. Approximate concentration of nitrogen in yard wastes

Material	Nitrogen (% dry wt)
Grass clippings	2.15 to 4.5
Leaves	0.5 to 1.0
Wood (pine)	0.07
Sawdust	0.11
Fruit wastes	1.52
Paper	0.25

Sources: References 11, 12.

Table VI-11. Ranges of concentrations of metals in plants and yard waste (mg/kg, except as noted)

Element	Cultivated Plants	Yard Waste
Aluminium (%)	0.02 to 0.40	0.06 to 0.31
Barium	15 to 450	
Boron	37 to 540	< 0.1 to 1.4
Cadmium	0.37 to 2.3	3 to 14.3
Chromium	0.42 to 6.6	1.2 to 52.5
Copper	21 to 230	
Iron (%)	0.06 to 0.27	0.06 to 0.31
Lead	7.1 to 87	1 to 38
Manganese	96 to 810	23 to 1261
Nickel	2.7 to 130	1.7 to 33.3
Selenium	0.04 to 0.17	
Zinc	180 to 1,900	39 to 585

Sources: References 12-14.

In designing a yard waste management program, seasonal variations in quantity and composition must be considered. The types and quantities of yard waste generated vary markedly depending on the season, as well as on the geographical location. As discussed previously, these variations in type affect the characteristics of the yard waste. The magnitude of the variations is exemplified by the ranges of values given in Tables VI-10 and VI-11.

Because street sweepings are likely to contain contaminants such as bottle caps, plastics of various types, dirt, rocks, and glass shards, they should not be mixed with yard waste destined for composting without careful evaluation. However objectionable these materials may be, of much more serious concern are the dust and dirt in the sweepings. The dust and dirt are apt to be laden with potentially hazardous inorganic and organic substances.

It should be pointed out that in terms of chemical content and origin, the dust in street sweepings differs only slightly from that which accumulates on the foliage of plants, shrubs, and trees located near roadways -- particularly where the traffic is heavy. Thus, delivery of fallen leaves during certain periods of the year may include an appreciable concentration of contaminated dust.

E1.2. Processing of yard waste

Three principal alternatives are available for processing yard waste: 1) process all yard waste at a central facility; 2) process all yard wastes at their respective sites of generation (e.g., backyard composting); and 3) a combination of alternatives 1 and 2 (i.e., central facility plus backyard composting). The second alternative would eliminate collection of yard waste and would involve onsite use of the material.

E1.2.1. Backyard processing

Some drawbacks of backyard processing are relevant to developing countries. An obvious drawback is the physical impossibility of backyard processing in densely populated urban areas due to lack of available space. Another drawback is the need for education and training in the practice of backyard processing. A final drawback is the potential that backyard processing could degenerate into backyard “open dumping” and roadside littering.

In light of the drawbacks, one of the best approaches to managing yard waste on a large scale is to process yard waste at a central facility and to keep backyard processing as a strictly voluntary, but encouraged, undertaking on the part of the householder.

The processing of choice for the backyard situation is composting, although some debris can be spaded directly into the ground prior to planting -- usually in early spring or in late autumn. Principles and procedures for composting are described in detail in Chapter VIII.

With respect to composting of small quantities of yard waste, the minimum volume for satisfactory heat retention and, therefore, rapid decomposition is about 1 m³. Thus, the utility or even practicality of most of the pre-fabricated compost units presently on the market is debatable. The units seem to be too small to permit the self-insulation required for a significant accumulation and retention of heat. Preferably, but not necessarily, the compost bin should be constructed of a durable material. Wood, concrete, or cement blocks are suitable.

Inoculums, enzymes, and other exotic additives serve no useful purpose [16,17]. However, the addition of a waste rich in nitrogen or a chemical fertiliser to lower an excessively high C:N is useful in order to achieve relatively rapid decomposition.

E1.2.2. Central processing facility

Inasmuch as yard waste delivered to a central processing facility is likely to be of relatively large particle size and may be contaminated with dirt, rocks, bricks, and ferrous material, it often is subjected to the processing indicated by the flow diagram in Figure VI-28. Size reduction (shredding) renders the waste easier to handle, and brings the particle size distribution of the composted material within that prescribed by product specifications. The size-reduced material is then screened and exposed to magnetic separation (or vice versa) to remove materials that might interfere with certain uses of the product. For instance, if the woody fraction is to be used as a solid fuel, the dirt, glass, and ferrous contamination in the product should be minimised. Removal of glass and ferrous metals would be important if the processed waste is to be used as a compost feedstock. Equipment used in the processing (e.g., shredders, screens, and magnetic separators) has been described previously in this chapter.

Composting of yard waste processed for that purpose may be carried out at the site of the processing facility. The alternative is that the processed waste is transferred and composted at another site. The principles, methods, and technology of composting are described in Chapter VIII.

Certain types of yard waste may become problems when used as a compost feedstock, unless appropriate precautions are taken. Among the more problematic types of yard waste are woody trimmings and large branches (either intact or size-reduced), grass clippings, and fallen leaves. Probably the best approach with woody materials is to use them as fuel or as bulking material for composting wastes that require bulking in order to provide porosity (e.g., sewage sludge). Problems with grass clippings come from the tendency of the clippings to form mats, which in turn become anaerobic. The matting problem can be avoided by thoroughly mixing the clippings with other types of yard waste. In actuality, if porosity and homogeneity of the mixture is achieved, grass clippings enhance the compost process because they decompose readily and usually have an appreciable nitrogen content. Problems associated with odours due to the grass clippings generally are due to the decomposition that takes place during storage and to poor composting practice.

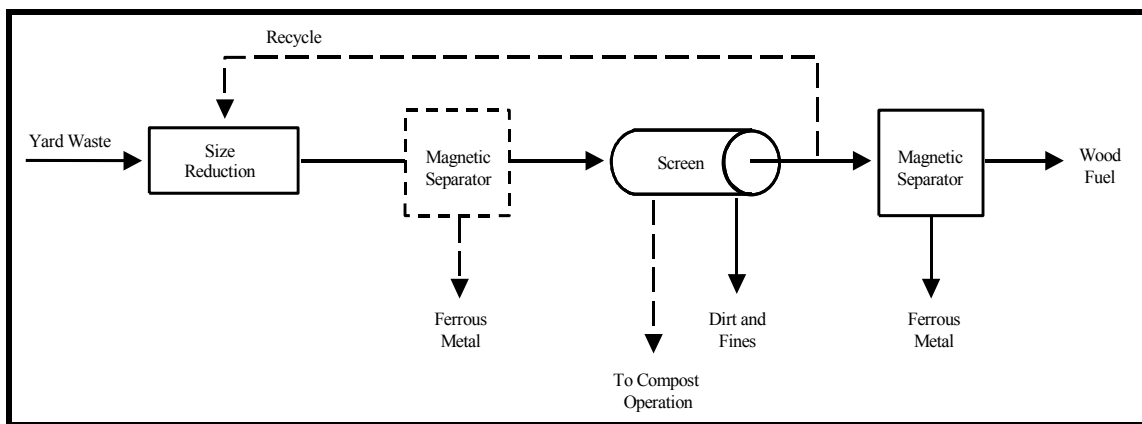

Figure VI-28. Yard waste processing alternatives

Primarily three problems attend the successful composting of fallen leaves. These problems are: 1) the greater part of the annual output, which can be sizeable, takes place within a two- or three-week period; 2) the C:N of the leaves is sufficiently high to significantly slow the composting process; and 3) some individual leaves are highly resistant to microbial attack as long as they remain intact. These problems are not serious if sufficient space is available to permit a leisurely rate of composting.

Although nothing can be done about suddenness of the influx occasioned by the change in seasons (e.g., autumn), the area required for composting can be minimised by accelerating the compost process. The process can be accelerated significantly by size reducing the leaves, lowering the high C:N, and optimising the operational and environmental conditions. Size reduction not only facilitates microbial access to the leaves, it also upgrades the final product in terms of appearance and handling. The C:N can be lowered by adding nitrogen either as a highly nitrogenous waste or as an agricultural chemical fertiliser (i.e., urea). The addition of a source of chemical nitrogen must be carefully analysed since it can appreciably increase the operational cost of the facility.

The beneficial effect of lowering the high C:N of leaves during composting by adding chemical nitrogen has been demonstrated by the authors. In one study, the initial C:N of the leaf feedstock was in the range of 50:1 to 80:1. Urea was used to lower the C:N to a range of 19:1 to 26:1. The substantial rise in temperature that followed (i.e., from ambient to highs of 55° to 60°C) denoted rapid decomposition. The rise in temperature could only be attributable to the improvement in C:N levels since in the two months prior to the addition of urea, temperatures had remained near ambient levels.

Both turned open windrow technology and the forced-air static pile method are satisfactory for composting yard waste unless unusual circumstances exist. With either method, the windrows should be enclosed during the active stage of composting by a structure to protect them from rain and snow and from the very low temperatures characteristic of winter in some areas. In addition, the enclosure allows for control of dust and odours. In areas of relatively milder climate, a roofed area would be sufficient. If time and space are not critical, the use of a tarpaulin would be sufficient for protection, especially during the rainy season. If in-vessel technology is required for some reason, a simple form of the bin system would be suitable.

E1.3. Chemical-related health and environmental considerations

Among the constituents of yard waste and composted yard waste that represent a potential hazard to occupational and public health and safety and to the quality of soil, water, and air are: nitrogen, metals, pesticide and herbicide residues, organic breakdown products, and other toxic organic compounds. Information on hazardous constituents in solid waste is becoming increasingly available in the literature. However, a lack of data exists regarding specific hazardous substances in yard waste and the environmental fate of those substances. Likewise, the identity and fate of the intermediate breakdown products (i.e., those generated as the composting process proceeds from the raw yard waste to the finished compost) have not been adequately characterised. Consequently, prudence dictates that compost leachates, runoff, surface water, and groundwater beneath and adjacent to compost facilities should be closely monitored. Untreated compost leachate and runoff water from the facility should not be allowed to reach surface and groundwaters. Information pertinent to the concentration of some toxic organic compounds in yard waste compost is presented in Table VI-12.

Table VI-12. Concentrations (ppm) of herbicides and pesticides in compost from yard waste

Herbicide/Pesticide ^{a b}	Source 1	Source 2
Chlordane	0.324	0.152
p'p'DDE	0.014	0.005
p'p'DDT	0.019	0.008
o'p'DDT	0.004	ND ^c
Toxaphene	0.300	0.300
Aldrin	ND	0.007
Dieldrin	ND	0.019
Dursban	ND	0.039
Trifluralin	present	present
Casoron	present	present
Dalapon	< 0.50	< 0.50
Dicamba	0.50 to 12.9	< 0.50
MCPD	< 0.50	< 0.50
MCPA	0.5 to 7.1	< 0.50 to 2.4
Dichloprop	< 0.50	< 0.50 to 1.2
Dinoseb	< 0.50 to 1.0	< 0.50 to 1.0

Source: Reference 15.

- ^a Endrin, lindane, malathion, parathion, and diazinon are not detected/below detection limit for both sources.
- ^b 2,4-D, silvex, 2,4,5-T, and 2,4-DB are < 0.50 for both sources.
- ^c ND = not detected/below detection limit.

E2. FOOD waste

The term “food waste” refers to the putrescible waste generated in the preparation and consumption of food and that remaining after consumption (i.e., “kitchen” and restaurant wastes); discarded comestibles (e.g., spoiled or partially eaten fruit, stale bakery goods, etc.); and vegetable trimmings generated in produce markets.

A relatively recent development in the United States and Western Europe is the expanding advocacy for composting a mixture of yard waste and food waste. The concept has much in its favour. Food waste decomposes readily and under proper conditions enhances the compostability of yard wastes, especially of shrub and tree trimmings and leaves by serving as a readily available microbial energy source and to a limited extent as a nitrogen source for the microbial populations.

The composting of yard waste and food waste is encumbered usually by the difficulty in reconciling the seasonal variations in yard waste production with the year-round uniformity of food waste production. The problem is less significant in tropical climates. Because of the difference in patterns of generation, yard waste can be in short supply during slack growing seasons (e.g., rainy season, late autumn and winter). However, the dearth of yard waste is a problem only if the composition of the food waste is such that a bulking agent would be needed, since yard waste can be an excellent bulking agent.

If mixed with food waste, yard waste would become a part of a mixture that would have the objectionable aesthetic, health, and environmental impacts usually associated with raw food

waste. Objectionable impacts usually associated with food waste are unsightliness and malodours. Objectionable health-related impacts include the attraction of flies of all types (e.g., common houseflies, fruit flies, “blowflies”) and rodents (particularly rats) to food waste. Food waste serves not only as a nutrient source but also provides shelter for pests.

E2.1. Storage and collection

The isolation of food waste from the environment during storage and collection must be as complete as possible in order to minimise health and environmental impacts. The high degree of isolation requires the use of enclosed, leak-proof containers for storage. Furthermore, since 90% to 95% of the weight of raw food waste is water, its density approaches that of water. Thus, the volumetric capacity of the storage container should not be larger than 40 to 50 L if it is to be handled manually. If the food waste is to be transported to a central facility, the transport vehicle must be designed to ensure complete containment of the food waste. Storage time at the site of generation and at the central facility should be as short as is feasible.

The storage and collection of yard waste should be separate from those of food waste in order to avoid the aforementioned problems with storage and collection of food waste. Mixing of the two wastes should not occur until immediately before processing.

E3. COMPOSTING of mixtures of yard and food wastes

E3.1. Methodology

The composting of a mixture of yard waste and food waste is almost identical to the general composting methodology described for backyard and central facility composting of yard waste. A principal difference is that the repercussions of operational shortcomings and lapses are more onerous in the composting of food/yard waste mixtures. Also, the precautionary measures that attend the composting of yard waste/food waste mixtures are more numerous and critical.

The difficulties associated with composting food wastes on a large scale are such that some municipalities have opted for first digesting the mixture anaerobically and then composting the digested solids.

E3.2. Backyard composting

The necessarily batch nature of residential backyard composting creates potential health and environmental problems because substantial time may elapse before sufficient waste is available to warrant operational procedures such as turning. Prior to the accumulation of sufficient material, diffusion of odours and access by pests can be minimised and perhaps prevented by covering the material with a tarpaulin underlain by a fine-mesh screen. The floor and sides of the composting bin should be constructed of “rat-proof” material (e.g., asphalt, concrete, or durable wire mesh). However, if the size of the wire mesh is too large, egress of insect and fly larvae from the bottom of the material will occur.

E3.3. Central composting facility

The problems associated with batch composting can be reduced by resorting to a modified continuous type of composting. With the windrow method of composting (turned or static), continuity is attained by adding material to one end of the windrow while, more or less simultaneously, removing an equivalent volume from the other end. In-vessel composting can be made continuous, although there is the potential of inadequate mixing and aeration of material.

Regardless of batch or continuous operations, both raw and composting material should be made inaccessible to flies and animals, especially rats.

E4. PRECAUTIONS

Storage facilities for the raw food waste and for the mixed yard waste/food waste feedstock must be well constructed and maintained. These criteria can best be attained by enclosing storage facilities and the active composting stage in a suitably designed structure.

Because of its putrescible characteristics, food waste (or mixtures containing them) must be properly managed so as to protect human health and safety and the environment. To minimise vector attraction, food wastes should be processed promptly, ideally on the same day that they are delivered to the processing site. Prompt processing minimises the risk of food waste undergoing anaerobiosis and, therefore, generating obnoxious odours. Good housekeeping within and about the processing facility also promotes an operation free of vectors, malodours, and litter.

F. Processing and recycling construction and demolition (C&D) debris

Economic activity and natural disasters generate residues, among which are solid wastes and wastewater. Construction and demolition debris (C&D) is one of the solid wastes. In terms of weight, C&D typically constitutes from 5% to 15% of the solid waste stream of industrialised nations. Among the many activities that generate major amounts of C&D are highway construction and urban development, expansion, and renewal. In the United States, concrete debris from highway construction and demolition account for 10% to 40% of C&D.

Available data on the quantities of C&D produced in developing countries are very limited. However, estimates conducted by the authors indicate that the quantities of C&D generated fluctuate between 0.05 and 1.0 kg/cap/day.

As is well known, the management and disposal of C&D are beset with numerous problems, most of which relate to handling, storage, transport, and disposition either by recycling or by final disposal. These problems are largely due to the nature of the wastes. A characteristic that frequently magnifies the problems is bulkiness. The bulk density of C&D is a function of that of its components. The bulk density of major components of C&D is indicated by the data listed in Table VI-13. Bulkiness and heaviness, along with resistance to compaction, seriously constrain the landfill option. High cost rules out particle size reduction (shredding, grinding) merely as a means of compensating for bulkiness. However, it is justified if it were a unit process in recycling. Disposal by incineration is impractical since the material is mostly inert.

Table VI-13. Selected C&D waste stream densities

Component	kg/m³
Brick (whole)	715 to 1,795
Concrete	705 to 1,100
Metal, non-ferrous	540
Metal, steel	650
Wood	240

Sources: References 19, 20.

A seemingly obvious solution to disposal difficulties is to avoid them through recycling. Although C&D may be difficult to handle and to move, it potentially is rich in terms of

inorganics that compare favourably with those of virgin materials. However, wood may be an exception.

Prior to the advent of plasterboard, wooden laths made up a significant portion of C&D in the United States, and were particularly difficult to landfill because of their resistance to compaction. The hope of minimising this problem, and that caused by wood waste in general, led to a proposal in the early 1980s to recycle the wood by using it as a source of fibre for manufacturing paper. A study to investigate the feasibility of such an undertaking found that unavoidable contaminants rendered the concept unfeasible. In many cities in economically developing countries, wastes from C&D are either discarded on empty lots or used at the land disposal site for road building or cover material.

F1. CONCRETE

Of the five components listed in Table VI-13, concrete is the one of principal interest in this section. Concrete debris comes from the razing of buildings and the demolition of other structures, roads, and highways, and may represent 10% to 40% of C&D. In the past several decades and continuing today, a significant fraction of the concrete debris was and is recycled after only a minimum of processing that consists of reducing the concrete chunks to a size required by their intended use. The uses are many and varied. For example, they may be used in dike construction, or may provide an “all-weather” temporary roadbed in a waste disposal site.

Although these uses may have sufficed for past conditions, they are inadequate for the much broader recycling volume demanded by modern conditions. The expansion of recycling to the extent demanded by the present waste management and disposal situation necessitates much greater processing than mere size reduction. Fortunately, practical methods of accomplishing the required processing have been developed by commercial haulers and builders in the past several decades. The assessment of concrete recycling is accomplished in this discussion by way of analysis of two representative ongoing operations. Such an approach is appropriate because, at present, most concrete recycling is done as a unit process in C&D processing facilities. As is true with other recovered C&D products, recovered concrete debris usually is recycled in the construction industry. Hence, the strength of the market for recycled concrete reflects that of the construction industry. The principal use of processed concrete debris is as aggregate.

The physical characteristics of C&D are such as to need the use of relatively expensive equipment for processing it into its marketable components. A promising means of lowering the resulting unit cost of processing is to rely upon portable equipment that can be moved from one demolition operation to another. Equipment cost has not deterred some contractors from designing and operating C&D processing facilities. The facilities usually incorporate some or all of the following operations to produce marketable materials: screening, size reduction, magnetic separation, density separation, and manual sorting.

F2. TECHNOLOGIES

Although technologies for the overall processing of C&D may be loosely grouped into manual (i.e., labour-intensive) and fairly mechanised, concrete debris processing generally does not lend itself to such a grouping in that its processing is, as a whole, both labour-intensive and mechanised [24]. However, there may be some advantages in designing the technology to be either predominantly manual or mainly mechanised. Advantages alleged to be inherent in predominantly manual processing are lower capital expenditure, and a labour force that is available for other activities during the intervals between process operations. Advantages attributed to largely mechanised approaches are greater efficiency and processing rates, and lower

labour requirements. This attribute becomes meaningful only when labour either is scarce or expensive.

“Sorting” exemplifies the “dual nature” of concrete debris processing. Sorting is two-fold: 1) separation of concrete debris from other C&D, and 2) classification of the separated concrete debris. Separation from other debris usually is one of the demolition activities and, thereby, begins at the demolition site. At this point, segregation may be performed manually, mechanically, or both. The role of sorting in this stage is to retrieve recyclable materials. It is exemplified in the demolition of a building that has one or all of the following: concrete walls, floors (slabs), and columns. Steel and/or wire present in the structures is removed manually as the demolition progresses.

The other aspect of sorting is the separation and classification done in the processing sequence. This sorting usually is mechanised and largely consists of screening. The screening may be preceded by size reduction and be augmented by: 1) magnetic removal of ferrous material, and 2) flotation to separate wood and plastics. These processing operations may be performed onsite, with the use of portable equipment, or at a central facility.

Size reduction is one of the more important of the processing steps. It usually is carried out by a specially designed crushing machine (“shredder”) or by a grinder. Obviously, the machines must be rugged. Discharge from the machines is screened and further processed. As stated earlier, the discharge may serve as an aggregate for use in roadbed construction or may be further processed (refined) to the extent required for a particular use. A likely use would be for making concrete. Careful analyses of the concrete must be performed to ensure that it meets national standards.

F3. STATUS of concrete recycling

As was stated earlier, some retrieval of concrete debris always was a part of conventional C&D management and disposal. Nevertheless, it constituted only a minor part of the total effort. This minor role is rapidly being expanded in response to the changes that are taking place in the public attitude regarding waste management in all of its aspects. The upshot with regard to C&D management and disposal in general, and those of concrete debris in particular, is a growing number of processing and reclamation undertakings in industrialised countries.

In this section, we typify the state-of-the-art by describing two representative C&D processing operations. One of the two projects represents a situation in which both onsite processing and reuse or disposal are feasible. An example of such a situation is highway and overpass reconstruction following an earthquake. The second type of situation is one in which concrete processing is done at a central location -- often in conjunction with a materials recovery facility. These facilities are described for those locations in economically developing countries in which the particular situation may demand the processing and recycling of C&D.

F4. REPRESENTATIVE projects

F4.1. Example 1: Onsite processing and reuse/disposal

The first enterprise to be described is part of a development that considerably expanded the Yale University Science Park in Connecticut, United States. The Park is the home of the U.S. Repeating Arms Corporation (USRAC) Winchester Manufacturing facility. In order to make space for the new 46,500 m² USRAC structure, a 60,400 m² complex consisting of 12 contiguous buildings had to be demolished. The complex included 4- to 5-story structures, high-bay buildings, single-story residences, and part of a World War I munitions complex. An important feature of the demolition contract called for the filling of all sub-grade cavities in preparation for

the new building foundations. These cavities included utility tunnels, passageways, basements, and subbasements. A serious constraint on demolition strategy was the required elimination of the use of explosives. Therefore, the demolition had to be done entirely with use of mechanical (“wrecking ball”) and manual methods. The demolition was preceded, accompanied, and followed by establishment of remedial and preventive measures to keep the site from being classified as an inactive hazardous waste disposal site.

Materials collected in the demolition activity and the processing accorded them are listed in Table VI-14. As the table indicates, concrete was crushed onsite to form an aggregate. The aggregate was used as backfill. Use of the crushed concrete onsite eliminated significant transportation and disposal expenditures. Cost of disposing C&D in the state in 1990 was US\$15 to US\$20/m³. Equally important were the savings in landfill capacity. For many reasons, available landfill volume was and remains extremely scarce in Connecticut and adjoining states.

Onsite equipment included two to three hydraulic shears, grapples, hydraulic excavators, and a crane with a wrecking ball. Most equipment was mounted on caterpillar-tracked bodies.

An idea of the costs involved in demolition may be gained from the project unit costs listed in Table VI-15. According to the data listed in the table, the unit cost for demolition, exclusive of any return from sale of recovered product, was US\$15/m³ in 1990. Cost for processing of the concrete was US\$23/m³, exclusive of demolition cost. Without the benefit of recycling, the unit costs experienced in the project site demolition would have been more than double. Use of processed (crushed) concrete as backfill had a very favourable impact on unit costs in the project. This use was particularly advantageous inasmuch as no viable disposal alternative was available at the time.

F4.2. Example 2: Central processing

The second representative case is one in which concrete processing is conducted at a fixed or central site. In this case, concrete debris is brought to the site and the processed concrete is used offsite. The particular case described below is located on an active landfill and has been in operation for a number of years. Processing concrete and C&D is in two separate systems. The material flow through the concrete processing system is diagrammed in Figure VI-29. According to the figure, processing of concrete debris consists mainly in size reduction and screening. The product is used in road construction and other applications in which fill material is required.

The separate C&D processing system is diagrammed in Figure VI-30. Unlike the concrete system, the C&D system is designed to recover several types of materials from size-reduced debris. Among them are dirt, a planting mix, and a “hog” fuel. The key unit operations are size reduction, screening, and flotation.

Table VI-14. Composition and disposition of materials

Material	Onsite Processing	Market
Structural steel	Cut with hydraulic shears	Local scrap metal processor
Concrete (75,000 Mg)	Crushed to 10 cm maximum particle size	Blend and sub-grade preparation; compact in 30 cm lifts; stockpile remainder for future use
Brick from the oldest fireplace	Hand recovered; mortar taken off, palletised; shrink- wrapped	Stockpiled for reuse in the new building
Brick, other (5,200 Mg)	Crushed to 10 cm maximum particle size	Blend and sub-grade preparation; compact in 30 cm lifts; stockpile remainder for future use
Wood flooring	None	Local processor chips for use as fuel or for export
Electrical (copper) and plumbing (iron, copper, and brass) ^a	None	Local scrap salvager
Old iron fence	Stockpiled	Future reuse onsite

^a Exposed non-ferrous metals had been scavenged prior to demolition.

Table VI-15. Unit costs (US\$, 1990)

Cost Element	Project Cost^a (\$/m³)	Comparative Disposal Costs (\$/m³)
Demolition ^b	15	30
Concrete ^c	23	30

^a Includes use of processed material on the project site.

^b Unit costs reflect no value for recovered materials.

^c Unit costs reflect no cost for demolition.

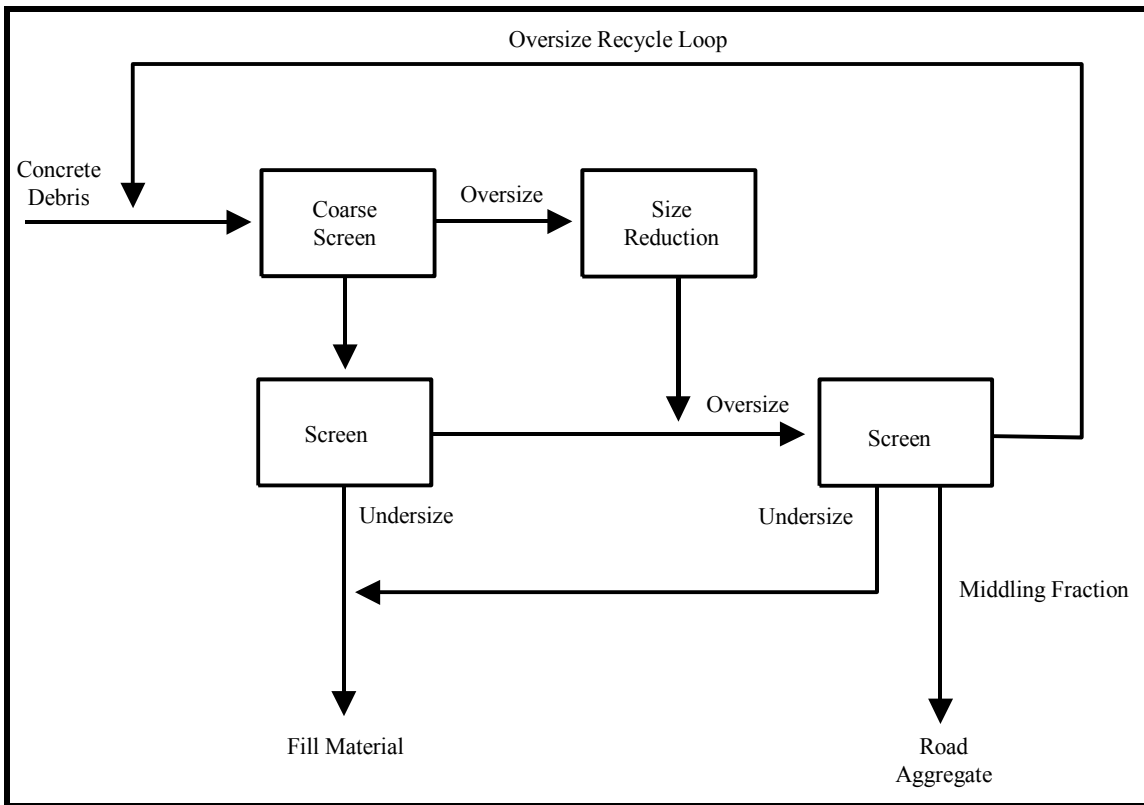

Figure VI-29. Concrete recycling process system

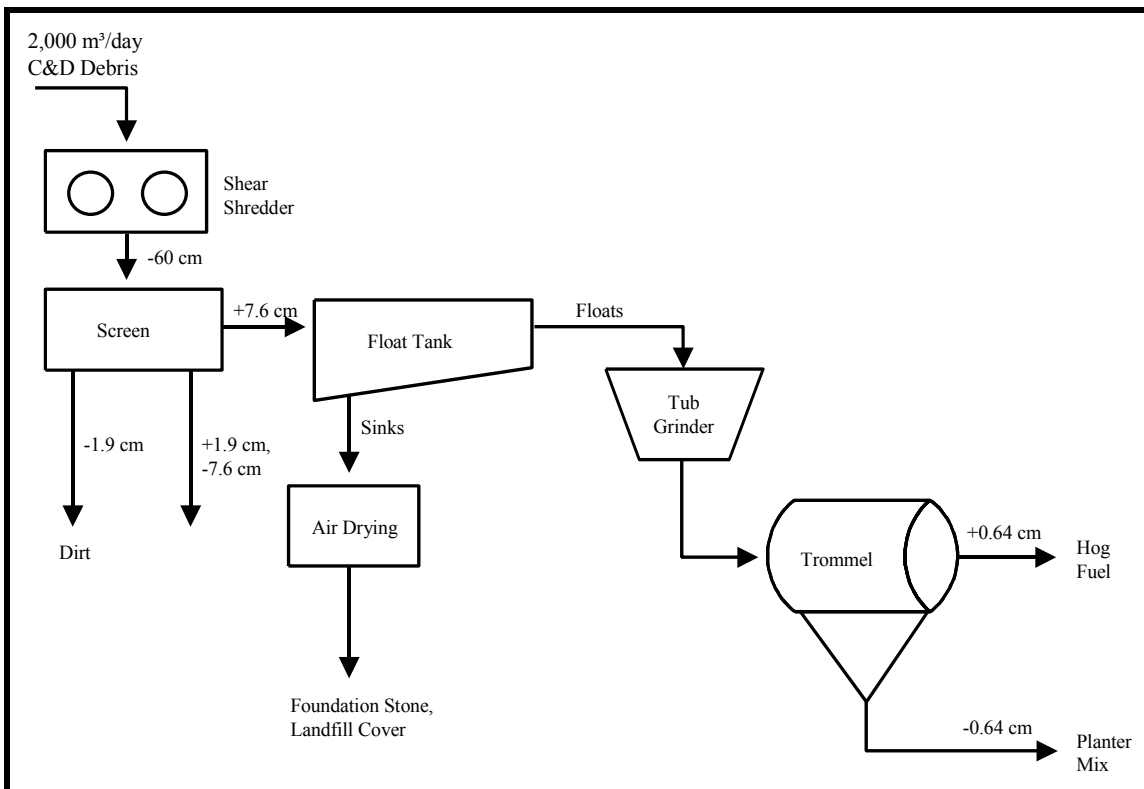

Figure VI-30. Construction and demolition debris recycling process system

A variant of the preceding system is designed to recover secondary materials. It makes use of a bucket screen to classify size-reduced wastes on the basis of particle size. Oversize materials are manually sorted to recover cardboard, aluminium, foil, plastics, wood, and ferrous materials. Undersize discharge from the bucket screen is conveyed to succeeding screens and an assortment of manual and mechanical separations.

F5. SUMMARY and conclusions

1. Although the focus of this section is on concrete debris, it does include some discussion of C&D debris because concrete is a component of C&D debris. As is true with C&D debris, recycling leads to substantial savings in disposal costs. Contractors in industrialised countries are well aware of this fact and have become adept in developing effective procedures. This is well illustrated in the first example.
2. The first example exemplified the advantages of onsite processing with portable equipment in certain situations. In this case, processed concrete debris was used as backfill, for which there was a considerable need. As a result, substantial savings were realised in transport and disposal costs.
3. The second example demonstrates the feasibility of processing concrete debris with fixed equipment at a central facility in conjunction with a MRF. With this combination of concrete processing and MRF operation, it was possible to recover a wide range of usable products.
4. Onsite vs. central processing: The advantages of onsite processing are more apparent with C&D processing than with concrete debris processing. Costly transport of raw and processed wastes is minimised with onsite processing. The advantages are emphasised when the processed product is used onsite, as was true in the first example.
5. Mechanically-intensive vs. labour-intensive: The qualification “intensive” is used because all but the smallest reuses of concrete debris entail crushing (size reduction) as a first step, followed by screening. Perhaps a more meaningful comparison would be one between manual vs. automated in terms of equipment control. Manual control requires constant supervision in processing concrete debris because of the greater demands imposed by the nature of the material.
6. If for no other reason than its potential in reducing disposal costs, processing concrete debris will always be one of the activities that characterises construction and demolition. Furthermore, this basic reason is being increasingly reinforced by the expansion of the number of useful products of processing.
7. The applicability of mechanised C&D processing and recovery in most developing countries is still debatable. The concepts, however, can be applied in several of the large metropolitan areas. A large amount of manual segregation of C&D debris takes place in most urban areas in economically developing countries. The recovered materials are either reused or recycled.
8. While the examples in this section placed emphasis on concrete segregation and recycling, C&D wastes also usually include high concentrations of asphalt and wood waste. Both of these materials also can be segregated at the source or at central processing facilities, as is the case with concrete wastes. Recovered asphalt can be reused in asphalt mixtures to construct roadways, and wood waste can be used as fuel or as bulking agent for composting.

G. References

1. Diaz, L.F., G.M. Savage, and C.G. Golueke, *Resource Recovery from Municipal Solid Wastes: Vol. I, Primary Processing*, CRC Press, Inc., Boca Raton, Florida, USA, 1982.
2. Savage, G.M., J.C. Glaub, and L.F. Diaz, *Unit Operations Models for Solid Waste Processing*, Noyes Publications, Park Ridge, New Jersey, USA, 1986.
3. Savage, G.M., D.J. Lafrenz, D.B Jones, and J.C. Glaub, *Engineering Design Manual for Solid Waste Size Reduction Equipment*, prepared by CalRecovery Inc. for U.S. Environmental Protection Agency, Report No. EPA-600/S8-82-028, 1982.
4. Hasselriis, F., *Refuse-Derived Fuel Processing*, Butterworth Publishers, 1984.
5. Vesilind, P.A. and A.E. Rimer, *Unit Operations in Resource Recovery Engineering*, Prentice-Hall, Inc., Engelwood Cliffs, New Jersey, USA, 1981.
6. Robinson, W.D., "Shredding Systems for Mixed Municipal and Industrial Waste", *Proceedings of the American Society of Mechanical Engineers Conference*, 1976.
7. CalRecovery, Inc., *Trommel Screen Research & Development for Applications in Resource Recovery*, prepared for U.S. Department of Energy, October 1981.
8. *The Solid Waste Handbook*, ed. W.D. Robinson, John Wiley & Sons, New York, USA, 1986.
9. Savage, G.M. and L.F. Diaz, "Processing of Solid Waste for Material Recovery", presented at American Society of Mechanical Engineers 14th National Waste Processing Conference, Long Beach, California, USA, June 1990.
10. Savage, G.M., "Design of Materials Recovery Facilities (MRFs)", *Proceedings of the First U.S. Conference on Municipal Solid Waste Management -- Solutions for the 90s*, Vol. II, sponsored by U.S. Environmental Protection Agency, Washington, DC, USA, June 1990.
11. Sills, M.J. and R.N. Carrow, "Turfgrass Growth, N Use, and Water Use under Soil Compaction and N Fertilization", *Agronomy J.*, 75:488-492, 1984.
12. Rosen, C.J., N. Schumacher, R. Mugas, and S. Proudfoot, *Composting and Mulching: A Guide to Managing Yard Waste*, Minnesota Extension Service, AG-FO-3296, pp. 7, 1982.
13. Epstein, E. and P.L. Engel, "Compost Products and Their Uses", *Solid Waste & Power*, 5(4):44-53, August 1991.
14. Brownlo, A.H., *Geochemistry*, Prentice-Hall, Engelwood Cliffs, New Jersey, USA, pp. 498, 1979.
15. CalRecovery, Inc., *Portland Area Compost Market Study*, Final Report No. 1189-3, prepared for Metropolitan Service District, Portland, Oregon, USA, October 1988.
16. Solbraa, K., "An Analysis of Compost Starters Used on Spruce Bark", *BioCycle*, 25(2):46-47, March 1984.
17. Golueke, C.G. and L.F. Diaz, "'Starters' -- Inoculums and Enzymes", presented at BioCycle West Coast Conference '89, March 1989, *BioCycle*, 30(4):53-57, April 1989.

18. CalRecovery, Inc. and PEER Consultants, *Material Recovery Facilities for Municipal Solid Waste*, EPA 625/6-91/031, prepared for U.S. Environmental Protection Agency, Office of Research and Development, Washington, DC, USA, September 1991.
19. Lund, H., *The McGraw-Hill Recycling Handbook*, New York, New York, USA, 1993.
20. CalRecovery, Inc., *Conversion Factors for Individual Material Types*, prepared for California Integrated Waste Management Board, Sacramento, California, USA, December 1991.
21. Mancini, I.M. and S. Masi, "Influence of Mechanical Pretreatment on MSW Disposal in Integrated Systems", *SARDINIA 99 Seventh Waste Management and Landfill Symposium Proceedings, Vol. I, Landfill Processes and Waste Pre-Treatment*, Cagliari, Sardinia, Italy, pp. 361-269, October 1999.
22. Heyer, K.-U., K. Hupe, and R. Stegmann, "Mechanical Biological Pretreatment and Energetic Recovery of RDF Fractions in Germany: Processing and Costs", *SARDINIA 99 Seventh Waste Management and Landfill Symposium Proceedings, Vol. I, Landfill Processes and Waste Pre-Treatment*, Cagliari, Sardinia, Italy, pp. 455-464, October 1999.
23. Biala, J. and W. Muller, "Bio-Mechanical Waste Treatment as Part of an Integrated Waste Management Strategy and a Means of Meeting UK and EU Waste Reduction Targets", *SARDINIA 2001 Eighth International Waste Management and Landfill Symposium Proceedings, Vol. I, The Sustainable Landfill*, Cagliari, Sardinia, Italy, pp. 399-408, October 2001.
24. Diaz L.F. and G.M. Savage, "Current Practices and Future Development of Construction and Demolition Waste Management - The International Perspective", proceedings of *International Seminar on Environmental Issues in the Construction Industry*, Hong Kong, September 1998.

CHAPTER VII. USE OF WASTE-DERIVED ORGANIC MATTER AS A SOIL AMENDMENT

A. Introduction

Although the nitrogen (N), phosphorus (P), and potassium (K) contents of organic waste typically are insufficient to permit the waste to be legally termed “fertiliser”,¹ the waste is a source of plant nutrients. When incorporated into the soil, the nutrients increase its fertility. The major utility of organic waste in agriculture is not its NPK content, however; it is its beneficial effect on the structure and other characteristics of the soil. Nevertheless, although the fertiliser aspect may be secondary, it should not be overlooked.

Organic wastes suitable for use in crop production fall into three broad groups: garden and crop debris, animal and human wastes,² and food preparation and food processing (e.g., cannery) wastes.

Raw organic wastes can be used either directly after they are generated, or they can be composted prior to application. Some preparation of the wastes, such as dehydration or shredding, may precede direct application. Each mode (i.e., direct vs. composted) has attendant advantages and disadvantages, the nature of which becomes apparent as this chapter advances.

The form in which fertiliser elements (NPK, and others) occur in processed and in raw, i.e., unprocessed, organic waste has an important bearing on the application of the waste. The elements are almost entirely in the form of organic molecules. In unprocessed waste, the elements are bound mostly in plant and animal cellular protoplasm. As the waste decomposes, the elements are gradually transformed into microbial protoplasm, and into intermediate and final breakdown products. Among the latter, ammonium and ammonia-nitrogen are especially important. The practical significance of the elements being bound in organic molecules is that upon the introduction of the waste into the ground, only a fraction of its nutrients immediately becomes available to a crop. For example, it is estimated that only about 30% to 35% of the nitrogen in compost is available for utilisation by crop plants during the first year after application. However, in succeeding years, the nitrogen and the other elements eventually become available.

B. Utilisation of raw organic waste

B1. PREPARATION

Type and extent of preparation depend upon several factors, among which four are particularly important. They are: 1) physical characteristics of the waste, 2) whether or not the waste can be incorporated into the soil in its present state, 3) time lapse between generation and application of the waste (storage time), and 4) distance to the site of use. Population density and proximity to the generation and application sites might be fifth and sixth factors.

B2. PARTICLE size

Particle size is one of the physical characteristics that serves as a decisive factor in the determination of the feasibility of direct application. The maximum permissible particle size is the largest at which a waste can be manipulated by the machine or by the labourer who spreads it on the land. Additionally, it is the size beyond which the waste cannot be completely covered with soil or would require an inordinately deep incorporation into the soil to do so. The dimensions of the maximum particle size probably can be larger if the material is to be

incorporated manually. A machine has an inflexibly uniform depth tolerance, whereas a labourer can adjust his tilling to suit the size of the particles -- within reason.

The molecular composition of a waste particle also has a bearing on its maximum permissible dimensions. The particle size suited to a refractory material (difficult to decompose) is smaller than one suited to a material that can be readily decomposed. For example, woody material should have a maximum particle size of 1 or 2 cm; whereas most green (raw) vegetable trimmings and crop debris usually do not require size reduction. Of course, stalks of plants that are more or less a meter in length should be chopped into 30-cm sections -- mainly for convenience of handling. If the paper is removed, raw refuse, especially in the lesser industrialised countries, need not be size reduced. If an appreciable amount of paper is present, the paper should be shredded to a maximum particle size of about 12 cm.

Size reduction as a means of preparation for direct application of raw wastes should be avoided unless it is seriously needed. The reason is economic in nature. Generally, direct application is selected only because economic constraints rule out a more sophisticated approach (e.g., composting).

B3. DEHYDRATION

The potential generation of foul odours should be carefully considered, particularly in locations where there may be a high concentration of grass clippings and food residues. Dehydration is a preparatory step that could be done with much advantage. Dehydration is indicated in situations in which storage time and distance of transport are significantly long. It also might be required if the generation and collection areas, as well as the disposal sites, are in relatively densely populated areas.

The utility of dehydration comes from the fact that it leads to a more or less complete cessation of microbial activity responsible for odorous breakdown products. Microbial activity ceases completely when the moisture content drops to 12% (on a wet weight basis), and declines rapidly as that level is approached. Moreover, dehydration renders the material less attractive to vectors, makes the material easier to handle, minimises drainage during storage and transport, and decreases the weight and volume of the material to be transported. Loss in weight and volume is significant because the 85% to 95% moisture found in most living matter is reduced by 50% to 55%.

Dehydration should be limited to that which can be attained through air drying and exposure to the sun. Spreading on an exposed surface or placing on racks are two ways of bringing about dehydration; the cost of dehydration by means other than these two is prohibitive. Whatever the method of drying, appropriate precautions should be taken to prevent excess untreated liquid from harming the environment.

B4. EXAMPLE of direct application

Finally, as a point of interest, mention is made of an experiment to apply raw organic material that was tried first in the United States (Texas) and later in Israel [1]. In Texas, the attempt was unsuccessful; whereas in Israel, the attempt was very successful. In the attempt in Israel, 8 Mg of organic garbage (food preparation wastes) were spread upon a 0.25-ha plot of desert wasteland. The waste was sowed with seeds of a high-protein animal feed and a white wheat. Seeds and waste were covered with sand. The plot received no watering. Yield from the 0.25-ha plot was 4 Mg of animal feed. According to the author of the article, substantial yields were obtained over the ensuing ten years without resorting to watering or further reseeded.

C. Evaluation of direct application

C1. ADVANTAGES

The primary advantage of direct application of raw organic wastes is economic. The elimination of processing made possible because of direct application can reduce costly investment. The processing is costly because it involves the use of equipment. Another advantage is a probable reduction of the loss of nutrients that usually characterises processing. A common example is a loss of ammonia-nitrogen during composting. Another potential advantage is a reduction in the land area requirement because no land is involved in processing operations. In summary, most of the benefits arising from the incorporation of organic matter in soil can be attained with a smaller expenditure of effort, time, and money than is entailed in processing the waste prior to utilisation.

C2. DISADVANTAGES

Unfortunately, the advantages to be gained from the direct application of raw organic waste are strongly tempered by several limitations and constraints that pertain to crop production, maintenance of a quality environment, and safeguarding the public health. The site should be isolated and well managed; otherwise, the generation of foul odours alone will lead to numerous complaints.

C2.1. Crop production

Studies in Europe indicate that composted waste significantly surpasses raw organic waste in terms of promoting plant growth. Additionally, common gardening and farming experience demonstrates that the direct application of fresh manure can seriously damage plants and in general inhibit plant growth, unless precautionary measures are taken. The severity of the damage depends upon the degree of freshness and characteristics of the manure, which depend on the animal source. For example, damage from applying fresh cow manure, though significant, is not as severe as that from applying fresh chicken or swine manure. The adverse consequences from the use of fresh crop debris and urban refuse are much less drastic.

A severe form of the damage is the so-called “burning” that soon follows the application of a fresh raw waste. The burning is comparable to that which results from excessive application of chemical fertiliser (e.g., ammonium sulphate). In less severe cases, plant damage is manifested as a general stunting of plant growth.

The usual mechanism of the damage is the release of toxic concentrations of ammonia in the root zone. If the concentration is sufficiently great, plant roots are killed. Another possibility is the formation of toxic breakdown products. It should be noted that the application of incompletely composted material can have similar consequences.

One precautionary measure consists of spreading the material on the field in the autumn. However, in regions characterised by winter snows, there is the danger of eutrophic elements (e.g., NPK) being transported to receiving waters by way of the melting snow. The same possibility of polluting receiving waters applies in regions characterised by heavy rainfall during the period when the fields lie fallow. A second measure is to interpose a 10- to 20-cm layer of soil between the raw waste and the expected root zone. A third measure is to reduce the thickness of the layer of raw waste -- the assumption being that the waste will be sufficiently decomposed before plant seeds have germinated and the root system of the seedlings has developed.

The limitations described in the succeeding paragraphs apply only to raw wastes that are highly perishable in nature or are animal body wastes. Most types of field crop debris do not fit into the highly perishable classification.

C2.2. Public health hazard and environmental degradation

As was stated earlier, unless suitably protected during storage and transport, raw municipal organic wastes serve not only as attractants but also as sources of nutrient and as shelters for rodents and vectors. Rodents are attracted by wastes of plant origin and rarely, if at all, by manures. The potential of raw organic waste to attract and serve as a nutritional source for rodents and vectors was illustrated in an unpublished study conducted in the United States in the 1960s. (At that time, the organic content of United States refuse was much higher than it is at present.) The study demonstrated that an open dump containing municipal refuse can serve as a focal point for the spread of rat populations over an area with an 8-km radius. The spreading area of flies is about the same. The entire reproductive cycle of flies can and does take place in decaying organic matter. Major deterrents to flies are a low moisture content and either very low or very high temperatures.

Two other disadvantages are aesthetic in nature. One is the production of objectionable odors. Under an appropriate combination of conditions, the foul odour emission may become very intense. The second aesthetic affront is the unsightliness of raw wastes, especially of the garbage from the preparation of food.

Environmental and public health problems can be considerably lessened by preventing access by undesirable organisms (macro- and micro-) during storage and transport. In the field, they can be well controlled by incorporating the wastes into the soil as soon as is possible after the spreading.

D. Economics

If no preparation is required, the major cost prior to application is that of transportation. It is possible for transportation costs to become the key factor in the decision to utilise or not to utilise a raw waste. The existing economic situation is such that the economically permissible longest distance of transport is soon reached. Since the late 1960s, the unit cost for truck transport in the United States has doubled, and in some cases tripled. A similarly precipitous rise in costs prevails in developing countries.

If the material is to be stored, the cost of constructing a suitable enclosure becomes an important factor. Covering the material with screening would exclude flies and rodents. However, screening would do nothing about unsightliness or emission of odors.

Health authorities in the United States have concluded that beef and dairy cattle manures can be stored satisfactorily only in a concrete tank. Storage in a concrete tank or other durable container eliminates leachate formation, as well as wards off fly and rodent invasion. Despite these benefits, the cost involved in building concrete tanks is likely to exceed the economic capacity of most developing countries. On the other hand, the likelihood of prolonged storage in a developing country is remote.

E. Use of composted waste

E1. DESCRIPTION of product

Waksman defines humus as being a complex aggregate of amorphous substances resulting from the microbiological activity that takes place in the breakdown of plant and animal residues.

Properly composted waste fits Waksman's definition of humus [2,3]. In terms of chemical makeup, compost is a heterogeneous mixture of substances that includes a variety of compounds synthesised by the microbial populations of complexes resulting from decomposition, and of materials resistant to further breakdown. Thus, derivatives of lignins, proteins, certain hemicelluloses, and celluloses are compost's principal constituents. Inasmuch as it is a humus, compost is not in a biochemically static condition. Therefore, under appropriate conditions, compost will be further decomposed by microbes and to some extent by higher forms of life (e.g., earthworms and insects). Eventually, it is oxidised to mineral salts, carbon dioxide, and water. Because compost is a humus, it has an ample capacity for base exchange, with consequent swelling.

E2. APPEARANCE

The appearance of the compost product directly after the processing phase strongly depends upon the physical characteristics of the waste. However, regardless of origin, the product is dark brown to dark grey in colour. Unless the moisture content of the material is lower than 15%, decomposition continues. Decomposition is accompanied by change in appearance. If the compost product is stored sufficiently long, it eventually approaches the consistency of a fine dust. Because this eventual change in appearance also betokens a radical change in properties, all descriptions in this section refer to the compost product directly after it has been discharged from the compost facility.

Unless all newsprint and cardboard are removed in the pre-processing stage, composted mixed municipal refuse from industrialised countries will contain a sizeable amount of paper in the form of bits of recognisable paper. Similarly, straw, wood, or other resistant material may also be recognisable. Despite the fact that the bits of paper, wood, straw, etc. are recognisable, chemical and physical processes significantly alter their natures. For example, the bits are much more brittle than they were prior to composting. The change is manifested as a drastic increase in the ease with which the material can be further size reduced.

Glass shards and plastic film from composting mixed waste detract from the appearance, and to some extent from the utility of the product. Unfortunately, they are not easily removed; although screening may help to some extent. The visual attractiveness of the compost product can be enhanced by screening and shredding such that its particle size becomes relatively small and uniform. The alternative, of course, is to compost source-separated materials.

The composting material takes on an earthy odour toward the end of the processing phase, usually at the same time that fungi and actinomycetes make their appearance. The earthy odour mingled with slightly musty overtones continues to be a characteristic of the product long after the processing phase has been completed.

E3. PRODUCT specifications

Although the compost product does have a fertiliser value, as stated before, its nitrogen, phosphorus, and potassium (NPK) contents do not meet the usual legal definition of "fertiliser". Because the NPK of the product reflects that of the raw material, use of a high NPK raw waste results in a high NPK compost product. The converse is true for a low NPK raw waste.

Examples of nitrogen concentration (dry wt. basis) of municipal refuse typically encountered are as follows: United States, 0.5% to 1%; São Paulo, Brazil, approximately 2% to 4%; Mexico City, approximately 2% to 4%; and India, about 1% to 2%. The nitrogen content of composted cattle manure may be as little as 0.5% or as much as 2.5%. Composted fowl manure, pig manure, and sheep manure reflect the substantial nitrogen concentrations of the raw manures. The phosphorus

content of composts generally is only slightly less than that of the nitrogen content. When municipal refuse is composted, the potassium (K) content generally is much lower, unless wood ash is present. The low potassium content is not a serious nutrient deficiency in areas where the soil is alkaline.

The carbon-to-nitrogen ratio (C:N) declines during the compost process, because carbon is lost by way of the carbon dioxide formed in microbial metabolism. However, the decline is not proportional to carbon dioxide formation, inasmuch as some nitrogen also may be lost in the form of ammonia. The final C:N may range from about 30:1 to about 20:1. Decline is not uniform. If the process is carried out properly, the C:N of the product does not exceed 20:1.

The C:N is critical to crop production. An excessively high C:N can lead to a nitrogen shortage for crop plants. The shortage ultimately is a result of the disparity between higher plants and soil microbiota for the available nitrogen. The microbes are more efficient in assimilating nitrogen than are higher plants. The upper critical C:N depends upon the availability of carbon to microbial assimilation and metabolism. The more difficultly available the carbon, the higher is the permissible C:N. Thus, if the major portion of the carbon is a substance that is difficult to decompose such as wood, straw, and paper, the upper level is about 35:1.

As is characteristic of all living cells, synthesis of new protoplasm (i.e., growth and proliferation) and metabolism occur with an inevitable simultaneity if nitrogen is available. If the supply of nitrogen is insufficient to fulfil the demands of all organisms present in the soil, the organisms compete with each other for the available nitrogen. Organisms that are the most efficient in nitrogen assimilation take up most of the available nitrogen -- at the expense of the less efficient organisms. The latter then exhibit symptoms of nitrogen deprivation -- namely, chlorosis and a general stunting of plant growth.

An excessively high C:N can be compensated by simultaneously applying a nitrogen-rich fertiliser with the compost.

If most of the carbon is readily available (e.g., green plants, food preparation waste), then the permissible C:N is lower -- namely, on the order of 20:1. If the C:N is too low, there is some danger of the occurrence of plant damage, i.e., "burning".

E4. GRADING the product

The variations in visual and nutritive qualities of composts bring up the advisability of grading the product, either as a single mass, or as subdivided into fractions separated on the basis of differences in quality. In most cases, effective utilisation of the product depends upon the imposition of grading. The rationale for grading is in part the fact that applications differ among themselves with respect to the quality of compost required for them. For example, reclamation of land despoiled by strip mining can be satisfactorily accomplished with a relatively poor grade of compost; whereas, a very high-grade product would be needed for vegetable production.

Grading can be based upon: 1) NPK content; 2) particle size and uniformity of particles; 3) extent of contamination with glass and plastics; and 4) freedom from pathogens and toxic organics and metals. The data in Table VII-1 indicate allowable concentrations of individual heavy metals permitted in the marketing of European composts. A possible fifth basis might be degree of "maturity", i.e., age of the compost product.

Table VII-1. Compost standards in some European countries (mg/kg, dry)^a

Country	Pb	Ni	Cd	Hg	Cr	Cu	Zn
Netherlands	65 to 100	10 to 20	0.7 to 1	0.2 to 0.3	50	25 to 60	75 to 200
France	800	200	3	8	--	--	--
Austria	45 to 200	25 to 100	0.7 to 3	0.4 to 3	70 to 250	70 to 500	200 to 1,800
Germany	100 to 150	35 to 50	1 to 1.5	0.7 to 1	70 to 100	70 to 100	300 to 400
European Community	45 to 100	25 to 50	0.7 to 1	0.4 to 1	0.7 to 1	70 to 100	200 to 300

Source: Reference 8.

^a Where two values are given, they denote compost meeting different regulatory conditions, classes of compost, or uses. If two values are indicated for a given metal, they reflect different limits based on specific class of compost, on allowable uses, or on different regulatory conditions.

Obviously, a top-grade (grade-1) product is one that is free of contaminants, is safe in terms of public health, has a uniformly small particle size, and has an NPK approaching that is legally expected of a fertiliser (about 6%). It would be suitable for the more demanding applications; as, for example, production of vegetables destined for human consumption, either with or without being cooked.

The following specifications are suggested for grade-2 and grade-3 composts. Grade-2 compost would be one that has a maximum particle size larger than that of the grade-1 product; a likely size would be 3 to 6 cm. Grade-2 compost could include some glass and plastic bits, have a C:N of at most 30:1, and would be free of pathogens. Grade-2 compost would be suitable for use in orchards and in raising field crops (e.g., forage, grain). Composts that do not meet specifications for grades 1 and 2 would be relegated to the grade-3 category. Grade-3 composts could be satisfactorily used in most land reclamation schemes. Other standards could be established to meet situations peculiar to the countries destined to use the compost products.

E5. METHOD of applying

Equipment for applying, i.e., using, compost is the same as that described for applying raw organic material. The principal difference between the use of raw organic material and the use of compost in the field is that the compost product can come into direct contact with the plants without harming them. This latitude makes it unnecessary to interpose a layer of soil between the root zone and the compost. Moreover, the compost can be used as a mulch without danger of generating a nuisance. In relatively small areas, compost can be applied manually. In larger applications, the material can be distributed by means of a manure spreader or vehicles specially made for that purpose. The spreaders range in capacity from about 4 to 13 m³. The units are powered from a tractor's power take-off (PTO) and are capable of distributing the material at variable rates. The price of manure spreaders in the United States varies from about US\$8,000 to US\$11,000.

E6. LOADING rate

A prime constraint on the upper limit of the compost loading rate is the importance of not adding more plant nutrients (particularly NPK) than are required for crop production. Of the three elements, nitrogen is of the greatest concern. Consequently, the maximum amount of compost

that can be applied without giving rise to a problem is that which contains no more nitrogen than is used by the crop during the growing season. For example, if the intended crop is corn (maize), the addition of about 224 kg of nitrogen per hectare would be permitted. If the compost has a nitrogen concentration of 2%, theoretically the maximum permissible loading would be about 11 Mg/ha. However, because only about 35% of the nitrogen in the compost is available to the plants in year-1, the loading could be about 30 Mg/ha. In determining the compost loading in the succeeding years, it should be remembered that the remaining nitrogen eventually becomes available to the plants, i.e., 30% to 35% in year-2, and the remainder in year-3. An indication of actual amounts released each year is given by the data in Table VII-2.

The importance of maintaining a balance between nitrogen added and that consumed arises from the fact that excess nitrogen is oxidised to nitrate by soil bacteria. Because the nitrate is soluble, it can be leached to the groundwater and thereby detract from the quality of the water. Amounts of NPK utilised by various crops are listed in Table VII-3.

The maximum permissible loading with composts that contain substances toxic to the plant, animal, and human members of the food chain is determined by multiplying the concentration of the objectionable substances in the compost by the number of Mg at which the upper permissible loading would be reached. Of course, the maximum amount that can be applied without damage is the difference between the amount at which damage occurs and that already in the soil. The quantity of compost per hectare is easily estimated according to the equation:

$$x = \frac{y}{z}$$

where:

- x = the total amount of compost per unit of area (Mg/ha),
- y = the permissible maximum amount (kg) of the objectionable substance per hectare minus the amount already in the soil, and
- z = the concentration of the substance per unit mass of compost (kg/Mg).

Table VII-2. Quantity of nitrogen released annually from compost incorporated into the soil

Organic-N in Compost (%)	Amount of Nitrogen Released (g/Mg compost added)		
	Year-1	Year-2	Year-3
2.0	454	408	408
2.5	544	544	499
3.0	635	635	590
3.5	771	726	680
4.0	862	816	771
4.5	998	952	907
5.0	1,088	1,043	998

Table VII-3. NPK requirements by various crops

Crop	Phosphorus (kg/ha)	Nitrogen (kg/ha)	Potassium (kg/ha)
Corn	39.2	207	199
	49.3	269	223
Corn silage	39.2	224	227
Soybeans	23.5	289	112
	32.5	376	134
Grain sorghum	45.0	280	186
Wheat	24.6	140	102
	26.9	208	150
Oats	26.9	168	140
Barley	26.9	168	140
Alfalfa	39.2	504	446
Orchard grass	49.3	336	348
Brome grass	32.5	186	236
Tall fescue	32.5	151	172
Bluegrass	26.9	224	167

Soil factors that determine the concentration in the soil at which a toxic element becomes inhibitory to a crop plant or hazardous to a consumer of the crop are pH, organic matter content, degree of aeration, structure and ion-exchange capacity, and amount of uptake of a toxic element by the plant. The mechanisms that make the factor effective are their impacts, combined and individually, on the solubility of the substance in question. Solubility becomes the ultimate factor in that a plant can assimilate substances that are in solution and the toxic substance can exert its harmful effect only if it is assimilated by the plant. The only exception is if the substance is physically destructive of plant tissue, as is ammonia with plant root hairs. Moreover, the substance becomes hazardous to humans only if the concentration of the substance in the edible portions of the plant is at a level toxic to the consumer.

Generally, heavy metals that are toxic to plants and potentially so to humans are insoluble at pH levels higher than 7.0 (alkaline soils). Increasing the organic concentration, promoting aeration, and ensuring a high exchange capacity in the soil magnifies the immobilisation or fixation accomplished by chelation, ion exchange, or by being rendered insoluble. The addition of compost amplifies all three factors. Consequently, the upper permissible limits are raised by incorporating compost into the soil. This fact should be taken into consideration in the determination of maximum permissible loadings. For a detailed discussion on the heavy metal problem, the book by Leeper [4] is an excellent reference.

Another important factor to consider is the concentration of salt in the compost. Based on their relative tolerance to salt, plants are divided into two general groups: halophytes and glycophytes. Halophytes are those plants native to saline environments and glycophytes are those species less tolerant to salts. Glycophytes have wide differences in sensitivity to saline conditions. Most crop species are glycophytes. Phytotoxic effects to plants are a function of both quantities and types of salts responsible for the saline conditions in the soil. Both leaf expansion rates and root growth are impacted by saline conditions. Reduction in plant growth has been attributed to the impacts of salts in the reduction of the water potential [6]. Some general guidelines on the salinity of soil and its effect on plant growth are presented in Table VII-4.

Table VII-4. Salt content and its impact on plant growth

EC (mS/cm)			Examples of Plant Species
Normal Yield	Sharp Fall in Yield	Plant Reaction to Salt	
< 2.0	> 4.0	sensitive	all seedlings, apples, peaches, beans
< 4.0	> 10.0	fairly tolerant	wheat, maize, alfalfa, vines
< 10.0	> 16.0	very tolerant	spinach, barley, sugarbeet
> 16.0		salt-loving	few saline plants grow

Source: Reference 7.

Nutrients and soluble ions such as nitrate, ammonium, calcium, potassium, magnesium, chloride, sodium, carbonates, and bicarbonates contribute to the soluble salt content of soil amendments and water. The concentration of soluble salts in compost should be measured periodically. Measurement can be accomplished by recording the electrical conductivity (EC) of the material. Electrical conductivity of a sample of compost can be obtained by preparing an extract of saturated compost. The extract can be prepared by mixing in a beaker about 500 mL of compost with enough distilled water to saturate the material. The mixture is allowed to stand for about 1 hour. After one hour, the suspension is filtered through filter paper (the authors have used coffee filters). The EC of the saturated solution is then measured. Conductivity is expressed in millisiemens per cm (mS/cm), or mmho/cm (1 mho = 1 S). A millisiemen is equal to a millimho. The relationships between electrical conductivity (EC) and salt concentrations are as follows:

- Total ion (anion and cation) concentration expressed in meq/L is equal to about 10 x EC (in mS/cm).
- The concentration of salt in mg/L (ppm) is equal to about 640 x EC (mS/cm).

Under certain conditions, such as is the case when compost is used as container medium, excessively high concentrations of salts can be reduced by leaching. If the application of compost is being considered in catchment areas for drinking water or in other protected areas for water supply, care must be taken to have a thorough understanding of the soluble salt concentration of the compost, typical rainfall, quality of the groundwater, and the conditions of the soil prior to application in order to prevent contamination of the water.

Desirable concentrations of soluble salts for compost for use in agricultural applications are within the range of 2.0 to 3.5 mS/cm.

In conclusion, loadings of about 10 Mg of compost/ha/yr, or from 20 to 30 Mg/ha/3-yr interval, generally are acceptable. Specifically, the latter alternative would involve incorporating 20 to 30 Mg in year-1 and no application in years 2 and 3. Lower loadings would be indicated for composts made from biosolids produced in an industrial sector, or from a waste that contains a sizeable amount of wood or coal ash, or an exceptionally heavy concentration of nitrogen.

F. Benefits from the application of compost to the soil

The benefits from the application of compost to the soil include those alluded to in preceding paragraphs and in the section on raw wastes. Among the benefits are enrichment of the NPK content of the soil, albeit not to the extent accomplished by the standard application of a chemical fertiliser. Nevertheless, because of the NPK in the compost, the amount of chemical fertiliser added can be reduced in proportion to the NPK concentration in the compost. Indeed, the amount

of reduction in the required chemical fertiliser dosage is more than the simple difference between total amount required and that in the compost. Less chemical NPK is required because the presence of compost (or of any other biological organic matter) increases the efficiency of chemical NPK utilisation. The increased efficiency ultimately is the result of the conversion into microbial cellular mass of chemical fertiliser not used by the crop. NPK bound in microbial cellular mass is slowly released as the microbes die off. If organic matter had not been present, 30% to 35% of the nitrogen, 20% to 30% of the phosphorus, and a lesser fraction of the potassium added as chemical fertiliser would have been leached beyond the root zone, and thus could not have contributed to crop production.

The storage of phosphorus is accomplished through the agency of organic acids synthesised in the metabolic breakdown of organic matter. The acids form a complex with inorganic phosphates in the soil and thereby render the phosphorus more readily available to higher plants. Phosphorus as well as nitrogen are in effect “stored” in a manner peculiar to humus, in that precipitation of phosphorus by calcium is deterred and nitrogen is converted into microbial protoplasm. The conversion of nitrogen into microbial protoplasm interferes with the nitrogen mineralisation (nitrification) that would otherwise be the fate of nitrogen introduced into the soil and not rapidly assimilated by plants thereafter. Prevention of nitrification, in turn, protects the quality of groundwaters from being degraded. Not to be overlooked is the fact that compost is an excellent source of trace elements.

Another major benefit of the use of compost is a substantial improvement of soil structure. With respect to fertility, structure ranks with nutrient content. The improvement in soil structure results from the tendency of compost to bring about soil aggregation. Aggregation is accomplished through the agency of various cellulose esters formed in microbial metabolism. Aggregation imparts a crumb-like texture to soil, i.e., makes the soil friable. Friability is closely related with soil aeration and water-holding capacity. The more friable a soil becomes, the greater will be its water-holding capacity and its state of aeration. Because aeration and moisture are important factors in root system development, plants grown in compost-enriched soils characteristically have well developed root systems.

Another aspect of the water conservation potential of compost is the use of compost for mulching. A layer of compost mulch on the soil is a physical barrier to evaporation. The utility of compost as a mulch is furthered by the fact that eventually it can be incorporated into the soil and therein enhance its beneficial effects. The beneficial effects with respect to chelating and fixing heavy metals were described in the section on loading.

A final and important benefit is an accompanying increase in the resistance of crops to many plant diseases. Whether the increased resistance is due to the vigorous growth encouraged by the presence of compost or whether it is due to an actual development of an immunological response in the plant itself is immaterial; the result is the same. For example, Filipi and Pera have demonstrated that the use of mixes amended with composted pine bark can suppress *Fusarium* wilts of carnation [5].

G. Limitations to the application of compost to the soil

In this section, limitations are discussed related to public health that were not mentioned in the section on loading. Also covered are limitations pertaining to transport and to the mechanics of applying the compost on the field.

G1. PUBLIC health

Public health hazards arise when the product is composted human excrement or is composted industrial wastewater solids (i.e., sludge). Wastes from diseased animals could be ranked with human excrement as a hazard to public health, but perhaps to a lesser degree. Only those pathogens not exterminated during or after composting pose a hazard to public health.

It is important to keep in mind that passage through the compost process is not of itself a guarantee that all viable pathogens have been killed, and hence that the product is entirely free of viable pathogens. The reality is that the intervention of some factor may have prevented exposure of all pathogens to the bactericidal conditions associated with the compost process. Pathogens that escape these conditions can subsequently recontaminate “steriled” material. A single kilogram of insufficiently exposed infested or contaminated material can recontaminate an entire pile of compost.

For example, failure to expose all material in a composting pile to temperatures lethal to pathogens can result in pockets of contaminated material. Subsequent turning or other redistribution of material can lead to a recontamination of the entire composting mass. In systems that involve no turning, and in which sufficiently elevated temperatures seemingly should prevail throughout the composting mass, pockets of low temperatures might nevertheless exist.

A factor that amplifies the effects of high temperature and may even compensate for incomplete exposure to high temperature is the collection of inhibitory phenomena that begin in the composting mass at the time compost conditions are imposed and end when the process is terminated. Because the phenomena are time-dependent, loosely speaking it might be said that passage of time more or less compensates for shortcomings in exposure to high temperature. Thus, passage of time allows: 1) destruction of pathogens, 2) competition with non-pathogenic microorganisms, 3) antibiosis, and 4) the development of a less than favourable environment.

An important factor regarding pathogen survival and multiplication is the fact that the normal habitat of pathogens is the human body. Because of this, nutrient sources useful to pathogens are compounds usually found only in the human body. Therefore, only a relatively few compounds in a composting mass can be used as nutrient sources by pathogens. These compounds are rapidly destroyed under composting conditions.

Because they are adapted to the protective environment provided by their host, pathogens are at a disadvantage when competing with microbes indigenous to the habitat constituted by the composting material. Moreover, the presence of some antibiotics is ensured by the proliferation of actinomycetes and fungi normally characteristic of composting. For example, species of *Streptomyces* (actinomycete) and *Aspergillus* (fungus) appear in substantial numbers during composting. Therefore, all things considered, a year of storage should be ample for rendering a product safe for most uses.

G2. TRANSPORT and application mechanics

The bulky nature and low density of the dry compost product are responsible for most of the difficulties that pertain to transport and mechanics of applying the product. Because the volume-to-weight ratio is higher, a low-density product is more expensive to transport than is one of a high density. Inasmuch as compost generally is an uncompacted low-density product, the volumetric capacity of the transport vehicle is reached long before its weight capacity. The bulkiness and low density of compost necessitate the use of bulky equipment to spread it on the field. As previously indicated, a manure spreader can be used or adapted to apply compost to the field. With regard to manual application, more trips per unit mass of material are needed.

Nevertheless, these disadvantages are minor in comparison to the many benefits to be gained from the use of compost.

This chapter has provided the motivation for composting through a description of the many uses of the compost product. The efficient production of the product is the goal of Chapter VIII, Composting.

H. References

1. Ragen, N., "The Struggle for Israeli's Environment", *Hadassah Magazine*, November 1979.
2. Waksman, S.A., *Humus* (ed. 2), Williams-Wilkins Company, Baltimore, Maryland, USA, 1938.
3. Waksman, S.A., *Soil Microbiology*, John Wiley and Sons, New York, New York, USA, 1952.
4. Leeper, G.W., *Managing the Heavy Metals on Land*, Pollution Engineering and Technology Series, Marcel Dekker, Inc., New York, New York, USA, and Basel, Switzerland, 1978.
5. Filipi, C. and A. Pera, "The Role of Telluric Microflora in the Control of Fusarium Wilt of Carnation Grown in Soils With Bark Composts", *Biol. Wastes*, 27:271-279, 1989.
6. Rendig, V.V. and H.M. Taylor, *Principles of Soil-Plant Interrelationships*, McGraw-Hill Publishing Company, New York, New York, USA, 1989.
7. Anonymous, *Quality Criteria Application and Recommendations for Compost Derived from Solid Waste or Solid Waste/Sludge*, (Compost Standards of West Germany, "Merkblatt 10"), Document No. TVAB/18.Lfg. II. 85, (Translation from German), 1984.
8. The Waste and Resources Action Programme, *Comparison of Compost Standards Within the EU, North America and Australasia, Main Report*, June 2002.

Notes

¹ To legally qualify as a fertilizer in the United States, the NPK content must be at least 6%.

² Because of grave hazards to public health, human excreta must be treated in a manner such that pathogens and parasites are destroyed before applying in the field.

CHAPTER VIII. COMPOSTING

A. Introduction

In economically developing countries, constraints related to economics, technology, and qualified personnel have narrowed the choice of acceptable solid waste management, treatment, and disposal options. Viable options include minimisation, recycling, composting, incineration, and sanitary landfilling. Composting is the option that, with few exceptions, best fits within the limited resources available in developing countries. A characteristic that renders composting especially suitable is its adaptability to a broad range of situations, due in part to the flexibility of its requirements. As a result, there is a composting system for nearly every situation; i.e., simple systems for early stages of industrial development to relatively complex, mechanised systems for advanced industrial development.

The compost option affords the many advantages of biological systems: lower equipment and operating costs; in harmony with the environment; and results in a useful product. On the other hand, composting is sometimes attributed with disadvantages often associated with biological systems -- namely, a slow reaction rate and some unpredictability. Regarding the attributed disadvantages, slow reaction rate may be justified, in that retention times are in terms of weeks and months. However, the attribution of unpredictability is not justified. If all conditions are known, applied, and maintained, the course of a given process will be predictable.

Among the major prerequisites for successful composting are a satisfactory understanding and application of the basic principles of the process. Without this understanding, inadequacies of design and operation are practically inevitable. An understanding of the biology rests upon a knowledge of the basic principles of the process. Such a knowledge enables a rational evaluation of individual compost technologies and utilisation of those technologies. An obvious benefit of the knowledge is the ability to select the system most suited to an intended undertaking. An accompanying benefit is the ability to critically evaluate claims made on behalf of candidate systems.

B. Definitions

Two definitions of composting are presented. The first is a definition in the strict sense of the term, which differentiates composting from all other forms of decomposition. The second one is an ecological definition.

B1. DEFINITION in the strict sense

A definition that distinguishes composting from other biological processes is:

“Composting is the biological decomposition of biodegradable solid waste under controlled predominantly aerobic conditions to a state that is sufficiently stable for nuisance-free storage and handling and is satisfactorily matured for safe use in agriculture”.

The terms and phrases that collectively differentiate composting from other decomposition processes are: “biological decomposition”, “biodegradable”, “under controlled predominantly aerobic conditions”, “sufficiently stable”, and “matured”. The phrase “biological decomposition” implies that the decomposition is accomplished by living organisms. “Biodegradable” refers to the substrate and it requires that the substance be susceptible to decomposition attack by certain living organisms, e.g., bacteria and fungi. Such substances are organic compounds formed either by living organisms or by way of chemical synthesis (e.g., halogenated hydrocarbons).

Decomposition of synthetic organics generally involves the activity of certain microorganisms under special conditions. The phrase “under controlled predominantly aerobic conditions” has a twofold significance: 1) it differentiates composting from the random biological decomposition that takes place in nature (e.g., open dump, forest, field, etc.); and 2) it distinguishes composting from anaerobic digestion (biogasification). The criterion for “stable” is safe and nuisance-free storage. The criterion for “sufficiently mature” is oriented to use in agriculture.

B2. ECOLOGICAL definition

An “ecological definition” is as follows:

“Composting is a decomposition process in which the substrate is progressively broken down by a succession of populations of living organisms. The breakdown products of one population serve as the substrate for the succeeding population. The succession is initiated by way of the breakdown of the complex molecules in the raw substrate to simpler forms by microbes indigenous to the substrate”.

C. Active organisms

Mesophilic and thermophilic bacteria and fungi are the predominant organisms during the initial and the active stages of the compost process. The bacteria can be morphologically grouped into the “bacteria proper” and “filamentous” bacteria. In reality, the filamentous bacteria simply are “branched” bacteria, and are members of the actinomycetes. Usually the actinomycetes do not appear in sizeable numbers until the close of the high-temperature active stage of the compost process. Coincidentally with their appearance is a rapid disappearance of cellulose and lignin. Although some nitrogen-fixing bacteria may be present, conditions are not conducive to nitrogen fixation [23].

The onset of the stabilisation stage of the process is attended by the appearance of saprophytic macroflora. Sources of nutrients for the macroflora are inactive microflora and the decomposing wastes. The more minute forms (e.g., paramecium, amoeba, rotifers) are the first to appear. Eventually, larger forms such as snails and earthworms become numerous. Among the earthworms are *Lumbricuse terrestris*, *L. rubellus*, and *Eisenia foetida* [24,25]. The compost mass is fairly advanced by the time the earthworms make their appearance. Of course, the earthworms can be deliberately introduced successfully at some prior time, perhaps even in the relatively early stages [25].

The claimed potential benefits from the utilisation of earthworms in composting have led to the promotion of vermiculture.

C1. VERMICULTURE

In the discussion of vermiculture, it is important to keep in mind that earthworms constitute the end product of vermiculture; and that worm castings are a residue. The castings make up the “compost product” to which the vermiculture proponents refer. Among the numerous benefits claimed for vermiculture are the following: 1) increased particle size reduction, 2) enrichment of the compost product by earthworm nitrogenous excretions, 3) increase in the carbon and nutrient exchange brought about by the enhanced interaction between microflora and macroflora, and 4) the superiority of earthworm castings to the conventional compost product.

Not all of the species of earthworms are suitable for vermiculture (the production of protein and castings). Among the species that can be used in captivity are those commonly known as the red californian (*Eisenia foetida*). Initially, this type of earthworm was selected in order to increase

the quantity of substrate that would be ingested and thus increase the amount of castings that would be produced. Unfortunately, the results of these attempts were not very positive and efforts were diverted toward improving the fertility of the species as well as to try to increase its lifespan.

Each adult earthworm of the californian species measures between 6 and 8 cm in length and about 3 to 4 mm in diameter. The average weight is about 1 g. This species can live up to 6 years.

The principal component of an earthworm is water; it constitutes between 70% and 95% of its weight. The remainder (between 5% and 30%) is primarily protein. The composition of an earthworm on a dry-weight basis is as follows: protein between 53% and 72%, grease between 1% and 17%, and minerals between 9% and 23%.

Vermiculture can be carried out on a small scale. The basic production module typically has about 60,000 earthworms, which can be placed in an area of about 2 m long by 1 m wide, known as a bed. The substrate is placed on the worms at a depth of 15 to 25 cm. Depending upon the climatic conditions, the bed can be protected by means of a simple roof. Similar to any biological process, earthworms will seek favourable conditions. Consequently, the beds must be carefully managed to provide the earthworms with optimum conditions, especially nutrients, humidity (70% to 80%), and temperature (20° to 25°C). In addition, there are certain regimes for feeding (adding the substrate to) the beds to achieve optimum growth and degradation of the organic matter.

Estimates indicate that a basic module of 60,000 earthworms can produce on the order of 800 kg of humus in three months.

Although the earthworms produced in the process constitute a low level source of proteins, they also contain a major fraction of the heavy metal contaminants in the substrate. The reason is the tendency of the worms to store the contaminants in their tissue.

Although vermiculture merits careful consideration, it does have serious limitations and demands careful control, particularly in large-scale systems (i.e., larger than 10 Mg/day). Furthermore, there are situations in which conditions required for their culture may not be achievable. The process has potential in small-scale systems for the treatment of relatively homogenous substrates.

C2. INOCULUMS

The utility of inoculums in compost practice is open to many questions that could well be considered objections. Obviously, the utility of an inoculum is proportional to the extent of the need to compensate for a lack of indigenous population of microorganisms and macroorganisms to decompose (compost) the substrate. Characteristically, most wastes encountered in compost practice have such an indigenous population, and inoculation would be unnecessary. On the other hand, inoculation would be useful with wastes that either lack an indigenous population or have one that is deficient. Examples of such wastes are pharmaceutical manufacturing wastes, wastes that have been sterilised or pasteurised, and wastes that are homogeneous in composition (sawdust or wood chips, rice hulls, petroleum wastes, etc.).

If the need for an inoculum is indicated, one must be developed unless a suitable inoculum is available. As is shown by the discussion that follows, inoculum development is a difficult undertaking that requires highly qualified microbiologists who are thoroughly knowledgeable regarding the compost process.

A serious difficulty is the fact that composting involves a dynamic succession of several groups of microbes sequentially interacting with the substrate. The identification of these microorganisms is the first step in the development, followed by delineation of the respective roles of the identified organisms. Accurate identification and appropriate assignment are particularly difficult when mixed cultures are concerned. To be effective, the organisms in the inoculum must be able to successfully compete with organisms indigenous to the waste. The competitive ability of introduced organisms is adversely affected by the repeated subculturing involved in culture maintenance.

In conclusion, little is gained from the abundant indigenous population of microorganisms characteristic of most inoculated wastes destined to be composted. Before being accepted, claims for an inoculum must be demonstrated to be valid by way of unbiased conducted tests or demonstrations. Moreover, it should be noted that, generally, inoculated microbes do not compete well under practical conditions [26,27].

If an inoculum or additional microorganisms are desired, decomposed horse manure, finished compost, or a rich and loamy soil can serve the purpose. All three materials contain an abundance of microflora. A form of inoculation often used in compost practice is the “mass inoculation”, accomplished by recirculating a fraction of the final product, i.e., adding it to the incoming waste. Other than possibly improving the texture of the incoming waste, the efficacy of such a mass inoculation is debatable.

D. Process factors

In addition to the presence of the needed organisms, major factors can be grouped into three main categories -- namely, nutritional, environmental, and operational. The relative importance of an individual factor is determined by its bearing on the proliferation and activity of the key organisms in the process. The key organisms determine the rate and extent of composting, because they have an enzymatic complex that permits them to attack, degrade, and utilise the organic matter in raw waste. The other organisms can only utilise decomposition products (intermediates). Hence, the composting of a waste is the result of the activities of the previously mentioned dynamic succession of different groups of microorganisms. In short, groups prepare the way for their successors.

D1. NUTRITIONAL factors

A given nutrient in a waste can be utilised only to the extent that it is available to active microbes. Availability takes two forms -- namely, chemical and physical. A nutrient is chemically available to a microbe or group of microbes if it is a part of a molecule that is vulnerable to attack by the microbe or microbes. Usually, the attack, i.e., breakdown, is accomplished enzymatically by microbes that either possess the necessary enzyme or can synthesize it. Physical availability is interpreted in terms of accessibility to microbes. Accessibility is a function of the ratio of mass or volume to surface area of a waste particle, which in turn is determined by particle size.

D1.1. Macronutrients and micronutrients

Nutrients can be grouped into the categories “macronutrients” and “micronutrients”. The macronutrients include carbon (C), nitrogen (N), phosphorus (P), calcium (Ca), and potassium (K). However, the required amounts of Ca and K are much less than those of C, N, and P. Because they are required only in trace amounts, they are frequently referred to as the “essential trace elements”. In fact, most become toxic in concentrations above trace. Among the essential trace elements are magnesium (Mg), manganese (Mn), cobalt (Co), iron (Fe), and sulphur (S). Most trace elements have a role in the cellular metabolism.

The substrate is the source of the essential macronutrients and micronutrients. Even though an element of uncertainty is introduced into an operation, economic reality dictates that a waste constitute most or all of the substrate in compost practice. Any uncertainty is due to variation in the availability of some nutrients to the microbes. Variation in availability, in turn, arises from differences in resistance of certain organic molecules to microbial attack. Variations in resistance lead to variations in rate at which the process advances. Examples of resistant materials are lignin (wood) and chitin (feathers, shellfish exoskeletons), and several forms of cellulose.

D1.2. Carbon-to-nitrogen ratio

The carbon-to-nitrogen ratio (C:N) is a major nutrient factor. Based on the relative demands for carbon and nitrogen in cellular processes, the theoretical ratio is 25:1. The ratio is weighted in favour of carbon, because uses for carbon outnumber those for nitrogen in microbial metabolism and the synthesis of cellular materials. Thus, not only is carbon utilised in cell wall or membrane formation, protoplasm, and storage products synthesis, an appreciable amount is oxidised to CO₂ in metabolic activities. On the other hand, nitrogen has only one major use as a nutrient -- namely, as an essential constituent of protoplasm. Consequently, much more carbon than nitrogen is required. The ratios encountered in waste management vary widely. Generally, the ratio is higher than 8 to 10 parts *available* carbon to 1 part *available* nitrogen (the emphasis on "available" should be noted). In compost practice, it is on the order of 20:1 to 25:1. The general experience is that the rate of decomposition declines when the C:N exceeds that range. On the other hand, nitrogen probably will be lost at ratios lower than 20:1. The loss could be due to the conversion of the surplus nitrogen into ammonia-N. The high temperatures and pH levels characteristic of composting during the active stage could induce the volatilisation of the ammonia.

In a developing country, an unfavourably high C:N can be lowered by adding a nitrogenous waste to the compost feedstock. If economics permit, it also can be lowered by adding a chemical nitrogen fertiliser, such as urea or ammonium sulphate. Conversely, a carbonaceous waste can be used to elevate a low C:N. The nitrogen contents and the carbon-to-nitrogen ratios of various wastes and residues are listed in Table VIII-1.

D1.3. Carbon and nitrogen analyses

Among the several useful analytical methods available for determining nitrogen content, the venerable standard Kjeldahl method continues to be both practical and useful.

Carbon determination is rendered difficult in a developing country by the need for expensive analytical equipment and an appreciable skill on the part of the analyst. Obtaining a representative sample within the very small size limits specified by current methods is an extremely difficult task, especially when dealing with a waste as heterogeneous as is solid waste. A "stop-gap" approach suitable for composting in solid waste management is an estimation based on a formula developed in the 1950s [1]. The formula is as follows:

$$\% \text{ carbon} = \frac{100 \text{ \% ash}}{1.8}$$

Table VIII-1. Nitrogen content and C:N of various wastes and residues

Waste	Nitrogen	C:N
Activated sludge	5	6
Blood	10 to 14	3.0
Cow manure	1.7	18
Digested sewage sludge	2 to 6	4 to 28
Fish scraps	6.5 to 10	5.1
Fruit wastes	1.5	34.8
Grass clippings	3 to 6	12 to 15
Horse manure	2.3	25
Mixed grasses	214	19
Nightsoil	5.5 to 6.5	6 to 10
Non-legume vegetable wastes	2.5 to 4	11 to 12
Pig manure	3.8	4 to 19
Potato tops	1.5	25
Poultry manure	6.3	15
Raw sewage sludge	4 to 7	11
Sawdust	0.1	200 to 500
Straw, oats	1.1	48
Straw, wheat	0.3 to 0.5	128 to 150
Urine	15 to 18	0.8

According to one report [28], values determined by way of the formula were within 2% to 10% of those obtained in the laboratory studies.

In situations in which carbon and nitrogen analyses are not feasible, a workable assumption can be made on the basis of the substrate composition. The assumption is that if the ratio of green (in colour) raw waste (or of food preparation wastes, or of fresh manure) to dry, non-green waste is volumetrically about 1 to 4, the C:N will be within a “permissible” range.

D1.4. Particle size

The size of particles in the waste is a nutrient-related factor, because the waste is the substrate in composting and the substrate is the source of nutrients. The relation to nutrition is the effect of size of the individual particles on the physical availability of nutrients, i.e., accessibility to the nutrients. As was stated earlier, particle size determines the ratio of mass-to-surface and, hence, amount of a particle’s mass that is exposed to microbial attack. Inasmuch as the ratio increases with decrease in size, the rate of decomposition (composting) theoretically should increase with decrease in particle size. However, the theoretical increase does not always materialise in practice. The failure may be due to one or more factors. For example, the physical nature of the substrate may impose constraints in terms of minimum permissible size. The permissible minimum size is the one at which any further reduction would adversely affect the compost process. Ultimately, the criterion for determination of minimum permissible size is the ability to establish a substrate porosity that is consistent with necessary aeration.

Porosity is largely a function of the structural strength of the particle material. Structurally strong, crush-resistant waste materials, such as wood, straw, and paper, remain porous at very small

particle sizes. An appropriate particle size range for such wastes is about 1.5 to 7 cm. A suitable particle size for individual wood chips is about 1 cm in thickness and 2 to 5 cm in width. Particle sizes suitable for fibrous materials and woody trimmings (yard debris) are from about 5 to 10 cm. If the individual branches and twigs are less than 1 cm in diameter, the particle sizes may be somewhat larger. The minimum permissible particle size of soft materials tends to be large, because excessively size-reduced soft materials tend to compact into an amorphous mass that has little or no porosity. Thus, the minimum permissible particle size for fresh plant debris, fresh vegetables, and kitchen wastes could be as much as 15 cm, and even larger with softer materials. Fresh green residues such as lettuce and ripe fruits (e.g., papaya and mangoes) require little or no size reduction.

Unless they are intermixed with an abundance of bedding material, animal manures do not require size reduction. Any size reduction needed would be determined by the characteristics of the bedding material.

In a developing country, there are economic and technological obstacles to the size reduction of wastes intended for composting. Size reduction is usually accomplished with a shredder or grinder, which is a large, expensive piece of equipment. A possible alternative might be to rely upon some form of tumbling to accomplish the relatively limited tearing, breaking, and maceration that would be required. The tumbling could be done by way of a rotating drum or cylinder.

D2. ENVIRONMENTAL factors

The principal environmental factors that affect the compost process are temperature, pH, moisture, and aeration. The significance of environmental factors with respect to the compost process is the fact that individually and collectively they determine the rate and extent of decomposition. Consequently, rate and extent of decomposition are proportional to the degree that each nutritional and environmental factor approaches optimum. A deficiency in any one factor would limit rate and extent of composting -- in other words, the deficient factor is a limiting factor. It is important to keep in mind that the ultimate limiting factor is the genetic makeup of the various microbial populations.

D2.1. Temperature

Although convincing arguments can be made with respect to the advantages of thermophilic vs. mesophilic composting, the question has become moot in compost practice. The reason is that in normal practice, composting begins at ambient temperature (mesophilic range) and progresses to and through a thermophilic phase, followed by a descent to the mesophilic level. The process will follow this course unless preventive measures are imposed.

The compost process is more or less seriously adversely affected at temperatures above 65°C. The reason is that microorganisms characterised by a spore-forming stage do so at temperature levels higher than 65°C. Unless they are thermophilic, other microorganisms either lapse into a resting stage or are killed. Consequently, the current practice is to resort to operational procedures designed to avoid temperatures higher than about 60°C.

D2.2. pH level

The pH level of the composting mass typically varies with the passage of time, as is indicated by the curve in Figure VIII-1. As the figure demonstrates, the level usually drops somewhat at the onset of the compost process. However, it soon begins to rise to levels as high as pH 9.0. The initial drop reflects the synthesis of organic acids. The acids serve as substrates for succeeding

microbial populations. The subsequent rise, in turn, reflects the utilisation of the acids by the microbes.

Because the pH level reached in the initial descent is not inhibitory to most microbes, buffering is unnecessary and could have adverse consequences. For example, the use of lime ($\text{Ca}(\text{OH})_2$) could result in a loss in $\text{NH}_3\text{-N}$ at the relatively elevated temperatures and pH levels that occur as composting progresses. Nevertheless, the addition of lime may be advantageous in some cases. The addition improves the physical condition of the composting mass, perhaps partly by serving as a moisture absorbent. Furthermore, some researchers report that the addition of lime could be of use in the composting of fruit wastes [2], because the initial drop in pH level often is sharper when fruit wastes are composted.

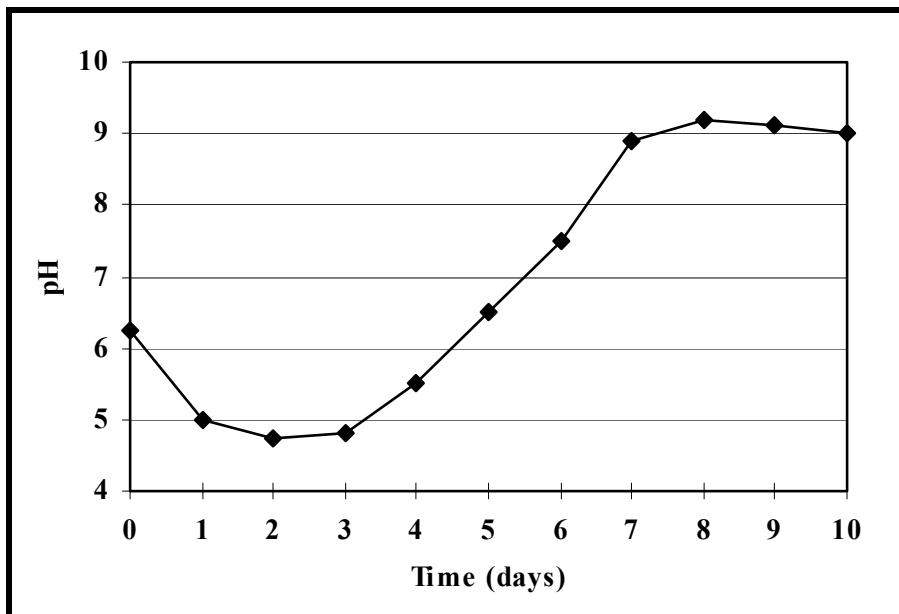

Figure VIII-1. Variation of pH as a function of time in composting

D2.3. Moisture content

An important characteristic of MSW composting is the close relationship between moisture content and aeration -- particularly in windrow composting. The basis of the relationship is the fact that the principal source of the oxygen required by the microbial populations is the air entrapped in the voids (interstices) between the substrate particles. Diffusion of ambient oxygen into the composting mass is relatively minor in terms of meeting the microbial oxygen demand. Inasmuch as the interstices also contain the free moisture in the mass, a balance must be struck between moisture content and available oxygen. For convenience, this balance may be represented by the term “permissible moisture content”. Thus, the maximum permissible moisture content would be that level above which insufficient oxygen would be available for meeting the oxygen demand, and a state of anaerobiosis would develop. Figure VIII-2 indicates the relation between moisture content and air (i.e., oxygen).

Among the physical characteristics of the substrate that affect permissible moisture content is the “structural strength” of the particles that make up the substrate. Structural strength determines particulate susceptibility to deformation and compaction.

Moisture content is somewhat less critical to aeration in the applications that involve the use of in-vessel compost systems, in which the waste is mechanically, and more or less continuously, agitated. Nevertheless, factors other than interstitial limitations may impose an upper permissible

moisture content in those systems. The limitation arises from a general tendency of material to mat, clump, or form balls. This tendency increases progressively to the point at which a slurry is formed. The range of the moisture levels at which these problems appear coincides with that of most upper permissible moisture content levels.

The importance of keeping the moisture content of the substrate above 40% to 45% is often overlooked in compost practice. It is important because moisture content is inhibitory at lower levels, and all microbial activity ceases at 12%.

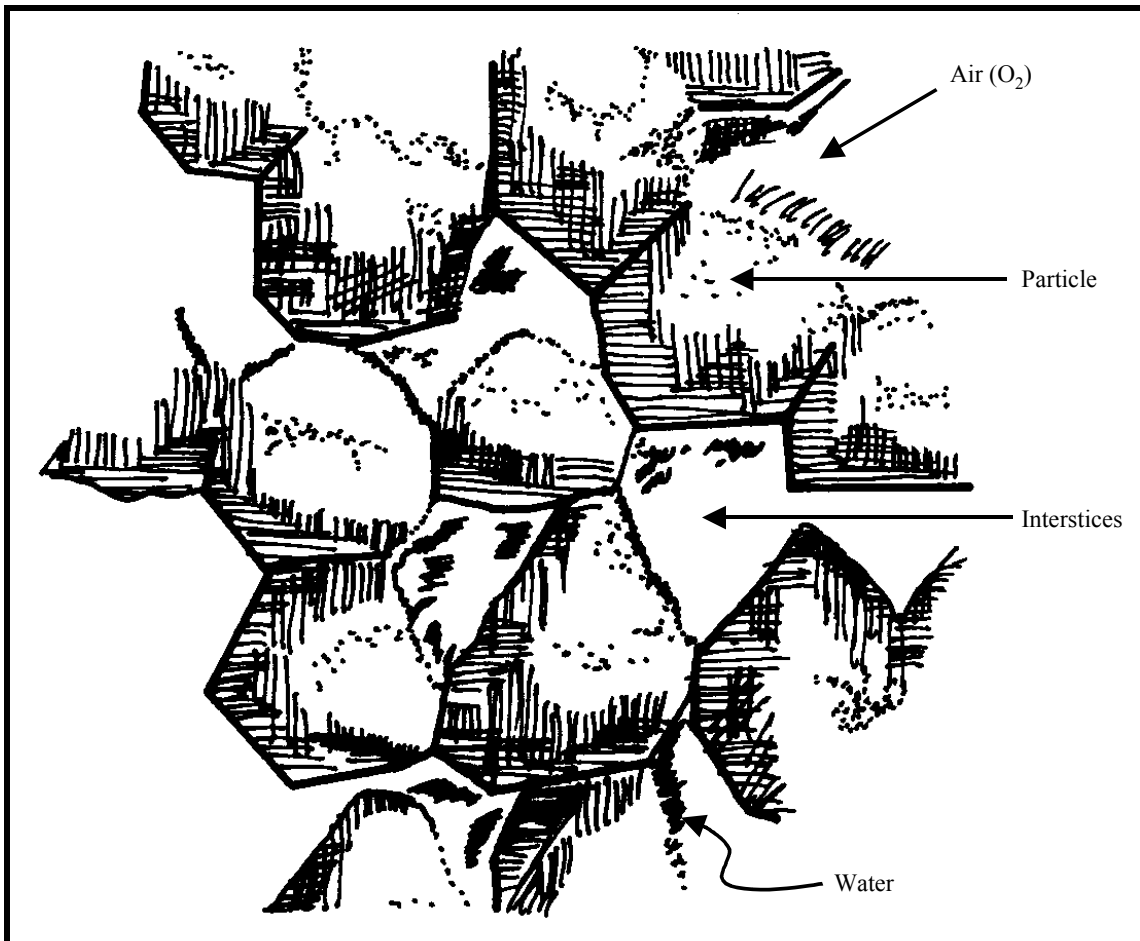

Figure VIII-2. Enlarged illustration of the relationship between air, water, and interstices in composting

D3. AERATION

D3.1. Aerobic vs. anaerobic composting

Originally, anaerobic composting was considered to be a viable alternative to aerobic composting, and strong arguments were made in its favour. One such argument was the supposed minimisation of nitrogen loss; another was a better control of emissions. The reality is that these supposed advantages never seemed to materialise. Even had these advantages materialised, they would not be sufficient to compensate for the demonstrated disadvantages of the anaerobic mode. Doubts about the effectiveness of anaerobic composting began to escalate, and by the end of the 1960s, anaerobic composting generally was considered as an unacceptable alternative. Recently, the trend has been to regard composting as being an entirely aerobic process. However, it is now beginning to be recognised that a transient anaerobic phase is essential in the destruction of

halogenated hydrocarbons by way of composting. This need, combined with conservation of nitrogen, may be sufficient for a transient anaerobic phase to merit serious consideration.

As compared to anaerobic composting, aerobic composting has several potential advantages. Among them are the following: 1) decomposition proceeds more rapidly, 2) temperature levels that are lethal to pathogens are attained, and 3) the number and intensity of objectionable emissions are sharply reduced. The emission of some objectionable odours is an inevitable accompaniment of waste treatment and disposal. The extent and intensity of the odours can be significantly ameliorated in aerobic composting by fully satisfying the oxygen demand of the active microbial populations by the institution of an appropriate aeration program. Emissions can also be controlled by capturing the gases of decomposition from the composting mass and treating them in chemical and/or biological gas treatment systems, which reduces the intensity of the objectionable emissions.

D3.1.1. Aeration rates

The rate of aeration at which a composting mass remains aerobic (i.e., satisfies the microbial oxygen demand) is a function of the nature and structure of the components of the waste and of the aeration method. For example, the oxygen demand of a large and active population, composting a mass of easily decomposed material, obviously would surpass the demand of a sparser and less vigorous population acting upon a refractory material.

The accurate calculation of a specific proper aeration rate is a difficult undertaking. The difficulty arises from problems in the acquisition of realistic data with the use of available techniques and equipment. The diversity of data reported in the literature is exemplified by the results obtained in the following investigations.

One of the early investigations [3,4] involved forcing air at various rates into a rotating drum and measuring the oxygen content of the exiting air. Although the experimental conditions did not justify a determination of the total oxygen demand of the material, the experimental results did indicate the rate of O₂ uptake. The respiratory quotient was found to be 1, i.e., CO₂ produced ÷ O₂ consumed = 1.0.

In another phase of the same investigation, the investigator's concern was about relation of O₂ uptake to principal environmental factors. One of the observations was the not surprising one that rate of uptake increased in proportion to proximity to the optimum level of a factor. For example, the O₂ uptake increased from 1 mg/g volatile matter at 30°C to 5 mg/g at 63°C [4]. On the other hand, O₂ uptake declined in proportion to extent of departure from optimum levels.

The variability is further illustrated by results obtained by other investigators in later years. The following are three examples of these investigations:

1. In one investigation, it was found that O₂ requirements ranged from 9 mm³/g/hr for ripe compost to 284 mm³/g/hr with fresh compost serving as the substrate [5].
2. In another investigation, it was found that oxygen demand ranged from 900 mg/g/hr on day-1 of composting to 325 mg/g/hr on day-24 [6].
3. Uptakes observed in this investigation [7] were 1.0 mg O₂/g volatile solids/hr at a temperature of 30°C and a moisture content of 45%; and 13.6 mg/g/hr at a temperature of 45°C and a moisture content of 56%.

Inasmuch as results obtained by these and other investigators characteristically demonstrated that O₂ uptake depends upon intensity of microbial activity, it should, therefore, decline with increase in stability of the composting mass, i.e., as the mass approaches maturity.

D3.1.2. Prediction of oxygen demand

The full potential oxygen demand cannot be predicted solely upon the basis of amount of carbon that is to be oxidised. The reason stems from the impossibility of arriving at a precise estimate of O₂ requirement on the basis of the carbon content of the waste, inasmuch as some carbon is converted into bacterial cellular matter and some is in a form sufficiently refractory to render its carbon inaccessible to the microbial attack. For purposes of preliminary design of an in-vessel system and a forced-air windrow system, an input air-flow rate of 530 to 620 m³/Mg waste may be assumed [3]. Aeration rates used in the final design should be based on O₂ consumption, as determined by way of early experimentation in which the waste to be composted serves as substrate. With turned windrow systems, the findings would be in terms of frequency of turning. An indication of the O₂ concentrations as a function of depth in a turned windrow may be gained from Figure VIII-3.

In the experimentation and subsequent designing, it should be kept in mind that all malodours emitted from a composting mass are not necessarily a consequence of anaerobiosis. The fact is that some decomposition intermediates and the substrate itself may be malodorous. Moreover, even if complete elimination were possible, accomplishing it in a composting mass larger than about one cubic meter would be technologically and economically unfeasible.

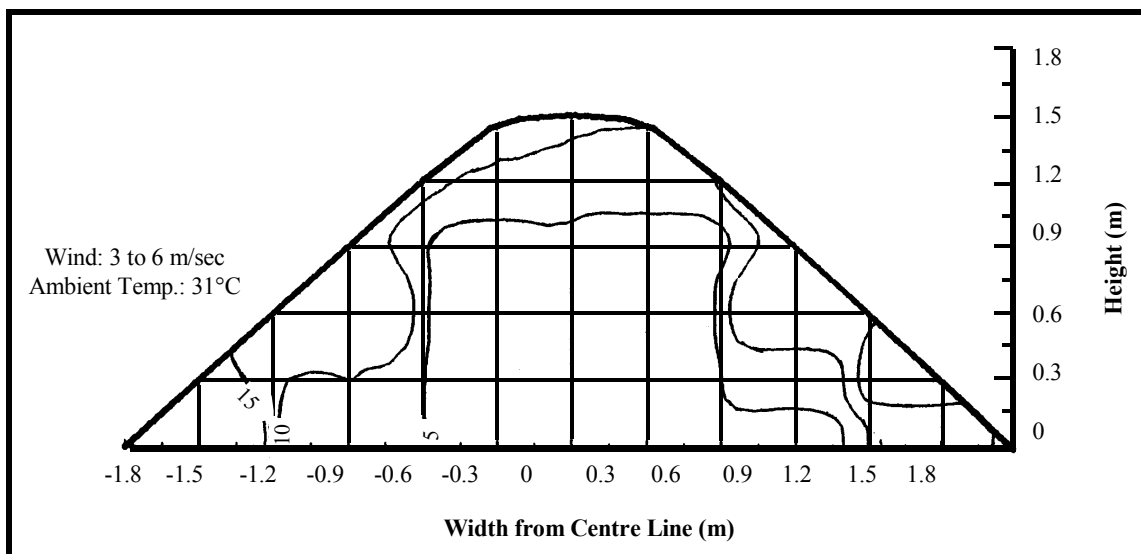

Figure VIII-3. Oxygen concentrations (%) within compost windrow

D4. OPERATIONAL parameters

D4.1. Monitoring the process

The identification and evaluation of pertinent operational parameters and their bearing on the compost process are essential elements in the development of an effective monitoring program. The attainment of these elements and understanding of their underlying principles can be greatly facilitated by a thorough knowledge of the sequence of events that takes place during the compost process when all conditions are satisfactory. Certain features of the course of the compost process can fill this role and serve as parameters in the monitoring of system performance. Three

prominent features are: 1) temperature rise and fall, 2) changes in physical characteristics (odour, appearance, texture), and 3) destruction of volatile solids.

D4.1.1. Temperature rise and fall

A typical temperature change as a function of time is presented in Figure VIII-4. As is indicated by the curve in the figure, the temperature of the material to be composted begins to rise shortly after the establishment of composting conditions, i.e., after the material has been windrowed or has been placed in a reactor unit. The initial change in temperature parallels the incubation stage of the microbial populations. If conditions are appropriate, this stage is succeeded by a more or less exponential rise in temperature to 60° to 70°C. The exponential character of the temperature rise is a consequence of the breakdown of the easily decomposable components of the waste (e.g., sugars, starches, and simple proteins). It is during this period that the microbial populations increase exponentially in population size. The temperature remains at this level (plateaus) over a period of time that is determined by the system used and the nature of the waste. Thereafter, the temperature begins to drop gradually until it reaches the ambient level.

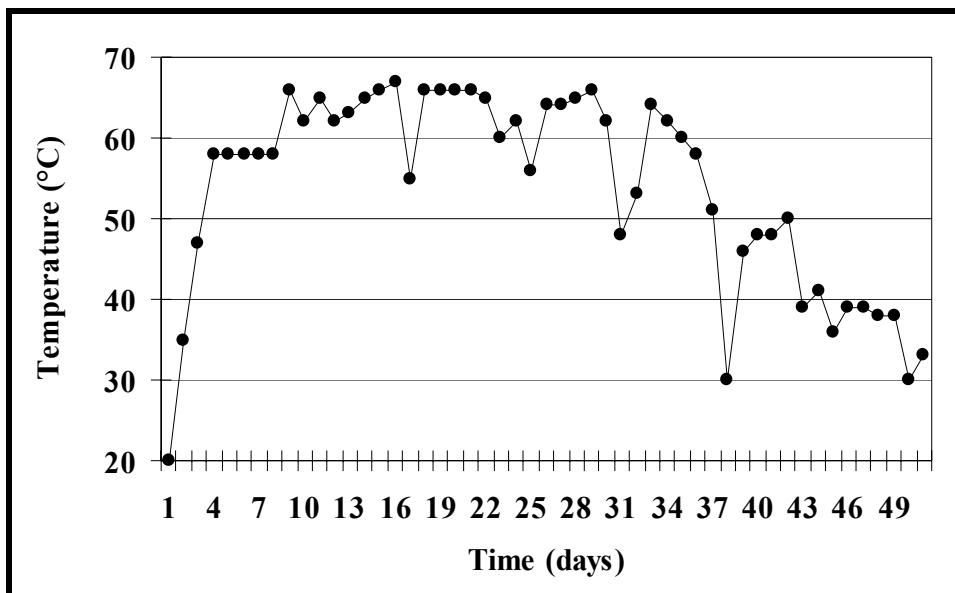

Figure VIII-4. Typical temperature variations in a compost pile

The duration of the high-temperature plateau may be prolonged if the substrate is largely refractory, or if conditions are less than satisfactory. It should be noted that the magnitude or intensity of the rise is much reduced if the wastes have a significant concentration of inert material. Such a condition would be indicated by a low volatile solids concentration (e.g., tertiary municipal sludge). In these cases, the temperature level probably would be lower, i.e., in the 50° to 60°C range. If any other condition is less than satisfactory, the results would also be a prolonging of the duration and a reduction of the level of the high-temperature plateau.

Bacterial activity becomes less intense and the resulting temperature drops after the readily decomposable components have been degraded, and only the more refractory components remain. Consequently, it may be assumed in routine compost practice that by the time the temperature has descended to ambient or a few degrees above, the more biologically unstable components have been stabilised and, therefore, the material is sufficiently composted for storage or for utilisation.

Although heat generated in the compost process is a result of microbial metabolism, the accumulation of the heat energy also depends upon the effectiveness of the insulation provided by the composting mass. In short, the characteristic rise in the temperature is a measure of the heat generated in microbial metabolism and retained within the composting mass. Thus, two factors are responsible for the temperature rise -- namely, heat generated by the microbial population and the effectiveness of the thermal insulation provided by the compost mass and by any cover or container enclosing the mass. Effectiveness of the insulation is partly a function of the size of the composting mass. In areas in which the ambient temperature is higher than about 8° to 10°C, the minimum volume for heat accumulation is about 1 m³.

The maturation stage or phase is indicated by the onset of a persistent decline in temperature and other indicators of microbial activity despite the absence of limiting factors, i.e., maintenance of optimum conditions. In short, it coincides with the approaching completion of the compost process and resulting increase in stability. Past experience indicates that the compost mass can be safely used or stored after the temperature has finally dropped to about 40°C.

D4.1.2. Changes in physical characteristics

D4.1.2.1. Appearance

Provided that the process is progressing satisfactorily, the composting mass gradually darkens and the finished product usually has a dark grey or brownish colour.

D4.1.2.2. Odour

An assortment of odours replaces the original odour of the substrate within a few days after the start of the process. If the substrate is MSW, the original odour is that of raw garbage. If the process is advancing satisfactorily, the succeeding odours probably could be collectively described as “faint cooking”. However, if conditions are unsatisfactory (e.g., anaerobiosis), the predominant odour would be that of putrefaction. If the C:N of the substrate is lower than about 20:1 and the pH is above 7.5, the odour of ammonia could become predominant. An earthy aroma is characteristic of the curing and maturing stages.

D4.1.2.3. Particle size

Because of abrasion by the other particles and of maceration, the particle size of the substrate material becomes smaller. Additionally, decomposition renders fibres brittle and causes amorphous material to become somewhat granular.

D4.1.3. Volatile solids destruction

Extent and rate of volatile solids destruction are major operational parameters. Changes in this category include destruction of volatile matter, altered molecular structure, and increased stability. One of the more important causes of these changes is the destruction of some substrate volatile solids (i.e., organic matter) accomplished by bio-oxidation to CO₂. Inasmuch as composting is a controlled biodegradation process in which complex substances are reduced to simpler forms, complex molecular structures are replaced by molecules of a simpler structure. Molecules that are partially or completely impervious (refractory) tend to remain unchanged. This combination of volatile solids destruction and conversion of complex molecular structure to simpler forms constitutes an increase in stability of the substrate organic matter.

D4.2. Parameter utilisation

The role of operational parameters in the diagnosis and remediation of process malfunctions complements their monitoring function. Illustrative examples of the dual role are given in the succeeding paragraphs.

The following example pertains to the temperature parameter: It may justifiably be assumed that some condition is less than satisfactory or even inhibitory if the temperature of the mass to be composted does not begin to rise or rises extremely slowly after the material is windrowed or placed in a reactor. In such a situation, it is highly probable that the underlying problem either is that the moisture content of the mass is excessively high or that it is excessively low. A proliferation of malodours would be symptomatic of excessive moisture. Conversely, the absence of all odours would be indicative of an excessively low moisture content. A possible cause not related to moisture could be an unfavourably high C:N. The difficulty with that diagnosis is the fact that some increase in temperature would be detectable even though the C:N were high. A pH level lower than approximately 5.5 or higher than about 8.5 could be a third possibility.

A high moisture content can be remedied by adding a bulking material. An alternative is to intensify aeration. Aeration not only supplies needed oxygen, it also evaporates moisture. Addition of water is the obvious remedy for a low moisture content. A high C:N can be lowered by enriching the substrate with a highly nitrogenous waste (sewage sludge; poultry, pig, or sheep manure). Lime may be used to raise a pH level. Doing so, however, leads to the difficulties cited in the discussion on pH.

An abrupt, sharp change in an operational parameter is symptomatic of an unfavourable development. Thus, an unplanned interruption of the exponential rise in temperature would indicate the development of an inhibitory situation such as excessive moisture in a windrow or an aeration malfunction in an in-vessel reactor. Either inadequate aeration or insufficient moisture could account for an unscheduled slowing of the exponential temperature rise or shortening of the duration of the high-temperature plateau.

Malodours are indicators of an O₂ deficiency, often brought about by an excess of moisture in the substrate. If excessive moisture is not the cause, the deficiency could be due to an inadequate aeration system or program. Inasmuch as malodours usually are associated with anaerobiosis, the olfactory sense can serve as a monitoring device, albeit somewhat crude. However, a more effective, and more costly, approach is to rely upon especially designed O₂ measuring instruments. With an in-vessel system, the O₂ of "input" air obviously should be greater than that of the discharge air stream.

D4.3. Measurement of stability

The search for an economical and technologically practical test for degree of stability began almost simultaneously with the recognition of composting as a waste treatment alternative. Consequently, many tests and techniques have been and continue to be proposed. The problem is that the tests have one or more deficiencies that diminish their utility. For example, tests that are based on superficial changes in physical characteristics involve a high degree of subjectivity and the unreliability often associated with subjectivity. This is illustrated by the confusion of the temporary stability imparted by a very low moisture content.

A far more frequently encountered deficiency is the lack of universality in terms of applicable values. Lack of universality is illustrated by a test that is based on the concentration of volatile solids. The fallacy arises from the assumption that all materials containing volatile solids degrade with equal rapidity or are equally biodegradable. This deficiency, lack of universality, and other

deficiencies are rapidly disappearing due to refinements in analytical procedures and advances in analytical technology. Unfortunately, these advances involve the services of highly qualified personnel and the use of very expensive equipment.

A list of tests that have been used to determine stability would include low C:N; final drop in temperature; self-heating capacity; redox potential [12]; oxygen uptake [13]; growth of the fungus *Chaetomium gracilis* [13]; the potassium permanganate test [21]; the starch test [14]; and the lipid test [23,29-31]. A sampling of these and other representative tests and their associated analytical procedures is made and discussed in the paragraphs that follow.

D4.3.1. Low C:N

Possession of a C:N lower than 20:1 is not necessarily indicative of stability; and, hence, is not suitable as a measure of stability or maturity. The C:N of fresh manures (without bedding) usually is lower than 20:1.

D4.3.2. Drop in temperature

In one of the earliest tests, the criterion for attainment of stability is the final and irrevocable drop in the temperature of the composting mass. The specification is based upon the fact that the drop is due to the depletion of readily decomposed (unstable) material. This parameter has the advantage of being universal in its application; the course of the temperature (i.e., shape of the temperature curve) rise and fall remains the same qualitatively, regardless of the nature of the material being composted. Although it is reliable, it is time-consuming, lacks universally applicable specifications, and depends upon degree of self-heating capacity [10]. Nevertheless, the test is fully satisfactory for application in developing countries and for small- and medium-scale operations in industrialised regions.

D4.3.3. Self-heating capacity

The test, self-heating capacity, is a variation of the final drop in temperature parameter [10]. The conduct of this test involves the insertion of samples in Dewar flasks. The flasks are swathed in several layers of cotton wadding or other insulating material. The swathed flasks are placed in an incubator. Degree of stability is indicated by the extent of subsequent rise in temperature. The method has the universality of the final drop in temperature parameter. Its disadvantage is the length of time involved, in that it may require several days to reach completion. Nevertheless, it is simple, relatively inexpensive, and satisfactory for use in a developing country.

D4.3.4. Degree of oxidation

The criterion of another measure of stability is the breadth of the difference between the percentage of decomposable material in the feedstock and that in the sample being tested. The measure of decomposability was the concentration of oxidizable matter. Accordingly, the method was designed to determine the amount of decomposable, i.e., oxidizable, material in a representative sample [11]. The rationale for the test is that the difference between the concentrations of decomposable material in the raw waste and that in the sample to be tested is indicative of the degree of stability of the latter. The basic procedure involved in the test is the determination of amount of oxidizing reagent used in the analysis. Because stability in composting is a matter of extent of oxidation, the amount of oxidizable material in a product is a measure of its degree of stability. In the conduct of the test, the sample is treated with potassium dichromate solution in the presence of sulphuric acid. The treatment brings about the consumption of a certain amount of the dichromate that had been added in excess to oxidize

organic matter. The oxidizing reagent remaining at the end of the reaction is back titrated with ferrous ammonium sulphate and the amount of dichromate used up is determined.

The amount of decomposable organic matter can be determined with the use of the following formula:

$$DOM = (mL)(N)(1 - T/S) 1.34$$

where:

- DOM = decomposable organic matter in terms of wt % of dry matter,
- mL = millilitres of dichromate solution,
- N = the normality of potassium dichromate,
- T = the quantity of ferrous ammonium sulphate solution for back-titration in millilitres, and
- S = the amount of ferrous ammonium sulphate for blank test in millilitres.

Quantitatively resistant organic matter is equal to the difference between the total weight lost in the combustion and that degraded in the oxidation reaction.

The basis for oxidation-reduction potential as a test for maturity [12] is the apparent rise in oxidation-reduction potential that accompanies increase in mineralization of the organic matter. The increase is brought about by microbial activity made possible by the presence of decomposable material. The presence of decomposable material results in an intensification of microbial activity and, hence, an accompanying increase in oxygen uptake; which, in turn, leads to a drop in the oxidation-reduction potential. One researcher [12] states that stability has been reached if the oxidation-reduction potential of the core zone of a windrow is <50 mV lower than that of its outer zone. Obviously, this standard is not applicable to in-vessel composting. An important shortcoming of the oxidation-reduction potential is the test's lack of accuracy and its vulnerability to interfering factors.

D4.3.5. Fungus growth

The effect of maturity of the substrate upon the rate of growth and upon the development of fruiting bodies of the fungus *Chaetomium gracilis* is the basis of another measurement of maturity [13]. The test involves the culturing of the fungus upon a solid nutrient medium that contains pulverised compost. On the 12th day of incubation at 37°C, the fruiting bodies of the fungus are counted. Supposedly, the number of fruiting bodies diminishes with an increase in maturity. The utility of the test is gravely reduced by the lengthy test time, as well as the dependence upon analysts who are skilled and knowledgeable in mycological procedures.

D4.3.6. Starch test

Another potential test, known as the starch test, is based upon the assumption that the concentration of starch in the substrate declines with destruction of organic matter i.e., increase in stability [14]. The rationale is that inasmuch as starch is a readily decomposable, and hence, unstable ingredient of all wastes, its decomposition should increase the stability of a waste. Therefore, a fully matured compost should contain no starch. Consequently, starch concentration is an indication of stability.

The determination of starch concentration involves the formation of a starch-iodine complex in an acidic extract of the compost material. Difficulty in the avoidance of false results combines with the absence of universally applicable values to detract from the utility of the starch test.

D4.3.7. Oxygen consumption/carbon dioxide evolution

The level of O₂ consumed or of CO₂ evolved by microorganisms during decomposition of organic matter is a measure of stability of the material. High unit rates of utilisation of O₂ and, consequently, of production of CO₂ indicate substantial availability of decomposable matter in the substrate to microbial attack, i.e., the material is not biologically stable. Stability of the substrate is indicated when the unit rate of O₂ consumption or of CO₂ formation approaches a low value. There is no definitive endpoint of microbial metabolic activity because metabolic rate gradually decreases as the material is decomposed. Consequently, the results of analyses of reference materials, practical experience, or both are required to judge the degree of stability of the tested material.

Collectively, tests that measure consumption of O₂ or production of CO₂ fall under the general category of respirometry. Several organisations have promulgated respirometry tests, including the following:

- “Standard Test Method for Determining the Stability of Compost by Measuring Oxygen Consumption, D5975”, American Society for Testing and Materials;
- “Specific Oxygen Uptake Rate, Test Methods for the Examination of Composting and Compost (TMECC), 5.08-A”, US Composting Council; and
- “Carbon dioxide Evolution Rate (TMECC), 5.08-B”, US Composting Council.

Additionally, various researchers have reported developing and using methods of respirometry for measuring oxygen required for composting [37,38].

E. Technology

E1. PRINCIPLES

Compost technology has three important functions, the first of which is “pre-processing”. Pre-processing consists of the preparation or processing of a raw waste such that it constitutes a suitable substrate for the compost process. The waste of concern in this section of the book is the organic fraction of municipal solid waste. The second function is the conduct of the compost process. The third function is the preparation of the compost product for safe and nuisance-free storage and/or the upgrading of the product so as to enhance its utility and marketability.

E2. EQUIPMENT

The principal role of equipment is to provide an economically and technologically feasible set of optimum environmental conditions or factors for the microbes. Ranking high in the set of factors is the oxygen availability supplied by aeration of the composting mass. Recognition of this importance is reflected by the emphasis placed upon the development of effective aeration in the design of compost equipment, reactors, and procedures.

Air in the space between the particles of the composting material (interstitial air) is the source of oxygen for the active microbial populations. However, oxygen in ambient air that impinges upon the outer surface (surface air layer) may also constitute a significant source in some compost

systems. Thus, oxygen availability generally is largely a function of the porosity of the composting mass.

As decomposition progresses, interstitial oxygen and oxygen in the surface air layer are consumed in the respiration carried on by the active microbes and are replaced by the CO₂ generated in the respiration. Unless interstitial air and surface air now devoid of oxygen are replaced by fresh air with its oxygen content intact, anaerobic conditions soon prevail. Consequently, aeration equipment must be designed such that interstitial air and surface layer air are renewed at a rate such that O₂ is always available.

Renewal of the oxygen supply can be accomplished by physically rearranging the particles (agitation). Agitation establishes new interstices and surface air layers and an accompanying infusion of oxygen.

Agitation can be accomplished either by tumbling or by stirring, or by a combination of the two. Tumbling is done by way of lifting particles and then allowing them to fall or drop. In windrow composting, tumbling occurs in the “turning” of the composting material. Tumbling is accomplished in some in-vessel systems by way of dropping the composting mass from one floor to another or from one conveyor belt to a lower one. A slowly rotating drum or cylinder equipped with interior vanes is used for accomplishing tumbling in a group of in-vessel systems. In systems involving stirring, movement is primarily sideways (horizontal), and tumbling is practically non-existent.

In several compost systems, the particles remain stationary and only the interstitial air is exchanged more or less continuously. The exchange consists of removing interstitial air saturated with CO₂ and replacing it with fresh air. Surface air also is continuously exchanged. The exchange is accomplished by forcing fresh air into, and simultaneously exhausting spent air from, the composting mass. Appropriately, systems involving such an exchange are termed “forced-air systems”. The effectiveness of a forced-air system is determined by both the rate and the extent to which the forced air is uniformly distributed throughout the entire composting mass.

E3. BIOFILTERS

As mentioned previously in the chapter, the composting process generates odours as a byproduct of the process. The types and intensities of the odours are a strong function of the types of feedstocks, compost process design, and operating conditions that are employed at the facility. Since the odours generated can be bothersome or otherwise a nuisance to the public, the control of odours generated by sources within composting facilities is an important design consideration if the facility is to be located near human populations. Factors that determine the intensity of the odours at offsite locations include chemical composition and intensity of the odours generated at the facility, local meteorological conditions (e.g., atmospheric stability and wind velocity), and distance to the nearest sensitive human receptor. Sources of odour include but are not limited to the raw feedstocks, actively composting material, and unstabilized compost storage piles.

Biofiltration is an effective method of treating and lessening the intensity of the odours generated from the processing of organic materials [35]. Currently, most of the aerated-pile composting facilities in the United States are relying on the application of biofilters for odour control. In addition, the majority of these facilities utilise traditional, above-ground biofilter units. Recent trends in the industry indicate that other designs, such as the application of agitated beds, the use of roll-off containers, and the use of other types of enclosures, may be incorporated into the designs.

During the 1990s and continuing to this day, the proliferation of green waste composting facilities in the United States and organic composting facilities in Europe has contributed to close scrutiny of odour generation and control from composting facilities. Research and development has been concentrated on biofilter design and performance [35,36].

The most common biofilter medium consists of a mixture of compost and wood chips. In some cases, other materials such as peat, lime, bark mulch, or sand may be added. The type and characteristics of the filter medium have a direct impact on the effectiveness of the filter, as well as on its lifespan. Medium selection also depends upon the concentration of odorous compounds in the gaseous stream and on the porosity of the mixture that comprises the medium. Porosity, in turn, has a direct impact on the pressure drop and, thus, the power requirements for operating the system and its ability to support a microbial population.

A biofilter can be constructed as follows: the gases to be treated are conveyed to a network of perforated pipes. The pipes are placed at the bottom of the bed to serve as the air distribution system. A 45-cm layer of round, washed stones is placed over the perforated piping. In order to prevent clogging of the perforations and to allow the upward migration of the gases, a filter layer is placed on top of the stones. One alternative that is commonly used in composting facilities in the United States is the application of geotextiles. Proper functioning of geotextiles depends upon the size of openings in the fabric. After the geotextile (or any other type of filter) is in place, a 100- to 120-cm layer of filter medium is placed on top. The filter medium should be properly selected in order to perform according to specifications. In some cases, an additional 30-cm layer of a different filter medium is placed on top of the previous layer. The effectiveness and efficiency of the filter medium depend upon the following parameters: temperature, moisture content, C:N, nutrient content, and others.

The temperature of the material in the biofilter is affected by ambient conditions, as well as by the flow rate, humidity, and temperature of the gas being treated. Several designers are considering other approaches for lowering the inlet temperature of the gas from thermophilic to mesophilic levels. Some of these approaches include dilution with building air or outside air, or scrubbing with water. The levels of dilution must be properly calculated because the dilutions can lead to additional power requirements for the fans without achieving the necessary temperature decline.

In order to maintain a desired population of microorganisms in the biofilter, it is necessary to keep the moisture content in the range of 50% to 55%. Moisture content can be controlled by means of humidifiers in the piping or by the installation of spray nozzles over the beds. Moisture addition must be carefully designed in order to maintain the desired moisture levels and, at the same time, prevent the generation of free “leachate” and clogging of the open spaces in the bed and in the piping.

The C:N and nutrient content contribute to the maintenance of the microbial population responsible for treating the exhaust gases. These parameters are dealt with through proper media selection.

Other parameters that exert an impact on the performance of a biofilter include: porosity, field capacity, and particle size distribution. Porosity and moisture distribution can be corrected by periodically agitating the beds. The biofilter medium will eventually reach a point beyond which its efficiency for odour removal drops substantially and should be replaced. Although the actual replacement point of the medium will vary and will depend upon local conditions and type of materials used, operators should generally plan on replacing the material at two- to three-year intervals.

E4. SYSTEM selection decision factors

Application of appropriate decision factors is essential not only to the rational selection of system and equipment but also to the successful implementation of an entire compost enterprise. Practical experience has demonstrated the genuine utility of the general principles and decision factors discussed in this section.

A basic and exceedingly valuable principle is that complexity does not ensure success, particularly because complexity does not beget efficiency of process. Product quality is not necessarily improved by complexity. More importantly, the economics of composting allow very little margin for complexity. Thus, any reduction in the time requirement that might be gained from increased complexity would not be sufficient to warrant the additional expense involved. Conceivably, it would be possible to design a reactor such that a product could be produced within the detention times of one or two days. An example of such an approach would be to make an ultra-fine slurry of the waste and then subject the slurry to the activated sludge process conventionally used in wastewater treatment [22]. However, the capital and operating costs of such a setup would be economically prohibitive.

Among the other key decision factors is one directly related to economics. Simply stated, the selected system must be adaptable to the economic and work force conditions of the locale in which it is to be used. This factor would render thoroughly inadvisable the selection of even a moderately automated system by a non-industrialised country in which there would be an excess of labour and that almost certainly would lack the necessary economic and qualified personnel resources.

An important guiding decision factor is one that is related to the evaluation of prospective systems to operate an automated system. Such an evaluation should take into consideration the tendency of some vendors to make unrealistic claims of superior performance regarding acceleration of the process, magnification of efficiency, or production of a superior product. Claims regarding process time should account for all stages of the compost process -- namely, incubation, active (high temperature and curing), and maturing. Ideally, an evaluation would include firsthand observation of a candidate system while it is in operation. It is essential that the observation and evaluation be made by an individual or individuals who are thoroughly conversant with composting as well as with solid waste management. Moreover, the compost product should be sampled and inspected directly at the compost facility on the day it is produced.

Finally, being a biological process, composting is subject to the limitations characteristic of all biological systems. Thus, the rapidity at which a process progresses and the extent to which decomposition proceeds under optimum substrate, environmental, and operating conditions are ultimately functions of the genetic makeup of the active microbial populations. As a result, further sophistication of reactors and/or equipment could not bring about further advances in rapidity and extent of decomposition.

F. Types of compost systems

Compost systems currently in vogue can be classed into two broad categories -- namely, "windrow" and "in-vessel".

F1. WINDROW systems

As one would suspect, the designation "windrow systems" reflects the distinguishing feature of such systems -- namely, the use of windrows. Windrow systems can be mechanised to a

considerable extent and may even be partially enclosed. Two versions of windrow systems are practiced at present -- namely, static (stationary) and turned. As was mentioned in the section, Aeration, the principal difference between the “static” version and the “turned” version is the fact that in the static version, aeration is accomplished without disturbing the windrow; whereas with the “turned” version, aeration involves tearing down and rebuilding the windrow.

A windrow composting process involves the following principal steps: 1) incorporation of a bulking agent into the waste if an agent is required (e.g., biosolids), 2) construction of the windrow and aeration arrangement, 3) the composting process, 4) screening of the composted mixture to remove reusable bulking agent and/or to meet specifications, 5) curing, and 6) storage.

F1.1. Static windrow

The two principal versions of the static pile are: “passive” and “forced-air”. Despite the distinction between the two designations, the terms static pile and forced aeration often are used interchangeably in current literature.

F1.1.1. Passive aeration

In keeping with the accepted meaning of the word “passive”, the windrow is allowed to remain undisturbed and aeration is a function of natural phenomena. The method or approach does not involve the intervention of mechanical equipment (e.g., fans or turning equipment). Consequently, it would seem to be a method of aeration well suited to a developing nation.

In passive aeration, convection is the principal moving force whereby external air enters the windrowed material and displaces CO₂, although some oxygen may enter the outer layer of a windrow by way of diffusion. Theoretically, the intervention of mechanical equipment for injecting air would not be required. Convection arises from the existence of an imbalance between the temperature of the interior of the windrowed composting mass and that of the ambient (external) air layer, differences in concentrations of oxygen, and from the flow of air over the windrows.

In some cases, units have been incorporated in the designs to promote convection and air movement. The designs usually take the form of chimneys and vents inserted into the composting mass. For instance, in the People’s Republic of China, a system of composting that relies on passive aeration has been used. In the system, organic matter to be treated (in the observed cases, it was organic matter from refuse and nightsoil) is mixed. The mixture is piled to a height of approximately 15 to 20 cm. Subsequently, four timbers having a diameter of about 6 to 8 cm are placed horizontally on top of the mixture in the shape of “#”. The timbers are placed about 1 m apart. At the points where the timbers cross, four vertical timbers (or bamboo poles) are erected. After this, waste is piled until the windrow reaches a height of approximately 1 m. The entire windrow is then covered with mud (see Figure VIII-5). Once the mud has dried, the timbers are removed. According to representatives of the municipality visited (Tianjin), it takes about 3 weeks during the summer and about 4 weeks during the winter for the compost process to be completed. The designers of the system claimed several advantages, including: 1) achievement of high temperatures in the composting mass, 2) achievement of a relatively even temperature distribution, and 3) minimum release of odours. Unfortunately, the effectiveness of such designs, and of convection in general with respect to the maintenance of aerobiosis throughout the composting mass, leaves much to be desired. The problem is the inadequate lateral movement of air.

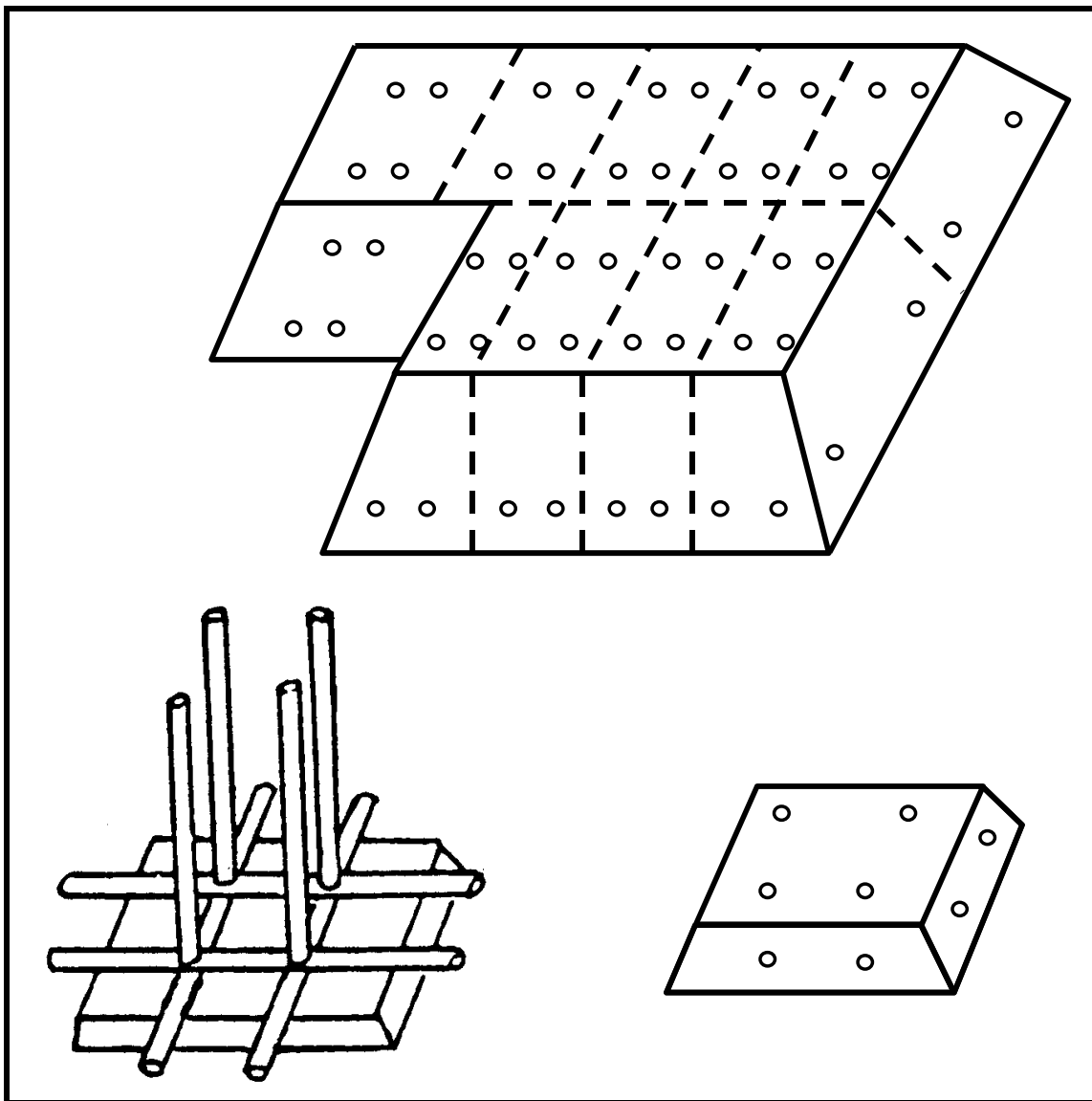

Figure VIII-5. Example of passive aeration used in the People's Republic of China

F1.1.2. Forced-air aeration

The designation “forced-air aeration” reflects the fact that aeration involves either mechanically forcing air up (positive pressure) or mechanically pulling it down (negative pressure) through the undisturbed composting mass. The forced-air version was introduced and studied in the late 1950s [15]. However, appreciable attention was not accorded it until the 1970s. Despite a practical demonstration of its utility in the composting of dairy cattle manure [8], the primary reason for the renewal of interest was the ready adaptability of the method to the treatment of sewage sludge [16,32].

An attractive feature of the suction (negative pressure) mode of forced aeration is the ability to pass the exiting air through an emission treatment device. Such a device could be a biological filter consisting of a mass of stable organic matter. The application of a biofilter to control gaseous emissions from composting facilities is a very appropriate solution for developing countries. Alternative devices may incorporate modifications of technology conventionally used in treating combustion emissions.

In the absence of an excessively high moisture content, aerobic conditions can be maintained at a satisfactory level in a static windrow, despite periodic brief interruptions of aeration. (A safe

moisture content is one within a range of 40% to 55%.) Because of its dependence upon several variable factors, the specific requisite rate of air input for a particular operation should be determined experimentally [19,20]. The following example provides a tentative indication of rates that could be encountered. The example assumes a 17-m windrow containing about 73 Mg of biosolids. For this setup, an adequate timing sequence would involve forcing air into the pile at 16 m³/hr for 5 to 10 minutes at 15-minute intervals. This particular rate was based upon an assumed need of about 4 L/sec/Mg of dry biosolids.

F1.1.3. Design and construction

The basic arrangement of a static windrow system is shown in Figure VIII-6. The construction of a static windrow conventionally proceeds as follows: A loop of perforated pipe, 10 to 15 cm in diameter, is installed on the compost pad. The loop is oriented longitudinally and is centred such that it will be under the highest part of the windrowed mass. Short-circuiting of air is avoided by adjusting the length of the pipes such that they end about 2 to 3 m short of the edges of the windrow. Non-perforated pipe is used for connecting the loop with a blower. The installed loop is covered with a layer of bulking material or finished compost. This “foundation” layer should cover the entire area to be occupied by the windrow. The foundation layer facilitates the movement and makes possible a uniform distribution of air during the course of the compost process. Due to its absorption potential, it can lessen seepage from the windrow by absorbing excess moisture. Construction of the windrow is then completed by stacking upon the foundation layer the material destined to be composted. The completed windrow should have the configuration shown in Figure VIII-6. Suggested dimensions of a constructed pile are: length, indeterminate; width (at the base), about 4.6 m; and height, about 2.3 m. Usually, the constructed windrow is covered with a 0.3 to 0.4 m layer of matured (finished) compost. The covering layer serves as insulation; it ensures the attainment of high-temperature levels that are lethal to pathogens throughout the composting mass and, thereby, accomplishes a more complete pathogen “kill”.

The “extended aerated pile” is a forced-air version of a “continuous culture”. It is an advantageous approach when large amounts of material are involved. An extended aerated pile is begun by constructing on day-1 a pile in the manner described in the preceding paragraphs. However, only one side and the two ends of the pile are blanketed with insulating cover material - leaving one side exposed. To minimise emission of malodours, the exposed side is lightly covered with a shallow layer of mature compost. On each succeeding day thereafter, an additional loop of piping and accompanying windrow and its appropriate covering are added.

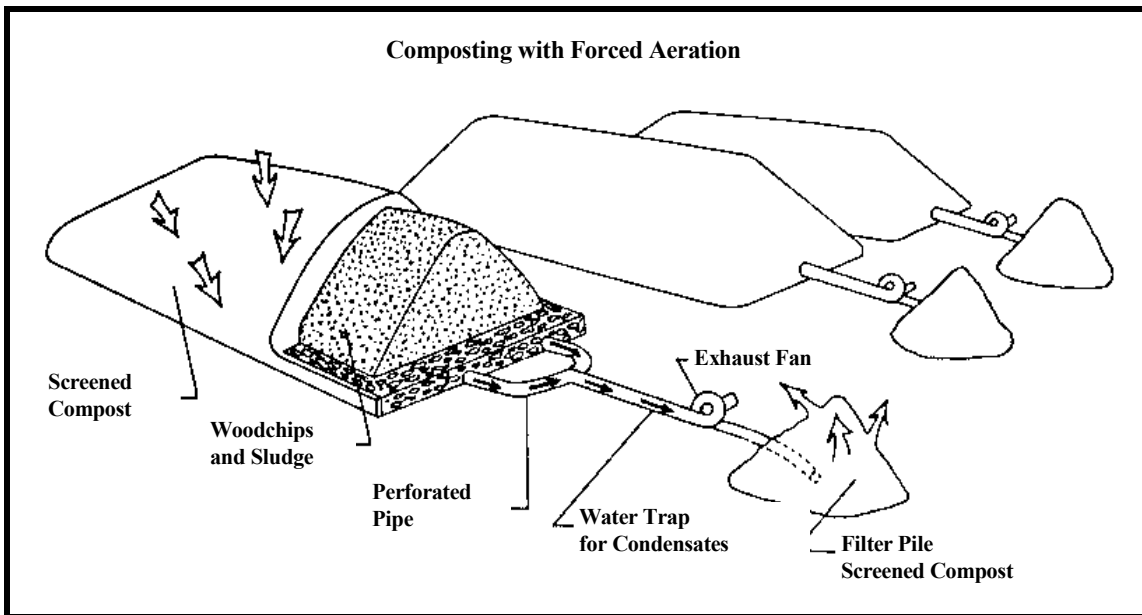

^a Piping under pile is perforated for air distribution.

Figure VIII-6. Schematic diagram of an aerated pile, showing location of aeration pipe^a

Each day's addition is installed immediately adjacent to the preceding day's loop. Procedures closely akin to those followed in constructing the day-1 pile also are followed in constructing each day's addition. This procedure is repeated over the succeeding days. After 21 days, the manifestation of this program is an elongated windrow. Continuity is achieved through the removal of day-1 (pile-1) material and replacing it with new (fresh) material. Such an exchange is made on each succeeding day. In short, finished product (compost) is removed twenty-one days after the construction of pile-1. (If the material is not sufficiently composted, the removal may be delayed to the extent deemed necessary.) If it is sufficiently matured, day-2 material is removed on the 22nd day and is replaced with fresh material. A similar exchange is made on the 23rd day. Daily exchanges are made until all piles are reconstituted. Thereafter, the external manifestation is an elongated pile from one end of which an increment of material is removed and is replaced by adding a comparable increment of fresh material to the opposite end of the pile. In effect, continuity is attained and maintained; and the residence time is 21 days.

An important advantage of the extended approach is a substantial reduction in spatial requirements. With respect to wastewater solids (biosolids), the land area needed for a single-pile compost system, together with area involved with runoff collection, storage, and administration, amounts to approximately 1 ha per 7 to 11 Mg (dry wt) of biosolids processed.

F1.1.4. Evaluation of the static pile approach

Because its capital cost is largely site-specific, it is difficult to arrive at a generally applicable capital cost for static pile composting. Modest equipment requirements and cost apparently render the static pile economically attractive. The problem is that the method is sufficiently satisfactory only with wastes that have a granular texture, that have relatively uniform particle size, and in which the size of the particles is less than 3 or 4 cm. Otherwise, there is a tendency of anaerobic pockets to develop in substrates that are characterised by a wide diversity of overly large particle sizes. This tendency is a consequence of the resulting uneven distribution and movement of air through the composting mass (channelling).

F1.2. Turned windrow

The current consensus is that the turned windrow approach antedates the forced-air (static) approach. As was stated earlier, a distinguishing characteristic of the turned windrow is the accomplishment of aeration by way of the periodic turning of the windrowed material, i.e., tearing down and reconstructing the windrow.

Although the ultimate reason for the turning process is the accomplishment of aeration, turning does simultaneously fulfil other beneficial functions. It periodically exposes all parts of the composting mass to the interior of the pile, i.e., to the zones of highly active microbial activity. It also may further the reduction of particle size. Turning accelerates loss of water from the composting mass. This is beneficial if the moisture content is unfavourably high; conversely, it is disadvantageous when the moisture level is unfavourably low.

F1.2.1. Windrow construction

Conventionally, windrows are roughly conical in cross section. However, certain conditions may dictate a variation from the conventional shape. If a variation is indicated, it should be one that best fits the situation. A loaf-shape, characterised by a flattened top, would be appropriate for dry, windy periods because the ratio of exposed surface area-to-volume would be less than it would be with other configurations. However, a flat top would be a drawback during rain or snow. If turning is done by machine, the configuration and dimensions of the windrow are functions of the design of the turning machine.

To avoid compaction, the height of the windrow should not exceed 2.3 m.

F1.2.2. Turning space requirement

The total space involved in the turning process can be significantly large. The area requirement is particularly large if turning is done manually. At the other extreme, the area requirement is minimal with certain types of mechanical turning.

According to the logistics of turning indicated by the diagram in Figure VIII-7, from 2 to 2.5 times the area occupied by the original pile is required for manually turning a single day's input. The second day's manual turning returns the pile to its original position. The double space requirement for each day's increment continues until the material is sufficiently composted.

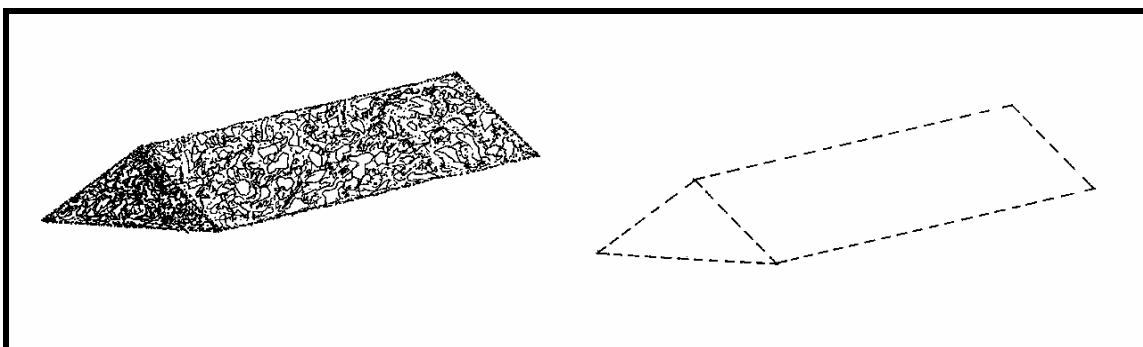

Figure VIII-7. Process for turning windrows manually or with front-end loader

The spatial requirement for mechanised turning is a function of the type of machine utilised for the operation. Thus, the turning space required by a certain type of machine can be quite small. Machines of this type usually are designed to straddle the windrow. As the machine advances, it tears down the straddled windrow and directly reforms the composting mass into a new windrow.

Consequently, the turning space involved is only slightly more than that occupied by the original windrow. The additional space is that which is needed for positioning the machine.

The turning space required with machines that do not straddle the windrow is comparable to that needed in manual turning. The reason is that the position of the reconstructed windrow is adjacent to that of the torn-down windrow.

F1.2.3. Windrow reconstruction

Obviously, windrow reconstruction in the turning process should be done such that pathogens that may be present in the composting mass are destroyed. Moreover, the reconstruction should promote uniform decomposition. Pathogen destruction and uniform decomposition can be accomplished by reconstructing the torn-down windrow such that material in the outer layer of the torn-down pile is in the interior of the reconstructed windrow. Certain circumstances, e.g., design of the turning machine, could make it unfeasible to reverse positions at every turning, which could be compensated for somewhat by an increase in frequency of turning. For example, the frequency could be adjusted to 2 or 3 turnings per day.

F1.2.4. Turning frequency

Ideally, the turning frequency should be such that: 1) sufficient O₂ always is available to meet oxygen demand, and 2) all pathogens are destroyed. Nevertheless, economic and technological realities may compel a compromise between the practical and the ideal.

With respect to meeting oxygen demand, turning frequency depends upon the available pore volume. Available pore volume is a function of the porosity of the pile and its moisture content. Pore volume, in turn, depends upon the structural strength of the windrowed particles and consequent ability to retain pore integrity. Therefore, the drier the material and the firmer the structure of the particles, the less frequent will be the indicated turning.

A variable factor regarding turning frequency is the rate of decomposition desired by the operator. The bearing of this factor on turning frequency is by way of the effect of aeration on rate of decomposition. Until another factor becomes limiting, rate of decomposition increases with intensification of aeration, and intensification increases with increase in turning frequency.

Practical experience [9,17,20] indicates that rate of composting can be accelerated through the establishment of two sets of conditions. The first set involves the use of a substrate in which: 1) sufficient microbial nutrients are readily available; 2) a bulking material, such as dry grass, dry leaves, wood chips, sawdust, or paper, is used; and 3) moisture content is on the order of 60%. The second set of conditions calls for a turning schedule according to which the first turning takes place on the third day following the institution of compost conditions and four subsequent turnings, i.e., one every other day. After the fourth turning, the frequency need be only once each four or five days. Both sets of conditions most likely would exclude MSW and biosolids composting.

Increasing the frequency of turning, e.g., one turn per day, often can lessen the emission of putrefactive odours, inasmuch as such odours are symptomatic of anaerobiosis. A once-per-day turning regimen also can promote the loss of excess moisture from a windrow.

F1.2.5. Manual turning

Manual turning is a very appropriate approach in small-scale operations in any location but particularly applicable in areas where there is a surplus of unskilled labourers. The most practical

tool for use in manual turning is the pitchfork (trinche). There are some key factors that should be kept in mind when piles are to be turned manually.

1. The height of the pile should not exceed that of the typical labourer.
2. Sufficient space must be incorporated in the design such that a new pile can be formed in the process of aeration.
3. During rebuilding of the pile, material from the outside layers of the original pile should be carefully placed in the interior of the newly formed pile. Since it is not always convenient to turn the pile in such manner, in practice, supervisors should aim at trying to place material from the exterior of the pile in the interior of the new piles as often as possible during the course of the composting process. If this ideal situation cannot be achieved, the deficiency can be compensated by increasing the frequency of turning (e.g., from two times per week to three times per week).
4. The new pile should be reconstructed such that the composting material is not compacted as to impede some air circulation.

Based on the authors' experiences, a motivated labourer can turn approximately 8 to 10 Mg of organic matter per 8-hr day. In practice, manual turning has been employed in composting programs processing on the order of 20 to 30 Mg of organic matter per day. It is important to emphasise that if manual turning is to be employed, the workers must be carefully trained on the composting process and on safety procedures. In addition, the workers must be provided with safety equipment such as dust masks, boots, gloves, and uniforms. The composting facility should be equipped with a first-aid kit, as well as with bathrooms and showers.

F1.2.6. Turning equipment for windrows

When manual turning is not feasible, some form of mechanised turning must be used. Forms presently available can be conveniently classified into two broad categories: 1) machines specifically designed to turn windrowed compost material, and 2) machines designed to move earth. Machines in the first category are often termed "mechanised turners".

F1.2.6.1. Mechanised turners

Currently, several types of mechanised turners are available. Serious obstacles to the acquisition of the machines are the relatively high capital and operating costs associated with the machines. The magnitude of these costs very frequently places the acquisition beyond the economic and technological resources of most developing nations and small operations in industrialised countries. In situations in which sufficient financial and technological resources are at hand, the scale of the operation must justify the expenditure.

Several types of mechanical turners are on the market. The machines differ among themselves in degree of effectiveness and durability. Capacities vary with the model of machine; with some models the capacity may be on the order of 1,000 Mg/hr, with other models it may be as much as 3,000 Mg/hr. Prices range from about US\$20,000, to more than US\$180,000, FOB.

F1.2.6.2. Conventional earth moving machines

Examples of conventional earth moving machines that are used for constructing and turning windrows include the bulldozer, front-end bucket loader, and backhoe ditch digger. The objection to the use of such equipment is the tendency to compact the composting material, to inadequately

agitate and aerate it, or both. This is especially true when a bulldozer is employed. Almost certainly, objectionable odours will be generated. Although the performance of these types of equipment as compost turners is far from satisfactory, it can be acceptable if the machines are used carefully by knowledgeable operators.

The conventional rototiller has been used with considerable success for turning relatively small amounts of compost material (i.e., less than a few Mg per day). The rototiller is a relatively small piece of equipment designed to till garden soil. Turning with the use of a rototiller is done in four steps:

1. tear down the pile or windrow;
2. spread the material to form a 30- to 60-cm layer;
3. rototill (“agitate”) the compost mass, i.e., pass the machine back and forth through the layered mass; and
4. reform the pile or windrow.

F1.3. Site preparation

Site preparation involves a number of activities: A surface is provided that can satisfactorily accommodate all phases of the operation; and provision is made for the collection and treatment of leachate and for the diversion of runoff. In desert regions, a windbreak is erected to shield windrows from drying winds and, thereby, avoid excessive loss of moisture by way of evaporation. In situations characterised by moderate to heavy rainfall, roofing is provided to shelter the windrows, particularly during the active and early maturing stages.

With respect to surface, windrows should be kept on a paved surface throughout the time they must be worked, i.e., until the material is ready to be stored. A paved surface is necessary because it: 1) facilitates materials handling, 2) enables control of leachate and diversion of runoff, and 3) prevents migration of fly larvae to surrounding areas. The only paving materials suitable for operations that involve the use of a mechanical turner are asphalt and concrete. The weight of a mechanical turner makes it essential that the machine be operated on a surface that provides a firm footing. Only asphalt pavement and concrete pavement furnish such a surface. For operations that do not involve the use of a mechanical turner, the list of suitable paving (surfacing) materials expands to include not only concrete and asphalt, but also packed gravel, crushed stone, and thoroughly compacted soil. However, compacted soil is only marginally suitable because turning and ancillary traffic are seriously impeded when the soil becomes wet, such as during periods of rainfall.

F1.4. Windrow facility

An idealised version of a windrow compost installation is one that would be housed in a shelter. The shelter would be provided with the ventilation equipment needed to control and treat gaseous emissions. Windrows would be turned by means of an automatic turning machine. Maturation could take place either within the shelter or outside.

Plastic particles and similar contaminants in the compost product can be removed by way of screening. Inasmuch as the screen oversize consists mainly of plastics, it is removed immediately. The tendency of plastics to be concentrated in the oversize stream is due to the low density of plastics combined with their characteristically two-dimensional shape and, of course, their tendency to be oversize in terms of screen opening size.

Should the finished product contain glass particles, a second stage of size reduction can be included into the process. The degree of size reduction used in the process, particularly in developing countries, must be carefully evaluated since size reduction is an energy- and maintenance-intensive process.

F1.5. Economic considerations

The many variations between approaches to windrow composting render it difficult to formulate generalisations regarding the economics of the process. The only exception can be stated as follows: It can justifiably be expected that either turned or static windrow composting would be less costly than in-vessel composting. Current versions of windrow composting differ among themselves with respect to size, degree of mechanisation, and process. An example of the effect of the differences is the wide spread between the economics involved in a few-Mg per day operation and those of a several-hundred Mg per day facility.

The cost of the mechanical turner is a major item in the economics of medium- to large-scale operations. If a shelter is provided, it need not be elaborate; it should, nevertheless, include provisions for the control and treatment of problem emissions such as malodours and dust. Shelters would be particularly important if the facility is built relatively close to residential or commercial areas. Reported costs for composting MSW, manures, and biosolids range from US\$30 to US\$60 per Mg.

F1.6. Constraints

Aside from economics and political and sociological constraints, the principal constraints on windrow composting are either of public health or of environmental origin. The presence of human excrement or of the remains of diseased animals in the compost substrate generates a potentially serious public health constraint, depending upon the degree to which temperature levels that are lethal to pathogens are reached and maintained. The problem is that it frequently happens that lethal temperatures do not entirely pervade a windrow; this is especially true for the outermost layers. Another problem is the likely recontamination of already sterilised material by unsterile material during the turning operation. However, such recontamination can be compensated considerably by increasing the frequency of turning.

The almost inevitable emission of odours, despite the establishment of a preventive regimen, constitutes a serious environmental constraint. This constraint and proposed methods of alleviating it are discussed in another section. However, it should be emphasised that the inevitability of malodour emission is characteristic of most systems that involve the handling and processing of community wastes.

The relatively long process times and the attendant greater area requirements frequently are construed as constituting a constraint on windrow composting. This constraint is not necessarily a disadvantage in that, as was explained earlier, rapid composting is an advantage either when land area is a critical factor, or when in-vessel composting is involved. The rationale in the latter case is that cost savings through reduction of the monetary expenditure on land acquisition can be used to partially or entirely compensate the cost of the in-vessel reactor.

F2. IN-VESSEL reactors

Goals underlying the design of an in-vessel reactor are to: 1) accelerate the compost process through the maintenance of conditions that are optimum for the microbes active in composting, and 2) minimise or eliminate adverse impacts upon the ambient environment.

Excepting for minor variations, current reactors commonly have these characteristics: 1) the design of each reactor represents a relatively minor deviation from other reactors in a comparable category; and 2) various methods or combinations of them are used to aerate the composting mass, some more successfully than others. The aeration design usually calls for one or more of the following features: forced aeration, stirring, and tumbling. Forced aeration is employed to some extent in most in-vessel reactors. Stirring is accomplished by rotating ploughs or augers through the composting mass. Tumbling can be accomplished by dropping the composting material from one level to a lower level (from belt to belt, or floor to floor). Another mechanism for tumbling is a rotating horizontal drum equipped with internal, horizontally-oriented vanes.

F2.1. Examples of proprietary in-vessel reactors

There are many types of in-vessel systems that have been used over the years. A few of these systems are described in this section.

F2.1.1. Dano drum

Dano reactors have been on the market since the 1940s [33]. The Dano reactor typifies the horizontal drum category. As such, its distinguishing feature is a long, almost horizontal, drum that is three or more meters in diameter and is rotated at about 2 rpm. Severe economic constraints restrict residence time in the drum to the active stage of the process. Therefore, maturation takes place outside the drum and involves windrow composting. It is highly doubtful that a Dano facility would be within the economic and technological resources of most developing countries. Not only are Dano reactors expensive in terms of capital expenditures, they also involve high operational and maintenance costs.

F2.1.2. Other horizontal drum systems

The design of the Eweson system differs from that of the Dano system in that its drum is divided into compartments such that the residence time can be varied throughout the drum. The system used in the Ruthner System and the PLM-BIAS systems are two additional versions of the drum design [18]. Although some of these systems are no longer being marketed at the time of this writing, an example of an operating Eweson-type drum is shown in Figure VIII-8.



Courtesy: Ms. Antje Vorreiter

Figure VIII-8. Example of Eweson drum design (Western Australia)

F2.1.3. Naturizer system

The original Naturizer system exemplifies the tumbling floor approach. The system involves the use of two vertical silos positioned side-by-side. Each silo has three floors. The distinctive feature of the silos is the use of floors that consist of V-shaped troughs placed side-by-side. Transfer of the compost mass from an upper floor to the one immediately below is accomplished by inverting the upper-floor troughs. A conveyor belt dumps processed wastes on the top floor of the first silo. The wastes are retained on this floor over a 24-hr period. At the end of the period, the composting mass is dropped to the middle floor on which it is held over a second 24-hr period, and then is dumped upon the bottom floor. After having been size reduced, the composting mass is then transferred to the top floor of the second silo, where the routine is repeated. Thus, the total retention time in the tandem silos is six days. Following discharge from the second silo, the material is windrowed and allowed to mature over a one- to two-month period.

F2.1.4. “Metro”- or channel-type

Metro- or channel-type in-vessel systems combine forced aeration with tumbling. The system involves the use of an elongated, horizontal open channel or reactor, equipped with a perforated bottom and a mobile agitator designed to tumble the contents of the channel (see Figure VIII-9). (Typically, the agitator is some version of the travelling endless belt or a rotating drum.) These types of systems are also sometimes called “aerated, agitated bed” systems. In addition to that brought about by tumbling the composting material, aeration includes the forcing of air into the

composting mass by way of the perforations in the floor of the trough. It is likely that through a suitable adjustment in the frequency of the passage of the agitator through the trough contents, it would be possible to eliminate the forced-air feature without adversely affecting system performance. An exception would be the use of forced air as a means of controlling temperature.

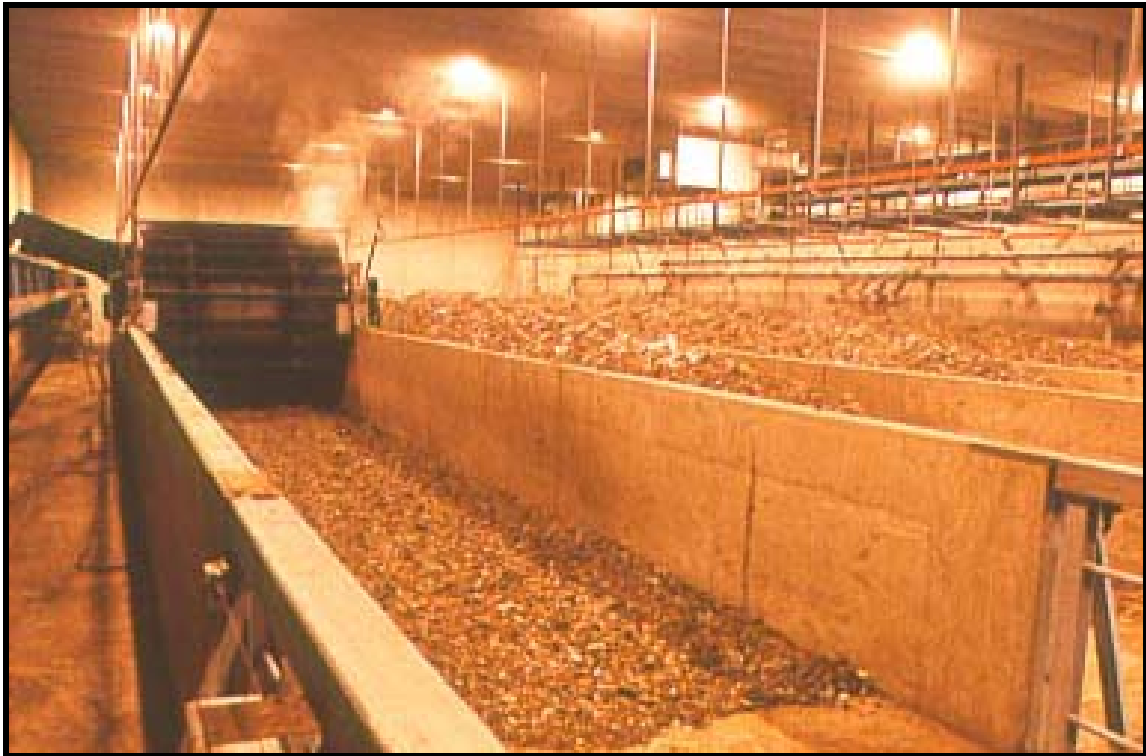

Courtesy: CalRecovery, Inc.

Figure VIII-9. Metro- or channel-type system, showing channels and agitator at left centre

The compost operation cycle begins with the discharge of size-reduced waste into the tank and subsequent passage of the travelling agitator through the wastes. Simultaneously, air is forced through the material. The agitator is passed through the mass on the order of once each day. The residence time recommended by the vendor is six days. Thereafter, the material is windrowed for one to two months. There are currently several systems on the market that utilise designs similar to those of the Metro system.

F2.1.5. Fairfield reactor

The Fairfield reactor is representative of in-vessel systems characterised by the use of stirring, combined with forced-air injection, to accomplish aeration. The reactor consists of an open cylindrical tank in which is installed a set of screws (“augers” or “drills”), which are hollow and are perforated at their edges. The set is supported by a bridge attached to a central pivoting structure. The reactor is shown in Figure VIII-10. The bridge with its collection of augers is slowly rotated. The augers are turned as the arm rotates. Air is discharged from the perforations and into the composting material as the screws are forced through the material. Residence time varies. If the time is less than two or three weeks, the material must be windrowed in order to attain stability.



Courtesy: CalRecovery, Inc.

Figure VIII-10. Fairfield reactor

F2.2. Economics

Intuitively, one would surmise that the economics of in-vessel systems in a developing country would be less favourable than those for windrow composting. In the early 1970s, capital costs for compost plants in the United States were on the order of US\$15,000 to US\$20,000/Mg of daily capacity; and operational costs were US\$10 to US\$15/Mg. In the late 1990s, capital costs were in the range of US\$40,000 to US\$100,000/Mg of daily capacity; and operational costs have varied between US\$30 and US\$60/Mg. A common failing in estimating and predicting capital, maintenance, and operational costs is the tendency to hold down apparent cost by basing the costs upon underdesigned equipment and underestimated labour requirements. Other factors to consider in making a comparative evaluation of in-vessel systems were discussed in the section, Technology.

G. Marketing and distribution of compost

G1. POTENTIAL markets

The benefits of using compost as a soil amendment are well documented. Compost increases the organic content of the soil and can improve its texture, its nutrient content, and its water retention and aeration capacities. Because of the utility of compost, it can be used in a variety of applications. Examples of such uses include [34]:

- Agriculture -- food and non-food crops, and sod farms
- Landscaping -- commercial properties and grounds maintenance
- Nurseries -- potted plants, bare root planting, and forest seedling crops
- Public agencies -- highway landscaping, recreational areas, other public property

- Residences -- home landscaping and gardening
- Other -- land reclamation and landfill cover

The quality of the compost dictates which types of uses are appropriate. For example, nurseries require a high-quality product; whereas, a lesser quality material would be suitable for land reclamation or landfill cover. Product quality is a function of a number of factors, including the types and characteristics of the feedstock material; the design and operation of the composting facility; and the post-processing, if any, that is employed to upgrade the product. Examples of post-processing activities include shredding, screening, nitrogen addition, and bagging.

The agriculture industry is the largest potential market for compost, especially in economically developing countries, although it can be difficult to penetrate. Factors that can militate against the use of compost in agriculture, as well as in other market segments, include: shortage of readily available, reasonably priced compost; unawareness of the general utility of the product; indifference; difficulty in applying the material; and cultural or other bias against the use of products generated from waste.

G2. SELLING price

Not all of the considerations that normally should enter into the determination of a suitable selling price of a commodity are applicable to the compost product. One such exception is the fact that the selling price need not fully defray the monetary cost of producing the product, the reason being that composting is a service in that it is a viable option in the treatment and disposal of organic wastes. Because of its role as a service, composting need not generate a revenue. On the other hand, practicality dictates that the cost of utilising the service should be competitive with other options, e.g., landfill and incineration. Obviously, the competitiveness of the composting option would benefit from revenue derived from the sale of the product. As of the early 2000s, the prevailing selling price of biosolids and yard waste composts in the United States is on the order of US\$7 to US\$25/Mg. In developing countries, the price of compost is on the order of US\$5/Mg.

Competitiveness is enhanced by the fact that composting is a resource recovery activity, characterised by a formidable array of environmental credits.

Despite the many benefits inherent in the compost option, the establishment of the selling price of the compost product is subject to certain important constraints. One such constraint is the sharp limitation exerted by the economics of the farming industry upon chemical fertilisers and inorganic additives. This, in turn, exerts a dampening effect on the establishment of the selling price of compost.

In the establishment of policies regarding the value of organic amendments, local, regional, and national governing bodies in developing nations should be aware that continued soil fertility depends upon maintenance of the soil's organic content. Inasmuch as this maintenance is best done through the use of the compost product, lowering of the product's selling price through subsidisation might be justifiable. However, this justification is not valid if the product is destined solely for landscaping and cultivation of ornamentals, unless such use is the maintenance and care of public grounds and recreational areas.

G3. MARKET development

As is true with other products, development of a market for compost involves instilling in potential users an awareness of the utility of the product. Additionally, it often is necessary to overcome existing inertia and bias.

In this section, the discussion of market development consists of a description and explanation of a plan conceived in, and formulated for, an agriculturally-oriented community situated in an elevated (about 2,600 m), semi-arid rural region. Corn (*Zea maiz*) is the principal agricultural crop. The soil is in dire need of organic matter. The proposed plan has the attractive feature of offering a program that adapts education to the promotion of the compost product.

The project plan calls for a cooperative undertaking in which a city and a farmers' cooperative are the active parties. An important component of the planned undertaking is a recycling/composting endeavour. According to the plan, the city would embark upon a resource recovery program in which it would process its wastes (MSW) such that reusable materials would be separated and removed, leaving a compostable residue. This residue would be delivered to the participating farmers' cooperative. The cooperative would then compost the material on sites controlled by the group. The compost product would be distributed among its members for use on their individual farms. Figure VIII-11 depicts a similar type of demonstration preformed jointly by the authors and a rural farm cooperative in an Eastern European country.



Courtesy: CalRecovery, Inc.

Figure VIII-11. Compost Demonstration and market development project performed at a rural farm cooperative

A key feature of the plan is the combined education/promotion program, designed to convince the farmers regarding the utility of the compost product in crop production. Consequently, the program would be in the form of a demonstration of the beneficial effect of compost on crop production.

According to local, experienced government agriculturalists, the first step in such a demonstration should be to encourage leading members of the farmers' cooperative to test the product on their farms. The leaders' participation would be valuable, if not essential, because they have earned the respect of their fellow farmers by virtue of demonstrated superiority in farming and in the conduct of farm affairs. In the first year of the demonstration, the leaders would be supplied with compost at no cost. To the extent permitted by circumstances, the leaders would use the compost in the conduct of scientific tests under the guidance of agricultural agents. The rationale of relying upon leaders to conduct the tests is obvious -- if the leaders are convinced as to the utility of the product, it should require no great effort to convince the other farmers.

The objectives of the tests were to be threefold:

1. to arrive at a determination of the extent to which chemical fertiliser requirements (NPK) could be met by the compost;
2. to demonstrate an increase in crop yield solely attributable to the addition of compost; and
3. to demonstrate an increase in water-holding capacity of the soil and the resulting enhancement of efficiency of irrigation water utilisation. (This benefit is a strong motivational factor, because of an unavoidable dependence in the region upon irrigation water. Hence, required expenditure for water is a significant element in a farmer's budget.)

It should be noted that the experimental plan did not include provisions for "control plots", i.e., plots in which compost serves as the only source of NPK. The omission was deliberate for a very practical reason -- extreme scarcity of land available to individual farms in the project region precluded farmers in that region from exposing themselves to any risk that could result in a diminution of a normal crop yield. Not surprisingly, no participant would be willing to include a control plot.

G4. PRODUCT distribution and transport

Having developed the market demand essential to the viability of a compost enterprise, logically, the next step is to devise and establish an effective and efficient distribution system. To be both effective and efficient, the distribution system must be such that the greatest number of consumers has ready access to the product at the lowest cost. Among the key considerations in devising an ideal, or at least, satisfactory system is the minimisation of haul distance between the point of production and the consumer. This factor derives its importance from the fact that transport cost is a decisive element in the magnitude of the eventual monetary burden to be borne by the consumer. Ultimately, transport cost is largely a function of distance.

A variety of strategies have been developed whereby required haul distance can be manipulated. One of the strategies calls for the production facility to be located centrally. The advisability of this strategy is a function of the relative advantages of centralised production facilities versus scattered production facilities. Greater economies of scale can be achieved with centralised production. However, transportation costs also would usually be expected to increase. The reduction of potential economies of scale characteristic of widely scattered facilities is compensated by a reduction in haul costs. Finally, in a developing country, economy of scale does not have the high degree of significance that it does in an industrialised country.

If the compost facilities are scattered, distribution would best be accomplished by having the individual consumer take delivery at the facility, inasmuch as no great distances would be involved. On the other hand, if a sizeable central facility is involved, the indicated course would be to establish a system of outlets at which prospective consumers could take delivery.

The mechanics of distribution are as diverse as the variety of possible situations.

H. References

1. "Second Interim Report of the Interdepartmental Committee on Utilization of Organic Wastes", *New Zealand Engineering*, 6(1-12), November/December 1951.
2. "Composting Fruit and Vegetable Refuse: Part II", *Investigations of Composting as a Means for Disposal of Fruit Waste Solids*, Progress Report, National Cannery Association Research Foundation, Washington, DC, USA, August 1964.
3. Schulze, K.F., "Rate of Oxygen Consumption and Respiratory Quotients During the Aerobic Composting of Synthetic Garbage", *Compost Science*, 1:36, Spring 1960.
4. Schulze, K.F., "Relationship Between Moisture Content and Activity of Finished Compost", *Compost Science*, 2:32, Summer 1964.
5. Chrometzka, P., "Determination of the Oxygen Requirements of Maturing Composts", *International Research Group on Refuse Disposal, Information Bulletin 33*, August 1968.
6. Lossin, R.D., "Compost Studies: Part III. Measurement of the Chemical Oxygen Demand of Compost", *Compost Science*, 12:12-31, March/April 1971.
7. Regan, R.W. and J.S. Jeris, "A Review of the Decomposition of Cellulose and Refuse", *Compost Science*, 11:17, January/February 1970.
8. Senn, C.L., "Role of Composting in Waste Utilization", *Compost Science*, 15(4):24-28, September/October 1974.
9. Golueke, C.G., *Composting*, Rodale Press, Inc., Emmaus, Pennsylvania, USA, 1972.
10. Niese, G., "Experiments to Determine the Degree of Decomposition of Refuse by Its Self-Heating Capability", *International Research Group on Refuse Disposal, Information Bulletin 17*, May 1963.
11. Rollé, G. and E. Orsanic, "A New Method of Determining Decomposable and Resistant Organic Matter in Refuse and Refuse Compost", *International Research Group on Refuse Disposal, Information Bulletin 21*, August 1964.
12. Möller, F., "Oxidation-Reduction Potential and Hygienic State of Compost from Urban Refuse", *International Research Group on Refuse Disposal, Information Bulletin 32*, August 1968.
13. Obrist, W., "Enzymatic Activity and Degradation of Matter in Refuse Digestion: Suggested New Method for Microbiological Determination of the Degree of Digestion", *International Research Group on Refuse Disposal, Information Bulletin 24*, September 1965.
14. Lossin, R.D., "Compost Studies", *Compost Science*, 11:16, November/December 1970.
15. Wylie, J.S., "Progress Report on High-Rate Composting Studies", *Engineering Bulletin, Proceedings of the 12th Industrial Waste Conference*, Series No. 94, May 1957.

16. Epstein, E., G.B. Willson, W.D. Burge, D.C. Mullen, and N.K. Enkiri, "A Forced Aeration System for Composting Wastewater Sludge", *Journal Water Pollution Control Federation*, 48(4):688, April 1976.
17. Golueke, C.G. and P.H. McGauhey, *Reclamation of Municipal Refuse by Composting*, Tech. Bulletin No. 9, Sanitary Engineering Research Laboratory, University of California, Berkeley, California, USA, June 1953.
18. Dean, R.B., "European Manufacturers Display Systems at Kompost '77", *Compost Science*, 19(2):18-22, March/April 1978.
19. *On-Farm Composting Handbook*, Northeast Regional Agricultural Engineering Service, Cooperative Extension, Ithaca, New York, USA, 1992.
20. Diaz, L.F., G.M. Savage, L.L. Eggerth, and C.G. Golueke, *Composting and Recycling Municipal Solid Waste*, Lewis Publishers, Ann Arbor, Michigan, USA, 1993.
21. American Public Works Association, *Standard Methods for the Examination of Water and Wastewater*, 13th Edition, APHA, Washington, DC, USA, 1971.
22. U.S. Environmental Protection Agency, *Autothermal Thermophilic Aerobic Digestion of Municipal Wastewater Sludge*, EPA/625/10-90/007, Risk Reduction Engineering Laboratory and Center for Environmental Research Information, Cincinnati, Ohio, USA, September 1990.
23. de Bertoldi, M., G. Vallini, and A. Pera, "The Biology of Composting: A Review", *Waste Management & Research*, (1):157-176, 1983.
24. Hortenstein, R., A.L. Leaf, E.F. Neuhauser, D.H. Dickelhaupt, and F. Hortenstein, *Physiochemical Changes Accompanying the Conversion of Activated Sludge into Castings by the Earthworm*, SUNY College of Environmental Science Forestry, Syracuse, New York, USA, 1979.
25. Collier, J., *Conversion of Municipal Wastewater Treatment Plant Residual Sludges into Earthworm Castings for Use as Topsoil*, First Annual Report to National Science Foundation, NSF Grant ENV77-16832, 1978.
26. Bartha, R., "Biotechnology of Petroleum Pollutant Biodegradation", *Microbial Ecology*, 12:155-172, 1986.
27. Golueke, C.G. and L.F. Diaz, "Bioremediation for Hazardous Wastes", *BioCycle*, 31(2):54-55, February 1990.
28. University of California, *Reclamation of Municipal Refuse by Composting*, Technical Bulletin No. 9, Sanitary Engineering Research Project, Berkeley, California, USA, June 1953.
29. Dinel, H., M. Schnitzer, and G.R. Mehuys, "Soil Lipids: Origin, Nature, Contents, Decomposition and Effects on Soil Physical Properties", *Soil Biochemistry*, 6:397-429, ed. J. M. Bollag and G. Sotzky, Marcel Dekker, New York, USA, 1990.
30. Dinel, H., M. Schnitzer, and S. Dumontet, "Compost Maturity: Chemical Characteristics of Extractable Lipids", *Compost Science Utilization*, 4(1):16-25, Winter 1996.

31. Savviozzi, A., R. Riffaldi, R. Levi-Minzi, "Compost Maturity Analysis", *Compost Production, Quality, and Use*, ed. M. de Bertoldi, M.P. Ferranti, P. L'Hermitte, and F. Zucconi, 359-367 pp., Elsevier Applied Sciences, London, England, 1987.
32. *Biosolids Composting*, Water Environment Federation, Alexandria, Virginia, 187 pp., 1995.
33. Golueke, C.G., "Composting Refuse at Sacramento, California", *Compost Science*, 1(3), Autumn 1960.
34. Eggerth, L.L., "Compost Marketing Trends in the United States", *The Science of Composting, Part 2*, proceedings of May 1995 International Conference on The Science of Composting, sponsored by European Commission and University of Udine, Bologna, Italy, 1996.
35. Park, K.J., M.H. Choi, and J.H. Hong, "Control of Composting Odour Using Biofiltration", *Compost Science & Utilization*, 10(4):356-362, Autumn 2002.
36. Lau, A.K., M.P. Bruce, and R.J. Chase, "Evaluating the Performance of Biofilters for Composting Odour Control", *Journal of Environmental Science & Health*, A31(9):2247-2271, 1996.
37. Lasaridi, K.E. and E.I. Stentiford, "A Simple Respirometric Technique for Assessing Compost Stability", *Water Resources*, 32:3717-3723, 1998.
38. Chica, A., et al., "Determination of the Stability of MSW Compost Using a Respirometric Technique", *Compost Science & Utilization*, II(2):169-175, Spring 2003.

CHAPTER IX. SINGLE-CELL PROTEIN AND ETHANOL PRODUCTION

A. Introduction

A1. EXPLANATION of the concept

Hydrolysis involves the use of waste materials as feedstock to produce single-cell protein and ethanol. Strictly speaking, two concepts are involved, the first of which is the production of a nutritious food for consumption by livestock or by humans. The second concept is the production of ethanol that can serve as a fuel in the production of energy. However, both concepts have a distinguishing characteristic -- namely, the use of a carbonaceous waste as the major source of carbon for the microorganisms that are involved.

The implementation of the first concept is a one-step process that consists of the use of waste as substrate in the culture of the single-cell microorganisms that collectively constitute an edible feedstuff that is highly nutritious for humans and livestock. Microorganisms that constitute the feedstuff are varieties or strains of the yeast, *Saccharomyces cerevisiae*, or of some other comparable species.

The implementation of the second concept is an integrated two-part process that consists first in the culture of microorganisms capable of fermenting sugars to ethanol, followed by harvesting the microorganisms and mixing them with sugar to produce ethanol. The microorganisms may be a particular yeast or bacterial species noted for its ethanol fermentation capability.

Although in the preceding paragraphs, reference is made to the concepts as one- or two-part processes, both must begin with a pre-treatment process in which the carbon in the waste is made available to the microorganisms. Pre-treatment is essential because, with rare exception, most of the carbon in waste is bound in highly complex molecules and, thus, is unavailable to all but a few highly specialised microorganisms. Fortunately, the bound carbon can be made accessible to the desired microorganisms through a process that disrupts the complex molecules -- namely, hydrolysis. Thus, hydrolysis is an essential step. Because of its importance, the greater part of this chapter is concentrated on hydrolysis and its various aspects.

A2. HISTORICAL development

The concept of expanding food and energy resources through the conversion of cellulose and complex carbohydrates in wastes into a single-cell protein feedstuff for humans and animal, or into ethanol, triggered an interest and subsequent research in the potential of hydrolysis in the 1940s [1]. These efforts became especially strong in the 1950s and persisted into the early 1960s. After a brief lag, interest and research revived in the late 1960s [2-4]. The interest originally was based on the fact that yeast constitutes a single-cell protein source that can serve as an important dietary supplement. Moreover, yeast also can produce ethanol through fermentation. Since the late 1970s, energy has begun to compete with and, indeed, surpass food in the hierarchy of popular concerns. The result is that now the interest is not so much in the conversion into a feedstuff as it is in the conversion into ethanol, a source of energy [5-7].

Sporadic interest in conversion of organic solid waste to ethanol continues as of this writing. In the early 2000s, the State of California (USA) analysed the production and economics of producing ethanol from several types of organic residues, including agricultural crop residues and

municipal solid waste [15]. The study found that large-scale production of ethanol from cellulosic biomass has not yet been demonstrated commercially.

A3. APPLICABILITY to developing countries

The principal source of cellulose and related complex carbohydrates in developing nations is agricultural residue; another source would be paper in municipal solid waste, although availability could be limited. This alternative to the management of some of the organic residues generated in economically developing countries may be too costly and sophisticated to be applicable to only but a few specific situations. Nevertheless, the concept is presented in this chapter for completeness.

B. Hydrolysis

B1. PRINCIPLES of hydrolysis

B1.1. Role of hydrolysis

As stated earlier, hydrolysis is an essential element in the waste to food and energy concepts, because it is through hydrolysis that the cellulose and carbohydrates in wastes are split into their constituent sugars. For example, the cellulose molecule may consist of more than 5,000 glucose units. The carbon in the glucose and other simple sugars is readily available to most microorganisms. Without the intervention of hydrolysis, the carbon in the cellulose and the complex carbohydrates are not available to microorganisms, particularly to those associated with single-cell protein or with ethanol fermentation. (The term “complex carbohydrates” will be referred to as “carbohydrates”.) It is through hydrolysis that the carbon in the glucose units that make up cellulose, and in the simple sugars that make up other carbohydrate molecules, are rendered available to yeasts and any other microorganisms that may be responsible for fermentation. (“Hydrolysis” often is termed “saccharification” when used in reference to the concept.)

B1.2. Factors

An especially influential factor in the hydrolysis of cellulosic waste is the ratio of crystalline to paracrystalline (amorphous) cellulose. The ratio has a major bearing on the practicality of using a particular waste as a feedstock to the process. The crystalline region of cellulose molecules is marked by a very closely packed structure and, hence, strong internal forces of attraction. On the other hand, the paracrystalline region is more randomly oriented. The high degree of order in the crystalline region renders the region more resistant than the amorphous (paracrystalline) region to hydrolysis. Therefore, the higher the ratio of crystalline to paracrystalline cellulose in a waste, the more difficult it is to hydrolyse the waste.

The surface-to-mass ratio of the waste particles exerts an important impact on hydrolysis, in that the smaller the particle, the more rapid is the physical or biological hydrolytic reaction. Another rate-related factor is the partial or complete masking of the cellulose molecules by lignin or some other resistant substance. The masking inhibits access of the hydrolytic mechanisms to the cellulose.

B1.3. Classification of methods of hydrolysis

The various methods of hydrolysis can be classified into three classes on the basis of the mechanism or process of splitting, i.e., disrupting cellulose and carbohydrate molecules. The classes are: chemical, physical-chemical, and enzymatic. In the literature, the terms “chemical

hydrolysis” and “acid hydrolysis” are often used synonymously. Even though physical disruption does not fully fit the classic definition of “hydrolysis”, in this chapter “acid hydrolysis” includes physical and physical-chemical disruption. Enzymatic hydrolysis is mostly biological in nature. Yet another class could be formed by integrating enzymatic hydrolysis with chemical hydrolysis.

Arguments abound regarding the relative superiority of one or the other particular class. Nevertheless, currently physical-chemical approaches are in the ascendancy in terms of attention. As will become apparent in the succeeding sections of this chapter, all classes depend upon complex technology, equipment, and highly qualified personnel. As mentioned previously, these complexities sharply limit the applicability of hydrolysis in developing countries.

B2. ACID hydrolysis

Basically, acid hydrolysis is a process in which the cellulosic fraction of a waste is suspended in an acidified aqueous medium that is maintained under pressure at an elevated temperature. It shares with other hydrolysis systems the general substrate and operational factors described in the preceding section. Other factors of particular significance to acid hydrolysis are liquids-to-solids ratio, acid concentration, and temperature. The rate of acid hydrolysis increases with increase in liquids-to-solids ratio.

Minimum particle size is determined by economic practicality, because energy and monetary costs of size reduction increase almost exponentially when the intended particle size is less than 5 cm. The permissible upper limit of the liquids-to-solids ratio also is determined by economic practicality. The consensus apparently places the upper ratio at 10 parts liquid to 1 part solids. Cost of acid, percentage of acid recovery, and rate of acceleration of corrosion establish the maximum permissible acid concentration. For sulphuric acid, the concentration would be about 0.5% in most situations. Yield of sugar is highest at the higher temperature levels and acid concentrations.

B2.1. System design

Acid hydrolysis can be carried out on either a batch basis or a continuous basis. Not unexpectedly, the batch approach is more appropriate for smaller operations, i.e., processing on the order of 120 Mg or less per day. In a batch operation, the entire hydrolysis process takes place in a single reactor. It proceeds in a sequence of steps: hydrolysis, flash vaporisation, neutralisation, and centrifugation. A 110 Mg/day operation would be based on two 70 Mg/day reactors operating in parallel, and involve the use of the same storage tanks and same centrifuge [3].

As in a batch system, the process steps in a continuous system are hydrolysis, flash vaporisation, neutralisation, and centrifugation. In a continuous system, however, a series of reactors is involved, the design of which differs from that of the single reactor in a batch operation. Each reactor in the series is followed by a screw press. The first reactor is designed to hydrolyse only the hemicellulose fraction of the waste. Sugars released by the hydrolysis are harvested by passing the reactor discharge through the screw press. Liquid discharge from the press contains the sugars. Sugars in the alphacellulosic fraction are in the solids (pulp) residue from the press. These sugars are obtained by re-acidifying the pulp and then passing it successively through a second and a third reactor. These two reactors are designed to hydrolyse the alphacellulose fraction of the waste.

The yield of sugars produced in acid hydrolysis is equal to about 35% to 45% of the incoming cellulose.

B2.2. Recent developments in technology

Most of the recent developments in hydrolysis seem to centre on the improvement and broadening of conventional chemical hydrolysis. This is accomplished by way of conditioning cellulosic and carbonaceous waste components, particularly fibres, such that sugar recovery efficiency is substantially improved. Thus, one approach involves exploding cellulosic fibres through the application of liquid anhydrous ammonia to biomass under pressure at 30° to 80°C for a few minutes, and then rapidly releasing the pressure. This blows individual fibres apart, thereby greatly increasing the surface area and accessibility of the cellulosic component. The ammonia is removed and the resulting material can be hydrolysed by weak acid or enzymes. Another innovation involves the use of a coaxial feeder and extruder to process biomass at 250°C and 3.2 MPa pressure. The exploded product is a moist fibre that is partially hydrolysed to permit easy fermentation. In a third innovation, concentrated acid (sulphuric, hydrochloric, or hydrofluoric acid) at 140° to 160°C results in approximately a 90% conversion of cellulose to sugar. (Compensating for the use of weaker acid by elevating the temperature to 180° to 200°C results in the production of undesirable byproducts, and sugar conversion drops to 50% to 60%.)

B3. ENZYMATIC hydrolysis

B3.1. Principles

In keeping with the descriptive term, “enzymatic”, hydrolysis of cellulosic and carbonaceous wastes is accomplished through the agency of the enzyme, cellulase. The process is essentially biological in that the hydrolytic enzyme is produced by microorganisms genetically capable of synthesising it. Cellulase is an enzyme that specifically splits cellulose molecules into their constitutive sugars (hexoses and pentoses).

B3.2. Types of cellulases and their relative effectiveness

B3.2.1. Constitutive vs. induced

The presence of cellulase is continuous in some microbes and is continuously synthesised. It is not continuously present in certain other microbes, and its synthesis must be triggered, i.e., induced by an external stimulus, usually the presence of cellulose or other reducing agent. Enzymes in the first class are termed “constitutive”, and those in the second class are termed “induced”.

B3.2.2. Extracellular vs. intracellular cellulase

The microbial origin of cellulase necessitates a two-stage process in enzymatic hydrolysis. In stage-1, cellulases are produced and harvested. In stage-2, the harvested enzymes are introduced into a waste. In the waste, the enzymes split, i.e., hydrolyse, cellulose and carbohydrate molecules into fermentable sugars, which are then harvested. Generally, the harvested sugars are used as the carbon source in ethanol fermentation.

Harvesting is facilitated by the fact that the cellulases involved in enzymatic hydrolysis are synthesised extracellularly by the cellulolytic microorganisms that produce them. Because they are extracellular, the cellulases are in the culture medium. If necessary, they can be extracted from the medium.

Some cellulolytic bacteria synthesise their enzymes intracellularly. For example, the cytophage have their enzymes system bound in the cell wall or membrane. With such an arrangement, hydrolysis depends upon the existence of a close contact between the cellulose and the cell wall

or membrane. Access to the bound enzyme would necessarily be by way of disrupting the individual microbes. Obtaining a cell-free enzyme extract would be an expensive operation.

B3.2.3. Enzymatic systems

The various cellulolytic enzyme (cellulase) systems can be divided into two groups -- namely, C_1 and C_X . The C_1 groups are effective on highly crystalline forms of cellulose (e.g., cotton fibre). They split crystalline cellulose into linear anhydroglucose. The anhydrous glucose chains are then split into soluble carbohydrates by C_X enzymes. This sequence has an important bearing on rate of hydrolysis of cellulosic waste because the first step in the hydrolysis must be the splitting of crystalline, i.e., resistant forms into simpler forms that are accessible by a wider array of enzymes. Thus, the higher the concentration of C_1 enzymes and hence the greater the concentration of microbes that synthesise them, the faster is the rate of hydrolysis. The fungus, *Trichoderma reesei*, has long been recognised as being an especially active synthesiser.

B3.3. Factors

The factors discussed in this section are specific to enzymatic hydrolysis. Chief among them are: 1) concentration of inducing agent (i.e., reducing sugar), 2) concentration of hydrolysis product (glucose), and 3) pre-treatment of waste.

B3.3.1. Concentration of inducing agent

The required concentration of cellulose is minute, i.e., about 0.5%. Activity usually is assured because cellulose generally is found in minute amounts with cellulose. However, it should be noted that cellulase production is repressed and activity is curtailed at cellulose concentrations greater than about 1.9%.

B3.3.2. Concentration of hydrolysis product

Cellulase formation also is inhibited and repressed in the presence of high concentrations of glucose. Inhibition resulting from a concentration of cellulose above the critical level can be counteracted by simultaneously imposing an inhibitory situation. It has been reported [7] that the concentration of enzymatic hydrolysis reducing sugars increases with the increase in concentration of solids in the substrate. The report states that using a 25% solids charge of compression-milled paper and a 10 IU/g enzyme-to-substrate ratio, it is possible to produce a reducing sugar syrup that has a concentration of 11%. Practical ethanol production is possible with such a syrup.

B3.3.3. Pre-treatment

Ideally, pre-treatment at a reasonable cost decreases cellulose crystallinity, disrupts the physical structure of lignin, and curtails cellulose polymerisation. The various proposed forms of pre-treatment may involve one or all of following three major steps: particle size reduction, heating, and perhaps, chemical treatment.

Most pre-treatment methods are based on the assumption that the cellulosic waste has been separated from the municipal solid waste stream and that all contaminants have been removed to the maximum extent permitted by economic feasibility.

Maintaining the temperature of the cellulose at 218°C during milling renders the inner surface of the cellulose more accessible and modifies the structure of the cellulose. Structure is modified

through the oxidation that takes place during heating. Cellulose can be heated either in a rotary kiln or preferably in an indirect-heat calciner dryer.

One of the several proposed forms of pre-treatment involves the induction of mild swelling and the partial solubilization of lignin through exposure to an alkali (e.g., NaOH) [4]. Succeeding the exposure to alkali is a period of air oxidation, which depolymerises the cellulose to a lower degree of crystallinity.

Another proposed form of pre-treatment calls for exposure to steam and compression milling (two-roll). Steaming is done by exposing moist solids to temperatures of 195° to 200°C for 15 to 30 min in a pressure vessel. The problem is that, although steaming increases the reactivity of agricultural residues and hardwoods, urban wastes lose 40% of their reactivity.

Another of the several proposed methods calls for compression or two-roll milling of newspaper for 6 to 10 min. Apparently, this innovation results in substantial increases in rates of enzymatic hydrolysis and yields of sugar. Another benefit attributed to compression milling is an increase in bulk density of the paper great enough to permit slurries of 20% to 30% to be used in hydrolysis [4]. The treatment is equally effective with all types of cellulosic materials. The additional expenditure of energy involved in compression milling reportedly is less than 0.60 kWh/kg newspaper.

B3.4. Technology

Advances in the technology of enzymatic hydrolysis of urban solid wastes took place in the 1970s. Since then, advance has been very slow and largely confined to refinements in equipment. Thus, the basic technology current in the 1970s is, with minor modifications, pertinent to present conditions. One of the more active centres of research into practical application of hydrolysis to municipal solid waste, i.e., the paper fraction, was at the Berkeley campus of the University of California (UC), and is fairly typical [5,6]. Hence, the process developed there is used to exemplify hydrolysis technology and the complexities associated with it.

The UC process incorporates the following five major steps: 1) feedstock preparation, 2) enzyme production, 3) the actual hydrolysis, 4) collection of the sugar (glucose) product, and 5) drying the residue. The entire flow pattern is diagrammed in Figure IX-1.

The detailed description begins with step-2, because step-1 (feedstock) was essentially covered in the preceding section, Pre-Treatment. The first of the two stages that constitute step-2, enzyme production, involves fungal growth followed by enzyme synthesis. Separation of the enzyme solution is the second stage. Fungal growth is accomplished by using standard industrial fermenters and a medium, and applying cultural conditions that favour the growth of the desired fungus (e.g., *Trichoderma*). Among these conditions are: 1) a medium that includes 0.3% superphosphate, 0.5% glucose, and the essential trace elements; and 2) a dilution rate of 0.2 per day. The medium should be sterilised. Sterilisation can be done by way of steam injection or heat exchange. Within the first stage, pure cellulose is introduced into the rapidly growing culture to induce enzyme synthesis. The introduction of pure cellulose initiates enzyme synthesis [8].

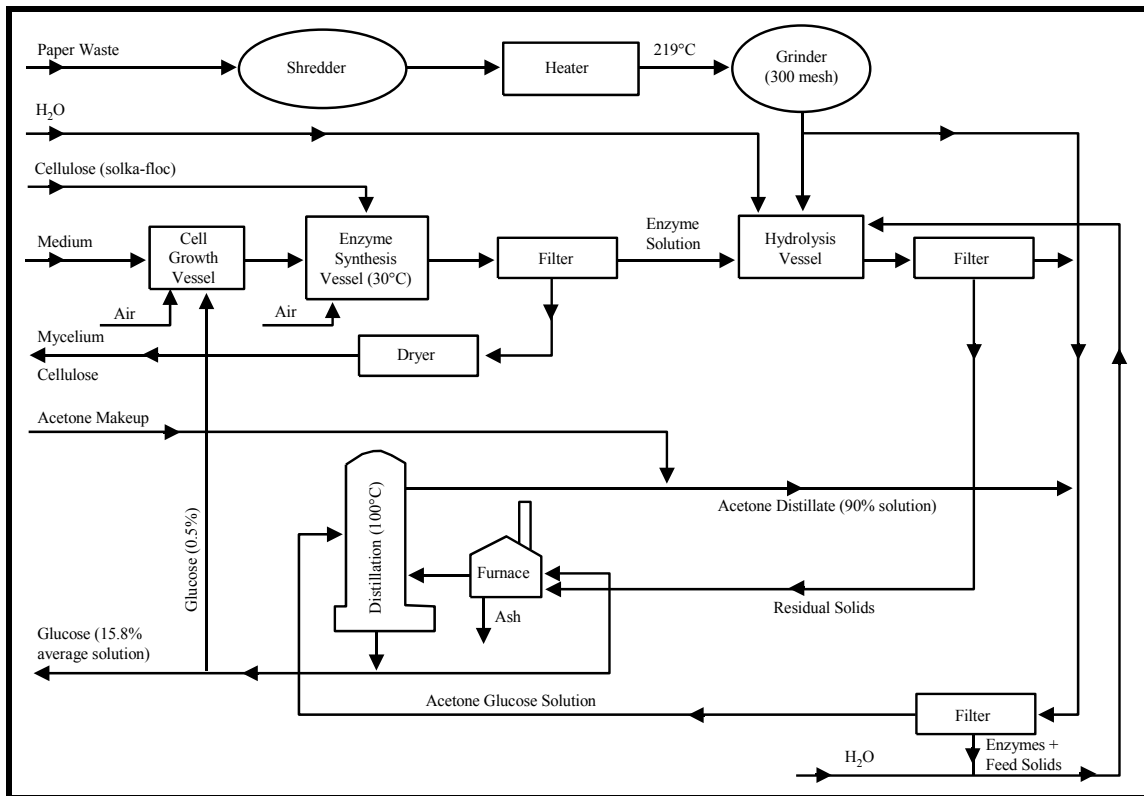

Figure IX-1. Diagram of the UC hydrolysis process

Separation of the enzyme is the second of the two main stages of step-2 of the UC process. The three methods available for separation are ultracentrifugation, precipitation by adding ammonium sulphate, and precipitation by adding acetone. Ultracentrifugation is very costly. Of the two precipitation methods, only the acetone method is practical because it is not always possible to separate the ammonium sulphate from the precipitate. A disadvantage of the acetone method is a 14% loss of enzymatic activity with each reuse of the enzyme solution. The precipitate (cellular material and unhydrolyzed cellulose) is removed from the enzyme solution by pressure filtration. The precipitate may then be dried and used as a cattle feedstuff [9,10].

B4. PRODUCTION system

Hydrolysis is the step in which the cellulose waste to be hydrolysed is introduced. Introduction is by way of suspending the waste in the enzyme solution produced in step-1. The enzymes in the solution catalyse the conversion of the cellulose into sugars.

B4.1. Specifications

The following specifications and conditions are taken from References 5 and 6. They are: 1) solids concentration of suspension, 11.5%; 2) retention time, 40 hr; and 3) suspension temperature, 50°C (this renders conditions relatively aseptic). Solids remaining in the suspension after hydrolysis is completed are removed by passing hydrolysed effluent through a pre-coated vacuum filter. The solids residue can be burned and the resulting heat energy used to generate steam and distil acetone from the effluent. Acetone from the distillation system (combined with a small makeup stream) is added to the aqueous enzyme-glucose solution in a volumetric ratio of 2:1. An almost complete precipitation of protein results. The precipitate may contain as much as 85% of the original enzyme activity. The enzyme solution is recovered by means of a pressure filter and returned to the hydrolysis units. Acetone is recovered by passing the filtrate through acetone distillation columns. Heat for the distillation columns comes from the combustion of the

residual solids. The distillate is 90% acetone. The glucose solution remaining after the distillation contains only a trace of acetone. About 1% of the glucose solution is returned to the first fermentation stage, and the remaining 99%, which is a 5% to 6% solution of reducing sugar, constitutes the final plant product.

B4.2. Capital equipment requirements

The capital equipment requirements for a hydrolysis plant have been reported for a 9.1 Mg/day processing capacity [5,6]. The requirements are summarised in Table IX-1. The plant would produce about 0.3 Mg/day of dry fungal mycelium-cellulose mixture and 8.3 Mg/day of glucose in the form of a 5.3% syrup. The distribution of the capital costs among the major processing stages of the system is itemised in Table IX-2. It should be noted that the lists presented in Tables IX-1 and IX-2 do not take into consideration the capital requirements for acetone recovery. Moreover, the percentage of the total capital investment for cellulose pre-treatment, especially for particle size reduction (milling), is unrealistically low.

C. Single-cell protein

Selection of an appropriate microorganism is essential to the success of any single-cell protein production undertaking. The microorganism must be one that is edible and can serve as a feedstock for humans and/or livestock. Of course, its culture must be technologically and economically feasible. To satisfy the second condition: 1) the organisms must grow rapidly and vigorously; 2) culture of the organism should involve the use of relatively simple growth units and inexpensive nutrient sources (e.g., commercial crop fertilisers); 3) ideally, the organism could be grown in open culture, or at least as an enrichment culture; and 4) because single-cell protein production is only marginally economically feasible, the least “permissible” condition is the need to culture the organism under sterile conditions, i.e., as a completely pure culture. However, competition with other organisms is eliminated in sterile culture and rapidity of growth is thereby increased. Moreover, contamination with possibly toxic organisms is avoided.

Most of the work on single-cell protein production has been focused on the yeast, *Candida utilis* (*Torula utilis*). The yeast meets most of the requirements named in the preceding paragraph. Not only is the yeast easily grown, it also is a good food and fodder yeast. Although sterility is necessary, purity of culture is not essential.

The high nucleic acid content of bacterial proteins renders them less desirable as feedstuff for man and animal. Additionally, some groups of bacteria are characterised by the possession of endotoxins. The endotoxins could be incorporated in the feedstuff product. There is also a possibility that certain bacterial feedstuffs can promote allergenic reactions in humans who handle or ingest them. Finally, the much smaller size of bacteria makes them more difficult to harvest than yeasts.

Table IX-1. Major equipment requirements for a 9.1 Mg/day hydrolysis plant

Item	Size/Capacity
Fermenters (4)	197 m ³
Hydrolysis vessel	263 m ³
Filter 1	2.23 m ² surface
Filter 2	8.36 m ² surface
Air filter	0.22 SCMS
Shredder	454 kg/hr
Heater	454 kg/hr
Grinder	817 kg/hr
Dryer 1	13.9 m ² surface
Dryer 2	118 m ² surface
Heat exchanger 1	7.9 m ²
Heat exchanger 2	4.7 m ²
Heat exchanger 3	18.6 m ²
Heat exchanger 4	2.8 m ²
Air compressor	0.234 SCMS
Medium supply tanks (2)	37.9 m ³
Fermenter motors (4)	10 hp
Hydrolysis unit motor	20 hp
Medium supply motors (2)	5 hp
Solids feeder	817 kg/hr
Screw conveyors (2)	454 kg/hr
Centrifugal pumps (3)	189 L/min

Source: Reference 5.

Table IX-2. Distribution of fixed capital costs for a 9.1 Mg/day hydrolysis plant

Item	(%)
1. Cellulose pre-treatment	11.1
Shredding	
Heating	
Grinding	
2. Enzyme production	52.6
Fermentation	
Air and medium sterilisation	
Medium supply system	
3. Cellulose hydrolysis	12.4
4. Cellulose recycle and product recovery	23.9
Filtration	
Drying	
Total	100

Source: Reference 5.

C1. INDIRECT vs. direct production

The relation of single-cell protein production to the reclamation of useful nutrient elements in waste is by way of the utilisation of sugars formed through hydrolyzation of cellulosic substances in municipal waste. However, a separate hydrolysis step may be bypassed by culturing the yeast directly on the cellulosic waste. For convenience, in this presentation, the two approaches are respectively designated by the terms “indirect” and “direct”.

C1.1. Indirect production

The production of *C. utilis* is an example of the indirect approach. The sequence of events in the production is diagrammed in Figure IX-2.

With respect to nutritional requirements, the sugars (glucose) satisfy the carbon needs. The other required essential nutritional elements are nitrogen, phosphorus, and potassium, which must come from an external source. Usually, nitrogen is added as an ammonium compound (e.g., ammonium sulphate); a phosphate is used for phosphorus; and a potassium sulphate or hydroxide compound for potassium. Generally, it is not necessary to add the essential trace elements.

Principal cultural conditions are a temperature at 20° to 35°C; and O₂, about 1.02 kg/kg cell mass-produced. The necessarily aerobic conditions are attained by continuously agitating the culture. The volume of air applied to meet the oxygen demand would be a rate of about 120 millimoles O₂ absorbed per L-hr (3.84 g/L-hr). The yield to be expected at such a rate is 3.66 g yeast per L-hr.

Under proper cultural conditions, the yield of the cell mass should be from 45% to 55% of the sugar consumed [3]. The production rate under continuous conditions depends upon a combination of cell mass and hydraulic detention time (culture volume/volume feed medium/day). Maximum cell concentration is a function of the hydrolysate sugar concentration multiplied by the sugar conversion efficiency of the yeast.

C1.2. Direct production

Direct production differs from indirect production in that organisms are cultured upon unhydrolyzed wastes. Indirect production involves two discrete steps (hydrolysis and cell production); whereas in direct production, the two steps are neither spatially nor always temporally discrete. Although of necessity, the steps are sequential (hydrolysis must precede utilisation for cellular growth; both may involve the same microorganism). In other words, an organism can degrade a cellulosic molecule and utilize the constituent sugars to synthesise cellular mass. All sequences are not occurring simultaneously and, collectively, they constitute a single unit process. Therefore, at least some of the microorganisms must be cellulolytic, i.e., capable of breaking down cellulose molecules. Preferably, most should be cellulolytic. A disadvantage is the inability to use submerged culture in the absence of special adaptations.

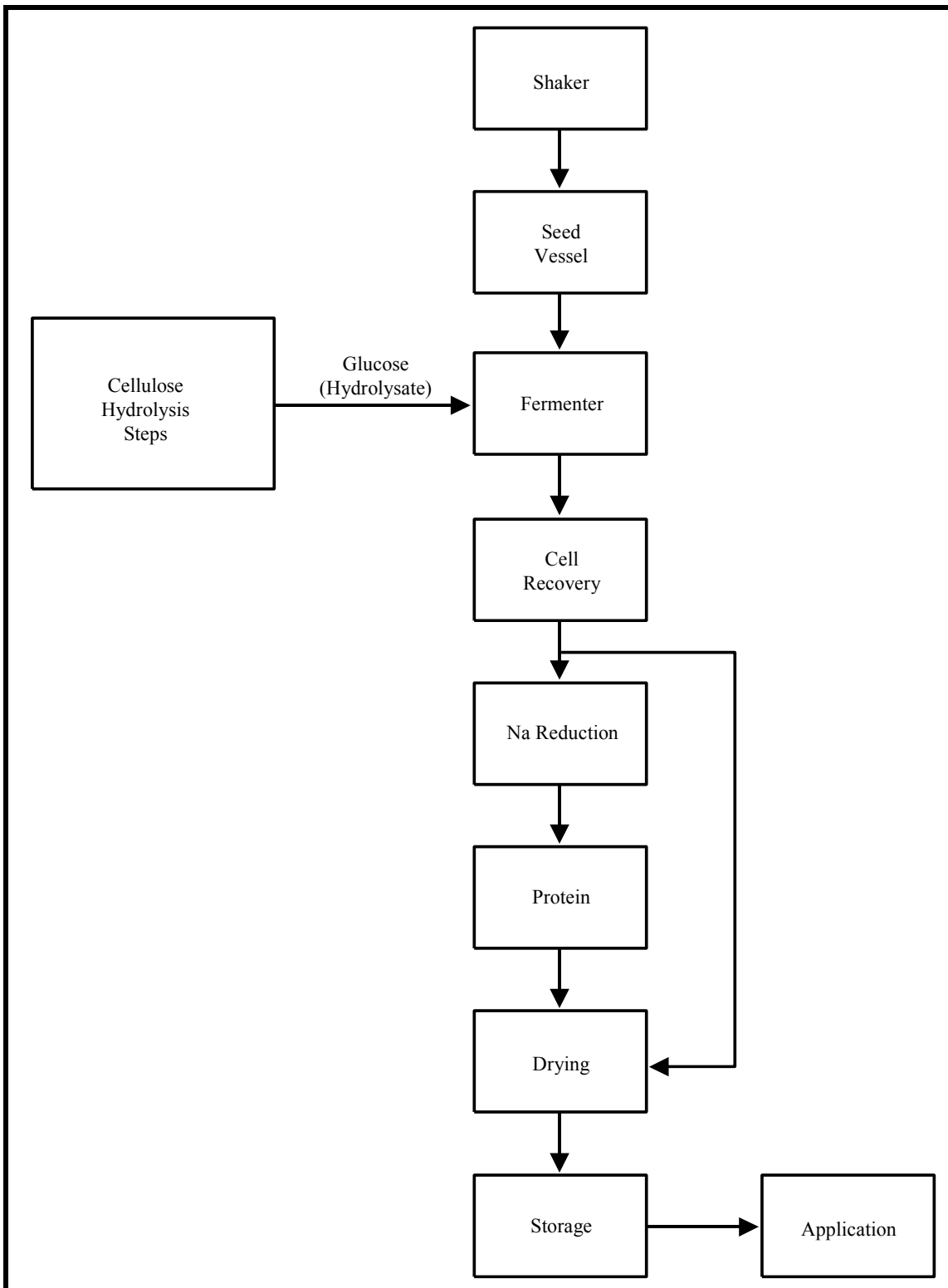

Figure IX-2. Indirect production of single-cell protein

Most of the experience with single-cell production from waste has been at the laboratory- and pilot-scale levels and has been with paper and bagasse. Paper is from 40% to 80% cellulose, 20% to 30% lignin, and 10% to 30% hemicellulose and xylosans. Bagasse is the residue remaining after the juice has been extracted from sugar cane by milling. Inasmuch as the studies were limited to laboratory- and pilot-scale levels, projections and estimates based on the studies must be considered in that light.

Among the cellulolytic microorganisms that have been studied are the yeasts, *C. utilis* and *Myrothecium verrucaria*, and the bacteria, *Cellulomonas flavigena* [3,11].

In a study that involved the culture of *M. verrucaria* on a substrate composed of ball-milled newspaper, a yield of crude protein amounting to 1.42 g/L was obtained [11]. A pilot-scale study involved the application of a system such as is diagrammed in Figure IX-3 [12,13]. The organism used in the investigation was *C. utilis*. The bagasse was pre-treated because experience had shown that without pre-treatment, the soluble carbohydrate content of untreated bagasse is only about 2%; whereas after treatment, it is almost 18%. Pre-treatment reduces the cellulose crystallinity of the bagasse from almost 50% to only 10%. As stated earlier, pre-treatment generally takes one or a combination of the following forms: fine milling and exposure to moderately elevated temperature under either acid or alkaline conditions.

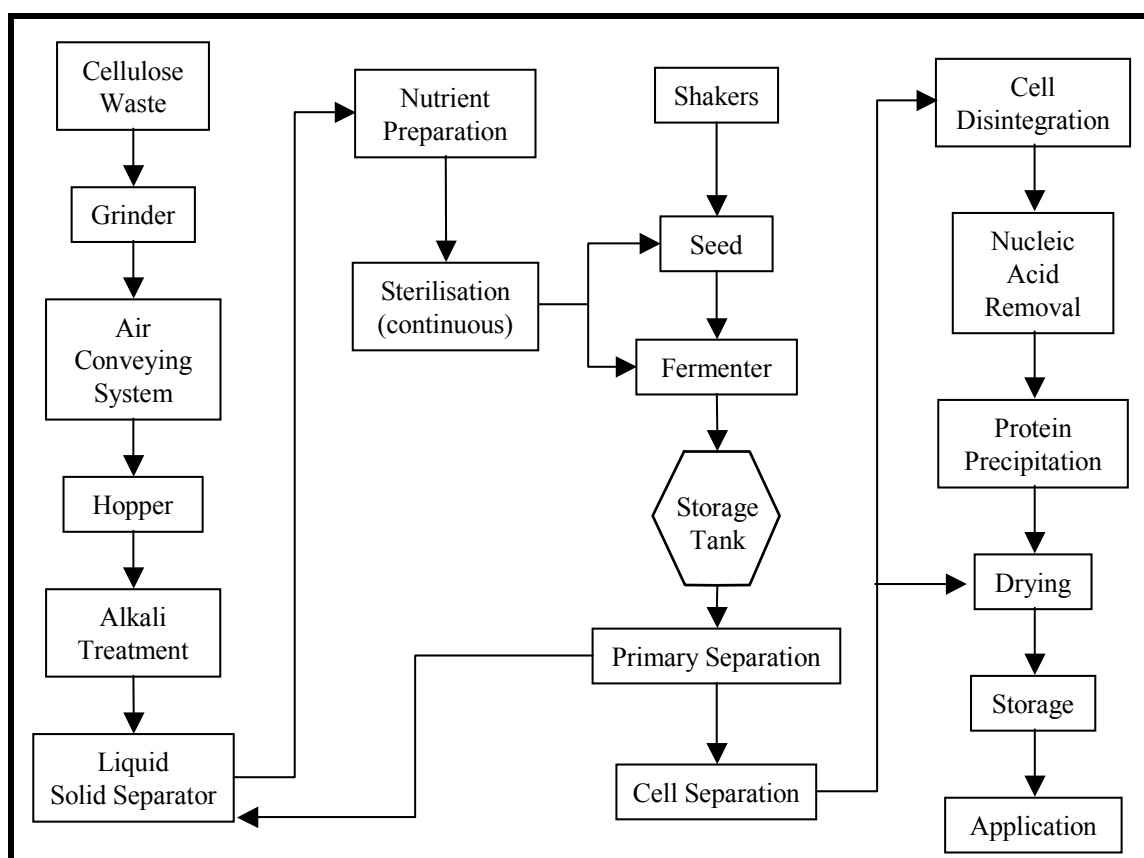

Figure IX-3. Direct production of single-cell protein by US Army Natick Lab

The bacteria *C. flavigena* and *C. uda* constituted the product in a pilot study in which the feedstock was bagasse [4]. The study confirmed the need to pre-treat bagasse -- specifically, alkaline pre-treatment. Moreover, in the study, extent of conversion of feedstock to cell mass was very modest despite a continuous fermenter efficiency of 75% and an approximate 90% solubilization of bagasse. Supplementary nutritional needs could be supplied by fertiliser and industrial chemicals. From 50% to 55% of the product is crude protein that has a good amino acid balance [14].

Another pilot-scale study involved a mixed culture of *Cellulomonas* and *Alcaligenes faecalis*. The cell density was 6.24 g/L. The crude protein composition was as follows (in g/100 g protein): arginine, 9.21; histidine, 2.30; isoleucine, 4.74; leucine, 11.20; lysine, 6.84; methionine, 1.86; phenylalanine, 4.36; tyrosine, 2.67; threonine, 5.37; and valine, 10.71.

C2. HARVESTING

Harvesting usually is done in two main stages: a concentration stage and a concentrate processing stage.

C2.1. First-stage concentration

This stage results in the formation of a concentrate that has a sludge-like consistency and is in need of further processing. The need for the concentration step arises from the relatively low concentration of cells and large volumes of material that must be processed. The sludge (concentrate) is dewatered and dried. The concentration step is beset with many and grave difficulties due to the microscopic size and the physical characteristics of the cells, as well as their modest monetary value. The several technologies available for accomplishing the concentration step can be grouped into the categories of screening, filtration, settling (sedimentation), and centrifugation.

C2.1.1. Screening and filtration

Screening and filtration are discussed under a single heading because they share a common characteristic: separation of particles (cells) depends upon the difference between the size of the particles and that of the openings (screen) or pores (filter medium). The problem is that the screen or filter medium becomes clogged before a workable “cake” can be accumulated.

C2.1.2. Settling

Their small size, low specific gravity, density, and low settling velocity render concentration by sedimentation impractical. The settling velocity of yeast cells is approximately 1.1×10^{-5} cm/sec.

Significant advances in settling tank design and operation may enhance settling to a point at which it becomes a feasible option. Another approach to settling or a modification is to induce floc formation and thereby promote settling to a level at which it might be practical. Floc formation can be induced by altering the surface charge of yeast cells such that they agglomerate into floc particles. Surface charge can be altered by introducing a polymer flocculant (either anionic or cationic) into the suspension. Alteration can also be accomplished by passing the suspension through an ion exchange column.

C2.1.3. Centrifugation

Centrifugation is an effective concentration method. Unfortunately, it is expensive in terms of equipment and power, and requires skilled personnel. A high-velocity rotor is necessary because of the microscopic size and low specific gravity and density of the cells and viscosity of the medium. A putative advantage is that the two separation stages can be accomplished in a single operation.

C2.2. Second stage - concentrate (sludge) processing

Treatment consists of dewatering and drying. Flash drying is a good approach. It is rapid and is amenable to mass production and is successfully used in food and feedstuff preparation. Moreover, it removes threats to human and animal health posed by chance pathogens. Other options include pressure filtration and vacuum drying, such as is used in sewage sludge conditioning.

C3. EQUIPMENT requirements and costs

The data listed in Table IX-3 provide an indication of the equipment that might be required in commercial production of single-cell protein. The table includes data that indicate the relation of the cost of individual types of equipment to the total cost. The basic flows for minimum-size versions of direct and indirect production of single-cell protein are presented in Table IX-4.

Table IX-3. Equipment requirements and relative costs for the production of single-cell protein

Cost Element	Direct Production		Indirect Production	
	Equipment (500-L base)	% of Total Cost	Equipment (1,200-L base)	% of Total Cost
Pre-treatment line	6 units	18	5 units	15
Sterilisation system	2 units	3	2 units	3
Enzyme production line	--	--	5 units ^a	11
Syrup manufacturing line	--	--	4 units	3
Cell (metabolite) line	2 units ^b	22	2 units ^c	11
Cell recovery line	2 units	5	2 units	5
Protein recovery	3 units	7	3 units	6
Drying distillation	1 unit	10	1 unit	10
Instrumentation - interface		15		18
Computer hardware - program (software)		20		18
Totals		100		100

Source: Reference 2.

^a 350-L seed vessel; 1,200-L fermenter; two storage tanks; one ultrafiltration system.

^b 100-L seed vessel; 500-L fermenter.

^c 550-L seed vessel, 1,200-L fermenter.

Table IX-4. Basic annual flows of a minimum-size commercial single-cell protein plant

Parameter	Direct Production (Mg)	Indirect Production (Mg)
Raw material input	8,100	17,000
Intermediate output	--	6,000
SC output	1,200	1,200
Liquid flow rate for cell separation	20,000	20,000
Average cell mass (g/L) ^a	25	25

Source: Reference 12.

^a Assuming 20% loss during recovery.

D. Ethanol production

The relation of ethanol production to hydrolysis is through the use of the glucose released in the hydrolysis of a cellulosic waste [16,17]. In other words, the substrate for ethanol production is the sugar produced in the hydrolysis of the cellulosic fraction of the waste feedstock. The sugar serves as the carbon source for the microbes responsible for ethanol fermentation.

Expressed over-simply and hence very loosely: "Ethanol fermentation is accomplished by culturing strains of microbes capable of converting the carbon (C) in the glucose molecule to the C in ethanol". Several strains and varieties of bacteria and fungi have been identified as being capable of fermenting sugars to ethanol. Among the fungi are a few varieties of *Rhizopus* and yeast forms of *Aspergillus*, *Penicillium*, and "Fungi imperfecti". Perhaps the best known and most thoroughly explored are selected varieties and strains of the yeast, *Saccharomyces cerevisiae*. (Because *S. cerevisiae* is representative, it is used in the succeeding paragraphs to typify ethanol fermentation technology.)

In contrast to the aerobic conditions required in hydrolysis, ethanol fermentation takes place only under anaerobic conditions regardless of type of microorganism. Hydrolysate sugars are readily fermented by *S. cerevisiae*. The conversion efficiency reportedly is 83%, and the gross energy for the conversion of newsprint to ethanol is 47% for the hydrolysis step, and 37% for the waste to ethanol step (exclusive of credit for waste heat) [6]. The net efficiencies are 34% and 24%, respectively.

Inasmuch as practical experience in the use of cellulosic solid waste for ethanol production has been negligible, reliance must be had on information gathered in past laboratory- and pilot-scale studies. Consequently, projections and extrapolations reported in the literature are largely conjectural. This limitation, however, applies only to the use of hydrolysate sugars as an ethanol fermentation substrate. The technology of ethanol fermentation of substrates other than cellulosic solid wastes not only is well developed, it also is being vigorously continued because of the significance of ethanol as an energy source. Documentation of the advance also continues apace. Even with respect to cellulosic wastes, the uncertainty and scarcity of the literature is more applicable to the preparation of the feedstock and its hydrolysates than to the fermentation of the hydrolysates. Thus, one can justifiably conclude that conventional fermentation technology should be suitable for the fermentation of the hydrolysis sugars.

E. References

1. Saeman, J.F., "Kinetics of Wood Saccharification", *Ind. and Engineering Chemistry*, 37(1):43, January 1945.
2. Fagan, R.D., H.E. Grethein, A.O. Converse, and A. Porteus, "Kinetics of Acid Hydrolysis of Cellulose Found in Paper", *Environmental Science and Technology*, 5(6):545, June 1971.
3. Meller, F.H., *Conversion of Organic Solid Wastes into Yeast: An Economic Evaluation*, prepared for Bureau of Solid Waste Management by IONICS, Inc., under contract PH86-87-204, U.S. H.E.W. (presently, U.S. Environmental Protection Agency), 1969.
4. Callihan, C.D. and C.E. Dunlap, *Construction of a Chemical-Microbial Pilot Plant for Production of Single-Cell Protein from Cellulosic Wastes*, Report SW-24c, U.S. Environmental Protection Agency, Cincinnati, Ohio, USA, 1971.

5. Rosenbluth, R.F. and C.R. Wilke, *Comprehensive Studies of Solid Waste Management: Enzymatic Hydrolysis of Cellulose*, SERL Report 70-9, Sanitary Engineering Research Laboratory, University of California, Berkeley, California, USA, December 1970.
6. Wilke, C.R. and G. Mitra, "Process Developmental Studies on the Enzymatic Hydrolysis of Cellulose", presented at National Science Foundation Special Seminar, *Cellulose as a Chemical and Energy Source*, University of California, Berkeley, California, USA, June 1974.
7. Spano, L., T. Tassinari, D.D.Y. Ryu, A. Allen, and M. Mandels, "Enzymatic Hydrolysis of Cellulose to Fermentable Sugar for Production of Ethanol", *Proceedings of the Biogas and Alcohol Seminar*, Chicago, Illinois, J.G. Press, Emmaus, Pennsylvania, USA, October 1979.
8. Mandels, M. and J. Weber, "The Production of Cellulases for Specific Purposes", presented at Cellulase Symposium, American Chemical Society Fall Meeting, Atlantic City, New Jersey, USA, September 1968.
9. Webb, F.C., *Biochemical Engineering*, Van Nostrand, London, England, 1964.
10. Aiba, S., A.E. Humphrey, and N.F. Mills, *Biochemical Engineering*, Academic Press, Inc., New York, New York, USA, 1965.
11. Updegraff, D.M., "Utilization of Cellulose from Waste Paper by *Myrothecium verrucaria*", *Biotechnology and Bioengineering*, 13:77-97, 1971.
12. Nyiri, L.K., "Processing of Cellulosic Materials by Biological Means: An Economic Evaluation of Biosynthesis Systems and Processes", presented at International SITRA Symposium on Enzymatic Hydrolysis of Cellulose, Hammeenlinna, Finland, March 1975.
13. Mandels, M., M. Lihontz, and J. Hystrom, "Enzymatic Hydrolysis of Waste Cellulose", presented at 8th Cellulose Conference, SUNY, Syracuse, New York, USA, May 1975.
14. Srinivasin, V.R., "Single Cell Protein from Cellulosic Wastes", presented at Cellulose Solid Waste Seminar, Environmental Control Administration, Cincinnati, Ohio, USA, March 1969.
15. California Energy Commission, *Costs and Benefits of a Biomass-to-Ethanol Production Industry in California*, Commission Report, P500-01-002, March 2001.
16. US Department of Agriculture, *Small-Scale Fuel Alcohol Production*, Washington DC, March 1980.
17. Solar Energy Research Institute, *Ethanol Fuels Reference Guide: A Decision-Maker's Guide to Ethanol Fuels*, SERI/SP-451-442, October 1982.

CHAPTER X. TYPES OF WASTE-TO-ENERGY SYSTEMS

A. Introduction

During the 1970s and early 1980s, many of the nations of the world became gravely affected by the high cost of imported oil and by the scarcity of low-cost alternative fuels. This situation precipitated a search for alternative sources of energy, which in turn led to a renewed interest in urban wastes as one potential source. The renewed interest in the energy potential of urban wastes was not surprising, for two reasons: 1) a sizeable fraction of the waste, depending on the country, can consist of combustible components, i.e., materials that can serve as a fuel in the production of heat energy; and 2) incineration of municipal waste and use of the waste heat produced therefrom had been practiced in Europe for many years.

Many of the combustible components of municipal solid waste are also biodegradable and, thus, can serve as substrates for biological conversion to a fuel gas that is immediately converted into energy (i.e., direct conversion into heat energy), or that can be stored or transported for later conversion (i.e., indirect conversion). The energy potential of all urban wastes is not the same, in that they differ both in energy content and in the ease with which the energy can be “extracted”.

Energy can be extracted from solid wastes in many ways. A schematic diagram of the various methods of energy recovery, and of the types of fuel and forms of energy that can be produced from municipal wastes, is presented in Figure X-1. As illustrated in the figure, energy recovery can be accomplished with or without mechanical, manual, or mechanical/manual processing of the wastes prior to their conversion (i.e., pre-processing). Energy recovery without pre-processing is accomplished by conversion of the wastes predominantly in the form in which they were generated. Energy recovery through pre-processing is accomplished by one or more of the methods shown in the figure. The main objective of pre-processing a waste for energy recovery is to segregate the organic or combustible fraction from the remainder of the waste, i.e., the non-combustibles.

B. Incineration and refuse-derived fuel production

B1. FUEL characteristics

The value of wastes in direct conversion lies primarily in their energy content or heating value. Chemical elements that make the greatest contribution to the heating value of wastes are principally carbon and hydrogen. On the other hand, the fuel value of the wastes is adversely affected by moisture content and the inclusion of non-combustible materials.

The fuel value of the refuse-derived fuel, as well as the actual incineration of the material, is decided in large part by the composition of the wastes. For example, the relatively high moisture content of putrescible materials must be lowered before ignition can take place. The energy to accomplish this removal must come from that released when dry materials are burned, or by supplying additional energy by combusting supplemental (e.g., fossil) fuels along with the wastes. A perusal of the data listed in Table X-1 shows that the urban wastes generated in several developing nations can be approximately 50% to 70% putrescible on a wet weight basis. On the other hand, the quantities of discarded paper and plastics are relatively small. Therefore, the overall percentage of dry, combustible (volatile) matter is small. Additionally, the ash content of urban wastes in some locations in developing countries can be substantial (e.g., up to 60% where wood ash, coal ash, or both are major waste byproducts of domestic activities). The combination of these attributes of the wastes can render the waste conversion system as a net user of energy,

as opposed to a net supplier. The relation among the fundamental parameters is illustrated in Figure X-2. The upshot of this situation is that incineration and thermal processing in general for energy production may not be applicable to a developing nation, or may be feasible only in certain locations or under special conditions.

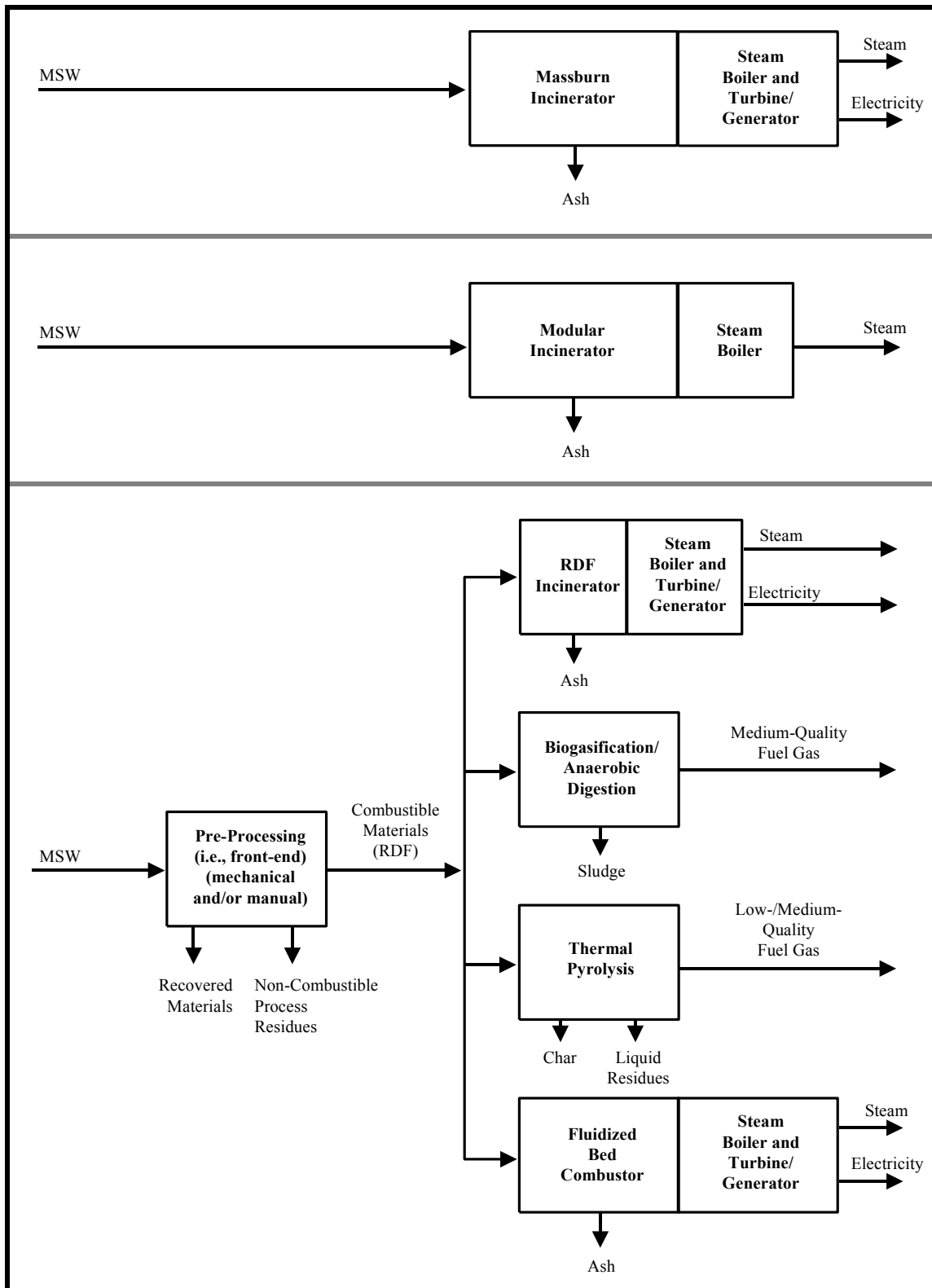

Figure X-1. Examples of methods of recovering energy from solid wastes

Table X-1. Comparison of solid waste characterisation worldwide (% wet wt)

Location	Putres-cibles	Paper	Metals	Glass	Plastics, Rubber, Leather	Tex-tiles	Ceramics, Dust, Stones	Wt (g)/cap/day
Bangalore, India [1]	75.2	1.5	0.1	0.2	0.9	3.1	19.0	400
Manila, Philippines [2]	45.5	14.5	4.9	2.7	8.6	1.3	27.5	400
Asunción, Paraguay [2]	60.8	12.2	2.3	4.6	4.4	2.5	13.2	460
Seoul, Korea [3]	22.3	16.2	4.1	10.6	9.6	3.8	33.4 ^a	2,000 ^a
Vienna, Austria [4]	23.3	33.6	3.7	10.4	7.0	3.1	18.9 ^b	1,180
Mexico City, Mexico [5]	59.8 ^c	11.9	1.1	3.3	3.5	0.4	20.0	680
Paris, France [4]	16.3	40.9	3.2	9.4	8.4	4.4	17.4	1,430
Australia [7]	23.6	39.1	6.6	10.2	9.9		9.0	1,870
Sunnyvale, California, USA [6]	39.4 ^d	40.8	3.5	4.4	9.6	1.0	1.3	2,000
Bexar County, Texas, USA [6]	43.8 ^d	34.0	4.3	5.5	7.5	2.0	2.9	1,816

^a Includes briquette ash (average).

^b Includes “all others”.

^c Includes small amounts of wood, hay, and straw.

^d Includes garden waste.

B2. INCINERATION

The incineration of raw (unprocessed) wastes is practiced throughout the world, particularly in European countries where it has been in use for decades. The simplest and crudest method of incineration is open burning. With the successive changes that have taken place in technology in general and in environmental concerns, the combustion process gradually has become subjected to increasingly “controlled” conditions. Initially, the main objective of the process was to reduce the volume of the material requiring disposal. Later, the products of combustion (hot gases) were used to generate steam.

Incineration of raw wastes has its advantages and its disadvantages. Two main advantages come to mind, particularly for an energy- and space-hungry, densely populated metropolis; they are the potential for generating steam and the accomplishment of volume reduction. On the other hand, incineration has a serious disadvantage in the form of the substantial cost of controlling and managing its pollutant emissions. The general forms of the pollutants generated during the course of incineration include air emissions, bottom and fly ash, and wastewater. Another important disadvantage is the fact that the direct combustion of the raw wastes does not provide an opportunity for substantial recovery of material resources.

Within this book, stoker-fired, modular, and fluidised bed systems are included within the definition of incineration technologies.

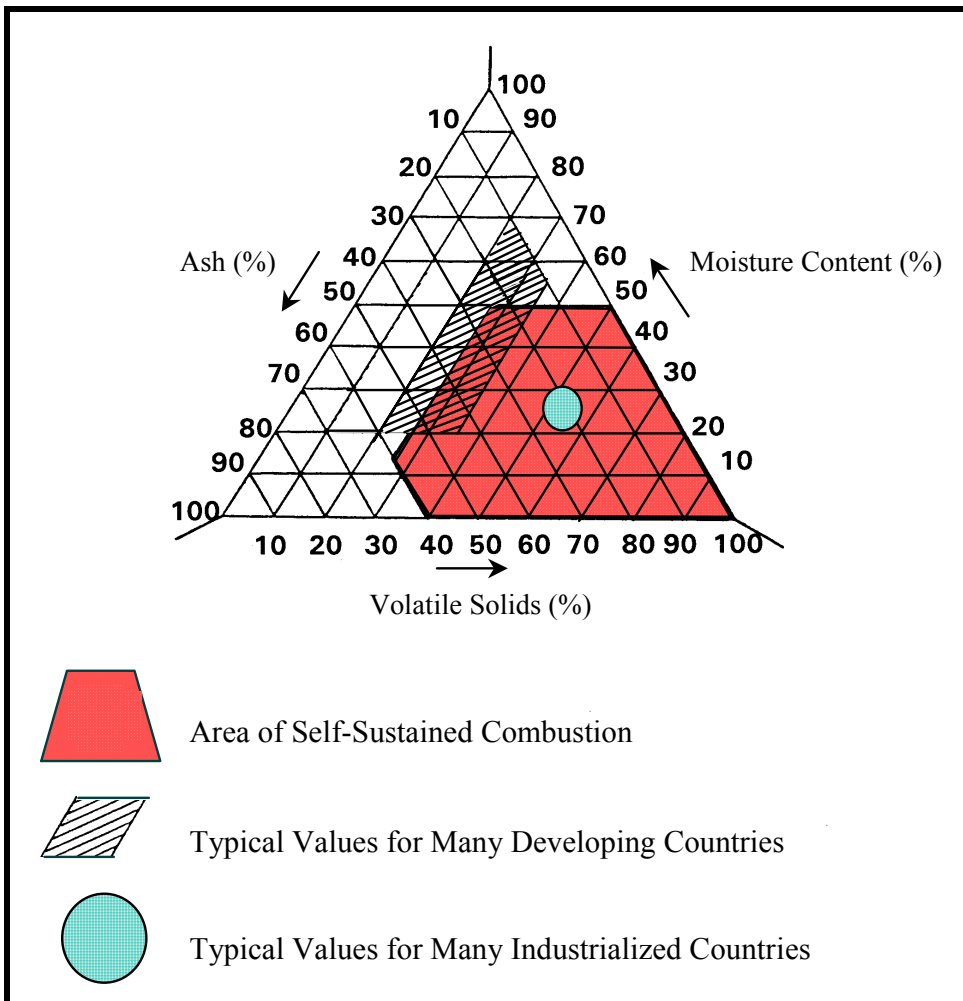

Figure X-2. Comparison of the thermal characteristics of MSW and those required for self-sustained combustion

B3. REFUSE-DERIVED fuel production

The production of refuse-derived fuel (RDF) typically involves the use of a number of operations -- among the more common operations are size reduction, screening, and magnetic separation. Manual operations (e.g., sorting of materials) are also used, especially if material recovery and RDF recovery are integrated into one processing facility. Manual processes of separation are especially appropriate in many cases in developing countries, singularly or in combination with mechanical processing operations. As mentioned earlier, for recovery of RDF, the key aspect of processing is separation of the combustibles from the non-combustibles in the waste. Refuse-derived fuels can serve as feedstocks for incineration systems with energy recovery equipment.

C. Thermal gasification and biogasification

“Gasification”, as used in solid waste management, is a term applied to the conversion of wastes into a gaseous fuel. The term is used even though not all of the recovered energy is in the form of a combustible gas. Indeed, with certain processes, the fraction in the form of a combustible gas may be much less than that in a solid or a liquid form, or in both. Because, as is explained in later chapters, gasification can be a complex and expensive undertaking, recourse to it for energy recovery should be considered only in certain special circumstances. For example, there might be a local need for an organic gas as a chemical feedstock or a gaseous fuel to supply a gas-fired industrial process. Such circumstances preclude the presence of an economical supply of fossil (“natural”) gas.

Gasification may be accomplished by biological and non-biological processes. Biological gasification involves the collective activities of groups of facultative and obligate anaerobes in the conversion of 30% to 40% of the energy bound in the biodegradable fraction of wastes into the chemical energy of methane. The process by which the transformation is accomplished is a well known one, and usually is referred to as “anaerobic digestion”, although the terms “methane fermentation” and “biogasification” may be used synonymously. Generally, “biogasification”, as used in the literature, has a rather generic connotation, whereas “anaerobic digestion” is regarded as implying the usage of specialised equipment (reactors) and the adherence to a well defined operational procedure. Inasmuch as biogasification takes place in nature where and whenever conditions are appropriate, it is not surprising that it takes place in a landfill. This latter phenomenon, while widely known for many years, has only recently been put into extensive beneficial use, i.e., landfill gas recovery and utilisation.

Non-biological gasification processes are thermal (or thermal-chemical) in nature. Through them, both non-biodegradable and biodegradable combustible matter can be transformed. Because of this attribute, the percentage of energy recovery from non-biological gasification processes potentially can surpass that from biological systems. Non-biological gasification, or as it is more commonly termed, “pyrolysis”, essentially is the fractional distillation of the organic matter in a waste under O₂-free, or partially O₂-free, conditions. The end products are gases, liquids (oils and tars), and solids (char). The extent of the gasification in terms of percentage of the end products in the gaseous form is primarily a function of elevation of temperature and, to some degree, of pressure. If a high yield of combustible gas is the objective of the process, then steps must be taken to elevate the temperature at some point in the process since the temperature of “strict” pyrolysis reactions results in low gas yields. One such step is to combust a portion of the gas stream by admitting a small amount of O₂ into the process, such that the overall process is a two-step one -- namely, strict pyrolysis followed by limited combustion. This has led to the development of the “pyrolysis-combustion” type of process. Occasionally, the term “gasification”, or more specifically “thermal gasification”, is restricted to pyrolysis-combustion, while “pyrolysis” is used solely for pyrolysis in the strict sense of the term.

Biogasification, production of refuse-derived fuel, and thermal (i.e., non-biological) methods of conversion are discussed in more detail in later chapters of the book.

D. References

1. Nath, K.J., “Solid Waste Management in the Present Indian Perspective”, proceedings of ISWA 1993 Annual Conference, Jönköping, Sweden, September 1993.
2. Diaz, L.F. and C.G. Golueke, “Solid Waste Management in Developing Countries”, *BioCycle*, 26:46-52, September 1985.
3. Japan International Cooperation Agency, *Master Plan and Feasibility Study on Seoul Municipal Solid Waste Management System*, Tokyo, Japan, 1985.
4. Scharff, C. and G. Vogel, “A Comparison of Collection Systems in European Cities”, *Waste Management & Research*, 12(5), October 1994.
5. CalRecovery, Inc., *Criterio de Diseño - Planta de Selección y Recuperación de Subproductos de los Residuos Sólidos Municipales*, prepared for Mexico City, Mexico, December 1992.

6. CalRecovery, Inc., *Handbook of Solid Waste Properties*, Governmental Advisory Associates, Inc., New York, New York, USA, 1993.
7. Morwood, R., “Australian Waste Management - Towards 2000”, *Proceedings of 32nd Annual International Solid Waste Exposition*, SWANA, San Antonio, Texas, USA, August 1994.

CHAPTER XI. BIOGASIFICATION

A. Introduction

The possibility of biologically recovering energy in the form of the combustible gas, methane, has prompted an interest in applying biogasification to waste treatment in developed and developing countries alike. The attraction to the concept arises from the fact that biogasification of solid waste serves a twofold function -- namely, waste treatment and energy production. If viewed solely as a solid waste treatment method, biogasification probably does not rank with composting in terms of technical and economic practicality and feasibility in most economically developing countries. Biogasification plant design and operation are more expensive and allow much less latitude of scale and level of technology than composting. Equipment needs are more rigorous, and maintenance and processing demand a higher level of personnel competence. However, biogasification is more practical than composting for treating readily degradable wastes (such as some food wastes), nightsoil, and body wastes. Moreover, it can be very practical when used in conjunction with sanitary landfilling.

In the 1970s and in much of the 1980s, the hope of realising the great potential attributed to biogasification led to a proliferation of a variety of biogasification schemes, particularly in economically developing countries for the treatment of nightsoil and animal manures. The schemes were designed to carry out the process with a minimum of, or even without, sophisticated equipment. Moreover, they called for native raw materials to be used for constructing the digesters and gas collectors. Inevitably, only a very few of the proposed schemes proved to be sufficiently realistic to have survived. The surviving systems are those that adhere to realism and to principles of biology and good engineering.

During the mid-1990s and continuing as of this writing, substantial research, development, and commercialisation of solid waste biogasification systems has occurred in Europe in response to the promulgation of the Landfill Directive by the European Union [25]. In brief, the Directive specifies the maximum biodegradable content of wastes that are destined for land disposal, and aggressive material recycling goals. Also, in response to the Directive, the designers and system suppliers are integrating waste pre-processing, biogasification, and composting technologies in order to simultaneously decrease the organic content and quantities of waste requiring land disposal.

A presentation dealing with biogasification systems that are biologically and economically sound and realistic is made in this chapter. Thus, basic principles of biogasification are the first subjects to be covered. Specifically, basic principles that receive attention are biogasification biology and related construction design, and pertinent design and operation factors. The chapter is concluded with a discussion of the advantages and disadvantages of the biogasification option and an evaluation of its present status.

B. Principles

B1. DEFINITIONS

Among the terms frequently used as synonyms for biogasification are “methane fermentation”, “methane production”, and “anaerobic digestion”. All are suitable, despite the fact that they also are applied to processes that may have no bearing on methane production. Gases generated in the alternative processes usually include only carbon dioxide and occasionally a trace gas. (It should be noted that in microbiology taxonomy, “methane fermentation” refers to the fermentation, i.e.,

the decomposition of methane.) Anaerobic digestion is not necessarily attended by methane production. Nevertheless, the three terms are justified by common usage, and especially for want of a better term. In this chapter, the three terms are used interchangeably.

As popularly accepted and for the purposes of this book, biogasification is defined as being the biological decomposition of organic matter of biological origin under anaerobic conditions with an accompanying production primarily of methane (CH₄) and secondarily of other gases, chief of which is carbon dioxide (CO₂). The two features that distinguish the process as defined from other forms of biological decomposition are “under anaerobic conditions” and “the production of methane”.

C. Process description

A feature that has a major influence on the application of biogasification in waste treatment is the fact that, conventionally, the process takes place in more or less distinct stages or phases. The stages are distinct in that they can be separated from each other with respect to reactions, reaction products, and microflora. Generally, it is held that the number of stages is two -- namely, acid stage followed by a methane forming stage. However, some researchers hold that three stages are involved when the substrate is a waste [9]. In that view, the two conventional steps are preceded by a “polymer breakdown” step when a waste is the substrate.

A division of the process into three stages probably more accurately reflects the microbiology of the overall process than does the two-stage division. However, consideration of biogasification as a two-stage process makes for simplicity of description and reference, and is the one commonly used in the technical literature. Moreover, the two-stage division is justified if one thinks of the process in terms of pre-methane activity and of methane forming activity. The traditional division into two phases is more readily apparent in practice than a three-phase division would be.

The process is sequential in that the acid stage precedes the methane forming stage regardless of whether the culture (i.e., digester) is operated on a batch or a continuous basis. In a continuous type of operation, all stages may be encountered at any time. This is true because all input must pass through the sequence. Therefore, if the operation is on a continuous basis, all stages would be represented at any point in time, and newly introduced material would be going through the acid stage; whereas, simultaneously, material previously introduced may already be in the methane-forming stage.

Assuming the three-stage division, the entire process begins with the polymer stage. In the polymer stage, organic wastes are acted upon by a group of facultative microorganisms that enzymatically hydrolyse the polymers of the raw waste into soluble monomers. The monomers (short-chain organic acids, acetic acid, etc.) become the substrate for the next stage (acid stage). Some carbon dioxide also is formed. The organic acids form the substrate for the bacteria active in the final methane-production stage. In this stage, the methane producers (methanogens) break down the organic acids into, primarily, methane. Methanogens are strict anaerobes, and as such do not tolerate free oxygen, i.e., atmospheric oxygen (O₂). Methanogens produce methane in two ways: 1) they can ferment an organic acid (e.g., acetic acid) to methane and carbon dioxide; and 2) they can reduce carbon dioxide to methane through the use of hydrogen or formate produced by other bacteria. The interrelationship of the three steps is diagrammed in Figure XI-1.

The overall process rests upon the maintenance of a relatively critical balance between the respective activities of the three stages. An imbalance reduces the efficiency of the overall process and may lead to the complete cessation of all microbial activity and, hence, no methane production would occur.

Immediately after its initiation, the sequence of readily observable reactions in a continuous culture is a gradual decline in pH level (the acid stage), followed by a similarly gradual rise in pH level, and eventually by the production of a gas rich in methane (the methane production stage).

The end products of the final stage are methane, carbon dioxide, trace gases, and a satisfactorily stable residue.

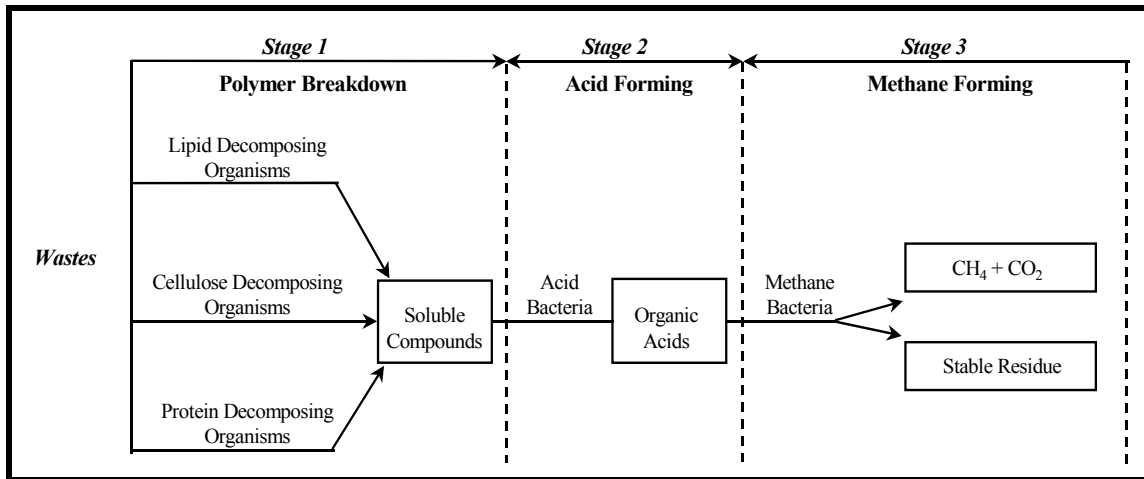

Figure XI-1. Relationship of three stages in biogasification

C1. MICROBIAL ecology of the stages

Over the past four or five decades and continuing today, many competent scientists have thoroughly investigated the bacteriology of methane production. The investigations have mainly been focused on the isolation, identification, and population size of the methane producers.

Some research has been conducted on identifying and quantifying the representative species of the microflora involved in the biogasification of sewage sludge, organic municipal solid waste, and some agricultural residues [15-20]. The acidogenic population, consisting of about 90% of the total digester population, is the largest of all the groups [21]. However, relatively little is known about the number and physiological activities of the acidogenic microorganisms [22].

Although constituent population sizes may be modest, the variety of the microorganisms that make up the microflora of biogasification is relatively extensive. The bacterial populations involved in the polymer stage are primarily those that have enzymatic systems capable of hydrolysing the complex molecules of the intact waste particles. Molecules to be hydrolysed are mainly those of carbohydrates. Others, in lesser amounts, are those of lipids and proteins.

The carbohydrates are represented chiefly by cellulose and other components of plant fibre, such as lignin and hemicellulose. The presence of cellulolytic enzymes is particularly important because the greater fraction of municipal wastes and many agricultural wastes is cellulosic.

Generally, biogasification proceeds more rapidly with a mixed collection of hydrolytic microbes than with a single (pure) culture. The faster pace is partly due to the synergistic action resulting from the interaction of several types of microbes. A likely outcome of the synergism is the destruction of potentially inhibitory byproducts.

C1.1. Acid stage

The role of acid forming bacteria is to convert polymer stage breakdown products into organic acids (straight-chain fatty acids) that can be utilised by methane-formers. Among the acids

formed in the stage, acetic acid is the most abundant. Among the lesser abundant are formic, propionic, valeric, butyric, and trace amounts of other acids. Characteristically, the acid-formers grow vigorously and tolerate a wide variety of environmental conditions. Because of the vigorous growth and wide tolerance, the acid stage rarely is the rate-limiting factor in biogasification. However, conditions can and do arise under which the intensity of the acid stage can inhibit biogasification. Such conditions develop when the activity of the acid-formers is not counterbalanced by the utilisation of the acids by methanogens, and to some extent by other organisms. In the absence of such utilisation, acid buildup occurs to such an extent that the pH of the culture drops to an inhibitory level. The tolerance exhibited by the acid stage to environmental conditions probably arises from the diversity of its microbial composition. Consequently, slow growth seldom is a problem of the acid stage.

C1.2. Methane stage

In the methane stage, decomposition products from the acid stage (short-chain fatty acids, CO₂, and H₂) are converted into CO₂, CH₄, and an assortment of trace gases. Methane producing bacteria (methanogens) accomplish the transformation by way of two types of reactions: 1) fermentation of short-chain fatty acids and some alcohols; and 2) a respiration in which H₂, CO₂, and certain simple organic compounds are oxidised anaerobically, coupled with the reduction of CO₂ to CH₄. The following two reactions typify the fermentation reactions in the conversion of the acids and alcohols.

Acetic acid:



Methyl alcohol:



The production of CH₄ through respiration involving the incomplete oxidation of alcohol to acetic acid, coupled with the reduction of CO₂ to CH₄, can be exemplified by the reaction by *Methanobacterium omelianski*. The reaction is as follows:

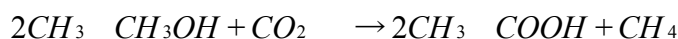

The reduction of CO₂ with molecular hydrogen is:

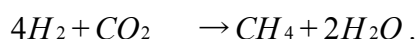

Unlike the acid-formers, the methanogens grow slowly and show very little latitude regarding nutritional and environmental requirements. In terms of nutrition, they are restricted to simple organic compounds. Therefore, in the biogasification of wastes, they must rely upon the polymer and acid stages to meet their carbon and acid needs. Moreover, they must depend upon the nitrogen in the ammonia produced by the breakdown of organic nitrogen compounds.

A distinctive and very practical characteristic of the methane stage is a relatively intensive sensitivity to certain environmental factors. Chief among these factors is atmospheric oxygen. Methanogens are obligate anaerobes and, hence, atmospheric oxygen becomes inhibitory to them even at exceedingly low concentrations. This sensitivity extends to some degree with respect to highly oxidised compounds. Thus, nitrites and nitrates can inhibit the growth of the methanogens.

Unlike methanogens, most acid-formers are facultative anaerobes, i.e., O₂ is not inhibitory to their growth.

Another restrictive factor is pH level. Whereas for the acid stage, the tolerated pH range is as wide as pH 4.5 or 5.0, to 7.5 or even 8.0, the permissible range for the methane stage is only pH 6.0 to 7.5. The optimum level is pH 7.0.

D. Process rate limitation factors

Potential limitations imposed by each of the three stages on the rate of the biogasification (digestion) process as a whole have practical effects on equipment design and specifications, and on operation. The rate limitation imposed by the polymer stage originates in its role of rendering essential nutrients bound in the raw feedstock (waste) available to bacteria involved in the second and third stages of the biogasification process. The stage is rate limiting because it is needed for solubilizing insoluble cellulose and complex organic nitrogenous compounds. The cellulose is converted into soluble carbohydrates by way of extra cellulases. As stated earlier, acid-forming bacteria convert the soluble carbohydrates to low molecular weight fatty acids in the second stage. The third stage is the final rate determinant. In fact, it often is regarded as the rate-limiting stage for the process as a whole, because it is the final step and because the methanogens are basically slow growing. In the third stage, acids and certain other intermediate decomposition products are converted into CH₄ and CO₂.

D1. ENVIRONMENTAL factors

Key environmental factors (i.e., those that relate to culture and growth conditions) are oxidation-reduction level, hydrogen ion concentration (pH), temperature, and substrate. The importance of having a low oxidation-reduction level and a restricted pH range was discussed previously. Hence, the focus of the paragraphs that follow is on temperature and substrate.

D1.1. Temperature

A direct relation exists between extent and intensity of microbial activity and temperature level within a temperature range tolerated by the organisms. Each range characteristically has a minimum level below which no activity occurs and a maximum level above which all activity ceases and the microbes do not survive. Within the survival range, activity and growth increases with rise in temperature until an optimum level is reached, and decreases after the optimum level is reached. In the biogasification process, this influence is manifested by changes in rate and volume of gas production, and rate and amount of volatile solids destroyed.

In practice, temperature ranges have been grouped into two broad classes or types -- namely, mesophilic and thermophilic. Correspondingly, the microorganisms that have mesophilic ranges are termed mesophiles; those having a thermophilic range are termed thermophiles. The mesophilic range begins at about 10° to 15°C, peaks or plateaus at about 35° to 38°C, and ends at about 45°C. The thermophilic range begins at 45° to 50°C, peaks at 50° to 55°C, and ends at 70° to 75°C.

Some types of microorganisms can survive and perhaps thrive under both temperature regimens. Mesophilic microorganisms that can tolerate thermophilic conditions are termed facultative thermophiles; equally tolerant thermophiles are termed facultative mesophiles. Microorganisms lacking such tolerance are designated obligate mesophiles or thermophiles, as the case may be. A mesophilic culture can be adapted to thermophilic conditions. However, as will be explained later, there is considerable reason for attributing the so-called adaptation to enrichment. Consequently, to operate a digester under thermophilic conditions, either an existing culture of

thermophiles must be used, or one must be developed. Development, whether it be adaptation or enrichment, is a slow process. Most likely, successful development will be the result of a chance occurrence of a “wild” strain of thermophiles in the “starting culture”.

D1.1.1. Developing a thermophilic culture

Two of the procedures or methods for developing a thermophilic digester culture are discussed.

D1.1.1.1. First method

A digester culture is set up and its temperature is adjusted to 35°C. Within a 30-day period thereafter, the temperature is elevated gradually until the culture temperature reaches 50° to 55°C.

D1.1.1.2. Second method

Directly after it has been set up, the temperature of the culture is elevated to the thermophilic level (50° to 55°C). The immediate response of the culture is an apparent cessation of all activity and growth such that the culture seemingly has been “killed”. Nevertheless, if the culture is not disturbed and the temperature is maintained at 50° to 55°C, eventually it will exhibit indications of activity, and in time will have become fully adapted to thermophilic conditions. In effect, the culture was transformed into an enrichment culture for thermophiles.

D1.1.2. Thermophilic vs. mesophilic - decision factors

Generally, thermophilic cultures are more sensitive than are mesophilic cultures. For example, a thermophilic culture does not thrive under mesophilic conditions. Their sensitivity is an important decision factor because restoring a failed thermophilic culture or replacing it with a new culture is a time-consuming process. The situation is far less serious when a mesophilic culture fails (e.g., unplanned exposure to thermophilic temperatures). Development of a replacement culture can be accomplished in a much shorter time.

It is very likely that gain, if any, in pathogen destruction, gas production, and in rate and extent of volatile solids destruction and resultant shortening of detention period in a thermophilic system would be offset by the added expenditure of energy that would necessarily be involved. In short, the cost-benefit ratio would surpass that for a mesophilic system.

D1.2. Substrate

In this book, “substrate”, “feedstock”, and “digester input” are used interchangeably.

As is true with most biotreatment systems, the waste to be treated serves as the substrate and feedstock for the microbial populations that are active in the biological phases of the treatment. The suitability of a waste as a substrate depends upon three characteristics -- namely, physical properties, chemical composition, and biodegradability. Actually, biodegradability is determined in large part by the physical properties and chemical composition of a waste. With respect to chemical composition, possession of nutrient (fertiliser) elements and molecular structure of the compounds that contain them are the pertinent characteristics.

D1.2.1. Physical properties

An advantageous feature of physical properties in general is relative ease of changing or adjusting them to improve their utility as a feedstock. Two such properties are particle size and moisture content.

D1.2.1.1. Particle size

The influence of particle size is the relation of particle size to the ratio of mass-to-surface area -- the smaller the particle size, the greater is the ratio. The influence of the ratio is primarily by way of its bearing on ease and degree of accessibility by active microbes to nutrient elements in the waste mass. Secondary effects are breaching of barriers in the form of “protective” coatings (e.g., waxes, lignaceous sheathes), exposure to moisture and gases, and potentially inhibitory metabolic products. Inasmuch as extent of accessibility is a function of particle surface area exposed to microbial action, the greater the ratio of particle surface area to mass, the more intensive becomes the microbial activity and, hence, the rate of decomposition is accelerated.

The bearing of the magnitude of the surface area-to-mass ratio varies according to the type and nature of wastes. Thus, with municipal organic waste and fibrous agricultural wastes, digestibility increases with increase in size of the ratio. The ratio is not so critical where highly putrescible wastes are concerned (i.e., particle size can be larger). Examples of such wastes are food wastes, yard wastes, and some market wastes. Unless they contain bedding, cattle and poultry manure may be fed directly into a digester without having been size reduced.

D1.2.1.2. Moisture content

The appropriate and permissible moisture content depends upon the type of biogasification system intended and designed. Within the past three decades, two broad classes of municipal waste digestion systems based on moisture content have come into vogue -- namely, conventional (“low solids”, “slurry”) and “high solids”. Chronologically, the conventional form is the original form; whereas the high solids form did not reach significant acceptance until the 1980s. Both high- and low-solids digestion systems are being extensively researched and implemented in Europe as of this writing [26].

Experience indicates that for conventional (low solids) systems, a solids content of 5% to 10% (i.e., moisture content, 90% to 95%) is appropriate for the digester culture and feed. In conventional systems, too high of a solids content leads to inadequate mixing, with the objectionable consequences to be described later. Too low of a solids content necessitates a larger than necessary digester volume. Because of the expense involved, digester size can be the deciding factor for economic feasibility.

D1.2.1.3. Chemical composition

With regard to chemical composition of substrate and feed, elemental composition and the structure of the molecules that contain essential elements are main considerations. Essential nutrient and metabolic elements are conventionally arranged into two groups -- namely, “macronutrients” and “micronutrients”. However, this arrangement neglects essential elements that do not fit within these two groups; among them are calcium and magnesium. The micronutrients (“trace elements”) include sodium, cobalt, manganese, and a number of other metallic elements. Most wastes contain the full array of essential trace elements.

Macronutrients include nitrogen, phosphorus, and potassium (“NPK”). Not only are these elements essential, they must also be present in an appropriate ratio, i.e., a certain balance must exist between the three elements. An appropriate carbon-to-nitrogen ratio (C:N) is a requisite for the continued successful functioning of a digester. An excessively high C:N promotes acid formation and accumulation. The accumulation retards methanogen activity and, hence, methane production ceases. On the other hand, when the C:N is too low, nitrogen is converted to ammonium-N at a faster rate than can be assimilated by the methanogens. As a consequence, ammonia reaches concentrations that are toxic to the microbes.

The physical and chemical natures of the waste are among the more important factors that determine the level at which C:N is optimum; hence, the range above and below which it is inhibitory. For readily degradable substrates, the optimum C:N is on the order of 20:1 to 25:1. However, for materials that are resistant to microbial attack, the C:N can be as high as 35:1, or even 40:1. Common examples of resistant, i.e., refractory, wastes are wood and other lignaceous wastes, rice hulls, and straw. Because it breaks down extremely slowly, wood is not amenable to conventional low-solids digestion. However, its digestibility can be increased somewhat by way of pre-treatment involving exposure to heat, pressure, and acid or alkali.

Nutrient deficiencies in the waste are remedied either by adding a waste that contains the missing nutrients, or by enriching the deficient substrate with appropriate chemical fertiliser elements. The monetary costs of chemical fertiliser elements usually discourage their use in a developing country. The nitrogen content and carbon-to-nitrogen ratios of several wastes are presented in Table XI-1.

In Table XI-2 are listed chemical and other characteristics of some representative wastes. A comparison of the ratio of water-soluble constituents with combined lignin-cellulose contents can serve as a means of gauging the degradability of the listed wastes. The higher the ratio, the greater is the degree of degradability.

Because of a tendency to float, wood, straw, rice hulls, and other wastes of low density do not constitute suitable materials for low-solids digestion systems. The unsuitability is due to the propensity of low-density wastes to intensify scum formation. Consequently, it becomes necessary to control the more or less thick surface layer of scum that characterises conventional anaerobic digestion.

Table XI-1. Nitrogen content and C:N of typical wastes

Material	Total-N (% dry wt)	C:N
Animal Wastes		
Urine	15 to 18	0.8
Blood	10 to 14	3
Fish scraps	6.5 to 10	5.1
Mixed slaughterhouse wastes	7 to 10	2
Poultry manure	6.3	--
Sheep manure	3.8	--
Pig manure	3.8	--
Horse manure	2.3	25
Cow manure	1.7	18
Farmyard manure (average)	2.15	14
Nightsoil	5.5 to 6.5	6 to 10
Plant Wastes		
Young grass clippings (hay)	4.0	12
Grass clippings (average mixed)	2.4	19
Purslane	4.5	8
Amaranthus	3.6	11
Cocksfoot	2.6	19
Lucerne	2.4 to 3.0	16 to 20
Seaweed	1.9	19
Cut straw	1.1	48
Flax waste (phormium)	1.0	58
Wheat straw	0.3	128
Rotted sawdust	0.25	208
Raw sawdust	0.1	511
Household Wastes		
Raw garbage	2.2	25
Bread	2.1	--
Potato tops	1.5	25
Paper	nil	--
Refuse	0.8 to 2.0	25 to 60

Sources: References 4, 5.

**Table XI-2. Chemical composition of major crop and forest wastes
(% of air-dry material)**

Constituent	Mature Wheat Straw	Soybean Tops	Alfalfa Tops	Young Cornstalks	More Mature Cornstalks	Young Pine Needles	Old Pine Needles	Mature Oak Leaves
Fats and waxes	1.10	3.80	10.41	3.42	5.94	7.65	23.92	4.01
Water-soluble constituents	5.57	22.09	17.24	28.27	14.14	13.02	7.29	15.32
Hemicelluloses	26.35	11.08	13.14	20.38	21.91	14.68	18.98	15.60
Cellulose	39.10	28.53	23.65	23.05	28.67	18.26	16.43	17.18
Lignin	21.60	13.84	8.95	9.68	9.46	27.63 ^a	22.68 ^a	29.66 ^a
Protein	2.10	11.04	12.81	2.61	2.44	8.53	2.19	3.47
Ash	3.53	9.14	10.30	7.40	7.54	3.08	2.51	4.68

^a The high lignin content is partially an artefact due to the analytical procedure used in its determining.

D2. PERFORMANCE factors

The factors of principal interest are those that are related in some way to the substrate, and which either stimulate or inhibit digester performance. These factors usually are in the form of substances either present in or added to the substrate.

D2.1. Transfer of metabolic products

The rate of transfer of dissolved metabolic and other products from the liquid to the gaseous phase can be a limiting factor due to the need to remove these products from the vicinity of individual cells. Inhibition arising from an inadequate transfer from the liquid to the gaseous phase may occur when the bacteria individually are completely surrounded by a wall of bubbles, as would occur at a very high substrate concentration. The envelope of bubbles interferes with diffusion of substrate into intercellular spaces. A solution to the problem is to vigorously agitate the culture, as for example, by thoroughly mixing on a continuous basis.

D3. FACTORS in the form of elements or compounds

Certain substances, either inherently or in combination with another substance, adversely affect the growth and activities of microorganisms involved in biogasification. The effect ranges from mild inhibition to destruction. The extent of inhibition depends upon the concentration of the toxic substance. Some substances become lethal at very low concentrations; whereas others become inhibitory only after a critical concentration has been passed. Paradoxically, the essential trace elements are of the first type.

When the concentration of inhibitory substances is lower than critical, inhibition may or may not be immediately apparent during the polymer and acid-forming stages. On the other hand, inhibition is almost immediately apparent during the methane stage, and is manifested by a drop in methane production. Methanogens are particularly sensitive to ammonia and ammonium ions, soluble sulphides, and soluble heavy metal salts (e.g., copper, cadmium, nickel). For example, soluble sulphides are toxic at concentrations beginning at 50 to 100 mg/L. Soluble metals salts become toxic when concentrations exceed a few ppm.

Ammonia and ammonium-ion toxicity depends upon pH level. Thus, when the pH level is higher than 7.4, ammonia is toxic at concentrations greater than 1,500 to 3,000 mg/L of total ammonia-N. On the other hand, the ammonium ion is toxic at any pH level when its concentration is greater than 3,000 mg/L of total ammonium-N. The influence of pH is largely due to its effect on the equilibrium that exists between dissolved ammonia gas and ammonium ions. The equilibrium shifts towards the ammonium ion at low pH levels, and inhibition begins at 3,000 mg/L. Conversely, the shift is toward ammonia gas at the higher pH levels, and inhibition may begin at 1,500 mg/L. The potential inhibitory effects of the ammonium ion at high concentrations do not nullify its utility nor its role as a key source of nitrogen.

The salts of alkaline-earth metals (sodium (Na), potassium (K), calcium (Ca), magnesium (Mg)) are stimulatory at concentrations below a critical level and inhibitory at concentrations above that level. The concentrations are determined by the cation portion of the salt. Sodium is stimulatory at 100 to 200 mg/L; K, at 200 to 400 mg/L; Ca, at 100 to 200 mg/L; and Mg, at 75 to 150 mg/L. The critical level for Na is about 3,500 mg/L; for K and Ca, about 2,500 mg/L; and for Mg, about 1,000 mg/L. In other words, these are the concentrations at which the named elements become inhibitory.

These and any other elements can exert their stimulatory and inhibitory influences only when they are in solution. Harmful and inhibitory effects can be avoided by rendering the compounds insoluble. Thus, an inhibitive concentration of dissolved sulphide can be reduced or eliminated by adjusting the pH level such that the compound becomes insoluble and is precipitated. An alternative recourse would be to add a heavy metal to act as a precipitant. A disadvantage of the latter approach is an increase in the heavy metal content of the sludge and, thereby, a magnification of the constraints on its disposal or utilisation. Incidentally, a soluble sulphide can serve as an antidote for heavy metal poisoning of a digester culture. The antidotal effect is the result of the formation of an insoluble heavy metal/sulphide complex. A disadvantage of such an approach is an increase in the heavy metal content of the sludge and, hence, a lowering of its agricultural utility.

Although this section deals primarily with the low-solids type of digester, the basic principles discussed are applicable both to low-solids and high-solids digesters.

E. Parameters

Regardless of type of digestion (i.e., low vs. high solids), parameters fall into two broad groups -- namely, those pertinent to the cultural environment that affects digester performance and those used for judging digester performance. Values assigned to environmental parameters are based on those environmental conditions that promote optimum digester performance and, conversely, those that lead to destruction of the culture and, thus, to "zero" digester performance. Examples of types of environmental parameters are hydrogen ion level and alkalinity. The principal parameters on which digester performance is judged are gas production and composition, rate and extent of volatile solids destruction, volatile acid content, pH level, and buffering capacity.

A range of values for key environmental and performance parameters has been developed for sewage sludge digestion. Unfortunately, because of chemical and physical structure differences, this range is not necessarily applicable to the digestion of other types of solids.

E1. GAS production and composition

Gas production ranks highest among the parameters commonly used to judge cultural performance and guide digester operation. It is a direct measure of overall microbial activity. In combination with the parameter, composition, it is a measure of the activities of the methanogens.

The combination of the two parameters is a measure of energy recovery efficiency and economic practicality.

Gas production usually is expressed in terms of volume of gas produced per unit of mass of total solids and of volatile solids introduced. Gas production per unit of total solids depends both on the volatile solids content of the total solids and on the extent to which the volatile (organic) solids are converted into gas. Gas production per unit of volatile solids may be expressed either as volume of gas produced per unit mass of volatile solids introduced or as volume of gas per unit mass of volatile solids destroyed. Gas production in terms of volatile solids introduced is a particularly useful parameter, because it is a measure of the efficiency of the utilisation of volatile (i.e., organic) solids by the culture.

Gas volume per unit of volatile matter depends both upon the detention period and other operational features, and upon the nature of the waste. For example, in one study, gas production amounted to 0.374 to 0.454 m³/kg of raw sewage solids introduced. Examples of gas production in the digestion of other types of wastes are listed in Tables XI-3 and XI-4. The yields listed in the two tables are in terms of volume of gas per unit mass of total solids introduced. It is highly likely that yields obtained with municipal wastes generated in a developing country would be roughly comparable to the yield obtained with raw sewage sludge in the United States.

Table XI-3. Biogas production from digestion of common wastes

Raw Material	Biogas/Unit Wt of Dry Solids (m³/kg)	Temperature (°C)	Methane Content of Gas (%)	Detention Time (days)
Cattle manure	0.20 to 0.33	11.1 to 31.1	--	--
Poultry manure	0.46 to 0.56	32.6 to 50.6	58 to 60	9 to 30
Swine manure	0.49 to 0.76	32.6 to 32.9	58 to 61	10 to 15
Sheep manure	0.37 to 0.61	--	64	20
Forage leaves	0.5	--	--	29
Sugarbeet leaves	0.5	--	--	11 to 20
Algae	0.32	45 to 50	55	11 to 20
Nightsoil	0.38	20 to 26	--	21
Municipal refuse (USA)	0.31 to 0.35	35 to 40	55 to 60	15 to 30

Sources: References 9, 23.

Table XI-4. Bovine, swine, poultry, and horse manure npk equivalents and potential methane yields

Animal	Waste Production (kg/day/animal)	Methane (m ³ /day/animal)	N P K		
			(kg/yr/animal)		
Bovine					
Beef	38	11.9	32	15	40
Dairy	52	15.8	64	29	79
Replacement	34	10.2	21	10	27
Swine					
Sows (136 kg)	14	5.1	15	8	5.4
Hogs (68 kg)	7.3	2.5	7.7	4.1	2.7
Weaners (27 kg)	3.6	1.4	4.1	1.8	1.4
Poultry (per 1,000)					
Broilers	28	7.4	64	27	23
Layers	118	31.1	499	403	222
Turkeys	134	34.2	245	195	109
Horses	17	4.8	45	17	35

Source: Reference 14.

The parameter for estimating the rate of gas from the digestion of a given waste should be based only on data obtained after the digester culture has reached steady-state conditions. Yields obtained before steady-state is reached or after it has passed are lower than the maximum potential yields. Thus, yield steadily progresses from almost zero at the start of the culture until it reaches the rate characteristic of steady-state. Conversely, after steady-state begins to deteriorate, yields correspondingly decline.

The great utility of gas production as a parameter is largely due to its ease of recognition. For example, an unexpected deviation from a prevailing rate of gas production is a symptom of culture malfunction. Nevertheless, some deviation is inevitable even during steady-state, inasmuch as almost every biological system is characterised by a daily fluctuation. However, the fluctuations are only slight and a given deviation is not persistent. The practical impossibility of maintaining all operational and environmental conditions at a constant level renders some deviation inevitable. Nevertheless, a consistent decline for longer than four or five days could be taken as an indication of trouble. A sudden, sharp decline in yield bespeaks imminent danger to the culture.

The use of gas production as a parameter depends not only upon the volume of gas produced, but also upon its composition. In waste treatment, the components of interest are carbon dioxide and methane. Methane is the more useful of the two and, hence, significant. Two factors determine the magnitude of the methane content -- namely, substrate and the methanogen population, i.e., the density and intensity of activity of the latter. With regard to the substrate, a predominance of carbohydrates usually results in a 1:1 ratio of methane to carbon dioxide. Accordingly, 50% of the gas produced is methane. Conversely, the use of a highly nitrogenous substrate (e.g., raw sewage sludge) may result in a gaseous product that is 65% methane.

The continuing increase in methane percentage that lasts until steady-state is reached is the reason why only steady-state gas composition data should be used as operational and performance parameters. As was stated earlier, the rate of the development of the methanogen population is slower than that of most of the other microorganisms involved in biogasification.

Consequently, the methane content of gas produced initially is negligible. Eventually, however, traces of methane begin to be detected. Provided that conditions remain appropriate, methane production increases until it levels off at steady-state.

E2. DESTRUCTION of volatile matter

Destruction of volatile matter is a performance and operational parameter because only the volatile (organic) fraction of a waste is biodegradable and, hence, is subject to anaerobic digestion. Therefore, rate and extent of destruction are measures of rate and extent of microbial conversion of organic solids into gas and stable or inert matter. Destruction can be as high as 60% to 70% with food preparation wastes and as low as 30% to 40% with newsprint as the principal carbon source.

Several factors exert a significant influence on the parameter, rate, and destruction of volatile matter. Among them are particle size distribution, degradability, temperature, and detention period. The four factors must be taken into consideration when evaluating changes in rate of destruction of volatile matter.

E3. VOLATILE acid content

Volatile acid concentration becomes a key parameter only when it is in a state of flux. A state of flux indicates an imbalance between proliferation and activities of acid formers and those of methanogens. The imbalance becomes a problem when the acid concentration is at a limiting, i.e., inhibitory, level. The occurrence of an inhibitory level is a function of a number of variables, including organic mass loading rate [27]. Limiting levels are those at which the accompanying pH level is inhibitory to methanogens. This relation between pH level and buffering capacity renders impractical any attempt to designate a particular total organic acid concentration as being inevitably lethal. The reason is that resulting pH changes are functions of the buffering capacity of the culture medium and adaptation of the microbial complex. Thus, it has been amply demonstrated that suitably adapted methanogens flourish at volatile acid concentrations of 10,000 mg/L. (Volatile acids concentration is expressed as mg/L acetic acid.) Chances are that they could be adapted to concentrations higher than that level. In contrast, with a poorly buffered culture, the inhibitory concentration could be as low as 200 or 300 mg/L. In summary, the significance of volatile acid concentration as a parameter depends upon the constancy of concentration rather than upon a specific concentration.

Constancy of volatile acid concentration can serve as an operational parameter, in that the presence of an inhibitory condition is manifested by a gain in the amount of volatile acids. The gain would be the result of the resistance of the acid-formers to unfavourable conditions being superior to that of the methanogens. Any progressive gain in acid concentration after steady-state has been reached is an indication of impending difficulty, even though concentration may be as low as 200 mg/L.

E4. HYDROGEN ion concentration

The pH range tolerated by methanogens is very narrow -- namely, 6.0 to 7.5. Hydrogen ion concentration could be regarded as an operational parameter because it is a manifestation of volatile acid formation. However, its utility as a parameter is lessened because the pH level also depends upon the buffering capacity of the culture. For example, the culture could be well on the way to complete inhibition before a substantial change could be noted in the pH level. The utility of the parameter depends to a large extent upon the immediacy with which it responds to significant changes in the overall conditions of the culture.

E5. BUFFERING capacity

In practice, alkalinity is a measure of the buffering capacity of the culture medium within the neutral pH range. Thus, the capacity of the medium to accept protons is its alkalinity. The alkalinity of the medium is a function of its bicarbonate, carbonate, and hydroxide components [1]. Of the three components, bicarbonate is the most important; the reason is that it is responsible for the neutral buffering capacity.

A failing of the routine analysis currently practiced is that it does not provide all of the information essential for satisfactory digester performance, because it determines alkalinity only to pH 4.0. Therefore, it accounts for only about 80% of the acetate alkalinity and pertinent bicarbonate alkalinity. (Bicarbonate alkalinity is total alkalinity minus acetic alkalinity.) The buffering range of acetate is effective only from pH 3.75 to pH 5.75. Moreover, this range is much lower than that tolerated by the methanogens. The bicarbonate alkalinity required to maintain pH level at 7.0 depends upon the carbon dioxide content of the digester gas. For example, with the CO₂ of the gas at 25%, the required bicarbonate alkalinity would be on the order of 2,000 mg/L. The needed alkalinity would be 4,000 mg/L, if the carbon dioxide concentration were from 50% to 53%. Generally, satisfactory performance is obtained within the broad range of 1,500 to 5,000 mg/L as acetic acid.

E6. REMEDIAL measures

Appropriate remedial measures must be taken when parameter values indicate the approach or actual existence of an inhibitory situation and, thereby, a likely deterioration in digester performance. The causes should determine the remedial measures. Thus, simply adding lime or buffer to raise an unfavourably low pH may raise the pH level, but it does nothing to alleviate the problem responsible for the pH drop. Moreover, in low-solids digestion, the lime may become a cement-like precipitate upon the bottom of the digester unless precautions are taken.

Although ammonia would effectively raise the pH, its use is attended by a danger to the culture because ammonia becomes toxic to the culture microorganisms even at very low concentrations. Cost and uncertain availability at the concentrations needed militate against the use of sodium bicarbonate to enhance the bicarbonate concentration.

As soon as digester malfunction becomes apparent, "feeding" should be discontinued because continued feeding most likely would magnify the problem. Unfortunately, no clear-cut, reliable remedy is available at present. Feasibility permitting, the best recourse is to dispose of the digester contents and then develop a new culture. Except for a very small operation, such recourse is not feasible because of the severe and rigid constraints placed by regulatory agencies on the dumping of incompletely treated material on the environment. The constraints are justifiable because of the unfavourable impact of the material on the quality of the environment.

F. Operational procedures

F1. MIXING

The usual rationale for mixing is that it enhances digestion efficiency regardless of type of digestion system. In high-solids digestion and in low-solids digestion, mixing serves several important functions. Two such functions are the removal of metabolic waste products accumulated in the culture's interstitial voids and simultaneous replacement with additional nutrients. Additionally, mixing is a critical feature in the digestion of some types of substrates, e.g., fibrous materials. With respect to low-solids digestion, rate and frequency of mixing or

agitation of the digester contents distinguishes conventional systems from high-rate digestion systems. The two systems are diagrammed in Figures XI-2 and XI-3.

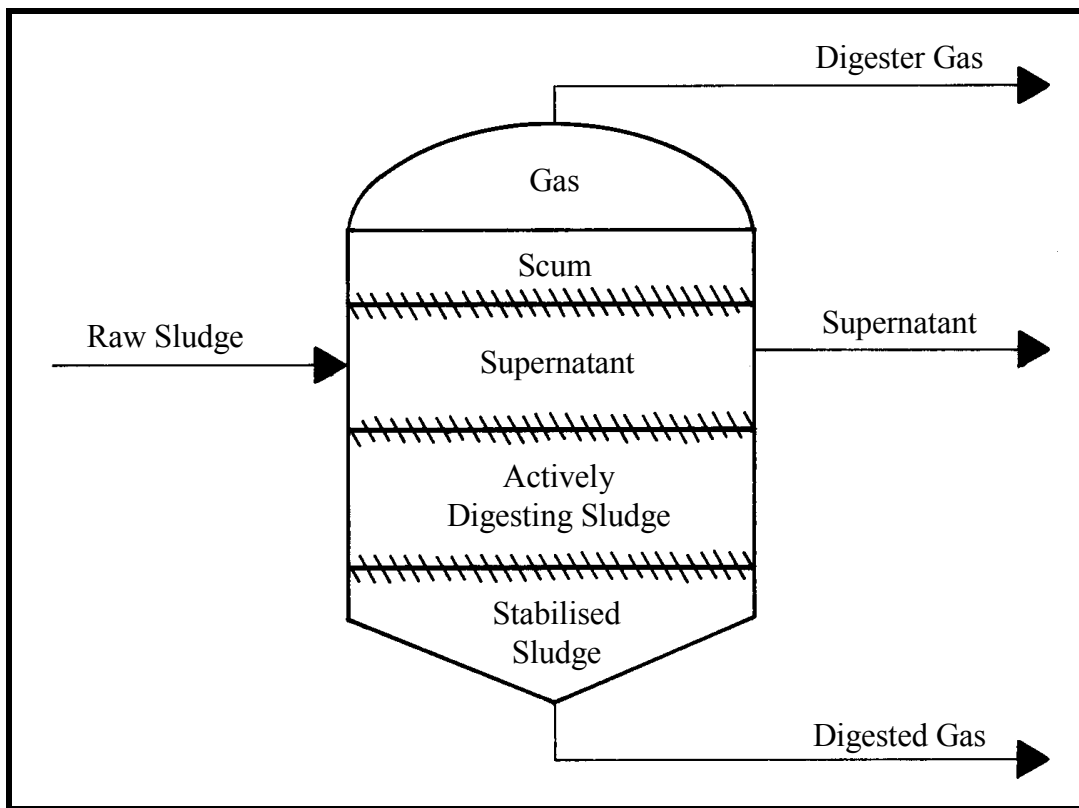

Figure XI-2. Conventional digestion (low solids)

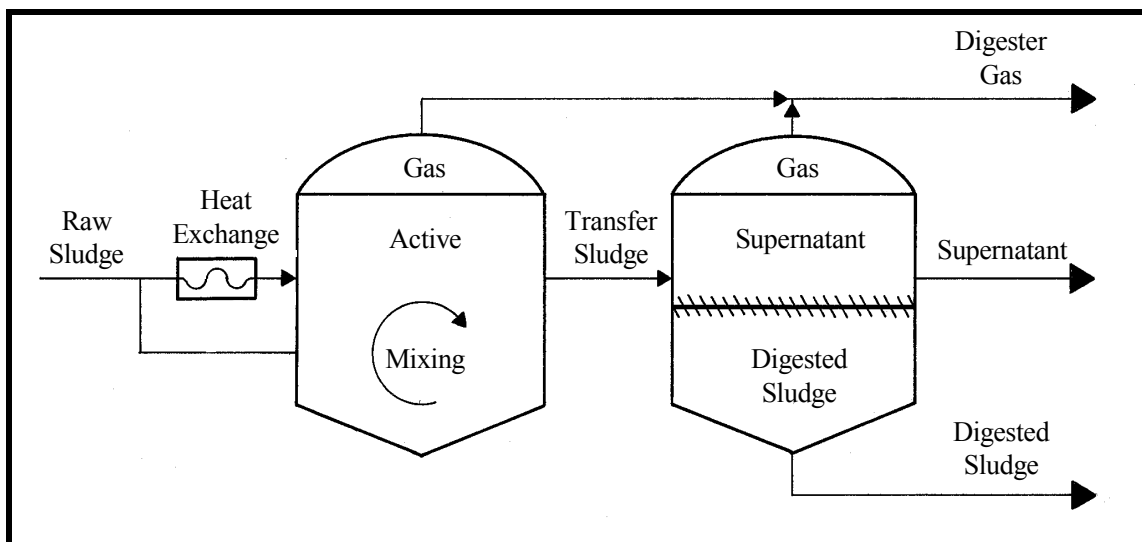

Figure XI-3. High-rate digestion (low solids)

Reduction of sedimentation layering is an important function of mixing in low-solids digestion. Usually, the contents of an unmixed low-solids digester separate into the following four layers: scum layer, supernatant, actively digesting sludge layer, and stabilised sludge (see Figure XI-2).

F1.1. Problems associated with scum formation

The scum layer is the uppermost layer. It is a froth consisting of bubbles formed by the rising of gases released in the supernatant layer. Because of the high surface tension of the supernatant, the bubbles are long-lasting and tend to accumulate and, as a result, the layer tends to increase in thickness. Because of its buoyancy, the froth collects low-density materials such as wood, straw, chaff, hair, and feathers. If the organic fraction of solid waste is part of the feedstock, small particles of paper (especially newsprint) may also become part of the scum layer. Generally, some inert fines may be found distributed throughout the froth.

Depending upon a number of factors, the thickness of the layer may be as little as 5 cm to as much as 30 cm. Digestion efficiency is adversely affected by the scum layer because the layer collects degradable material and, thereby, keeps it from entering the active zone of digestion. The extent of the isolation may be substantial if the substrate contains a large percentage of fibrous material. The exclusion of biodegradable mass from the active zone obviously decreases overall efficiency because the energy content of excluded material remains untapped.

A thick scum layer can interfere with the operation of a digester. Interference can be with operational procedures such as gas collection, medium and gas recirculation, and the lesser mixing systems. A further unfavourable result of a thick layer is that a portion of the reactor volume serves no purpose -- thereby diminishing the effective capacity of the reactor.

F1.2. Control of scum formation

Inasmuch as scum formation is minimised, if not avoided completely through proper mixing, scum formation can be controlled through the application of an appropriate mixing program. Regarding intensity, the required vigour of the mixing action, as well as the frequency needed, increases with an increase in the tendency to form scum.

Mixing can be accomplished in low-solids digestion either by recirculating liquid medium and/or gas, by mechanical mixing, or by a combination of recirculation and mechanical mixing. Recirculation usually would be sufficient when the supernatant is moderately viscous, and the digesting solids are low in fibrous content and bulk density. Recirculation of liquid medium is accomplished by taking liquid from the bottom of the digester and re-introducing it by way of discharging it above the culture through one or more jets. The approach with gas recirculation is to remove gas from the gas plenum and inject it at the bottom of the culture. The mixing action is supplied by the ascent of the resulting bubbles through the culture.

If scum formation cannot be controlled by way of recirculation, it becomes necessary to resort to mechanical mixing. The several available mechanical mixer designs basically involve the rotation of a paddle or paddles in the culture suspension. Variation generally is in the arrangement and location of the paddles. (Manual rotation of the paddle device is feasible only with cultures less than about 500 L in volume.) Continuous mixing is required only when large digester volumes are involved. For the smaller applications, mixing need be done only once or twice each day. A balance must be struck between the ability of the mixing system to break up the scum layer and its innate tendency to promote the formation of scum.

For many reasons, accomplishing mixing in high-solids digestion is much more complicated than it is in low-solids digestion. The injection operation provides some mixing in a "plug-flow" system. Tumbling the material in an airtight, rotating horizontal drum might be another approach.

F2. LOADING

Loading parameters are functions of the nature of the substrate and the degree to which operating conditions approximate the optimum. With low-solids digesters operated on a continuous basis, the extent of energy recovery from wastes and the efficiency at which digester capacity is utilised are determined by rate and amount of loading. Overloading not only leads to a decline in amount of energy recovery but also eventually results in the demise of the microorganisms -- a situation often referred to as “stuck digester”. The consequence of not loading at full capacity is inefficient utilisation of digester volume and imposition of the economic penalty associated with an unnecessarily large unit. Questionable benefits of underloading might be a higher percentage of energy recovery and a greater safety factor.

Loading may be expressed either in terms of units of volatile solids introduced per unit of digester capacity per unit of time, or of total solids per unit of digester capacity per unit of time. The use of volatile solids in expressing loading promotes uniformity and a certain degree of universality, because the percentage of volatile solids varies with type of waste. Accordingly, loading is expressed in terms of volatile solids in this discussion. Moreover, all loading rates are on the basis of dry weight of the solids.

The nature of a waste determines the suitability, i.e., “permissibility”, of a loading rate. Generally, if the waste is readily biodegradable (e.g., manure, green plants, meat), the recommended volatile solids loading is less, because the amount of material directly available to the organisms, especially the acid-formers, is greater. Because the carbon in refractory organic materials (straw, paper, dry leaves) is difficultly available to the microorganisms, the loadings can be somewhat larger without leading to adverse results. For example, at a 20- to 30-day detention period, the loading rate with raw sewage sludge could be on the order of 1.4 to 2.6 kg/m³ digester volume/day. However, the permissible loading could range from 1.0 to 2.2 kg/m³/day, with a 1:1 mixture of raw sewage sludge and organic refuse rich in paper (e.g., MSW). The breadth of the range is due to that of the temperature range, in that the lower end applies to temperate climates and the upper applies to tropical climates. A likely compromise is 3.2 kg/m³/day (detention time, 15 days) [23]. The loading with nightsoil can be about 1.0 to 2.2 kg/m³ digester culture/day [9]. Such a loading rate would accommodate the excrement from about 28 individuals. If cow dung is the substrate, the loading rate could range from 1.17 to 5.29 kg/m³ digester volume/day.

F3. DETENTION time (period)

Alternative terms for “detention” are “retention” and “residence”. Although the terms may on occasion be used in reference to batch cultures, usually they are applied only to the continuous type of culture. In practice, the solid and liquid phases of the digester contents may have a common detention time. If they have different periods, the liquid phase has one period and the solids phase has another period. The solids phase includes both the microflora and the suspended solids. The designation “hydraulic detention time” applies to the culture as a whole. The hydraulic detention time is either the common detention time or the liquid detention time. The hydraulic detention time is conventionally used in the operation of large-scale, low-solids digesters. It can be expressed as:

$$t = \frac{V}{q}$$

where:

- t = the detention time;
- V = the culture volume; and
- q = the throughput per unit of time.

Although the use of the dual detention approach is quite common in the aerobic treatment of wastewaters, its application in anaerobic waste treatment is relatively limited, albeit slowly increasing. Examples of dual detention periods in aerobic wastewater treatment are activated sludge, trickling filter, the rotating disk, and fixed-bed adaptations. Dual detention periods by way of fixed-bed adaptations have advantageous potential in anaerobic digestion practice. Two examples of situations where it is especially appropriate are: 1) a situation in which the microbial mass constitutes the bulk of the settleable solids, or the microbial growth rate is so rapid that the water consumption would be excessive if a hydraulic detention time were the only one applied; or 2) one in which the rapidity of the rate of nutrient depletion with a rapidly growing culture may be such that an abbreviated detention period would be suitable. The additional handling involved is a disadvantage of a dual detention period, as is the possibility of exposing the methanogens to atmospheric oxygen. Yet another disadvantage would be poor settling characteristics and a substantial concentration of inert fines. With such a combination, the net effect would be a gradual accumulation of inert fines without an accompanying recirculation of microbes.

Because of the difficulties associated with the dual detention approach, the subsequent discussion is principally concerned with the common (or single) type of hydraulic detention period. For several reasons, appropriate detention time is a requisite for digester efficiency.

- An unnecessarily long detention period could result in the construction of an unnecessarily large digester or in the inefficient use of existing digester capacity.
- With an unnecessarily long detention period, there is the strong possibility that the average age of the microbial populations may be beyond that of peak productivity, i.e., beyond the phase of exponential multiplication.
- The hydraulic detention period must be long enough to allow the culture to continue at peak activity. Otherwise, the population would be less than adequate for accomplishing the required energy conversion and, in effect, the full amount of potentially available energy would not be recovered.
- If the detention period is not long enough to accommodate a rate of bacterial multiplication great enough to compensate for the numbers of bacteria discharged in the digester effluent, the active microbial population would disappear -- the culture would be "washed out".

In summary, the optimum detention time is one in which: 1) the microbial population, particularly that of the methanogens, is maintained in the exponential growth phase; and 2) the greater part of the reclaimable energy in the waste is converted to the chemical energy of methane. Nevertheless, the proper length of the detention period is determined by a collection of environmental and operational conditions and of the composition of the substrate. The more closely that conditions approach optimum and the more decomposable the waste, the shorter can be the detention period. When all environmental and operational conditions are maintained at optimum, the ultimate limitation is the genetic makeup of the bacteria. In anaerobic digestion, it is the genetic makeup of the methanogens that makes it necessary to apply detention periods in terms of weeks rather than of hours. The minimum penalty for failure to account for this limitation is incomplete recovery of energy bound in the waste. The maximum penalty is the destruction or loss of the active microbial population and, eventually, a "stuck" digester.

Obviously, the suitability of a particular length of detention period varies with the nature of the substrate. For example, a satisfactory detention time for the digestion of municipal refuse in the United States probably would be about 15 days under appropriate conditions; whereas a 30-day period might be unnecessarily long. In a developing nation, the detention time would likely be 10 to 15 days. Researchers have found that a 5-day detention period was sufficient for the digestion of pure cellulose (reagent grade) that had been fortified with nutrients [3].

F4. STARTING a digester

“Starting a digester” may be loosely defined as “the establishment of culture and environmental conditions conducive to the proliferation of both indigenous and introduced methanogens”. In effect, it is the establishment of an enrichment culture for the organisms. The emphasis is on methanogens because usually the necessary populations of hydrolyzers and acid-formers are developed without difficulty. In fact, care must be taken to counteract the drop in pH level caused by acid that is generated by the acid-formers. The drop persists until the population of the slow-growing methanogens reaches a level at which it utilises all of the acids produced by the acid-formers.

Examples of situations that could make it necessary to “start a digester” are: 1) initiation of a biogasification project or expansion of an ongoing one, and 2) replacement of a “stuck” culture.

Volumetric capacity of the intended digester is one of the determinants of the method to be followed in starting a digester. A second basic determinant is type of digestion system, i.e., low-solids vs. high-solids. Unless otherwise specified, this section deals with low-solids digestion.

F4.1. Small digester (1 to 2 m³)

The digester is loaded with the waste “starter”, that could consist of 5 to 10 kg of highly organic loam. An alternative starter could be 15 to 20 L of bottom mud from a stagnant pond or swampland. A third alternative is sludge from an existing, satisfactorily functioning digester. The sludge should be diluted to about 5% solids and added in an amount sufficient to account for approximately 10% of the designed full volume of the digester. (With a high-solids digester, the sludge should be dewatered to about 85% total solids and should constitute about 10% of the waste mass.)

If a starter cannot be obtained, it would be necessary to resort to enrichment based on indigenous methanogens. The time involved would be longer than that when a starter is used.

F4.2. Large-scale digester

In general, methods of starting a small-scale and a large-scale digester are comparable. With low-solids digestion, an exception occurs when sewage is available. In a developing nation, sewage probably would be available in the country’s highly urbanised regions. The procedure for starting would be as follows: 1) the digester is filled to capacity with sewage and is allowed to remain undisturbed; and 2) after the passage of one or two weeks, a 30-day program of “feeding” is begun. The duration of the program is flexible in that it can be extended until a sufficiently large population of methanogens has developed -- as would be indicated by the production of methane. Thereafter, the loading could be gradually increased until the designed loading capacity is reached.

An alternative method is as follows: the digester is loaded with digesting sludge (obtained from an active digester) to about 10% of the designed final volume. The remaining 90% of the volume is filled with sewage. A loading based on the volume of the “starter” sludge is initiated

immediately. Thereafter, the loading is gradually increased at increments that reflect the resulting expansion of the starter volume.

G. Digester construction design principles

Although construction design principles in a developing country setting do not materially differ from those in an industrialised country, construction practice does differ.

Low-solids digestion systems currently in vogue are strongly based on those practiced in conventional treatment of wastewater solids. The designs fall into three main groups -- namely, "conventional", "high-rate", and "contact" ("fixed-bed").

G1. CONVENTIONAL digestion systems

The dimensions of the biogasification reactor (digester) constitute the first design consideration to be discussed. The required dimensions vary with type of system and digester culture, i.e., high-solids vs. low-solids digestion, and batch culture vs. continuous culture. The reactor volume involved either in batch or in continuous high-solids systems is that of the total volume of the waste to be digested. Continuity is achieved in a continuous culture by the imposition of a loading program that involves the periodic removal of an amount (volume) of culture equal to the volume of the waste to be introduced.

The situation is more complex with low-solids continuous cultures. The dimensions are functions of the amount of waste to be processed. Therefore, the dimensions depend upon the total amount of waste that must be digested, and the loading and withdrawal regimen. Regimen pertains to volume of slurried waste to be added each day, as well as the average time a given load will be in the digester (detention time), and the volumes of gaseous, liquid, and solids produced each day and their management. If the temperature of the culture is controlled, the volume of the system for heating and circulating the water used in elevating and maintaining the temperature of the digester culture also must be taken into consideration. In most situations in economically developing countries, the reactors are not heated.

In summary, the necessary digester volume is determined by the amount of wastes to be processed each day, the moisture content of the waste, the volatile solids concentration, the loading rate, solids content of the slurry, and detention time. The theoretical minimum volume of the digester can be calculated by dividing the amount of volatile solids to be added each day by the imposed loading rate. Thus, if the amount of volatile solids (VS) to be disposed each day were 1,200 kg and the loading rate were 3 kg VS/m³/day, the theoretically required digester size would be at least 400 m³. In practice, the size actually needed would be larger, because allowances must be made for "freeboard" and adjustments involved in the reconciliation of dilution requirements with intended detention times. The volume of the gas holder depends upon the amount of waste processed per day multiplied by the amount of gas produced per unit of waste introduced into the digester. Gas produced per unit of volatile solids introduced is determined by the many factors previously mentioned. As a rule, the actual size of the gas holder can be smaller than the calculated theoretical size, because some or all of the gas will be utilised on a regular basis as soon as, or shortly after, it is generated.

G2. HIGH-RATE digestion systems

The high-rate system is best suited to large-scale operations in urbanised situations. High-rate digestion is a two-stage operation in which the two stages are in series, and each stage takes place in a separate digester (cf. Figure XI-3). The first stage is the active stage. Two distinguishing characteristics of this stage are: 1) the fact that the digesting waste is thoroughly agitated, and

2) the detention period is only a few days. Effluent from digester-1 (first stage) is discharged into the second digester (second stage). In this stage, the digesting material is allowed to remain quiescent. The principal function of the second digester is to serve as a settling chamber in which the digester's contents separate into two layers -- namely, digested sludge and supernatant. The supernatant is topped by a gas plenum.

G3. "CONTACT" digestion systems

A version of the contact approach that has gained considerable attention is the "fixed-bed" system. In this system, the fixed-bed aspect is attained by providing a surface on which the microorganisms can become attached and form a film that consists mostly of active microorganisms. The surface on which the film develops is that of a solid, in a configuration conducive to film formation. The film is bathed by the waste. Periodically, either the entire film or only the film's outer layer sloughs off. The sloughing provides a detention period for the microorganisms. Examples of contact systems in wastewater treatment are the trickling filter and the rotating disk(s).

A major problem with contact systems is the maintenance of the anaerobic conditions that are essential in biogasification. Practical constraints on the adoption of contact and fixed-bed treatment in developing countries are technological and financial in nature.

G4. HEATING the digester

The practical feasibility of the application of the digestion process in cold and temperate climates demands that the temperature of the digester culture be maintained at a level sufficiently high to ensure maximum microbiological activity, or at least at a level that permits the minimum required degree of activity.

A digester culture is easily heated by circulating hot water through a coil immersed in the digester's contents. Among the variety of sources of the energy needed to elevate the temperature of the circulating water, solar energy is an interesting possibility. The key element of the system is a solar panel that has a black backing and over which water is trickled. (The face of the panel is oriented to receive maximum exposure to the sun.) In its passage over the "face" of the panel, the trickling water becomes increasingly warmer. The heated water collects in a reservoir positioned at the base of the panel. The heated water can be taken from the reservoir and then circulated through the digester heating coil.

Perhaps the largest share of the heat energy expended in heating a large-scale digester is in the elevation of the temperature of incoming feed to the level required to maintain the culture at the desired degree of activity. Heat dissipated in warming the feed is proportional to the mass flow rate and the difference between the temperature of the feed stream and that of the digester contents. This relation may be expressed as:

$$Q = Sc (T_1 - T_0)$$

where:

- S = the feedstream (kg/hr);
- c = the specific heat of the fluid (Cal/kg-°C);
- T₁ = the temperature of the culture (°C);

- T_o = the feedstream temperature ($^{\circ}\text{C}$); and
- Q = the heat required (Cal/hr).

Other heat losses are through convection and radiation, and through evaporation of water vapour from the gas stream. The energy lost in a large-scale operation by way of convection and radiation is usually minor compared to that required to heat the feed stream. Any such loss can be compensated by insulating the digester. Insulation can be used to lessen convective and evaporative heat losses in smaller operations. Some insulation can be acquired by surrounding a digester unit with soil, i.e., “sinking” it. However, such protection is only at the level of the soil temperature.

G5. SMALL-SCALE digester design and construction

The information in this section pertains to small-scale applications (less than 1 m^3 , to several m^3). It cannot be applied to large-scale systems because safety demands that large-scale units be constructed according to carefully developed engineering design, and made of durable materials. Moreover, abundant information on large-scale digesters is available in the sanitary engineering literature.

This presentation is prefaced with the reminder that regardless of the size, design, materials, and type of structure, methane generation is a hazard associated with anaerobic digestion. Methane and air become an explosive mixture at concentrations of methane as low as 5%. Consequently, no open flame should be permitted in the vicinity of a digester or gas storage unit. In addition, the over-simplification of designs and the lack of adequate skills of builders have led to several failures.

G5.1. Gobar (India) research station application

The design of the Gobar, India digester is diagrammatically shown in Figure XI-4. The greater part of the digester is below ground level. Heating of the digester contents is accomplished through the use of a submerged hot-water coil, and mixing apparently is accomplished by recirculating the digester culture. Potential daily gas production is reported as being 9.5 m^3 .

A list of materials used in constructing the digester is given in Table XI-5. The list is given because it is fairly typical of digestion systems of this nature. With the use of the list, it is possible to arrive at some concept as to types and quantities of materials required for digesters of designs proposed for other applications. Digester design, construction, and application particulars are described in detail in References 11, 12, and 13.

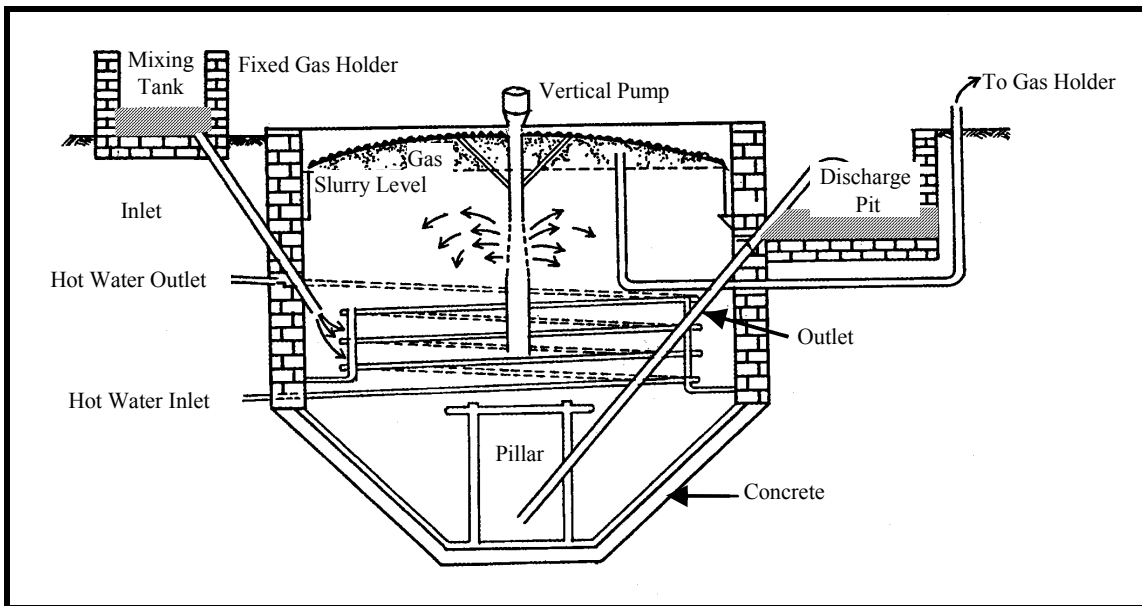

Figure XI-4. Diagram of digestion system in Gobar, India

Table XI-5. Materials required for a small-scale digester (gas production 2.8 m³/day)

Material	Quantity
Cement	40 bags
Sand	8.5 m ³
Brick ballast	2.84 m ³
Bricks	7,500
12 or 14 gauge M.S. sheet drum (1.5 m in diameter and 1.2 m in height), open at bottom	
M.S. angle iron for structure and gas holder guide	30 m
Alkaline pipe (0.125 cm in diameter)	15 m
Alkaline pipe fittings B end, elbow and sockets of 2.5 cm, and 1.25 cm fittings	3 each
Wire gauge - 80 mesh	0.93 m ²
Miscellaneous fittings	
Paint (enamel)	3.8 L

Sources: References 11, 12.

G5.2. Manure-latrine application

The designs of two digesters that had been constructed on farms in France and Germany and were in operation in the late 1950s are diagrammatically sketched in Figures XI-5 and XI-6. Figure XI-5 shows the connection between the digesters and the latrine. A detail of the digesters is shown in Figure XI-6. The direct connection between the latrine and the digester is a feature of the design. The digester designs are described in Reference 5.

G5.3. Chinese version

A version of digester design in The People's Republic of China in the 1970s is diagrammed in Figure XI-7. The gas is stored in the plenum above the culture. Inasmuch as the digester cover is fixed, the gas is under increasing pressure because of the continuing gas production. In practice,

the actual pressure is a function of the rate of gas usage and gas production. A description of the digester is provided in Reference 8.

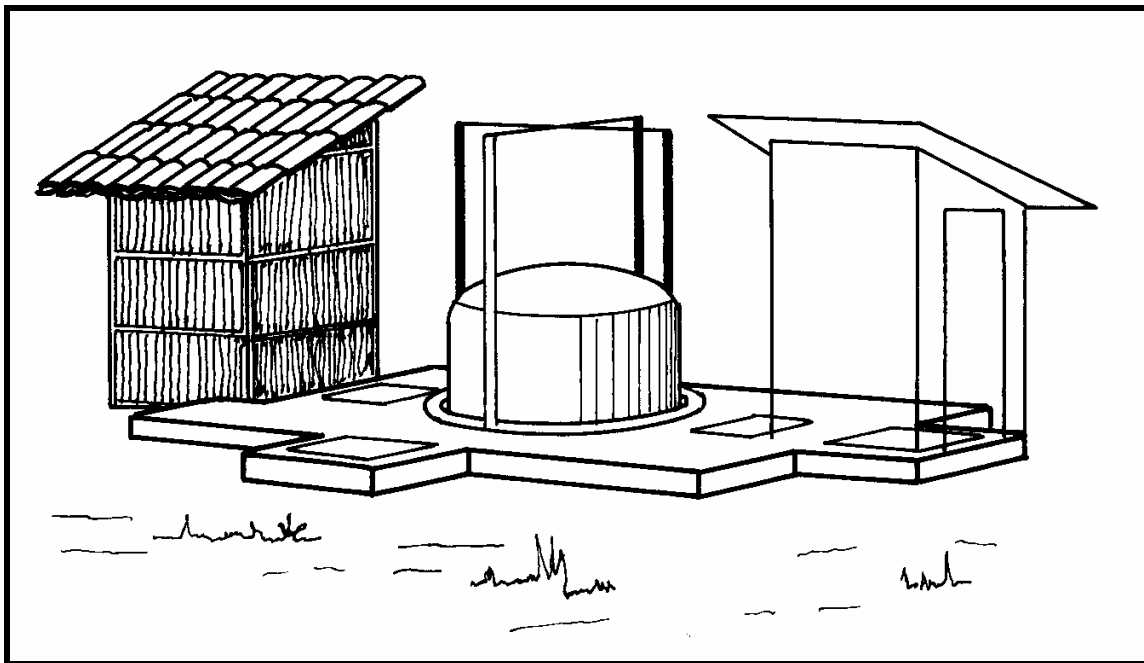

Figure XI-5. Diagram of manure digester connected to latrines

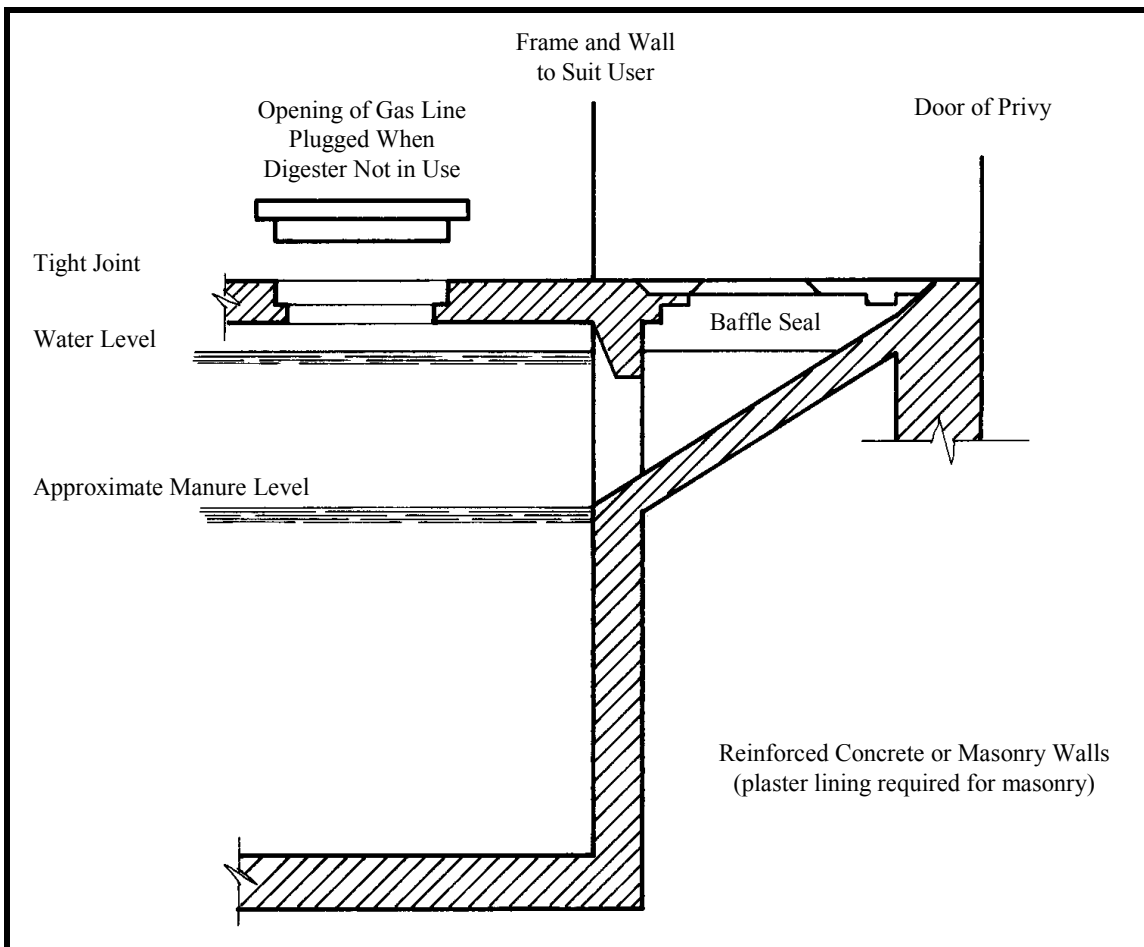

Figure XI-6. Detail of manure/nightsoil digester

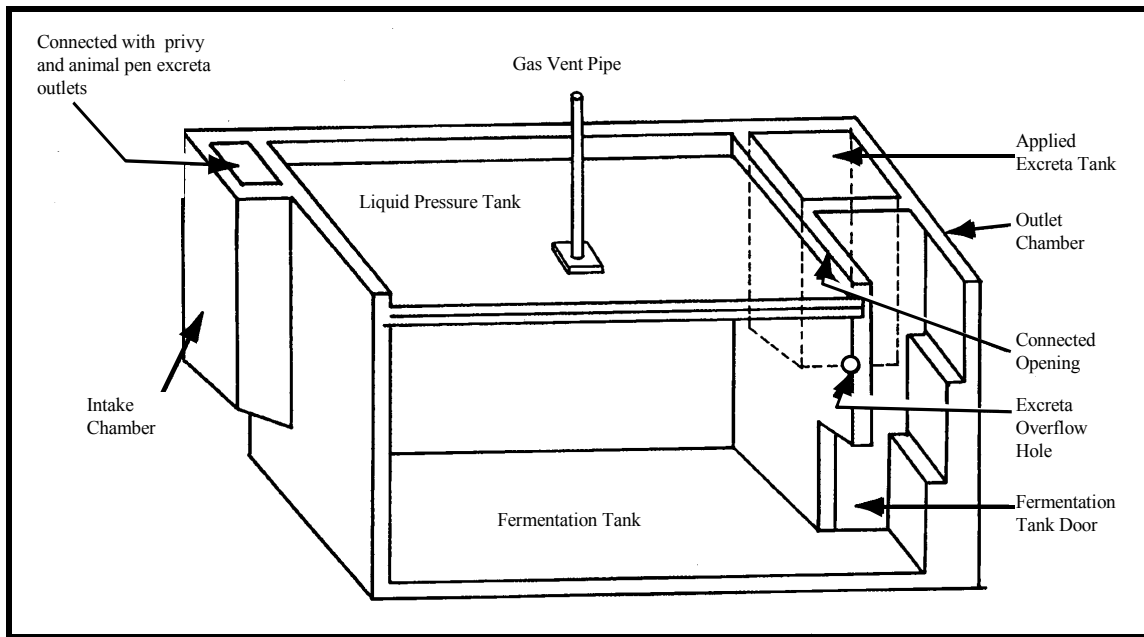

Figure XI-7. Diagram of Chinese digestion system

G5.4. Steel tank

The steel tank digester is an example of design variation to accommodate the demands of certain situations. Steel tanks adapted for use as digesters usually are replicates of steel tanks fabricated for the containment of a liquid (e.g., water). An essential feature of adaptation is the coating of the tank's interior with a material that is resistant to corrosion by substances formed in the digestion process.

Various non-proprietary adaptations were tried during a short-lived flurry of farm-scale undertakings in the 1980s in the United States. The objective was the combining of energy production with treatment of animal wastes [2]. Digester volumes usually were less than 5 m³. The flurry dwindled rapidly when state subsidies were discontinued. Foremost among the reasons advanced regarding the farmers' loss of interest were the increased burden involved in operating and maintaining a digester, and the illusory abundance of fossil fuel on the market.

Currently, a proprietary version of a steel digester is on the market in Europe. It is purported to be particularly effective for digesting liquid wastes.

G5.5. Lined excavated pit

As its name indicates, a lined pit digester is constructed by lining an excavated pit with a wall of native material found at the site of the proposed operation. The interior of the walled pit is then lined with an impervious material such as plastic film. The lined pit is suitably capped and an arrangement is made for gas collection. It is claimed that the lined excavated pit has features that enhance its potential utility in developing regions.

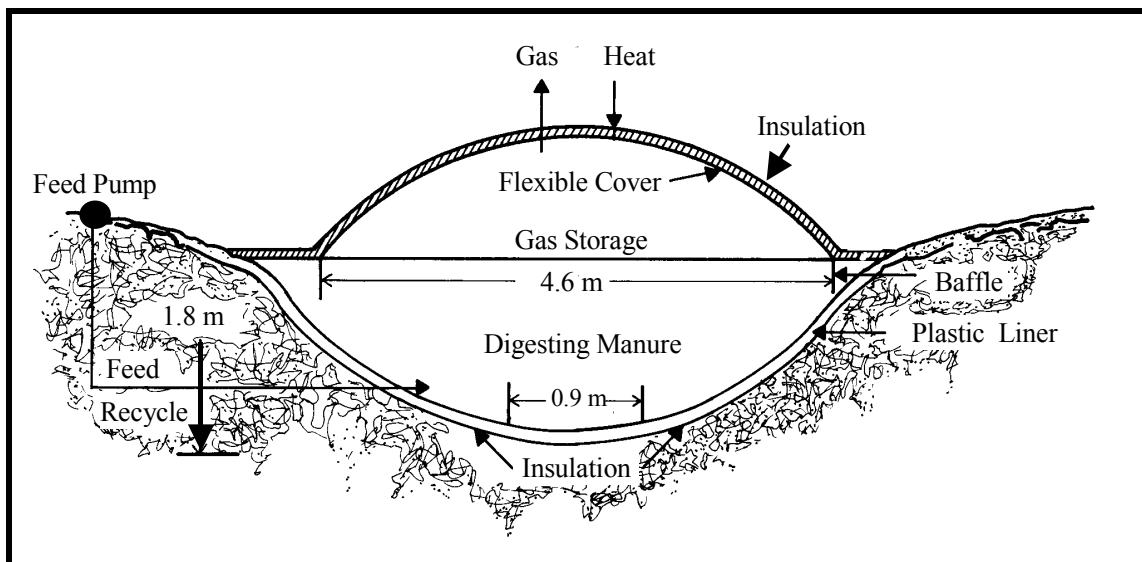

Figure XI-8. Diagram of lined-pit plug-flow reactor

The plug-flow digester diagrammed in Figure XI-8 is an example of a lined-pit adaptation. According to the reference, results obtained in an investigation involving the use of the reactor in a 65-cow operation indicate that the net energy production from a 100-cow unit could be on the order of 600×10^3 kcal/day. A pilot-scale plug-flow bioreactor is modelled in Reference 6.

The lined-pit approach is not without serious problems. Ranking high among the problems is the difficulty encountered in finding a sufficiently durable membrane that will remain genuinely impermeable throughout the life of the operation. It often happens that an initially impermeable membrane gradually becomes increasingly permeable with the passage of time because certain of the organic acids slowly affect the mechanical properties of plastics.

H. End products of the biogasification process

H1. PROPERTIES of the biogas

The composition and quality of raw (untreated) biogas directly after its emission from a digester or a landfill vary widely from day to day. The result is a wide range of values for each component. As stated in the section on parameters, the two principal components of biogas are methane (CH_4) and carbon dioxide (CO_2). From 55% to 65% of the biogas is methane; and 34% to 44% is carbon dioxide. Lesser gases include H_2S , N_2 , and H_2O . The heating value of raw biogas ranges from 18,630 to 26,080 kJ/m^3 . The raw gas can be burned and the resulting heat can be used in any one of several uses. Although the raw gas can be used as a fuel in internal combustion engines, its hydrogen sulphide content would cause considerable corrosion in the engine.

Table XI-6 lists estimates of biogas production required for satisfying the energy needs of certain applications.

H2. BIOGAS purification

Most of the potential uses of biogas demand that the quality of the gas be uniformly high and the composition vary minimally. Unfortunately, the moisture content of raw biogas may range from as low as 5% to saturation. Variations in moisture and hydrogen sulphide content can be as much as 50% from day to day and season to season. An intrusion of atmospheric oxygen in the gas could have serious repercussions in terms of explosion potential.

Table XI-6. Biogas consumption in assorted applications

Use	Specification	Quantity of Gas Required (m ³ /hr)
Cooking	5 cm burner	0.33
	10 cm burner	0.47
	15 cm burner	0.64
	5 to 10 cm burner	0.33 to 0.47
	per person/day	0.34 to 0.42
Gas lighting	per mantle	0.07 to 0.08
Gasoline or diesel engine ^a	converted to biogas, per hp	0.45 to 0.51
Refrigerator	per m ³ capacity	1.20
Incubator	per m ³ capacity	0.5 to 0.7
Gasoline	1 L	0.33 to 1.87 ^b
Diesel fuel	1 L	1.50 to 2.07 ^b
Boiling water	1 L	0.11 ^c

Sources: References 11, 12.

^a Using 25% efficiency.

^b Volume of biogas required to provide energy equivalent to 1 L of fuel.

^c Volume of biogas needed to boil off 1 L of water.

Currently available purification technology probably is so expensive as to place purification beyond the economic resources of most developing countries. Nevertheless, the technology is described and discussed in this book, because circumstances peculiar to some developing countries or regions may be such as to render purification feasible. Purification procedures may range in extent from simple dehydration to complete H₂O, CO₂, and N₂ removal. Dehydration can increase the heating value by about 10% of the original value. Combining dehydration with CO₂ and H₂S removal can bring the heating value up to 22,360 to 26,000 kJ/m³.

Among the dehydration procedures are the use of in-line gravity outflow, filtering, triethylene glycol system (TEG), molecular sieves, heating, air cooling, and refrigerant cooling.

H2.1. Molecular sieve

The molecular sieve technology is both relatively inexpensive and quite efficient. Its absorptive capacity is much greater than that of other absorbents. Molecular sieves are crystalline and aluminosilicates, honeycombed with cavities interconnected by pores, which range from about 3 to 100 angstroms in diameter. Because of the highly localised polar charges characteristic of molecular sieves, polar or polarizable compounds are strongly adsorbed on the molecular sieves.

H2.2. TEG system

The use of triethylene glycol (TEG) for gas dehydration is common. Among the reasons for the widespread usage include the following five: 1) its unusual hygroscopicity, 2) its excellent thermal and chemical stability, 3) low vapour pressures, 4) ready availability, and 5) moderate cost.

The first step in the passage of biogas through a TEG system is compression. Thereafter, bulk contaminants are removed in a "knockout drum", and the gas is cooled. The treatment thus far has removed the greater part of its water content. The cooled gas is passed through a TEG absorber/separators tower. Action in the tower is as follows: free liquids are removed in the lower

part of the tower (separator section), and the gas stream then ascends to the upper part of the tower (absorber section). In this section of the tower, the gas comes in contact with lean triethylene glycol on bubble-cap trays.

H2.3. Potassium carbonate system

Coupling the TEG dehydration system with a hot potassium carbonate scrubbing system makes it possible to remove water, CO₂, and H₂S simultaneously.

H2.4. Iron sponge

Some uses of biogas require the removal of hydrogen sulphide only. For those uses, hydrogen sulphide can be removed by passing the gas through a dry gas scrubber, i.e., an “iron sponge” consisting of ferric oxide mixed with wood shavings. Experience indicates that the removal capacity is on the order of 3.7 kg of sulphur/bushel (0.0352 m³ of iron sponge). A sponge can be regenerated by exposing the sponge to air. Exposure results in the conversion of the ferric sulphide formed in the scrubbing operation into ferric oxide and elemental sulphur.

H3. USE of purified gas

Purified biogas can be used onsite or offsite. Offsite use could involve injection of the upgraded biogas into a public utility transmission line. Onsite use generally involves use of the gas as a fuel in the generation of electricity. With respect to generation, the gas is used to fuel the internal combustion engine that drives the turbine. For such use, the gas should be compressed to about 5 psig. If a gas turbine is used, the pressure must be increased to 150 psig.

Due to the high costs involved and complexity of required equipment, any undertaking that includes the upgrading of biogas to pipeline quality would, with rare exception, be imprudent in a developing country. The practical procedure in almost all cases would be to burn the gas directly at the site of generation and to put the heat to some immediate use.

I. Residues

Combustible biogas constitutes the product, because its formation is the objective of anaerobic digestion (i.e., biogasification). Hence, all discharged non-gaseous components (i.e., solid and liquid materials) make up the residues. Accordingly, prior to further processing, digested sludge constitutes the collective residue. As was indicated earlier in this chapter, unprocessed digested sludge consists of a liquid phase (the supernatant) and a settled solids phase (cf. Fig. XI-2). In an anaerobic digestion operation, supernatant and settled solids (sludge) are the two principal residues that require management and treatment.

II. SUPERNATANT

The supernatant is an aqueous suspension in which the suspending medium contains an assortment of dissolved solids and a variety of suspended colloidal solids and bacterial cells. Because its dissolved and colloidal solids contents are highly biodegradable and therefore unstable, the supernatant must be properly treated before being discharged into the environment. In practice, a sizeable portion of the supernatant is returned to the digester; i.e., it is recirculated. In a two-stage operation, the supernatant is returned to the first digester. Recirculation promotes the build-up of the microbial population and more complete utilisation of nutrients. Application on land is a beneficial means of disposing of supernatant that is not recirculated.

I2. SLUDGE (biosolids)

The settled sludge layer, i.e., the bottom layer in Figure XI-2, constitutes the sludge residue. In “everyday” practice, the term “sludge” often has a much broader connotation, in that occasionally it is applied indiscriminately to the solids in the sludge layer and to the combined solids and supernatant. Another classification that may be encountered in practice and in the literature is based on the division of the solids layer into two layers -- namely, the digesting sludge and the inactive sludge layers. In this chapter, sludge (“biosolids”) refers solely to the layer of settled solids.

As stated previously, the term “sludge” is often applied both to the effluent at the point of discharge from the digester and to the solids mass formed by dewatering the effluent (dewatered sludge). In the absence of dewatering, the solids content of the effluent generally is 1.5% to approximately 4% or 5%. Undewatered effluent frequently is directly spread upon or incorporated into the soil. The extent to which the effluent may be dewatered depends upon the intended disposition of the dewatered sludge.

The technology of dewatering is broad, ranging from simply spreading upon a sand bed to processing through complex equipment. With the sand bed method, dewatering is by way of drainage and evaporation. Mechanical removal of water is by way of vacuum filtration or centrifugation. Because of its simplicity and low cost, the sand bed method is usually the appropriate approach in a developing nation. During sunny, dry weather, a solids content of 15% to 20% can be attained within a week with the use of a properly designed and operated sand bed. Sand beds should be sheltered from rain and snow.

The physical and chemical characteristics of a dewatered sludge generally are comparable to those of its composted counterpart, excepting that its nitrogen content is greater. Despite the many similarities between non-composted and composted sludges, public health considerations dictate that digested sewage sludge containing human excrement be composted prior to utilisation in agriculture.

The term “excrement” includes collected human faeces and urine, nightsoil, septic tank cleanings, raw sewage sludge, and any other material that may contain human body waste. As is stated in an earlier chapter, the hazard posed to public health by excrement is the likely presence of enteric pathogens. Table XI-7 presents a list of such organisms. Unfortunately, despite the substantial destruction of pathogens that occurs during conventional (mesophilic) digestion, the number of surviving pathogens is great enough to constitute a health hazard (see Table XI-8). However, extent of destruction probably would be sufficient if digestion took place at thermophilic temperature levels.

In summary, conventionally digested sludge generally can be used interchangeably with composted sludge in agriculture, unless the sludge feedstock contains human excrement. A constraint on the use of either digested sludge or composted sludge, independently of excrement, would be the presence of toxic metals and toxic synthetic organic chemical compounds (e.g., halogenated hydrocarbons) found in many sludges of industrial origin. However, industrial sludges are not likely to be encountered in a developing country because they involve industrially generated wastes. Problems resulting from the presence of heavy metals and toxic chemicals, as well as methods of alleviating them, are discussed in Chapter VII, Use of Waste-Derived Organic Matter as a Soil Amendment. Additional information can be found in Reference 7.

J. Feasibility considerations

Among the factors that determine the practical and economic feasibility of biogas production in a developing country, either as a waste management option or as an energy resource, or both, two are particularly important: 1) availability of the required technology, and 2) the extent of the country's economic resources. However, superseding the two factors is magnitude of the proposed undertaking. The decisive influence of magnitude arises from the fact that technological and economic requirements escalate almost logarithmically with increase in magnitude, and soon exceed available technological and financial resources of all but the more highly industrialised countries.

Table XI-7. Enteric pathogens

Category	Disease	Organisms (where identified)
Viral	Infectious hepatitis	
	Gastroenteritis	
	Respiratory illness	adenovirus reovirus
Bacterial	Poliomyelitis	enterovirus (poliovirus)
	Typhoid fever	<i>Salmonella typhosa</i>
	Salmonellosis	<i>Salmonella</i> spp. (Exp. <i>S. paratyphi</i> , <i>S. schottmueleri</i>)
	Bacillary dysentery	<i>Shigella</i> spp. (Shigellosis)
	Cholera	<i>Vibrio cholerae</i>
Protozoan	Tuberculosis	<i>Mycobacterium tuberculosis</i>
	<i>Amebiasis</i>	<i>Entamoeba histolytica</i> (<i>Amebic dysentery</i>)
Helminthic	(Roundworm)	<i>Ascaris lumbricoides</i>
	(Pinworm)	<i>Oxyaris vermicularis</i>
	(Whipworm)	<i>Trichurus trichiura</i>
	(Tapeworm)	<i>Taenia saginate</i>
	(Hookworm)	<i>Ancylostoma duodenale</i> <i>Necator americanus</i>

Table XI-8. Survival of pathogens in the anaerobic digestion process

Organisms	Temperature (°C)	Residence Time (days) ^a	Die-Off (%)
Poliovirus	35	2	98.5
<i>Salmonella</i> ssp.	22 to 37	6 to 20	82 to 96
<i>Salmonella typhosa</i>	22 to 37	6	99
<i>Mycobacterium tuberculosis</i>	30		100
<i>Ascaris</i>	29	15	90
Parasite cysts	30	10	100 ^b

Sources: References 28-30.

^a Time in digester.

^b Does not include *Ascaris*.

An arbitrary but logical and convenient classification of “magnitude” is into “large-scale” and “small-scale”. Accordingly, a large-scale operation is one that involves 100 Mg or more per day,

and serves a metropolitan area. The primary function of a large-scale plant is the treatment of wastewater solids (sewage sludge), and biogas production is secondary and coincidental. Small-scale operations are suited to villages and individual farms, or to groups of farms. In operations on that scale, biogas production ranks with waste treatment in terms of priority.

J1. LARGE-SCALE undertakings

As of this writing, the record of large-scale biogas installations, other than conventional wastewater solids treatment, is singularly scarce and unimpressive in developing countries. Available technology for non-sewage sludge, large-scale operations based on low-solids digestion has not been successful, largely because of operational problems and deficiencies in digester design and construction. Currently, the trend is toward high-solids digestion. However, the largest high-solids digester presently in operation is modest in size. It is only relatively recently that some European designs have been applied to the anaerobic digestion of primarily manures and the highly putrescible fraction of domestic waste. A photograph of a new high-solids anaerobic digester is shown in Figure XI-9. The facility is in Salzburg, Austria and processes on the order of 18,000 Mg/yr. The digested residue is dewatered and composted in tunnel reactors. A portion of the gas produced by the digester is used to generate electricity for use by the facility. The remainder of the gas is burned in a flare. Digesters of this type operate under the following conditions: digester loading, 10 to 30 kg of COD/m³ of digester volume-day; temperature, 50° to 58°C; and a detention time of 15 to 30 days. Based on these conditions, one could expect a production of about 4 to 8 Nm³ of biogas/m³ of digester volume per day, with a concentration of methane of about 60% (by volume) [24]. Several of these and similar units have been installed in primarily Western European countries.



Courtesy: CalRecovery, Inc.

Figure XI-9. Example of high-solids anaerobic digester

J2. SMALL-SCALE undertakings

Technical problems encountered in small-scale operations generally are related to maintenance and functioning of the digester [10]. Examples are corrosion of gas holders, “wear and tear” of components such as the guide pipe of the gas holder and of hoses, and the development of cracks in the digester walls. Financial constraints arise mainly from the relatively high costs of construction materials, scarcity of land on which to locate the plant, and diversion of labour to unrelated activities. In some countries, sociological and cultural problems may be manifested by a prejudice against connecting latrines to a gas plant, or in a reluctance of farmers to use a latrine [10]. The problems are aggravated by the low levels of gas production that occur during cold weather.

Problems that beset small-scale farm operations can be alleviated through integration into a community installation. The integration would be accompanied by the establishment of an organisational program designed to: 1) provide follow-up service; 2) ensure frequent contacts with relevant agencies for technical advice; and 3) establish a mechanism for access to reliable and regular supply of raw materials and plant components, and provide for personal contacts by biogas technicians.

K. References

1. American Public Health Association (APHA), *Standard Methods for the Examination of Water and Wastewater*, APHA, 13th Ed., New York, New York, USA, 1971.
2. Anonymous, Anaerobic Digestion of Dairy Cow Manure at the State Reformatory Honor Farm, Monroe, Washington, Ecotope Group and Parametrix, Inc., Sumner, Washington, USA, 1975.
3. Chan, D.B. and E.A. Pearson, *Comprehensive Studies of Solid Waste Management: Hydrolysis Rate of Cellulose in Anaerobic Fermentation*, SERL Report No. 70-3, Sanitary Engineering Research Laboratory, University of California, Berkeley, California, USA, October 1970.
4. Fry, L.J. and R. Merrill, *Methane Digester for Fuel, Gas, and Fertilizer*, Newsletter No. 3, Santa Cruz, California: New Alchemy Institute-West, USA, 1973.
5. Gotaas, H.B., *Composting*, World Health Organization Monograph Series, No. 31, WHO, Geneva, Switzerland, 1956.
6. Hayes, T.D., W.J. Jewell, J.A. Chandler, S. Dell'Orto, K.J. Farfoni, A.P. Leuschner, and D.F. Sherman, "Methane Generation from Small Scale Farms", *Biogas and Alcohol Fuels Production*, proceedings of a seminar on Biomass Energy for City, Farm, and Industry, Chicago, Illinois, JG Press, Emmaus, Pennsylvania, USA, May 1979.
7. Leeper, G.W., *Managing the Heavy Metals*, Pollution Engineering Technology Series, Marcel Dekker, Inc., New York, New York, USA, and Basel, Switzerland, 1978.
8. McGarry, M. and J. Stainforth, editors, *Compost, Fertilizer, and Biogas Production from Human and Farm Wastes in the People's Republic of China*, International Development Research Centre, Ottawa, Ontario, Canada, 1978.
9. National Academy of Sciences (NAS), *Methane Generation from Human, Animal, and Agricultural Wastes*, Report of an Ad Hoc Panel of the Advisory Committee on Technology Innovation, National Research Council, NAS, Washington, DC, USA, 1977.
10. Prakasam, T.B.S., "Application of Biomass Technology in India", *Biogas and Alcohol Fuels Production*, proceedings of a seminar on Biomass Energy for City, Farm, and Industry, Chicago, Illinois, J.G. Press, Inc., Emmaus, Pennsylvania, USA, May 1979.
11. Singh, R., *Bio-gas Plant: Generating Methane from Organic Wastes*, Gobar Gas Research Station, Ajitmal, Etawah (V.P.) India, 1971.
12. Singh, R., "Building a Bio-Gas Plant", *Compost Science*, 13(2):12-17, March/April 1972.
13. Singh, R., "The Bio-Gas Plant -- Generating Methane from Organic Waste", *Compost Science*, 13(1):20-26, January/February 1972.
14. Sullivan, J.L., C.M. Ostrovski, and N. Peters, *Feasibility Analysis Model for Centralized Methane Production from Animal Wastes*, Report for Ontario Ministry of Energy (File No. 1903-02-876-24) Faculty of Engineering Science, The University of Western Ontario, London, Canada, 1978.

15. Hungate, R.E., "Studies on Cellulose Fermentation - I. The Culture and Physiology of an Anerobic Cellulose Digesting Bacterium", *Journal of Bacteriology*, 48:499-513, 1944.
16. Hungate, R.E., "The Anaerobic Mesophilic Cellulytic Bacteria", *Bacteriological Review*, 14:1-49, 1950.
17. Hungate, R.E., "Microorganisms in the Rumen of Cattle Fed a Constant Ration", *Canadian Journal of Microbiology*, 3:289-311, 1957.
18. Madden, R.H., M.J. Bryder, and N.J. Poole, "Isolation and Characterization of an Anaerobic Cellulytic Bacterium, *Clostridium papyrosolvans* sp. nov.", *International Journal of Systematic Bacteriology*, 32:87-91, 1982.
19. Madden R.H., "Isolation and Characterization of *Clostridium stercorarium* sp. nov. Cellulitic Thermophile", *International Journal of Systematic Bacteriology*, 33:837-840, 1983.
20. Mendez, B.S., M.J. Pettinari, S.E. Ivanier, C.A. Ramos, and F. Sineriz, "*Clostridium thermopapyrolyticum* sp nov., a cellulolytic thermophile", *International Journal of Systematic Bacteriology*, 41:281-283, 1991.
21. Zeikus, J.G., "Microbial populations in digesters", *Anaerobic Digestion*, D.A. Stafford, B.I. Wheatley, and D.E. Hughes (ed), 61-89 pp., Applied Science Publishers, London, England, 1980.
22. Kaseng, K., K. Ibrahim, S.V. Paneerselvam, and R.S. Hassan, "Extracellular Enzymes and Acidogen Profiles of a Laboratory-Scale Two-Phase Anaerobic Digestion System", *Process Biochem.*, 27:43-47, 1992.
23. Diaz, L.F., G.M. Savage, G.J. Trezek, and C.G. Golueke, "Biogasification of Municipal Solid Wastes", *Journal of Energy Resources Technology*, 103:180-185, June 1981.
24. Personal Communication, City of Salzburg, Austria, October 1995.
25. European Council, "Council Directive 1999/31/EC of 26 April 1999 on the landfilling of waste", *Official Journal of the European Communities*, L 182, 1-13; 1999.
26. Diaz, L.F., et al., "Selective Aspects of the Treatment of Biodegradable Waste in the European Union", presented at the 2002 International Symposium on Composting and Compost Utilization, Columbus, Ohio, USA, May 2002.
27. Kayhanian, M. and S. Hardy, "The Impact of Four Design Parameters on the Performance of a High-Solids Anaerobic Digestion of Municipal Solid Waste for Fuel Gas Production", *Environmental Technology*, 15(6):557-567, 1994.
28. Bertucci, J., et al., "Inactivation of Viruses During Anaerobic Sludge Digestion", *Journal of Water Pollution Control Federation*, 49(7):1642-1651, 1977.
29. Foster, D.H. and R.S. Engelbrecht, "Microbial Hazards in Disposing of Wastewater and Soil", *Recycling Treated Municipal Wastewater and Sludge through Forest and Cropland*, W.E. Sopper and L.T. Kurdos, eds., Pennsylvania State University Press, University Park, Pennsylvania, 1973.

30. Dotson, G.K., "Some Constraints of Sprading Sewage Sludge on Croplands", *Land Disposal of Municipal Effluents and Sludges*, Proceedings of Conference on Land Disposal of Municipal Effluents and Sludge, March 1972, U.S. Environmental Protection Agency, EPA-902/9-73-001, 1973.

CHAPTER XII. PRODUCTION OF REFUSE-DERIVED FUEL (RDF)

A. Background

Typically, the production of a combustible fraction (i.e., fuel) from mixed municipal solid waste (MSW) and its thermal conversion requires two basic and distinct subsystems -- namely, the “front-end” and the “back-end”. The combustible fraction recovered from mixed MSW has been given the name “refuse-derived fuel”, or simply “RDF”. The composition of the recovered combustible fraction is a mixture that has higher concentrations of combustible materials (e.g., paper and plastics) than those present in the parent mixed MSW. Thus, the rationale for recovering a prepared fuel from mixed MSW is that the recovered fuel fraction is of higher quality than is raw (i.e., unprocessed) MSW itself.

The principal function of the front-end (“pre-processing”) subsystem is to accept solid waste directly from the collection vehicle and to separate the solid waste into two fractions -- namely, combustible and non-combustible. The front-end separation produces the “feedstock” for several types of back-end recovery (or conversion) systems, among which are included thermal and biological systems.

The main components (i.e., unit operations) of a front-end subsystem are usually any combination of size reduction, screening, magnetic separation, and density separation (e.g., air classification). These unit operations and equipment are discussed in detail in Chapter VI, Materials Recovery and Recycling. The types and configurations of unit operations selected for the front-end design depend on the types of secondary materials that will be recovered and on the desired quality of the recovered fuel fraction. The fuel quality must be specified by the designer or supplier of the thermal conversion system.

Typically, systems that recover a combustible fraction from mixed MSW utilise size reduction, screening, and magnetic separation. Some designs and facilities have used screening, followed by size reduction (e.g., pre-trommel screening), as the fundamental foundation of the system design, while others have reversed the order of these two operations. A number of considerations enter into the determination and the selection of the optimum order of screening and size reduction for a given application. Among others, the considerations include composition of the waste. Other unit operations may also be included in the system design, including manual sorting, magnetic separation, air classification, and pelletization (i.e., densification), as the need dictates for recovery of other materials (e.g., aluminium, etc.) and for achieving the desired specification of the solid fuel product [1].

Some examples of RDF production configurations from former and current facilities in the United States are given in Figure XII-1. The processing configurations shown in the figure are arranged from left to right in the approximate order of their historical development. The maturation of the processing designs occurred as a consequence of several circumstances, which included either singularly or in combination, inadequate performance of equipment, inadequate energy yield, and unacceptably high RDF ash content.

An historical perspective of the maturation of RDF processing configurations in the United States is shown Figure XII-2, along with reasons for the modifications of the configurations.

An example of a pre-processing system to recover RDF is illustrated in Figure XII-3. The processing configuration depicted in the figure utilises a pre-trommel screen, secondary trommel

screen, one stage of size reduction, and a magnetic separator as the key unit operations to effect recovery of a high-quality RDF.

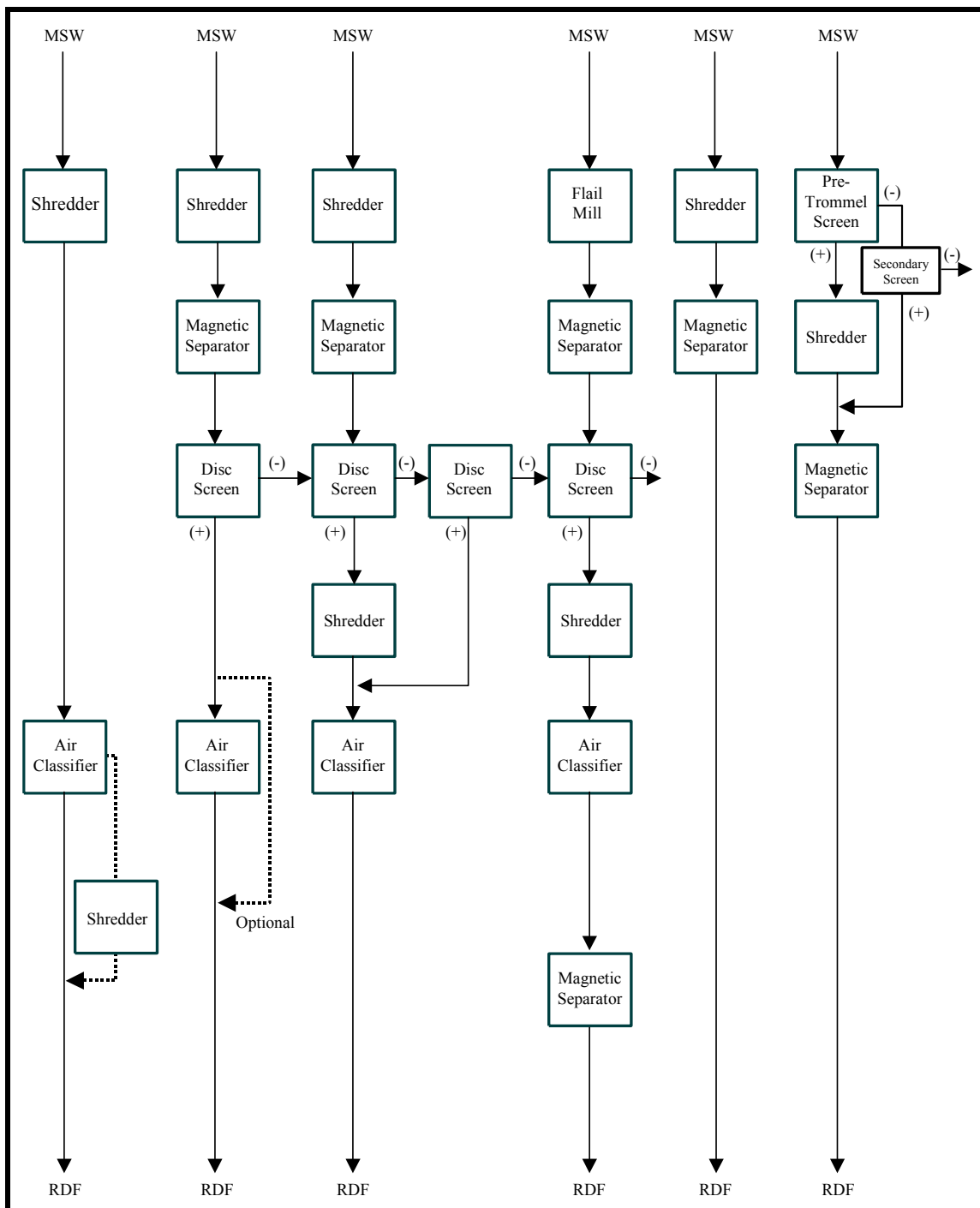

Figure XII-1. Examples of front-end configurations used in the United States for RDF production

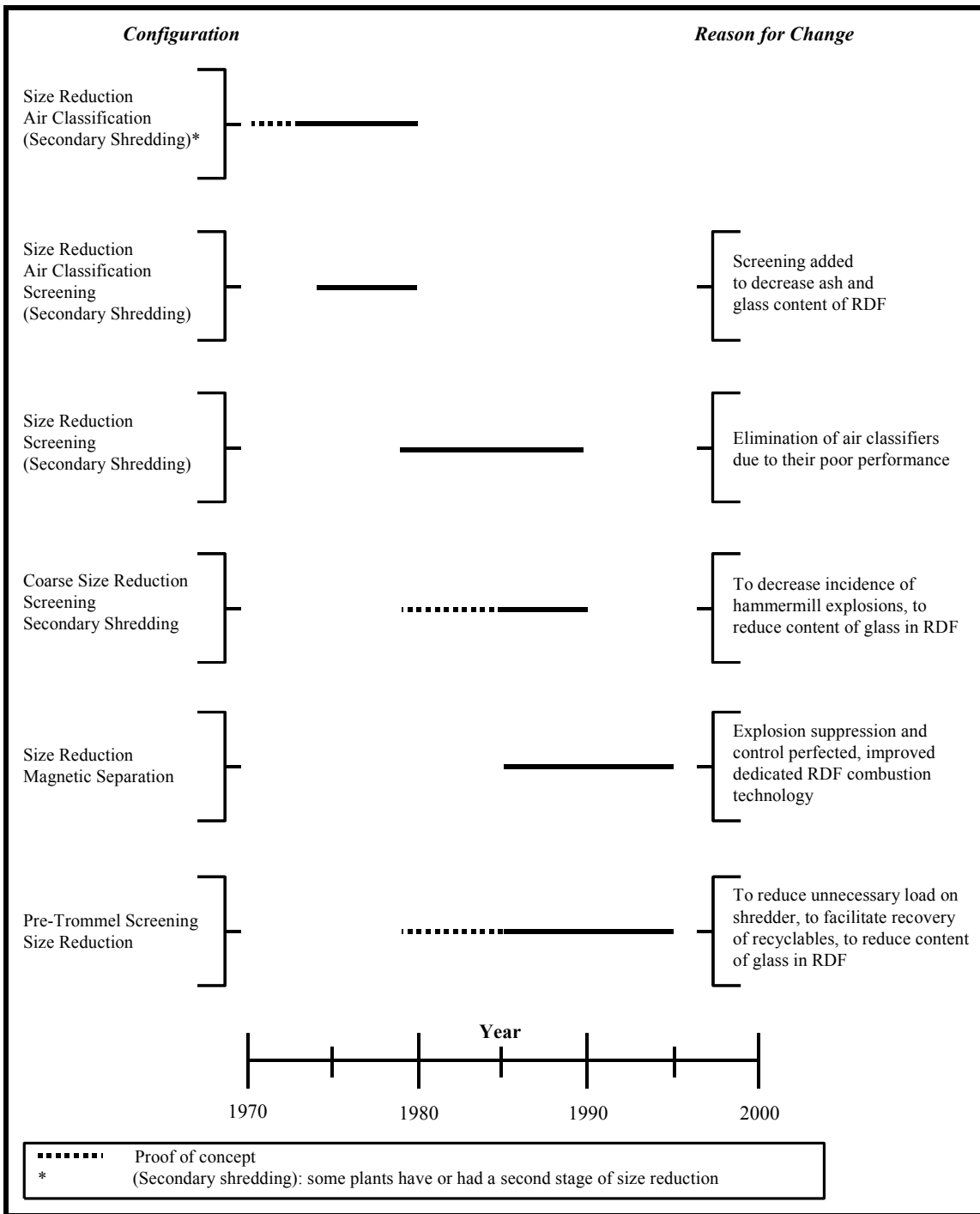

Figure XII-2. Historical perspective of front-end configurations for RDF production

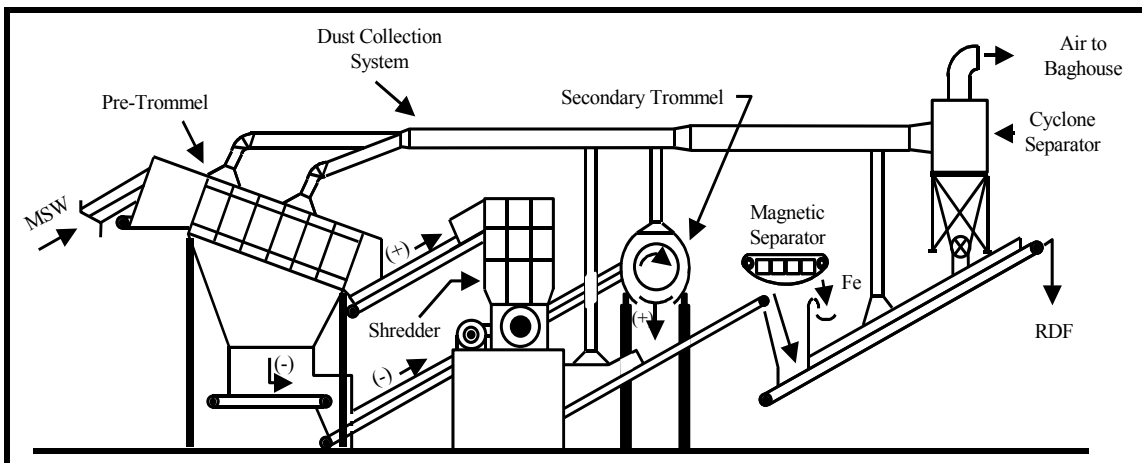

Figure XII-3. RDF production system with pre-trommel configuration

In terms of applications, RDF has been used in industrialised countries as a fuel supplement for coal-fired utility boilers and as the sole fuel for firing in dedicated boilers (i.e., boilers that use RDF exclusively). When fired as a supplemental fuel in coal-fired boilers (i.e., co-fired), experience has shown that RDF with heating values in the range of 12,000 to 16,000 J/g (wet wt basis) can successfully contribute up to about 30% of the input energy.

While RDF has advantages over mixed MSW as a fuel in terms of quality and uniformity of characteristics, it also has some disadvantages. One of the disadvantages is the fact that a cost is associated with the front-end processing to recover the fuel fraction. Another disadvantage is that the unit yield of energy (i.e., kJ per kg of MSW) in the case of RDF is less than that of the parent MSW.

B. RDF characteristics

Pre-processing provides the means of recovering a high-quality fuel fraction from solid waste. An additional and equally important benefit of pre-processing is that it characteristically serves to control the fluctuations in characteristics of the RDF. In other words, within the usual limits of the time-varying characteristics (e.g., composition) of MSW, the pre-processing of MSW yields a combustible fraction whose properties are relatively uniform over time when compared to the variation in the properties of the parent MSW.

Various qualities of RDF can be produced, depending on the needs of the user or market. The range of qualities of RDF with regard to the more important thermal properties is presented in Table XII-1. The data shown in the table are for refuse-derived fuels produced from the solid wastes of industrialised countries. A high quality of RDF would possess a higher value for the heating value, and lower values for moisture and ash contents. As shown by the data in the table, RDF is a fuel of higher quality than is unprocessed MSW. For those properties listed in Table XII-1, the values for RDF are closer to those of typical sub-bituminous coals than those for MSW. The quality of RDF is sufficient to warrant its consideration as a preferred type of fuel when solid waste is being considered for co-firing with coal or for firing alone in a boiler designed originally for firing coal.

As mentioned above, the ranges of thermal properties for RDF shown in Table XII-1 are representative of RDF recovered from MSW from industrialised countries. In the case of economically developing countries that have high concentrations of materials with high moisture content in their solid waste, the RDF can be expected to be of lower quality unless extraordinarily complex methods of processing are employed. Specifically, the heating value on a wet wt basis,

while relatively uniform, nonetheless would be at the lower end of the range in Table XII-1, or less, because much of the moisture will be absorbed by and adhere to the predominantly combustible materials (represented by paper and film plastic in the wastes) present in the recovered fuel fraction. In effect, the heating value is diluted by the substantial concentration of moisture.

Table XII-1. Important fuel properties of RDF^a

Type of Fuel	Heating Value As-Received (J/g)	Moisture Content (%)	Ash Content (%)
RDF	12,000 to 16,000	15 to 25	10 to 22
Coal	21,000 to 32,000	3 to 10	5 to 10
MSW	11,000 to 12,000	30 to 40	25 to 35

Source: CalRecovery, Inc.

^a Typical of RDF recovered from municipal solid wastes generated in industrialised nations.

C. Use of RDF

In keeping with the present state of technology, when RDF is used as a fuel or as a supplement, it is fired in a moving grate furnace or a boiler equipped with some form of grate. The experiences had with the co-firing of RDF and pulverized coal in suspension-fired coal boilers, which have no bottom grates, fell well short of expectations except in some isolated cases. The reasons for the disappointment included difficulty in feeding RDF into the boiler, higher percentage of excess air, inadequate residence time for complete combustion of the RDF while in suspension, and its lower heating value when compared to most coals. The incomplete combustion of the RDF, along with its higher production of ash per unit of energy released, combined to cause overloading of the ash handling systems of the suspension-fired coal boilers. Additionally, incomplete combustion adversely affected the overall thermal efficiency of the energy recovery system.

RDF can also serve as a feedstock for other types of thermal systems, e.g., pyrolysis and fluidised bed systems. The relative uniformity of properties and higher quality of RDF compared to mixed MSW has led in the past to a preference for RDF in some applications.

D. Presence of contaminants

Although RDF has relatively high concentrations of paper and plastics, both of which have a high heating value (paper, about 17,460 J/g; plastics, about 37,250 J/g) in comparison to most coals, it also contains materials that: have a relatively high percentage of ash, can be damaging to burners and boilers, and can exert a seriously adverse effect on the quality of the exhaust gases. For example, RDF typically contains materials that have substantial concentrations of chlorides. During the course of combustion, some or all of the chlorine may be converted to hydrogen chloride (HCl) by combining with the hydrogen released from the water inherent in the combustible fraction or with the water formed from the oxidation of hydrogen. As is well known, under many conditions HCl can have a corrosive effect on the internal surfaces of the burner and sections of the boiler, especially the boiler tubes. Of course, mixed MSW also contains chlorides and, therefore, it also suffers from these same shortcomings when viewed as a potential fuel.

The presence of small particles of metal and of glass fines (<0.125 cm) in RDF can present problems in the combustion system. The exclusion of these small particles in RDF is a difficult exercise in process design as a consequence of their inherent physical and aerodynamic characteristics and of the inherent inefficiencies of mechanical processing equipment. Although the resulting contamination in pre-processed MSW may be considerably less than 1% by wt, a

build-up of silicon dioxide and metal oxide deposits on the heat transfer surfaces of the boiler eventually occurs (the combustion of MSW shares this drawback also). The resulting fouling can lead to the loss of the heat transfer capacity of the surfaces. In extreme cases, the fouling could be sufficiently extensive as to necessitate a premature (i.e., unscheduled) shutting down and overhauling of the boiler. An encouraging note is that recent advances in metallurgy and in surface coatings for boiler tubes have led to substantially reduced fire-side corrosion in solid waste-fired boilers.

With respect to ash, in the production of a given amount of energy, ash production resulting from combustion of RDF can be four to six times that which would be experienced with the combustion of coal. Consequently, even with the use of RDF in a co-firing situation with coal, some provision must be made for handling the additional burden of ash.

Even though RDF more closely approaches homogeneity than does raw solid waste, the approach is far from great enough to justify RDF being regarded as a clean or high-quality fuel in terms of combustion. The reason is that RDF is a combination of many materials, each of which has its particular set of characteristics. The consequence is that in comparison to more homogeneous solid fuels, such as wood or coal, the maintenance of an efficient combustion process is more difficult when RDF is used as a fuel.

E. Beneficiation of RDF

The use of mechanical screening to produce a very high-quality RDF in terms of a reasonably high heating value, a low moisture content, and a low ash content was demonstrated at the University of California (USA) [2] in the mid-1970s and the concept was put into practice in several locations.

E1. HEATING value

The key design feature required for the recovery of a very high-quality RDF is the proper use of a screening operation in the sequence of processing. Screening operations either before or after the size reduction step have proven successful. Additionally, the trommel screen historically has been the equipment of choice, although exceptions exist. Through a judicious selection of a proper screen opening size, most of the minute contaminants (fines) can be removed from the RDF; they pass through the screen openings. On the other hand, the combustible fraction is retained by the screen, and exits the screen as the oversize stream. Generally, from 40% to 60% of the waste disposed in industrialised countries fits this category. Since the fines characteristically are inert materials having little or no heating value, their elimination has a twofold effect: 1) the overall heating value of the RDF is increased as a result of concentrating the combustible paper and plastic materials (screened RDF is about 95% paper; whereas prior to screening, it is only 60%); and 2) the ash content is materially lowered. Studies have shown that on the order of 90% or more of materials that have a low heating value can be removed with the use of a trommel screen [2,4].

The substances that collectively give RDF its heating value belong to one of two groups: those that have a high inherent heating value, and those that have a low heating value. Those that have a high heating value are almost exclusively in the form of paper, paper products, and plastics. The heating value of this group averages about 18,600 J/g. Inorganic fines (e.g., glass particles) and fine, wet organic matter (e.g., food preparation waste) make up the fraction having a relatively low heating value, i.e., on the order of 10,800 J/g. Obviously, the inclusion of the latter category in an RDF lowers the overall heating value of the RDF. In terms of thermal efficiency, the removal of the finely sized, inorganic (i.e., non-combustible) particles and the fine, wet organic

particles from RDF can bring about an increase in the heating value of RDF by 20% over that of an RDF in which the non-combustible and fine, wet organic particles are retained.

E2. MOISTURE content

Another major benefit accruing from the pre-processing of MSW for recovery of a quality fuel is a lowering of the moisture content of the recovered RDF fraction in comparison to that of the parent MSW. This benefit is of particular relevance in the case of developing countries, where the wastes commonly have high concentrations of wet, putrescible matter. The lowering of the moisture content is a result of the disproportionate removal of moisture that accompanies the removal of waste materials during processing that occupy the lower range of the particle size distribution (i.e., finer sized materials) of MSW. These materials (e.g., food preparation and garden wastes) characteristically are wetter than the materials occupying the upper range of the distribution (e.g., paper). The removal of the finer-sized particles is most easily and usually conducted with screens (usually trommel screens), which allow the finer-sized materials to pass through the screen openings. The removal is disproportionate because the average moisture content of the “undersize” fraction is appreciably greater than that of the “oversize” fraction. Depending on the local conditions and the design of the pre-processing system, an RDF potentially can have a moisture content that is 25% to 50% lower than that of the parent MSW. At the same time, the heating value is increased proportionately.

F. Precautions

Proper design of a front-end system is obviously imperative for the successful operation of a fuel production facility. The key function of the pre-processing system is the segregation of the combustible components from the non-combustible components. In the production of a solid fuel (RDF), particular attention must be paid to the combustion unit in which the fuel is to be burned. For example, in order to facilitate handling, storage, and transportation, it may be necessary in some cases to produce a densified fuel.

The processing of municipal solid wastes for the production of a fuel is seemingly straightforward in terms of design and system operation. The performance and operation of the processing system is strongly and fundamentally determined by: the characteristics of the solid waste feedstock, the type of equipment chosen, and the location of the equipment in the overall processing configuration. Although some of the equipment available for solid waste processing applications may have been proven to be well suited to the processing tasks of other industries (e.g., mining, forestry, etc.), it must be remembered that raw solid waste differs substantially from the raw materials that serve as feedstocks for other industries. The failure to take the difference into account, particularly in some industrialised nations, resulted in a number of operational problems at waste processing facilities. The problems arose in many cases from the use of equipment that was improperly applied, designed, or operated. After a lengthy period of learning, plant operators and designers now recognise the need for a thorough understanding of the operating parameters of each piece of equipment as they pertain specifically to solid waste. This need for specialised knowledge extends to a detailed familiarisation with the physical and chemical characteristics of the wastes [3].

G. Summary

RDF most certainly can be used in some coal-burning facilities that are (or can be) equipped with grates to accommodate complete combustion of the RDF and that are (or can be made) capable of handling the additional ash production. Of course, existing coal-fired combustion facilities would have to be modified to accept and store the RDF and to inject it into the combustion chamber.

An important prerequisite for the successful combustion of RDF in a combustion system, whether fired solely or in combination with another fuel, is the development of the proper fuel specification. The fuel specification should be provided to the RDF system designer by the supplier of the combustion system. The combustion system supplier should be knowledgeable regarding RDF and its materials handling and combustion characteristics, as well as with fuel handling systems, combustion systems, and air pollution control systems. Obviously, in practice, the required quantities and characteristics of the RDF must be reliably and consistently supplied by the RDF system to the combustion system.

The compatibility of the RDF with all of the applicable elements of the combustion system cannot be over emphasised. Additionally, for financial reasons, optimum performance of the combustion process and thermal conversion system is required. Therefore, the properties of the RDF must be carefully evaluated and selected. As noted above, these requirements and conditions apply in the case of a thermal conversion system dedicated to RDF and to co-firing situations with coal.

Pre-processing system design for RDF recovery in developing countries must take into account the composition of the wastes to be processed. Characteristics of particular relevance are moisture content and content of inert materials, such as ashes from domestic cooking and heating. These characteristics present some special, but not unsolvable, challenges to the design of technically and financially successful RDF facilities.

H. References

1. Diaz, L.F. and G.M. Savage, "Pretreatment Options for Waste-to-Energy Facilities", *Solid Waste Management: Thermal Treatment & Waste-to-Energy Technologies, VIP-53*, proceedings of International Technologies Conference, Washington, DC, USA, April 1995, Air & Waste Management Association, 1996.
2. Savage, G.M. and G.J. Trezek, "Screening Shredded Municipal Solid Waste", *Compost Science*, 17(1):7-11, January/February 1976.
3. Savage, G.M., "The History and Utility of Waste Characterization Studies", presented at Air & Waste Management Association 86th Annual Meeting & Exhibition, Denver, Colorado, USA, June 1993, *MSW Management*, 4(3):70-78, May/June 1994.
4. CalRecovery, Inc. and Midwest Research Institute, *Prediction of the Impact of Screening on Refuse-Derived Fuel Quality*, prepared for Electric Power Research Institute, EPRI Report No. FP-1249, November 1979.

CHAPTER XIII. INCINERATION AND THERMAL CONVERSION

This chapter describes thermal conversion systems used for solid waste management. For the purpose of the discussion, the chapter has been divided into two major sections – Incineration and Pyrolysis.

A. Incineration

A1. INTRODUCTION

The first attempts to dispose of urban refuse through combustion in a furnace are reported to have taken place in the north of England in the 1870s [1]. By the turn of the century, emphasis was placed on the development of furnaces capable of burning solid wastes. During this time, a number of communities found incineration to be a satisfactory and sanitary method of waste disposal. The reason for the satisfaction lay in the fact that the main objective was to achieve maximum volume or weight reduction. Little or no concern was had for energy recovery or for control of air pollution from incinerators. The situation changed completely in the 1960s in that the majority of incinerators in the United States were closed down, primarily because of excessive particulate emissions. However, the popularity of incineration continued undiminished in Western Europe and often was made to include energy recovery.

Throughout this chapter, the terms “incinerator” and “incinerator system” are used to describe equipment and systems that combust solid waste or fuels derived from solid wastes. Thus, as used herein, the above terms are synonymous with “combustor” or “combustion systems”. While, in earlier times, the term “incinerator” connoted uncontrolled combustion, the incinerators of today have a much higher degree of process control.

A2. PRINCIPLES

Incinerators may be classified in a variety of fashions: by type and form of the waste input; by the throughput capacity (with or without heat recovery); by the rate of heat production (for systems with energy recovery); by the state in which the residue emerges from the combustion chamber (e.g., slagging); and by the shape and number of furnaces (e.g., rectangular, multiple). The key system elements involved in the incineration of urban wastes are: 1) tipping area, 2) storage pit, 3) equipment for charging the incinerator, 4) combustion chamber, 5) bottom ash removal system, and 6) gas cleaning equipment (i.e., air pollution control system). If energy is to be recovered, a boiler is included.

Combustion air may be classified either as “underfire” or as “overfire” air. Underfire air is that which is forced into the furnace through and around the grates. Overfire air is forced into the furnace through the sides or the ceiling. Overfire air typically is introduced through jets located at specific points in the furnace. It is used to regulate and complete the combustion of combustible gases evolved by the thermal reactions that are occurring in the lower part of the furnace. The flow of air and combustion gases through the furnace can be controlled by means of forced draft and induced draft fans. The forced draft fan, as its name implies, forces air into the furnace, while the induced draft fan draws the air. Both types are used in modern combustion units. Forced draft fans provide for the central overfire and underfire air, and induced draft fans for the exhausting of the flue gases.

The furnace (i.e., combustion chamber) is the essential element of an incineration system. Types of furnaces include rectangular, cylindrical, and multi-chamber. The size and shape of a furnace

usually are determined by the manufacturer, and are based upon a number of parameters, including: solids and gas flow rates, residence time, combustion temperature, and depth of ash bed. In some cases, secondary combustion chambers are included as part of the design. They are connected to the primary chamber, and their main function is to provide the proper conditions needed to complete the combustion process.

Generally speaking, two types of solid residues are generated from incineration: 1) bottom ash, and 2) fly ash. The two residues collectively are known as “ash” and, in the case of industrialised nations, typically are equal to approximately 20% to 40% (by wt) of the incoming solid waste (besides the inherent ash content of MSW, fly ash can also contain additional mass by virtue of chemical reagents used to treat the inherent fly ash). Systems must be included in the facility design to handle and treat the two ash streams. Depending on conditions, the bottom ash and fly ash may be processed separately or in combination. The ash that is produced from incineration is hot and must be cooled prior to disposal. The normal method of cooling is quenching in water. After quenching, the ash is dewatered to facilitate storage or landfilling on the incinerator site or transport to a remote disposal site. Both the quench water and the ash must be treated and disposed properly.

Taken in combination, the grate system, bottom ash removal, and quenching and dewatering system compose the material handling system for the bottom ash. Historically, the bottom ash handling system has been one of the systems in an incineration facility that has experienced, and is particularly susceptible to, extraordinary wear and tear and frequent breakdowns.

Years ago, incinerators were designed to burn waste that had a low heating value. The reason was primarily to accommodate wastes with a high moisture content. Consequently, features were incorporated that were designed to: 1) dry and ignite the refuse, and 2) deodorise the off gases. Little or no waste heat was available for energy export. As the composition of municipal waste in industrially developed countries changed (i.e., substantial paper and plastic content, small putrescible fraction), the heating value of the solid waste increased. To accommodate the increase, the designers of modern incinerators include in their designs provision for the utilisation of excess energy. This is done by introducing a waste heat boiler for steam generation.

In industrialised nations, incineration systems must have complex air pollution control (APC) systems in order to meet the required limits for protecting the quality of the ambient air and human health. The complexity is a result of the fact that modern APC systems include provisions for controlling a number of pollutants to very low concentrations (e.g., parts per million or per billion). The provisions include control and manipulation of the combustion process itself within the combustion chamber and the use of post-combustion techniques, including the use of chemical reagents and of special mechanical and electrical systems to process the combustion gases [10]. The principal pollutants that are controlled in industrial countries are listed in Table XIII-1, along with the typical methods of control and levels of pollutant reduction. Because of their complexity, modern APC systems can account for up to 30% of the capital cost of incineration systems.

In the last 10 to 15 years, considerable research and development effort has been expended on “trace” air pollutants formed as byproducts of solid waste combustion, the relevant chemistry, and methods of control [14]. Examples of these trace pollutants are mercury, and dioxins and furans.

A3. TYPES of incinerators

Three types of incinerators, modular (small capacity, less than about 300 Mg/day), large-capacity stoker, and fluidised bed, are discussed in this chapter. (As will be described subsequently, a

stoker is a system of grates.) These three types of incinerators will satisfy the majority of applications of incineration (with or without heat recovery) that will exist in many of the developing nations for the next several years. Additionally, large-capacity stoker systems have been subdivided into two subtypes due to the different forms of solid waste that are combusted: 1) municipal solid waste, and 2) refuse-derived fuel.

Table XIII-1. Air pollutants from solid waste incineration and methods of control

Pollutant	Control Methods	Typical Reduction (%)
Oxides of nitrogen (NO ₂)	<ul style="list-style-type: none"> • Selective catalytic reduction • Selective non-catalytic reduction • Flue gas recirculation • Combustion control 	10 to 60
Acid gases (SO ₂ and HCl)	<ul style="list-style-type: none"> • Wet scrubber • Dry scrubber • Fabric filter • Electrostatic precipitator 	50 to 85 SO ₂ 75 to 90 HCl
Carbon monoxide (CO)	<ul style="list-style-type: none"> • Combustion control 	50 to 90
Heavy metals	<ul style="list-style-type: none"> • Dry scrubber • Fabric filter • Electrostatic precipitator 	70 to 95
Particulates	<ul style="list-style-type: none"> • Electrostatic precipitator • Fabric filter 	95 to 99.9
Toxic organics (including dioxins and furans)	<ul style="list-style-type: none"> • Combustion control • Combination of dry scrubber and fabric filter 	50 to 99.9

Source: Reference 10.

A3.1. Modular (small-capacity) incinerators

Modular combustion systems are so named because each combustion unit is of relatively low throughput capacity in comparison to the typical capacity of a massburn or RDF incinerator. As used here, a unit, or module, consists of one primary combustion chamber (i.e., a chamber in which the solid waste is converted to gaseous compounds). To achieve an equivalent processing capacity of a typical large-capacity, stoker-type massburn or RDF incinerator, multiple modules would be required; thus, the derivation of the term “modular” for this type and capacity of combustion technology.

The charging chamber of a modular incinerator is typically loaded by a front-end loader. Wastes are fed into the primary combustion chamber by a hydraulic ram. Wastes are moved through the primary combustion chamber of large-capacity modular incinerators by moving grates, usually reciprocating grates. A modular incinerator (with or without an energy recovery system) also has a separate, secondary combustion chamber dedicated to completing the combustion of the partially oxidised gases produced in the primary combustion chamber.

An illustration of a modular incinerator is shown in, and its key components are presented in, Figure XIII-1. A photograph of a modular incineration facility is shown in Figure XIII-2.

Modular units typically are designed to process up to about 300 Mg of waste per day. As mentioned earlier, the design of most modular incinerators includes a primary and a secondary combustion chamber and provides for the introduction of the air needed to attain complete combustion. Thus, sometimes they are termed “controlled air modular incinerators”.

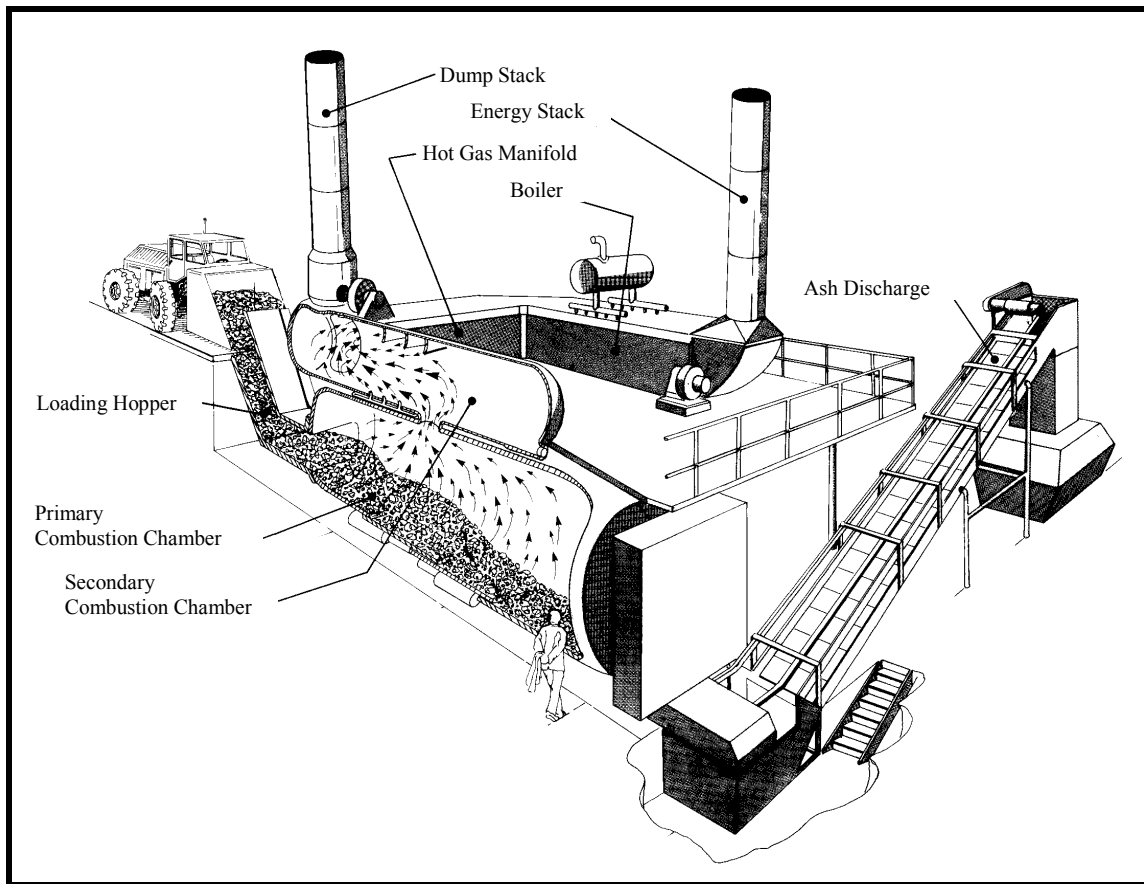

Figure XIII-1. Illustration of modular combustion unit used for residential and commercial MSW and for selected industrial wastes

Some designs also incorporate energy recovery equipment. The majority of modular incinerators usually can function quite well when burning commercial and industrial wastes. However, some designs and facilities have encountered an assortment of difficulties in processing unsorted municipal solid wastes. The difficulties usually presented themselves in the form of unreliable operation of the ash handling system and of unacceptably high wear-and-tear on the equipment. Small-capacity modular incinerators are commonly used to combust solid wastes from a single generator, e.g., a hospital (medical wastes) or manufacturing facility. Small modular incinerators that process a few Mg per day commonly are supplied as batch systems without provisions for automatic feeding of wastes or for ash removal.

A modular incinerator/steam production facility of moderate capacity for MSW can cost from US\$75,000 to US\$100,000 per Mg of daily capacity.

A3.2. Large-capacity stoker systems

A stoker is a system of grates that moves the solid fuel through the combustion chamber. A variety of types of stokers are available. Typically, the grates in large-capacity massburn incinerators are movable (vibrating, rocking, reciprocating, or rotating) to provide agitation to the wastes, thereby promoting combustion. The movement also serves to remove the residue from the furnace. The stoker commonly employed in large incinerators designed to combust RDF is a

“travelling” grate; a travelling grate consists of a set of hinged grate sections that are configured as a conveyor belt.

Two examples of stokers used in massburn incinerators are shown in Figure XIII-3. In the case of massburn systems, the primary combustion of the waste occurs on the grate.



Courtesy: CalRecovery, Inc.

Figure XIII-2. Modular combustion facility

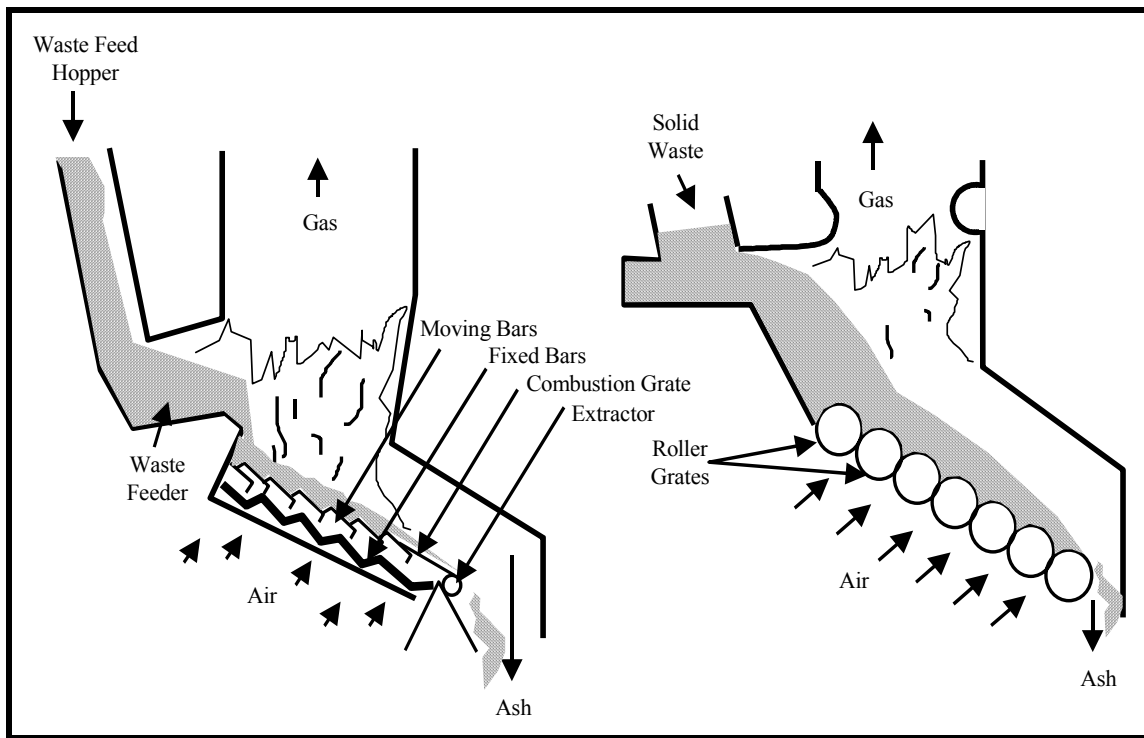

Figure XIII-3. Grate systems used in massburn MSW combustors

An example of a grate system for an incinerator designed to burn RDF is shown in Figure XIII-4. In the case of an RDF incinerator, a substantial portion of the combustion of the RDF occurs while the fuel is in suspension or falling toward the grate. Thus, only a portion of the combustion of the fuel occurs on the grate itself. In the case of all grate systems, air is introduced below the grate in order to: 1) cool the grate and, therefore, maintain the temperature of the grate below its maximum design temperature; and 2) provide a supply of combustion air to the waste burning on the grate (i.e., underfire air).

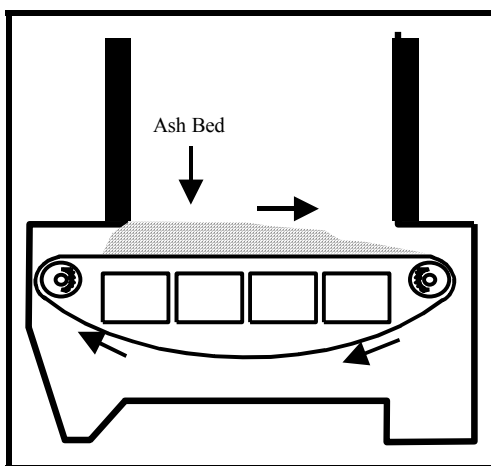

Figure XIII-4. Travelling grate system used in RDF-fired incinerators

Large-capacity stoker systems that combust raw MSW are commonly referred to as “massburn” incinerators. On the other hand, as the name implies, RDF combustion systems are designed to burn a combustible mixture of materials that is recovered from MSW. Another name commonly used to describe RDF is “prepared fuel”. The definition of two subtypes in the case of large-capacity stoker combustors is appropriate due to some important differences between the two types of feedstocks (i.e., raw MSW and RDF) with respect to combustion system design. Among

the more important distinctions, MSW has a lower heating value and higher ash content than would be exhibited by an RDF recovered from the same MSW. Other distinctions between MSW and RDF and between different qualities of RDF are discussed in Chapter XII, Production of Refuse-Derived Fuel.

A3.2.1. Massburn incinerators

In a typical massburn incinerator operation, the MSW to be burned is unloaded from the collection vehicles onto the tipping floor or directly into a storage pit. A pit is included so that sufficient solid waste can be stored to permit a continuous operation of the incinerator (i.e., 24 hr/day, 7 day/wk). The pit also serves as an area in which large non-combustible materials can be removed, and the wastes can be blended to achieve a fairly uniform and constant charge. From the pit, the waste is transported to a charging hopper. Charging hoppers are used for maintaining a continuous feeding of waste into the furnace. Massburn incinerators do not use pneumatic or mechanical systems for injecting or charging the waste into the combustion chamber. (Mechanical and pneumatic injection systems are typically used when RDF is the feedstock.) Wastes fall from the hopper onto the stoker (i.e., grate system) where the combustion takes place [2].

An illustration of a large-capacity massburn incinerator and its key components is shown in Figure XIII-5. A photograph of a massburn incinerator facility is shown in Figure XIII-6.

A modern massburn/electricity production facility having a capacity in the range of 800 to 2,500 Mg/day may cost approximately US\$90,000 to US\$135,000 per Mg of daily capacity.

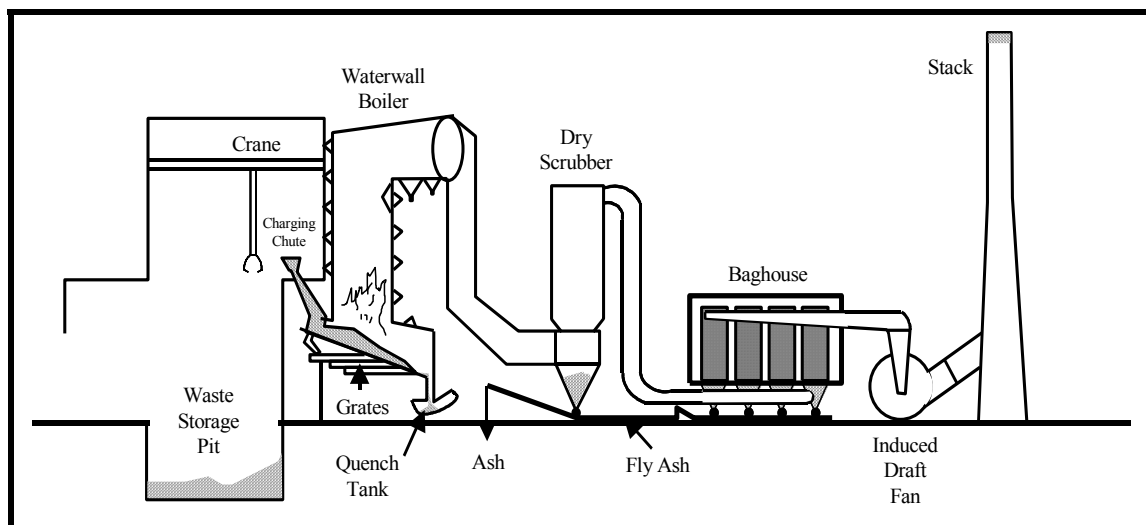

Figure XIII-5. Key Components of a massburn incinerator system with energy recovery



Courtesy: CalRecovery, Inc.

Figure XIII-6. Massburn combustion facility

A3.2.2. RDF-fired incinerators

Large RDF-fired incinerators are similar in overall design to massburn units. However, key distinctions exist between the designs. As mentioned previously, RDF incinerators usually have a travelling grate at the bottom of the furnace, as opposed to the agitating form of grates used in most massburn incinerators. Secondly, since RDF has a finer size distribution than raw MSW, the charging system is different. RDF combustion systems commonly employ a ballistic type of feeding system, i.e., the fuel is injected into the combustion chamber above the grate at a relatively high velocity using mechanical or pneumatic injection, or a combination of the two injection methods. On the other hand, as noted above, massburn incinerators are fed by gravity through a charging chute. An illustration of an RDF incinerator and its key equipment is presented in Figure XIII-7. A photograph of an RDF combustion facility is shown in Figure XIII-8.

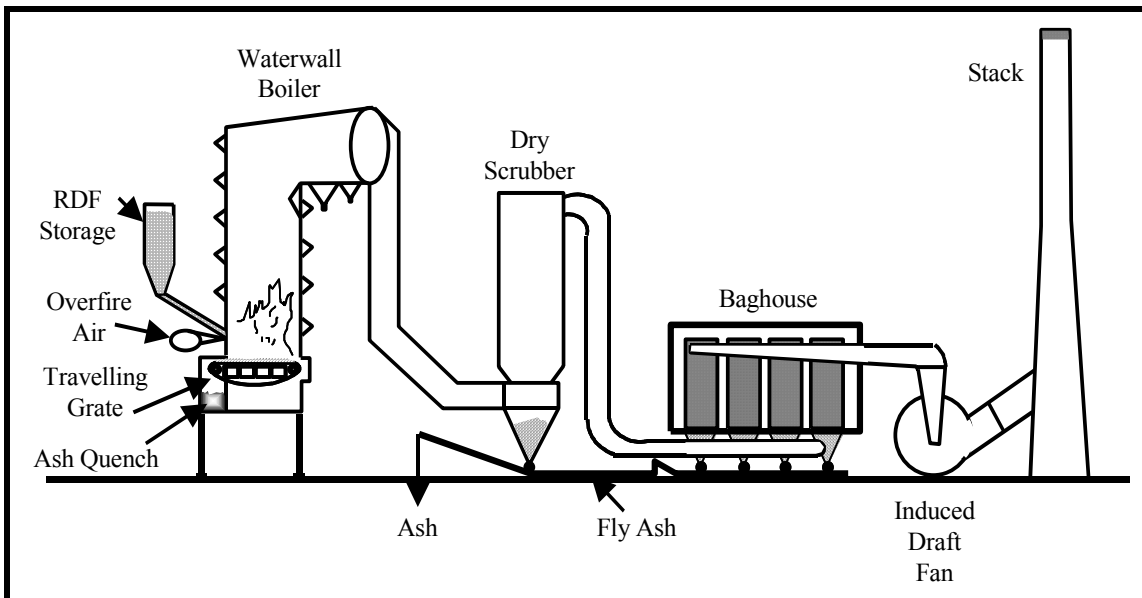

Figure XIII-7. Key features of a dedicated RDF incineration system with energy recovery



Courtesy: CalRecovery, Inc.

Figure XIII-8. RDF combustion facility

A modern RDF/electricity production facility, including pre-processing and combustion systems, with a capacity in the range of 1,000 to 2,000 Mg/day, can cost in the neighbourhood of US\$100,000 to US\$150,000/Mg/day.

A3.3. Fluidised Bed Incinerators

While fluidised beds can be used in pyrolysis (or thermal gasification) systems, which operate in oxygen-deficient conditions, their use in incineration systems under oxidising conditions only is discussed in this book. In a fluidised bed incinerator, the fuel, e.g., solid waste, is combusted within a chamber that contains a high temperature zone (i.e., bed) of a fluidised, granular, non-combustible medium, such as sand. The particles of the medium are suspended (fluidised) within the combustion zone through the nullification of the downward acting gravitational force by the upward acting aerodynamic lifting force that is imparted by the combustion air stream that is made to permeate the bed. The concept of the design is that complete or near complete combustion (i.e., no or little unburned carbon in the ash residue) of the solid fuel particles is facilitated by their intimate contact with many sites (i.e., grains of the medium) of high temperature and by the high surface-to-volume ratio. Also, because of this design concept, a particulate form of solid waste is the optimum. Thus, RDF is the usual form of solid waste that would be supplied to fluidised bed combustion units. For reasons of cost and for appropriate thermal characteristics, the optimum choice of medium is usually sand.

Fluidised bed (FB) combustion technology is appropriate for the efficient thermal conversion of a number of solid fuels, including coal. Consequently, the technology is suited for combustion of RDF, or for co-firing of RDF and coal. The experience with combustion of municipal solid waste in FB reactors is currently limited primarily to research and development; although, there is some limited commercial history as discussed below. As of this writing, most commercial fluidised bed conversion systems operate at approximately atmospheric pressure and combust coal or wood. Certain potential advantages have been offered for the operation of fluidised bed systems at elevated pressure (i.e., pressurised fluidised bed) as opposed to atmospheric pressure, such as higher thermal efficiency. However, commercial application of pressurised FB technology to combustion of solid waste is some years into the future. One reason is the problems attending the feeding of a solid waste feedstock into a system at elevated pressure [11].

Two basic types of fluidised bed designs are commercially available: bubbling bed and circulating bed. The main difference in the designs is the higher air supply velocity used in the circulating bed technology. As the name implies, in a circulating bed unit, the bed medium is captured from the high-velocity combustion gas stream exiting the combustion chamber and subsequently cleaned of ash particulates and recycled into the bottom of the bed zone. In a bubbling bed system, the gas velocities are maintained at a low level so that the bed medium is maintained in the combustion chamber. Circulating bed designs have an economic advantage over bubbling bed designs when the energy output requirements are greater than 45,000 kg steam/hr [12]. The majority of commercial fluidised bed systems combusting low-grade fuels are of the circulating bed design [13]. An illustration of a circulating fluidised bed system is shown in Figure XIII-9.

The interest in the use of FB technology for the combustion of solid waste stems from several factors: 1) the performance of the combustion process is relatively insensitive to the flow rate of the feedstock (i.e., it has a high turndown ratio); 2) compared to standard incinerators, the combustion temperatures are relatively low and, therefore, emissions of nitrogen oxides are subjected to inherent control during the combustion reaction; and 3) reagents in solid form can be incorporated among the inert bed particles and used to control acid gas emissions. These methods of control ease, but do not necessarily eliminate, the need for exhaust gas treatment in cases where low concentrations of pollutants are desired or required by regulation.

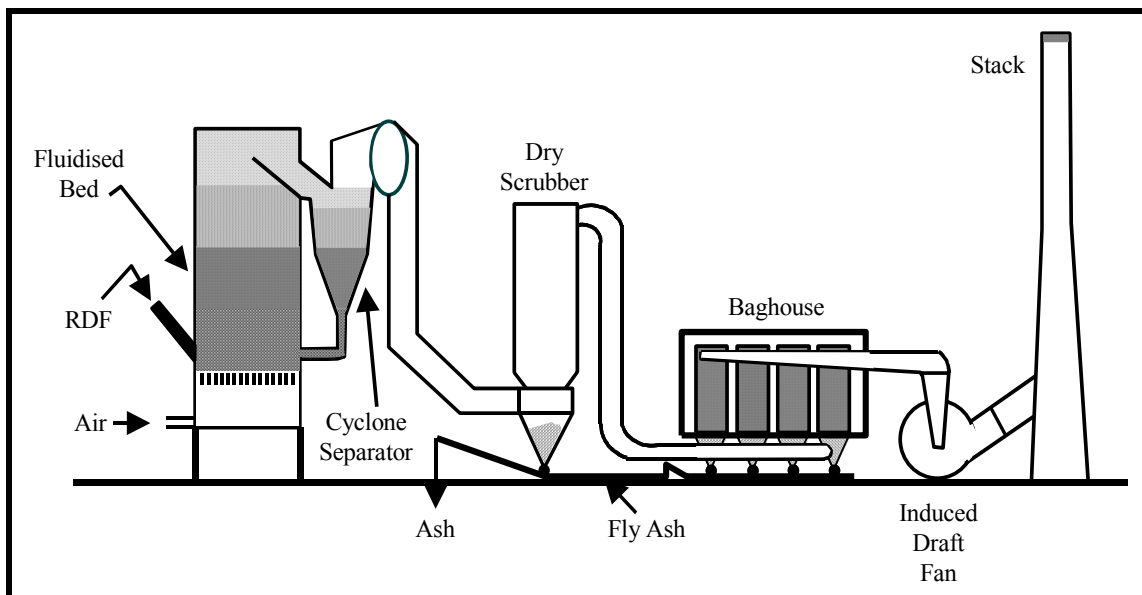

Figure XIII-9. Key features of an RDF-fired circulating fluidised bed combustion system with energy recovery

As mentioned earlier, the use of fluidised combustion for thermal conversion of solid waste has seen limited application in the past. The limited commercial applications have primarily combusted RDF and a supplemental fuel, e.g., sludge, coal, or wood. A limited resurgence of interest and application of combustion of RDF in dedicated fluidised bed combustors occurred in the United States in the mid 1990s.

For fluidised bed systems to be effective, the combustion conditions within the fluidised bed must be carefully controlled. As is the case with any type of combustion system, control is easiest to maintain continuously and effectively at the set point if the solid fuel is a homogeneous mixture (i.e., possesses uniform characteristics, e.g., composition, bulk density, and particle size). Homogeneity is especially important in the case of fluidised bed technology due to its particular sensitivity to fuel characteristics. In the case of this technology, RDF is not the optimum feedstock given its heterogeneity (i.e., non-uniformity of characteristics). On the other hand, one of the potential benefits of the fluidised bed is its ability to accommodate variations in fuel flow rate while maintaining a specified level of performance.

A modern RDF-fired fluidised bed/electricity production facility (pre-processing and combustion systems), with a capacity in the range of 800 to 1,000 Mg/day, can cost in the range of US\$135,000 to US\$190,000/Mg/day.

B. Pyrolysis

Pyrolysis is a process in which organic matter is broken down at high temperatures in the absence or near absence of oxygen into products that may be gaseous, liquid, or solid in form, or as a collection of all three forms. The system pressure influences the reaction and, therefore, the characteristics of the products of the reaction. Most of the products are organic and, therefore, combustible and are potential energy sources.

Strictly speaking, pyrolysis is the high-temperature thermal conversion of organic material in an environment devoid of oxygen. Two other thermal conversion processes are similar but not identical to pyrolysis: thermal gasification and liquefaction. Thermal gasification is a thermal conversion process that occurs in a high-temperature, sub-stoichiometric environment, i.e., insufficient oxygen is present in the reaction to convert all organic carbon to carbon dioxide.

Liquefaction is similar to thermal gasification. However, in the case of liquefaction, the reactions are shifted in favour of a high yield of liquid byproducts. Since the three processes have many similar characteristics, for the purpose of this discussion, they are lumped together under the term “pyrolysis”.

Pyrolysis differs from incineration in that it is an endothermic reaction and takes place in an oxygen-free or low-oxygen atmosphere. Because it is endothermic, a considerable amount of energy input is required to attain the high temperatures required to volatilise the organic compounds.

An interest in the pyrolysis of municipal solid waste began in the late 1960s. The interest was based on the reasoning that since municipal solid waste is typically at least 60% organic in nature, it should be a raw material well suited for pyrolysis. During the mid-1970s, the interest and the potential of pyrolysis as a method of producing energy reached their peak. As a consequence, a number of studies were conducted in the United States and in Europe, and a few were expanded to encompass the construction and operation of commercial-size demonstration plants. In the middle to late 1970s, a combination of technical problems and unfavourable economics associated with MSW pyrolysis resulted in a drastic lowering of the interest and expectations for the technology. The lack of interest persists as of this writing.

Certainly, the combination of technological difficulties and poor economics would make pyrolysis a dubious undertaking by a developing nation. Nevertheless, pyrolysis is described herein in order to provide the decision-maker with the background information required to arrive at a rational decision as to the advisability of using pyrolysis as a method of resource recovery. The most likely recoverable resource would be energy, at the time of this writing, but the potential of synthesis of chemical feedstocks, e.g., methanol, is not ruled out. Chemical feedstock recovery, although economically unfeasible at this time, is technically achievable.

B1. PRODUCTS

The gases produced are principally CO, CO₂, H₂, and water vapour. The liquids consist of pyrolytic oil, highly viscous tars, and oxygenated organics in water. The solids are collectively designated as “char”.

The quantity and composition of the products of pyrolysis are functions of the composition of the raw material (“input”, “charge”), and of the temperature and pressure applied in the process. The higher the temperature, the greater is the yield of gas, whereas that of the liquids and char is correspondingly less.

The relative concentrations of the three groups can also be altered by: 1) reforming through the use of oxidising reactants (e.g., air, water), or partial oxidation through the use of reducing agents (hydrogen, carbon monoxide) with a catalyst; 2) hydrogenation through the application of high pressures and supplying of H₂; and 3) altering the residence time.

The products of systems that depend upon reforming and partial oxidation are mostly gaseous in nature [3,4]. Hydrogenation reactions favour the production of either oil or methane. Oil is the predominant product if the process temperature is from 285° to 340°C; and the pressure is from 20,000 to 30,400 kN/m². Methane becomes the principal product if the temperature is held at 650°C and the pressure at 7,580 to 20,000 kN/m².

B2. TECHNOLOGY

In modern practice, the process typically is carried out in three principal stages -- namely, combustion, pyrolysis, and drying. The three stages usually take place simultaneously in the reactor. Thus, a part of the heat liberated in the combustion zone is used to “drive” the pyrolysis reaction and to dry the incoming material. Carbon dioxide given off during combustion is converted into CO in the zone of pyrolysis.

Currently, commercial MSW pyrolysis technology is not available in the marketplace. The closest available technology is that serving the coal and wood gasification industry. While large-scale coal and wood gasification systems are commercial, currently no pyrolysis systems are processing large quantities of municipal solid waste. In the 1970s, the technology of pyrolysis was typified by three proprietary systems -- namely, Andco-Torrax, Monsanto “Landgard”, and Union Carbide “Purox”. These three systems are described below.

B2.1. Andco-Torrax

The Andco-Torrax pyrolysis system was designed to convert the organic fraction of municipal solid waste primarily into a combustible gas, which, in turn, was to be burned to generate steam. The system consists of five major components: 1) air pre-heater, 2) gasifier, 3) secondary combustion chamber, 4) waste heat boiler, and 5) gas cleaning equipment [5].

In operation, raw solid waste is introduced at the top of the reactor (gasifier) by means of a reciprocating ram or a vibratory feeder. Essentially, the gasifier is a cylindrical column 12 to 15 m high and 1.8 to 2.7 m in diameter. As the waste descends from the top to the bottom of the reactor, it passes successively through drying, pyrolysis, and combustion zones. In the pyrolysis zone, the solid waste is heated from 278° to 1100°C, and converted, mostly into a combustible gas. The hot gases are discharged through the top of the gasifier, countercurrent to the incoming waste. Consequently, some of the energy in the gas is used to dry the incoming waste.

The energy required to dry and pyrolyze the waste is obtained from the combustion of the char in the combustion zone. The process results in the generation of high temperatures (up to 1590°C), as well as the transformation of the non-combustible matter into a molten slag. The slag is continuously removed through a slag tap and is discharged into a quenching pit.

The pyrolysis gases leave the reactor at about 400° to 500°C. The gaseous mixture has a heating value typically in the range of 3,730 to 6,340 J/L. From the gasifier, the gases are transported to the secondary combustion chamber where they are mixed with air and burned. The off gases from the secondary combustion chamber are directed to the waste heat boiler for the production of steam. The steam can be used for process heating or for generating electricity. Waste gas is transported to the gas cleaning system, which typically consists of a hot gas electrostatic precipitator.

The processing capacity of the Andco-Torrax units is about 300 Mg/hr.

Technical difficulties were encountered in the operation of five plants in Europe and the United States. Among the difficulties were “channelling” of the gas in the reactor, large slag flow rates, and excessive noise levels [6]. The process is reported to have achieved a weight reduction of 80% to 85% at an efficiency of 62% to 68% [5].

B2.2. Monsanto “Landgard”

The development of the “Landgard” system began in 1969 in the United States with the testing and evaluation of a 272 kg/day pilot plant in Dayton, Ohio. The plant was followed by the construction of a 32 Mg/day prototype plant in St. Louis County, Missouri [7]. Results from the tests and evaluations served as a basis for the design of a 907 Mg/day full-scale plant, which was erected in Baltimore, Maryland.

The Landgard process involves low-temperature pyrolysis of municipal organic solid wastes through partial oxidation with air.

Preparation of the raw waste involves shredding it to a nominal 10- to 12.5-cm particle size by using two 45 Mg/hr shredders. (No separation of inorganics from organics is attempted prior to introduction into the reactor.) The reactor is a horizontal rotary kiln lined with refractory material.

The thermal energy necessary to carry out the pyrolysis process is obtained by burning a portion of the solid waste along with No. 2 fuel oil. The temperatures within the reactor may rise as high as 535°C. As the pyrolysis off-gases are generated, they move countercurrent to the flow of solid waste and, thereby, in effect, dry the incoming waste before leaving the kiln. At the point of discharge, the temperature of the gas is about 630°C. The heating value of the gaseous mixture is about 2,800 to 3,700 J/L.

From the kiln, the gases are transported to an afterburner in which they are mixed with air and burned. The hot combustion products are introduced into waste heat boilers to generate steam, which is produced at a rate of about 90,700 kg/hr. The waste gases are passed through wet scrubbers, a mist eliminator, and a reheater prior to being exhausted into the atmosphere.

The inorganic matter is discharged from the kiln into a quenching tank, and then to a flotation unit, where it is separated into a light fraction and a heavy fraction. The light fraction, primarily carbon char, is thickened and filtered. The heavy fraction is conveyed past a magnet for the recovery of magnetic metals. The non-magnetic balance consists of a glass aggregate, intended to be used as an ingredient in paving mixes.

The Landgard system was plagued by a number of difficulties in the Baltimore operation, all of which led to the eventual closure of the plant. Among the problems were the failure of the refractory liner, an excessive concentration of particulate matter in the exhaust gas, and a constant plugging of the slagging opening in the afterburner.

B2.3. Union Carbide “Purox”

The Purox system was developed in the United States by the Linde Division of the Union Carbide Corporation in 1970 in Tarrytown, New York. The system was centred around a reactor having a capacity of about 4.5 Mg/day. After the evaluation of the pilot plant, a 180 Mg/day facility was designed and built in South Charleston, West Virginia. Construction was completed in 1974. The facility was intended to demonstrate the operation of a full-scale module.

The principal component of the Purox system is a vertical shaft reactor. Solid waste, either raw or processed, is introduced into the top of the furnace and via an airlock feeder. Simultaneously, pure oxygen is forced into the base of the column at the rate of about 0.2 Mg per Mg of solid waste. Char formed from the solid waste reacts with the incoming oxygen, generating temperatures on the order of 1370° to 1660°C. Gases formed in the reaction between the oxygen and the char ascend to the top of the retort, counter currently to the incoming waste. In the

process, the combustion of the gases supplies the energy required to drive the pyrolysis reaction. As the gases approach the top of the retort, they dry the incoming waste and, consequently, are further cooled to about 90°C. The off gas contains certain impurities that are removed in a gas cleaning system, which consists of an electrostatic precipitator, an acid absorption column, and a condenser. The fuel gas product has a heating value of about 11,190 J/L and has combustion characteristics similar to those of natural gas. An illustration of the Purox pyrolysis system is shown in Figure XIII-10.

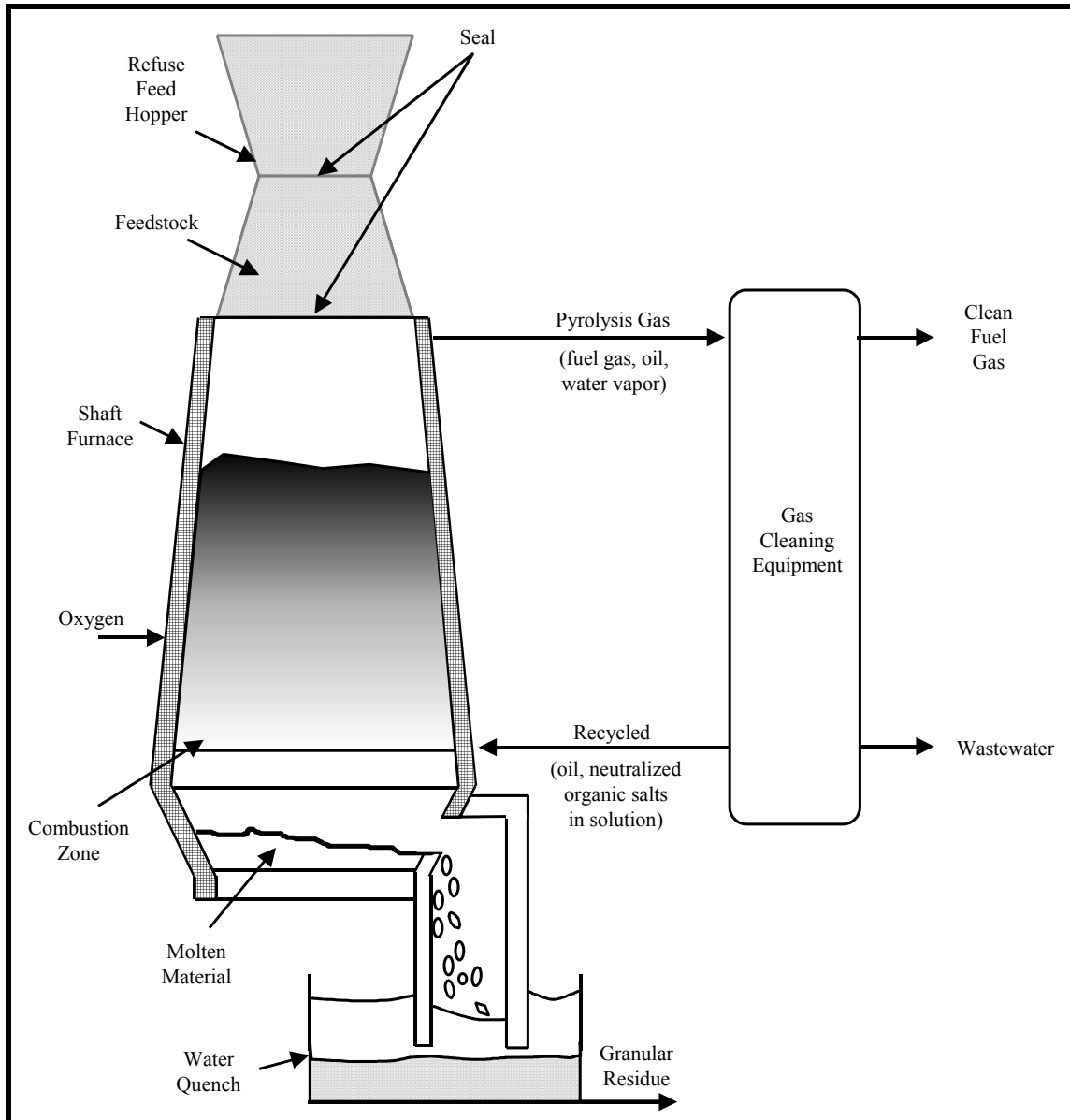

Figure XIII-10. Schematic of Purox® oxygen-fed pyrolysis system

Temperatures reached near the bottom of the reactor are sufficiently high to melt and fuse the inorganic components of the introduced wastes. The molten residue drains into a quench tank.

B3. PYROLYSIS-PRODUCED gas

B3.1. Potential uses

The potential uses of pyrolysis-produced gas (“syngas”) can be subdivided into usage in existing systems and possible use in systems under consideration for future energy needs. The

consideration of these two potentials has a significant bearing on the required composition, heating value, and purity of the gas.

Pyrolysis gas could be used by utilities and by large industrial energy users if the heating value and composition of the gas are compatible with existing combustion equipment. Ideally, compatibility would require that the gas have a heating value as close as possible to 37,000 J/L and have low concentrations of carbon monoxide (CO), hydrogen sulphide (H₂S), and hydrogen (H₂). Burning fuel gas that has a low heating value and high concentrations of CO, H₂S, and H₂ can lead to the development of a number of problems requiring equipment modifications and alternate distribution arrangements.

B3.2. Composition and heating value

In this section is discussed the compatibility and, hence, marketability of syngas with existing natural gas-fired burners. At the same time, other factors concerning gas composition, such as CO, H₂S, and N₂ content, have a bearing on the marketing aspects of a syngas. It should be noted that all questions of marketability in this discussion deal with technical considerations. Questions concerning the safe transmission and use of a syngas that contains a large amount of CO add a socio-political feature to the overall acceptance of syngas use.

From the standpoint of maximum heating value, syngas should contain as few non-combustible constituents as possible. Non-combustible components of typical syngas are N₂, O₂, and CO₂. The presence of these components dilutes the heating value of the gas and, consequently, reduces its marketability, other factors remaining equal. As shown by the data in Table XIII-2, systems that involve the use of air (i.e., of a combustion step) in the generation of energy to sustain the pyrolysis reaction (Andco-Torrax and Monsanto systems) produce a gas that contains a large percentage of N₂. (The gas from the Andco-Torrax system is 55% N; and that from the Monsanto, 69.3%.) Consequently, the heating values of these two syngases are low -- namely, 5,716 and 3,688 J/L, respectively.

Table XIII-2. Syngas composition from pyrolytic conversion of solid wastes

System	Gas Composition of Major Constituents (% dry basis)										Organic Vapour s	% of Total ^a	Average Heating Value (J/L)
	H ₂	CO	CO ₂	CH ₄	C ₂ H ₂	C ₂ H ₄	C ₂ H ₆	C ₆ H ₆	N ₂	O ₂			
Andco-Torrax	15.0	14.0	10.0	3.0	NR ^b	NR	1.0	NR	55.0	2	NA ^c	100.0	5,716
Monsanto Landgard	6.6	6.6	11.4	2.8	NR	1.7	NR	NR	69.3	1.6	NA	100.0	3,688
Union Carbide Purox	24.0	40.0	25.0	5.6	0.7	2.1	0.3	0.3	0	0	0.15	98.15 ^d	11,370

^a Percent of major constituents in total syngas composition.

^b NR = non-reported.

^c NA = not available.

^d C₃H₆ (0.3), C₃H₈ (0.2), C₄ (0.5), C₅ (0.4), C₇H₈ (0.1), C₆₊ (0.2), H₂S (0.05), and CH₃OH (0.1) are the remaining 1.85 of the Purox pyrolysis gas.

On the other hand, the fuel gas produced by the Union Carbide (Purox) process has a heating value of 11,370 J/L. Air is not introduced into the pyrolytic reactor vessel in the Purox system. Consequently, the heating value of its gas product is substantially higher than that of the others.

From an operational point of view, the use of gaseous fuels having a heating value less than 7,460 J/L is attended by technical problems. The problems result from using a burner, or boiler, or both,

designed and optimised specifically to burn 39,000 J/L natural gas, 44,200 J/L fuel oil, or 28,000 J/g coal and trying to substitute a gaseous fuel of lower heating value. If syngas of less than 7,460 J/L is substituted into an existing fossil fuel system, the overall operation of the burner/boiler heat recovery system is reduced to undesirable levels [8,9]. The use of low heat-value syngas would have to be limited to burners and boilers specifically designed to burn it. Systems providing less than 7,460 J/L gas would involve a capital investment lower than that required for producing gases that have heating values in the 10,000 to 19,000 J/L range. The capital cost for the latter is higher by reason of the additional equipment or processes involved in providing pure oxygen for the pyrolysis reaction (e.g., Union Carbide system).

B3.3. Process yield

The net yield (kJ/Mg of solid waste) determines the plant size required for meeting a given energy demand. Here, net yield is taken as the useful energy net output from the pyrolysis plant (i.e., after the extraction of energy for in-plant use and for process losses) divided by the quantity of solid waste received at the plant gate. The net yields expressed in MkJ/Mg of solid waste for the three pyrolysis systems discussed here are estimated as follows: Andco-Torrax 9.63; Monsanto, 9.24; and Union Carbide, 7.56. The system with the highest net yield will produce the greatest amount of useful energy from a given quantity of solid waste. The average yield of the three systems is 8.47 MkJ/Mg of waste.

B3.4. Upgrading syngas quality

Upgrading syngas involves one of two approaches: The first approach is to convert the syngas to pipeline quality gas, i.e., approximately 33,600 J/L. A number of different conversion processes are available through which a syngas can be converted to pipeline quality. The second approach is to increase the gas heating value, but not to pipeline quality. The second alternative results in a gas that has heating values in the range of 5,600 to 21,300 J/L. The relative merits of either approach depend upon certain technical and economic considerations. The added cost for syngas improvement must be weighed against the additional revenue gained by improving the gas quality. Since improved syngas quality will usually increase the marketability of the product, the degree of cleanup is germane to economic feasibility.

From an operating and safety standpoint, converting syngas to pipeline quality gas, i.e., synthetic natural gas (SNG), is preferable since to do so would result in minimising the CO and H₂S problems. The objective would be to produce a synthetic natural gas (34,500 J/L) from solid waste that could be injected into the natural gas network of a utility. In certain areas, however, the operation and interconnections of the transmission and distribution systems may be so complex that the injection of SNG would result in a reduction in heating value in excess of allowable variations.

Another approach to syngas quality improvement could involve the removal of CO₂, N₂, and even of H₂ should cleanup prove to be technologically and economically feasible. CO₂ and N₂ may be removed to improve the overall heating value of the syngas. On the other hand, H₂ may be removed to improve burner performance or to produce H₂ gas for sale.

C. Precautions

Some important lessons have been learned with regard to thermal conversion systems in general that combust processed or unprocessed municipal solid waste. These lessons and their ramifications should be considered when designing, evaluating, or implementing solid waste-fired thermal conversion processes. Experience has shown the following, listed in no particular order of priority.

- If air pollutant emissions must be controlled to very low levels, such as those established in Europe, Japan, and the United States, then process control must be exercised from the point of fuel delivery to the points of discharge of ash, wastewater, and combustion gases. The upshot is that costly and complex pollution control systems will be required and the system will have to be operated and maintained continuously.
- Inattention to the characteristics, quantities, and material handling of ash will probably result in low availability of the ash handling system. The design of ash handling systems must include an analysis of the fuel characteristics, of the effect of the combustion process on ash formation, and of the proper types of equipment for ash treatment and handling.
- The composition and quantities of the waste must be adequately estimated over the lifetime of the thermal conversion project. If recycling of materials is planned, the design of the thermal system must take the changes in composition and availability of the fuel into account.
- Material handling of unprocessed MSW and of prepared fuels (i.e., RDF) is an area that has proven to be highly susceptible to oversights during design and operation. Instances that require special attention include replacement, conversion, or adaptation of existing coal-fired material handling systems to accommodate RDF if co-firing of coal and RDF is planned for an existing coal-fired combustion system. Such modifications obviously must be accounted for in the determination of the overall cost of the energy production system.

D. References

1. Goodrich, W.F., *The Economic Disposal of Towns Refuse*, P.S. King and Son, London, England, 1901.
2. Weinstein, N.J., "Municipal-Scale Thermal Processing of Solid Wastes", EPA/530/SW-1330, prepared for U.S. Environmental Protection Agency, 1977.
3. Shuster, W.W., *Partial Oxidation of Solid Organic Wastes*, Final Report, Bureau of Solid Waste Management SW-7RG, 1970.
4. Groner, R.R., et al., "The Chemical Transformation of Solid Wastes", AICHE Symposium Series 68(122):28-39, 1972.
5. Davidson, P.E. and T.W. Lucas, "The Andco-Torrax High-Temperature Slagging Pyrolysis System", *Solid Wastes and Residues - Conversion by Advanced Thermal Processes*, ACS Symposium Series 76, 1978.
6. Mark, S.D., D. Bohn, and C. Melan, "Recent Developments in a Slagging Process for Conversion of Refuse to Energy", *Proceedings from the International Recycling Congress*, Berlin, West Germany, 1979.
7. Levy, S.J., "Pyrolysis of Municipal Solid Waste", *Waste Age*, 5(4):14-20, October 1974.
8. Murray, R.H., "Low Btu Gas for Industrial Fuels Market", presented at Symposium on Commercialization of Synthetic Fuels, American Chemical Society, Colorado Springs, Colorado, USA, February 1976.
9. Frendberg, A.M., "Performance Characteristics of Existing Utility Boilers When Fired with Low Btu Gas", EPRI Symposium, "Power Generation Clean Fuels Today", Monterey, California, USA, April 1974.

10. Savage, G.M., D.L. Bordson, and L.F. Diaz, "Important Issues Related to Air Pollution at Municipal Solid Waste Facilities", presented at 25th Annual Governmental Refuse Collection and Disposal Association (GRCDA) Conference in St. Paul, Minnesota, USA, August 1987, *Environmental Progress*, 7(2):123-130, May 1988.
11. Bonk, D.L., H.M. McDaniel, M.R. De Lallo, Jr., and R. Zaharchuk, "Performance Analysis of Co-Firing Waste Materials in an Advanced Pressurized Fluidized-Bed Combustor", *Solid Waste Management: Thermal Treatment & Waste-to-Energy Technologies*, VIP-53, proceedings of International Technologies Conference, Washington, DC, USA, April 1995, Air & Waste Management Association, 1996.
12. Murphy, M.L., "Using Fluidized Bed Boilers for Burning Refuse-Derived Fuel", *Solid Waste Technologies*, VIII(5):34, September/October 1994.
13. Chang, Y., J. Kang, and C. Ho, "Circulating Fluidized Bed Incineration of Industrial Solid Wastes", *Waste Management & Research*, 10:357-369, 1992.
14. Niessen, Walter R., *Combustion and Incineration Processes*, Third Edition, Marcel Dekker, New York, New York, 2002.

Part III

Final Disposal

CHAPTER XIV. SANITARY LANDFILL

A. Introduction

Left unmanaged and uncontrolled, solid wastes openly dumped on the land: 1) generate liquid and gaseous emissions (leachate and landfill gas) that can pollute the environment, and 2) represent a breeding ground for disease-bearing animals and microorganisms. Other risks to the public health and safety and to the environment are also posed by the uncontrolled land disposal of solid wastes.

Sanitary landfilling, which is the controlled disposal of waste on the land, is well suited to developing countries as a means of managing the disposal of wastes because of the flexibility and relative simplicity of the technology. Sanitary landfilling controls the exposure of the environment and humans to the detrimental effects of solid wastes placed on the land. Through sanitary landfilling, disposal is accomplished in a way such that contact between wastes and the environment is significantly reduced, and wastes are concentrated in a well defined area. The result is good control of landfill gas and leachate, and limited access of vectors (e.g., rodents, flies, etc.) to the wastes [1-3]. The practice of sanitary landfilling, however, should be adopted in accordance with other modern waste management strategies that emphasise waste reduction, recycling, and sustainable development.

Currently, the implementation and practice of sanitary landfilling are severely constrained in economically developing countries by the lack of reliable information specific to these countries, as well as by a shortage of capital and properly trained human resources. This chapter attempts to partially fulfil the need for information by including explanations and descriptions of technologies and procedures proven appropriate in practice. There are explanations of underlying principles and directions for putting the technologies into practice. The chapter provides basic information for designing and implementing a well engineered sanitary landfill. Emphasis is placed on technologies and operating practices that generally are available to, and compatible with, conditions in economically developing nations. The coverage is sufficiently broad to encompass the conditions that are characteristic of the relatively high levels of industrialisation that are found in many of the large metropolitan areas, as well as those that are characteristic of the conditions of the less industrialised communities, both large and small.

B. Basic principles

B1. DEFINITION

All definitions of “sanitary landfill” call for the isolation of the landfilled wastes from the environment until the wastes are rendered innocuous through the biological, chemical, and physical processes of nature. Major differences between the various definitions are in the degree of isolation and means of accomplishing it, as well as in the requirements for monitoring and closing the fill and in maintaining the fill after its active life. In industrialised nations, the degree of isolation required usually is much more complete than would be practical in developing nations. Not surprisingly, the means of accomplishing the high degree of isolation in developing nations are complex and expensive.

In order to be designated a sanitary landfill, a disposal site must meet the following three general but basic conditions: 1) compaction of the wastes, 2) daily covering of the wastes (with soil or other material) to remove them from the influence of the outside environment, and 3) control and prevention of negative impacts on the public health and on the environment (e.g., odours,

contaminated water supplies, etc.). However, meeting all specific aspects may be technologically and economically impractical in many developing countries. Therefore, the short-term goal should be to meet the more important aspects to the extent possible under the existing set of technical and financial circumstances. The long-term goal should be to eventually meet all of the specific aspects of the design and operating conditions. Only when a fill meets all of the specific conditions will all of the benefits associated with a sanitary landfill be realised. The most important condition is the prevention of negative impacts on public health and the environment. The basic design and operating aspects of a sanitary landfill in terms of routes of impact outside the fill and of meeting the three basic conditions are illustrated in Figure XIV-1.

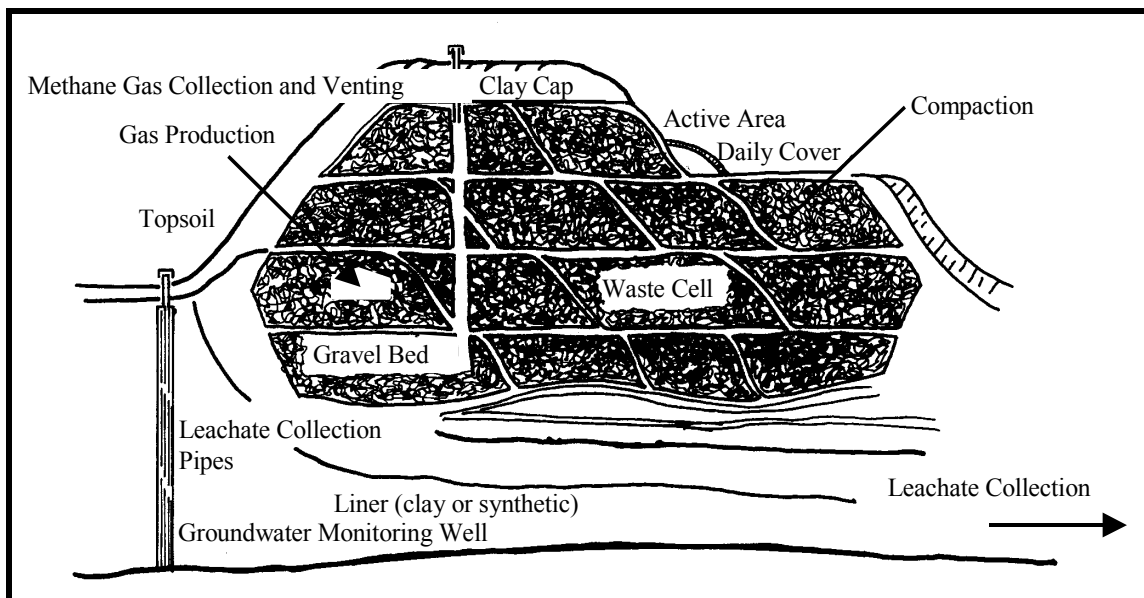

Figure XIV-1. Schematic diagram of basic aspects of a sanitary landfill

B2. PLANNING for a landfill

For this chapter, planning involves the collection of information on type, amount, generation rate, and characteristics of the wastes to be accepted for landfilling. Acquisition of this information is a prerequisite to rational design and efficient and effective development of a landfill. For example, knowledge of the composition of the waste stream destined for landfilling leads to an awareness of possible opportunities for recycling or reuse of certain constituents of the waste stream. Indeed, it should be noted that the underlying assumption is that reduction and recycling are the preferred courses of action, and that landfilling is indicated only when reduction and recycling are unfeasible, and is intended for the residue left after recycling.

C. Landfill processes

Physical, chemical, and biological processes are discussed in this section. Of the three types, the biological processes probably are the most significant. However, the biological processes are strongly influenced by the physical and chemical processes. The last part of this section considers some of the consequences of the three types of processes.

C1. PHYSICAL

In general, significant physical reactions in the fill are in one of three very broad forms: compression (compaction), dissolution, and sorption. Because settlement is an invariable accompaniment of compression, the two usually are discussed together. Similarly, dissolution and

transport are closely associated phenomena, although not to the same degree as compression and settlement. All components of the buried fill are subjected to the three processes.

Compaction is an ongoing phenomenon that begins with compression and size reduction of particles by the compacting machinery and continues after the wastes are in place. The continuing compression is due to the weight of the wastes and that of the soil cover (burden). Sifting of soil and other fines is responsible for some consolidation. Settling of the completed fill is an end result of compression. This settling is in addition to the settlement brought about by other reactions (e.g., loss of mass due to chemical and biological decomposition).

The amount of water that enters a fill has an important bearing on physical reactions. Water acts as a medium for the dissolution of soluble substances and for the transport of unreacted materials. The unreacted materials consist of animate and inanimate particulates. Particle sizes range from colloidal to several millimetres in cross-section.

In a typical fill, the broad variety of components and particle sizes of the wastes provides conditions that lead to an extensive amount of adsorption, which is the adhesion of molecules to a surface. Of the physical phenomena, adsorption is one of the more important because it brings about the immobilisation of living and non-living substances that could pose a problem if allowed to reach the external environment. It could play an important part in the containment of viruses and pathogens and of some chemical compounds. Adsorption does have its limits, one of which is its questionable permanency. One or several factors can alter permanency. For example, it can be altered by the effect of biological and chemical decomposition on adsorption sites.

Absorption is another of the physical phenomena that takes place in a fill. It is significant in large part because it immobilises dissolved pollutants by immobilising the water that could transport them and suspended pollutant particulates out of the confines of the fill. Absorption is the process whereby substances are taken in by capillarity. Most of the absorption potential of landfilled municipal waste is attributable to its cellulosic content. However, it should be recognised that, excepting fills located in arid regions, eventually all absorbent material in a fill becomes saturated. Consequently, absorption may be regarded as being only a delaying action as far as pollutant release is concerned.

C2. CHEMICAL

Oxidation is one of the two major forms of chemical reaction in a fill. Obviously, the extent of the oxidation reactions is rather limited, inasmuch as the reactions depend upon the presence of oxygen trapped in the fill when the fill was made. Ferrous metals are the components likely to be most affected.

The second major form of chemical reaction includes the reactions that are due to the presence of organic acids and carbon dioxide (CO₂) synthesised in the biological processes and dissolved in water (H₂O). Reactions involving organic acids and dissolved CO₂ are typical acid-metal reactions. Products of these reactions are largely the metallic ions and salts in the liquid contents of the fill. The acids lead to the solubilization and, hence, mobilisation of materials that otherwise would not be sources of pollution. The dissolution of CO₂ in water deteriorates the quality of the water, especially in the presence of calcium and magnesium.

C3. BIOLOGICAL

The importance of biological reactions in a fill is due to the following two results of the reactions:

1. The organic fraction is rendered biologically stable and, as such, no longer constitutes a potential source of nuisances.
2. The conversion of a sizeable portion of the carbonaceous and proteinaceous materials into gas substantially reduces the mass and volume of the organic fraction.

At this point, it should be remembered that a fraction of the nutrient elements in the waste is transformed into microbial protoplasm. Eventually, this protoplasm will be subject to decomposition and, hence, it makes up a reservoir for breakdown in the future.

The wide variety of fill components that can be broken down biologically constitute the biodegradable organic fraction of MSW. This fraction includes the garbage fraction, paper and paper products, and “natural fibres” (fibrous material of plant or animal origin). Biological decomposition may take place either aerobically or anaerobically. Both modes come into play sequentially in a typical fill, in that the aerobic mode precedes the anaerobic mode. Although both modes are important, anaerobic decomposition exerts the greater and longer lasting influence in terms of associated fill characteristics.

C3.1. Aerobic decomposition

The greater part of decomposition that occurs directly after the wastes are buried is aerobic. It continues to be aerobic until all of the oxygen (O_2) in the interstitial air has been removed. The duration of the aerobic phase is quite brief and depends upon the degree of compaction of the wastes, as well as the moisture content since the moisture displaces air from the interstices. Microbes active during this phase include obligate as well as some facultative aerobes.

Because the ultimate end products of biological aerobic decomposition are “ash”, CO_2 , and H_2O , adverse environmental impact during the aerobic phase is minimal. Although intermediate breakdown products may be released, their amounts and contribution to pollution usually are small.

C3.2. Anaerobic decomposition

Because the oxygen supply in a landfill soon is depleted, most of the biodegradable organic matter eventually is subjected to anaerobic breakdown. This anaerobic decomposition is biologically much the same as that in the anaerobic digestion of sewage sludge. Microbial organisms responsible for anaerobic decomposition include both facultative and obligate anaerobes.

Unfortunately, the breakdown products of anaerobic decomposition can exert a highly unfavourable impact on the environment unless they are carefully managed. The products can be classified into two main groups: volatile organic acids and gases. Most of the acids are malodorous and of the short-chain fatty-acid type. In addition to chemical reactions with other components, the acids serve as substrates for methane-producing microbes.

The two principal gases formed are methane (CH_4) and CO_2 . Gases in trace amounts are hydrogen sulphide (H_2S), hydrogen (H_2), and nitrogen (N_2). Landfill gas production, management, and recovery are discussed in another section.

C3.3. Environmental factors

The nature, rate, and extent of biological decomposition in a fill are greatly influenced by the environmental factors that affect all biological activities. The nature of biological decomposition

determines the nature of the decomposition products. Among other things, rate determines the length of time during which the completed fill must be monitored and which must pass before the “reclaimed” area (i.e., completed fill) can be put to use -- whether it be for recreation, agriculture, construction, or other purposes.

One of the ways in which decomposition affects use of the completed fill is through its effect on the rate and amount of settlement (reduction in elevation), in that settlement is a major constraint on the use of the completed fill. Settling continues until biological decomposition has run its course. Therefore, the higher the rate of decomposition, the sooner the site can be put to use. Both research and demonstration studies have been performed over the past 5 to 10 years to accelerate biological decomposition of landfilled waste.

The principal factors that influence biological decomposition in a conventional fill are moisture, temperature, and the microbial nutrient content and degree of resistance of the waste to microbial attack. Moisture is a limiting factor in a fill at moisture content levels of 55% to 60% or lower, because microbial activity is increasingly inhibited as the moisture drops below the 55% level. For practical purposes, it ceases at 12%. Therefore, decomposition can be expected to proceed very slowly in fills located in arid regions.

The activity of most microbes increases with rise in temperature until a level of about 40°C is reached. For some types of microbes, the upper temperature is on the order of 55° to 65°C. Because temperatures in tropical regions are more favourable, decomposition can be expected to proceed more rapidly and to a greater extent in those regions.

With respect to nutrients, wastes characterised by a high percentage of putrescible matter approach the ideal in terms of decomposition. Among the wastes that fall into such a category are green crop debris, food preparation waste, marketplace produce waste, and animal and human manures. It is likely to find such a combination of ideal decomposition factors in developing countries in humid tropical regions of the world.

C4. IN-PLACE density and settlement

C4.1. Density

Representative densities of raw wastes are discussed in another section. Among the factors that determine or influence in-place density (i.e., density after the wastes have been deposited and compacted in the fill) are composition of the wastes and operational procedures. Progressive settlement of the entire mass of the fill occurs as a consequence of decomposition and weight of overburden.

Because of the effect of settlement, increase in density becomes a continuing phenomenon. The in-place density of a properly operated, relatively deep fill can be on the order of 900 kg/m³; whereas that of a poorly compacted fill would be only about 300 kg/m³. In the United States, the usual range of density directly after compaction is on the order of 475 to 712 kg/m³ [31].

C4.2. Settlement

Settlement is manifested by a decrease in volume of the affected mass and subsequent reduction in elevation. For several reasons, the drop in elevation is not uniform throughout the fill. The lack of uniformity may be a serious constraint on the use of the completed fill. Undoubtedly, the greater the organic fraction and the deeper the fill, the greater will be the extent of settling. Rate of settling depends in large part upon that of the decomposition of the wastes and, hence, upon the factors that affect decomposition.

Because of the variations in the above factors and wide differences between operational procedures encountered in sanitary landfill practice, it is not surprising that a similarly wide variation exists between reported rates and the extent of settlement. Of the total settling, usually about 90% takes place during the first year [31]. In arid regions, settlement may be only 3% after three years, while that in subtropical regions may be as much as 20% after the first year. A.C. Cheney [32] indicates that whereas no physical settlement may occur if the initial density exceeds $1,060 \text{ kg/m}^3$, nevertheless a theoretical settlement of 40% due to waste decomposition is possible. However, he points out that with placement densities between 650 and $1,200 \text{ kg/m}^3$, annual rates of 0.55% to 4.7% have been measured.

D. Types of solid wastes

D1. SIGNIFICANCE of waste types

The type of solid waste to be disposed is an important consideration in the design of a sanitary landfill. Generally, sanitary landfills are considered to be land disposal facilities that receive solid wastes from residential, commercial, and industrial sources. The quantities and characteristics (e.g., composition, etc.) of the solid waste define the general procedures to be employed in the landfill operation. Furthermore, the type and composition of the wastes buried in the fill affect the quantity and composition of leachate generated and of the gases generated within the fill. Other considerations related to types of solid waste that affect the design and operation of landfills include the risks and hazards to personnel arising from the corrosivity, severe toxicity, or other dangerous property had by a particular waste.

D2. ACCEPTABLE wastes

Most solid wastes generated by residential, commercial, industrial, and agricultural sources may be disposed in a sanitary landfill of modern design without necessarily directly or indirectly endangering the well being of the public and the quality of the environment. For convenience of reference, such wastes are referred to as “acceptable wastes”. In contrast, many types of industrial process wastes (as opposed to the wastes generated in the offices of industrial facilities) should not be disposed in sanitary landfills but should be handled in specially designed landfills. These wastes are referred to as “unacceptable wastes”. Wastes that are unacceptable should receive special evaluation to assess the particular risks associated with their disposal.

With very few exceptions, only those wastes for which a given facility has been specifically designed should be accepted by that facility. An exception might be a waste that has been shown to fit within the existing or appropriately modified design capacity of the facility and that has the appropriate biochemical characteristics. Unfortunately, in many of the poorer developing nations, separation of wastes into acceptable and unacceptable categories is not practiced, nor is separation feasible in the foreseeable future. In many developing countries, circumstances are likely to be such that the only feasible course of action to gain some degree of control over land disposal is to accept all solid wastes without exception. The very act of removing the wastes from the open environment and placing them in a controlled land disposal facility would represent an advancement over the indiscriminate disposal practices currently in existence.

Dewatered solids (i.e., sludges or, synonymously, biosolids) from municipal wastewater treatment plants and water supply treatment plants (excepting raw sludge) can be regarded as being acceptable wastes.

D3. UNACCEPTABLE wastes

Ideally, the decision as to which wastes are to be deemed unacceptable should be made during the planning process, should be made jointly by the responsible governmental agency and the disposal site designer and operator, and should take into account the results of surveying large waste generators (in particular, industrial waste generators) in terms of the quantities and characteristics of their wastes. The wastes should be identified in the landfill development plans and frequent users of the disposal facility should be provided with a list of such wastes. Criteria recommended for use in decisions regarding acceptability should include the hydrogeology of the site; the chemical and biological characteristics of the waste; availability of alternative methods for disposal, reuse, or recycling; environmental risks; and the risks to the health and safety of the operating personnel and to the public.

Wastes that should require specific approval of the responsible government agency for acceptance at the disposal site should include those that are legally defined as “hazardous waste” or wastes that contain materials that are defined as “hazardous materials” -- medical wastes, bulk liquids and semi-liquids, sludges containing free moisture, highly flammable or volatile substances, raw animal manures, septic tank pumpings and raw sludge, and industrial process wastes. It should be noted that some animal wastes may be infectious because they contain animal disease organisms that can be transmitted to humans.

The United States Environmental Protection Agency (EPA) promulgated a definition of “hazardous waste” that is appropriate for industrialised and developing nations. According to the definition, a waste is hazardous if it poses a substantial present or potential hazard to human health or living organisms because: the waste is non-degradable or persistent in nature, it can be biologically magnified, it can be lethal, or it may otherwise cause or tend to cause detrimental cumulative effects [4].

D4. SPECIAL wastes

There are several types of wastes that are commonly termed “special wastes”, as previously introduced and discussed in Chapter II. Of these, medical (infectious) wastes and various types of sludges are commonly generated and disposed on the land in developing nations, and therefore, should receive special attention. Quantities of other types of special wastes will be considerably reduced through extensive scavenging and recycling activities characteristic of developing nations. Some of these wastes include institutional wastes, construction and demolition debris, animal manures, and animal carcasses.

E. Quantity and composition of the wastes

The need for conducting a reliable waste characterisation program (accurate determination of generation rates and composition) arises from the fact that rational planning and sound decision-making in solid waste management depends upon access to accurate and representative data regarding generation rates and composition. Unfortunately for planners and decision-makers, the quantity and composition of urban wastes vary not only from country to country, but also from city to city and even from neighbourhood to neighbourhood within a city [5,6].

Descriptions of the procedures that can be used to determine the quantity, composition, and other characteristics of the wastes are presented in Chapter III.

F. Site selection

F1. INTRODUCTION

The location and characteristics of the site will determine the extent and nature of the impact of a sanitary landfill on public health and the quality of the surrounding water, air, and land resources. Among the adverse effects that can be substantially limited or even avoided through proper siting of a fill are: 1) pollution of air, water, and soil resources with chemicals, gases, and organisms introduced or generated by landfilled wastes; and 2) a reduction of the aesthetic quality and monetary value of adjacent properties. Even with the best design, it is very difficult to completely isolate all natural resources from the contaminants and from the impacts that are mentioned in the following paragraphs. Since this is the case, selection of the best possible site becomes an extremely important matter. A prerequisite to the selection is the ability to determine which of the available sites most closely meets all criteria demanded by a “best possible site” [7]. Another factor that must be considered is the ownership and tenancy of land.

Site selection, particularly in the densely populated urban and suburban areas of industrialised countries, has become a highly contested socio-political process. A typical procedure for selecting a site either at the regional or local level in an industrialised country involves the identification of five to ten possible sites. This step is followed by a pre-feasibility analysis. The results of the analysis lead to the selection of two to five candidate sites. The next step of the process is to allow the public to comment on the sites. Finally, a decision is made and a site is selected. The process of selecting a landfill site in a developing country may be different from or a variant of that used by an industrialised country.

Despite the importance of selecting the best possible site, in many developing countries (and in many industrialised countries), most, if not all, choices are removed by pressures exerted on land use by an increasing population density, widening urban sprawl, and essential needs for food production and commerce. If these conditions are overbearing, the only feasible course is to locate sites remotely from urban centres and depend on the use of transfer stations. Obviously, if this course of action is taken, consideration must be given to the general trends and direction in population growth and to the means of transporting wastes from the area of generation to the remote disposal site.

Even though a set of unfavourable circumstances may prevent adherence to the criteria and parameters for the selection of the best possible site, knowledge of them is of substantial utility. For example, an awareness of the extent to which a site differs from the ideal is instructional for identifying protective measures to take against unfavourable impacts of land disposal at less than ideal sites. As a second example, if a fill must be installed on a hillside that has a body of water relatively close to its base, interception and diversion ditches can be dug between the fill and the body of water to divert runoff from the body of water.

Finally, as an essential part of the development of long-term land-use plans, the knowledge of siting criteria can be used when assigning future uses to land disposal sites [66].

Several factors that are fundamental to the selection of a site will be discussed in this section. Proper consideration of these will lead to the development of a disposal facility that will protect the quality of the groundwater and surface water resources, and of human life and habitation.

F2. USEFUL lifespan and area of site

Useful lifespan and area constitute the first of the factors and is determined by the following parameters: depth of the fill; quantity, rate of delivery, and characteristics of the solid waste; and

operating practice. The site should be selected such that the useful life of the fill is sufficient to recover the capital investment. It is generally recommended that a landfill be designed for a useful lifespan of at least ten years. Determination of the size of the site must include two elements: gross area and useful fill area. Gross area is the total area within the property boundaries. Useful fill area excludes the area that will be taken up by buffers, access roads, and soil stockpiles. Useful fill area may be about 50% to 80% of the gross area. A diagram of a landfill is shown in Figure XIV-2. An indication of the usable land area required for one year of operation, as determined by population size and density of the compacted waste, may be gained from the curves plotted in Figures XIV-3 and XIV-4. Type of waste and operational procedures (including the amount of soil cover material) determine degree of compaction.

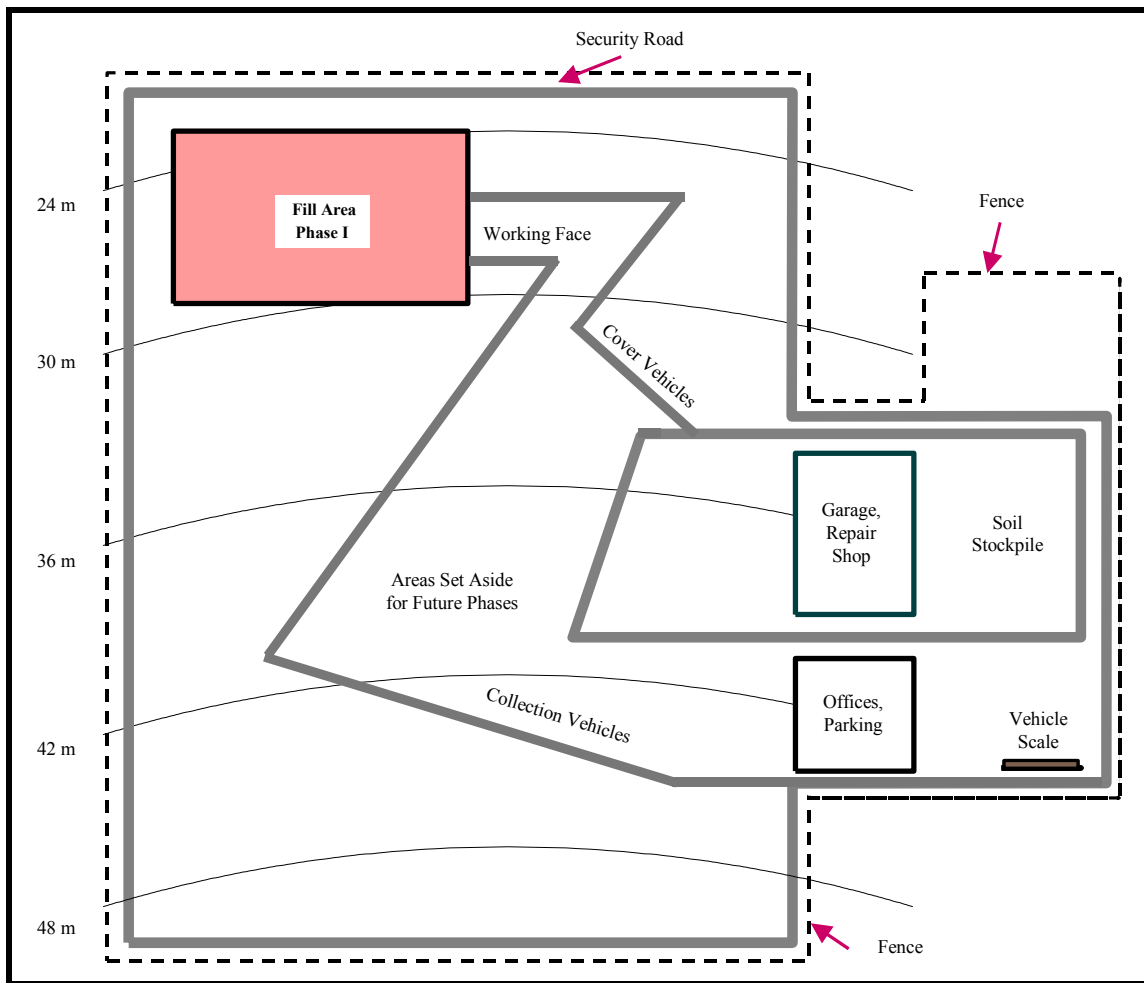

Figure XIV-2. Plan view of a landfill

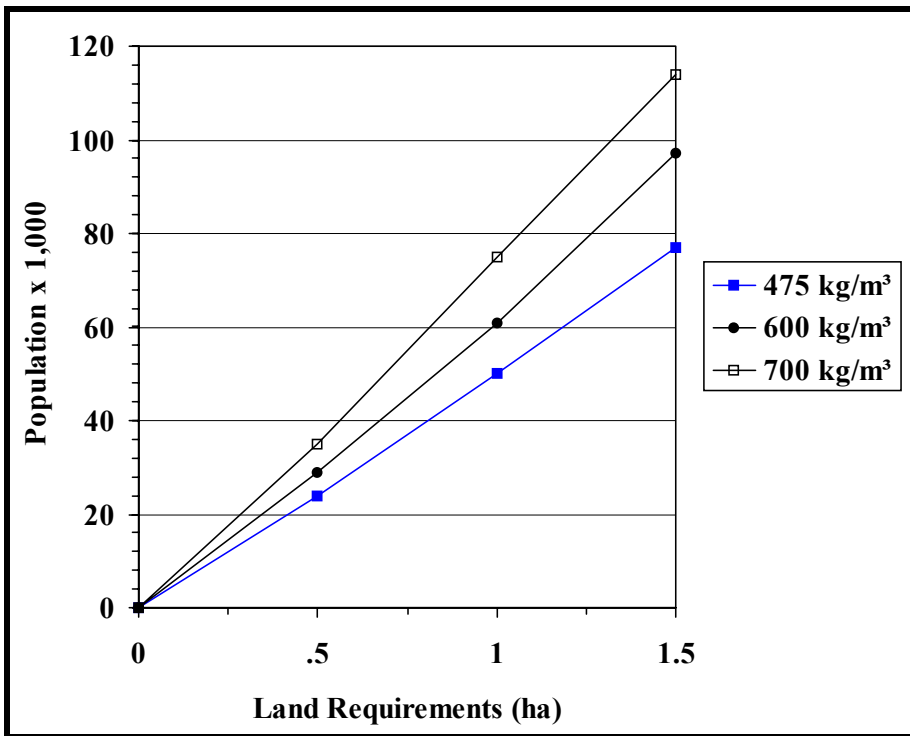

Figure XIV-3. Land requirements for a landfill as a function of compaction

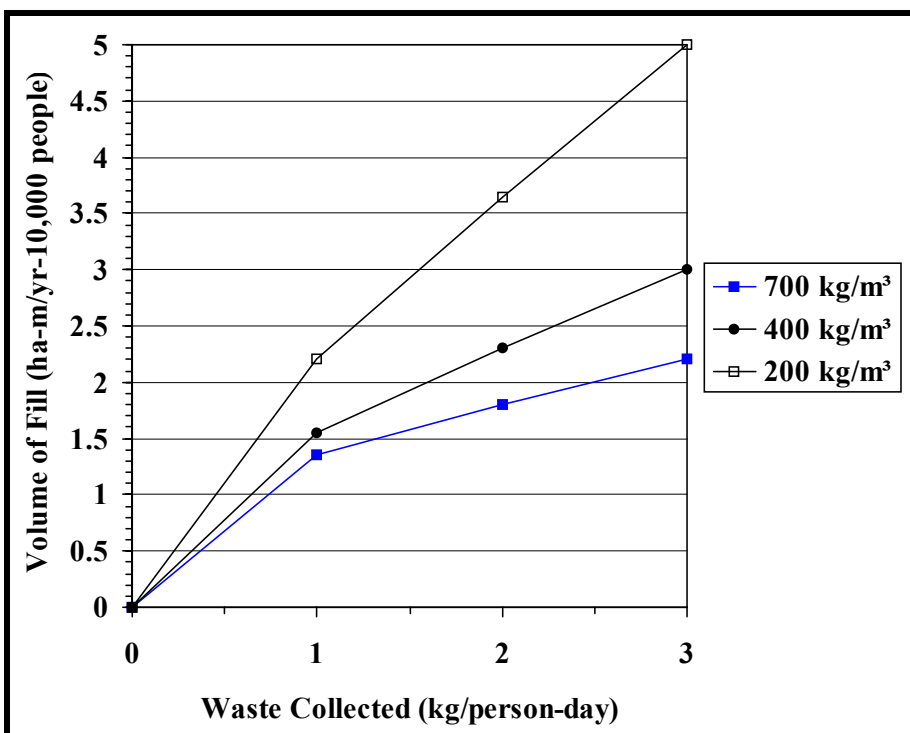

Figure XIV-4. Relationship between bulk density of waste and landfill volume required

The following formula can be used to calculate the useful life of a sanitary landfill:

$$L = \frac{V_T}{365(Q_p(1 + F_{Q_s}))}$$

where:

- L = useful lifespan in years,
- V_T = volume of selected site in m^3 ,
- Q_p = quantity of solid wastes in m^3 /day, and
- F_{Q_s} = quantity of cover material expressed as a fraction of Q_p in m^3 /day.

The quantity of waste can be projected using estimates of population. The estimate can be carried out by using the following formula:

$$Q_i = Q_p(1 + r)^n$$

where:

- Q_i = quantity of wastes to be collected in year “i”,
- Q_p = present annual quantity of wastes collected,
- r = average annual growth rate in population as a decimal fraction, and
- n = number of years.

The surface area required for a particular volumetric capacity decreases as the depth of the landfill increases. The area requirements can be calculated by using the following formula:

$$A = \frac{V_T}{h}$$

where:

- A = area required in m^2 ,
- V_T = total volume of solid wastes and cover in m^3 , and
- h = average depth of fill in meters.

Based on the formula and as depicted in Figure XIV-4, the compacted density of the wastes and soil have a substantial effect on the total volume and, therefore, on area requirements.

F3. TOPOGRAPHY

Regardless of type of site (e.g., abandoned coal strip mine, clay pit, natural depression), topographic information is a basic requirement in the development of an adequate facility design and determination of the impact of the facility. The importance of topography arises in part from the fact that precipitation will pond easily on a relatively flat site. On the other hand, it may erode an excessively steep site. In either case, operational difficulties are created. Slopes greater than 1% and less than 20% generally would be satisfactory. Topographic information is necessary in

order to plan a surface water drainage system such that: 1) surface water is diverted around the fill area; and 2) runoff from the waste is prevented from damaging the environment. In addition, topographic information is required to accurately determine the capacity of the site and the type and extent of excavation required.

A topographic map of the facility should have sufficient contour intervals to clearly indicate surface water flow patterns in the general area and in each operational landfill unit. Topographic maps are available from a number of sources, or they may need to be developed using any of a variety of land surveying methods. Useful information that may be recorded on the topographic map includes:

- the 100-yr flood plain area,
- surface waters,
- current land use patterns (nearest households),
- water use wells,
- monitoring wells, and
- drainage or flood control barriers (dikes, levees).

Maps showing site topography before facility construction, during operation, and after closure should be prepared. All maps should be labelled with map scale, date, and orientation.

F4. SOILS

The availability of soil of proper characteristics for the construction of bottom liners, of cover systems, or both is usually one of the more important considerations when analysing and selecting a landfill site. An advantage is had if sufficient quantities are on the site or nearby to avoid the time and expense of securing synthetic materials or soils located remotely from the potential fill.

In the event that the site does not have sufficient quantity of the required types of soil, the materials must be imported to the site. If importation is necessary, the site should have enough space for soil storage. Sufficient soil should be stored to satisfy the needs for five to seven days.

Soil surrounding the fill influences contaminant migration and provides a foundation for facility structures. Important soil properties are: particle size distribution (gradation or texture); structure; strength; porosity; activity; depth; spatial distribution; quantity; liquefaction potential; relationships between moisture, density, and permeability; and workability.

The classification and analysis of properties of soils is a well established science. There are several classification schemes available. The most popular scheme is the Unified Soil Classification System (USCS). A listing of some of the USCS soil types is presented in Table XIV-1, along with some of their properties.

Table XIV-1. Some typical properties of soil classes

Soil Class	Description	Permeability (cm/sec)	Optimum Moisture Content (%)	Maximum Dry Density (kg/m³)
GW	Same as GP (except well-graded in grain sizes)	$(2.7 \pm 1.3) \times 10^{-2}$	< 13.3	> 1908
GP	Gravel, very gravely sand (less than 5% silt and clay)	$(6.4 \pm 3.4) \times 10^{-2}$	< 12.4	> 1763
GM	Very gravely sand and loams	$> 3 \times 10^{-7}$	< 14.5	> 1827
GC	Very gravely loams and clays	$> 3 \times 10^{-7}$	< 14.7	> 1845
SW	Same as SP (except well-graded in grain sizes)	N/A	13.3 ± 2.5	1908 ± 80
SP	Sand, gravely sand (less than 20% very fine sand)	$> 1.5 \times 10^{-5}$	12.4 ± 1.0	1763 ± 32
SM	Loamy sand, sandy loam; sand; gravely sands and loams	$(7.5 \pm 4.8) \times 10^{-6}$	14.5 ± 0.4	1827 ± 16
SC	Sandy clay loam, sandy clay; gravely clay loams and clays	$(3 \pm 2) \times 10^{-7}$	14.7 ± 0.4	1845 ± 16
ML	Silt, silt loam, loam, sandy loam	$(5.9 \pm 2.3) \times 10^{-7}$	19.2 ± 0.7	1651 ± 16
CL	Silty clay loam, clay loam, sandy clay	$(8 \pm 3) \times 10^{-8}$	17.3 ± 0.3	1731 ± 16
OL	Mucky loams	N/A	N/A	N/A
MH	Silt, silty loam	$(1.6 \pm 1) \times 10^{-7}$	36.3 ± 3.2	1314 ± 64
CH	Silty clay, clay	$(5 \pm 5) \times 10^{-8}$	25.5 ± 1.2	1507 ± 32
OH	Mucky silty clay	N/A	N/A	N/A

Source: Reference 4.

Information regarding the strength of soils that serve as foundation for overlying facility components is required. Information is needed regarding the site's soil permeability (hydraulic conductivity -- usually in units of cm/sec) since landfill design must consider seepage through the foundation.

For economic reasons, onsite soils should be used for soil liner construction, cover material, and drainage layers to the extent permitted by the quantity and characteristics of the available soils and as required by the general conditions of the site. The volume of soil available on a given site is a function of site topography, groundwater depth, depth of trench excavations, ultimate height of the fills, and properties of the soils. In the United States, volume required for cover purposes generally ranges from 1 part soil for every 3 to 8 parts waste by volume. For small landfills, the ratio may be as high as 1 part soil to 1 part waste.

Two major considerations for using onsite soil are the ease with which the soil can be excavated and the seasonal variations in workability (e.g., clay-like silt when dry, moist, or frozen). Regarding engineering properties, well drained soils are suitable for drainage layers in leachate

collection systems. Highly organic soils are generally unsuitable for most land disposal applications due to their low strength and poor workability. An exception might be the use of compost as daily cover material.

If a bottom liner is required by the landfill design, the availability of suitable soil on the landfill site is a substantial benefit. In general, the preferable soil is one with a permeability of less than 1×10^{-6} cm/sec when placed as the liner.

Three types of cover systems are usually employed in the construction of a sanitary landfill: daily, intermediate, and final. As in the case of bottom liners, the availability of suitable soils on the potential landfill site for the construction of the cover systems is beneficial and should be a major consideration when analysing potential sites. The characteristics that are suitable for the various cover systems are described later in this chapter.

F5. GEOLOGY

Information on the geology of a site is required for properly engineering a facility. Such information serves three important purposes: 1) identification of geological hazards, 2) provision of information for facility design, and 3) assessment of vulnerability of the site to groundwater contamination due to the hydrogeology of the site.

Much of the useful geological information for engineering purposes relates to bedrock -- namely, depth to bedrock, bedrock characteristics, and condition of the bedrock. This information is especially useful if bedrock is at or near the surface and will serve as part of the foundation for the facility.

The status of the bedrock has an impact on its stability as a foundation. Joints and other discontinuities can provide hydraulic conduits and constitute pathways for migration of contaminants. In the case that the fill has a synthetic liner (which is unlikely in most developing countries), when the water table is high, these pathways may result on localised hydraulic pressures or gradients on the liner.

Geological information is difficult to acquire when an unstable terrain is involved. The integrity of the structures on unstable terrain is especially vulnerable to natural or man-induced forces, such as floods, seismic displacement and deformation, volcanic activity, landslides, subsidence, and weak or unstable soils.

F6. HYDROGEOLOGY

The potential to pollute the groundwater at the landfill depends, to a considerable extent, on the hydrogeological characteristics of the site, such as:

- depths to groundwater,
- nature and approximate thickness of water-bearing formations or aquifers near the landfill,
- quality of the groundwater upgradient of the landfill,
- site topography and soil type,
- soil infiltration rates at the site,
- effects of nearby pumping wells on groundwater beneath the site,

- hydraulic conductivity and its distribution at and near the site,
- depth and nature of bedrock,
- horizontal and vertical components of groundwater gradients, and
- groundwater velocity and direction.

In an economically developing country, the determination of all of the relevant hydrogeological characteristics of a site may be an extremely difficult task. However, some of the data may be available from government records, surveys, and maps. If these records do not exist, the geology of the site will provide some information as to its hydrogeology. Other data may be collected by interviewing local residents about floods (duration, levels, year, etc.).

The assessment of hydrogeology should include classification of the groundwater underlying the site, determining level and direction of flow, and evaluating the potential for groundwater contamination. Pollution potential largely depends upon the extent to which the characteristics of the site will control contamination of groundwater by the disposed solid wastes. Obviously, if more than one site is available, the preferable site should be the one with characteristics that would most impede groundwater contamination. Any problems with the level of isolation of the wastes from the groundwater should be compensated by protective measures (such as installation of liners and initiation of groundwater quality monitoring), to the extent permitted by available local economic, technological, and human resources.

Some of the most important characteristics associated with the obstruction of groundwater contamination include surface and subsurface hydrogeologic conditions. These conditions determine the potential migration velocity of contaminants at the site. Some of the conditions are: physiographic setting, location of groundwater recharge areas, characteristics of the unsaturated zone, characteristics of the uppermost aquifer, and depth of confining beds.

F7. PHYSIOGRAPHIC setting

The physiographic setting is a combination of climate, topography, stream density, and geological structures.

Climate plays an important role on the design and operation of a landfill because of its impact on the amount of rainwater that may infiltrate through the unsaturated zone and into a groundwater system. Degree of infiltration depends upon the amount of precipitation, volume of surface ponding and runoff, and the rate of evapotranspiration. Ambient temperature and relative humidity also have an impact on infiltration, evaporation, and evapotranspiration. The potential for groundwater contamination from a well designed and constructed landfill in arid and semi-arid regions can be quite low. In the case of semi-arid and arid regions (annual precipitation lower than about 10 cm), it may not be necessary to install a bottom liner or, consequently, leachate management facilities. On the other hand, the potential is quite high in humid regions. The amount of rainfall, as well as the timing and intensity, are very important considerations. For example, if rainfall is seasonal, the amount of rainfall during the wet season may be of such magnitude as to allow significant infiltration even though the annual average rainfall may be relatively low.

The tendency of precipitation to accumulate on flat sites and to erode on steep sites generally limits the siting of landfills to areas that have a natural slope of more than 1%, but less than 20%. In general, high topographic relief areas are less desirable for landfill siting than low relief areas.

The preference is due to the potential for rapid contaminant transport in the subsurface and rapid water flow on the ground surface.

In an area in which streams are relatively close together, the potential of surface water contamination increases in locations in which an unusually short underground flow path precedes discharge of contaminants into a stream. However, the overall extent of any groundwater contamination may be limited by nearby discharge points. The risk of surface water contamination in areas of low stream density may be reduced due to attenuation of the contaminants by subsurface media. On the other hand, widely spaced streams may also lead to the development of larger and longer term groundwater contamination zones. However, the increased attenuation potential and reduced risk of surface water contamination associated with low stream densities override the drawbacks of a large potential groundwater contamination area. In summary, the general preference is to select sites characterised by low stream densities [8].

F8. GEOLOGY and soil characteristics

Knowledge of the geological structure and history of an area is needed to predict groundwater behavioural characteristics. If sedimentary units are present or suspected, knowledge of the depositional history of the region may reveal unsuspected discontinuities in apparently uniform units (e.g., permeable channel deposit in a low permeability unit).

Permeability of the surrounding rocks and soils is an important factor in evaluating the suitability of an area as a potential site for a landfill. Although the primary permeability of a soil formation generally refers to groundwater intergranular flow (flow along the primary porosity), rate and direction of flow are controlled by the flow along fractures, joints, bedding planes, and solution cavities (secondary porosity). Secondary porosity may prevail when subsurface flow takes place in carbonate terrains, metamorphic and igneous rocks, and folded and faulted sedimentary rocks. Short circuiting may occur in situations in which secondary porosity is prevalent, inasmuch as low permeability (secondary porosity) is less an obstacle to contamination than is high permeability (primary porosity).

Unless control measures such as liners and leachate collection systems are implemented, a high permeability near the ground surface allows contaminants to move relatively quickly to the groundwater. Conversely, contaminants move slowly due to low permeability near the surface. Consequently, more time is allowed for attenuation or for instituting remedial measures before the groundwater becomes extensively contaminated. However, in such a situation, runoff of contaminated water may increase surface and subsurface water contamination.

F8.1. Groundwater recharge

The potential for groundwater recharge to significant aquifers is one of the most important considerations in the evaluation of a potential landfill site [29]. Areas of natural recharge must be avoided. Accordingly, the location of a site with respect to a regional groundwater flow system must be defined, particularly if the site is in or close to a primary recharge area. The introduction of contaminants in certain recharge areas may bring about migration of a contaminant over considerable distance and long residence times for a contaminant within the aquifer before reaching a discharge area.

Recharge areas are usually in topographically high areas where the water table may be relatively deep. Conversely, the water table is either near or at the land surface in discharge areas. Because of a decrease in potential energy with depth, the flow component is primarily downward in upland recharge areas; whereas, upward flow is the usual course in surrounding lowland discharge areas. The groundwater flow may be mostly horizontal in locations between the major

recharge and discharge areas in laterally extensive regional flow systems. Moreover, significant recharge can take place between the major recharge and discharge areas. Finally, an adequate prediction of pathways of contaminant migration and determination of the recharge potential to underlying aquifers presupposes the making of an assessment of vertical gradients at the site under consideration.

The soil infiltration potential should be evaluated on a site-specific basis. Doing so may involve making determinations of the unsaturated hydraulic activity of the soil, particularly the soil that separates the bottom of the landfill from the uppermost aquifer. Such determinations are useful in determining the protective potential of the site against groundwater contamination by a landfill.

F8.2. Vadose zone

The vadose zone is the zone that lies between the surface of the land and the principal water table (Figure XIV-5). Although the vadose zone is generally known as the “unsaturated zone”, saturated regions may be found in some vadose zones. Examples of such regions are perched water tables and tension-saturated zones. Vadose zone characteristics are important in arid regions because the water table may be located fairly deeply in those regions. Characteristics are less important in vadose zones in humid regions where the water table is shallow or in areas where fractured rock media occur near the ground surface.

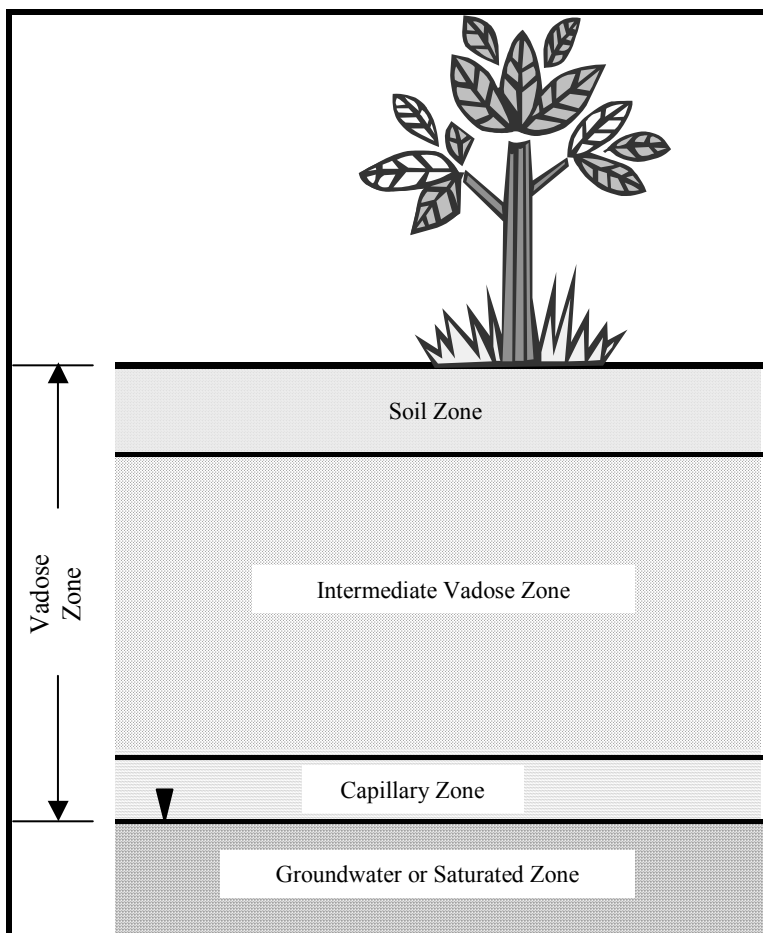

Figure XIV-5. Diagrammatic sketch of vadose and groundwater zones

Among the physical, chemical, and microbiological characteristics of the vadose zone that have a bearing on the mobility, attenuation, or degradation of contaminants in the subsurface are:

- mineralogy,
- porosity,
- organic matter content,
- particle size distribution,
- soil horizons and structure,
- soilwater characteristics,
- cation exchange capacity,
- temperature,
- soil pH, and
- availability of microorganisms.

A vadose zone that offers substantial protection against groundwater contamination should have the following characteristics: substantial thickness, a large capacity for adsorption and degradation of potential pollutants, a uniform soil structure, and consisting of a material characterised by low hydraulic conductivity.

The large sorption capacity of strata containing clay-rich soils is counterbalanced by the tendency of contaminants to move around them rather than through them. This tendency minimises the attenuation potential that may come from the presence of such strata. On the other hand, poor sorption materials (sands) are usually very permeable.

F8.3. Uppermost aquifer

The term “aquifer” refers to a geological formation in which the amount of saturated permeable material is sufficient to result in a significant amount of water in wells and springs. An aquifer is classified as a “confined aquifer” if its top is covered by an impermeable layer. If the top of the water table represents the top of the aquifer, such an aquifer is classified as “unconfined”.

The uppermost aquifer should be carefully monitored because it is the portion of the saturated zone that has the highest probability to be contaminated. It may be confined or unconfined. Certain uppermost aquifers may not represent a threat to groundwater quality, for example, those that do not have underlying aquifers, are not used for water supply, contain sorptive materials to attenuate potential contaminants, are deep, and are under a vadose zone that contains sorptive materials.

F8.4. Underlying aquifers

The occurrence, characteristics, and usage of sources of groundwater that may underlie uppermost aquifers are factors to be considered in evaluating the potential of a landfill to contaminate groundwater. Considerations discussed for uppermost aquifers are applicable to underlying aquifers. Factors of particular importance are type of existing and potential usage,

flow components, ambient water conditions, and the thickness and properties of materials that separate the aquifers. Among the factors that are the more effective in the prevention of contamination of groundwater resources are aquifers that are separated by a very thick layer of low permeability, sorptive materials or that lack direct hydraulic connections with the uppermost aquifer.

F8.5. Summary of relationship between geological and hydrogeologic characteristics and groundwater contamination

The combination of characteristics that would limit the risk of groundwater contamination is the following:

- The distance between the ground surface and the surface of the water in an unconfined aquifer or the top of a confined aquifer is greater than 30 m.
- The net recharge rate is less than 5 cm/yr.
- The water bearing unit is massive, dense, and unfractured.
- The soils are moderately hard or impervious.
- The topographic gradient is steeper than 18%.
- The vadose zone is comprised of dense, impervious media.
- The hydraulic conductivity for the water-bearing unit is less than about $0.4 \text{ m}^3/\text{day}/\text{m}^2$.

The greatest risk of groundwater contamination would be represented by the existence of the following set of conditions:

- The depth from ground surface to the water table is less than about 3 m.
- The groundwater recharge is greater than 25 cm/yr.
- The aquifers and vadose zones consist of irregular limestone or fractured basalt.
- The topographic gradient is less than 2%.
- The hydraulic conductivity is greater than about $80 \text{ m}^3/\text{day}/\text{m}^2$.

A fairly concise grasp of the interrelation between the various geologic and hydrogeologic factors, direction of leachate travel, and contamination of water resources may be gained from a review of Figure XIV-6.

F9. VEGETATION

Vegetation of concern ranges from the native types growing at the site to types planted as a part of site preparation and maintenance. The types of vegetation include small trees, shrubbery, herbaceous annuals, perennials, and groundcovers.

Trees and shrubs are planted to serve as a buffer; to reduce dust, noise, odor, and visibility problems; and for site beautification. A groundcover reduces or even eliminates wind and rain erosion of the landfill cover, improves aesthetic quality, and enhances moisture removal by way of evapotranspiration. The amount of water removed through evapotranspiration is significant. A

groundcover is especially important because of its role in ensuring the long-term stability and performance of the final landfill cover system.

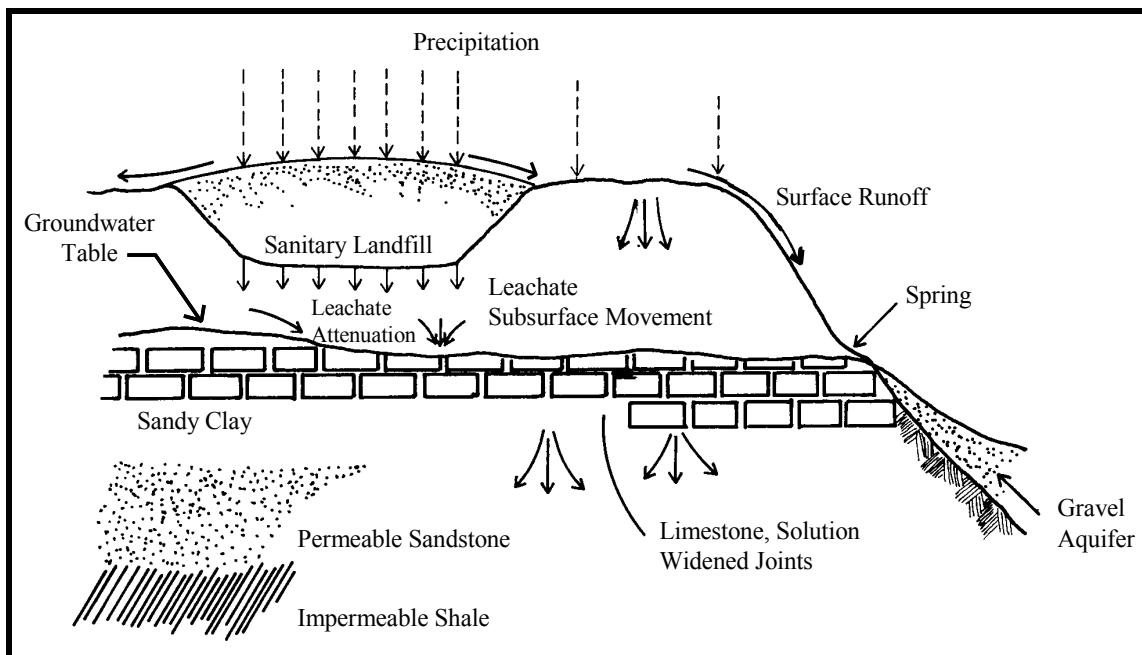

Source: Reference 31.

Figure XIV-6. Interrelation between climatic, topographic, hydrologic, and geologic factors in terms of leachate travel and groundwater contamination

F10. SITE access and transport

The cost of transport of waste to a potential site should be an important consideration during the process of identifying a location for a disposal site. If this were the sole consideration, the optimum location would be one located at the centroid of the waste collection area. However, other considerations come into play, some of which may override the hauling cost consideration. One such consideration is the decline in availability of land due to the constantly strengthening competition exerted by other uses. Socio-political considerations and environmental concerns also are important elements of the site selection process. The competing considerations could be such that the siting of the fill may be so distant that a transfer station would be required.

The conditions of the roads leading to the landfill have an impact on the cost of the overall system. Poor access both delays travel and damages vehicles. Thus, access to the site should preferably be over paved roads or all-weather unpaved roads. In the case of the use of trailer trucks to transport the wastes, the roads, bridges, and similar structures should be adequately designed to support the loads.

F11. LAND use

Land use involves two considerations during the site selection process: 1) compatibility of use of the site for the landfill with the present and future uses of adjoining land areas, and 2) availability of soil for necessary cover material (discussed previously).

Regardless of the state of a country's economic development, availability of the site selected for landfill depends to a large extent upon governmental and public acceptance. Hence, the degree of compatibility of the intended fill with the uses intended for surrounding land areas has important social and political implications.

A landfill places land use constraints not only upon the fill itself before, during, and after its completion, but also upon the use of the surrounding area. The constraints usually are determined from due consideration of technical issues, land use compatibilities, and public policy. The constraints should not be so severe that the satisfactory integration of the fill into the area's master plan is prevented. Social and political overtones come into play when it becomes necessary to convince the public that the integration can and will be made.

The future use of the surrounding area also has an important bearing upon the design and operation of the fill. For example, it determines the amount of wastes that the fill must accommodate and, consequently, it establishes the capacity required of the site. It also places constraints upon the nature of the waste that could be disposed at the site. Future use and location have an impact on the final shape, height, and contour of the fill.

On the other hand, proper siting of a landfill, including the construction of suitable access roads, has the tendency to attract the development of low-income housing. Thus, adequate measures must be taken to restrict intrusion into and around the site.

F12. ECONOMIC considerations in site selection

The cost of cover materials depends in large part upon the availability of the materials. The cost would be minimal if the material could be obtained from the site itself. If not, then the purchase price of the material, plus the cost of transporting it to the site, could have a substantial effect on the total costs of disposal. The high cost associated with securing the cover material and transporting it to the site, in many cases, prevents many communities in economically developing countries from covering the wastes on a daily (or relatively frequent) basis.

Hauling costs for transporting the wastes from the collection point to the landfill are a major consideration in selecting a landfill location. Obviously, the further the fill is from the centroid of the collection area, the greater the hauling costs. In fact, the distance between the site and the point of generation can be so great that the hauling costs exceed those of land and pre-development.

The decision regarding a feasible distance to the disposal site should be determined by the costs and the benefits that may be associated with distance. For instance, a site that happens to be farthest away from the collection points may also have the lowest potential for exerting an adverse impact upon the public health and the quality of air, water, and land resources. The decision with regard to a feasible distance will generally rest upon what is perceived as being the more important: lower costs of hauling and degraded resources, or higher costs and higher quality of health and natural resources. At issue is the willingness of a community to pay to improve the quality of life. Of course, distance brings another possibility -- namely, effect of distance on the cost of the land occupied by the site and impact upon public health and quality of the environment. Distance may lower land costs in addition to lessening the extent of adverse impact upon public health and environmental quality.

F13. DECISION-MAKING process

A suggested decision-making process for selecting a suitable landfill site in an economically developing country involves three steps:

1. The first step is to make an initial assessment of potential sites by doing the following:
 - determining physical and demographic limitations;

- establishing suitable study areas on the basis of haul distance, topography, geology, and surface and groundwater conditions;
- identifying candidate sites;
- assessing financial feasibility on bases of haul distances, approximate site development costs, and operating hours per week for equipment and personnel;
- performing preliminary site investigations as to location, land use, haul distance and routes, topography, hydrogeology, soil characteristics, and area of the site; and
- eliminating undesirable sites.

An approach that takes into consideration the elements of step-1 involves the use of a computerised database that describes the physical, sociological, and demographic data within a physical area. Development of the information is by way of digitising various types of maps (e.g., land use, geographical structure, census tract) and adding other demographic data.

2. The second step in the process is to screen the candidate sites. This step is composed of the following:
 - investigating four to five candidate sites and identifying site-specific problems;
 - evaluating and ranking sites; and
 - obtaining public input.
3. The third step consists of:
 - preparing a preliminary design for each site so that capital and operating costs can be estimated;
 - determining and evaluating the use upon completion of each of the sites;
 - evaluating the costs associated with developing and operating each site, including the cost of hauling wastes to the site;
 - selecting a site and listing alternative sites; and
 - acquiring the site.

G. Landfill technology

G1. INTRODUCTION

Landfill technology applies to a variety of aspects of the construction and operation of the landfill facility. Consequently, in this section, topics discussed include not only practices of disposal, e.g., formation of the cellular structure of the sanitary landfill, but also some other aspects of technical importance. Some of the other aspects are the liner and cover as landfill system components and the special circumstances that must be taken into account concerning the different types of wastes that can be expected to be delivered to a disposal facility in developing countries. Also, the role of technology in the construction and use of the completed fill is discussed.

G2. CELL design and construction

Experience has shown that no one method of landfilling is best for all sites, and a single method is not necessarily the optimum for any given site. Selection of a method depends upon the physical condition of the site, amount and types of solid waste to be disposed, and the relative costs of the various options. The two basic types of landfill methods are the trench (Figure XIV-7) and the area (Figure XIV-8). The trench method is best suited for sites that have a flat or gently rolling land surface, a low groundwater table, and a soil layer thicker than 2 m.

The area method is applicable with most topographies and probably would be the better of the two choices for sites that receive large quantities of solid waste. A design using a combination of the two methods may be the most appropriate approach at some sites.

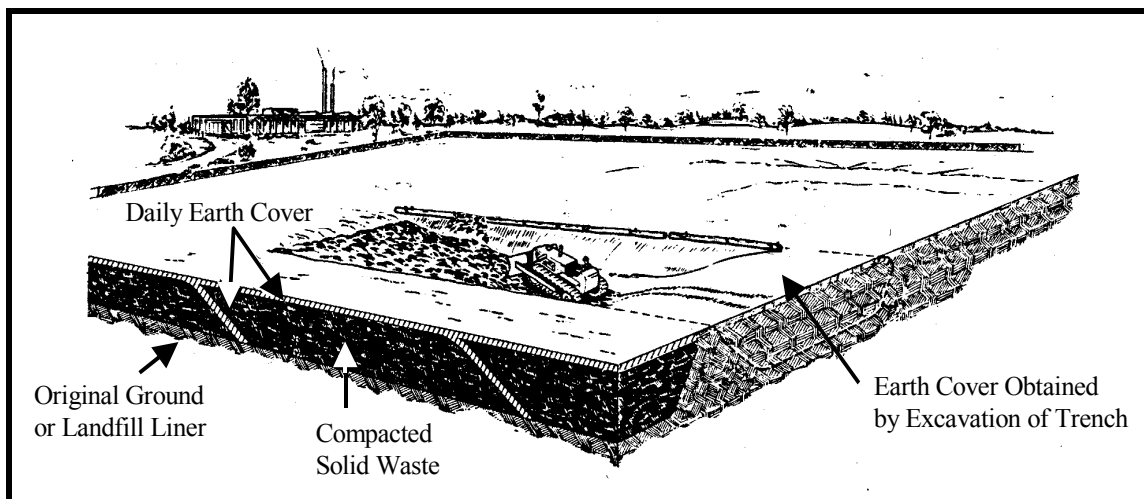

Source: Reference 11.

Figure XIV-7. Trench method of sanitary landfilling

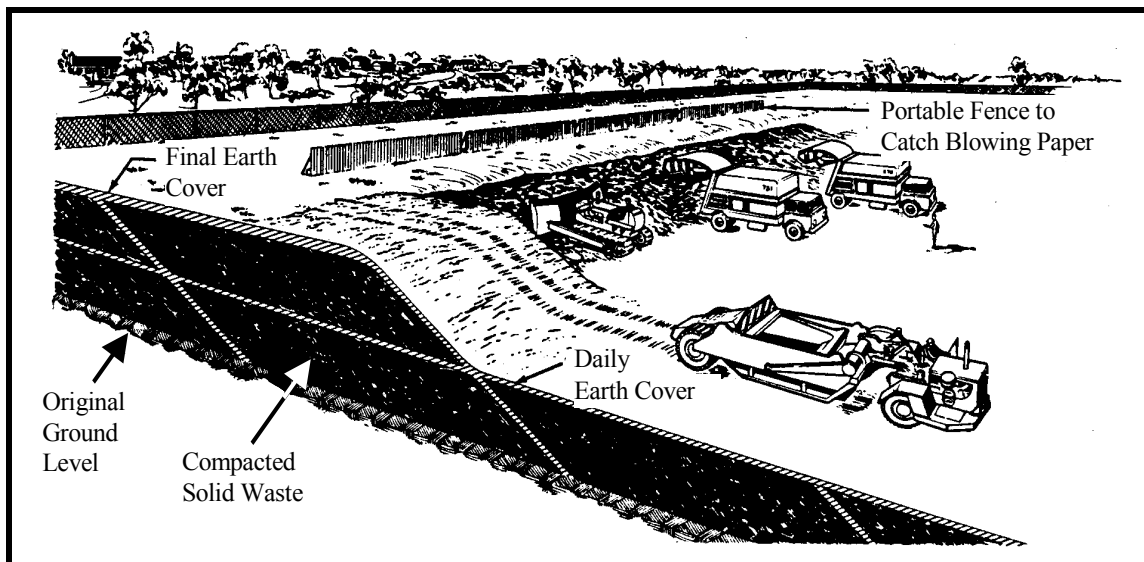

Source: Reference 11.

Figure XIV-8. Area landfill

All true sanitary landfills consist of elements known as “cells” (Figure XIV-9). A cell is built by spreading and compacting the solid waste into layers within a confined area. At the end of each working day, or during the working day as well, the compacted refuse is covered completely (including the working face) with a thin, continuous layer of soil. The soil cover also is

compacted. The compacted waste and its daily soil cover make up a cell (Figure XIV-9). A series of adjoining cells at the same elevation constitute a “lift”. A completed fill may consist of one or several lifts.

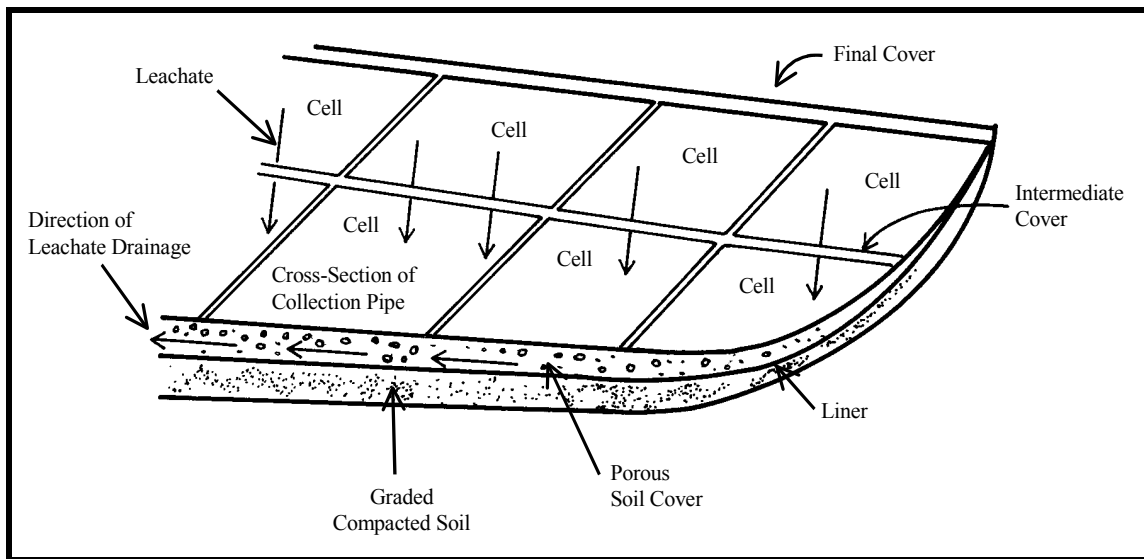

Figure XIV-9. “Cellular” structure of a landfill

The cells are designed based on the quantity of wastes requiring disposal. The basic elements of a cell are: height, length, width of working face, slope of sidewalls, and thickness of daily cover. The height of a cell is a function of the quantity of waste, thickness of daily cover, stability of slopes, and degree of compaction. Typical heights vary between 2 and 4 m.

The minimum width of the cell or minimum width of the working face depends upon the type of equipment used. It is generally recommended that the minimum width of the cell be about 2 to 2.5 times the width of the blade used for building the cell. The minimum recommended cell widths based on rate of waste delivery are: 8 m for up to 50 Mg/day, 10 m for 51 to 100 Mg/day, 12 m for 101 to 225 Mg/day, and 15 m for 226 to 500 Mg/day.

The width of the working face also is dictated by the maximum number of vehicles arriving at the disposal site at the peak hour. The width of the working face (in meters) can be calculated by multiplying the maximum number of vehicles arriving at the peak hour by about 4.

The width of the working face is one of the major weaknesses in the operation of a land disposal facility in economically developing countries. Generally, the working face is excessively wide in order to accommodate the maximum number of vehicles and to avoid long delays. However, the width is such that it is extremely difficult to achieve any type of control. In practice, one should attempt to operate a landfill using the smallest practical area for the working face.

The slope of the cell is the inclined plane upon which the wastes are distributed. The maximum recommended slope is 1 to 3 (vertical to horizontal). Slopes less than about 1 to 6 result in an undesirably large area for the working face.

The trench method has only one working face. On the other hand, the area and combined methods may have two working faces.

G2.1. Trench

The trench method involves the excavation of a trench. Once the excavation is completed, the waste is placed into the trench, spread, and compacted (Figure XIV-7). The waste is deposited on the slope of the trench. The excavated soil serves as cover material. Soil not used for the daily cover is stockpiled for later use in a subsequent area that might be constructed on top of the completed trench fill.

The stability of the sidewall is a critical factor in the design of a trench landfill. Sidewall stability is a function of the characteristic strength of the soil, depth of the trench, distance between trenches, and slope of the sidewall. Maximum depth and steepness of sidewall slope are compatible with clays, glacial till, or other fine-grained, well-graded, consolidated soils. Weaker soils require gentler sidewall slopes. Other factors that may affect soil stability and permissible steepness of sidewall slope are climatic conditions and the length of time the trench is to remain open.

Because a suitable distance should be maintained between the bottom of the fill and the groundwater table, compatibility with groundwater protection places another constraint on trench depth.

Theoretically, the trench should be as narrow as possible since the amount of required cover material is a function of the width of the trench. However, because width must be sufficient to allow discharge of the wastes as well as accommodate the compaction equipment, practicality demands that the trench be wide enough to accommodate the number and types of vehicles that use the fill. Generally, the indicated width is twice that of the largest piece of equipment that will work in the trench.

Based on the projected size of the landfill, excavation may either be done continuously at a rate adjusted to landfilling requirements, or periodically on a contract basis.

The direction of the prevailing wind should be taken into consideration in the alignment of the trenches since wind exerts a significant influence on the amount of blowing litter. The most effective alignment in terms of reduction of amount of blowing litter is one that is perpendicular to the prevailing wind.

To ensure proper drainage, the bottom of the trench should be sloped away from the active fill area. Water that accumulates at the bottom of the trench should be pumped out of the trench. Surface water can be diverted from the trench by constructing temporary berms on the sides of the excavation.

G2.2. Area

As opposed to the trench method, the area method does not involve excavation of trenches (Figure XIV-8). Instead, a layer of waste is spread and compacted on the surface of the ground (on the inclined slope). Cover material is then spread and compacted over the layer of waste. The area method should be used on flat and gently sloping land. This method can be adapted to quarries, strip mines, ravines, valleys, canyons or other land depressions, and excavations made for the landfill.

G2.3. Ramp

The ramp, also known as the progressive slope method, consists of spreading and compacting the solid waste on a slope. The ramp method is similar to the area method. However, in a departure

from the area method, cover material is obtained from the soil surface immediately in front of the working face -- thus, leaving a slight depression to begin receiving deliveries of waste the following day. Because it does not involve the importation of cover, the ramp method promotes greater efficiency of site usage when a single lift is constructed.

G2.4. Combination of fill methods

The area method and the trench method might be used in the same site if the particular site has varying thicknesses of topsoil and receives a large amount of wastes. The trench method would be used in situations where the topsoil layer is thickest. Soil not used for cover on the trench fill would be stockpiled for the area fill. Through the use of the area method and stockpiled cover material, additional lifts can be constructed upon a completed lift.

G2.5. Slope stability

The stability of slopes of wastes and of waste/bottom liner interfaces in the landfill are important in managing the fill cost effectively and in protecting the safety of landfill workers and other people that reside on or near the fill. Sloughing or landslides of waste can occur in improperly constructed masses of waste that have steep slopes. When the quantities of waste are large and slope failure occurs, the movement of waste can destroy property, cause personal injury or death, and (further) contaminate or disrupt the environment, or a combination of these. Uncontrolled disposal of waste on land is obviously susceptible to slope instability, particularly in the case where large quantities of waste have been dumped indiscriminately over a ledge or into a ravine. However, engineered landfills are also susceptible to slope failures unless designed properly. Substantial slope failures in waste disposal sites have occurred in the United States [86], the Philippines, Turkey, Colombia, and Italy [85], among others. Events that can trigger movement of an unstable slope of waste include, but are not limited to, earthquakes and heavy rainfall.

The design and construction of the slopes of landfill cells and of completed landforms must take into consideration the types and engineering properties of the wastes placed in the fill and of the soils, synthetic materials, or both used to isolate the waste from the environment. This type of analysis should be performed by a qualified and experienced professional, and is usually reserved for a geotechnical engineer.

The shear strength of solid waste is an important mechanical property used in the analysis and design of waste slopes [87,88]. The amount of moisture in the waste can affect the shear strength and slope stability of the waste.

G3. BOTTOM liner

A bottom liner (or, simply, liner) is an engineered system to contain and control the pollution of the land and water environments surrounding the land disposal operation. The design of a bottom liner, in the case of economically developing countries, will vary depending on a number of factors, including: the potential of the landfill polluting the land and water environments, the local hydrogeology and meteorology, and the availability of suitable materials and monetary resources. Liners are described in detail later in this chapter.

G4. DAILY, intermediate, and final covers

The technology of modern sanitary landfilling includes cover systems over the waste to control nuisances, to protect the environment, and to protect the health and safety of workers and of the public. Depending on the location within the fill and the phase of the construction and operation, the cover systems employed are daily, intermediate, and final. The daily and intermediate covers

are placed more or less continuously during the active phase of the filling operation. The final cover usually is periodically placed during the active phase of the landfill or at the completion of the fill. Of the three, the final cover is the most complex system. In the context of economically developing countries, the design and materials of construction of each of the three types of cover systems are subject to the short- and long-term risks posed by the operation of the fill, to the availability of suitable materials, and to financial resources. The three types of landfill cover systems are described below.

G4.1. Daily cover and intermediate cover

Daily cover controls vectors, litter, odours, fire, and moisture. Any soil material that is workable and has stability (clays, gravels, etc.) may be used.

Intermediate covers control gas migration and provide a road base. Soils used for intermediate cover must have strength and the required degree of impermeability. Typically, a thickness of 15 to 20 cm of compacted soil is recommended.

The application of cover over the waste on a daily basis controls the generation of nuisances and hazards to the operators and to the public. However, in some situations, the application of cover on a daily frequency may not be warranted as a consequence of an assessment of the risk of hazard and nuisances versus the availability of material and financial resources. These situations would be most likely to exist in arid locations in which the average rainfall does not exceed about 10 cm/yr and the evaporation rate is about the same on an annual basis. Under these conditions and assuming that the groundwater is not in any danger of contamination and that the operators or public are not exposed to some other unacceptable risk, it may be justified to cover the waste on a frequency that is less than daily. An analysis of the situation and local conditions is required in order to determine the frequency of covering waste.

Lack of availability of native soil for cover is not necessarily an adequate reason for infrequent covering of the wastes. Alternatives to native soil exist in some cases. For instance, a large number of municipalities in developing countries have a large market that generates considerable quantities of organic matter. This material usually is landfilled. Instead, the material can be composted together with residues from landscaping and used as cover material. Generally, one can find a number of alternative cover materials that can replace soil after adequate analysis of local conditions and after processing of the materials, if necessary.

G4.2. Final Cover

The final cover is the layer that is placed on the completed surface of the fill. The functions of the final cover are several. It controls infiltration of water (and, hence, indirectly controls leachate production), controls landfill gas migration, serves as a growth medium for vegetation, provides a support for post-closure activities, and is a barrier between the external environment and the waste [8].

An important consideration in the design of a final cover is the degree of resistance that the cover offers to percolation and infiltration of moisture and to the upward migration of gases generated in the buried waste. This resistance may or may not be desirable. Thus, some cover designs call for the free percolation of rainwater through the cover; whereas, others call for resistance to such percolation.

In the cases where high runoff and minimal cover percolation are the main criteria in cover design, soil hydraulic conductivity is one of the more important design parameters in controlling percolation [8]. Percolation decreases as the number and thickness of layers in the cover increase.

The most resistant to percolation of the two-layer soil covers consists of a topsoil surface layer over a hydraulic barrier layer composed of a properly designed mixture of clay and loose-textured soil.

Other considerations regarding the design of the final cover involve the intended use of the completed fill. A relatively loosely textured soil cover provides a good growth medium for vegetation, even if the vegetation is intended solely for the purpose of encouraging water loss through evapotranspiration. However, a loosely textured soil cover does not provide the maximum possible load-bearing capacity. If eventual gas recovery is a goal, the upward flow of gas must be prevented. If structures are to be built on the completed fill, the maximum withdrawal of gas should be promoted. Finally, regarding all considerations pertaining to penetration, it should be kept in mind that a tightly compacted clay cover resists penetration, whereas a sandy or gravelly cover material offers little if any resistance.

The simplest design of a final cover system for a sanitary landfill consists of two layers: 1) the surface layer, and 2) the hydraulic barrier. The hydraulic barrier essentially is the first layer of the cover specifically designed to prevent the passage of liquids into the waste.

If a cover is to be designed and implemented in a developing country, it is advisable to use a thickness of about 60 cm for the surface layer and a thickness of 30 cm for the underlying hydraulic barrier. This design would be acceptable in areas with high evaporation and low rainfall (i.e., a climate with high temperatures, low humidity, and low precipitation). The design of the cover is depicted in Figure XIV-10.

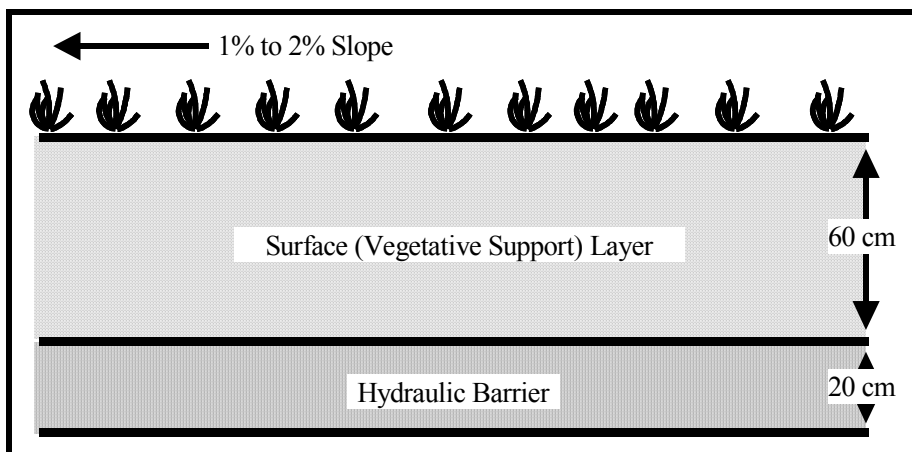

Figure XIV-10. Basic design of final cover system

In humid climates and in those situations that require a high level of control, the inclusion of other types of layers may be necessary.

In order to maintain the flow of water into the solid wastes to a minimum, the cover must be designed such that the major portion of precipitation becomes runoff. This objective can be accomplished by building a cover with a slope between 1% and 5%. This inclination promotes flow off the cover and at the same time limits erosion to an acceptable level. Erosion also is reduced by establishing vegetation. Vegetation also has an additional benefit because it promotes evapotranspiration. Thus, slope and vegetation play important roles in the performance of the cover.

In the event that the layer of topsoil does not have a sufficiently low permeability to prevent percolation, then the waste will be subject to infiltration and, thus, the potential generation of leachate. Infiltration can be reduced by the incorporation of a lateral drainage layer above the

hydraulic barrier layer. The incorporation of the drainage layer into the design brings about a higher degree of control of leachate formation and also increases the complexity of the cover system and the cost. The increase in the complexity of the system and in the cost may not be acceptable in economically developing countries. The reason is that if the drainage layer is to function properly, it should be protected from above by a filter zone. The filter zone consists of a layer of carefully selected and sized cohesionless soil. The filter zone, as its name implies, serves the purpose of preventing the downward migration of small soil particles from the vegetative layer into the drainage layer. These particles would eventually clog the drainage layer.

Finally, if brush and tree growth is promoted and burrowing animals are present, it would be necessary to include a barrier to keep the roots and animals from damaging the cover. This additional layer is called a biotic barrier. This barrier generally is located between the filter and drainage layers.

The main aspects of the design of a cover are its individual layers. The schematic in Figure XIV-11 shows the state-of-the-art in the design and construction of landfill covers as employed in the United States. As shown in the figure, eight different layers compose the complex cover system of a modern sanitary landfill.

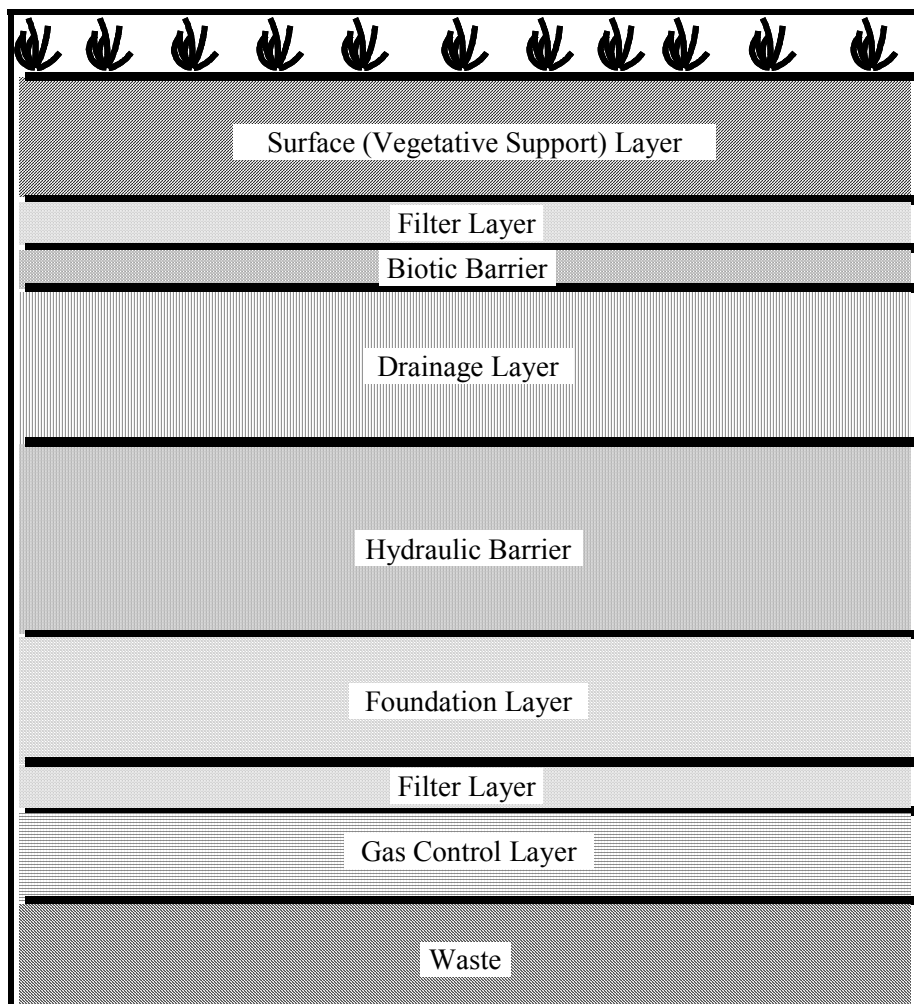

Figure XIV-11. Components of a complex final cover system of a modern sanitary landfill

Each of the eight layers is described in the following subsections.

G4.2.1. Vegetative (or surface) layer

This layer is necessary to protect the cover from erosion due to wind and water flow. The surface or vegetative layer should consist of nutritive and dense topsoil in order to support plant growth. The soil can be mixed with composted yard debris, biosolids, or animal manures.

G4.2.2. Filter layers

Any time soils having fine particles are placed over soils with coarse particles, there is potential for the movement of the fine soils into the voids of the layer of coarse grains. This phenomenon is known as piping and results in the plugging of the coarse layer. Filter layers are used in the design of landfill covers both to remove fine particles from infiltration and to allow upward flow of landfill gases. Soil or non-soil particulate filters can be used. In the event that they are not available, geotextiles may be used.

A filter layer also is usually placed below the foundation layer to prevent clogging of the gas control layer.

G4.2.3. Biotic barrier

As previously indicated, the hydraulic barrier plays a very important role in the performance of a cover. As such, the integrity of the hydraulic barrier must be maintained. Plants and animals can perforate the hydraulic barrier and, thus, compromise its integrity. One method of controlling this potential problem is through frequent mowing and pruning of the plants and through the use of rodenticides. Another method of control is through the installation of a biotic barrier. A biotic barrier consists of a layer of construction debris, crushed rock, or similar material of such size to prevent the movement of roots and animals.

G4.2.4. Drainage layer

If a final cover is incorporated into the design of a landfill, it should incorporate a drainage layer. The few exceptions would be in very arid areas where precipitation is very low. The main purpose of this layer is to intercept the downward flow of infiltration and to remove it before it can penetrate the hydraulic barrier.

A schematic of a drainage layer is shown in Figure XIV-12. As is depicted in the figure, the layer should slope in the direction of collection points on the perimeter of the landfill. The drainage layer should be made up of porous material.

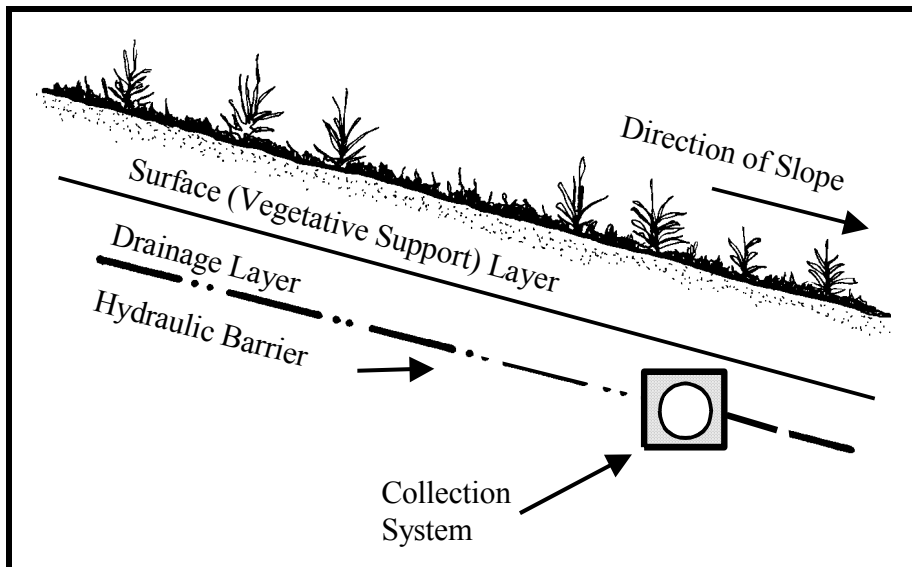

Figure XIV-12. Schematic of a drainage layer

G4.2.5. Hydraulic barrier

The hydraulic layer is one the most important components of a final cover. The main function of the hydraulic barrier is to prevent infiltration of moisture into the solid waste and, thus, prevent the formation of leachate.

In industrialised countries, hydraulic barriers are made of fine-grained soil that is carefully compacted. The soil can be mixed with other materials such as bentonite clay and fly ash in order to reach the desired permeability. Proper performance of the final cover depends upon the maintenance of the integrity of the hydraulic barrier. In order to perform effectively over time, the thickness and hydraulic permeability of the soil barrier layer should be at least 30 cm and less than 1×10^{-6} cm/sec, respectively. The ideal design is a thickness of 60 cm and a permeability of less than 1×10^{-7} cm/sec.

The integrity of the hydraulic barrier can be affected through three mechanisms: mechanical, chemical, and environmental. Mechanical impacts deal primarily with damage due to construction, such as excessive overburden, high compaction, and punctures. Chemical effects are the least troublesome and relate to vapours and gases. Environmental impacts involve drying, wetting, and root penetration.

Synthetic membranes can be used instead of soil as hydraulic barriers. Synthetic membranes can be very expensive for these applications, particularly in the small municipalities of economically developing countries. If synthetic membranes are used, they should be protected from mechanical damage (both during construction and maintenance) by installing adequate underlayment and a protective layer (such as sand) on top.

G4.2.6. Foundation layer

As its name implies, the foundation layer serves as a buffer between the final cover and the wastes it is designed to support. The foundation layer is made up of compacted soil placed on top of the uppermost waste lift.

One of the main concerns in the design of a final cover is settlement due to decomposition of the wastes. Consequently, one of the more effective means of protecting the foundation layer, and therefore the final cover, is by ensuring that the wastes are thoroughly compacted.

G4.2.7. Gas control layer

Landfill gas is a product of decomposition of organic matter in the landfill. The gas is primarily composed of methane and carbon dioxide. The quantity and composition of the gas depend upon a number of variables, including: nature of wastes, climate, and moisture content.

Gas control mechanisms typically utilise a porous layer placed as close to the waste as possible. The layer may be part of a static or dynamic gas collection system.

G5. CUSTOMISED methods of construction and use after completion

The design and construction of a sanitary landfill may be customised so as to accommodate both waste disposal and use of the facility after the completion of the active phase of the fill. Some examples of feasible uses are topographical contouring, reclamation of aquatic environment, strip mine reclamation, urban redevelopment, and gas recovery. The use of a landfill after its active life entails special considerations.

Two particular types of customised landfill construction and uses are described below: topographical contouring and reclamation of aquatic environment. Other potential uses and their implications in terms of design and maintenance of the fill are discussed later in this chapter.

G5.1. Topographical contouring

Topographical contouring is the construction of a fill in the form of a hill. This approach allows more efficient use of the land by increasing the capacity of the landfill in a given area. The completed fill consists of a series of circular lifts tapered to approach the contour of a hill. In this case, the area method would be used for building the lifts. The maximum slope of the hill is determined by the angle of repose of the soil cover, the climbing capacity of the equipment, and the angle of slip and tip (roll over) of the equipment when operating at normal loading. The design specifications should provide a comfortable safety factor with regard to these items. The maximum grade of the slope must be one at which several requirements (e.g., spreading, compaction, covering) for a satisfactory fill can be met without endangering the safety of the workers, and at which the eventual landscaping of the hill can be done. Other factors that must be considered and addressed include soil erosion caused by precipitation and slope stability.

G5.2. Reclamation of aquatic environment

In some cases, the landfilling of solid waste may be justified for the reclamation of marshes and other land masses containing pockets of water with very low quality. In these situations, the water is removed or allowed to evaporate and the appropriate evaluations are carried out (geological, hydrological, and others). Careful consideration must be given to the ecological conditions of the site. For the improvement and maintenance of the public health and safety, solid waste should not be disposed in or near existing or potential sources of water used by humans for drinking, cleaning, or recreation, or in ecologically sensitive areas. Prior to the implementation of a coastal reclamation project, all potential environmental consequences must be carefully identified and analysed.

G6. CO-DISPOSAL of special wastes

Co-disposal involves the mixing of one type of waste with another and the subsequent disposal of the mixture. Although the co-disposal described in this section can be applied to most types of non-industrial sludges, the discussion is directed primarily to sludges (biosolids) associated with

the storage, treatment, and disposal of human body-wastes (primarily, faecal wastes). Examples of the latter biosolids are those produced by a conventional wastewater treatment facility, septic tank pumpings, sludge from the storage pits of unsewered public toilets, and nightsoil in general.

Despite the many hazards to public health and nuisances attributed to the practice, untreated nightsoil frequently is co-disposed with municipal solid wastes in developing countries. These hazards and nuisances are amplified by the prevalence of the open dump method of disposal. Although perhaps not as pronounced, the same hazards attend the open dump co-disposal of primary (i.e., raw) sewage biosolids from a sewage treatment facility. The hazards can be substantially reduced by converting to sanitary landfilling.

In an operation involving co-disposal by sanitary landfilling, an approach is to deposit the biosolids (20% to 30% solids) on top of the solid waste at the working face of the landfill. The biosolids and solid waste are thoroughly mixed. The mixture is then spread, compacted, and covered in the manner usual to the sanitary landfilling of solid waste. Liquid in the biosolids is absorbed by the solid wastes. Because the absorption capacity of municipal solid waste in developing countries generally is relatively low, the maximum weight of the water in the biosolids must be low in order for the solid waste to retain the water contained in the biosolids so that it does not contribute unduly to leachate generation. Scavengers should not be permitted to come in contact with biosolids or solid wastes that have received biosolids.

G7. HAZARDOUS wastes (secure landfill)

G7.1. Introduction

Although the management of hazardous wastes is not the main concern of this book, the technology for disposing of these wastes is briefly covered for completeness and as a reminder of the importance of their management. Furthermore, in most developing countries, a large fraction of the hazardous wastes generated are collected and disposed with the municipal solid wastes.

The land disposal of hazardous waste can pose a substantial risk and undertaking in a developing country since definitions, standards, and safeguards usually are not developed or fully operative.

G7.2. Definition and specifications

A secure landfill is a complex, engineered earthen excavation specially designed to contain hazardous wastes such that they cannot escape into the environment. Therefore, a genuinely secure landfill has the following features:

- Waste disposed in a secured landfill is completely enclosed by one or more layers or liners of impervious materials.
- The distance between the bottom of the liner and the groundwater is sufficient to prevent contact between the two.
- Leachate and all other liquids are not allowed to accumulate inside or outside the containment layers.
- Groundwater quality is monitored such that leakage from the fill can be detected and corrected.

- The fill is located such that it is isolated from surface and subsurface water supplies; is free from the effects of flooding, earthquake, or other disruptions; and its site is not needed for other uses after the facility is closed [29].

G7.3. Design

As with all sanitary landfills, the design of a secure landfill largely depends upon the hydrogeological characteristics of the site. Thus, if the distance to the water table is substantial and the soils are impermeable, compaction of the soils at the site combined with the placement of a single liner, either of natural or of synthetic material, would be sufficient. In such a case, soil or bentonite could serve as a natural liner material and high-density polyethylene or chlorinated polyethylene could serve as a synthetic liner material. If conditions are not ideal, but do meet minimum standards of acceptability, the soil presently at the landfill site could be excavated and replaced with a sand/gravel layer, followed by a compacted clay layer, a synthetic liner, and a final layer of compacted clay. In all cases, provision should be made for preventing the various types of wastes from mixing together and thereby triggering a dangerous chemical reaction (e.g., highly caustic waste with a strong acid waste). Prevention of mixing is effected by separating different areas of the facility from one another by forming subcells using earthen dikes.

Arrangements should be made for collecting and withdrawing leachate as it accumulates in the basin. This is done through a network of piping installed in the fill. Groundwater quality should be monitored by means of monitoring wells placed along the perimeter of the fill. Monitoring of groundwater should take place before the beginning of the deposition of wastes and be continued thereafter until chances of pollution become non-existent.

The design, operation, and monitoring of a secure fill is a complex process that requires the participation of skilled professionals. The various elements of a secure fill are diagrammatically indicated in Figure XIV-13.

G7.4. Closure of the fill

The closure operation is designed such that total and complete containment of the facility is assured, and that the completed fill does not pose a threat to the public safety and the environment. This objective is attained by adhering to the following procedure:

- Upon completion of the landfill, cover the upper surface of the completed fill with impermeable soils.
- Cover this layer with a synthetic liner (if available) to effectively seal this layer and underlying wastes from rainfall.
- Cover the synthetic liner with topsoil and seed the topsoil to produce vegetation to complete the closure operation. Leachate and gas collection pipes should protrude through the final cover.

Finally, excavation of the completed fill should not be attempted since most buried hazardous wastes continue to be dangerous long after their burial. Excavation of completed, secured landfills can be a dangerous undertaking.

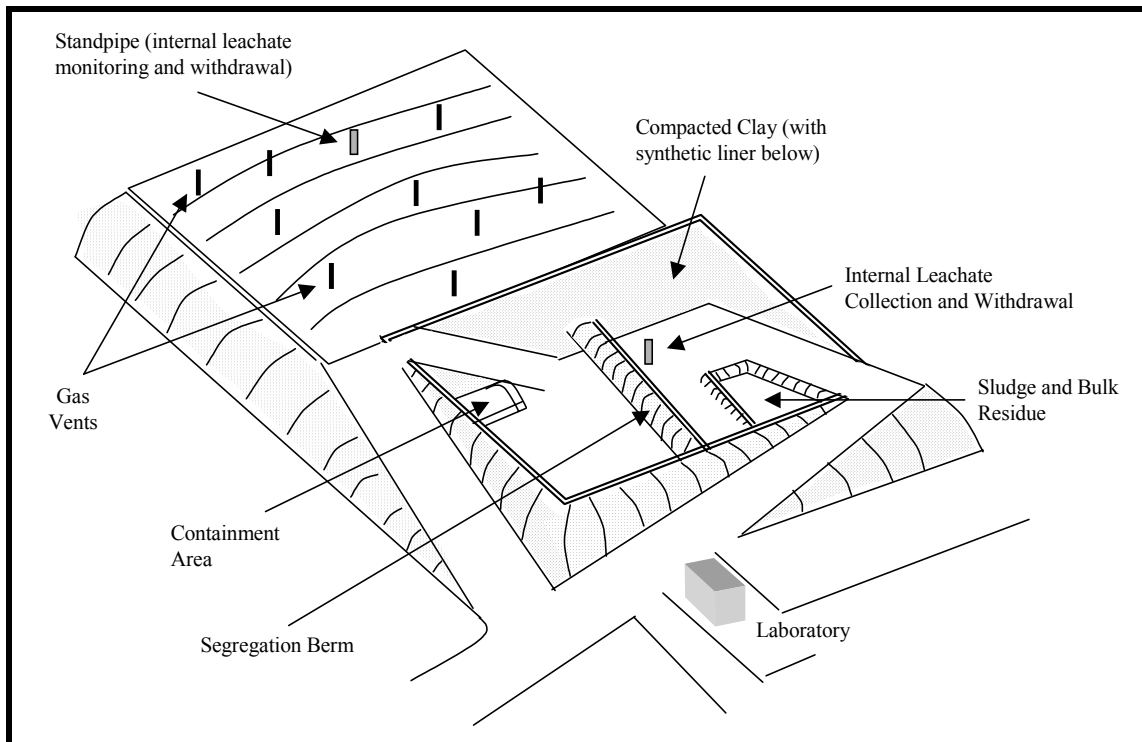

Figure XIV-13. Typical layout of a secure landfill

H. Development of the landfill

This section describes the steps involved in preparing a site for an orderly and sanitary operation.

H1. TERRAIN upgrading

One of the first steps in the development of a sanitary landfill involves the removal of all objects that may interfere with the operation and movement of vehicles and equipment. Consequently, trees, shrubbery, and other interfering vegetation should either be cleared from the site, or restricted to its periphery.

Secondly, the site must be graded so as to eliminate interfering surface irregularities. The surface of the site should be contoured such that a controlled runoff is promoted and ponding is prevented. Appropriate measures should be employed for minimising problems associated with erosion, the generation of dust, and sedimentation. To avoid danger of erosion and scarring of the land and to allow close supervision, large sites should be cleared in phases.

H2. ROADS

All-weather (permanent) access roads from the public road system to the site should be provided. With large sites, these access roads would be extended from the site's entrance to the vicinity of the working area. The roads should be designed to support the anticipated volume of pedestrian and vehicular traffic. Before the access roads are designed, it also is important to determine the size of vehicles and their probable range of speed, as well as the minimum service standards to be maintained. Adequate drainage should be provided to prevent the roads from flooding during wet seasons. Ideally, the roadway should consist of two lanes (minimum total width, 7 m) for two-way traffic. Grades should not exceed motorised equipment limitations: uphill grades, less than 7%; downhill grades, less than 10% [29]. Although the initial cost of onsite permanent roads may be higher than that of temporary roads, the difference in cost is more than compensated by

savings in equipment repair, maintenance, and time. Finally, the roads should be built to meet national standards. A cross-section of a typical access road is presented in Figure XIV-14.

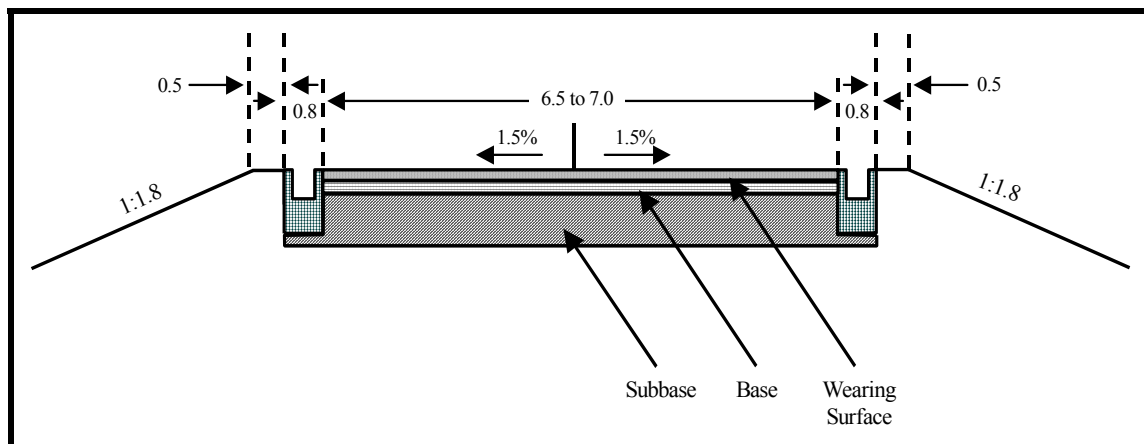

^a Dimensions are in meters.

Figure XIV-14. Typical cross-section of access road^a

Because the location of the working face is constantly changing, roads for the delivery of wastes from the permanent road system to the working face usually are temporary in terms of nature and construction. Temporary roads may be constructed by compacting the native soil and by digging drainage ditches. The roads may be topped with a layer of tractive material, such as gravel, crushed stone, cinders, broken concrete, mortar, or bricks. The use of lime, cement, or asphalt binders may increase the serviceability of the temporary roads. Road width is a function of road alignment and traffic volume. However, the width should be at least 3.5 m for a one-lane road and 6 m for a two-lane road.

If the expected truck traffic is only 25 to 50 round trips/day, a roadway composed of a graded and compacted soil usually would suffice. Traffic consisting of more than 50 trips/day probably would justify the use of calcium chloride as a dust inhibitor, or of binder materials such as soil cement or asphalt. Traffic consisting of more than 100 to 150 trips/day would necessitate a base plus a binder. The types of vehicles using a landfill will range from modern collection trucks to primitive forms of transportation, such as some of those described in the chapter on storage and collection. The types of vehicles using a landfill must be considered when designing the roadways in the fill.

H3. MEASUREMENT of weight (scales)

The importance of having an accurate knowledge of the gravimetric and volumetric amounts of wastes delivered to the disposal site has been discussed in previous chapters. Therefore, to the extent feasible, all incoming wastes should be weighed. In some situations, it may be necessary to install more than one scale in order to avoid long queues and to record the weight of the empty vehicles as they exit the site.

Types of scales range from highly automated electronic scales to simple, portable beam versions. The platform, or scale-deck, may be constructed of wood, steel, or concrete, such that the scale is horizontal and on a firm foundation. The scale should be able to weigh the largest vehicle that will come to the landfill on a routine basis. A capacity of 30 to 60 Mg probably would be adequate. Ideally, the platform should be long enough to weigh all axles simultaneously, although separate axle-loading scales (portable versions) would suffice for small operations. A photograph of a truck scale is presented in Figure XIV-15.

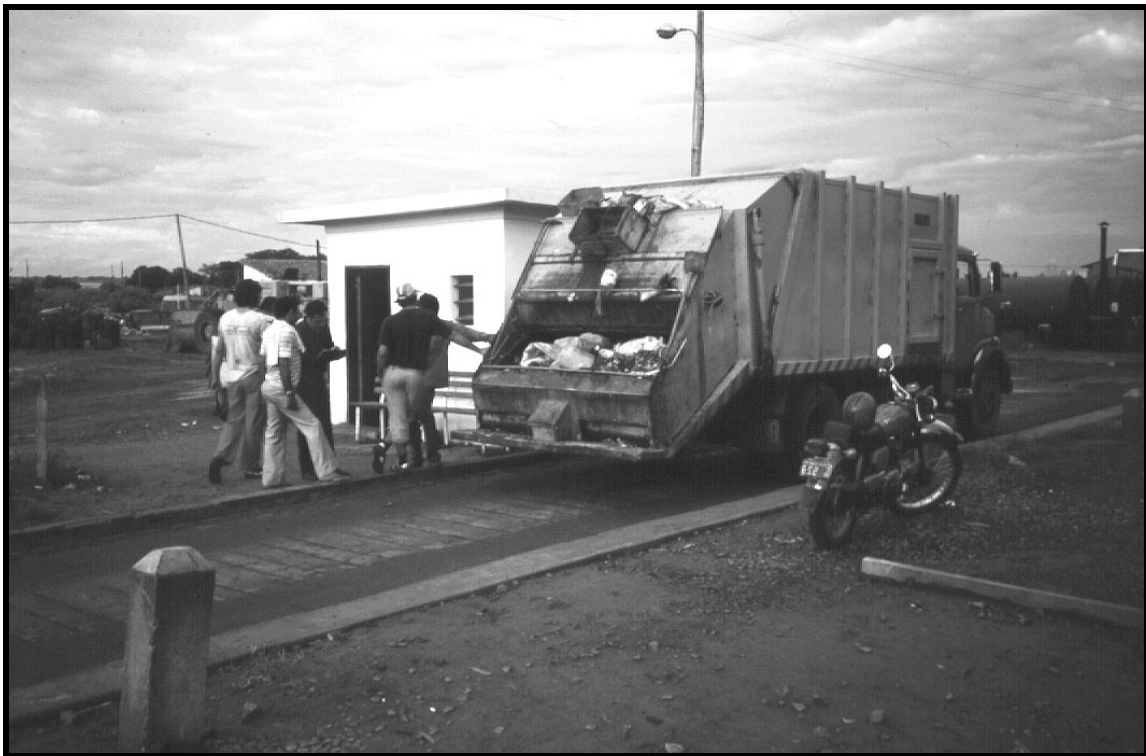

Courtesy: CalRecovery, Inc.

Figure XIV-15. Collection vehicle being weighed on a truck scale

The accuracy of the scale should be checked periodically using known weights.

H4. UTILITIES

Ideally, electrical, water, and sanitation services should be provided. However, the likelihood of all three being available at a disposal site in a developing country is unlikely. Electricity can be used for illumination and power. These two uses are almost essential if equipment maintenance and repair are to be done at the site. Electricity can be generated at the site by means of a portable generator. Water should be available for drinking, fire fighting, dust control, and employee sanitation. In the absence of access to a sewer, ventilated latrines should be built and maintained.

H5. STRUCTURES

If feasible, and particularly at large disposal operations, a structure or set of structures should be erected to provide office space; to house employee facilities; to provide a sheltered area for equipment storage, maintenance, and repair; and to serve as a scale house. The office space is needed for recordkeeping and the required clerical activities. Employee morale, well being, and efficiency are substantially benefited by providing a structure that includes: first aid facilities, provisions for workers' washing and changing, toilet facilities, and a canteen. The equipment structure serves as garage and repair shop. Buildings that will be used for less than ten years should be of temporary construction and preferably be movable. The design and construction of all buildings should take into consideration landfill gas migration and differential settlement of the fill. If these facilities are not provided at any but the smallest disposal sites, operation of the landfill will be impeded or compromised.

H6. FENCING

Access to the landfill site should be controlled preferably by building a fence around the entire perimeter of the site or, at the very least, around the locations of easy access to equipment and

wastes by unauthorised individuals. A fence also serves to restrict access to the waste by animals, screens the landfill, and delineates property lines. The type and height of the fencing are determined by the available resources and conditions prevailing at the site. Fencing of about 1.5 m in height and with a minimum of 5 cm openings usually is adequate.

Litter fences should be erected in the immediate vicinity of the working face to control blowing paper and other litter. A low (about 1 m) fence usually suffices at a trench operation; whereas, a 2 to 3 m height may be necessary at a windy, area-type operation. Litter fences should be portable. A diagram of a litter screen is presented in Figure XIV-16.

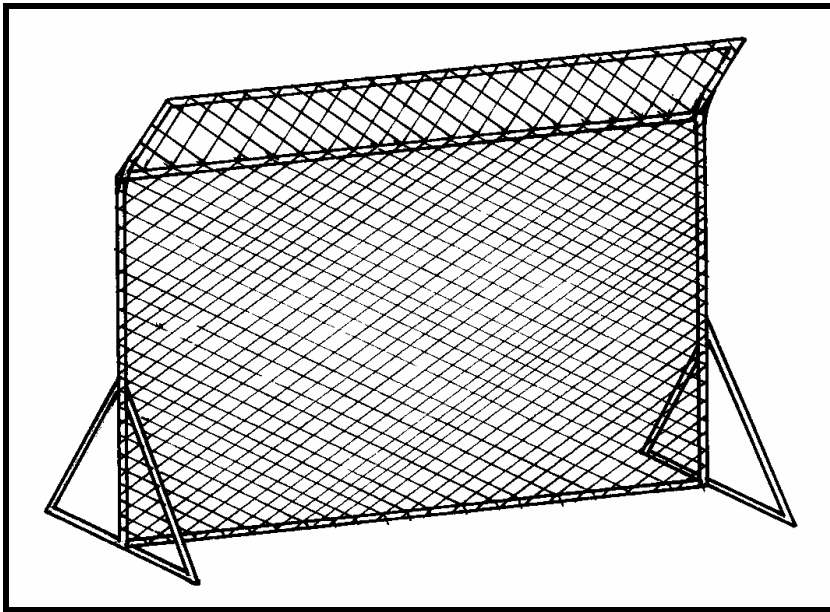

Figure XIV-16. Portable litter fence (2 m high, 3 m wide)

I. Operation

II. INTRODUCTION

This section presents an approach for the efficient operation of a solid waste landfill. A detailed outline of all daily activities is the basis of an effective operating plan. The plan must be sufficiently flexible to encourage managerial ingenuity in reaching the objectives, and sufficiently rigid to support proper operations. An efficient operating plan implies equipment that is compatible with the characteristics of the solid waste, the site conditions, and the method of landfilling

In this section, site operation is divided into two parts: 1) operational procedures that do not depend upon the method employed for landfilling, and 2) operational procedures that are specific to the method of landfilling.

II. GENERAL operating procedures

Operation of a sanitary landfill requires a series of activities, some of which are normally conducted continuously while others are conducted at a fixed frequency. Some of the more important operational procedures that must be considered for all methods of landfilling include:

- preparation and maintenance of the site,
- environmental control,

- hours of operation, and
- procedures during inclement climate.

A discussion of each of these key items is presented in the following sections.

I2.1. Site Preparation and maintenance

I2.1.1. Site preparation

Site preparation is an important aspect of the general operating procedures of a sanitary landfill. As a particular cell is completed, new areas must be cleared, excavated, and lined (if necessary). Similarly, as the working areas are filled, a final cover should be applied on them as soon as possible.

The sites must be prepared and constructed according to design specifications. Site preparation and construction include:

- clearing and grubbing,
- installation of leachate control systems,
- erection of structures,
- installation of utilities,
- constructions of roadways, and
- soil stockpiling.

I2.1.2. Road maintenance

Maintenance of access roads at landfill sites is one of those activities that should be conducted on a continuous basis. If performed well, road maintenance often is an expensive operation. Regardless of the type of surface (soil, gravel, or pavement), the roads must be inspected and repaired frequently. Typical repairs include cleaning, adding or grading soil and gravel, filling holes, and cleaning drainage ditches. Since road maintenance is a costly operation, typically it is neglected. Unfortunately, lack of proper road maintenance leads to equipment damage, unnecessary delays in operations, and safety problems. It may be advisable to leave a few sections of well marked rough areas on some roads in order to control excessive speed by vehicles using the site.

I2.1.3. General maintenance

All waste treatment and disposal sites require continuous care. The site manager is the person responsible for the preparation of a detailed maintenance schedule. Specific dates should be scheduled for the performance of the following tasks:

- collection and disposal of litter;
- relocation of portable fences for the management of litter;
- maintenance of gates, fences, and structures;
- maintenance of drainage system and final cover; and
- preparation and upkeep of final site maps.

As areas of the site are completed, a series of maps indicating the status of filling phases should be updated. The maps should identify areas used for special wastes, the fill depth of the various areas, the type of waste disposed, as well as other site-specific features.

I2.2. Environmental control

In most situations, regulations are established that require the inclusion of environmental controls in the design and operation of a landfill in order to protect the public health and the environment from potential negative impacts of landfills. The most commonly used types of environmental controls include impermeable barriers (liners), leachate collection and treatment systems, landfill gas management systems, and cover systems. The proper design and construction of these control systems are discussed throughout this chapter. Environmental controls are necessary to protect the environment during landfill operation and during the closure and post-closure periods. These practices are described in the following sections.

I2.2.1. Siltation and erosion

Runoff having relatively high concentrations of silt usually is brought about by improper grading. Grades with a slope of 2% to 5% should be maintained, where feasible, to promote surface drainage but at the same time to control flow velocities to acceptable levels. Denuded areas should be kept to a minimum during site operation. Ongoing construction and maintenance of sediment control devices (e.g., diversion ditches, rip-rap, sediment basins) are critical for an environmentally sound operation. During final closure and the post-closure period, proper final grading, seeding, and maintenance of a final cover system help prevent long-term problems as a consequence of erosion and siltation.

I2.2.2. Mud

Heavy rains and snow melt can result in the production of mud. In order to reduce the undesirable effects that mud can impose on daily operations, access roads should be elevated somewhat above the surrounding ground level, and paved or gravelled. Another alternative for road base where vehicular traffic is frequent is to mix soils of large particle size such as sand and gravel with clay soils. Mud can be tracked onto public roadways by landfill equipment or collection vehicles and can result in poor public relations for land disposal facilities [25]. Ideally, if the site is prone to muddy conditions, an area for washing the vehicles should be installed near the gate to the facility for the purpose of vehicular cleaning. Specific areas of the site should be identified for use during poor weather conditions and when conditions in other areas of the facility are muddy and would make operation difficult. Wet weather operation areas should be located as close to the main gate as possible in order to reduce onsite travel.

I2.2.3. Dust

Dust is generated at a landfill site by two main sources: 1) collection vehicles and heavy equipment moving over dry dirt roads, and 2) the wind. Dust can also be generated during the discharge, placement, and compaction of unusually dry materials or during the excavation and movement of dry soils. To reduce the amount of dust generation, access roads should be gravelled or paved. As an alternative, water or other environmentally acceptable dust control chemicals can be applied to dirt roads on a continuous basis. The practice in some developing countries of applying waste oils to roads should not be used because of the potential of pollution of land and water resources. Excavating or moving soils when they are damp also will limit dust production. Similarly, when a load of dry waste materials is brought to the landfill, it should be slightly moistened prior to disposal. Another means of reducing the total amount of dust generated from a particular facility is to revegetate completed areas as soon as possible.

Landfills should be equipped with a water truck or trailer to moisten dirt roads and working areas for dust control.

I2.2.4. Vectors and pests

Flies, mosquitoes, rodents, birds, dogs, and other animals are an occurrence at landfill sites. Vectors can be controlled by frequently placing an adequate quantity of compacted soil over the wastes or by chemical means, and by maintaining the smallest possible working face. It has been demonstrated that a daily cover consisting of 15 cm of compacted soil having a low clay content will prevent the emergence of flies. However, even under the best program of prevention and site conditions, a landfill should have a regular inspection and fly control program. Mosquito control is best accomplished by preventing the accumulation of stagnant water anywhere on the site (e.g., in old tires and depressions). The accumulation of stagnant water on the surface can be prevented by properly grading the surface, by filling depressions, and by placing cover soil over waste materials.

Occasionally, rats and mice may be delivered to the site with the solid waste. If harbourage occurs in areas adjacent to or in some neglected portion of the site, extermination by the local health department will be necessary. Employees at the landfill should be trained to recognise burrows and other signs of the presence of rats and mice so that appropriate management procedures can be put into force.

Although they may not be classified as “vectors” in the strict sense of the term, birds are discussed in this section because certain types become pests when considered in the context of a landfill operation. Birds generally are attracted to a landfill in search of food. This is particularly the case in landfills located in coastal areas, although most landfills will attract one type of bird or another. Birds can pose a serious hazard to aircraft and create a nuisance to landfill personnel and neighbours. In the United States, criteria for the classification of waste disposal facilities and practices indicate that solid waste facilities should not be sited within 3 km of an airport serving turbojets [26]. On rare occasion, certain species (for example, seagulls) can serve as vectors for certain diseases by way of their droppings or by serving as hosts to insectivorous vectors. As is true with problems arising from other pests, the bird problem is best met by rapidly and completely covering all wastes. Noise production, distress calls, or similar measures can provide some temporary control, but usually are not found to be consistently successful.

Access to wastes by animals such as pigs, cattle, sheep, and others should be strictly prohibited because of their ability to transmit pathogens directly or indirectly to humans.

I2.2.5. Odours

Several potential sources of unpleasant odours exist at landfill facilities. Odours may be generated in the following situations:

- at the time the waste is delivered,
- from decomposing waste in place at the landfill, and
- from storage ponds and liquid treatment systems.

Odours generated at the time the waste is delivered can usually be mitigated by rapidly covering the wastes and ensuring that the cover is maintained intact.

Occasionally, loads of particularly malodorous materials (e.g., market or fish processing wastes) may be delivered to the landfill. If at all possible, deliveries of these materials should be scheduled such that sufficient workers and equipment are available to immediately cover the waste. If not possible, malodorous loads can be mixed or covered with other wastes in order to control the problem. In some cases, the application of lime and/or chemical masking agents to the wastes can achieve some degree of odor control.

I2.2.6. Noise

The primary sources of noise at landfills are operating equipment and collection vehicles. The noise generally is very similar to that generated by any heavy construction activity, and is limited to the site and to the streets used to transport the solid waste to the site. In order to reduce the total number of individuals exposed to the noise, every effort should be made to route traffic through the least populated areas. In addition, the site should be isolated or surrounded by a buffer zone such that the noise will not disturb neighbours. The installation of noise barriers such as berms, walls, and trees are effective measures of control.

I2.2.7. Aesthetics

In order to maintain environmental impacts to a minimum and to make the landfill acceptable, the site should be designed to be as compatible with its surroundings as possible. During site preparation, it is important to leave as many trees as possible to form a visual barrier. Berms can also be used to form visual barriers. The use of architectural effects at the entrance, confining disposal to designated areas, and the use of attractive landscaping will assist in the development of an aesthetic facility. Additionally, every attempt should be made to minimise the size of the working area.

I2.2.8. Litter

One of the most frequent complaints from residents living near landfills concerns blowing litter, particularly light materials such as papers and plastics. Blowing litter can be substantially reduced by:

- discharging the waste at the toe of the working face,
- application of water or damp waste to loads containing a high concentration of paper and/or plastics, and
- installation of portable or stationary fencing around the working face.

In addition, if soil cover or another material is available, frequent and thorough covering of the face and completed portions of the cell can play an important role in the control of litter.

Generally, despite the operators' best efforts and control measures, the accumulation of some litter is inevitable at a landfill site. The installation of a fence around the site or downwind from the site will help to contain litter and keep it from reaching adjacent property. Daily cleanups, particularly at the end of the working day, can limit the quantity of litter that can eventually reach other property.

I2.2.9. Fires

Potential sources of fires at landfills include receipt of wastes containing hot embers, sparks from vehicles, equipment fire, and vandalism. A good security program, combined with alert vehicle

spotters, can control most of the problem. Hot and highly flammable wastes should be directed to special areas in the landfill and moistened or smothered with soil prior to disposal. All landfill vehicles should be equipped with fire extinguishers to limit damage in the event of an equipment fire.

If a water line is not available, a water truck or trailer equipped with a gas-powered pump should be always be on-hand at all but the smallest landfills. There are several techniques available for managing landfill fires. Fires near the surface of the fill can be excavated and extinguished with soil and/or water. Deep fires can sometimes be extinguished by placing damp soil on the surface of the fill, by injecting water into the burning section of the fill, or by excavating and extinguishing the waste. Deep landfill fires are very difficult to extinguish completely.

If landfill gas collection systems are present in a landfill where waste is burning, their continued operation must be given due consideration. Gas extraction wells can draw air into the fill and thus be a source of additional oxidiser (oxygen). Additionally, the wells can collect the byproducts of the waste combustion products, which can lead to degradation or destruction of the wells, piping, and control systems [90].

Open burning of combustible materials should be strictly prohibited at all disposal sites. The common practice of open burning for volume reduction or for salvaging (i.e., removal of insulation from aluminium and copper wire) should not be allowed at any type of waste disposal facility.

12.3. Operating hours

The operating hours at a landfill typically are set by the collection schedules. However, in some cases, collection practices can be modified to accommodate site operations. Generally, landfill sites in the United States are open from about 6:00 am to mid to late afternoon. The hours of operation of both the collection system and of the landfill should take into consideration local traffic conditions.

Operating hours may be modified based upon the quantity of waste produced during a certain time of the year. In the event that the site is not open 24 hr/day, the gates should be closed sufficiently early to allow for covering of the waste and general cleanup. Containers may be placed outside the gate to allow for the disposal of small quantities of wastes after operating hours.

Personnel should arrive at the facility sufficiently early to prepare the equipment and the site before the arrival of collection vehicles. Some of the tasks that are carried out prior to the arrival of collection vehicles include: snow plowing (where appropriate), relocation of fencing for litter, maintenance of equipment, fuelling, preparation of unloading areas, and cleaning of roads.

12.4. Inclement climate

Climatic conditions can significantly affect the operation of a landfill. Long periods of excessive rainfall, freezing temperatures, or extreme heat can disrupt routine operation of a landfill.

The relative amount of rainfall during site preparation has a direct impact on the moisture content of the soil, as well as on groundwater saturation levels. Both of these parameters are important in the control of soil strength and permeability during construction of a clay liner or other compacted soil components. Extremely low temperatures (i.e., freezing conditions) during construction of the landfill site also impact soil workability and permeability. Temperature levels also affect the installation of flexible membrane liners, in particular seaming requirements.

Weather conditions also have an impact on the performance and operation of the facility. This is particularly true in economically developing countries where heavy rainfall often results in extremely muddy access roads and unloading areas, thus leading to long delays. Extremely high precipitation also has an impact on the water table. An excessively high water table may increase the groundwater pressure on the sidewalls of a trench operation, resulting in unstable conditions and landslides. One of the more effective means of managing high rainfall is to construct and maintain drainage canals on the periphery of the site to divert water from the wastes. In the event that the site is relatively flat, one option is to design relatively small and well contained cells properly sloped for the collection of the leachate. Another alternative is to install leachate collection systems to control some of the problems associated with copious precipitation. However, the leachate collection system also must have the capacity to absorb the high flow rates, otherwise the liquid pressure in the facility will increase. High liquid pressure may result in migration of water and leachate from the site. Decreased soil density, which may cause liner instability, may also result from heavy precipitation.

On the other hand, very dry environmental conditions may make the soil hard to excavate or compact. Furthermore, in the absence of moisture, organic matter does not readily decompose. In arid areas, evaporation generally is greater than rainfall. Consequently, very little or no leachate is formed from the waste after disposal. Landfills in arid and semi-arid regions may be operated without liners and leachate collection systems. In fact, it has been suggested that the best sites for landfills are in arid regions [30]. Excessive drying of the soil used in the cover or bottom liner during construction can lead to the unwanted formation of cracks and increase the permeability of the soil.

Freezing temperatures may cause stockpiles of soil to freeze and become unusable. In extreme cases, very low temperatures may affect the proper operation of site equipment as well as the main components of the leachate collection system that are located above the frost line. Efficient operations require that operational problems of this nature be anticipated and contingency plans be developed in order to address the problems satisfactorily. Table XIV-2 lists problems due to inclement weather and potential means of managing them.

13. SELF-HAUL

The majority of waste disposal sites allow the discharge of wastes by private individuals. These individuals are known as self-haulers. Typically, medium- and small-size vehicles comprise a considerable portion of the traffic. These users (either small haulers or private individuals) usually are not familiar with practices at the site, can damage their vehicles, can cause delays at the working face, and may cause accidents.

Some options exist for managing vehicles operated by self-haulers. The operation of the vehicles can be directed to designated areas of the working face, remote from the large collection or transfer vehicles. Alternatively, some type of transfer system can be implemented. Transfer systems commonly used consist of strategically located large self-dumping trailers. The loaded trailers are periodically towed to the working face, and emptied. Other possibilities include the use of dump trucks or roll-off containers. Normally, a platform is constructed to facilitate the unloading of small quantities of waste into the large containers.

Table XIV-2. Inclement weather practices

Problem	Method of Management
<p>Wet Weather Access roads are muddy</p> <p>Unloading area is muddy</p> <p>Soil is wet/unworkable</p> <p>Soil permeability/density varies from design</p> <p>Leachate collection system clogging from runoff and sedimentation</p> <p>Dry Weather Soil is dry -- unable to excavate and increased permeability</p> <p>Cold Weather Soil freezes</p>	<ul style="list-style-type: none"> • Add cinders, crushed stone, or demolition debris • Maintain a special working area that has permanent roads • Stockpile well drained soils and apply as necessary • Keep compactive equipment off area by unloading and moving refuse perpendicular to area • Grade unloading area slightly to permit runoff • Maintain compacted, sloped stockpiles and/or cover with tarpaulin • Do not compact soils in overly wet weather • Cover the soil • Add barriers for fines • Periodic cleaning of pipe network • Cover the soil to prevent drying • Moisten the soil • Insulate stockpiles with leaves, snow, or straw • Add salt to the soil • Continually strip and cut soil • Maintain well drained soil/sand • Use hydraulic rippers on frozen soil

The transfer point should be located inside the gate and as close as possible to a good access road. This area should be located such that it can be continually monitored by site personnel. For the most advanced areas of developing countries, the alternative to continuous direct monitoring would be the use of closed circuit television. If utilisation by self-haulers is high, an employee may need to be permanently assigned to the site to supervise and operate the facility. A resource recovery operation (drop-off centre) can also be added if supervision is available. Transfer facilities are oftentimes the source of problems, especially from abuse by the users. Litter is a common problem and fires may take place in the container(s). Nevertheless, the value of some type of transfer system usually is justified in terms of simpler and safer operations at the working face, improved public relations, and reduced roadway costs.

14. SALVAGE/scavenging

Scavenging or uncontrolled sorting through raw wastes to recover materials that may be reusable is a common practice in most developing countries. This practice is strictly prohibited at the

working face of a landfill in industrialised countries because there is a high risk of injury and a potential health hazard to the scavenger. In locations where regulations allow controlled salvaging, the practice can be conducted (as discussed in another subsection) away from the working area by individuals under direct supervision of the operator. Salvaging operations and storage must be confined to a specific area or facility so that they will not interfere with landfill operation. Strict controls must also be established on the types of materials that can be recovered, location and type of storage, and removal frequencies so that nuisance conditions do not develop. The individuals working in the salvaging area should be provided with uniforms, hard hats, masks, boots, and basic sanitation services. Additional information regarding the design of resource recovery facilities is provided elsewhere.

15. WASTE receipt and vehicle routing

Every landfill site should have only one entrance and that entrance should be carefully controlled. A controlled entrance enables operators to: 1) keep records of weights or volumes of incoming loads, 2) direct incoming vehicles to a particular area, and 3) reject materials that cannot be disposed on the site. A sign should be placed at or near the entrance. The sign should clearly indicate applicable regulations, operating hours, user fees, emergency telephone numbers, permit information, and other relevant information.

Keeping control of the quantity and general types of wastes received at the site allows operators to evaluate the efficiency of the operation in terms of land use and compaction. These records also allow the operator to predict, with a certain degree of accuracy, the remaining capacity for the site. Remaining site life can be calculated with the help of topographical or aerial surveys. Aerial surveys may be unnecessary and too costly in some locations. In addition, a good understanding of the quantity and types of wastes reaching the site is very useful in determining user fees. There are various methods to monitor the quantities of waste received. Most large, modern landfills use a truck scale. Although it is preferable to monitor weights, small sites may decide to simply record volumes. If a truck scale is not available, weights may be obtained through a survey, over a short term, using a scale located away from the site. The results of the survey can be used to develop user fees and to estimate waste receipts over an annual period. This method does not take into consideration any changes in the characteristics of the waste stream.

16. SPECIFIC operational procedures in a sanitary landfill

There are three basic operational procedures that depend on the method of landfilling. The procedures are: 1) site preparation, 2) traffic flow and unloading, and 3) waste covering and compaction. These procedures are presented as a function of the two basic methods of landfilling -- area or trench.

The sequence and method of operating a sanitary landfill are dictated by a number of factors that are specific to a site. Some of the most important factors include physical site characteristics, types of waste, and the rate of receipt of waste.

As has been previously indicated, the main difference between the trench and area methods is that the trench operation employs a prepared excavation and, as such, confines the working face between the two sidewalls. The area method, on the other hand, does not use extensive surface preparation. The width of the working face for the area method is, theoretically, unlimited. Sometimes, landfills utilise both methods, depending upon the specific circumstances. For example, initial disposal operations may utilise a trench design and, subsequently, the area method may be used on top of the completed trench fill. There are some variations to the two basic methods; they include progressive slope, progressive trench, and the cut and cover approach.

The specific operational features of the area method are described first. Many of the features that characterise the area method also characterise those of the trench method, as well as the other less common methods of landfilling.

I6.1. Area method

As previously indicated, the area method typically is used in natural depressions, in prepared areas, or on top of filled trenches. The subgrade may consist of either natural soil, a prepared surface using liners, or compacted soil or soil supplements. The use of any of these materials depends upon local regulations and design preferences. Area fills generally use the land more efficiently than trench operations. Area fills, on the other hand, may require imported soil for liners and covers.

I6.1.1. Site preparation

The primary objective in preparing a site for an area fill is to use most of the available soil that meets the design requirements. At the same time, site preparation should keep to a minimum disturbance of natural soil and vegetation. In order to accomplish these objectives, it is necessary to conduct a comprehensive inventory of the amount and type of soil available.

Excavations should follow a particular sequence so that the soil that is removed can be used elsewhere onsite, preferably without resorting to stockpiling. This procedure eliminates double handling and increased costs. A model has been developed to provide assistance in the planning of soil movement [27]. However, stockpiling a certain volume of soil is frequently necessary in order to take full advantage of the various types. For instance, topsoil should be stockpiled for use on roads, as daily cover, or for the construction of leachate collection systems or surface drainage systems. Clay may be selectively excavated and used as liner material, dikes, interim and final cover or, if necessary, used to supplement subgrades.

Soil that is stockpiled should be placed in specific areas, compacted, and appropriately sloped to maintain it as dry as possible. Soil should be stockpiled as close to the location where it will be used as practical. Stockpiles should never be placed in areas where they will interfere with traffic, cover soil that might be needed for other functions, or impede the function of drainage control systems.

I6.1.2. Traffic flow and unloading

The general procedure for managing the waste at the gate is discussed elsewhere. The procedure is applicable to both the area and trench methods.

The procedures for spreading, compacting, and covering the waste can be facilitated by controlling the position of the collection vehicles during the unloading process. If the collection vehicles are directed over previously filled areas, the areas should be well compacted. When possible, demolition debris and other dense rubble should be placed to take advantage of the drainage plan. Roads should be designed and built such that they do not interfere with stockpiling or soil handling.

The working face should be as narrow as possible without interfering with normal operations. The width of the working face generally is a problem in the operation of land disposal sites in developing countries. To facilitate this, an operator should be at the face of the fill during working hours using a whistle, a bullhorn, or flags to direct incoming vehicles to the desired area of the working face. Barricades and markers should be used to delineate the area that is used on a given day.

It there is a choice, it is preferable to keep the unloading area at the toe (bottom) of the working face. This is because spreading and compaction are easier and generally more effective when performed from the bottom to the top. If the unloading is carried out from the top, care must be taken to prevent the waste from being pushed onto a steep working face with little or no compaction applied until the end of the day, or with infrequent compaction performed. This type of practice is one of the more common operational ones in developing countries. In some situations, a platform is built on the top by compacting refuse and applying a layer or several layers of soil. This type of operation can lead to unstable conditions and landslides if the weight of material on the top of the slope is too great and the slope is too steep.

Unloading at the toe generally reduces blowing litter. The unloading area should be kept clean and level to prevent vehicles from being damaged or tipped. In small sites, it may be necessary to provide an unloading area that is wider than the working face. At large sites, or at sites that process large quantities of wastes in relatively short time spans, a portion of the unloading area should be set aside for unloading trucks manually. If the face of the fill is not sufficiently wide to allow for this process, manually operated vehicles may be routed to the top of the lift so that unloading does not impede the other traffic.

16.1.3. Covering and compacting solid waste

Compaction and, in particular, covering of the waste are two important operations of a conventional sanitary landfill in industrialised countries. However, as previously discussed, there are some conditions under which the wastes may not have to be covered on a daily basis.

In general, spreading and compacting operations should be aimed at achieving proper cell density, height, slope, and width throughout the day.

The compacted density of the solid waste depends upon the following variables: 1) thickness of the layers, 2) composition and characteristics of the waste, 3) number of passes made by the equipment applying the compaction, and 4) compactive effort of the equipment. Compactive effort is primarily a function of the gross weight of the equipment, bearing pressure, and striking impact (if applicable). Although additional passes result in higher compaction, the return for the effort diminishes beyond six passes. An experienced operator should know when additional passes will result in greater compaction. In order to prevent soft spots in the fill area and eliminate uneven settling, excessively wet loads should be separated and mixed with dry materials before and during spreading. The slope of the working face also has an important influence on the compactive forces being applied on the waste. A schematic diagram of the compaction process is shown in Figure XIV-17. As shown in the figure, the effective compactive force acting on the waste is the product of the weight of the equipment multiplied by the cosine of the slope. Consequently, as the slope of the working face increases, the effective compactive force decreases and, conversely, the potential of slippage on the slope increases. There may be some situations where it may be difficult to avoid a steep slope; in fact at the end of the day, it may be desirable to have one in order to reduce the amount of cover material required and the nuisance potential. In those situations where a high in-place compaction is desirable, the slopes should be as gentle as possible. The tradeoff is need for more cover material and a larger area for the working face. An operator can perform some practical procedures in order to achieve high compaction densities. One of these procedures involves combining low-density, dry materials (such as paper or textile waste) with high-density, moist wastes (such as restaurant or market residues).

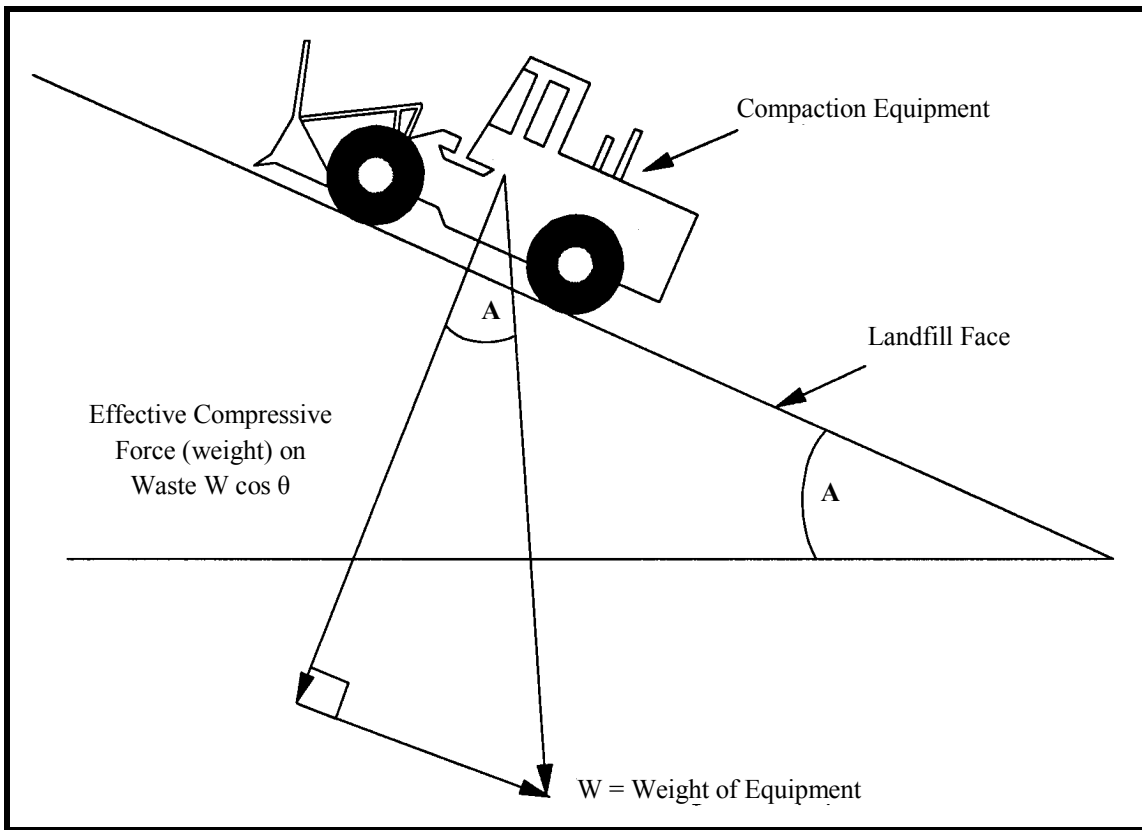

Figure XIV-17. Compaction of waste on a sloped surface

One important advantage of compaction is the increase in the capacity of the landfill. Consequently, if the plan is to optimise landfill capacity, continuous measurements of the in-place density, as well as of the remaining landfill capacity, should be carried out. Typically, the most common method of determining the degree of compaction accomplished in a landfill has been to estimate the volume of the incoming waste and either estimate or measure the in-place volume. The ratio of the incoming volume divided by the in-place volume determines the "compaction" ratio. However, these calculations simply are estimates, and they do not provide an accurate indication of the actual situation. Accuracy is particularly important in locations where disposal space is at a premium and lifespan of the disposal facility must be known to a high degree of accuracy. The most reliable means of determining the in-place density is by weighing the incoming waste and dividing it by the actual volume of the space occupied by it in the fill.

Tests can be carried out to determine the in-place density in a particular landfill and ascertain the optimum parameters to achieve the practical degree of compaction. As shown in Table XIV-3, there are a variety of variables that impact the in-place density of the refuse.

Table XIV-3. Some variables that impact the in-place density of refuse

- Characteristics of waste
- Thickness of lift
- Slope of working face
- Number of compactor passes
- Type and weight of compactor
- Design of compactor's wheel
- Condition of cell base
- Experience of operator
- Type of cover material

The final height of a lift usually is determined by the grade plan for the facility, soil usage, and operational limitations. In the case where extremely deep fills with a large number of lifts are used, the height of the lift may be limited by the equipment. For instance, a lift may be limited to the maximum height at which a scraper can provide complete coverage with one pass. Typical heights for lifts range between 2 to 4 m.

The relationships between density and the number of passes, as well as the thickness layer, are presented in Figure XIV-18.

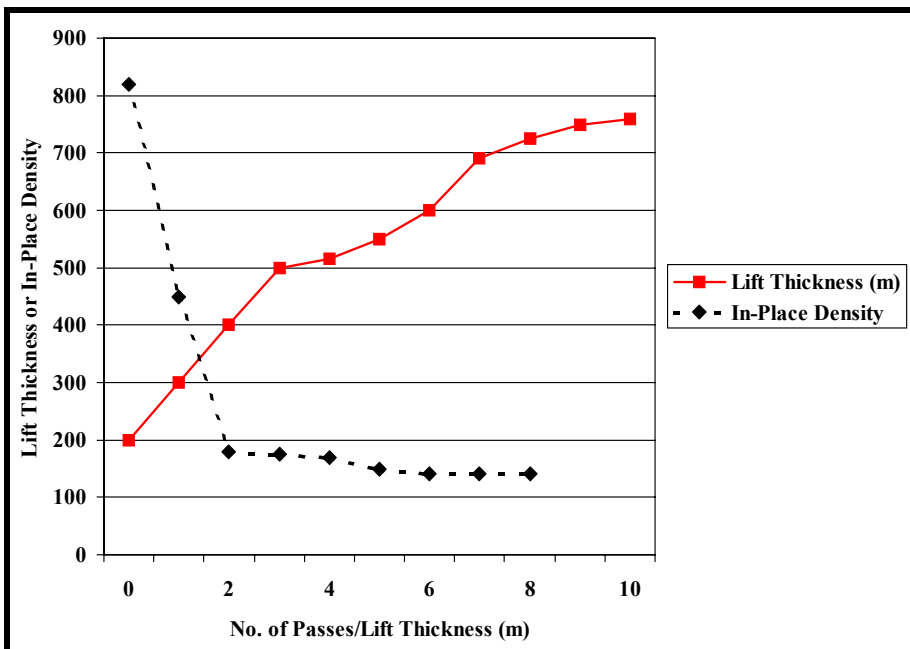

Figure XIV-18. Impact of compactor passes and lift thickness on landfill density

The slope of a cell generally should not exceed 20°, or about 3:1 (horizontal:vertical), and should never exceed that which results in structural instability of the mass. The slope should be established with initial loads and maintained constantly throughout the day.

As discussed earlier, there are three types of soil cover: daily, intermediate, and final. The thickness of each type depends upon the duration of exposure to the elements, as illustrated in Table XIV-4.

Table XIV-4. Thickness of cover soil and exposure time

Type of Soil Cover	Minimum Thickness (cm)	Exposure Time^a
Daily	15	0 to 30 days
Intermediate	30	30 to 365 days
Final	60	> 365 days

^a Length of time cover material will be exposed to wind and rain.

The stockpiling of soil for covering and the method of application of the soil should be performed such that the cover will not be littered with waste. These goals can be achieved by depositing the cover material at the top of the cell or adjacent to the working face. At the time that the cover is applied, the spreading equipment should only travel over the cover. The equipment should not travel through refuse onto fresh cover because this tends to draw waste on top of the cover material. The tires for the various types of equipment should be cleaned of waste before applying or compacting the cover.

Scrapers and draglines are the most frequently used types of equipment for the application of cover material. Scrapers reduce the amount of double handling. Unfortunately, the tires may be damaged by the waste materials. Draglines can also be used for the application of cover material. The use of draglines, however, requires additional grading and compacting of soil. Regardless of the placement method, the cover should be compacted and smoothed. Typically, two passes using appropriate equipment will provide sufficient compaction for daily cover soil.

The main purposes for applying daily cover are to control vectors, litter, odor, water infiltration, and, to some extent, fire. The solid waste should be compacted immediately prior to placing the daily cover. Compaction of the waste will level the site and facilitate both covering and subsequent operations by providing a smooth surface. If soil is used as cover material, a minimum compacted thickness of 15 cm is sufficient to accomplish the objectives. The thickness may exceed 15 cm if a greater depth is required to cover all of the waste. Cover should be applied to the top and side slopes as cell construction progresses. This procedure serves to control generation of litter, and also results in the working face only requiring cover at the end of the working day [29]. Experience has shown that materials other than soil may be safely used to cover the waste. Some of these materials include: composted or partially composted yard wastes, the fine residues of construction and demolition debris, dredge spoils, and other materials. Designers and operators of sanitary landfills in developing countries should conduct their own evaluations of potentially suitable materials for daily cover.

Intermediate soil cover has the same general function as daily cover. The intermediate cover, however, remains exposed to the elements for a longer period of time than the daily cover. The intermediate cover may also serve as a temporary surface for traffic movement. In fact, it generally is recommended that traffic move on intermediate surfaces in order to continue the compaction process. The minimum compacted depth for an intermediate cover is 30 cm. This cover should be placed on the lift surface as soon as possible, but kept a sufficient distance away from daily activity to prevent littering from equipment moving over it.

Completed areas should be covered with a final layer of soil as soon as possible. It generally is recommended that the final cover have a minimum thickness of 60 cm. The depth and type of soil to be used and the compaction requirements should be specified in the facility design and operation plan. All but the upper few inches should be compacted in order to keep the soil permeability as low as possible. Topsoil should be added to the surface of the final cover. Seeding, mulching, fertilising, and pH adjustment should follow final covering. An EPA

publication provides useful information on standard procedures for planting vegetation on final covers [28]. A separate discussion of cover systems is presented earlier in this chapter. Soil used as final cover should not be applied when it is too wet or frozen. A certain amount of soil should be saved after site completion to facilitate any grading that may be required to maintain an even surface. Completion should be phased such that once the final cover is applied, no traffic should be permitted on the completed area.

I6.2. Trench method

The trench method is most applicable on flat or gently rolling ground with deep soils. The widths and depths of the trenches can vary substantially from site to site. Trench operations usually result in excess soil and provide lateral confinement at the operating face. For a given level of productivity, a trench operation may require more land and equipment than an area operation. In addition, trench operations may need extensive soil stockpiling and handling.

I6.2.1. Site preparation

Generally, the depth and width of the trench are specified in the design and operation plans. The excavation of the first trench and also portions of later trenches may require stockpiling of large quantities of soil. The stockpiling must be conducted such that it will allow the soil to be available for use as liner and/or cover material and will not interfere with the fill operation.

As previously indicated, the size of unexcavated areas between trenches depends upon the depth of the trench and the characteristics of the soil. In general, the more cohesive and stable the soil, the less distance that will be required between the trenches. On the other hand, as the depth of the trench increases, more distance, in general, will be required between the trenches.

The amount of soil handling and stockpiling can be reduced by following either of two approaches. The first approach is called the phased fill and covering. This approach uses soil from a trench being excavated to provide cover for an adjacent trench that is in the process of being filled. Soil from the first trench must be stockpiled. The second approach is known as the progressive trench. The progressive trench method uses soil excavated from one end of the trench as cover material for waste deposited at the other end of the same trench.

I6.2.2. Traffic flow and unloading

The working face in a trench operation usually is more sharply defined than in an area operation. In the trench method, waste may be discharged over the edge (i.e., lip) of the excavation or from within the trench. Operational procedures must be developed according to the method of discharge. Stability of the sidewall is critically important if the unloading is going to take place from the edge of the trench. In addition, allowances must be made to prevent the vehicles from falling into the trenches. Typically, logs or poles are placed near the edge of the trench. A spotter should be present during unloading operations.

It is preferable in a trench operation that the waste be discharged from within the trench. In this particular case, a ramp leading to the base of the trench should be built, and maintained at a grade appropriate for vehicle traffic. Contingency plans should be provided during wet weather or when other situations make the ramp hazardous or difficult to use.

Traffic control for unloading of waste in the trench operations is similar to that for area fills. Likewise, waste handling practices described earlier for the area method also are common to trench operations, except for some special circumstances. The walls in the trench help control the width of the face and size of the cell. On the other hand, the walls of the trench can interfere with

compaction if the side slope is too steep for the wheels or tracks to reach the side and still maintain blade clearance.

Narrow trench operations may experience a rapid buildup of waste during peak periods of deliveries. In such situations, adequate compaction cannot be obtained if the waste is discharged on the face. In order to prevent this undesirable situation, it is best to loosely compact the waste in the trench, and spread and compact it thoroughly when time permits.

I6.2.3. Covering and compacting solid waste

Soil cover should be placed at the same times and depths as specified for the area method. When an area fill is placed on top of a trench fill, the operation should be phased such that the area fill is commenced as soon as possible after the completion of the trench fill. This procedure will help to prevent loss of soil and to achieve the desired ratio of soil to refuse. Sufficient soil for cover should be made available from the trench operation so that area lifts on top of the completed trench fill will have adequate cover.

J. Water management

The two primary types of water resources to be protected from landfill operations are surface waters and groundwater. Surface waters may be contaminated by runoff or leachate from the landfill; whereas, groundwater may be polluted by leachate. The primary objective is to directly and indirectly prevent the landfill from adversely influencing flows to the water resource. This is best accomplished by excluding from the water resources any inputs that originate in the landfill.

J1. SURFACE water

The first step in proper water management is to minimise surface waters entering the sanitary landfill. Upland drainage can be accomplished by means of pipes through fills that are located in gullies, ravines, and canyons. Runoff from areas surrounding the fill can be excluded by excavating a series of channels or shallow ditches to collect and divert the runoff.

All runoff from the disposal site and the fill itself must be excluded from all unaffected water resources. This is done by channelling the runoff to a collection and storage site, where the runoff can be treated. Ultimately, however, the best recourse is to exercise careful control over the amount of water subsequently retained on the fill site and the length of time the runoff is retained there. The longer the retention time, the greater the opportunity for the water to be contaminated before it leaves the site. Since runoff from the fill itself occurs only when the upper surface of the fill is as high or higher than the level of the surrounding land, an effective means of minimising the extent of degradation of the runoff is to shorten the time it is retained at or on the fill. Grading the landfill cover promotes efficient runoff of rainfall. The grade of the cover should be determined on the basis of the planned use of the completed site and of the ability of the cover material to resist erosion.

Surface water that runs off stockpiled cover material should not be allowed to enter watercourses without having been previously intercepted and ponded to remove settleable solids. A complete surface water plan must be developed with other preparatory planning for the site.

J2. GROUNDWATER

The basic premise of the protection of groundwater quality is that landfilled solid wastes and any leachate from the wastes not be allowed to come into contact with and, thus, contaminate groundwater. Leachate and leachate formation are described later in this chapter. In short,

leachate is generated by the passage of water through the solid waste in a fill. If moisture is already present in the fill, it is termed primary leachate. If the moisture comes from rainfall infiltrating into and percolating through the fill, the leachate is termed secondary leachate. In both cases, the eventual composition of leachate is a function of the type of solid wastes deposited in the fill, age of the fill, and several other factors.

The degree of required separation of waste from the groundwater is determined by the potential of the leachate for contaminating the groundwater. The risk of contamination is greatest when the leachate contains toxic and hazardous compounds and/or when underlying material is highly permeable. The degree of separation necessary to protect groundwater quality increases with the potential for contamination. One should not plan on the leachate being diluted in the groundwater because the usually laminar pattern of groundwater flow allows very little mixing to occur in an aquifer.

A preliminary step in protecting groundwater quality is to ensure that a suitably thick layer of soil is between the bottom of the fill and the groundwater. The interposition of the layer permits some attenuation of leachate that percolates through the layer. However, in recent years, the fund of knowledge and the depth of the understanding of leachate and its contaminating characteristics have revealed the limitations of natural attenuation that takes place in the soil layer.

J3. WATER balance and the formation of leachate

The rate of production of leachate can be calculated by performing a water balance. A water balance involves an accounting of all of the sources of water entering and leaving the landfill, including the water used in biochemical reactions and water leaving the landfill in the form of water vapour in the landfill gas. The quantity of leachate that could potentially be generated is that which exceeds the moisture-holding capacity of the material in the landfill.

J3.1. Water balance

The various components of a water balance for a landfill are presented in Figure XIV-19. As shown in the figure, the primary sources of water are: water entering the fill through the cover (precipitation), moisture in the cover material, groundwater inflow, and inherent moisture in the solid waste. In addition, a small amount of water is formed as a byproduct of decomposition of the wastes. Water leaves the landfill in the form of saturated vapour in the landfill gas, and through transpiration. The remainder of the water is either stored by the waste or becomes leachate.

The vegetation on the cover utilises water to build plant tissue and results in water loss by transpiration.

The total amount of moisture that can be stored in a unit volume of soil is a function of two variables -- the field capacity (FC) and the wilting point (WP) of the soil. The FC of a soil is defined as the quantity of liquid that remains in the pore space following a prolonged period of gravitational drainage. The WP of a soil is defined as the quantity of water that remains in a soil after plants are no longer capable of extracting any more water. The difference between the field capacity and the wilting point is equivalent to the quantity of moisture that can be stored in a particular type of soil.

Since a potential major contributor to the formation of leachate is precipitation, an estimation of its infiltration into the cover is an important aspect of establishing the water balance on the landfill system. The estimation of infiltration of precipitation into the cover is one of the more complex of landfill analyses. Flow of water from precipitation in a vertical percolation layer

either is downward (due to gravity drainage) or removed via evapotranspiration. A computer model has been developed for the purpose of performing the complex computations that are required to predict the amount of water that infiltrates, or percolates, through a cover system composed of layers of different characteristics. The model is called “Hydrologic Evaluation of Landfill Performance (HELP)” [12]. Other approaches also are available for estimating the amount of percolation that can be expected in a landfill, including the use of a conventional hydrological water balance.

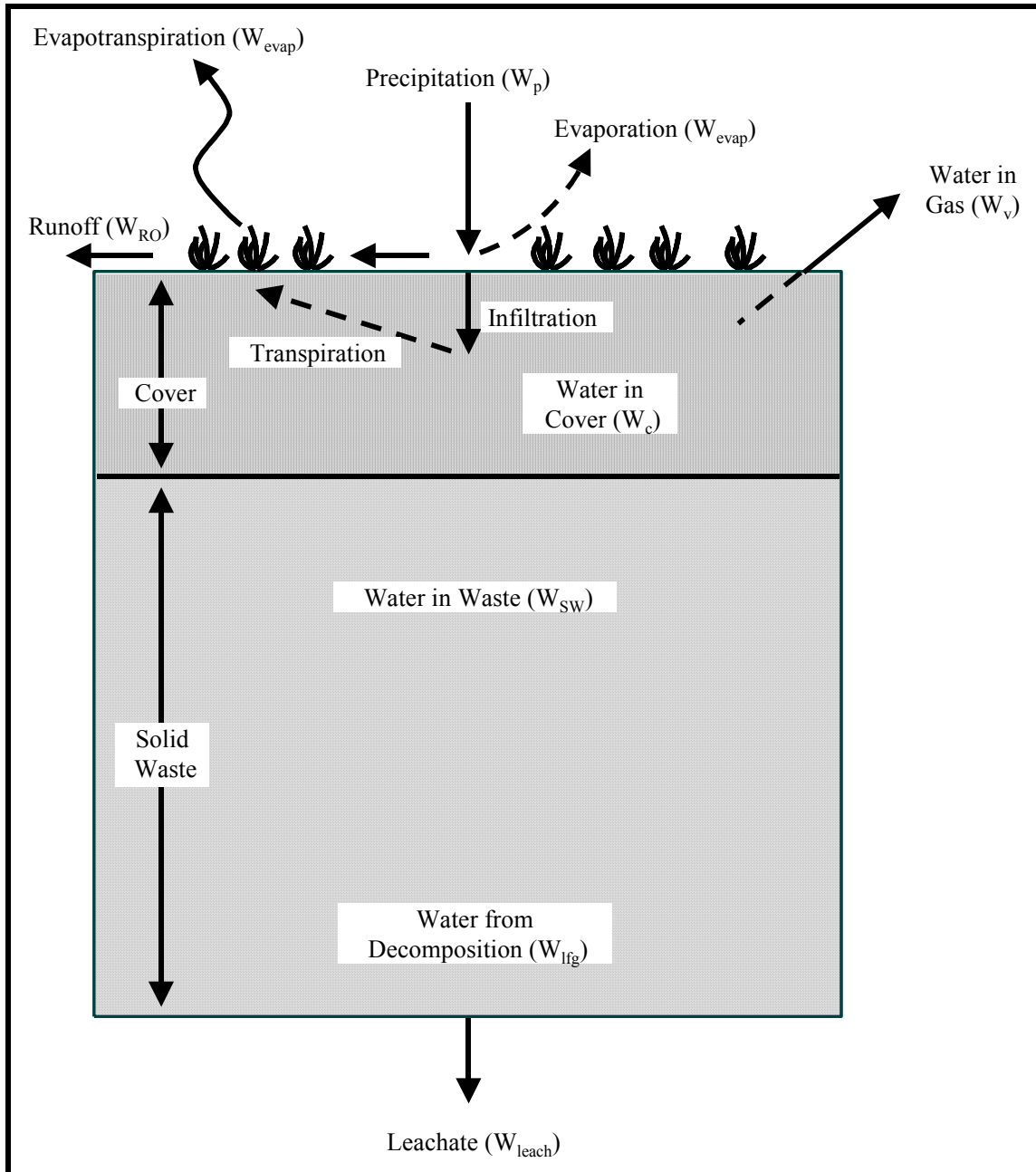

Figure XIV-19. Components of a water balance

The components of the water balance for a landfill can be expressed by the following equation if groundwater infiltration is insignificant:

$$MC = W_{sw} + W_c + W_p - W_{RO} - W_{lfg} - W_v - W_{evap} + W_{leach}$$

where:

- MC = change in the quantity of moisture stored in the landfill (kg/m³);
- W_{sw} = quantity of water in the incoming solid waste (the moisture content of solid waste ranges from 30% to 60% in developing countries, depending on the location) (kg/m³);
- W_c = quantity of water in the cover material (kg/m³);
- W_p = quantity of water from precipitation and other outside sources (kg/m³);
- W_{RO} = quantity of water from precipitation diverted as runoff (kg/m³);
- W_{lfg} = quantity of water utilised in the formation of landfill gas (on the order of 0.2 kg/m³ of gas);
- W_v = quantity of water lost as saturated vapour with the landfill gas (on the order of 0.04 kg/m³ of gas);
- W_{evap} = quantity of water lost due to evapotranspiration (kg/m³); and
- W_{leach} = quantity of water leaving the (control volume) landfill as leachate (kg/m³).

The water balance for a landfill is prepared by adding the mass of water that enters a unit area of a particular layer of the fill during a certain time increment to the mass of water of the same layer that remained from the previous time increment and subtracting the mass of water lost from the layer during the present time increment. The result of this analysis is known as the “available moisture” for the particular layer of the landfill at that particular time. In order to ascertain if any leachate will be formed, the available moisture is compared to the field capacity of the fill. Leachate will be formed if the amount of water present (available moisture) exceeds the field capacity of the fill.

The field capacity of a landfill varies as a function of the weight of the overburden, as well as of other variables, e.g., soil and waste characteristics. The field capacity of a landfill can be estimated approximately using the following equation [11,21]:

$$FC = 0.6 - 0.55 \left(\frac{W}{10,000 + W} \right)$$

where:

- FC = field capacity, and
- W = weight of overburden calculated at the middle of the lift.

Alternatively, the field capacity of compacted solid waste, as well as other materials, can be determined experimentally. Calculated estimates of field capacity should be confirmed through measurements whenever possible.

J3.2. Leachate migration

In “typical sanitary landfills” in most industrialised countries, leachate is found at the bottom of the fill. In developing countries, where most landfills are not lined, the leachate will have the tendency to migrate in a downward motion through the underlying soils. Only a limited amount of research has been carried out on the movement of fluids through solid waste. The values reported in the literature vary from 10^{-2} cm/sec for non-compacted, raw solid waste (bulk densities of up to 300 kg/m^3) to 10^{-4} cm/sec for compacted refuse [78,79]. Depending upon the type of material surrounding the fill, it is possible that a certain amount of lateral migration will take place.

One of the major concerns associated with the uncontrolled vertical migration of leachate is the potential contamination of the groundwater. The rate of migration of leachate can be estimated by using Darcy’s law:

$$Q = - K A dh/dl$$

where:

- Q = leachate flow rate (m^3/day);
- K = hydraulic conductivity ($\text{m}^3/\text{m}^2 \cdot \text{day}$);
- A = cross-sectional area through which the leachate flows (m^2);
- dh/dl = hydraulic gradient;
- h = head loss (m); and
- l = vertical depth (m).

The negative sign in Darcy’s law is due to the fact that head loss (dh) is always negative. Typical values for the hydraulic conductivity (i.e., permeability) for various soils are provided in Table XIV-5.

Table XIV-5. Typical values for the hydraulic conductivity for various soils

Soil Type	Hydraulic Conductivity, K ($\text{m}^3/\text{m}^2 \cdot \text{d}$)
Uniform coarse sand	407
Uniform medium sand	102
Uniform fine sand	4
Silty sand	0.09
Sandy clay	0.005
Silty clay	0.0009
Clay	0.00009

J3.3. Attenuation of leachate characteristics in soil

Attenuation by soil is an adsorption process in which contaminants are removed from leachate moving through the soil. Attenuation is an important mechanism to consider in the design of a bottom liner and particularly if a bottom liner is not incorporated into the design of a sanitary landfill. The mechanism of removal is the adsorption of the contaminants on the surface of active

soil particles (e.g., clay minerals). The fact that attenuation is an adsorption process places a high upper limit on the attenuation capacity of a soil. Hence, soil attenuation is only a short-term means of controlling contaminant migration and protecting groundwater resources from leachate. Moreover, having been contaminated by the adsorbed chemicals, the soil constitutes another source of contaminants to water percolating through the soil. In case of a need to institute corrective or remedial action, contaminated soil would have to be cleaned.

Among the chemical properties that exert an influence on the capacity of a soil for attenuating contaminants are cation exchange capacity (CEC), pH, clay content, mineralogy, free iron oxide content, and lime concentration. The attenuation capacity of a soil generally increases with increase in clay content, free iron oxide content, and lime concentration. Cation exchange capacity is largely a function of clay content and clay mineralogy of the soil. The higher its CEC value, the more efficient a soil becomes at attenuating cations and polar organics. Heavy metals frequently are held by alkali soils.

J3.4. Leachate formation in arid areas

The rate of leachate generation from landfills in developing countries located in arid regions may be relatively low if the results of a research project conducted in Lima, Peru are typical. The project was commissioned for the purpose of assessing the potential environmental impacts, including leachate production, associated with the operation of land disposal sites. The average rainfall in Lima (and generally in the entire coastal area of Peru) is less than 10 mm/yr; thus the results would be applicable to dry (arid) regions. Three micro-landfills that had been operated as sanitary landfills using sand as intermediate and final cover material and an old disposal site operated simply as an open dump were monitored and analysed. The results of the research indicate that, based on the moisture content and the field capacity of the samples and on an input of 500 Mg of waste/day, the landfills were generating between 0.5 and 1.1 L/sec of leachate [9].

K. Liners

K1. SOIL liners

To form a bottom liner for the landfill, soil can be used in one layer (i.e., a single-liner system) or in conjunction with layers of other materials (i.e., as one or more layers of a multi-layer, or composite, liner system). Hazardous wastes, due to their hazardous characteristics, require secure containment and should be disposed in sites equipped with double, or composite, liner systems. When a soil liner is used as a single liner, it reduces or may even keep the leachate from leaving the fill and reaching the subsurface environment. In the event that the soil liner is placed underneath a flexible membrane liner (FML), the soil liner serves as a protective layer for the overlying flexible membrane liner (FML). In addition, the soil liner constitutes an additional barrier to leachate migration. A soil liner must be properly designed and constructed so that it forms a long-term, structurally stable base for overlying facility components.

K1.1. Materials

To adequately serve as a liner, a soil must have a low permeability (preferably less than 1×10^{-6} cm/sec) when compacted under field conditions. After compaction, the liner should be able to support itself and the overlying facility components. The liner material should yield to handling by construction equipment. Finally, a liner constructed of the material (i.e., the soil) should suffer no significant loss in permeability or strength when exposed to waste or leachate from the waste. A soil that is deficient in a required characteristic may be rendered suitable by blending it with another soil or with a soil additive. An example is the addition of bentonite cement to decrease permeability. Ideally, the compaction and permeability characteristics of the selected soil liner

material should be determined by laboratory tests, so as to provide necessary information regarding the interrelationship between moisture content, density, compactive effort, and permeability.

Of the common types of soils, a well compacted mixture containing clay is one of the more commonly used soils for a bottom liner. Clay generally refers to all soils having a particle size smaller than a given size (typically less than 2 microns). Pore-size distribution, fluid viscosity, effective porosity, and fluid density determine the permeability of clay soils to fluids. A clay liner usually is constructed as a layer 0.3 to 1 m thick. To function as an effective liner, the clay must be mixed with other granular soils and placed with the proper moisture content. The density of the liner can be increased through compaction in order to decrease the material's permeability. During installation of a clay liner, compaction is controlled by measuring moisture content and density in each lift. If sufficient clay is not available locally, natural clay additives (e.g., montmorillonite) may be added to the mixture of clay soil to form an effective liner. The use of additives requires evaluation to determine optimum types and mixing ratios.

If it meets the necessary specifications for a liner, the native soil at the facility site would best satisfy cost and convenience considerations. Otherwise, a suitable soil must be imported from another location. Obviously, cost becomes an important consideration when offsite material is used. In developing countries, the maximum distance would depend upon local conditions. In most cases, a haul of any appreciable distance would be impractical. The liner material, whether excavated locally or imported, usually is stored as a borrow pile established at the site.

K1.2. Design and installation

Standard geotechnical practices adjusted to the geology and landfill operational requirements are followed in the design of the individual landfill liner. The soil liner must underlie the entire landfill. The liner should be of low permeability to impede leachate flow and sufficiently thick to provide a structurally stable base for overlying components. With allowances for leachate collection pipes and sump, the liner should be uniformly thick. However, the toes of sidewall slopes should be somewhat thicker to prevent seepage and to adequately join the bottom and sidewall liners (see Figure XIV-20). The liner material should be compatible with the characteristics of waste and of the resultant leachate it is supposed to contain.

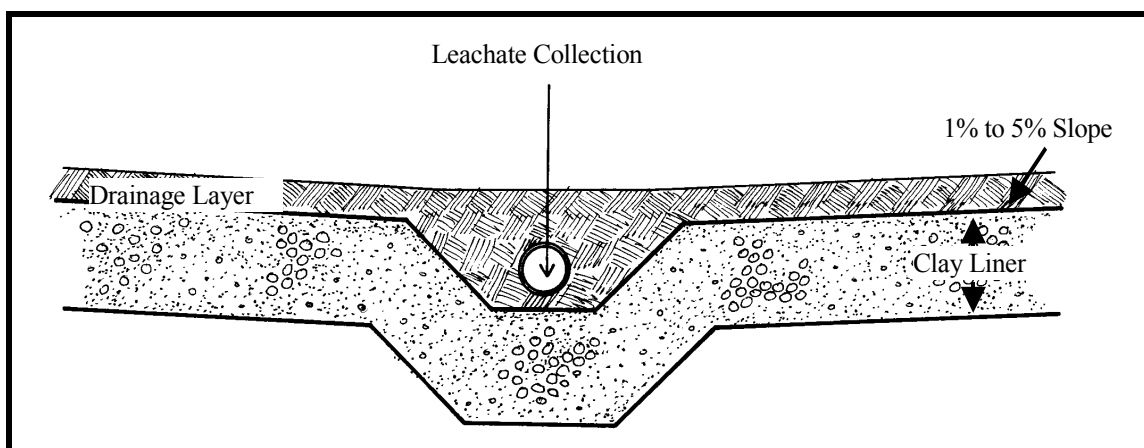

Figure XIV-20. Schematic of liner design

In general, soil liners are constructed of compacted soils installed in a series of layers of specified thickness. Although the use of thinner increments (and, consequently, more layers) facilitates compaction, it adds to construction costs because the number of layers/unit of liner thickness is

increased. Generally, the thickness of liner layers prior to compaction should be on the order of 15 to 22 cm.

K1.3. Liner installation

The liner is installed (constructed) by placing the liner material (soil) with the use of scraper pans or trucks. The soil is spread evenly over the site and then is broken up and homogenised through the use of disk harrows, rotary tillers, or manually-manipulated implements to facilitate compaction. If soil additives are used, they are applied evenly over the site and then are thoroughly mixed into the soil.

The liner may be constructed in sections or in one piece. In a small facility, the liner may be constructed in one piece over the entire facility. Installation by sections probably would be more suitable with large facilities or in continuous operation facilities. In the latter operations, the wastes are placed as portions of the liner are built. It is important that the sections be installed such that no break occurs between them. This can be done by bevelling or step-cutting the edge of a section as soon as it is installed so that the succeeding section can be tied in (i.e., overlapped) with the previously installed section.

Because the necessary degree of compaction is dependent upon a proper moisture content, any required addition of moisture should be made prior to placement of the liner material. Care should be taken to distribute the moisture uniformly throughout the soil. This is done by allowing adequate equilibration time after the moisture addition. The necessary time increment may be days, or even weeks, if the soil is very dry or certain additives are used.

Practices followed and equipment used in earthwork construction are suitable for compacting a liner. The success of the compaction effort depends upon the individual liner layers being properly tied together. Tying together the layers can be accomplished by scarifying the surface of the last installed layer prior to adding the next one and ensuring that the moisture contents of adjacent layers are similar. If sidewall slopes are not very steep, they can be compacted in layers continuous with the bottom liner layers. Steeply sloped sidewalls may have to be compacted in horizontal layers because compaction equipment cannot operate on steep slopes. Tying together is especially important for steep sidewalls, because separation between layers can serve as pathways for the migration of leachate through the liner.

Because climatic conditions (e.g., precipitation, freezing temperatures, and extremely dry conditions) strongly influence activities related to soil liner construction, steps must be taken to minimise climate-related problems. For example, precipitation may interfere with construction operations by eroding or flooding the site or by over-moistening the liner material. Conversely, desiccation can cause cracks to develop in clay mixtures, with the result being unacceptably high permeability.

K1.4. Bentonite-soil mixtures

Laboratory studies have demonstrated that hydraulic conductivities on the order of 10^{-8} cm/sec can be achieved with bentonite. Bentonite can be mixed with soil to reduce the permeability of the material. The permeability of the mixture will depend upon the quantity of bentonite added, the degree of compaction, and the size distribution of the soil. If the bentonite-soil mixture is going to be used as a capping system, it is recommended to use about 5% bentonite (by wt) and a layer thickness between 15 and 20 cm. On the other hand, if the mixture is going to be used as a bottom liner, concentrations of bentonite higher than 5% (by wt) are recommended [20].

K2. FLEXIBLE membrane liners

The constituent material of a flexible membrane liner (FML) is pre-fabricated polymeric sheeting. A flexible liner may be used in many ways. For example, it may be used as a single liner installed directly over the foundation soil; as part of a composite liner placed upon a soil liner, or as a layer of a multi-element leak detection system in a double-lined landfill. In general, flexible membrane liners may be too costly to be installed in developing countries. However, should they be required, attention must be given to specifications and cost, as well as to installation.

Major steps to be taken in the use of a flexible membrane liner are selection of the FML material, designing of the subgrade, and planning the installation. The last step includes the design of subcomponents, such as sealing and anchoring systems and vents. Among the types of membranes commonly used for lining sanitary landfills are high-density polyethylene, chlorinated polyethylene, and chlorosulfonated polyethylene [4,13]. Important criteria to follow for selecting an FML include chemical compatibility with the characteristics of the leachate to be contained; possession of appropriate physical properties such as thickness, flexibility, strength, and degree of elongation; resistance to weathering and biological attack; availability; and cost.

If testing facilities are not available, judgments about compatibility of the synthetic material with wastes and leachates will have to be made on the basis of specifications provided by the manufacturer. With respect to mechanical properties, FMLs having high strength and low elongation are best suited in applications where high stresses are expected (e.g., sidewalls steeper than 2.5:1). Lower strength and higher elongation FMLs (e.g., chlorosulfonated polyethylene) are best used for applications likely to involve large deformations such as differential settlement and local subsidence. Other important mechanical properties that should be considered include: flexibility at various temperatures, resistance to puncture, thermal expansion, seaming characteristics, resistance to weathering, and resistance to biological attack and environmental conditions (e.g., sunlight and atmospheric ozone). Information on FMLs can be sought from manufacturers. Although some published literature is available, such information may be difficult to obtain in a developing nation.

The subgrade upon which an FML rests is a key factor in the maintenance of its integrity. The reason is that it serves as a supporting structure and it controls the accumulation of gas and liquid beneath the liner. Consequences of the accumulation can be uplift stress and reduction of the strength of underlying soils. In addition to those resulting from gas and liquid accumulation, mechanical stresses may be caused by subsidence beneath the liner and other stresses due to differential movements of the subgrade, etc. All of these failure mechanisms can be prevented or minimised by employing common foundation design measures to prevent settlement, subsidence, slope failure, and other undesirable occurrences, as well as other engineering design measures related to soil and liner materials.

Important design features of protective bedding layers are the provision of drainage to prevent the accumulation of gas or liquid and the protection of the liner from being punctured. The drainage layer may consist of sand, gravel, or other comparable granular material. Alternatively, it may take the form of a geotextile (a fabric designed to provide tensile strength and serve as a filter). Granular drainage layers have some substantial limitations, including difficult installation and maintenance of stability on steep slopes, and vulnerability to disturbance by workers and to erosion wind or water during construction. These problems are avoided by resorting to geotextiles. Moreover, geotextiles protect the liner from mechanical stresses.

Surface preparation for FMLs should include: 1) removal of rocks (larger than 25 mm), roots, and other debris from the surface; and 2) removal of organic materials so as to minimise settlement and gas production under the liner. Soils that expand or shrink excessively should be avoided. Finally, the substrate soil surface should be compacted to provide a firm and unyielding base for the liner. Because the actual installation of a flexible membrane liner is a complex and critical task, it should be conducted by a qualified and competent company under the supervision of the manufacturer or an engineer of the manufacturer.

L. Leachate collection and treatment

L1. INTRODUCTION

The decision to incorporate a leachate collection and treatment system as part of a sanitary landfill system in a developing country is, in many cases, a very difficult one due primarily to the expense. Obviously, the consideration only applies in those instances in which a bottom liner has been incorporated into the design of the landfill. If a leachate treatment and collection system is to be installed, funds must be available for operation as well as for capital expenses. If a thorough analysis of the situation indicates that a bottom liner and a leachate collection and treatment system should be installed, every effort should be made to implement the systems such that their construction and operation do not result in the contamination of the surrounding land resources or potential sources of water supply. The implementation of a leachate collection and treatment system involves the following design steps: 1) selection of the type of bottom liner to be applied; 2) preparation of a grading plan (i.e., channels, pipelines, and others); 3) design of the system for the collection, removal, and storage (if required) of the leachate; and 4) identification, selection, and design of the treatment system.

L2. PREREQUISITES

There are two key steps that must be carried out before a leachate collection and treatment system can be designed. The first one involves the selection of the bottom liner and the second involves the estimation of the quantity and quality of the leachate.

L2.1. Bottom liner

The processes involved in the selection, design, and installation of a bottom liner have been discussed in previous sections.

L2.2. Quantity and quality of leachate

The quantity of the leachate can be estimated based on a water balance performed on the landfill system, as has been discussed in an earlier section.

The quality of the leachate from a landfill depends primarily on the type of waste placed in the fill, degree of compaction, depth of fill, and age of the waste. For example, leachate produced during the first phase of decomposition of MSW characteristically has an acidic pH resulting from a high concentration of organic acids. Some characteristics of leachate from municipal solid wastes are presented in Table XIV-6. The range of values given in the table reflects leachates generated during the acid and methanogenic phases of decomposition.

Table XIV-6. Characteristics of leachate generated from decomposition of municipal solid wastes

Parameter	Range of Values^{a)} (mg/L)
pH	4.5 to 9
Alkalinity (CaCO ₃)	300 to 11,500
BOD (5-day)	20 to 40,000
Calcium	10 to 2,50
COD	500 to 60,000
Copper	4 to 1,400
Chloride (Cl ⁻)	100 to 5,000
Hardness (CaCO ₃)	0 to 22,800
Iron - Total	3 to 2,100
Lead	8 to 1,020
Magnesium	40 to 1,150
Manganese	0.03 to 65
Ammonia- NH ₃	30 to 3,000
Organic N	10 to 4,250
Nitrogen-NO ₂	0 to 25
Nitrogen-NO ₃	0.1 to 50
Nitrogen-Total	50 to 5,000
Potassium	10 to 2,500
Sodium	50 to 4,000
Sulphate (SO ₄ ⁻)	20 to 1,750
Total Dissolved Solids	0 to 42,300
Total Suspended Solids	6 to 2,700
Total Phosphate	0.1 to 30
Zinc	0.03 to 120

Source: Reference 29 for hardness, total dissolved solids, and total suspended solids; all other values, Reference 80.

^a Range of values encompasses both acid and methanogenic phases of waste decomposition.

L3. LEACHATE collection systems

The basic purpose for installing a leachate collection system in a landfill is to remove leachate and water that may have penetrated the waste or may have come in contact with it.

The capacity of the leachate collection system depends upon the quantity of leachate expected to be generated. The system should be installed such that it is compatible with the type and shape of the bottom liner. The design of the system should incorporate every measure to minimise or prevent clogging.

One of the critical components of the leachate collection system is its drainage layer or system. The drainage layer provides a path for the leachate to flow through, thus enabling collection and removal of the leachate. In addition, the drainage layer provides protection to the bottom liner from both the waste and the heavy equipment operating on top. The drainage system typically

consists of a mixture of porous materials such as sand and gravel. The materials for the drainage system should be carefully selected and graded so that they do not clog the collection pipes. Some of the more sophisticated drainage systems include more than one drainage layer. In addition, clogging between filter layers can be reduced by including a filter fabric between them.

The efficiency of the leachate collection system is partly controlled by the characteristics of the drainage layer. In particular, the hydraulic conductivity of the drainage system reduces the efficiency of the collection system. Drainage layers also are prone to clogging. Clogging of the drainage layer (i.e., a reduction in the hydraulic conductivity) results in a reduction in the quantity of leachate removed from the site.

L4. DESIGN of the leachate collection system

There are a number of proposed designs for leachate collection systems. Two of the more common systems are the sloped terrace and the piped bottom. They are described below.

The sloped terrace design involves the sloping of the bottom of the fill into a series of terraces. Generally, the recommended slopes for the terraces are in the range of 1% to 5%. This degree of inclination promotes migration of the leachate in the direction of collection pipes or channels. The collection channels typically include perforated collection pipes in a bed of packed gravel. The gravel should have a size of in the range of 3.5 to 5 cm. The gravel itself can become clogged with fine particulates; consequently, the gravel typically is enclosed within a layer of geotextile filter fabric. Usually, the inclination of the drainage channels is in the range of 0.5% to 1.0%.

The piped bottom collection system design includes the placement of clay barriers and perforated leachate collection pipes at the bottom of the site. Typically, the barriers have a defined form and a width similar to that of the solid waste cell. A geomembrane is placed on top of the clay surface. After the barriers have been installed, slotted pipes are placed on top of the geomembrane. The leachate collection pipes usually have a diameter of about 10 cm, and the perforations usually cover about 50% of the pipe's circumference. The collection pipes are placed about 10 to 20 m apart and are covered with a drainage layer of sand and gravel. As a precaution against clogging of the pipe perforations, a fabric filter can be placed on top of the drainage layer. The separation between the pipes will control the amount of leachate that will accumulate at the bottom of the fill. In a typical operation, the layer of sand and gravel is about 60 cm thick and is placed on top of the collection pipes a few weeks before the first load of waste is discharged on the cell. It is advisable not to compact the first layer of waste in order to protect the integrity of the piping network. The slope of the unit should be on the order of 1% to 2% in order to promote the migration of leachate toward the collection points. The designs of these facilities should promote drainage by gravity [11,22-24].

L5. REMOVAL and storage of the leachate

Removal of leachate from a landfill can be carried out in either of two manners: by installing a pipe through the side of the fill or by placing a sloped collection pipe inside the fill. If a pipe is placed through the side of the landfill, the construction should be conducted with due caution in order to avoid damaging the liner system.

Most leachate collection systems will clog at some point in time. Consequently, manholes and vertical and/or horizontal cleanouts should be provided in strategic locations in order to conduct periodic maintenance and inspection.

Once the leachate is captured in a particular section of the landfill, it usually is routed to storage in tanks, vaults, or ponds. The type and size of the storage device will depend upon the quantity

and characteristics of the leachate, proximity to inhabited areas, and the type of treatment required.

L6. LEACHATE management alternatives

The type and degree of treatment afforded to leachate from a sanitary landfill will have an impact on the level of pollution of any nearby groundwater and of the surrounding environment. The best approach to leachate management is to avoid generating it in the first place. However, this condition usually can be achieved or closely approached only under dry climatic conditions. If conditions are such that leachate is generated, there are several options for managing it:

- evaporation (natural or forced),
- recirculation and recycling,
- discharge to an offsite wastewater treatment facility, and
- onsite treatment.

A discussion of each of the approaches follows.

L7. EVAPORATION

Evaporation of the leachate, by natural means, is one of the more appropriate solutions for managing the leachate generated in developing countries whose climatic conditions would be compatible with the technique (i.e., high temperatures and low relative humidity). In this technique, once the leachate is collected, it is transported to an evaporation pond. The pond should be constructed using an impermeable material and should have sufficient capacity to hold the leachate plus any incident precipitation. If the pond is relatively small, it may be feasible to place a cover over the pond permanently or during the rainy season. The rate of evaporation depends upon climatic conditions; however, the evaporation rate can be enhanced by spraying the leachate either on the pond or on the surface of parts of the completed fill. Spraying on the surface may lead to generation of unpleasant odours and of aerosols that may contain pathogens and micron-size particulates, which may be of consequence if sensitive receptors are located nearby.

The rate of evaporation can be increased by heating the leachate. Heating the leachate can be a costly undertaking, although landfill gas could be used for this purpose.

L8. RECIRCULATION and recycling

Recirculation of the leachate through the landfilled wastes has been applied in several facilities throughout the world as a method of leachate management. Relatively high concentrations of BOD, COD, and, in some cases, heavy metals generally are found in the leachate soon after the waste is placed in the landfill. Under certain conditions, the potentially polluting characteristics of organic compounds in the recirculated leachate can be attenuated by the chemical and biological processes occurring in the landfill and, thus, substantial savings can be achieved in terms of the capital and operational expenses of treatment [76].

Published results indicate that a substantial reduction of the organic compounds in the leachate can occur over a short time if recirculation is employed, although many landfills that have a high

rate of refuse placement have not experienced any appreciable long-term effect due to recirculation.

There are some disadvantages associated with the application of recirculation, including: 1) the potential of polluting the surrounding environment due to migration of the leachate through the sides or through the bottom of the fill, and 2) a buildup of heavy metals, salts, and other undesirable compounds in the leachate that eventually will have to be disposed.

If the landfill has two or more lifts and the lifts are capped with relatively impermeable covers, the application of recirculation should be considered very carefully. This is because intermediate covers can act as more or less impenetrable barriers, thereby leading to the accumulation of leachate on the top of the cover. Accumulation can be sufficient either to establish zones of saturated wastes, or to form water tables within the fill [33,78]. Saturation of portions of the waste can result in the material prematurely reaching anaerobic conditions and, thereby, yielding large variations in the quality of the leachate that is produced. Furthermore, the generation of areas of saturated waste above the intermediate cover can also lead to the leachate migrating to and emerging from the sides of the landfill [33,78].

L9. TREATMENT

In the event that minimisation, evaporation, or recirculation are not viable alternatives, the next viable alternative is to implement some type of treatment system. The type and capacity of the treatment system are functions of the quantity and characteristics of the leachate. As opposed to municipal wastewater, the quantity and characteristics of leachate undergo substantial variations over time. Furthermore, climatic conditions also have an impact on the quantity and quality of the waste liquid.

There are various alternatives available for the treatment of leachate. Most of these alternatives have been adapted from conventional methods of wastewater treatment. Some of the processes include physical, chemical, and/or biological steps. There are very few full-scale leachate treatment systems in operation in developing countries. A conventional design in industrialised countries would be as follows: 1) pre-treatment, 2) physical and/or chemical treatment, and 3) biological treatment. The pre-treatment step, as its name implies, generally involves a series of processes designed to prepare the leachate for further processing. Pre-treatment may include: screening, sedimentation, and pH adjustment. The second stage of the treatment includes several steps designed to remove heavy metals, suspended solids, and colour. These processes may involve flocculation, sedimentation, sand filtration, and others. The third and final general step may include a series of basically biological processes. These processes are designed to remove the organic loading (BOD and COD), as well as ammonia, from the leachate. Typical processes include: oxidation ponds, aerated lagoons, activated sludge, and others. Following are brief descriptions of some of these processes. Complete descriptions of these processes can be found in standard texts on wastewater treatment.

L9.1. Biological treatment

There are several characteristics of the leachate that will dictate the advisability of using some type of biological treatment. Some of the more important characteristics involve the relatively high organic and inorganic loads, fluctuations in the quantity, changes in the concentration of organic matter, and others. One relatively simple approach to evaluating the biodegradability of leachate is by checking the ratio of BOD to COD. If the ratio is about 0.5, then it may be possible to treat the leachate biologically. On the other hand, if the BOD:COD is less than 0.5:1, a biological system may not be appropriate as a treatment process. Ratios of BOD to COD over the

course of decomposition of MSW can range from an average of about 0.6 during the acid phase to about 0.1 during the methanogenic phase [80].

Leachate contains several compounds that, in some concentrations, are known to have a negative impact on the performance of biological treatment processes. Some of these compounds are: chlorides, sulphides, ammonia, metals, and others.

Even though biological treatment processes can withstand most of the characteristics of leachate, if inhibition is observed during tests, it may be necessary to include a pre-treatment stage in the overall treatment process.

L9.1.1. Aerated lagoons

Aerated lagoons are applicable to landfills that generate relatively small quantities of leachate. In this case, the leachate is transported to a lagoon, where it is aerated by mechanical means (surface aerators or air pumps). Both aeration and the mixing brought about by the aeration enhance the degradation of organic substances by introducing atmospheric oxygen into the leachate. Retention times on the order of 10 days have produced relatively large reductions in the concentrations of BOD and COD.

L9.1.2. Activated sludge

This particular process is similar to the aerated lagoons excepting that, in this case, a certain percentage of the sludge produced in the process is recycled. As such, a settling tank is needed in the system.

L9.1.3. Facultative ponds

Facultative ponds are used to treat various types of wastewaters. The ponds generally are between 1 and 1.5 m deep and are not aerated by artificial means. In the process, the top layer of the pond behaves as an aerobic lagoon due to wind aeration and the oxygen generated by algae. On the other hand, the bottom layer is not impacted by the conditions at the surface and thus becomes anaerobic. Facultative ponds typically remove ammonia-nitrogen through nitrification processes.

Properly designed aerobic lagoons and facultative ponds may be suitable for leachate treatment in a number of developing countries.

L9.1.4. Other biological processes

In addition to the processes described in the preceding paragraphs, there are several other alternatives for the biological treatment of leachate. Some of the processes include: anaerobic digestion, anaerobic lagooning, and anaerobic filters.

In general, aerobic processes require relatively long detention times in order to be effective. Aerobic processes remove ammonia-nitrogen by nitrification or by conversion to biomass. Anaerobic treatment processes, on the other hand, probably are most applicable as a pre-treatment process since these types of processes do not remove ammonia and the effluents generally have a relatively high turbidity.

L9.2. Reverse osmosis

The application of reverse osmosis (RO) is relatively new in the solid waste management field. In the process, the liquid to be treated is forced, at high pressures, through membranes. The membranes retain impurities and a treated effluent is discharged. Due to the characteristics of the

leachate, membrane fouling has been a common problem. Development of new types of membranes is addressing some of these problems. If RO is going to be used in the treatment of leachate, it is recommended that the leachate undergo some form of pre-treatment in order to reduce membrane fouling and to prolong the useful life of the system.

M. Management of landfill gas

M1. ORIGIN, composition, and volume of gases

Landfill gas (commonly termed “biogas” in some locations) is one of the products generated as a consequence of the biological degradation of the organic fraction of the wastes placed in the landfill. Immediately after disposal and for a brief period afterwards, there is enough oxygen contained in the air entrapped in the wastes so that the initial phase of biodegradation is primarily aerobic. The main constituents of the landfill gas during this stage are carbon dioxide (CO₂) and water vapour.

Waste compaction, combined with the application of the landfill cover, prevents air from reaching the wastes. Consequently, within a short period of time from initial deposition, the oxygen originally trapped in the wastes is consumed and the biodegradation process becomes anaerobic. The shift to anaerobiosis is marked by the production of methane (CH₄) and carbon dioxide (CO₂), as well as a variety of trace amounts of reduced carbon and sulphur compounds. The biological principles involved in the formation of biogas in a landfill are those that are characteristic of conventional anaerobic digestion. The principal differences are in rate of conversion of organic matter to methane and the ratio of methane to carbon dioxide. The microbiology of the decomposition of municipal solid waste has been reported in detail in Reference 67.

Typically, the composition of landfill gas is on the order of 40% to 60% CH₄, 40% to 50% CO₂, 3% to 20% N₂, 1% O₂, and traces of sulphides and volatilised organic acids. Traces of other compounds may include benzene, toluene, sulphur dioxide, methylene chloride, and others in concentrations of up to 50 ppm [15,16].

The change from aerobic to anaerobic degradation and the production of methane and carbon dioxide under anaerobic conditions proceeds as a series of phases. The first phase is the aerobic phase, lasting from a few days to several weeks -- the duration being a function of degree of compaction and other factors. The second phase begins as conditions within the fill change from aerobic to anaerobic. At this point, obligate aerobic bacteria die off and facultative aerobes shift from their aerobic to their anaerobic mode. During the second phase, CO₂ and, to a lesser extent, hydrogen are the main gases produced. The third phase can be identified by the gradual appearance of methane. In the fourth and final phase, methane production becomes constant and falls within the range of the ratio named in the preceding paragraph (40% to 60% CH₄: 40% to 50% CO₂). Research has been conducted on the identification and quantification of representative species of the microflora involved in biogasification of sewage sludge, organic municipal solid waste, and some agricultural residues [67-72]. The acidogenic population, consisting of about 90% of the total digester population, is the largest of all the groups [73]. However, relatively little is known about the number and physiological activities of the acidogenic microorganisms [74].

M2. GAS generation

Methods for estimating gas production in a conventional digester must be appropriately adjusted to reflect the differences between anaerobic digestion in a fill and anaerobic digestion in a digester (reactor). In general, the amount actually obtained from a landfill will be much less than the theoretical volumes predicted on the basis of organic waste content. Moreover, unless the fill

has been specifically designed for gas containment and eventual collection, the actual yield of gas will be disappointingly small.

Municipal solid waste contains a large variety of components that have the potential to break down under anaerobic conditions. Limited data are available on the chemical composition of the various components buried in landfills. Analyses conducted between 1984 and 1987 on municipal solid waste generated in Madison, Wisconsin (United States) indicated that the material contained about 40% to 51% cellulose, 12% hemicellulose, 15% lignin, and not more than 4.2% protein [60-62]. The main components of municipal solid waste that have substantial concentrations of biodegradable fractions are: paper, yard waste, and food waste.

Along with the concentration of biodegradable organic matter, two factors that have an impact on the production of methane in a land disposal site are moisture content and pH. Studies conducted on samples from landfills indicate that the production rate of CH₄ exhibits an upward trend as the moisture content of the refuse increases regardless of age, density, or composition of the waste [63]. On the other hand, the optimum pH level for activity by methanogenic bacteria is between 6.8 and 7.4. Collecting, neutralising, and recycling the leachate through the refuse has been demonstrated to have a positive effect on the formation and rate of methane production in laboratory-scale studies [64], and in some field-scale studies [81,82]. Landfills that are operated with injection (recycling) of leachate to enhance yield and quality of landfill gas are sometimes termed landfill bioreactors.

Methane is not formed immediately after the waste is deposited in a final disposal site. In some cases, it may take months or even years before the necessary microbial populations are established and the proper environmental conditions within the fill are reached.

Change in rate of gas production parallels the temperature curve for mesophilic bacterial activity -- namely, minimal at about 5° to 10°C, and optimum at about 35° to 40°C. Between the two ranges, rate increases with rise in temperature. As such, gas production slows down considerably at temperature levels of 3° to 5°C, because microbial activity almost ceases at these levels. Consequently, in all but the semi-tropical and tropical zones, temperature may be a limiting factor during winter, early spring, and late autumn in shallow or relatively small disposal sites. Temperature would not be a limiting factor throughout the year in tropical regions or in the case of large, deep landfills, if other conditions are not limiting.

As previously indicated, rate and volume of gas production generally improve with increase in moisture level up to and including saturation. Conversely, at moisture contents less than approximately 60% to 70%, volume and rate are increasingly adversely affected by further drops. Despite a reported satisfactory gas production in a fill in which the moisture content is less than 40%, the generality holds true that in the absence of other limiting factors, gas production is best at the higher moisture contents.

Since the characteristics of the wastes and conditions vary substantially from one region to another, it follows that reported rates and quantities of landfill gas encompass a wide range of values [15,17,18,83,84]. Thus, reported gas production in landfills in industrialised countries ranges from 0.06 to 0.4 m³/kg of solid waste disposed. Reported rates range from 1 to 10 m³ gas/Mg of waste disposed/yr. Most of the production takes place during the 20 years following landfill closure. Landfill gas production is most active during the first 5 years or so after the majority of oxygen is depleted from the wastes (typically, 1 to 2 years). Gas production, at gradually dwindling rates, may continue for as long as 50 years.

M3. VOLUME (yield)

M3.1. Potential

The difficulty of accurately predicting a continuous production of gas at a given flowrate [75] has interfered with the attainment of an adequate knowledge of the kinetics of gas generation in a landfill. Approximations made of expected yields have a high degree of uncertainty because they are necessarily based on assumptions that may or may not prove to be valid. On the basis of volatile solids content, the maximum yield of gas would be about 0.4 standard m³/kg volatile solids in the wastes; other reported yields are in the range of 0.006 to 0.05 standard m³ of methane/kg of “as-received” (wet) waste [75,76]. These yields were based on data collected during the first few years of landfill operation. Decomposition generally is most rapid and extensive during this period.

Several models have been developed to predict the production rates of gas from landfills. Most of the models, however, require actual measurements of gas production in order to determine the values of constants for the models. Interest in the prediction of gas generation from wastes has recently increased due to the concern for controlling contributions to global warming. One of the predictive models is based on the following assumptions [55]:

- The main components of the degradation process, i.e., the substrate, the microorganisms, and the primary gaseous products (methane and carbon dioxide), can be quantified based on the concentration of carbon in them.
- Continuous conversion (at standard conditions) of 1 kg of organically bound carbon will yield a total volume of 1.87 m³ of landfill gas composed primarily of methane and carbon dioxide.

In order to account for conditions typical of a disposal site, a first-order rate expression is assumed. The first-order rate coefficient is a function of temperature. The genesis of the mathematical model is the design of reactors to digest tropical vegetable material in batch reactions. The mathematical expression is as follows:

$$C_t = C_g (1 - e^{-kt})$$

where:

- C_t = the quantity of gas produced in time t ,
- C_g = the quantity of gas produced as t approaches infinity, and
- k = a first-order rate coefficient, in time^{-1} .

In order to solve this equation, it is assumed that the relationship between gaseous carbon and assimilated carbon is linear as temperature changes within the mesophilic range. The relationship is expressed as follows:

$$C_g = C_T (0.014 T + 0.28)$$

where:

- C_g = the total carbon that can be converted to gas as time approaches infinity,
- C_T = the total amount of carbon compounds in the substrate, and

- T = the temperature in °C.

The derivation of the equation for C_g is based on the assumption that the organically bound carbon content of the waste is 200 kg/Mg.

The model using the first-order rate equation is a good initial approximation within the constraints of the assumed parameters and their values. However, the use of 1.87 m³ of landfill gas/kg of waste and 200 kg of carbon/Mg of waste limits its application to certain land disposal sites and regions. These limiting assumptions would be particularly important in tropic and sub-tropic developing countries where the waste contains high concentrations of organic matter and typically is not covered.

A stoichiometric approach for estimating landfill gas production is described in *Recovery, Processing, and Utilization of Gas from Sanitary Landfills* [14]. This approach takes into consideration the two major classes of material that decompose to produce landfill gas. The first class consists of the easily biodegradable fraction (e.g., food waste or garbage, garden debris). The second class includes the less easily biodegradable fraction (e.g., paper, textiles, etc.).

The variables mentioned in the preceding paragraphs, as well as others, have an effect on the accuracy of models developed for predicting rates of landfill gas generation, especially rates of methane production. Among the variables for rates of methane production are volume of gas that escapes the fill, percentage of carbon that passes through the methane fermentation route, and percentage of carbon that becomes a part of microbial protoplasm. Consequently, such models should be regarded only as being approximate indicators of expected gas production trends. Actual measurements of gas flow and composition should be included as one phase of the design and implementation of a landfill gas recovery system.

Although most municipal wastes in developing countries have a high concentration of organic matter, the wastes usually are not adequately covered and thus the gases readily escape. In addition, there are several factors that affect the amount and rate of gas production in a solid waste disposal site. Some of these factors include:

- waste composition (i.e., concentration of carbon, nutrients, and inhibitors) and moisture content;
- degree of pre-treatment (size reduction, recycling, composting, baling);
- type and degree of compaction, method of operation of the landfill site, type and thickness of cover material;
- quantity of refuse, geometry, and hydrogeologic properties of the landfill; and
- climatic conditions (temperature, precipitation, evaporation, insulation).

Based on a review of available empirical information, the following can be concluded:

- The concentration of carbon in municipal solid waste can vary from 325 to 350 kg/Mg (dry basis). The amount of degradable carbon is in the range of 56% to 70%.
- Based on the results of a series of experiments conducted by the authors and other data, it can be estimated that the theoretical maximum production of landfill gas is on the order of 300 m³/Mg of MSW (wet basis) [65].

In order to estimate the quantity of landfill gas that can be produced from municipal solid wastes generated in different countries, a multi-component model can also be used. The model uses the composition of the solid waste and the ultimate analysis (i.e., concentrations of carbon, hydrogen, oxygen, and nitrogen) of each component (i.e., paper, food waste, etc.). By assuming an anaerobic reaction, calculations of gas production and of methane are subsequently made as a function of contribution of carbon in the total MSW landfilled by component. This method has the advantages of allowing the determination of the relative contribution of each component to the overall production and composition of the gas. The method allows: 1) the development and analysis of strategies for the management of each of the components prior to landfilling, and 2) assessments of the impacts of waste composition (including moisture content) on gas production.

M3.2. Actual recoverable

The economic and, hence, practical feasibility of recovering landfill gas from a fill depends upon generation rate, conversion efficiency, and the volume of the generated gas that is retained within the fill. The volume of gas retained within a fill depends upon the extent of gas lost from the fill prior to the initiation of the recovery operation, gas loss due to migration through the cover material and sides of the fill during gas recovery, and the amount of gas remaining in the fill after the cessation of gas recovery.

Convective flow through the cover and molecular diffusion through the sides are the principal mechanisms of gas loss from a landfill. Magnitude of the loss depends upon the permeabilities of the cover, the sides, and the soil surrounding the sides. If the compacted wastes and the surrounding soil are very permeable, convective flow responding to the pressure gradient also would be a mechanism of gas movement.

The amount of recoverable gas increases in proportion to the depth of the fill, since depth is an indicator of mass of waste in place.

After a landfill has been completed, it usually is impractical to do anything further to influence the rate and volume of gas generation (However, it is possible to affect landfill gas generation (rates, yields, etc.) by injecting leachate into the fill (as mentioned earlier in this chapter) or other materials, but the system is usually installed as the fill is constructed). After completion of the fill, gas generation depends upon the nature of the buried wastes, the age of the fill, the method of operation, and climatic conditions. If the landfill uses an impermeable cover and surrounding and underlying soil layers are impermeable, the volume of the stored gas will remain intact and available for collection [45].

M4. DISPOSITION of the landfill gas

Gases generated in the fill can either be allowed to disperse and migrate beyond the confines of the fill without any effort being made to control them, or they can be collected. Collected gases may be put to some use, may be flared, or may simply be vented into the environment. Venting into the environment provides undesirable contributions to global warming. However, the collection and use of landfill gas entails significant capital and operating costs that must be compared to alternative sources of energy.

Accumulated gases and uncontrolled dispersal and migration can lead to the development of undesirable or hazardous conditions due to flammability, asphyxiating properties, and trace organic composition of the gases. The slightly positive pressure usually existing within a landfill permits gases to flow uncontrolled from the fill to areas of lower gas pressure by convective gas

transport. Also, if cover is applied in an unmanaged fashion, the gas accumulated in the fill is likely to be inhibitory to the growth of roots of any vegetation that is placed on the cover.

In the absence of adequate gas control, landfill gases either migrate to the atmosphere through the landfill cover or migrate laterally through the soil around the fill until they reach areas from which they cannot escape and, as a result, accumulate. As long as the concentrations are relatively low, the gases pose only a nuisance; but when the concentration reaches a critical point, explosive levels of methane may be reached. (The explosive concentration level of methane is between 5% and 15% by volume. At higher concentrations, methane simply burns.) Because of the possibility of gas accumulation, buildings on or near landfills should not have underground structures. If such structures are present, they should be thoroughly and continuously ventilated and monitored for presence of methane.

Accumulation of gases in the fill can be avoided through the use of a porous final cover. Migration from the fill and the attendant hazards can be averted by providing an area of high permeability vented to the atmosphere. Gases flow to the surface of the vented areas where they are diluted in the atmosphere to harmless levels. The areas take the form of boreholes, of gas wells, or of interceptor trenches installed around the borders of the fill. A more useful measure is to recover (collect) the gas and use it as a source of energy.

M5. COLLECTION, upgrade, and utilisation of landfill gas

M5.1. Collection

If methane recovery is planned for a new facility, certain features should be incorporated into the design of the fill. Some of the features are characteristic of modern landfill design regardless of whether or not methane is to be recovered. For methane recovery, the fill must be effectively sealed off from the land and water environments. The steps involved in providing such sealing are the same as those described earlier. Old or existing fills should be sealed to the extent economically and practically feasible.

Gas recovery involves designing the fill such that the migrating gas can be controlled and collected. Collected gas either can be used directly as a low-heat fuel, or can be processed (purified) to form a high-heat fuel. Collection is made possible by providing a combination of strategically spaced wells and areas of high permeability through which gases are channelled to collection points. This is done by installing underground venting pipes and a gravel layer between the cover and the waste, or gravel filled trenches. The gas is removed from the landfill by way of a piping or header system to transport the gas, and blowers to pull the gas from the fill through the headers [13-15]. A schematic diagram of a landfill gas extraction well is shown in Figure XIV-21.

Proper functioning of the gas collection system is ensured through the use of blowers. The blowers are operated such that a partial vacuum is created in the headers and collection system and the gas is pulled from the landfill. Although some gas will flow unassisted into the collection wells because of the slightly elevated internal pressure of the landfill, the flowrate is too low to ensure proper collection performance. Blowers both increase the flow of gas from the landfill and broaden the effective landfill area serviced by each gas well. The blowers can be adjusted either: 1) to pull gas from the fill and discharge it at atmospheric pressure for dispersion, flaring, or combustion; or 2) to compress the gas to higher pressures for distribution or for further processing.

If the landfill has been properly operated during its lifetime, gas can be recovered from a landfill not originally designed for that purpose by way of drilling a number of boreholes into the landfill at selected gas collection points. The boreholes should be 0.66 to 1 m in diameter. Their depth should be from 50% to 90% of the refuse depth. The boreholes are fitted in the same manner as collection wells used in fills designed for gas recovery. These collection wells are described in the following paragraph.

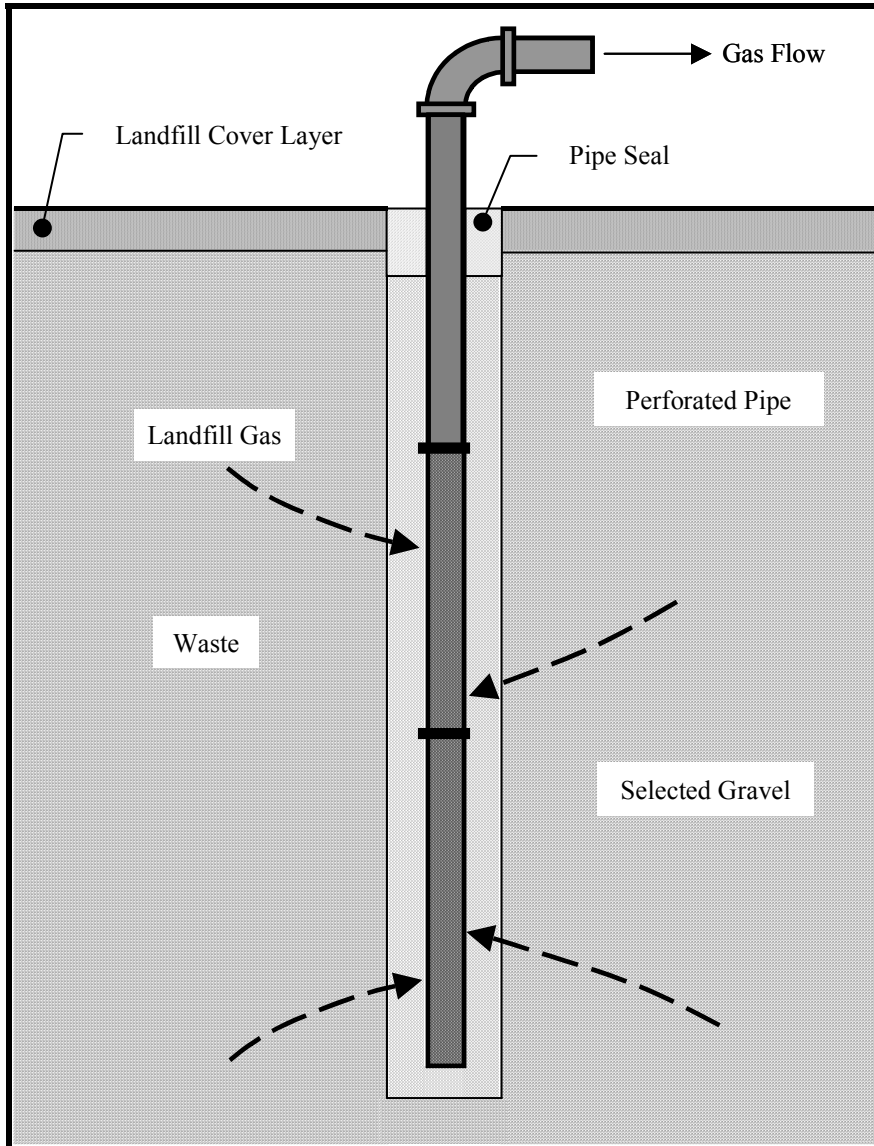

Figure XIV-21. Schematic diagram of gas well

Collection wells are gravel-packed wells equipped with casings that extend the full depth of the fill. The casings are perforated in the section exposed to the contents of the fill. The casings must have telescopic connections between pipe segments such that connections between segments are maintained despite the significant and non-uniform subsidence characteristic of landfills.

The wells are built by progressively backfilling gravel around the gas collection pipe. The backfilled gravel (or a coarse substitute) serves as a highly permeable collection zone through which the gas flows into the collection pipe for removal from the well. The gravel area is covered with a gas-tight seal topped by backfilled soil to form a barrier against intrusion of external air into the well. Air intruding into a well (or into any part of the fill) would dilute the collected gas and thereby lower its heating value and complicate purification. With respect to dilution, the concentration of nitrogen in the collected gas would be increased and the quality of the gas would

be lowered correspondingly. A second, and perhaps more serious, problem would come from the presence of oxygen in the air thus introduced. The oxygen would inhibit the activity of the methane-forming microorganisms. More importantly, it may raise the concentration of O₂ to the explosive level with respect to methane.

The arrangement of the collection wells is determined by their respective capacities, as well as by the characteristics of the soil cover and provisions for directing gas movement in the fill. The dimensions of the fill area affected by a well are a function of the rate of pumping. For example, in a 12 m California fill having a gas well that was 6 m deep and was being pumped at 2.83 m³/min, the negative pressure ranged from -5.1 cm of water at the well to less than -0.8 cm at a distance of 30.5 m from the well. Advancing the pumping rate to 8.5 m³/min brought the respective negative pressures to -17.8 and -2.54 cm [19].

In order to avoid the problems associated with the accumulation of landfill gas, some municipalities have adapted the designs described in the preceding paragraphs to local conditions. In the example shown in Figure XIV-22, gas venting units are built by using a wooden frame, a wire mesh, and crushed stone. A landfill gas flare is fashioned by sealing the top of the collection unit and inserting a 50 mm metal pipe into the stone. A 3- to 4-L metallic can (usually a food can or a used oil filter) is welded to the top of the pipe that protrudes through the fill. Perforations are made on the side of the can, as shown in Figure XIV-23.

M5.2. Upgrading and utilisation

Unless the gas is to be used for simple space heating and household cooking, it should be upgraded before being put to use. Upgrading is essential if the gas is to be used as a fuel for an internal combustion engine, or is to be injected into existing transmission lines.

Quality and content of landfill gas do not compare favourably with those of natural gas. Moreover, its composition and other characteristics are more variable. With regard to the latter, the heat and moisture contents and oxygen concentration of landfill gas may vary as much as 50% from day to day and season to season. The heat content of landfill gases ranges from about 7,500 to 22,000 kJ/m³; whereas the lowest heat content of natural gas is approximately 37,300 kJ/m³. Moisture content may be as low as 5% and as high as saturation. Oxygen content varies from trace levels to levels that are potentially explosive. However, the latter levels are reached very infrequently. Finally, the usually sizeable CO₂ and N₂ contents of landfill gas materially lower its heat content and, hence, the quality of the gas.

The utility of landfill gas can be increased significantly by upgrading the gas. Among the uses for upgraded gas are onsite generation of electricity and/or injection into a public utility transmission line. Methods and procedures are available for removing H₂O (dehydration), CO₂, and N₂ from landfill gas, and thereby considerably raising its heating value.



Courtesy: CalRecovery, Inc.

Figure XIV-22. Gas removal unit made with locally available materials



Courtesy: CalRecovery, Inc.

Figure XIV-23. Low-cost gas burner

With respect to onsite generation of electricity, the gas can be used to fuel an internal combustion engine or to drive a gas turbine. The degree of cleanup of the raw gas that is required prior to combustion depends on the specifications of the engine or turbine manufacturer. Also, the gas must be delivered to the combustion equipment at the correct flow rate and pressure.

Space heating and household cooking require only that H_2S be removed. Hydrogen sulphide can be removed by passing the gas through a dry-gas scrubber that contains a mixture of ferric oxide and wood shavings (“iron sponge”). The removal capacity of the mixture is on the order of 105 kg of sulphur/ m^3 of mixture. The mixture can be regenerated by exposing it to air. Doing so converts the ferric sulphide formed in the scrubbing operation to ferric oxide and elemental sulphur.

M6. USE of landfill gas in some developing countries

A few experiences have been gained in the collection, processing, and utilisation of landfill gas (LFG) in economically developing countries. In addition, some research has been conducted on the matter. Unfortunately, the results of the large majority of these efforts have not been widely disseminated nor published in international journals. Following is a brief description of some of early work on LFG that was carried out in Brazil and Chile.

M6.1. São Paulo, Brazil

The gas company in São Paulo (COMGAS) was one of the first entities to explore the potential of collecting and using landfill gas in Brazil. The company initiated a series of studies on LFG recovery in 1975. These studies were followed by actual field investigations in a disposal site (km 14.5 of Rodovia Raposo Tavares) in 1976. The field work was supported by the Petroleum National Council. After a period of evaluation, which included the collection and analysis of samples, a gas collection system was installed. The system included 13 wells; 2 compressors

(capable of processing about 1,560 m³/hr); and a network of piping connected to gas meters, filters, and condensers. The gas collected from the system was distributed to 31 residences located near the disposal site. The gas was used as a substitute to LPG [56].

M6.2. Rio de Janeiro, Brazil

Another important gas recovery project was carried out in Rio de Janeiro in 1975 by the municipal company for urban sanitation (COMLURB). The work was begun by building an experimental landfill that allowed for the measurement of important parameters of the fermentation process. The experimental landfill was operated for three years. The rate of gas production was calculated to fluctuate between 0.06 and 0.19 m³/kg of waste. During the research, the gas was filtered, cleaned, and compressed in cylinders. The compressed gas was used as vehicle fuel [57]. In 1984, COMLURB began a landfill gas recovery system in a landfill located in Caju. Since then, several LFG recovery projects have been implemented.

M6.3. Santiago, Chile

Landfill gas has been used in the sanitary landfill of La Feria in Santiago, Chile. The gas was extracted from about 70 vertical wells. The extracted gas was mixed, without treatment, with the city gas pipeline at concentrations of up to 20% by volume. Later, the gas was treated and used as fuel in a chemical plant [58]. Other work associated with gas recovery was performed in other cities in Chile [46,59].

M7. ECONOMIC feasibility factors associated with landfill gas recovery

In terms of economic feasibility, several factors have a decisive part in determining the advisability of recovering gas from a landfill and putting it to use. Among the more important factors are size of the fill, permeability of cover material and surrounding soil layer, and proposed use of the gas. If modern sanitary landfill design criteria are followed, the permeability of the cover and surrounding soil layer should not limit the production and availability of landfill gas. Regarding utilisation, if it involves a top-quality gas, the cost of upgrading may be prohibitively high and technological infrastructure may be inadequate.

The size of the fill (i.e., mass of waste) should be sufficiently great to ensure an eventual total gas output that would have a monetary and energy value in excess of that expended on necessary departures from conventional fill practice. It would not be advisable to utilise a fill that is less than 13 m deep. The completed fill should contain at least about 2 million Mg of municipal solid waste [14]. At the peak rate of generation, raw gas production from a fill containing about 2 million Mg of MSW would be on the order of 32 m³/min, or 760 GJ/day [14].

It is readily apparent that the proposed use of the gas exercises a decisive influence on economics and energetics. In a developing country, a safe use might be as a fuel in steam generation or for an internal combustion engine after a minimum of cleaning. Because of the relatively high moisture content and presence of corrosive elements in raw landfill gas, onsite usage of the gas is to be recommended [1].

N. Equipment

N1. BASIC concepts

The construction of a sanitary landfill requires proper equipment, suited to the work to be done, and typically involves a large capital investment. Equipment acquisition accounts for a large fraction of this investment. Furthermore, equipment operation and maintenance usually account

for a large portion of the operating costs. Equipment selection must be in accordance with the landfilling method, and with the amount and efficiency of the machinery to be used in order to ensure successful operational and least-cost procedures. The requirements must take into account the handling, compaction, and covering of the solid waste, as well as the construction of cells and the completion of general earthwork. These activities must be conducted in accordance with the sequential scheme of the work scheduled. The following basic items will be considered: 1) spare equipment, 2) multi-purpose equipment, and 3) maintenance and repair [2,3].

1. **Spare Equipment.** The recommended rate of backup equipment capacity is about 30%. This percentage is applicable to the total amount of work hours resulting from the design of the landfill operation, considering a maximum of 20 hr/day for the operation of heavy machinery. For instance, if the design specifies two machines operating a total of 36 hr/day, a 30% backup capacity factor dictates that three machines be available. Although the purchase of spare equipment will strain the initial capital investment, it will assure the continuity of service and extend the useful life of the machines.
2. **Multi-Purpose Equipment.** One way of balancing the cost of spare equipment is through the use of multi-purpose equipment able to perform more than one task. An example is a landfill compactor that can be utilised for either compaction or covering of solid waste, and for building haul roads. This strategy demands that the time requirement for each particular task and equipment be carefully determined and scheduled. The use of multi-purpose equipment does not supplant the need for spare equipment.
3. **Maintenance and Repair.** Maintenance and repair require detailed planning in order to satisfy the need for continuous service. These tasks should be performed in the field in order to avoid the inconvenience and loss of time attending the hauling of broken down equipment to a remote workshop. Cleaning of all the rolling stock assigned to the handling of solid waste is required on a daily basis. Cleaning must include removal of soil and wastes from the critical rotating and heat transfer systems of the equipment so friction and overheating do not contribute to premature equipment failure. Inspection, cleaning, and washing of the machines' radiators should be performed regularly for all rolling equipment that come into contact with solid waste. This operation should be performed daily, unless circumstances dictate a higher frequency. Other maintenance operations, described in the corresponding equipment manuals and/or catalogues, must be scheduled in advance and performed according to the manufacturer's specifications. The necessary tools and a complete set of manufacturer-recommended spare parts should be readily available at the site for the conduct of light and medium mechanical repairs.

N2. FACTORS

In addition to the obvious factors of suitability of particular equipment to landfill construction and operation and the probable multiple use of that equipment, three important factors enter into equipment selection:

1. amount of waste to be landfilled and the type of materials to be handled;
2. economic feasibility; and
3. availability of maintenance and repair facilities, and skilled personnel to perform the tasks.

However, failure to take into account any one of the three factors makes successful long-term operation of a landfill virtually impossible.

Maintenance and repair are especially important in developing countries. With the exception of the smallest of operations, a landfill involves a large amount of materials handling (soil and solid waste). Because practicality sharply limits the amount of wastes and soils that can be handled manually, most landfill operations must rely on mechanisation. Regardless of the ruggedness of the equipment, it will break down under the rigors of landfill operation unless it is conscientiously maintained.

The need for conscientious maintenance takes on added significance in developing countries because replacement parts often are difficult to obtain. This situation is made worse by the scarcity of personnel skilled in the maintenance of heavy equipment.

N3. FUNCTIONS served by equipment

Basic functions served by landfill equipment fall into the following three categories:

1. functions related to soil (excavation, handling, compaction);
2. functions related to wastes (handling, compaction); and
3. support functions.

Depending on the size of the operation, the same piece of equipment potentially can be used for more than one of the three functions.

N3.1. Relative to soil

The excavation, handling, and compaction of soils used as liner and cover material are considerations when determining the function of the landfill equipment. Procedures and equipment for accomplishing those tasks differ only slightly from those used in other earth-moving operations. Consequently, the degree of mechanisation and sophistication of equipment suitable for sanitary landfilling in a given situation would not differ markedly from that which is characteristic of other earth-moving operations in that area. This limitation extends to the procedural and equipment variations to meet specific requirements due to local topographic and soil conditions. For example, wheeled equipment usually is satisfactory for excavating soils in which sand, gravel, clay loams, and silt loams are the predominant constituents. On the other hand, tracked equipment would be indicated for the less workable soils.

N3.2. Relative to wastes

Functions served by equipment relative to wastes are distribution, spreading, and compaction. With small-scale operations, and those sharply constrained by inadequate economic resources, the equipment used for earth moving is adequate for the waste handling functions. Distribution can be accomplished by confining the unloading of collection vehicles to the immediate vicinity of the working face and, thereby, combining distribution and spreading. This dual function can be done by means of the bulldozer used to move and spread soil, and for compaction.

The compaction activity demands full attention because of its many short- and long-term effects on the operation of the landfill and rate and extent of settling, but mostly because it is an important determinant of landfill capacity. Heavy equipment specifically designed for compaction would be more effective and efficient for this function than would be a piece of lightweight equipment designed primarily for earth moving. However, lack of substantial machine weight (or, more correctly, applied pressure) can be offset significantly by increasing the number of passes over the waste mass.

Landfill equipment must be rugged because operational conditions for equipment used at the fill are far from ideal. Radiators tend to become clogged and damaged, and the body and operating parts of the equipment can be damaged by protruding or dislodged wastes. Tires, even heavy-duty types, can be punctured or cut, which results in a short lifespan. This combination of unfavourable factors emphasises the necessity of maintaining a parts inventory and an adequate repair and maintenance facility convenient to the fill.

N3.3. Support functions

With respect to the initial and subsequent construction phases of a landfill, support equipment would be needed for the installation of environmental control measures such as flexible membrane liners and covers, a leachate collection facility, and gas vents.

Support functions during the operational phase include extension and maintenance of roads to the working face of the fill, dust control, and fire protection. Unless collection and transport vehicles are equipped with self-unloading features, support equipment might be needed to assist unloading. If labour is abundant, unloading can be done manually.

N4. EQUIPMENT types: descriptions and specifications

N4.1. Considerations

Factors that will be considered in this section are closely related to types and characteristics of the machines themselves. One characteristic that should receive careful consideration in equipment selection is the ability of the machines to perform multiple functions. More importantly, the selection should be based upon the primary function of each piece of equipment and its ability to handle those functions under the conditions peculiar to the site.

N4.2. Types of rolling equipment

The following paragraphs will deal with the main functions and characteristics of the different types of equipment used at sanitary landfills.

N4.2.1. Track-type tractors with push-blades (bulldozers)

N4.2.1.1. Function

The function of bulldozers is to distribute and compact solid waste, as well as to perform site preparation, provide daily and final cover, and general earthwork. An example of a bulldozer is shown in Figure XIV-24.



Courtesy: CalRecovery, Inc.

Figure XIV-24. Bulldozer

N4.2.1.2. Characteristics

Bulldozers are equipped with metal tracks having variable standard widths. The cleats of the tracks must be high enough to facilitate size reduction of the solid waste and to provide good traction on the slopes planned for the fill. The bearing pressures exerted on the solid waste or soil typically are in the range of 0.5 to 0.8 kg/cm² for track-type tractors with power ratings in the range of 100 to 230 kW.

The degree of compaction of the solid waste depends on the pressure exerted. Tracked machines are not very efficient at compacting solid wastes due to their low ground pressure.

In order to obtain maximum efficiency from a track-type machine, it is very important that it be equipped with an adequate blade to push the material. The density of solid waste is about 3 times less than that of soil; therefore, it is possible to increase the capacity of the blade. The capacity of a blade can be increased by increasing its height, e.g., by using a steel screen. A screen avoids interfering with the operator's visibility. The dimensions of the blades vary with each model. For example, a typical 100 kW machine would have a blade with the following dimensions: 3.2 m wide and 1.8 m high (with screen).

The push-blade is controlled through a hydraulic mechanism. The estimated productivity for a typical 100 kW model, on flat surfaces, is on the order of 50 Mg of solid waste/productive workhour. On sloped surfaces, the production will obviously decrease; thus, for a recommended maximum slope of 30°, production will be reduced to 30 Mg/hr for the same 100 kW model.

N4.2.2. Landfill compactors

N4.2.2.1. Function

Landfill compactors spread and compact the incoming solid waste. A photograph is presented in Figure XIV-25.



Courtesy: CalRecovery, Inc.

Figure XIV-25. Landfill compactor

N4.2.2.2. Characteristics

Landfill compactors typically are equipped with either a standard or turbo diesel engine. The metal wheels, which perform the compaction process, usually have alternated, specially designed teeth that allow them to concentrate the weight on a smaller contact surface (as compared to a track-type machine) and to exert a greater pressure on the solid waste. For example, landfill compactors weighing 16,000 to 26,000 kg typically exert a pressure of 75 to 120 kg/cm², respectively.

This type of equipment is more versatile and faster than bulldozers. A typical 110 kW model will have a productivity of approximately 75 Mg/hr on flat surfaces. The productivity decreases to about 50 Mg/hr for a 30° slope.

Landfill compactors are equipped with a hydraulically controlled blade. The blade may have a metal screen attachment above it to increase its processing capacity of the compactor, to allow the operator to see the waste in front of the blade, or both. The blades are characteristically about 3 m wide and 1.9 m high, including the screen.

N4.2.3. Wheel loaders

N4.2.3.1. Function

Wheel loaders are designed to excavate soft ground (i.e., ground offering little resistance), load the excavated material onto trucks, and pick up or transport that material to distances not greater than 50 m to 60 m (for optimum efficiency).

N4.2.3.2. Characteristics

Wheel loaders generally are equipped with a diesel engine and four-wheel drive. The front axis is fixed and the rear axis can oscillate. Models vary in power, ranging from 75 to 280 kW. The capacity of the bucket varies from 0.8 to 6 m³. The most commonly used models are those falling in the range of 75 to 110 kW, with bucket capacities characteristically in the range of 1.3 to 2.7 m³, respectively.

On soft ground, a 100 kW machine with a bucket capacity of 1.9 m³ would be able to excavate and load a dump truck at a rate of about 160 m³/workhour. On tougher ground, the production would be less.

Wheel loaders also are able to perform efficient earthwork with clay-like soil, such as cell covering operations and preparation of sites to be landfilled.

N4.2.4. Track-type loaders

N4.2.4.1. Function

Track-type loaders can perform similar functions to wheel loaders. Track-type loaders also are able to excavate tough ground. The optimum distance for a track-type loader to transport material does not exceed 30 m.

In emergency cases, track-type loaders can be used to handle (i.e., to spread and compact) solid waste. They can also be utilised to contour and level the cover material.

N4.2.4.2. Characteristics

Tracked loaders are equipped with a diesel engine having power ranging from 70 to 200 kW. Machines having bucket capacities in the range of 1.3 to 2.5 m³ and bearing pressures in the range of 0.8 to 0.9 kg/cm² typically are powered by engines in the range of 70 to 140 kW, respectively.

The bucket in track-type loaders is easily and quickly operated through a hydraulic mechanism. Better efficiency and flexibility can be achieved with this equipment when it is equipped with a multi-purpose bucket. This type of bucket performs four different operations, according to the position in which the bucket is operated. With a multi-purpose bucket, the track-type loader can function as a loader (opening the grapple will allow the material within the bucket to be totally discharged), dozer, or scraper. Additionally, the clamping capability of a multi-purpose bucket can be used to lift materials like trunks and branches of trees.

The approximate earth-moving capacities for loaders and scrapers are presented in Table XIV-7.

Table XIV-7. Approximate earth-moving capacities for average soils (m³/hr)

Type	Capacity of Unit (m ³)	One-Way Haul Distance (m)								
		0	30	60	90	120	150	180	240	300
Tracked loader	2	80	60	45	40	35	30			
Pulled scrapers	12					165	145	125	100	75
Self-propelled scrapers	14						250	240	210	180

N4.2.5. Track-type (tracked) excavators

N4.2.5.1. Function

The function of this equipment is typically to excavate soil, excavate trenches for the placement of solid waste, load trucks, and to apply the daily or primary cover of solid waste. Track-type excavators can also be used for certain tasks in earthwork operations. An example of this type of machine is given in Figure XIV-26.



Courtesy: Caterpillar, Inc.

Figure XIV-26. Track-type excavator

N4.2.5.2. Characteristics

The excavator is equipped with a diesel engine and a hydraulic system to control the movement of the boom and that of the bucket.

The length of time of the excavation cycle depends on the size of the equipment and on the site conditions. Thus, when the excavation is more difficult or the trench is deep, the excavation procedure will be slower. The cycle time is primarily a function of the type of soil and excavation depth. For excavators with engines rated in the range of 100 to 240 kW, bucket capacities and

maximum depth of excavation are in the range of 0.8 to 1.9 m³ and 6.4 to 8.5 m, respectively (measured from the ground level), depending on the reach of the boom and the type of soil.

N4.2.6. Motor graders

N4.2.6.1. Function

This equipment is used in the construction and maintenance of hauling roads, embankments, and drainage ditches, and in the profiling and levelling of cover material.

N4.2.6.2. Characteristics

Graders are equipped with a diesel engine, rubber wheels, and power steering. The equipment typically is powered by engines with power ratings of 90 to 160 kW and gross weights of 12,000 to 18,000 kg. The standard blade for these machines is about 4 m in length and 0.7 m in height. The blade can reach a maximum slope of 90°, and is able to adopt different positions.

These machines can carry a scraper as an additional piece of equipment. The scraper is used to rip the ground to a depth of 0.1 to 0.3 m.

N4.2.7. Soil compactors

N4.2.7.1. Function

The function of soil compactors is to compact soils and embankments.

N4.2.7.2. Characteristics

Soil compactors can either be self-propelled or pulled by tractors.

Basically, this equipment performs compaction by conveying high pressure to the soil using cylindrical drums with “feet”. The drums can be ballasted with water. The average pressure depends on the design of the drum and foot, and on operating conditions. For the case of two cylindrical drums having the following dimensions: diameter of 1.53 m, width of 3.4 m, 120 feet/drum, and 12,600 kg of drum and water ballast -- the pressures exerted on the ground (over several types of foot designs) would be in the range of about 27 to 82 kg/cm².

Some machines have a mechanism that allows oscillation of the drums, which can facilitate uniform compaction, even on irregular layers of soil.

N4.2.8. Pneumatic tire compactors

N4.2.8.1. Function

These machines are designed to compact topsoils and sub-layers, especially when loamy material is present. High and uniform densities can be obtained throughout the thickness of the layers.

N4.2.8.2. Characteristics

Pneumatic tire compactors can be either self-propelled or hauled by tractors. The load is transmitted to the ground through the contact surface of the tires, which form the rolling unit. Typically, these compactors have seven tires.

The ballasting of the equipment is done with wet sand (density = 2,000 kg/m³), which can reach weights ranging from 13,000 to 35,000 kg. The operation is as follows:

- Initially, low tire pressures are used in order to have greater contact areas and less compaction resistance.
- During the compaction process, the tire pressures are increased, reducing the contact area and, therefore, the compaction pressure.

These machines have a device that allows proper control of the pressure of the tires.

N4.2.9. Self-propelled vibratory drum compactors

N4.2.9.1. Function

Vibratory drum compactors are designed to effectively compact soils and cover material formed by normal soils, whether granulated or clay-like.

N4.2.9.2. Characteristics

Vibratory drum compactors have a metal drum on the front. The approximate dimensions of the drum are: width, 2.15 m; diameter, 1.5 m. The compactors have pneumatic tires on the back.

The vibration system is operated by a hydrostatic engine directly connected to the vibrator, allowing variations in amplitude and frequency, independent from the speed of the propelling engine. The vibration frequency can be regulated to reach a maximum of up to 2,000 vibrations/min.

The weight of the equipment varies according to the model (9,000 to 12,000 kg).

N5. INSPECTION and maintenance

As previously indicated, the costs associated with operation and maintenance of the equipment used in landfills account for a major portion of total costs of operation. A program of frequent inspection and systematic maintenance should be implemented in order to prevent costly breakdowns of equipment. The maintenance program should be based on guidelines provided by the manufacturers of the equipment.

Facilities must be provided for carrying out the various maintenance procedures. Facilities include garages, tools, testing equipment, and a stock of replacement parts. Equipment manufacturers should be requested to provide a list of basic replacement parts and the name and location of a source for additional parts. Ideally, the source should be located within the country.

A summary of typical equipment required to operate a sanitary landfill is given in Table XIV-8.

Table XIV-8. Suggested equipment requirements as a function of waste generated

Waste Generated (Mg/day)	Equipment			
	Quantity	Type ^a	kW	Wt (1,000 kg)
0 to 20	1	TD, TL, RTL	50 to 75	6 to 9
21 to 50	1	TD, TL, RTL, LFC	60 to 160	7 to 20
51 to 130	1	TD, TL, RTL, LFC	75 to 160	9 to 20
131 to 250	1	TD, TL, RTL, LFC	110 to 240	12 to 30
251 to 500	1 or 2	TD, TL, RTL, LFC, S, DL, WT	190 to 340	25 to 40

^a TD = tracked dozer
 TL = tracked loader
 RTL = rubber-tired loader
 LFC = landfill compactor
 S = scraper
 DL = dragline
 WT = water truck

O. Provision for material recovery

O1. INTRODUCTION

This section discusses only material recovery performed at the final disposal site (scavenging), not that performed at the point of waste generation, during collection, during transport, or in a materials recovery facility. Presently, the sequence most commonly followed for scavenging at a typical disposal site in a developing country is as follows: incoming refuse is discharged at or near the working face, scavengers sort through the load, equipment spreads and compacts the residues from the scavenging activity, and the scavengers sort their recovered materials into organised portions.

Typical materials recycled in this manner include unbroken bottles, metals, plastics, cardboard, paper products, bones, textiles, and glass.

O2. PROBLEMS due to scavenging

The case for allowing scavenging at the final disposal site must be strong enough to counterbalance the objections that can be raised against scavenging. These objections stem primarily from the safety hazards to the personnel of both the scavenging group and landfill employees and secondarily from the interference caused by the scavenging activity with respect to the fill operation. The hazards posed by the intermingling of the manual scavenging activities and the equipment-oriented sanitary landfilling activity increase with the number and size of the landfill equipment.

O3. ESTABLISHMENT of scavenging site

The difficulties that arise between the landfill operations and scavenging can be substantially reduced or even eliminated by treating the scavenging activity as a first phase in a series of steps that make up the landfill activity. This approach allows a physical separation of the two activities. Unfortunately, such a separation adds a step to the overall operation. The step consists of two parts: 1) discharge the incoming wastes at the area designated for scavenging at the disposal site, and 2) transfer the residue remaining after scavenging to the working face.

If the scavenging area is established relatively close to the working face, transport of the residue from the scavenging operation may be done quickly by means of a bulldozer. This arrangement

would require that the scavenging area be movable. The design of a system of this type should provide adequate separation between the two activities so that those of the scavengers do not interfere with those of the land disposal operation.

A permanent scavenging facility can also be established, although a fixed scavenging site in most cases would be neither feasible nor advisable for a small disposal site. Dedication of a fixed portion of the disposal site to scavenging takes on many of the characteristics and advantages of a transfer station. For instance, scavenging done in a fixed area can be sheltered from the elements (wind, rain, etc.), the operation itself can be kept more orderly and closely controlled, and efficiency can be improved by including a certain amount of mechanisation (e.g., conveyor belts and screens). Best of all, encounters between scavengers and landfill equipment could be limited or avoided altogether. These advantages combine to enhance efficiency. This alternative allows for the provision of much needed sanitary facilities and a better working environment for the scavengers.

The scavenging area can be located about 1 to 2 km away from the working face. In this case, the waste to be disposed would be transported by means of a truck. The size of the disposal site is the decisive factor regarding advisability and necessity for dedicating a portion solely to scavenging. In general, a minimum lifespan of 10 years would justify the incorporation of a fixed scavenging area. This option was been adopted for the management of a portion of the residential wastes generated in Mexico City, Mexico.

O4. MANAGEMENT of scavenging activity

Landfilling should have precedence over scavenging since the reason for the fill is the disposal of wastes. Therefore, scavenging must be managed in a way that does not unduly interfere with the main activity of the landfill site. On the other hand, consideration must be given to the loss of income to the scavengers, as well as the loss of secondary materials to the local industry, if scavenging were to be discontinued. In some cases, secondary materials have been shown to play an important role in the local economy [10].

Unless traffic to and from the disposal site can be carefully managed, it can be one of the more disruptive of the interfaces between scavenging and final disposal. Among the more obvious causes of disruption are the increase in number of vehicles using the same road and the different vehicular speeds that result from the different types of vehicles employed for waste hauling and by scavengers. In some instances, long delays are brought about by the discharge of recyclable materials from the waste collection vehicles. Waste hauling traffic will generally move at a much faster speed than will scavenger traffic, and will be substantially slowed both by intermingling with scavenger traffic and by the increase in traffic density. One of the better approaches to separate the traffic is to provide different access roads. Unfortunately, this is probably one of the more expensive solutions. Hence, the decision involving separation of access would rest upon economic feasibility.

O5. SUPERVISION and procedures

The scavenging activity should be under the direction of a supervisor whose principal function is to make sure that the activity proceeds efficiently and fairly, and does so with a minimum of interference with the disposal operation. Accomplishing the latter objective implies working closely with the manager of the disposal operation. The manager of the disposal operation should have the authority to make decisions with regard to scavenging activities that affect the disposal operation. Efficiency and safety demand that good housekeeping be rigorously enforced.

A relatively fixed set of procedures should be established for the scavenging activity. Procedures should be established concerning: 1) assignment of spaces and refuse loads to individual scavengers or groups of them; 2) removal of scavenged material from the site (i.e., frequency, method of loading, type of vehicle used for the removal); and 3) sale of the recovered materials

The labourers should be provided with uniforms and safety equipment, bathrooms, showers, eating facilities, and first aid equipment.

P. Environmental monitoring

Ultimately, the rationale for monitoring is to detect adverse impacts of the landfill on the adjacent air, water, and soil environments so as to be able to take the remedial measures needed to counteract the impacts. The process consists of: 1) establishing baseline environmental data and characterising the nature, extent, and magnitude of the impact; and 2) developing a remedial course of action. Impacts are indicated and identified by differences between the pre-landfill and post-landfill qualitative and quantitative characteristics of the air, water, and soil environments, or by the existence of gradations in quality and quantity with respect to proximity to the fill. Programs and methods for monitoring can range from minimal to quite extensive in terms of extent, complexity, type, and costs. The minimal category would be sufficient for situations in which the need for monitoring does not warrant an extensive program.

P1. GROUNDWATER

According to the general principles mentioned in the preceding paragraph, impact on groundwater quality can be evaluated on the basis of difference between groundwater quality (e.g., pH; dissolved solids concentration; chemical composition; and presence, identity, and concentration of microorganisms before and after construction and completion of the fill). Impact of an existing fill on groundwater flowing under and around the fill can also be evaluated on the basis of difference between the quality of the groundwater before it reaches the vicinity of the fill and after it has moved beyond the fill. Estimates depending upon groundwater flow pre-suppose a knowledge of the direction and velocity of the groundwater flow.

Potential impact on groundwater quality can be estimated on the basis of the composition and quantity of leachate generated in the fill. Knowledge of leachate composition and rate of production would also be of use in the identification of contaminants attributable to the landfill and in predicting the intensity of the contamination. To obtain such knowledge, it is necessary that the fill be provided with a leachate collection and sampling system. The problem is that in developing nations, such installations are rare and the fund of accumulated data under controlled conditions is sparse. The applicability of leachate data collected for landfills in industrialised countries must be analysed prior to considering them representative of a given location in a developing country. If a leachate collection system is available, then monitoring would consist of measuring rate of leachate production and analysing the leachate for items of interest. Examples of such items are physical characteristics, the identity and concentration of toxic chemicals and chemical constituents adverse to water quality, and pathogenic organisms.

P1.1. Monitoring wells

Because sampling (collection and analysis) is a key element in a groundwater monitoring program, the method of sampling must be carefully considered. In this connection, networks of monitoring wells play an important role. The extent and sophistication of this network are determined in part by the purpose of the program and by the economic and technological resources of the region that is to be served by the network. With regard to purpose, a monitoring well network for gross groundwater quality indicators differs drastically from wells intended for

detecting toxic organic compounds or heavy metals. The wells must be installed at proper horizontal and vertical positions near the landfill.

Appropriate methods for installing the wells are determined on the basis of anticipated nature of subsurface aquifer materials, site accessibility, availability of drilling water, desired diameter and depth of the well, nature of subsurface contaminants, and economic and time constraints. (A list and evaluation of the many methods may be found in “Guidelines for the Land Disposal of Solid Wastes” [8].)

Of the various applicable criteria, all wells should, at least, meet the following two criteria: 1) water must flow freely into the well; and 2) downward migration of surface water or upward migration of undesired groundwater to the well-intake zone must be prevented. Basic elements in the design of monitoring wells are the casing, filter pack, seal, annulus backfill, and grouting. The elements are indicated in Figure XIV-27. Installation is completed by well development. Well development accomplishes two tasks: 1) the well is cleared of foreign materials introduced during drilling, and 2) the natural formation adjacent to the well screen is restored. Development may be accomplished by way of bailing, pump surging, air lifting, and combined air lifting and bailing.

Among the several methods for drilling a monitoring well are hand-augured boring, auger drilling, mud-rotary drilling, air-rotary drilling, and cable-tool percussion drilling [29]. Of these methods, hand-augured boring is the least expensive. However, it is best suited for shallow borings (less than 4 m deep) that are only 5 to 15 cm in diameter. Auger drilling is suitable for depths of about 45 to 50 m.

P1.2. Collection and analytical methods

With the use of the installed and developed wells, it is possible to obtain samples that are chemically representative of the water taken in by the well. Consequently, attention must be directed to: 1) the physical extraction of the water from the well, 2) the preservation of the chemical integrity of the sample in transit to the place where it will be analysed, and 3) the attainment of analytical results that are accurate and have a high degree of precision.

Among the several means of collecting samples from the wells are: down-hole collection devices; suction-lift, positive displacement, gas-lift, and gas-drive methods; gas squeeze or bladder pumps; and jet or venturi pumps [31].

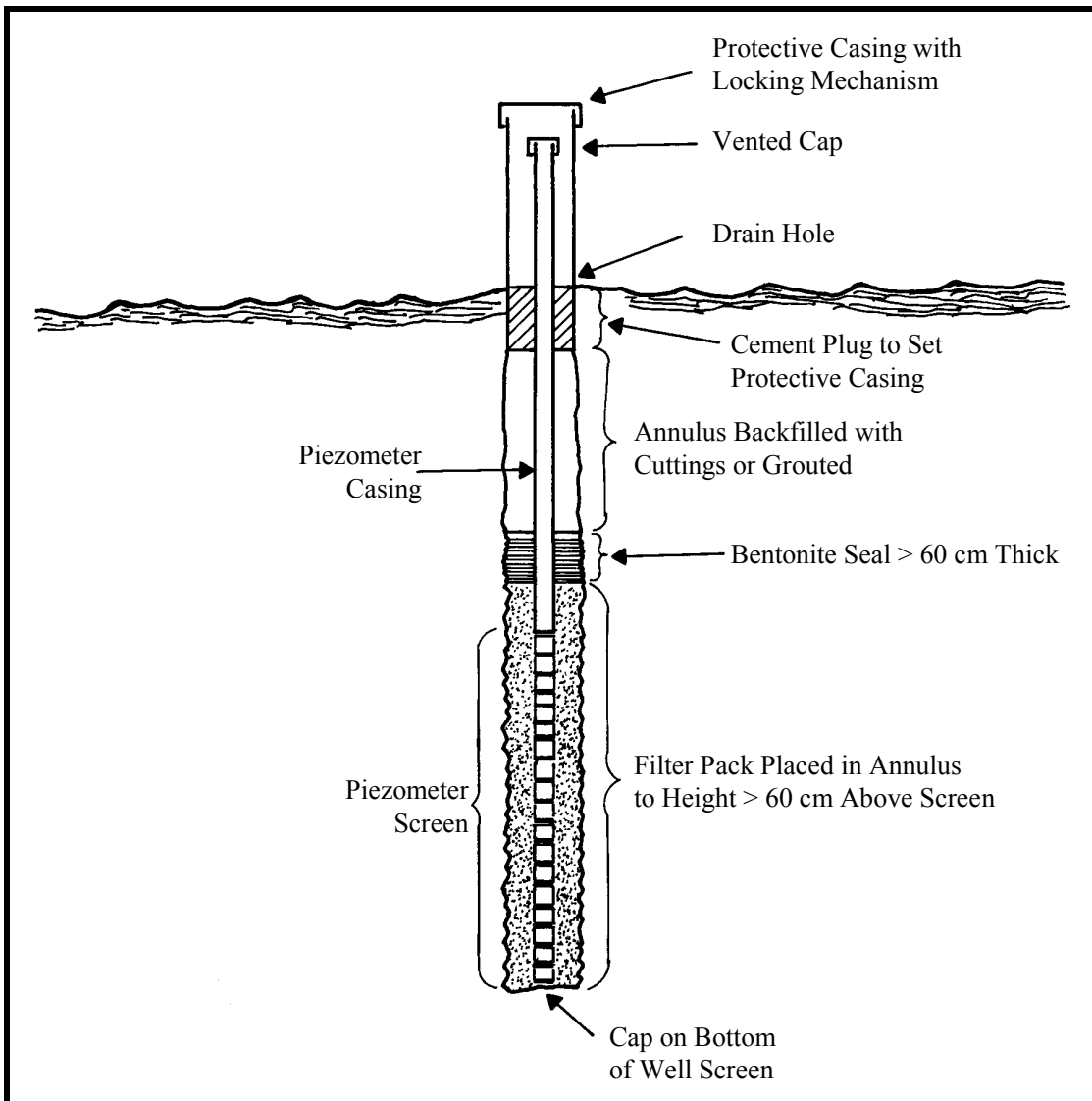

Figure XIV-27. Groundwater monitoring well

The following water quality parameters are recommended for analytical determination and monitoring due to the fact that the presence of them is a potential indicator of contamination by landfill leachate:

- pH,
- specific conductance,
- alkalinity,
- biological oxygen demand,
- chemical oxygen demand,
- nitrate/nitrite nitrogen,
- total (Kjeldahl) nitrogen,
- chloride,

- iron,
- sodium,
- manganese, and
- sulphate.

The pH level and specific conductance should be determined in the field, while the other sample analyses can be carried out by laboratories at universities or those that typically analyse the characteristics of potable water. The recommended frequency of sample collection and analysis is at least twice per year.

In addition to the water quality parameters listed above, analyses and monitoring for other metals and some organic chemicals should be considered for the groundwater testing program depending on the availability of financial resources and analytical testing capability. The additional list of parameters are listed below:

- arsenic,
- barium,
- cadmium,
- chromium,
- mercury,
- lead,
- selenium,
- total phenols, and
- volatile organic compounds.

These parameters can be monitored less frequently than twice per year and depending on site-specific conditions.

P2. SURFACE water

The necessity or advisability of monitoring surface water quality depends upon: 1) the proximity of the landfill to surface water, and 2) the drainage patterns between the fill and the surface water. The approach followed in the selection of sampling stations, equipment, and procedures should be similar to the approach used in the selection process for groundwater monitoring. The stations should be located in areas that have the greatest potential for contamination. These areas include the pathways through which leachate can enter a surface body of water. Flow patterns and seasonal variations should also be taken into consideration. Equipment used for sampling surface water and the methods used to analyse the samples should be consistent with procedures selected for testing groundwater samples.

P3. LANDFILL gas and migration

As stated in another section, landfill gas can escape by vertical and lateral migration. Obviously, if the landfill cover is sufficiently permeable, gas can exit vertically, i.e., through the cover. If the cover is impermeable (e.g., rain-saturated cover soil, pavement, or a clay or synthetic membrane cap) this escape route is blocked. Because of this blockage, lateral migration becomes the only avenue of escape. The distances involved in lateral migration can be significant, especially if the fill is adjacent to permeable soil strata.

Sampling devices should be located near the property boundary and offsite on the landfill side of structures in pathways most susceptible to gas migration. Simple gas probes can serve as gas sampling devices. The technique used in the collection of the samples is determined by the type of sampling probe. Methane usually is monitored by means of a portable meter. Methane gas concentration in facility structures, and in structures not on the facility, should not exceed 25% of the lower explosive limit. (The lower explosive limit is 5% methane.) In light of the mobility of landfill gas, precautions must be taken before human entry into any underground or confined space in the vicinity of a landfill. The space should be monitored for the presence and concentration of methane. Entry should be forbidden if the concentration is greater than 10% of the lower explosive limit.

Q. Uses of completed landfills

A completed sanitary landfill represents an opportunity to recover resources (landfill gas) or to construct facilities. Recovery of landfill gas is described in another section. The construction of several types of facilities on a landfill after its active life is described in the next several subsections. Because of the explosion hazard that results from the accumulation of landfill gas in enclosed spaces, housing and commercial construction on landfills should be limited to completely stabilised landfills unless special methods are used and precautions are taken.

Because of the many and often substantial constraints and limitations associated with the construction and utilisation of structures erected on a completed fill, the use of completed landfills as sites for construction and particularly for urban development generally is discouraged in industrialised countries [35]. However, in some locations a shortage of land prompts consideration of the potential of such sites. The situation is different in developing countries, especially in those in which the migration of populations from rural areas to the urban centres is substantial. Because of the migration, all unoccupied land has become attractive. Such being the case, the only recourse is to apply, to the fullest possible extent, precautionary measures designed to lessen associated hazards. Examples of proposed uses of completed fills are described in two World Bank reports: *Swamp Reclamation in Tropical Monsoon Regions by Appropriate Refuse Landfilling: Case Study Evaluations in Thailand* [36] and *Study of Landfill and Resource Recovery in Metropolitan Colombo* [37].

Constraints mainly take the form of problems associated with use of the site. Consequently, a sizeable share of these problems is geotechnical in origin and nature. Of equal importance is a group categorised as “potential hazards”.

Q1. GEOTECHNICAL problems

Settlement, a major geotechnical problem characteristic of all waste landfills, is addressed in another section. Not discussed in the previous section, however, is the problem posed by the relatively low bearing capacity of a completed fill. Despite variations in types of soil, in the characteristics of the landfilled wastes, and in the degree of settlement, the fact remains that reported values of bearing capacity indicate the prevalence of very low bearing capacities.

Reported values range from 2,440 to 2,910 kg/m². These rather low values apparently would restrict the construction of buildings on the completed fills to lightweight, single-story structures.

Q1.1. Solutions

The best course of action is to suspend the floor slab on sulphate-resistant cement piles. (The cement is of Class 4 or 5 (BRE 1981).) If the piles are made of materials other than concrete, they should be protected by corrosion-resistant material so as to cope with corrosive decomposition products in the fill.

A light, one-story building designed to accommodate settling may not require piling. However, its foundations should be reinforced to bridge gaps formed by differential settling. Continuous floor slabs reinforced as mats can also be used.

Roads, parking areas, and walkways should be constructed of flexible and easily repaired material.

Q2. POTENTIAL hazards

An important feature of the potential hazard of landfills is the fact that the potential persists as long as decomposition processes continue. Unfortunately, decomposition processes continue long after the site has been closed.

The three broad categories of potential hazards are landfill gas production, chemical contamination, and corrosion. In addition to the attention given here, gas production receives considerable attention in another section. Chemical contamination also is addressed elsewhere in this chapter.

Q2.1. Landfill gas production

As stated earlier, the rapid depletion of O₂ entrapped within the mass of buried wastes results in a rapid shift in the composition of the landfill gas from a preponderance of CO₂ to one of CH₄. The significance of this shift stems from the combustible and, under some conditions, explosive nature of CH₄. Because the rate of methane generation is extremely slow, methane production, *per se*, does not constitute a hazard. Consequently, methane becomes a combustible or explosive hazard only when the gas accumulates in a confined space within the fill itself or within a structure erected either on the fill or close to it. In some cases, pressure exerted by the buildup of landfill gases has been high enough to force the gas through permeable strata in soil adjacent to an unlined fill.

Although not necessarily hazardous, the malodorous nature of some trace constituents of landfill gas can be sufficiently intense as to constitute a problem. Examples of malodorous constituents are esters and organosulfurs. However, high dilution factors and low generation rates can sometimes, but not always, combine to keep malodorous gases from posing a problem in the use of the completed fill.

Q2.2. Corrosion

The hazard posed by corrosion is to building materials, utilities (pipes), and other items related to construction. The corrosion potential is in the many highly chemically active breakdown products found in decomposing municipal wastes. For instance, the mechanisms of attack on concrete include leaching of soluble materials, degradation of the binding capacities of cement by chemical change, disruption caused by expansion of reaction products, and crystallisation of salts

within the concrete pores. With respect to utilities, metals are subject to attack by the acids generated within the fill as products of anaerobic decomposition. (Of course, steel reinforcement rods are subject to the same acid corrosion.)

Q2.3. Solutions

Procedures for preventing gas production from becoming a hazard at the fill and its environs are described in another section. Measures described in this section are specific to the use of the fill for construction and urban redevelopment. With regard to construction on a fill, the following measures should be taken:

- Install the floor slab carefully so as to prevent cracking and to keep the concrete from becoming porous.
- Do not allow cavities to develop under the slab.
- Install an impermeable plastic membrane within or beneath the floor slab.
- Lay the slab on a layer of gravel or crushed stone. The layer may be actively or passively ventilated.
- Build the structure above the surface of the landfill and incorporate a well ventilated subfloor area. Active ventilation involves the use of a pump capable of ensuring several air changes/hour. Passive ventilation (i.e., “naturally occurring”) is sufficient in situations in which the rate of gas evolution is low.
- Do not install utilities by penetrating the floor slab. Therefore, piping, conduits, etc. should enter the structure above floor-level.
- Install strategically located methane alarms in the structure.

Q3. RECOMMENDATIONS for construction on completed fills

The following recommendations are based on criteria reported in the literature [38]:

- Construction and urban redevelopment should not be allowed on a newly completed deep fill that has a large concentration either of industrial wastes or of freshly deposited highly organic wastes.
- The fill should have been completed ten years prior to redevelopment.
- The completed fill should not be deeper than 10 m.
- The fill site should have a stable, low water table.
- The fill itself should contain no toxic or hazardous wastes, particularly liquid wastes.
- The development should be in keeping with the site conditions.
- Expenditures on the development should be in keeping with the intended use of the development.

Redevelopment should not be approached solely on a cost-effective basis. The approach also must be equally satisfactory on an environmental basis. Thus, adequate safety measures must be taken into consideration in the design of structures.

Q4. POTENTIAL uses

As stated in the other sections, all uses of completed landfills are subject to certain constraints and limitations that remain in force until the biodegradable fraction of the buried wastes has been almost completely decomposed, and chemical and physical processes going on in the fill have reached a relatively high degree of stability, i.e., are approaching equilibrium. Among the more important of the constraints are those that arise from:

- the low bearing capacity of the fill cover,
- extensive settling (especially uneven settling),
- presence of combustible and explosive gases, and
- the corrosive character of decomposition products and the internal landfill environment in general.

These processes and their associated constraints continue long after the fill has been completed. The duration of this period is a function of climate (rainfall, temperature), nature of the buried wastes, and design and operational features of the landfill. For example, the duration may be as brief as two or three years in a developing country located in a humid, tropical setting and longer than ten years in an arid environment.

The uses may be divided into the three general categories: open space, agricultural, and urban developmental.

Q4.1. Open space and recreation

Although “recreation” and “open space” can be treated as separate land uses, they can also be regarded as mutually inclusive. Many reasons can be given for regarding recreation as being the most beneficial of the potential uses of a completed fill. In some cases, the completed fill probably provides the only site that will be available for recreation within the foreseeable future. The list of potential recreational uses is extensive. The types of uses largely reflect culture (e.g., cricket vs. baseball), although open space would appeal to the widest spectrum. It is important to note that all constraints attending the construction and use of structures apply to structures erected for recreational purposes.

Q4.2. Agriculture

The completed fill can be for agriculture when reservations concerning this use are taken into consideration. Among the agricultural uses are grazing, crop production, tree farms, orchards, nurseries, etc. In all cases, the final cover on the fill should be deep enough to ensure that roots do not come into contact with the buried wastes. Not only would such penetration be inhibitory to the crop plant(s), whether it be grass or trees, it may also serve as an avenue for introducing harmful substances into the food chain and the environment. The precaution becomes especially important when food crops are concerned. (Examples of root depths are: grasses - 0.7 m.; shrubs, corn, alfalfa - 1.3 m; trees with laterally branching root systems - 1.3 to 2 m; trees with tap root systems -- greater than 4 m.)

Q4.3. Construction and urban development

Even though construction and urban development are low priority uses, it is highly likely to occur in developing countries, especially in regions undergoing rapid or accelerated urbanisation. In these regions, vacant space for residential and commercial construction is becoming increasingly scarce. For example, in Cairo, apartment buildings for the poor are built on landfills. Every effort should be made to observe necessary constraints and precautions associated with this use.

Q5. REHABILITATION of existing facilities

In economically developing countries, the great majority of the land disposal sites are not equipped with bottom liners. Consequently, most of the land disposal sites do not have leachate collection and treatment systems. This situation may be acceptable in some arid- and semi-arid regions or in situations where the land disposal site is located remotely from sources of surface and groundwater. However, there are many communities located in areas that receive relatively large quantities of precipitation and, consequently, probably are polluting or will eventually pollute the soil and water resources.

A typical open dump in an economically developing country is operated without any fixed plans or procedures. Access to the site is not controlled, which inevitably leads to the presence of different types of animals feeding on the waste. Dumping on a down slope (e.g., at the top of a ravine or drop-off) is a typical practice. In such a case, no containment of the working face occurs, and the slope of waste is so steep that the waste is not compacted, nor is it likely in a state of structural stability.

The rehabilitation of an unmanaged land disposal site has several benefits associated with public health and the environment. In addition, the rehabilitation can be carried out in such a way that valuable space can be reclaimed. In some cases, additional landfill capacity can be achieved either through excavation and processing of the waste or through vertical expansion from the rehabilitated site.

There are a number of activities that should be carried out in any process of rehabilitation or closure of an existing dumpsite. The more important steps can be combined into the following: 1) preliminary study and evaluation, 2) performance of field work, 3) implementation of measures, 4) closure, and 5) beginning of sanitary landfilling operations (if applicable).

The preliminary study typically involves a thorough assessment of the current situation, location of wastes, verification of property lines, location of environmentally sensitive areas, distance to nearest dwelling, quality and type of access roads, general operating procedures, demand for additional capacity, and other factors. The procedures for either rehabilitating the site for future expansion or for closure are basically the same. The main difference between the two is the preparation of the surface to receive additional refuse.

Once the preliminary study has been completed and the main problems identified, the next step entails the performance of required field work. The field work may include perforation of wells, identification of groundwater and its quality, evaluation of migration of leachate and landfill gas, and other activities. The results of the tests should be analysed by professionals knowledgeable in the specific area (i.e., hydrology, geology, etc.). Based on the analyses, a series of recommendations can be formulated as a plan of rehabilitation.

In the event that leachate migration is identified as a problem, two routes of management can be followed. One is control of additional leachate generation and dispersal, and the second is preventing the migration of the leachate.

Control of leachate generation can be achieved through the control of run-on and run-off of precipitation and through the installation of an impermeable cover. Run-on to the landfill can be controlled by the construction of dikes, berms, or similar structures. Infiltration of the precipitation into the fill itself can be controlled by installing an impermeable layer at the proper inclination to promote runoff. The cover or cap will only prevent additional leachate from being generated. The thickness of the cap will depend upon the location as well as the intended use of the rehabilitated site. Settling and other processes should also be considered if the plan is to vertically expand the rehabilitated site.

In addition to the measures indicated in the preceding paragraphs, attention should be given to the management of the leachate already in the fill, as well as to the control of the landfill gas. Control of the leachate that will seep through the sides of the fill can be exercised through the installation of cut-off subsoil drains. The drains can be shallow or full depth. Shallow drains will, of course, be cheaper to install but may not solve the entire problem and only capture leachate seepage in the rainy season. Full depth cut-off drains designed to reach to the impermeable natural layer would prevent any seepage away from the site. Selection of the most appropriate alternative is a function of location, potential negative public health and environmental impacts, cost, and other factors. Finally, provisions must be made for the management of landfill gas, as well as the monitoring of the site [77].

If the contamination problems are very serious (e.g., contamination of an existing system of water supply), then more substantive actions may be indicated. These actions may involve excavation and removal of all the waste, and either repair of the facility for new landfilling or closure of the site and transport of the wastes to a sanitary landfill. Another alternative is the excavation and processing of the waste, reclaiming some of the recyclable materials, placing a liner or repairing the existing one, and discharging the residues in the repaired site. This process is known as landfill mining and reclamation (LFMR).

R. Economics

R1. BACKGROUND

The economic costs of individual disposal operations vary substantially from country to country and within each country. The variations are impacted by local conditions and regulations, as well as other factors not directly related to landfilling (e.g., assessments for funding recycling programs, etc.). The coverage discussed in this section is limited to the definition of the general components of landfill operation and their costs.

The cost of landfilling depends in part upon the type of waste disposed, size of the operation, availability of fill and cover material, and whether or not construction is phased. Phased landfill construction usually is cheaper than construction of the entire landfill site at one time. Varying site conditions and regulatory requirements for landfill construction are important factors in the variability among landfill construction costs.

As for accurately determining the landfill costs in a particular area, the best approach, when available, is to examine past and current landfill operations in that area. In each area, the cost of landfill disposal depends upon the cost of the land upon which the facility is developed, the design of the landfill, cost of labour, and governmental regulations that must be met.

Not only do landfill costs directly affect the total cost of waste management, they also have a bearing on the extent and nature of the processing to which the wastes might be subjected prior to ultimate disposal. In other words, the manner that wastes are managed by communities generating the wastes is determined to a considerable extent by the cost of disposing of those wastes. For

example, if the cost of land disposal is low, waste reduction and recycling usually are given less emphasis than if the cost of disposal is high. Regardless of the level of economic development of a nation, landfill construction and operation costs usually are only a relatively small fraction of the total cost of waste management when and where the cost of property suitable for landfilling and the other development costs are low. Obviously, under such a circumstance, landfilling the wastes without pre-treatment usually would be the least expensive waste management alternative, although not necessarily the best option of managing the wastes. On the other hand, some form of waste processing to reduce amounts and volumes of wastes destined to be landfilled most likely would be economically justified in areas where land is expensive, scarce, or unsuitable for landfilling. Small, populated islands represent one example of meeting one or all of these land constraints

In most communities in developed countries, the cost of operating the landfill is recovered by means of a user fee. The fee typically is known as “tipping fee”. Tipping fees generally vary as a function of weight, type of waste, and availability of landfill space.

R2. LANDFILL costs vs. total cost of solid waste disposal

The total cost of waste disposal is the sum of the costs for each component of the waste disposal operation. The disposal operation begins with the collection of waste from residential and industrial generators and ends with final management of the landfill site after closing (i.e., closure and post-closure). The total cost of each component of the waste disposal operation is the sum of its capital and operating costs.

The three leading operations are collection, hauling, and processing. Processing is optional. Collection involves the pickup of discarded materials from residential and industrial areas. Hauling is the transportation of the collected wastes either to the landfill or to central collection or processing locations. The actual burial of the wastes at a landfill constitutes landfill disposal. In developing nations, collection represents the major fraction of the costs for waste management.

R3. EFFECT of processing on cost of waste disposal

Baling is one method of processing wastes for the purpose of increasing the density of the collected waste, thereby reducing the volume of the waste to be disposed. This procedure increases the total capacity of the fill. Additionally, less cover soil is required. Expanding landfill capacity and easing cover soil requirements obviously lower landfill costs.

Removal of recyclable materials (e.g., scavenging, composting) is a form of waste processing that reduces the volume of waste destined to be landfilled. The recovery of recyclable materials may take place before, during, or after collection. Waste processing on a large scale, in order to recycle and reduce the quantity of waste landfilled, may be justifiable in areas where landfill capacity is low and alternate sites are remotely located (i.e., more than 50 km away).

One manner in which processing can reduce costs other than by volume reduction is by upgrading the quality of the waste to a level whereby exceptional landfilling measures are not required. Examples of exceptional measures have been described previously. Methods of upgrading the quality of wastes are: 1) detoxification of toxic wastes, 2) encapsulation or solidification of hazardous or toxic materials, and 3) removal of particularly objectionable types of putrescible wastes (i.e., market wastes).

R4. CAPITAL and operating costs

Among the principal capital costs are those of land, buildings and construction, and vehicles. These capital costs usually are fixed costs in that, as a rule, they are set during the course of the landfill operation. Labour required for operation and maintenance, fuel costs, and cost of cover material used during the operation of the landfill are all classified as operational costs. Operational costs are variable in that they generally are a function of the rate and magnitude of waste requiring disposal.

R5. LANDFILL cost models

A major difficulty in developing a landfill cost model that reflects conditions and costs in a developing country is the small amount and questionable reliability of available data. Such being the case, the logical approach is to estimate costs based on site specific data and other data that is relevant. This task can be considerably facilitated by following a suitable model for calculating the costs involved in sanitary landfilling. Such a guide or model has been proposed by L.E. Joyce [39] and is summarised in Table XIV-9. Variations of this model, including more complex ones with more variables, are commonly employed by waste managers in industrialised countries to estimate landfill costs.

Although the model is based on conditions and practices in the United States, it can be adapted for use in developing countries, because it is based on generic rather than specific principles. The costs given in the table can be considered as “indicators” of relative costs, and the distribution of costs among the cost elements is fairly typical of those of modern sanitary landfills in the United States. The elements of cost within each of the major cost categories listed in Table XIV-9 are described in detail in Table XIV-10. The cost elements listed in Table XIV-10 can serve as a checklist during the definition and preparation of costs for a landfill in any part of the world.

Table XIV-9. Model for estimating landfill costs and service fees (180 Mg/day facility) (US\$)

COST BY MAJOR COST CATEGORY	
a. Total pre-development	\$887,000
b. Total initial construction	\$2,812,000
c. Total annual operational	\$1,323,000
d. Annual closure/post-closure	\$70,000
CALCULATION OF TOTAL ANNUAL COST	
e. Capital costs (a + b)	\$3,699,000
f. Amortisation of capital costs (straight line depreciation over 20 years at 9%)	\$401,000
g. Annual operating cost (c)	\$1,323,000
h. Annualised closure and post-closure costs (d)	\$70,000
i. Total annual cost (f + g + h)	\$1,794,000
CALCULATION OF UNIT COSTS AND SERVICE FEES	
j. Annual Mg/year (180 Mg/day x 6 day/wk x 52 wk/yr)	56,200 Mg/yr
Unit cost (US\$/Mg)	
k. Cost/Mg (i ÷ j)	\$32/Mg
l. Host community fee for capital improvements	--
m. State or local fee	--
n. Total tipping fee (k + l + m)	\$32/Mg
Cost/household/month	
o. Annual cost (i)	\$1,794,000
p. Population	100,000 people
q. Cost/person (o ÷ p)	\$18/yr/person
	\$1.50/month/person
r. Persons/household	4
s. Cost/household (q x r)	\$6/month/household

Adapted from Reference 39.

The estimated costs listed in Table XIV-9 are those for a hypothetical 180 Mg/day modern sanitary landfill designed to serve a population of about 100,000 people in the United States. The facility is situated on a 100-ha site, of which 40 ha will be used for actual disposal of waste and 60 ha will serve as a buffer. The average excavation depth is about 3 m. The costs include a double lining system and a leachate collection and detection system. The facility is designed to operate 6 day/wk, 52 wk/yr [40,41]

Table XIV-10. Definitions of elements of cost within the major cost categories listed in Table XIV-9

Pre-Development Costs

Siting the facility (engineering, legal fees, and preliminary geotechnical investigations)

Site mapping (topographic/boundary surveys) and final geotechnical investigation

Engineering design and regulatory permit application

Legal and public hearings

Land purchase

Regulatory permitting fees

Administrative support services

Contingency

Initial Construction Costs

Entrance and access roads

General site excavation and land clearing

Erosion and sediment control facilities

Liners and liner cushion system

Leachate collection and landfill gas venting system

Leachate treatment system

Site landscaping

Scale system

Scalehouse and office building

Equipment maintenance facility

Public convenience area

Miscellaneous site paving

Miscellaneous (lighting, gates, signs, etc.)

Construction engineering and quality control testing

Annual Operational Costs

Site personnel and management

Facility overhead (e.g., building and site maintenance)

Equipment operations and maintenance

Fuel and electricity

Equipment rental

Road maintenance

Routine environmental monitoring (e.g., groundwater quality and landfill gas)

Engineering services

Site and equipment insurance/closure bonding

Ongoing development and construction costs

Leachate treatment at a municipal sewer system

Pre-treatment of leachate prior to disposal into municipal sewer system

Unanticipated costs

Closure and Post-Closure Costs

Engineering fees for preparation of a closure plan

Regulatory approvals of the closure plan

Final site grading and revegetation

Maintenance of erosion and sediment control facilities

Maintenance of landfill gas system

Operation and maintenance of leachate collection system

Leachate treatment

Additional estimated costs for landfilling are provided in Table XIV-11. The data in the table are presented for landfill sites having 100, 200, 300, and 400 ha in total area [40-43].

The estimated costs described in Tables XIV-9 and XIV-11 provide the reader with both a method to format cost estimates and a general understanding of the magnitude of costs for modern sanitary landfilling.

The Panamerican Center for Sanitary Engineering and Environmental Sciences (CEPIS), of the Panamerican Health Organization (PAHO), has developed a computer program to assist users in determining the costs of the various phases of waste management [34].

Table XIV-11. Examples of costs of sanitary landfilling, based on current conditions and practices in the United States (US\$)

Item	Active Landfill Area			
	100 ha	200 ha	300 ha	400 ha
Pre-development^a	430,000	520,000	610,000	700,000
Site preparation				
Clay (onsite)	8,700,000	18,300,000	29,500,000	42,200,000
Clay (16 km-haul)	10,600,000	21,800,000	34,600,000	49,300,000
Membrane/clay (onsite)	11,900,000	24,400,000	38,500,000	54,400,000
Membrane/clay (16-km haul)	12,900,000	26,400,000	41,700,000	58,600,000
Operations (per year)	220,000	380,000	530,000	580,000
Closure^b	1,400,000 to 2,300,000	2,800,000 to 4,600,000	4,200,000 to 7,000,000	5,700,000 to 9,300,000
Post-closure^c (per year)	170,000 to 340,000	240,000 to 480,000	350,000 to 700,000	460,000 to 920,000

^a Items included in pre-development costs: environmental impact analysis/report, feasibility report, design and plan of operation, administration. Land costs are omitted.

^b Items included in closure costs: earthwork, seeding, gas collection.

^c Items included in post-closure costs: monitoring (groundwater, gas, leachate), leachate treatment, site maintenance, liability insurance, seeding, gas collection.

R6. LANDFILL equipment costs

Capital costs of heavy equipment used for landfilling refuse constitute a major cost component for the development of landfills. An indication of the magnitude of this component may be gained from the data presented in Table XIV-12. Because of the costs associated with sanitary landfilling, the acquisition of a sufficient number of the appropriate equipment for the efficient operation of a fill oftentimes is not carried out in developing countries.

Under U.S. conditions, the lifespan of mobile landfill equipment is generally estimated to be about 5 to 10 years.

In an industrialised nation, annual cost of maintaining heavy landfill equipment (lubrication, tire repair, parts, etc.) is estimated as being 15% to 20% of the original capital cost of the equipment. The actual cost in a developing country would depend very strongly upon the age of equipment, type of equipment, and maintenance procedures, as well as on the various factors peculiar to the

country. However, the maintenance cost to capital cost ratios in the two settings probably would be similar.

As with maintenance costs, fuel costs vary with type and condition of the equipment. Obviously, they also depend upon the prices locally charged for the fuel. An indication of fuel consumption may be had from the data reported in References 44 and 89. According to those data, fuel consumption averages about 25 to 45 L fuel/hour.

Table XIV-12. Capital costs of some landfill equipment

Machine Type	Flywheel (kW)	Approx. Wt ^a (Mg)	Approx. Cost ^b (US\$)	Comments
Tracked dozer	< 60	8 to 10	62,000 to 140,000	Standard/landfill blade
	67 to 97	12 to 16	88,000 to 205,000	Standard/landfill blade
	104 to 130	14 to 20	160, to 215,000	Standard blade
	186 to 209	26 to 34	385,000 to 485,000	Landfill blade
Tracked loader	< 68	9 to 11	75,000 to 100,000	GPB: ^c 0.8 m ³
	75 to 97	12 to 16	118,000 to 200,000	GPB: 1.5 m ³
	75 to 97	12 to 16	118,000 to 200,000	MPB: ^d 1.3 m ³
	119 to 142	16 to 22	260,000 to 415,000	GPB: 2.3 m ³
	119 to 142	20 to 24	260,000 to 415,000	MPB: 1.9 m ³
Rubber-tired loader	< 75	7 to 10	110,000	GPB: 1.3 m ³
	< 75	8 to 11	125,000	MPB: 1.1 m ³
	89 to 119	9 to 12	150,000 to 235,000	GPB: 3.0 m ³
	89 to 257	10 to 13	150,000 to 23312,000	MPB: 1.7 m ³
Landfill compactor	141 to 161	< 21	230,000 to 300,000	Landfill blade
	224 to 235	29 to 32	325,000 to 490,000	Landfill blade
	250 to 392	31 to 46	400,000 to 600,000	Landfill blade

Source: Reference 7 and CalRecovery, Inc.

^a Basic machine plus engine sidescreens; radiator guards; reversible fan; roll bar; and either a landfill blade, general-purpose bucket, or multiple-purpose bucket as noted.

^b 2002. The range of costs reflects differences regarding the equipment supplied by the manufacturer and regarding specifications of options supplied, and costs of taxes and import fees.

^c General-purpose bucket.

^d Multiple-purpose bucket.

S. Public participation

S1. INTRODUCTION

Because the environment has such an important bearing on the public's well being, and indiscriminate waste disposal is detrimental to environmental quality, the public usually demands an active role in waste management. Consequently, attention is being given to the adaptation and adoption of public involvement mechanisms and activities. Ideally, therefore, a public

participation program should be established to actively involve citizens in all phases of developing waste management facilities, including site selection, design, operation, completion, and (in the case of landfills) use after closure.

Institutionally, many developing countries are not organised for active public involvement. Nevertheless, it is recommended that the public take part in the development of solid waste management facilities or, at the very least, be kept well informed of the plans. Uninformed groups can disrupt the development of waste management facilities, which can have serious adverse impacts on the overall waste management system.

S2. PRINCIPLES of public participation

An effective way of securing public participation in a landfill project is to secure public favour. Any existing opposition should be dissipated. On the other hand, the removal of opposition by itself is insufficient, since it would merely be replaced by the intermediate stage of indifference or disinterest. Although with regard to a landfill project, indifference or disinterest would mean no opposition, it would also mean no positive input for bringing the project to fruition. It is at this point that motivation and incentive come into play. They constitute the moving force needed for advancing public attitude to a favourable level.

Activities associated with public participation should be conducted under the leadership of a professional who has been trained in public relations and is well versed in conflict resolution.

S3. DISSIPATION of opposition

In this section, the public is divided into three groups, based on their position in the economic hierarchy and the relative influence they have on decision-making regarding public undertakings dealing with solid waste disposal. The three groups are: 1) financially distressed (poor), 2) middle income (intermediate), and 3) financially secure (wealthy).

For convenience of presentation in the discussion that follows, we refer to the first class as “poor”, the second class as “middle”, and the third class as “wealthy”.

S3.1. Poor class

The poor class is primarily concerned with basic survival. Consequently, any perceived threat to survival arouses opposition to the source of that threat.

For individuals whose principal source of income is scavenging, the development of a new landfill is a threat, and hence cause of opposition, if the landfill eliminates or curtails scavenging in any way other than to manage it. The obvious way to remove the threat is twofold:

1. Do not completely prohibit scavenging at the site. Manage it, confine it to a designated area, and impose regulations needed to ensure accident prevention and prevent interference with the efficient operation of the fill.
2. Assure the scavengers that, aside from the regulation needed to protect the safety of the workers and the public at large and to efficiently operate the fill, no steps will be taken to eliminate scavenging.

It may be difficult to dispel the suspicion almost universally held by the public regarding governmental regulations. Suspicion can be dispelled by showing the scavengers the plans and designs, and/or requesting input from their leaders. Word of that assurance can be spread by

word-of-mouth; by way of scavenger associations, contractors, and others in the industry; by way of radio broadcasts, and public (official) announcements; and to some extent, by way of the printed media and “public education” programs.

Since a new site usually is located nearby to the waste generators, marginal lands for habitation by the poor can compete with the landfill. Regardless of the unsuitability of such low-grade land areas, they are the last recourse for living areas for some of the poor. Nevertheless, it may well happen that these populations have to compete for those sites with a landfill undertaking. It is not surprising that a strong opposition against any proposed landfill is aroused in those individuals.

Dispelling such a source of opposition can be a difficult task. An obvious way is to relocate the dispossessed individuals. Another approach to cope with the problem is to design and operate the landfill such that when completed, the site can provide living or recreational space, even though its promised remedy is postponed to a somewhat distant future. “Selling” that remedy to the affected individuals would be a difficult task, despite reliance upon the conventional means of making such an attempt. The best solution is to keep the number of those potentially affected to a minimum. Motivations in the form of sacrifices for the common good, preservation of the public health, patriotism, and similar approaches have little impact among a group for which mere survival is a pressing problem.

S3.2. Middle class

Middle class, as defined in an industrialised country, may either be non-existent or may be a relatively small group in a developing country. In this section, the term “middle class” is used for convenience and is intended to encompass a wide segment that neither fits within the poor class, nor is financially endowed to be categorised as wealthy. Therefore, this category includes individuals and professionals who are at the management and/or decision-making levels of the organisations for which they work. Examples of the organisations are small businesses and most branches of government. Also included in this category are some of the members of the educational system (principally primary and secondary schools), of the health care professions, informed concerned citizens groups, and others.

Reasons for landfill opposition are not as basic as those of the poor or as widespread. The concerns are not considered as basic because they do not concern survival. However, the important concerns relate to loss of living space and its quality-- space that already is extremely scarce. Most of the causes are in the form of perceived threats to: 1) health through contamination of resources and fostering the generation of insect and animal vectors, 2) quality of life, and 3) property values.

The opposition arising from concerns about health and quality of life could be considerable if not entirely eliminated by demonstrating that a properly designed and operated sanitary landfill would not be a threat. However, the fears regarding reduction of living space and lowering of property values would not be as easily allayed. The matter of the reduction of living space could be handled to some extent by way of the same measures prescribed for the poor. Addressing the adverse effects on value of surrounding property would be much more difficult. Of course, the difficulty would be considerably lessened if the proposed fill were to replace an open dump operation or by defining some type of compensation [54]. Compensation does not necessarily have to be financial. Compensation may also be in the form of the building of schools, parks, or community centres.

The best course of action is to publicise the advantages of a sanitary landfill. Because the greater percentage of the middle class is literate, “spreading the word” would be much easier than it

would be among the poor class. The printed media, as well as radio and television, could also be put to use.

S3.3. Wealthy class

Opposition on the part of the wealthy probably would be neither as deep-seated nor as strong as among the other two classes. Moreover, chances of members of this class having any immediate contact with a fill usually would be remote. Any opposition would arise from a concern about deterioration of the quality of water resources in the area, endangerment of the health of the public at large (i.e., beyond the vicinity of the fill), or of lowering of the value of any nearby property that may be owned. Members of this class would dwell in the developed areas of the community in which the quality of the environment would approach that in an industrialised country. Because the cultural (social and attitudinal) characteristics would be comparable to those generally encountered in developed nations, measures taken to attract and engage their participation in a present or proposed sanitary landfill undertaking would also be comparable.

S4. OBJECTIVES of public participation

Although some of these objectives may be difficult to attain in many developing countries, they are included here to guide the more advanced developing countries and to serve as a model for those less developed. Among the objectives of a public participation program for this group and, to some extent, for the middle or intermediate group would be the following:

- The public should have the opportunity to understand official programs and proposed actions, and that the government gives due consideration to the public's concerns.
- Official decisions on important activities should be made in concert with interested and affected segments of the public.
- The public must have every opportunity to participate in the decision-making process. In addition, the public's participation must be stimulated and supported.

All of the objectives presented in the previous list can be accomplished by maintaining open communication between the landfill planners, designers and operators, and the public.

S5. ADVANTAGES associated with public participation

In addition to the advantages mentioned earlier, a well designed public participation program includes the following benefits: 1) provision of useful information to decision-makers; 2) assurance that all issues are fully and carefully considered; and 3) consideration by decision-makers of issues beyond the project, but which nevertheless have an influence on it.

As would be expected, public participation has some disadvantages. Among them are: 1) added cost to the project due to poorly executed public involvement, and 2) potential delays in the project due to public opposition and involvement of additional parties.

None of the disadvantages listed above is sufficient to outweigh the many benefits associated with an effective public participation program. The benefits are such that they facilitate the establishment of an effective decision-making process essential to a publicly-accepted landfill.

S6. PARTICIPANTS

Among the potentially more useful participants would be groups and individuals likely to be directly affected by the landfill. They would be strongly motivated because they would have a personal stake in the success of the project. Other useful participants would be those who have demonstrated a serious interest in environmental affairs. In fact, their participation should be encouraged in the process.

Among the organisations and individuals that should participate in a landfill siting process are the following: 1) members of the public; 2) representatives of consumer, environmental, and minority associations; and 3) representatives of trade, industrial, agricultural, labour, and civic organisations.

Identifying and gaining the support of the public early in the landfill siting process is important to a timely and orderly siting process and can also benefit subsequent solid waste management activities. Participation of all or most of the relevant individuals and organisations can be instituted through a citizens' advisory board. A citizens' advisory board is a critical component of many siting strategies [51].

S7. EXTENT of public input in relation to stage of project development

Although useful at all stages in the development of a sanitary landfill undertaking, public input can be critical at certain stages. For example, the first stage, the planning process, is a critical stage. It is critical because it is the stage in which public input has the greatest potential for shaping the final plan. For that reason it also is the time when involvement should be greatest. As a result of this early input, the public plays a proactive (or constructive) rather than a reactive role in decision-making. Appropriate mechanisms for shaping and applying this input are public hearings, public meetings, and workshops.

The site selection and design stage is the succeeding critical stage [47]. Potential additional approaches of information conveyance in this stage are audio-visual presentations and establishment of task forces for recommending design procedures in areas of particular public concern. Formal public hearings are essential at this time.

A third critical stage is the construction and operation stage. Although usable public input is perforce limited in this stage, the input nevertheless is critical, in that it is a means of monitoring the quality of construction and operation.

S8. CONCLUSIONS

Problems associated with the siting of a landfill (or any other waste processing facility) come about because real costs faced by individuals living near the proposed site have been ignored in the site selection process. If the developers of the landfill ignore perception costs, the developers are inviting dissatisfaction with policies by elements of the affected population. Thus, the siting of the landfill more than likely will be opposed by the population bearing these costs [48].

Experience in the United States and other countries (both industrialised and developing) has shown that individual risk perceptions are altered any time a solid waste facility is sited. This situation may take place even though the siting may decrease the level of potential adverse consequences for the population at large. One possible solution to this situation is the use of host-community benefits (HCBs). Host-community benefits are a well proven technique in siting various types of facilities considered undesirable by the public at large (i.e., large-scale electric generation plants, prisons, and others). The HCBs range from actual financial remuneration (host

fees, tipping fees) to construction of parks, roads, schools, and other facilities that benefit the entire community. The application of HCBs, in essence, internalises the costs on those impacted by the decision [48,52,53].

In addition, if the economic benefit to the community is sufficiently large and the perceived degree of risk associated with the project is low, not-in-my-backyard (NIMBY) opposition is likely to be weak [49]. Compensation, however, should be complemented with non-monetary incentives such as monitoring and shared control [50,54].

T. References

1. Sorg, T.J., H. Lanier Hickman, *Sanitary Landfill Facts*, SW-4ts U.S. Department of Health, Education and Welfare, Public Health Service, National Center for Urban and Industrial Health, Solid Waste Program, Cincinnati, Ohio, USA, 1968.
2. *Sanitary Landfill Planning, Design, and Operation*, Div. General Engineering and Radiological Health, New York State Department of Health, Albany, New York, USA, 1968.
3. Brunner, D.R., D.J. Keller, C.W. Reid, and J. Wheeler, *Sanitary Landfill Guidelines - 1970*, U.S. Department of Health, Education and Welfare, Bureau of Solid Waste Management, 1970.
4. U.S. Environmental Protection Agency, *Design, Construction, and Evaluation of Clay Liners for Hazardous Waste Facilities*, EPA/530-SW-86-007, PB86-184496/AS, NTIS, Springfield, Virginia, USA, 1986.
5. Diaz, L.F. and C.G. Golueke, "Solid Waste Management in Developing Countries", *BioCycle*, July 1987.
6. Diaz, L.F. and C.G. Golueke, "Solid Waste Management in Developing Countries", *BioCycle*, September 1985.
7. Atar, A.M., "Siting a Landfill: The First Step", *World Wastes*, 32(13): 14, December 1989.
8. U.S. Environmental Protection Agency, "Guidelines for the Land Disposal of Solid Wastes", *Federal Register*, 1985.
9. Zepeda, F., et al., *Evaluación de Gases y Lixiviados en los Microrellenos de Lima*, Informe Final, CEPIS, OPS/OMS, Lima, Peru, February 1989.
10. Diaz, L.F., *Findings of Mission to Lima, Peru on Waste Management and Material Recovery*, prepared for Integrated Resource Recovery and Waste Recycling Project, The World Bank, May 1983.
11. Brunner, D.R. and D.J. Keller, *Sanitary Landfill Design and Operation*, U.S. Environmental Protection Agency, Report No. SW-65ts, 1972.
12. Schroeder, P.R., C.M. Lloyd, P.A. Zappi, and N.M. Aziz, *The Hydrologic Evaluation of Landfill Performance (HELP) Model*, U.S. Environmental Protection Agency, EPA/600/R-94/168a, Cincinnati, Ohio, USA, September 1994.
13. Haxo, H.E., et al., *Lining of Waste Impoundment and Disposal Facilities*, SW-870, U.S. Environmental Protection Agency, Cincinnati, Ohio, USA, 1983.

14. Ham, R.K., et al., *Recovery, Processing, and Utilization of Gas from Sanitary Landfills*, EPA-600/2-79-001, U.S. Environmental Protection Agency, Cincinnati, Ohio, USA, 1979.
15. Holmes, J.R., *Practical Waste Management*, John Wiley and Sons, Inc., New York, New York, USA, 1983.
16. Flynn, N.W., M. Guttman, J. Hahn, and J.R. Payne, *Trace Chemical Characterization of Pollutants Occurring in the Production of Landfill Gas from the Shoreline Regional Park Sanitary Landfill, Mountain View, California*, prepared by Science Applications, Inc. for Pacific Gas and Electric Company and U.S. Department of Energy, 1981.
17. Zimmerman, R.E., G.R. Lytynshyn, and M.L. Wilkey, *Landfill Gas Recovery - A Technology Status Report*, NTIS DE84-001194, ANL/CNSV-TM-12, August 1983.
18. Wilkey, M.L., R.E. Zimmerman, and H.R. Isaacson, *Methane from Landfills: Preliminary Assessment Workbook*, Argonne National Laboratory Report ANL/CNSU-31, 1982.
19. Diaz, L.F., G.M. Savage, and C.G. Golueke, *Resource Recovery from Municipal Solid Wastes, Vol. I, Primary Processing*, CRC Press, Boca Raton, Florida, USA, 1982.
20. Hoeks, J., H. Glas, J. Hofkamp, and A. H. Ryhiner, "Bentonite Liners for Isolation of Waste Disposal Sites", *Waste Management & Research*, 5, 1987.
21. Garland, G.A. and D.C. Mosher, "Leachate Effects of Improper Land Disposal", *Waste Age*, March 1975.
22. Shuckrow, A.J., A.P. Pajak, and C.J. Touhill, *Management of Hazardous Waste Leachate*, prepared for Municipal Environment Research Laboratory, Office of Research and Development, U.S. Environmental Protection Agency, Cincinnati, Ohio, USA, (SW-871), September 1980.
23. Lu, J.C.S., B. Eichenberger, and R.J. Stearns, *Production and Management of Leachate from Municipal Landfills: Summary and Assessment*, EPA-600/2-84-092, NTIS PB84-187913, May 1984.
24. Bass, J.M., *Avoiding Failure of Leachate Collection Systems at Hazardous Waste Landfills*, EPA-600/D-84/210, NTIS PB84-235100, August 1984.
25. Noble, G., *Sanitary Landfill Design Handbook*, Technomic Publishing Company, Westport, Connecticut, USA, 1976.
26. U.S. Code of Federal Regulations, Title 40, Chapter 1, Environmental Protection Agency, *Criteria for Municipal Solid Waste Landfills, Part 258*, July, 2003.
27. Conrad, R.B. and E.K. Hoffman, "Transportation Model Applied to Landfill Design", *Journal Environ. Eng. Div. ASCE*, June 1974.
28. Gilman, E.F., F.B. Flower, and L.A. Leone, *Standardized Procedures for Planting Vegetation on Completed Sanitary Landfills*, U.S. Environmental Protection Agency, Cincinnati, Ohio, USA, EPA-600/2-83-055, NTIS PB83-241-018, 1983.
29. Northeim, C.M., et al., *Handbook for the Design, Construction, and Operation of Sanitary Landfills*, U.S. Environmental Protection Agency, 68-02-3992-1/040, 1987.

30. Keller, E.A., *Environmental Geology*, second edition, Merrill Publishing Company, 1979.
31. Diaz, L.F., G.M. Savage, and C.G. Golueke, *Resource Recovery from Solid Waste, Vol. II, Final Processing*, CRC Press, Inc., Boca Raton, Florida, USA, 1982.
32. Cheney, A.C., "Settlement of Landfill", *Harwell Landfill Completion Symposium*, Cockcroft Hall, HMSO, London, England, May 1983.
33. Barber, C. and P.J. Maris, "Recirculation of Leachate as a Landfill Management Option", Water Research Center, Stevenage Laboratory, United Kingdom, 1983.
34. CEPIS/PAHO/WHO, *Cost of Urban Cleaning Services*.
35. Emberton, J.R. and A. Parker, "The Problems Associated with Building on Landfill Sites", *Waste Management & Research*, 5(4):473-482, December 1987.
36. *Swamp Reclamation in Tropical Monsoon Regions by Appropriate Refuse Landfillings: Case Study Evaluations in Thailand*, SEATEC International, The World Bank, Washington, DC, USA, 1983.
37. *Study of Landfill and Resource Recovery in Metropolitan Colombo*, Draft Final Report, prepared for The World Bank by Environmental Resources Limited, June 1987.
38. Stearns, R.P. and G.S. Petroyan, "Identifying and Controlling Landfill Fires", *Waste Management & Research*, 2:75-83, 1984.
39. Joyce, L.E., "How to Calculate Waste Disposal Costs", *World Wastes*, March 1989.
40. Glebs, R.T., "Landfill Costs Continue to Rise", *Waste Age*, 19(3), March 1988.
41. Walsh, J., "More on Sanitary Landfill Costs", *Waste Age*, 21(4), April 1990.
42. Glebs, R.T. and T. Juszczuk, "Closure and Post Closure Costs", *Waste Age*, 21(3), March 1990.
43. Hudson, J.F. and P.L. Deese, *Optional Cost Models for Landfill Disposal of Municipal Wastes*, prepared for U.S. Environmental Protection Agency, Cincinnati, Ohio, USA, March 1985.
44. Wilson, D.C., *Waste Management Planning, Evaluation, Technologies*, Clarendon Press, Oxford, England, 1981.
45. U.S. Environmental Protection Agency, *Landfill Bioreactor Design and Operation*, Seminar Publication, EPA/600/R-95/146, September 1995.
46. Gendelebien, A., et al., *Landfill Gas-From Environment to Energy*, Commission of the European Communities, Brussels, Luxembourg, 1992.
47. Star, A.M., "Siting a Landfill: The First Step", *World Wastes*, 32(13):14-20, December 1989.
48. Fort, R. and L. Scarlett, "Too Little Too Late? - Host Community Benefits and Siting Solid Waste Facilities", Policy Study No. 157, Reason Foundation, April 1993.

49. Rasmussen, T.H., "Not in My Backyard: The Politics of Siting Prisons, Landfills, and Incinerators", presented at the Annual Meeting of the American Political Science Association, San Francisco, California, USA, August/September 1990.
50. Leroy, D.H. and T.S. Nadler, "Negotiate Way Out of Siting Dilemmas", *Forum for Applied Research and Public Policy*, Spring 1993.
51. Gibbs, L.M. and B. Lipsett, "The Siting Game: A NIMBY Primer", *Forum for Applied Research and Public Policy*, Spring 1993.
52. Petts, J., "Incineration Risk Perceptions and Public Concern: Experience in the U.K. Improving Risk Communication", *Waste Management & Research*, 10:169-182, 1992.
53. Petts, J., "Effective Waste Management: Understanding and Dealing with Public Concerns", *Waste Management & Research*, 12:207-222, 1994.
54. Debaie, M., "Keeping the Country in Countryside", *Waste Age*, March 1995.
55. Tabasaran, O., "Gas Production from Landfill", *Household Waste Management in Europe -- Economics and Techniques*, A. Bridgwater and K. Lidgren, eds. Van Nonstrand Reinhold, undated.
56. Gomes, I.C., "Gas de aterro, a energia recuperada do lixo", *Energia, Fontes Alternativas*, São Paulo, Brazil, II(10), 1980.
57. Cantanhede, A.L.G., F.A. Sá, and J. Chlebnicek, *Aterro experimental do lixo, documento final*, X Congresso Brasileiro de Engenharia Sanitária e Ambiental, Manaus, Brazil, 1979.
58. Leci, C.L., "Landfill Gas as a "Town Gas" Extender, - The Santiago, Chile Experience", *Landfill Gas and Anaerobic Digestion of Solid Waste*, Y.R. Alston and G.E. Richards, eds., Proceedings of a Conference, Cherster, United Kingdom, 1989.
59. Galvez, F., G. Fernandez, and V. Casas-Corderos, "Santiago, Chile Builds Recovery System", *Management World Wastes*, 27(6), 1984.
60. Barlaz, M.A., *Microbiological and Chemical Dynamics During Refuse Decomposition in a Simulated Sanitary Landfill*, Ph.D. Dissertation, Department of Civil and Environmental Engineering, University of Wisconsin at Madison, Wisconsin, USA, 1988.
61. Barlaz, M.A., *Factors Affecting Refuse Decomposition in Sanitary Landfills*, M.S. Thesis, Department of Civil and Environmental Engineering, University of Wisconsin at Madison, Wisconsin, USA, 1985.
62. Barlaz, M.A., R.K. Ham, and D.M. Schaefer, "Mass Balance Analysis of Decomposed Refuse in Laboratory Scale Lysimeters", *ASCE Environmental Engineering*, 115(6):1088-1102, 1989.
63. Jenkins, R.L. and J.A. Pettus, *Biotechnological Advances in Processing Municipal Wastes for Fuels and Chemicals*, A.A. Antonopoulos, ed. Argonne National Laboratories, Report ANL/CNSV-TM-167, 1985.
64. Pohland, F.G., *Sanitary Landfill Stabilization with Leachate Recycle and Residual Treatment*, U.S. Environmental Protection Agency, Municipal Environmental Research Laboratory, Cincinnati, Ohio, USA, EPA-600/2-75-043, 1986.

65. CalRecovery, Inc., unpublished analyses, 1996.
66. Diaz, L.F. and G.M. Savage, "Proposed Guidelines for Siting and Designing Sanitary Landfills in Developing Countries", presented at XXV Interamerican Congress Sanitary Engineering and Environmental Sciences (AIDIS), Mexico City, Mexico, November 1996.
67. Hungate, R.E., "Studies on Cellulose Fermentation - I. The Culture and Physiology of an Anaerobic Cellulose Digesting Bacterium", *Journal of Bacteriology*, 48:499-513, 1944.
68. Hungate, R.E., "The Anaerobic Mesophilic Cellulytic Bacteria", *Bacteriological Review*, 14:1-49, 1950.
69. Hungate, R.E., "Microorganisms in the Rumen of Cattle Fed a Constant Ration", *Canadian Journal of Microbiology*, 3:289-311, 1957.
70. Madden, R.H., M.J. Bryder, and N.J. Poole, "Isolation and Characterization of an Anaerobic Cellulytic Bacterium, *Clostridium papyrosolvens* sp. nov.", *International Journal of Systematic Bacteriology*, 32:87-91, 1982.
71. Madden R.H., "Isolation and Characterization of *Clostridium stercorarium* sp. nov. Cellulitic Thermophile", *International Journal of Systematic Bacteriology*, 33:837-840, 1983.
72. Mendez, B.S., M.J. Pettinari, S.E. Ivanier, C.A. Ramos, and F. Sineriz, "*Clostridium thermopapyrolyticum* sp nov., a Cellulolytic Thermophile", *International Journal of Systematic Bacteriology*, 41:281-283, 1991.
73. Zeikus, J.G., "Microbial Populations in Digesters", *Anaerobic Digestion*, D.A. Stafford, B.I. Wheatley, and D.E. Hughes (ed), pp. 61-89, Applied Science Publishers, London, England, 1980.
74. Kaseng, K., K. Ibrahim, S.V. Paneerselvam, and R.S. Hassan, "Extracellular Enzymes and Acidogen Profiles of a Laboratory-Scale Two-Phase Anaerobic Digestion System", *Process Biochem.*, 27:43-47, 1992.
75. Bowerman, F.R., N.K. Rohatgi, K.Y. Chen, and R.A. Lockwood, *A Case Study of the Los Angeles County Palos Verde Landfill Gas Development Project*, EPA-600/3-77-047, Municipal Environmental Research Laboratory, U.S. Environmental Protection Agency, Cincinnati, Ohio, USA, July 1977.
76. Hekimian, K.K., W.J. Lockman, and J.H. Hest, "Methane Gas Recovery from Sanitary Landfills", *Waste Age*, 7(12):2, December 1976.
77. Jewaskiewitz, S.M., "The Rehabilitation of the New England Road Landfill Site in Pietermaritzburg, Natal: A Case Study", *Proceedings of the WASTECON '94, All Africa Congress*, Institute of Waste Management, Somerset West, South Africa, September 1994.
78. Christensen, T.H., R. Cossu, and R. Stegmann, eds. *Sanitary Landfilling: Process Technology and Environmental Impact*, Academic Press, London, England, 1989.
79. Ettala, M. "Infiltration and Hydraulic Conductivity at a Sanitary Landfill", *Aqua Fennica*, 17(2), 1987.

80. Ehrig, H.-J. and T Scheelhaase, "Pollution Potential and Long Term Behaviour of Sanitary Landfills", *SARDINIA 93 Fourth International Landfill Symposium Proceedings, Vol. II*, Cagliari, Sardinia, Italy, pp. 1203-1225, October 1993.
81. Straub, W.M., et al., "Performance of Field Scale Flushing Bioreactor Landfill Test Cells – Six Years On", *SARDINIA 2001 Eighth International Waste Management and Landfill Symposium Proceedings, Vol. I, The Sustainable Landfill*, Cagliari, Sardinia, Italy, pp. 309-317, October 2001.
82. Binder, M. and T. Bramryd, "Influence of Optimization on Bioreactor Landfill Performance", *SARDINIA 2001 Eighth International Waste Management and Landfill Symposium Proceedings, Vol. I, The Sustainable Landfill*, Cagliari, Sardinia, Italy, pp. 21-30, October 2001.
83. Croft, B., et al., "The Brogborough Test Cells: Conclusions from a 14-Year Field-Scale Landfill Gas Experiment", *SARDINIA 2001 Eighth International Waste Management and Landfill Symposium Proceedings, Vol. I, The Sustainable Landfill*, Cagliari, Sardinia, Italy, pp. 3-12, October 2001.
84. Kruempelbeck, I. and H.-J. Ehrig, "Long-Term Behaviour of Municipal Solid Waste Landfills in Germany", *SARDINIA 99 Seventh Waste Management and Landfill Symposium Proceedings, Vol. I, Landfill Processes and Waste Pre-Treatment*, Cagliari, Sardinia, Italy, pp. 27-36, October 1999.
85. Mazzetti, G.P., et al., "Consolidation of a Landslide of Waste with a Reinforced Embankment", *SARDINIA 2001 Eighth International Waste Management and Landfill Symposium Proceedings, Vol. III, Barriers, Waste Mechanics and Groundwater Pollution*, Cagliari, Sardinia, Italy, pp. 561-566, October 2001.
86. Mitchell, J.K., "Geotechnics of Soil-Waste Material Interactions", *2nd International Congress Environmental Geotechnics*, Osaka, Japan, Balkema, 3:1311-1328, 1996.
87. Kavazanjian, E., "Mechanical Properties of Municipal Solid Waste", *SARDINIA 2001 Eighth International Waste Management and Landfill Symposium Proceedings, Vol. III, Barriers, Waste Mechanics and Groundwater Pollution*, Cagliari, Sardinia, Italy, pp. 415-424, October 2001.
88. Eid, H.T., et al., "Municipal Solid Waste Slope Failure: Waste and Foundation Soil Properties", *Journal of Geotechnical and Geoenvironmental Engineering*, ASCE, 126(5):397-407, 2000.
89. *Caterpillar Performance Handbook*, Caterpillar, Inc., Peoria, IL, USA, October 1995.
90. Stearns, R.P. and G.S. Petoyan, "Identifying and Controlling Landfill Fires", *Waste Management & Research*, 2:303-309, 1984.

Part IV

Key Non-Technical Considerations

CHAPTER XV. REGULATORY AND ECONOMIC INSTRUMENTS FOR SOLID WASTE MANAGEMENT

A. Introduction

This section presents an overview of major strategies and policy methodologies employed in solid waste management in developing countries and in industrialised nations. The strategies and policies of concern are those that are designed to facilitate the control of pollution, especially those related to the improvement of solid waste management. Although the examples presented in this section deal with experience gained in industrialised countries, the message conveyed is applicable to developing countries with very minor modifications.

In industrialised countries, the strategy for protecting and enhancing the quality of the environment calls for direct regulation, reinforced by the “command-and-control” approach. In essence, the approach consists of the implementation of systems for monitoring and for the enforcement of the regulations. Usually, the implementation of the approach is by way of the application of regulatory instruments such as standards, permits, and licenses, and the control of land and water use. The approach more or less affords the regulators some degree of predictability regarding the achievable pollution reduction. Despite allegations regarding economic inefficiency and difficulty of enforcement, command-and-control strategies have been of significant assistance in the fulfilment of objectives of environmental policies.

In an attempt to endow control measures with increased flexibility, efficiency, and cost effectiveness, in some instances, industrialised countries are resorting to a mechanism that is based on economic motivation, i.e., economic incentive. The incentive is the empowerment of potential polluters to select the particular means of control that is economically favourable to the potential polluter. The rationale for the innovation is the assumption that if properly implemented, reliance upon economic incentives is attended by several advantages. Among the postulated advantages are the following:

1. promote the use of cost-effective means for achieving acceptable levels of pollution control;
2. encourage the development of pollution control expertise and technologies in the private sector;
3. provide a source of revenue to be applied by the government to pollution control programs; and
4. lighten the burden that otherwise would be placed upon the government with regard to the collection and analysis of the extensive data involved in determining the feasible and appropriate level of control for each and every facility or product.

Supposedly, the need for governmental involvement and regulation can be materially reduced through recourse to economic instruments, because those functions would be accomplished by the economic instruments according to market mechanisms. The reality is that, in practice, the need for conventional monitoring and enforcement, and other forms of direct government involvement, has not been materially lessened by economic instruments.

Thus far, applications of economic incentives have been quite limited and, as yet, there is no instance of a significant improvement in environmental quality that can be credited to economic incentives. Hesitancy to rely upon economic incentives is largely due to uncertainty regarding

ramifications and possible undesirable outcomes. Moreover, implementing a suitable application is a difficult and complex undertaking. Finally, economic instruments could be used to complement direct regulation.

B. Responsibility for regulatory and economic instruments

Nearly every governmental and non-governmental agency becomes involved in or is affected by ramifications traceable to the selection of regulatory and economic instruments designed to fulfil pollution control and waste management objectives. The responsible level of government, the type of institution, and the mechanisms for enforcement are determined by the nature of the selected instrument. Usually, agencies at the national government level are entrusted with instruments that involve activities characterised by a very high degree of political consensus, maximum complexity, and risk. On the other hand, responsibility for instruments concerned with natural resources shared by two or more municipalities generally is given to state and local agencies. Policy instruments that deal with wastewater collection and treatment, drainage control, air pollution from both mobile and fixed sources, solid waste management, and groundwater contamination generally are consigned to the local government level. At times, authorities managing a particular watershed, waste generation area, or air basin may be given responsibility for pollution control. Occasionally, non-governmental agencies strongly influence the development and enforcement of pollution control regulations.

B1. NECESSARY conditions

The authority of the agency assigned the responsibility for implementing pollution control or waste management policies must be clearly delineated. It follows that the selected agency be endowed with the expertise, human resources, equipment, and financial resources needed to carry out the policies. In many developing countries, doing this with respect to waste management, pollution control, and enforcement would involve a substantial strengthening of human and financial resources and of organisational structure. Frequently, it even may happen that a new environmental agency or environmental unit must be established.

Available reports of evaluations of the application of regulatory and economic instruments in developing countries are few in number. Reports that are available mostly deal with information on the existence or non-existence of standards or other regulatory or economic instruments. They focus attention on the weakness of current institutions and personnel regarding monitoring and enforcement activities. The literature contains few citations regarding the successful application of regulatory and economic instruments to environmental management.

In a developing country, the basic challenge regarding the makeup of environmental programs is to decide upon an appropriate combination of instruments. Among the factors to be considered are social, political, economic, and environmental issues. Accordingly, considerations that should be taken into account in the planning of environmental strategies and the selection of policy instruments should include the following: 1) the successful application of economic instruments pre-supposes appropriate standards, accompanied by adequate monitoring and enforcement capabilities; and 2) even with the establishment of effective monitoring and enforcement capabilities, it is unlikely that economic instruments will replace traditional regulatory instruments. Nevertheless, if adequate enforcement mechanisms are in force, a highly effective approach to the attainment of waste management objectives is the imposition of direct charges.

B2. NEEDED research

Additional research on environmental management strategies is needed. In-depth studies should be centred on the evaluation of the effectiveness of various regulatory and economic instruments

as, for example, practical aspects of initiating and operating an economic instrument and the circumstances essential to the success of the application. The scope of the study should be broad enough to include: 1) combinations of the most appropriate instruments, 2) approaches that take cross-media pollution effects into consideration, and 3) suitable minimum standards. Finally, research should be directed to the identification and establishment of monitoring and enforcement capabilities that would be appropriate in a developing country setting.

C. Useful regulatory and economic mechanisms

C1. REGULATORY mechanisms

C1.1. Standards

Most current standards were designed for and are used in industrialised countries. The development of standards is, as yet, in the early stages in non-industrialised countries. This disparity rapidly disappears during the transition from the developmental status to the industrialised status. Hence, the following presentation on standards deals mostly with those currently in vogue in industrialised countries. The variety of the standards in industrialised countries encompasses all phases of solid waste management. Thus, standards exist that are specific for each type of solid waste management activity (e.g., storage, collection, recycling, final disposition).

The rationale and the consequent objectives of all standards are: 1) protection of the public and of solid waste management workers, and 2) the maintenance and improvement of the quality of the environment. The scope of the standards includes all applicable technical and operational requirements. Additionally, the scope extends to all management, operation, and maintenance aspects of solid waste facilities. More recently, the scope of some standards has been expanded to involve waste minimisation, recycling, and resource recovery.

C1.1.1. Storage and collection

Technical and operational standards pertinent to storage and collection specify types and sizes of storage containers, locations for the containers, frequency of collection, and the amount and types of wastes to be collected. If the traditional manual mode of collection is replaced by the “automatic” or “semi-automatic” mode, the design of storage receptacles and the placement of the receptacles on the day of collection must be altered accordingly. Other applicable standards include specifications regarding the collection vehicle and the collection schedule. Standards pertaining to noise abatement during collection include noises associated with the collection vehicle and its operation. Examples are activation of the compaction mechanism and engine exhaust noise. A less frequently encountered specification is to the extent that the collection vehicle be covered, excepting during the loading and unloading operations. Another regulation calls for computerised air braking systems for trucks equipped with air brakes.

C1.1.2. Waste minimisation

A current trend is the reliance upon governmental regulation, legislation, and mandate as mechanisms for minimising the amount of waste destined for final disposal. The trend is prompted, in large part, by the rapid dwindling of available landfill capacity and, to a lesser extent, by an awareness of the need for resource conservation. Governments conserve the landfill capacity resource by specifying types and amounts of waste that are permitted to be landfilled [1,7]. Resource conservation is promoted through resource recycling and reuse, encouraged by way of government-backed incentives.

Regulatory measures related to storage and collection and intended for the promotion of recycling and reuse usually call for kerbside placement of storage receptacles on the day of collection. The measures also specify the number of containers and the types of materials that are placed in each container. The simplest configuration calls for two containers; one for recyclables and one for non-recyclables. Each of the other configurations has the following general arrangement: one container for non-recyclables and one container each for the separated components (e.g., ferrous metals, paper, glass, etc.).

One of the numerous strategies geared to resource conservation involves regulating the use of certain materials or energy resources such that the recovery of materials from the waste stream is facilitated. Applied in that manner, regulations can be designed to control and possibly prevent the use of certain materials, or discourage the use of a particular production method or treatment.

Governments may provide an incentive to recycle and reuse by way of requiring manufacturers and importers to use recycled materials. By so doing, the government advances the development of a market for recyclable materials and simultaneously may alleviate shortages of a particular material. However, application of these measures should be preceded by discussions with affected industries, and preferably with their cooperation.

C1.1.3. Final disposal regulations

All aspects pertinent to the final disposal of wastes are subject to regulatory control. Thus, a collection of technical and operational standards are in force that affect the siting, design, construction, operation, closure, and post-closure of solid waste disposal facilities. In the United States, these standards are covered in the Resource Conservation and Recovery Act (RCRA). RCRA exemplifies a regulatory course of action that, with suitable adaptation, can be successfully applied in most industrialised nations, as well as in developing countries. In other words, it is a useful model. A major feature of RCRA is its banning of the open dump -- open dumps must either be closed or be upgraded to the sanitary landfill level. In keeping with this directive, RCRA specifies a set of standards for sanitary landfills. Among the standards are some that affect the location of a landfill facility. Another standard calls for the installation of a leak detection system if the need for such a system exists. Other directives mandate the monitoring of groundwater, and the initiation of corrective action to remedy shortcomings that are revealed. Finally, RCRA gives legal standing to regulations that ban certain waste management practices and forbid the siting of certain types of facilities in sensitive environments.

In some countries in Europe, land disposal of solid waste is subject to the Landfill Directive of the European Union [7]. The directive sets forth the conditions under which solid waste can be disposed in landfills, including the biodegradable organic content of the waste, the maximum percentage of biodegradable waste that can be landfilled over the period 2006 to 2020, and other requirements.

C1.1.4. Permits and licenses

Safe processing, transfer, and disposal practices in solid waste management can be assured by way of the issuance of permits and licenses to the owners and operators of solid waste management enterprises. In industrialised countries, the permits and licenses address both design and operation of the solid waste facilities, and typically specify and are conditioned upon peak processing capacity; operating schedule; required controls of solid, gas, and liquid emissions from the facilities; as well as other requirements.

C1.1.5. Management programs

This aspect of solid waste management policy deals with the management plan or program that should be developed by solid waste management jurisdictions. Thus, each jurisdiction should be obligated to: 1) prepare a program for the storage, collection, treatment, and disposal of all household, commercial, and industrial waste expected to be generated within its confines; and 2) periodically update the program.

Examples of management programs include the following:

- Each province in the Netherlands is required to develop a solid waste management program that states the manner, location, and by whom wastes are to be deposited, treated, or recycled.
- In the United Kingdom, items covered in a program are: information on types and amount of waste expected to be generated or to be brought into the jurisdiction during the program, type of waste the authority will process, types of waste others are expected to process, method of disposal, sites and equipment being provided, and cost. Other programs may extend to measures for waste reduction and recycling.
- The French Environmental Protection Law passed in July of 1992 requires the development of departmental and regional plans for the management and disposal of waste [1].

C2. ECONOMIC mechanisms

An excellent stratagem for funding solid waste management systems is the imposition of fees or charges, the use of a deposit system, or the implementation of a subsidy program.

C2.1. Charges (fees)

Charges that may be levied to defray solid waste collection and disposal costs can be grouped into three categories -- user, disposal, and product.

C2.1.1. User charges

Charges in this category are those that are levied to defray costs associated with collection and treatment. Only rarely are they inflated sufficiently to serve as incentives. On the contrary, charges are assessed on the basis of total expenditures and ignore marginal social costs due to negative impact upon the quality of the environment.

Assessment of user fees can be modified such that they act as incentives to reduce the rate and amount of waste generation. The utility of such an approach is attested to by the extent of the reduction in waste generation that resulted from the implementation of a variable garbage can fee system in the State of Washington (Seattle) and in the State of California (San Jose and San Francisco), and the pay-per-bag systems in New Jersey, Pennsylvania, and Illinois. Experience in the United States demonstrates that combining programs for recycling newspaper and containers (glass, plastic, and metals) with the variable fee system markedly enhances the effectiveness of the latter in reducing the quantity of solid waste destined for collection or final disposal. However, attention must be paid to properly integrate the collection, processing, and disposal systems, structure the fees, and educate the public.

C2.1.2. Disposal charges

One of the typical forms of disposal charges is the “tipping fee”. The tipping fee is the charge levied at the disposal site. The amount of the tipping fee usually is a function of the weight of the waste to be disposed. For certain types of waste, the fee may be a function of volume. The magnitude of the charge also may depend upon the type of waste and the method of treatment prior to final disposal. In many cases, the landfill tipping fee for residues from composting facilities is lower than that for untreated waste. A charge is levied in Denmark on solid waste from households and industry; the charge is intended to serve as an incentive to recycle. In the United States, final disposition of certain troublesome wastes (e.g., tires, vehicle batteries, and used oil) may incur special charges. Another stratagem is the imposition of disposal surcharges to cover closure costs, or to finance pollution monitoring and control and/or resource recovery activities [2].

C2.1.3. Product charges

The rationale for product charges is largely anticipatory in nature in that they deal with future consequences rather than past or current consequences. As such, the rationale may be motivational, compensatory, or punitive.

The rationale is motivational when the fee is imposed to promote protection of public health and quality of the environment or to encourage conservation of resources.

The rationale becomes compensatory if the fees are designed to compensate for the loss that would attend the eventual disappearance of an essential resource. It also is compensatory if the imposed fees are to account for disposal cost over and above that of other wastes. In practice, product charges finance parts of the policy measure originally developed to deal with the negative environmental effects of the products on which the charges were imposed. The consumption of products will continue unless charge levels are raised considerably or regulations become more stringent.

The rationale assumes a punitive quality when the motivational and compensatory aspects fail to be effective or are not pertinent. Regarding the effectiveness of product charges or fees designed to serve a regulatory function, the general experience is that they have little impact in terms of incentive.

Among the categories of waste that have been and are being subjected to product fees are non-returnable containers, lubricant oils, plastic bags, automobile batteries, and fuels. The category of non-returnable beverage containers has been the major object of product fees. Usually, the collected fees are primarily used to finance the deposit-refund systems for containers (e.g., Finland and some states in the United States).

C2.2. Deposit systems

The utility of the deposit strategy as a regulatory device has been amply demonstrated. Traditionally, the deposit stratagem involved two steps: Step 1 is the imposition of special taxes, charges, or fees on certain consumer items (usually, returnable beverage containers). Step 2 is the recovery of the special fees, etc. by the purchaser when he or she returns the container for reuse or disposal. However, the scope of the strategy has been broadened considerably such that it currently includes not only containers but also several other types of items. The objectives of the deposit fee are the encouragement of recycling and the prevention of pollution.

Returnable beverage containers continue to be the items most frequently concerned. Thus, in the United States, several states mandate the application of deposit-refund systems to carbonated beverage containers (soft drinks and beer). These states report that of the total number of containers affected by the system, 80% to 95% are returned for recycling [6]. Apparently, the monetary incentive (US\$0.05 to US\$0.10 refund/container) is sufficient to induce the desired compliance. The application of the deposit-refund system is not confined to the United States. Deposit-refund systems have been very successful in Finland, in that about 90% of the containers are returned. Doubling the deposit charged for aluminium beer cans increased the quantity of cans returned from 70% to more than 80% in Sweden [3].

The deposit-refund concept has been expanded to include items other than reusable beverage containers. Suitably modified deposit-refund systems are being successfully applied to the recycling of automobiles and automobile batteries. For example, a deposit-refund system applicable to hulks of cars and vans was mandated in Norway in 1978. Under the system, the refundable fraction of the deposit is larger if the discarded hulk is returned to an officially designated site. The return rate in the mid-1990s was greater than 90%. Revenues are used for refunds and for financial assistance for collection, transportation, and dismantling facilities.

Mandatory deposit systems for automobile batteries have been implemented in some states in the United States (e.g., California). In these states, every battery sold or offered for sale must have a deposit paid at the time of sale. The deposit is waived or returned if a used automotive battery is brought to the store.

Experience tends to indicate that deposit-refund systems work well, and apparently are more effective than voluntary return systems. A probable reason is that deposit-refund systems provide a tangible reward for performance. Deposit-refund systems are efficient in terms of administration, in that monitoring or other involvement by authorities is usually not required.

Most industrialised countries have in effect some form of deposit-refund system applied to glass beverage containers.

In terms of the efficiency of deposit-refund systems, there is a lack of quantitative assessments in which the costs of deposit-refund systems are compared to the costs of alternatives that have an equally beneficial environmental impact. Nonetheless, it can be assumed that, in some cases, the costs of household waste collection, transport, and incineration or dumping exceed the costs of the deposit-refund system [3].

C2.3. Subsidies

Very frequently, subsidies can be used to advantage in most phases of solid waste management. At one time in the United States, federal grants were made to states to subsidise the development and implementation of solid waste management plans, resource conservation, and resource recovery. Currently, some grants are available for training, research, and demonstration projects for energy and materials recovery, and for solid waste disposal planning.

In Denmark, subsidies for the development or installation of technologies that produce less waste or reuse waste materials are authorised by an amendment to the Act on the Re-use and the Reduction of Waste (1974). The Waste Disposal and Treatment Law enacted by Japan stipulates that the state subsidise: 1) various categories of local expenditures in accordance with policy provisions, 2) necessary expenditures for maintenance and repair of refuse disposal facilities, and 3) expenditures for the disposal of wastes caused by natural hazards or other factors. The Ministry of Environment in Finland subsidises the reduction of interest on loans made for the purpose of financing waste recycling investments.

Subsidisation can be in the form of preferential tax treatment on bonds issued by state (provincial) and local governments for the construction of pollution control facilities or the development of plants capable of incinerating municipal solid waste for the generation of steam or electrical power. In the United States, earnings on municipal bonds issued for that purpose presently are exempt from payment of federal and state income tax. Preferential tax treatment may be used to encourage industry to practice resource recovery. This approach has been used periodically in the United States and in Poland [4]. Other incentives include tax credits to industries that use recycled materials as part of their feedstock.

The market for recyclable materials can be stabilised through: 1) price supports for the establishment of materials banks; 2) the guarantee of an income from a recycling plant or facility (e.g., tipping fees or quantity of incoming material above a defined minimum level); and 3) the institution of investment grants, accelerated depreciation, and soft loans designed to encourage private enterprises to implement resource recovery activities [5]. The guaranteed income may be in the form of tipping fees, or of a guaranteed quantity of incoming material.

D. References

1. Valentis, G., F. Weber, and T. Gosset, "Implications of French Policy of Waste Management on Landfilling Practices", *Proceedings, 25th ISWA Congress*, Vienna, Austria, 1995.
2. Royal Commission on Environmental Pollution, *Managing Waste: The Duty of Care*, Her Majesty's Stationary Office, London, England, 1985.
3. Organization for Economic Cooperation and Development, *Economic Instruments for Environmental Protection*, Paris, France, 1989.
4. Wilczynski, P., "Environmental Management in Centrally-Planned Non-market Economies of Eastern Europe", Environmental Working Paper No. 35, The World Bank, Washington, DC, USA, 1990.
5. Bartone, C.R., "Economic and Policy Issues in Resource Recovery from Municipal Solid Wastes", *Resources, Conservation and Recycling*, (4), 1990.
6. Moore, J., et al., "Using Incentives for Environmental Protection: An Overview", Library of Congress, Washington, DC, USA, 1989.
7. European Council, "Council Directive 1999/31/EC of 26 April 1999 on the landfilling of waste", *Official Journal of the European Communities*, L 182, 1-13, 1999.

CHAPTER XVI. FINANCIAL ARRANGEMENTS FOR SOLID WASTE MANAGEMENT

A. Introduction

As previously indicated, in most developing countries local governments have the primary responsibility to provide solid waste management services. Local governments must rely on a variety of financial resources to fund the services. In most cases, different resources are used to finance capital investments than to finance operating and maintenance costs. Furthermore, a mixture of resources may be used for financing of the various components of a waste management system (i.e., collection, transfer, resource recovery, and final disposition).

In this chapter, the various methods of financing solid waste management services are discussed. Issues pertinent to economically developing countries, such as financing services to low-income or marginal areas, are presented. For low-income areas, reducing the need for government financing through encouragement of greater self-reliance and community participation also is discussed.

The option of privatising solid waste management services, as a means of obtaining capital and implementing user charges for the services, also is discussed. In addition, key issues associated with municipal strengthening, as well as costs associated with publicly-owned versus privatised service, are presented.

B. Financing capital investment costs

In this section, four methods of financing capital investments are discussed: reserves, bonds, loans/grants, and donations [9-11].

B1. RESERVES

In this particular case, the solid waste agency receives and saves a portion of current revenues for the sole purpose of financing capital investments. Reserves also are known as renewal funds and usually are used for investments in equipment replacement or to extend the service capacity of existing equipment [1].

B2. BONDS

Another way to obtain financing for capital investments is to raise funds from private investors through the issuance of bonds [1].

Public ownership of a solid waste management system or facility generally results in one of three financing methods: general obligation (GO) bonds, revenue bonds, or lease revenue bonds. In each option, the community issues tax-exempt debt and guarantees repayment of the debt with credit of either the community or the project's revenues combined with any other guarantee or insurance.

B2.1. General obligation bonds

This type of financing utilises the credit of the community as the credit pledge. Principal and interest payments for GO bonds can either be made from tax revenues or from the project's revenues.

B2.2. Revenue bonds

This type of bond is repaid from the revenues generated by the project or system. The bonds are secured by legal documents specifying the responsibilities of each participant, as well as the flow of funds. Revenue bonds were popular in the United States for financing waste-to-energy facilities, where revenues were obtained through tipping fees and sales of energy. If the bonds for a facility of this type are secured only by the project's revenues, they will command a higher interest rate.

B2.3. Lease revenue bonds

In this type of financing, a public entity or a specially formed non-profit corporation issues tax-exempt revenue bonds to finance a waste management facility. The facility is then leased to the municipality. Security for the bonds is provided by the lease between the two entities.

In situations when projected revenues for a particular project are too limited or the risks are too high, it may be in the government's best interest to provide financial incentives to the private sector to encourage participation in new business development. When the government provides financial incentives, it either provides financing directly to the private sector or sacrifices potential tax revenues from the private sector. Tax exempt bonds are one example of a government financial incentive that leads to a potential loss in tax revenues.

B3. LOANS/grants

Ideally, most capital investments should be financed through the use of reserves. Nevertheless, in order to finance major capital investments, municipalities may resort to borrowings. Borrowings derive from loans with commercial banks, international development banks, and central government banks.

In some countries, capital expenditure by local governments is controlled by the central government. Each year, the central government sets a limit on the total capital expenditure that can be made. Projects are submitted to the pertinent agency of the central government for approval. Once approved, the local government can borrow either from a public agency or from the money market.

Several international lending institutions have been involved in financing solid waste management investments in economically developing countries. Some of the most active institutions include The World Bank, the Asian Development Bank (ADB), and the Inter-American Development Bank (IDB). The financings have covered replacement and expansion of the solid waste collection fleets, construction of transfer stations and purchase of transfer trucks, design and construction of sanitary landfills and purchase of landfill equipment, development of composting facilities, and others. The majority of the financings of solid waste management projects have been included as part of development bank loans for large urban development projects.

Borrowings for major solid waste management investments may be financed through the project or through general obligation financing. In project financing, the financial viability of the project is compared with the revenues that the project is expected to generate. In general obligation financing, the credit of the local government secures the loan. For both types of financing, if future revenues are in doubt, it may be necessary for the central government to secure the loan. Most loans for solid waste investments are project financing.

It is possible to finance some costs that would commonly be considered recurrent operating costs within arrangements to finance capital investments. For instance, capital investment in solid waste equipment could include the acquisition of a large supply of parts that are used frequently. Loans from development banks commonly make allowances for purchasing spare parts within the equipment procurement that they finance. This is part of a policy to ensure that the equipment financed can be successfully utilised to provide service and, thus, improve the revenue generation of the service entity.

In most developing countries, the central government will more than likely continue to be the principal source of funding for major projects in solid waste management.

B4. DONATIONS

Municipalities in developing countries often have access to a variety of organisations that can donate funds, human resources, or equipment for environmental protection and solid waste management. The organisations can be either national or international. Some of them are willing to assist in solving a specific problem without any conditions, while others impose rather stringent and sometimes costly conditions. This option is purposely included as one of the last options for financing solid waste services because the authors have observed several ill-advised “donations” in which the donations have been encumbered with conditions such that they eventually become costly investments to the community. One such example is the installation of an incinerator for combusting residential wastes in a community located in a tropical country, where the wastes would have a very high concentration of wet organic matter. Another one would be the donation of a few used, compacting collection vehicles to a city that is located in hilly terrain and that has narrow, unpaved roads. The cost of operating and maintaining the “free” vehicle is oftentimes several times higher than operating a simple animal-drawn vehicle. It is important to emphasise, however, that not all donations are failures. There are countless positive experiences throughout the world. Unfortunately, the recipients of the donations must be cautioned to carefully analyse the advantages and disadvantages of accepting a particular piece of equipment or system before it is put into use in the community.

C. Financing operating and maintenance costs

C1. FINANCING methods

In developing countries, operating and maintenance (O&M) costs, also known as recurrent costs, can be financed by means of several methods. A brief discussion of each one of these methods is presented in the following section [9-11].

C1.1. General revenues

Local governments obtain their revenues from a variety of sources such as property taxes, fines, and license fees. Local governments typically use their general revenues to finance costs associated with labour, consumables, and spare parts (O&M). Since the revenues in most municipalities in developing countries often are insufficient to cover O&M costs for solid waste services, grants or subsidies from the central government are used to supplement local revenues. In some countries, municipalities receive a fixed percentage (on the order of 10%) of the country’s general budget to complement their general revenue.

C1.2. Grants from central government

Theoretically, grants from the central government would only be justifiable for those cities that have national importance as centres of government, industry, and commerce (such as the capital).

The grants and subsidies would be justifiable as benefiting national economic growth. However, since central governments usually limit the ability of local governments to generate their own revenues, subsidies compensate for the lack of decentralisation.

C1.3. Sources of revenue

Unfortunately, a large number of local governments in developing countries have extremely limited sources of revenue. The amount of residential waste generated in developing countries is about one-third to one-half of that generated in industrialised countries. However, since their taxable income is so low, either a lower standard of service or a less capital-intensive system must be considered.

Ideally, a solid waste service organisation should be accountable for all costs, and the tax or fee paid should reflect the actual costs for the service. Property taxes are not suitable for financing solid waste services, unless it is clearly stipulated that a certain portion of the tax must be used to cover the costs of solid waste service. It is preferable to implement user charges, because these charges raise public awareness about the costs associated with providing the service. User charges have the tendency to make the service agency accountable. Furthermore, if the charge is related to the quantity of waste discarded, the charge may serve as an incentive for waste prevention.

One of the main problems associated with the implementation of user charges is that not everyone is willing or able to pay a user charge for solid waste service. Well designed surveys to determine both the willingness and capacity to pay should be carried out prior to the establishment of tariffs. Generally, the collection of user charges for waste services is extremely low. Some cities have tried to solve the problem of willingness to pay by attaching the user charge to the billing for a service for which residents are more willing to pay. For example, in the past in Lima, Peru, the user charge for solid waste was included with the electricity bill. In other developing countries, residents receive a single bill for water, wastewater, solid waste, and other services such as television and security, if applicable. Combined billing of services allows for reduced costs associated with the billing process, and leads to a high collection rate of the user charges. Furthermore, the addition of solid waste service charges has not led to a discernible reduction in the collection of user charges for electricity or water. In setting the tariff, consideration should be given to making allowances for cross subsidies. Large commercial establishments and high-income residential areas (which typically demand a high quality of service) would be charged a higher tariff than low-income areas.

In a large number of municipalities, the revenues that are collected for waste services generally are deposited into a general account. Once in that account, the funds are often utilised for a number of purposes other than waste management.

C2. COSTS of solid waste service

In order to generate sufficient revenues to cover the costs of solid waste service, a jurisdiction should have a thorough understanding of the actual costs associated with providing the service. Unfortunately, very rarely are the costs fully known. Budgets for departments of local government are based on projections from previous budgets and/or the need to pay salaries and purchase supplies. In order to determine the true costs for solid waste management, the costs incurred from several departments must be consolidated.

C3. RESPONSIBILITY for service delivery

Since activities associated with the delivery of solid waste services generally are decentralised in economically developing nations, it typically is extremely difficult to determine the full costs of the service. Accountability of, and responsibility for, service provision is also difficult to determine in a decentralised system. One of the best methods to resolve accountability is to establish a single entity responsible for all aspects of solid waste management. In order to obtain revenues, it is essential that this entity have the following: 1) equal status with other agencies in the local government that may be competing for a portion of the revenues, and 2) capability to assess and justify financial needs.

Assigning responsibility might be partially addressed by upgrading the status of a solid waste office, which is typically set up within another department having different responsibilities (e.g., Public Health Department, Public Works Department). The department chief would then have the opportunity to request some of the available revenues, as well as the professional staff necessary, to prepare the financial justification for budgetary needs.

Placing all solid waste activities within an independent organisation would assure accountability for the service. These types of organisations usually are autonomous. Generally, political leaders and members of the private sector are appointed to the Board of Directors. These organisations receive grants from the state and local governments. They also generate their own revenues through special charges and fines. Since these organisations are financially responsible and capable of generating their own revenues, it is considerably easier for lending organisations to work with them in obtaining financing and determining the means for cost recovery.

A study conducted in Latin America by The World Bank evaluated 16 semi-private solid waste enterprises. Although the enterprises were relatively accountable, the results of the study indicated that they were not financially independent. All entities received some type of government subsidy and most of them obtained only a small fraction of their revenue from service-related taxes or user charges [3,4].

D. Financing waste management services for marginal areas

In most economically developing countries, the urban poor usually live in marginal areas and squatter settlements. These areas are occupied illegally, and the settlers generally do not pay taxes to local jurisdictions.

In most cases, the marginal areas are not provided with water supply, electricity, wastewater collection, or solid waste services. The shortage of technical and financial resources is primarily responsible for the lack of basic services to these areas. As a result, those responsible for the management of solid wastes have the tendency to concentrate their efforts in high- and middle-income areas of the cities.

It is typically assumed that the residents of marginal areas are not willing to pay for solid waste services. However, the results of work conducted by the authors indicate that this may not necessarily be the case. In some countries in Latin America, the waste generated in low-income areas is collected by individuals outside of the formal collection system. The fees charged by these individuals are comparable to those charged by the formal sector. The level of user charge that has emerged throughout the urban poor areas in Latin America is on the order of US\$3 to US\$7/ dwelling/month.

D1. SERVICE alternatives

The lack of financial resources in economically developing countries does not allow for the provision of basic services to all segments of the population. In this section, alternatives are developed for providing solid waste services in low-income areas. Inasmuch as financial resources are limited, innovative solutions must be developed that take into consideration appropriate levels of service for different types of neighbourhoods and local conditions, as well as other factors.

D1.1. Public participation

A very practical and efficient alternative for providing solid waste services in marginal areas is to encourage public participation. In this particular case, the residents are requested to volunteer some of their time and effort and, thus, keep the outlay of financial resources to an affordable level.

Public participation can be accomplished by requesting that the residents of marginal areas transport their residues either to a conventional collection vehicle provided by the municipality or to a communal container located in a strategic location. In the first option, arrival of the collection vehicle is announced by means of a bell or a loud horn. In the communal container option, different types and sizes of containers can be used. The size of the container can range from half a drum (i.e., a drum in which the top half is cut off), to a whole drum (about 120 L), or to $\geq 1 \text{ m}^3$ containers. In any case, it is important that the containers be emptied by the collector at a fixed frequency and that they be located at convenient distances (i.e., generally not more than 100 m apart). In both alternatives, savings are realised through the reduction in the number of personnel in the collection vehicle.

Another option that has been used in marginal areas involves rigorous public participation initiatives. In this type of alternative, residents are requested to participate in workshops and public meetings in which they are instructed on the benefits of public health and solid waste management. In addition, residents are introduced to recycling processes involving the separation of organic and inorganic matter. The residents are then requested to treat their organic wastes onsite, and to segregate and turn in their dry recyclable materials to a local collection crew or to a neighbourhood recycling depot. The recyclable materials are sold, and the revenues from the sale of the materials are used to pay for the collection and processing costs.

In most cases, these projects have been funded by international development agencies, with the technical assistance of non-governmental organisations (NGOs). Experience thus far indicates that it is important that the technical assistance to the community be continued and maintained over a long period of time to assure a high degree of success.

D1.2. Micro-enterprises

Another viable option to providing collection services in marginal areas involves the establishment of micro-enterprises. In this approach, the full costs of providing the collection service to the particular area are borne by the residents of the area. As such, a small enterprise is established in which residents of the area are requested to participate. The members of the enterprise are trained in their different duties (from collection to basic bookkeeping). In order to keep the investment and operating costs to an affordable level, the enterprise provides the house-to-house service, while the municipality is requested to assist with the transportation of the wastes to the disposal site. Options of this type have been established in Latin American countries, with the assistance of NGOs. Experience thus far indicates that this type of organisation can be established successfully. The success of the enterprise depends upon a

number of factors, including: financial arrangements, logistics and degree of cooperation obtained from the municipal government, level and type of technical assistance, and degree of dedication of the members of the micro-enterprise. The key issues associated with the micro-enterprise include establishment of tariffs; punctuality of payment (either by the municipality or by the householder); and level, type, and length of qualified technical assistance given to the staff of the enterprise.

E. The role of the private sector

The provision of solid waste management services is a very costly and difficult undertaking for many municipalities throughout the world. The level of cost and degree of difficulty associated with the service provide an opportunity for participation of the private sector. In general, the private sector potentially can play two key roles in the field of solid waste management. One important role is to increase the efficiency of the service and, thus, reduce the cost in existing waste management systems. The other key role for the private sector is to provide much needed sources of funds for capital investments. As previously indicated, solid waste management systems in economically developing countries tend to be extremely inefficient, providing relatively low coverage at a high cost, and oftentimes becoming an “employment agency” to a large number of unneeded labourers.

One of the potential benefits of privatisation of the service is the ability to recover the costs of service through the implementation of user charges. The implementation of user charges, or the increase to existing charges, generally is an extremely difficult political decision that can best be managed by allowing the private sector to impose them [5,7,8].

Privatisation, however, is not the total solution to the successful provision of solid waste management services. First of all, privatising some aspect of the solid waste service delivery or the entire system does not reduce or eliminate the responsibility of local government for the service. Furthermore, privatisation of services should not be interpreted as weakening of the local government. On the contrary, in order for local government to effectively privatise some of its services, certain areas of the government institutions must be strengthened. Only a local government institution having competent and qualified professional staff will be able to develop, negotiate, manage, monitor, and enforce a contract with a private entity [2].

The types of privatisation most commonly used in solid waste management include: contracting, franchise, open competition, and vendor/operator equity investment [7].

E1. CONTRACTING

In this case, a private firm, by means of turnkey contracting, may design, build, own, and operate a solid waste facility such as a transfer station, a resource recovery plant, or a sanitary landfill. In the 1980s, turnkey contracts became a popular means of financing resource recovery projects in the United States. Private ownership was encouraged through financial incentives established by the central and state governments. Some of the financial incentives included tax benefits and opportunities for accelerated depreciation [1]. A substantial portion of the waste-to-energy plants in the United States is privately owned.

Perhaps one of the better areas for the private sector to enter the waste management field is in the area of waste collection under contract with the local government. As a result, it is feasible for local firms with modest financial resources to enter into the business of solid waste collection. A study of privatisation in Latin America indicated that most of the firms were of a small to medium size, demonstrating that there were virtually no barriers to entry [3]. Additionally, as previously pointed out, the demand for collection service in many low-income areas in

economically developing countries provides the opportunity for very small entities (micro-enterprises) to provide the service [6].

Privatisation is an appropriate alternative for providing much needed solid waste services in many countries. However, the service must be properly described, performance indicators established, costs delineated, an equitable contract developed, and monitoring functions well defined in order to receive the most benefit from the service. Therefore, contracting seems to be better suited for isolated activities (which can be evaluated easily) within the solid waste system, such as the operation of a landfill. In Buenos Aires, Argentina, private firms provide waste collection services and operate transfer stations and sanitary landfills under contract with CEAMSE, the government entity responsible for solid waste management. In Mexico City, a private entity operates one of the major landfills.

In the event that sufficient funds are not available for the acquisition of equipment or it is difficult to borrow the funds, it is possible to contract for provision of the equipment. For instance, some or all of the solid waste collection fleet can be leased from private firms. The firms can provide the vehicles only or the vehicles with the drivers, fuel, and even maintenance. One of the major disadvantages in this option is that the vehicles available for lease in developing countries often are not well suited for waste collection (particularly residential waste), since the majority of the equipment is used in the construction business. Since collection is one of the more expensive phases of the waste management process, the option of leasing vehicles should be carefully considered before it is implemented [6].

Another possibility for privatisation of collection services is to adopt a system that would consist of the following elements and functional relationships. The municipality would purchase appropriately designed collection trucks. The vehicles would then be leased to qualified contractors, who would be responsible for the operation and maintenance of the vehicles. In order to avoid the potential of poor operation and inadequate maintenance, the municipality can institute a rigorous monitoring program and provide the maintenance. On the other hand, operation and maintenance can be left up to the contractors, with the understanding that after a predetermined number of years the vehicles would be owned by the contractors.

If a municipality is considering privatisation of the collection system, it may be advisable to privatise a portion of the city and maintain public services in another. Under this system, the collection areas should be selected carefully so that they are comparable. The mixture of private and public services results in having both methods accountable to the users and, thus, encourages competition. Consequently, the public entity is motivated to provide efficient service, and the private organisation understands that efficiency and tariffs can be compared, as well as the fact that the municipality would still be able to take over the system if the service provided by the contractor is not satisfactory.

E2. FRANCHISE

In this option, the law empowers a municipality with the authority to give to a private entity an exclusive franchise, or right, to provide service to customers in various zones under the municipality's jurisdiction. In return for an exclusive franchise granted by the municipality, the private firm pays a franchise fee to the municipality. Under a franchise system, the firm is responsible for providing the service and can charge its customers to recover the cost of the service. In this situation, the municipality or local government maintains responsibility for supervising the performance of the private firms. Additionally, the municipality must maintain some degree of oversight and/or set limits on the type and level of tariffs.

E3. OPEN Competition

In economically developing countries, a municipality typically uses open competition in the private sector to secure maintenance and repair services for equipment used in the solid waste management system. In some cases, minor repairs are performed by maintenance personnel employed by the government. However, for major repairs of waste collection vehicles and other heavy equipment, the common practice is to request quotations from private garages and to grant the repair work to the lowest qualified bidder. Depending upon the size of the service area, it may be advisable to contract as well for the performance of minor repairs in order to economise on time and distance travelled.

Private collection through open competition is another viable option to municipalities in developing countries. This type of service provision is especially applicable in large urban areas where private collection firms are established. One of the advantages of this option is that through a well designed procurement process and a sound, as well as transparent, evaluation process, a municipality can select the most appropriate conditions for its particular situation and secure the lowest price. On the other hand, this alternative presents the possibility that an established firm may lose a contract and, thus, its investment and experience to one with little experience.

The alternative of open competition has been used several times by the City of San Jose, California in the implementation of its integrated mixed waste collection and recycling program.

E4. VENDOR/operator equity investment

This is an alternative for the private sector (the vendor or operator of a facility or system) to provide equity investment based on potential financial benefits (i.e., tax benefits). In developing countries, the equity investment varies from about 10% to 80%, or even 100%, of the project cost. The remainder of the funds generally is obtained by means of institutional loans. In some cases, the municipality guarantees a certain payment for the service (i.e., cost/Mg), and requires that the ownership of the particular process or system revert to the municipality after a certain time period.

F. Financing considerations and requirements

F1. SELECTION of financing method

In general, selection of the most appropriate means of financing a particular solid waste management project should be based on considerations of degree of risk or benefit and on the most cost-effective option to the rate payers. Essentially, a municipality should address the following three key issues associated with financing: 1) perform a thorough analysis to determine the financing method that results in the lowest tipping fee to the users, 2) identify the potential liabilities related to each financing alternative, and 3) determine the potential advantages and disadvantages associated with each alternative.

F2. VIABILITY of the project

At the risk of stating the obvious, one of the more basic requirements for financing, regardless of the type of method to be selected, is that the proposed solid waste management program be financially and economically viable. Viability can be thoroughly evaluated by developing and implementing a computer model and continually updating the model with current information. A good model allows the evaluation of several options or scenarios, and the impact of changes on the tipping fee. In addition to the development of a model, there are a few other key requirements that should be carefully explored and analysed before a final decision is made.

F3. RELIABILITY of waste supply

A reliable quantity of waste is a critical component of a solid waste project. The supply of waste should be available for the term of financing. A typical agreement involves a “put-or-pay” contract, signed by the municipality or solid waste authority, essentially guaranteeing delivery of a minimum amount of waste at a certain tipping fee. In the event that the municipality is unable to deliver the agreed minimum quantity, the municipality still has to pay the tipping fee for that minimum delivery.

F4. SERVICE agreement

Contracts should be developed and executed that clearly define the terms of the agreement. The various responsibilities of the parties involved should be delineated, such as acquisition of sites, permits, startup, operation, maintenance, and the terms under which payment for services will be made.

F5. SALES of materials and/or energy

Contracts should be in place with the entities that are going to purchase the resources that will be recovered from the waste stream. Ideally, these agreements would be made on a “take-and-pay” basis. A take-and-pay agreement simply means that the buyer must accept agreed-upon quantities of materials or energy, and pay for the resources regardless of use. This is particularly important when energy is produced. In the event that materials are recovered from the waste, then a minimum price per unit weight should be negotiated and included in the contract. The quality, or specifications, of the recovered resources also should be described in the contract, as well as a description of the method for adjusting the purchase price if the specifications are not met.

F6. AVAILABILITY of final disposal site

In the event that the project that is to be financed involves some type of resource recovery process, then provisions must be made to dispose of the residues. The residues would take the form of reject materials from a materials recovery process, or of combustion ash and waste that cannot be processed from a thermal treatment process. In addition, arrangements must be made to bypass and landfill the entire waste stream in the event of temporary shutdowns due to breakdowns, strikes, or other reasons.

F7. LEGAL authority

A legal authority should be clearly identified and established before financing is finalised. The legal authority acts as the responsible public agency for the project.

F8. PERMITS

All required permits should be obtained for the various solid waste facilities to be built and operated under the contract. Permits should be obtained from local, state, and national agencies, as appropriate.

F9. AGREEMENTS

Depending on the type of solid waste management project, some or all of the following types of agreements should be in place before the final financing process begins: waste supply agreements, construction contracts, operating agreements, end product purchase agreements, and financing agreements. Construction contracts should cover all aspects of construction, including:

timing and performance levels, technology to be used, and others. The contractor should have sufficient financial capabilities to guarantee the required performance of the agreements. Operating agreements should identify the operator of the facility, performance and operating conditions, and terms of payment. The financing agreements should specify items such as the requirements for reserve capital, debt coverage requirements, and terms of repayment.

F10. FINANCING process

The entity responsible for the financing must review in detail all aspects of the project and make sure that all requirements have been met. The review basically falls into three general categories: 1) evaluate the project's ability to secure financing, 2) develop and structure the financing, and 3) market the securities to finance the solid waste facility (if applicable).

F11. OWNERSHIP

Before final financing of a solid waste management is reached, the municipality must decide whether final ownership will rest in the public sector or in the private sector. The decision regarding ownership should consider the following items: expediency, risk assumption and allocation, control of the project, costs, and tax implications (if applicable).

G. The impact of resource recovery on financing

Resource recovery (e.g., recycling, composting), if properly conceived and implemented, can reduce the financial impact of waste collection and disposal services. For example, the separation of recyclable materials (such as paper, glass, metals, and plastics) at the source of generation leads to a reduction in the quantities of waste, which the local government would have to transport and dispose at a landfill. In economically developing countries, the mixed municipal waste stream typically contains on the order of 20% to 30% (by weight) of potentially recyclable inorganic materials. As the economic status of a particular country improves, consumption patterns change and an increase can be expected in the percentage of recyclable materials in the waste. Thus, savings in disposal costs may be available in the future if additional quantities of recyclable materials are recovered and marketed. In addition, the segregation and processing of the organic matter in the waste can make a sizeable contribution to the reduction of quantities requiring ultimate disposal, since organic matter typically constitutes 50% to 60% of the residential waste stream.

The recycling program must be properly planned and implemented; otherwise, the program may lead to substantial increases in the collection and processing costs (e.g., having to collect the source-separated materials by means of a vehicle other than a refuse collection truck). Perhaps one of the best approaches to encourage source separation is to provide some type of incentive to the community. One of the simplest and easiest methods of community-based recycling is the implementation of the buy-back centre. In this system, startup capital is provided to enable the centre to purchase ("buy back") recyclable materials from the generators. Generators are responsible for transporting the materials to the buy-back centre and the materials must meet certain minimum specifications. This approach works well if the generator does not have to travel long distances to sell the recyclable materials. The centre must be equipped with storage bins, scales, processing equipment to meet buyers' specifications and to reduce transport costs (e.g., baling equipment), and accounting offices.

Another approach to community recycling is to request and promote segregation of recyclables at the source of generation, followed by transport of the recyclable materials to a community-based facility for processing and marketing. To be cost effective, the collection and processing costs associated with the recycling program should be less than the revenue obtained through the sale

of the materials, or the net cost of collection and processing should be less than the cost of collection and disposal if the materials were disposed instead of recycled. The criterion for cost effectiveness chosen by a community depends on a number of factors, including the environmental benefit of recycling, which is difficult to quantify economically. These and other approaches to resource recovery and recycling have been presented in other chapters.

Regardless of strategy or system, marketing of the recyclable materials is fundamental to the success of any type of recycling program. Recycling programs should not be instituted without having contracts or agreements signed for the purchase of the recyclable materials. The contracts should stipulate some key items, such as: specifications for the materials, minimum quantities accepted, physical form (baled, shredded, etc.), and floor prices. A municipality can also undertake and initiate market development programs in order to seek and establish new local and cost-efficient uses for the recyclable materials. On a regional scale, central governments can encourage the development of markets for recyclable materials from the waste by limiting subsidies for virgin materials that compete against recyclable materials for particular uses, such as any subsidies favouring forest products over wastepaper as a feedstock for pulp and paper manufacturers.

H. References

1. Hilgendorff, C.C., "Emerging Trends in Solid Waste Finance", *Solid Waste & Power*, 3(2), April 1989.
2. Seader, D., "Privatization Moves to the Forefront", *Solid Waste & Power*, 3(2), April 1989.
3. Bartone, C.R., L. Leite, T. Triche, and R. Schertenleib, "Private Sector Participation in Municipal Solid Waste Service: Experiences in Latin America", *Waste Management & Research*, 9(6), December 1991.
4. Bartone, C.R., "The Role of the Private Sector in Developing Countries: Keys to Success", *Waste Management: The Role of the Private Sector*, ISWA Conference, Singapore, Malaysia, September 1995.
5. Scarlett, L., "Solid Waste Management Privatization: A Survey of Success Factors in the United States", *Waste Management: The Role of the Private Sector*, ISWA Conference, Singapore, Malaysia, September 1995.
6. Diaz, L.F. and J.M. Ortellado, "Privatization of Solid Waste Services in Latin America", *Waste Management: The Role of the Private Sector*, ISWA Conference, Singapore, Malaysia, September 1995.
7. Alegre, M.C., *Privatisation in Solid Waste Management*, Master Thesis, Loughborough University of Technology, England, September 1994.
8. Donnelly, P. and C. Rines, "The Effect of Existing Law on the Financing of Municipally Sponsored Systems for Converting Waste to Energy", Symposium on Energy from Biomass and Wastes IV, Argonne National Laboratory, Argonne, Illinois, USA, 1980.
9. Resource Planning Associates, *Financial Methods for Solid Waste Facilities*, U.S. Environmental Protection Agency, Office of Solid Waste Management Programs, Washington, DC, USA, 1974.

10. Bolczak, R. and R.E. Zier, "Financing Options and Alternatives", *Solid Wastes Management*, September 1982.
11. Dawson, R.A., "Facility Financing Options", *Solid Wastes Management*, April 1982.

CHAPTER XVII. POLICY ALTERNATIVES FOR IMPROVING SOLID WASTE MANAGEMENT

A. Introduction

Characteristically, in most developing nations, solid waste management and the provision of associated services are entrusted to a municipal agency. Associated services include all aspects of solid waste management, ranging from collection through final disposal. Another feature of solid waste management in developing countries has been the basing of important decisions upon findings made in a search for the least burdensome course of action. Not surprisingly, the almost inevitable outcome of such a limited course was the adoption of a solid waste management program that was unsatisfactory.

B. Decision-making

The proper approach to decision-making and program development is to take into account the combination of increasing demands and limited resources that usually prevail in developing nations. This combination necessitates the adoption of waste management systems that are based on practical and systematic methods. A further requirement is that program selection should essentially be a local activity, and should be a response to local needs. Consequently, no single formula is to be found that can provide a solution for every situation [1].

A serious problem that besets most developing countries is the high cost of solid waste management. Evidence of this difficulty is the fact that the expenses associated with providing solid waste services account for 10% to 50% of the revenue taken in by a typical municipality. Furthermore, deficiencies resulting from inadequate management cannot be remedied merely by resorting to increasing the already high expenditures. On the contrary, the attainment of high levels of efficiency in the overall system is one of the more effective means of expanding the coverage and improving the quality of the solid waste service.

Efficiency in solid waste management is a function of several fundamental factors. Factors of particular importance in a developing country setting may be classified as follows: 1) financial (e.g., budget, access to financing); 2) human resources (e.g., professional competence at the management and implementation levels, provisions for training personnel); and 3) pertinent political issues [2].

C. Financial aspects

C1. BUDGETARY issues

In comparison with those in industrialised countries, unit expenditures on solid waste management typically are larger in developing countries. The disparity arises in large part from the inefficiency and inadequacy characteristic of waste collection and transport in developing countries. The costs for collection services in a developing country generally range from US\$2 to US\$5/Mg. In a large metropolitan area, however, collection costs may be on the order of US\$10/Mg. This cost is high despite the fact that expenditure on disposal in developing countries is very low because the usual method of disposal is the open dump, unencumbered by environmental constraints.

The budgetary problem is aggravated by the failure of the public to appreciate the significance of the disproportionately high cost of solid waste management. This failure originates in the absence

of an understanding of the real costs associated with waste management, which is an outgrowth of a lack of awareness of the service charge, or of an erroneous belief that the charge only equals about 10% to 20% of the real cost.

A practice unfortunately typical of developing countries during periods of financial stress is the tendency to reduce funds allocated to maintenance of equipment and to the acquisition of supplies and replacement parts. This tendency has many unfavourable consequences, one of which is a sharp drop in the number of vehicles available for collection. Vehicle downtime may be as much as 40% to 60%. To maximise the number of functioning vehicles during times of financial stress, solid waste managers usually resort to cannibalising disabled vehicles to obtain parts for the repair of other vehicles. Another desperate measure is to keep vehicles in operation long past their useful lifespan [3].

C2. BUDGETARY reform

The objective of budgetary reform is the continuing assurance of an adequate solid waste management budget. A measure that would go far to the attainment of such an assurance is to give local governments the authority to defray solid waste management costs through the establishment of the necessary revenue base. Establishment of the revenue base can be facilitated through an updating of the cadastral. This can also be facilitated by amplifying the collection of taxes, fees, and licenses. Moreover, local governments should be empowered to levy and collect taxes from residents, including the imposition of user fees for solid waste services.

A serious problem arises from the three- to six-month delay that often intervenes between the drafting, approval, and appropriation of a budget for provision of solid waste management services and the actual receipt of the funds by the entity that provides the service. The problem is further aggravated by the fact that the amount eventually received almost inevitably is only a fraction of the original appropriation. Consequently, proper planning for the utilisation of the funds becomes extremely difficult. Another result is the unfavourable impact exerted upon the financial rating imposed by vendors and suppliers of equipment, replacement parts, and other items upon the solid waste service sector. The unfavourable rating has an inflationary effect upon charges for purchasing replacement parts and supplies. The inflation is an accommodation for the long delays in payment. Adding to the difficulties of the situation is the ineffectiveness of the budget cycle and an incorrect interpretation of the cycle.

A chronic shortage of funds in many municipalities intensifies the competition between the various departments within the municipalities for access to the limited funds that are available. This competition interferes with the proper balancing of the funds. Moreover, it encourages the absence of order and planning in the disbursement of available funds.

In summary, several measures can be taken whereby the required cash flow can be facilitated and maintained. Chief among them are the following two: 1) amplify and strengthen the self-sufficiency of local governments, endowing them with the authority to levy and collect taxes from constituents; and 2) empower solid waste service organisations to directly invoice and collect user fees from residents.

C3. DEVELOPMENT of a financial base

As is true in other governmental divisions, decision-making in the solid waste management sector is, or should be, strongly influenced by the magnitude of the available funding, i.e., the level of its monetary reservoir. The dependence originates in the obvious fact that the feasibility of implementing any given decision is a function of the existence and magnitude of the sector's financial resources. Unfortunately, all too frequently, decisions are made and their execution is

attempted without regard to available financial resources. These unfounded decisions may rest upon erroneous assumptions regarding available financial resources, or the matter of financial resources simply may be ignored.

C4. EFFECTS of financial resources

The effect of financial resources upon the feasibility of implementing decisions has many ramifications, some of which are discussed in the paragraphs that follow.

One ramification is the fact that funding availability can act as a constraint upon process and facility improvement, or upon facility expansion.

A particularly significant effect of access to adequate financial resources is that it enables the inauguration of systems or processes that markedly improve the service. For example, the financial resource could serve as a source of funding for the construction of a needed transfer station. The acquisition of land depends upon access to funding, i.e., access to a financial reserve. In addition, access to such a reserve is needed to finance the construction of a transfer facility complex, and for the purchase of rolling stock.

Not all shortcomings in the solid waste management sector are entirely traceable to financial difficulties. Thus, a serious shortcoming can be the unawareness of the savings that accrue from the substitution of a more efficient system for a less efficient one. Unfortunately, funding for such substitutions usually fails to materialise. The customarily poor financial climate with respect to certain systems in the solid waste management sector can be explained by the modest political appeal of the systems. Moreover, the foreign funding component of the system may be too small to be of interest to international financing institutions.

Instead of adopting an appropriately simple (low) technology, many developing countries tend to select a technology that is more suited for an industrialised country. Obviously, adoption of an inappropriately high technology will generate an unfavourable financial climate in a developing country. Nevertheless, securing financial backing for appropriately low-cost, low technology is far more difficult than obtaining financial backing for high-cost, inappropriate, complex (high) technology. Thus, it is not unduly difficult to arrange for the loans and credits involved in financing expensive, and frequently ill-suited, processing options such as incineration and highly mechanised materials recovery schemes. On the other hand, arranging a local loan and financing for the acquisition of land for a low-cost sanitary landfill and for construction and operation of the facility is a far more difficult task.

C5. DATABASE needs

A failing that is common in developing countries (as well as in industrialised countries) is the virtual neglect of an attempt to precede a solid waste management undertaking with the implementation of a database. The database should include: 1) the raw data, 2) an analysis of the data (discussed in another chapter), and 3) the planning arising from the data analysis.

An adequate database is particularly essential in the design and implementation of the waste collection service. A satisfactory database makes it possible to improve the quality and coverage of the service at a lower cost, because the collection process usually is the most expensive of the management processes. Maximum lowering of collection costs involves the gathering of accurate current information on parameters such as: number of stops per route, amounts of waste collected per stop per route, time requirements, and productivities per worker and per vehicle in terms of crew size. These data should influence the design of collection routes and the rationale for assigning crew size and number of vehicles per given route.

In a developing country setting, reliance upon a management information system can bring about a 25% to 50% reduction of per unit cost of solid waste management service. Although the futility of not analysing amassed data should be readily apparent, neglect of the analysis is not infrequent. Often, the accuracy of data is unfavourably compromised because of failure to adhere to prescribed protocols. Ultimately, effectiveness of cost reduction measures is a function of quality of the professional skill with which they are formulated and applied.

C6. COST containment via design of collection service

The following is a list of steps and considerations that are conducive to the designing of a collection service that is commensurate with cost containment.

1. Adjust the number of loads per shift of work such that the practical loading potential per worker is maximised.
2. Select the type and size of vehicle that best befits the roads and loading conditions of the neighbourhoods to be served.
3. Adjust crew size per collection vehicle such that the utility of the vehicle is maximised. Crew size should be based upon time and motion studies of worker productivity under different sets of working conditions.
4. Keep collection vehicle “downtime” to a minimum. This can be done by scheduling adequate preventive maintenance. An essential element of preventive maintenance is the continued availability of spare parts and of the tools needed for repairs.
5. Ensure compliance by local residents with ordinances enacted in support of the solid waste service.
6. Secure the collaboration of the public in the waste collection activity. This can be accomplished by resorting to a suitable public education effort. For example, aspects of proper storage of waste at the site of generation constitute a useful subject for public education. Among the aspects would be durability and capacity.
7. Properly design the storage area, as well as the positioning of the receptacles on the day of collection.

C7. PROCUREMENT

The success or failure of a solid waste management activity largely depends upon the degree of access to required equipment. The reason for the dependence lies in the extensive technological orientation of the activity. Hence, equipment procurement becomes a critical feature. Because collection and processing constitute a major share of solid waste management, especially in a developing country setting, procurement of collection equipment assumes a significant importance.

Procurement involves the preparation of specifications and tender documents. In the procurement of collection vehicles or processing equipment, it is essential that recourse be had to the expertise needed to select the most appropriate types of equipment at the lowest cost. The extent of the spread between highest and lowest vehicle costs is exemplified by the spread between the current highest and lowest costs of a new, modern collection vehicle. The current lowest cost is US\$50,000 and the highest is US\$190,000. The foreign exchange component of the purchase price for a particular vehicle may vary between 60% and 95%. In most situations, the initial

purchase price is not used as an indicator to determine whether or not the particular vehicle will result in a low total cost for ownership and operation.

Regarding the number of vehicles to be procured, obviously, number is a function of the capacity and degree of productive use of particular vehicles. Thus, one collection vehicle is required for every 1,500 to 10,000 residents. Practically speaking, the economic lifespans of waste collection vehicles range from 5 to 10 years.

C8. EQUIPMENT bid document: preparation and precautions

Ideally, responsibility for equipment acquisition is entrusted to a task force. Accordingly, members of the task force must work together to develop a detailed set of specification requirements.

The task of delineating the basic aspects of the bid documents should be assigned by the task force to a technically qualified individual. In making the delineation, the individual usually relies upon general specifications gleaned from brochures of one or two known equipment suppliers. Ideally, the decisive criterion for final acceptance of a bid is based upon the lowest qualified bid. Far less desirably, acceptance may rest upon political acceptability. An important, but often overlooked, criterion is lowest total ownership and operating cost. Comparative evaluations of vehicle ownership and operating costs should be made by knowledgeable mechanical engineers and by experienced supervisors from the fleet garage.

It is essential that decisions made by the task force concerning vehicle selection be based on actual vehicle operational experiences in the country, road conditions, driver skills, mechanic skills, available workshop equipment, local availability of spare parts, and opportunities for standardisation of components. In addition to the technical aspects, the specifications should include financial and legal conditions required for the particular acquisition.

In developing countries, the most likely sources of investment capital for the procurement of solid waste management equipment are entities such as the traditional international and bilateral development agencies (e.g., The World Bank). Certain funding agencies may insist upon international competitive bidding. On the other hand, a donor country may insist that the funds be used for the purchase of equipment manufactured within its domain. As far as developing countries are concerned, reliance upon funding sources currently available to them renders it very difficult to attain standardisation in the solid waste fleet. This in turn complicates the ability to stock the tools and replacement parts needed to keep the fleet in operation.

C9. COSTS apportionment

Information on actual costs is a precondition for the attainment of cost efficiency in a system. Although a manager may be given information on total costs of department salaries, fuel costs for the entire fleet, total costs for replacement parts, and debt service; he or she usually is not given detailed information. Moreover, the manager does not have the means of analysing existing data into meaningful information that could be used to improve the efficiency of the service. Information that could be used advantageously by the manager would be the unit cost of utilising a vehicle that has been used beyond its economic life, as compared to a new vehicle. Also useful would be a comparison of the cost of providing the service with a non-compactor collection vehicle and with a compactor, as well as an analysis of the cost advantages to be gained from the use of standardised containers. In addition, it would be useful to calculate the cost advantages of operating the fleet for two 6-hr shifts/day instead of one 8-hr shift.

Monitoring a solid waste management system demands access to data that are both reliable and applicable to the situation. The only fully satisfactory approach to the acquisition of such data is by way of an evaluation of the impact of the service upon the community's sanitary status.

In terms of percentage of average personal income, attainment of a comparable level of sanitation is more costly in developing countries than in industrialised countries. Although the cost of refuse collection in many developing countries is only about one-half that in industrialised nations; the magnitude of the average income is only a small fraction of the income of residents in industrialised countries. The consequence, therefore, is that a disproportionate amount of available revenues is spent on solid waste services in developing countries.

D. Human resources

D1. PERSONNEL requirements

The intricacies of solid waste management demand the services of highly qualified personnel that represent a broad array of professional disciplines. Illustrative of the breadth of the disciplinary array is the need for the input of professionals versed in mechanical engineering who would be responsible for the management and maintenance, repair, and deployment of the collection fleet. On the other hand, the input of professionals versed in civil engineering is essential to the design and operation of a sanitary landfill [5].

Regarding the design of optimal collection routes and the determination of appropriate collection methods and crew sizes, it is sufficient for the personnel assigned to this task to have had proper training and experience. However, a formal education in the principles of systems analysis would be helpful.

D2. FIELD supervision of collection service personnel

The importance of field supervision derives from the fact that the quality of the collection service is, to a great extent, a function of the quality of the performance exhibited by the staff, inasmuch as collection is a labour-intensive operation. Regarding the size of the supervisory staff, one field supervisor per five to eight collection vehicles is recommended. The difficulty in meeting this recommendation is intensified in many regions by a chronic shortage of competent professionals specifically trained in solid waste management. This deficiency is an outcome of the substantial dearth of formal education and of poor hiring practices. The unfortunate combination of circumstances compels numerous public and private sector institutions entrusted with solid waste management to employ untrained candidates, some of whom are unable to perform the tasks pertinent to routine operations.

The unfavourable consequences of the situation engendered by the shortage of qualified professionals are intensified by the practice of overburdening professionals with the responsibility of managing an overly large workforce. The lot of the professional in the solid waste management sector is rendered less attractive by the fact that the salary base in the solid waste sector usually is lower than that for comparable professional training and experience in other services in the public sector.

D3. ATTITUDE, morale, and motivation of personnel

The major significance of "attitude" arises from its effectiveness in minimising absenteeism. Absenteeism becomes a seriously deleterious factor in activities that require a given amount of human input. For example, an incomplete complement of workers almost invariably leads to an inadequate utilisation of equipment and/or overburdening of the remaining staff and crew.

Motivation is a factor because it is a positive force that impels an individual to participate in a given endeavour. One of the sources of motivation is a strong awareness of the utility of, and need for, the task being performed or to be performed. Judging from common experience, workers involved in a solid waste management activity generally have this awareness and, hence, possess the desired motivation. The community can foster and strengthen this motivation by initiating training programs and clarifying job descriptions. Monitoring and evaluating work performance, accompanied by assurance of job security, are excellent reinforcements of motivation. Finally, a program of motivation should be capped by the provision of basic benefits such as medical coverage and guarantee of a retirement pension.

Because motivation is a function of incentives and disincentives linked to performance evaluation, solid waste managers should be empowered to acknowledge superior performance by way of incentives such as formal recognition, further training, accelerated promotion, salary enhancement, and bonuses. Conversely, managers should be able to penalise inferior performance. This can be done through the imposition of disincentives such as fines, demotions, and dismissal.

D4. PUBLIC health inspectors

In accordance with the level of labour intensity, in developing countries, the size of the refuse collection workforce ranges from 5 to 50 labourers per 10,000 residents. Typically, the public health inspector assignment is one inspector per 100 to 300 collection workers. However, only from 5% to 40% of an inspector's time is devoted to solid waste related activities. Time over and above the 5% to 40% is reserved for the inspections of medical clinics, restaurants, food markets, public toilets, and other facilities and installations. In terms of time equivalents, this division of effort translates into approximately one full-time inspector for every 1,000 or more collection workers, or one inspector for every 200,000 residents. Generally, a public health inspector is entrusted with the enforcement of local health-related ordinances, definition of proper storage and disposal of waste, and the restricting of littering. Finally, the entire responsibility for providing public education on sanitation and improvement of the quality of the environment usually devolves upon the health inspector.

The preceding exposition of the labour situation demonstrates that the investments being made on public health inspection in developing countries are not sufficient to produce an educated and cooperative citizenry. Consequently, it is necessary to establish policies that will lead to a change in this situation.

E. Political issues

E1. AUTHORITY

Individuals charged with the management of an organisation must be authorised to make day-to-day operational decisions. In fact, the satisfactory functioning of an organisation depends upon the organisation being endowed with an authority commensurate with its responsibility. A serious difficulty in many developing countries arises from the fact that although the expenditure on solid waste management is relatively high, the position of the service in the municipal hierarchy is quite low. Frequently, the solid waste service has a divisional status within a public works or public health department. Another setup is as a section within a municipal semi-private authority established for water, wastewater, and solid waste.

Because of its comparatively low status, the authority is severely constricted. As a result, the manager of a solid waste group has little latitude in terms of hiring and appropriately paying the professional staff needed to plan and supervise the service. An additional and serious problem is

the practice of burdening the manager's budget with the costs of low-level staff, some of whom may be on the payroll but not actually working.

The difficulties described in the preceding paragraphs can be avoided by broadening the autonomy of the solid waste sector and reorganising it either as a separate solid waste department within the municipal structure or as a semi-autonomous public enterprise. Establishing a separate municipal department enables greater accountability and also allows the employment of high-level professionals in the service. Setting up a completely separate entity would allow the authority to institute pay scales, which would be outside of the municipal salary scales and enable staff hiring and firing with limited interference from politicians. This type of organisation could enable the entity to generate financial resources so that it could be self-financing. There is the possibility that the establishment of such an independent entity might be interpreted as being a weakening of the municipality because it apparently would usurp one of its fundamental services. Consequently, the advantages and disadvantages of such a move must be carefully analysed and weighed before its implementation.

E2. PUBLIC education

Collaboration of the public is essential to the successful attainment of the objectives of the solid waste management service. Collaboration is best obtained by convincing the public that its cooperation is the key to the successful conduct of the service and, furthermore, that success of the service redounds in an improvement in the welfare of the public. One of the most effective means of securing such a conviction is through education [6].

Education can be accomplished formally and informally. A formal approach would involve the establishment of conventional educational programs in schools, as well as publicity campaigns. The program and campaigns would elaborate upon the benefits to be expected from proper waste management, and upon the baneful consequences of poor sanitation, while emphasising the high costs associated with inadequate public cooperation.

There are several informal modes of convincing the public that might loosely be termed "education". For example, one such approach is disciplinary in nature and, hence, may be burdened with some political odium. The approach would largely consist of the enactment and enforcement of relevant legislation (e.g., establishment of regulations and delineation of penalties). A much more effective (and far more politically palatable) approach is to initiate a "cleanup" campaign designed to motivate the citizenry and, thereby, elicit its participation. The subject of a cleanup campaign could be a neglected neighbourhood, a littered park or body of water, or any other locality in need of attention. Inasmuch as at least some of the active participants in the cleanup may have contributed to the littering, they will acquire an appreciation of the arduous and thankless nature of the management of solid waste - and in the future may refrain from littering.

E3. STATUS and resulting problems

The lowly status of solid waste management in the municipal officialdom in developing nations is responsible for many of the difficulties that afflict the service. Among the more serious of these obstacles is the prevailing failure of residents to cooperate with the agency that provides the service.

An example of lack of resident participation is the poor management of waste at the point of generation. The poor management consists of the practice of the waste generator of directly discarding waste into the environment; or, at most, of storing waste in randomly selected containers, such as cardboard boxes, rather than in properly designed receptacles. Unfortunately,

the inadequate storage problem is compounded by failure to have filled storage containers readily available for servicing on designated collection days. The improper handling and storage and non-observance of collection day schedules render it exceedingly difficult to maintain cleanliness and order in delinquent neighbourhoods. Additionally, waste in unattended piles or wastes placed in inappropriate receptacles for collection are subject to being picked through by scavengers and dispersed by animals. The cost of emptying a properly designed waste container is only one-third that of collecting and disposing of dispersed refuse.

Few cities in developing countries enforce their littering and dumping laws. This relaxed attitude apparently is not influenced by the fact that littering and illegal dumping can make a well serviced city appear dirty even though residential refuse is properly stored and is collected on a daily basis. Moreover, the attitude apparently is not affected by the high cost of cleaning up after an untidy citizenry.

E4. POLITICAL factor

In developing and in industrialised countries, local and national public commitment is an essential element in the attainment of a solid waste management service that is both effective and efficient. Paradoxically, political commitment to the solid waste service demands that a protective barrier be set up and maintained between politics (political pressures) and the operation of the solid waste management service. In the absence of such a barrier, the work effort remains in danger of being concentrated on short-term, highly visible, publicity-oriented changes at the expense of accomplishing long-term, cost-effective improvements that happen to be less visible to the public.

The reality is that very frequently the ideal barrier either is not set up or is breached so often as to cease being effective. The result is that, in practice, the solid waste manager is a political appointee who often is devoid of experience or expertise in solid waste management. The outcome is that most of the appointee's term in office is consumed in becoming acquainted with the service and in deciding upon a course of action. The appointee's effectiveness is severely constrained by the reluctance or even refusal of staff to cooperate, which is not surprising because the staff is well aware of the appointee's short tenure in office. This is particularly true where the collection workers unions are very strong (e.g., some Latin American countries).

E5. ROLES of the political leadership

E5.1. National level

Ranking high among the roles available to the political leadership regarding the improvement of the solid waste management service is one that consists of enacting and enforcing ordinances that prohibit littering and call for the public to collaborate with the service. Another role is to provide the solid waste service with a reliable and adequate budget. An exceedingly important role is to ensure that corrective measures be rigorously applied in situations in which the quality and effectiveness of the management service are being corroded by internal corruption and theft. The successful implementation of the corrective measures depends in large part upon the willingness of the leadership to make and enforce the difficult decisions that lead to the disciplining of transgressors.

E5.2. Local level

Conscious of the brevity of term of office characteristic of local official positions (e.g., municipality, district), and of the fact that a second term may not be permitted, politicians at the local level tend to concentrate on short-term, preferably potentially newsworthy projects.

Consequently, local office-holders may be vulnerable to promotional overtures made by purveyors of unneeded equipment. Unfortunately, proposals for the acquisition of a fleet of vehicles or for the construction of new facilities are more apt to gain and hold the attention of politicians than would proposals to improve the routine operating and maintenance needs of the solid waste service. In short, local solid waste services are very vulnerable to political pressures.

E6. CENTRALISED policy coordination

It has been found that problems generated by local circumstances and fostered by the local political leadership often can be rectified through the establishment of an interministerial coordinating body at the central government level. The coordinating body would be entrusted with: 1) the development of a national strategy, 2) the evaluation and coordination of major investments, 3) the development of projects, and 4) the making of budgetary allocations from the central government.

It would prove useful to augment the coordinating body with a group of solid waste professionals at the central government level. This group would be charged with: 1) analysing and making comparisons between the systems in the various localities, 2) keeping abreast of the state-of-the-art in other countries, and 3) serving as a clearinghouse of information available to support local solid waste managers.

Policy and program support proffered by the regional or central government serve as a strong platform for local action. Standards for service delivery and performance measures should be established at the national level. Additionally, monitoring, guidance, and regulation of local solid waste services are best accomplished when they are done at the central level. Other activities appropriately delegated to the central government include the acquisition and analysis of data on waste characteristics and quantities, operational norms, service costs, and appropriate technologies. The objective of laws, regulations, and policies promulgated at the central government level should be to provide support for compatible local ordinances and enforcement actions [4].

To avoid needless duplication of effort and expenditures, large-scale research and development work and pilot testing should mostly be confined to the central government level. The reason for the restriction is the fact that the necessarily high degree of expertise and the occasionally relatively expensive financing are not available at the local level.

In general, the implementation of measures designed to reduce the quantities of solid waste generated and to promote recycling is best left to the central government. This is especially true if the primary goal is to protect the quality of the environment. Any increase in the promulgation and stringency of such measures usually triggers an increase in the cost of waste management at the local level. However, the added cost is compensated by an improvement in environmental quality. In turn, the added cost and the improvement in environmental quality serve as incentives. The central government can make a considerable compensation for the costs by way of the establishment of procurement specifications and procedures, import trade policies, and business investment tax incentives such that the market demand for recyclables is markedly enhanced.

F. Conclusions

The burden associated with the management of solid wastes in developing countries is magnified by a chronic shortage of financial and technological resources and a dearth of qualified professionals sufficiently conversant and experienced in solid waste management. The dearth of solid waste management professionals renders the countries vulnerable to the promotional activities of purveyors of equipment that may or may not be needed, or may be ill suited to local

or regional conditions, and that represent an unwise expenditure of funds. In many cases, the burden imposed by the aforementioned purveyors is compounded by pressures exerted by bilateral aid organisations and trade agencies to accept “gifts” of inappropriate equipment and technology. These organisations represent a variety of international agencies. The burden created by purveyors and by bilateral and international aid organisations has yet another facet -- namely, the many misconceptions concocted by the international media as to which techniques would be most effective in coping with the solid waste management problem in developing countries.

Yet another facet of the burden is the urging by certain international development agencies bent upon disbursing loan monies quickly. The catch is that the loan money be appropriated in investments that involve a large foreign exchange component. However, the reality is that such loans, in some cases, are of little use in the solid waste management sector in a developing country; inasmuch as improvements do not necessarily accompany increases in capital investments. The quality of solid waste management service is better served by establishing a program characterised by good management, close supervision, broadened knowledge, superior planning, and strict cost accountability. The successful implementation of such a program demands institutional strengthening, the development of appropriate regulations, and the implementation of a comprehensive and continuous public education program. A final and essential requirement is that the local professionals be trained and assisted regarding improving the efficiency of the present system without recourse to substantial monetary investments.

G. References

1. Montgomery, J.D. and D.A. Rondinelli, eds., *Great Policies: Strategic Innovations in Asia and the Pacific Basin*, Praeger Publishers, Westport, Connecticut, USA, 1995.
2. Ortellado, J.M., “El Proceso de Decisión en el Manejo de Residuos Sólidos y Peligrosos”, presented at *Conference on Regional Cooperation for the Management of Solid and Hazardous Wastes in Developing Countries*, Lima, Peru, December 1994.
3. Jorgensen, C.H. and J.B. Jakobsen, “Municipal Solid Waste Management: Institutional and Socio-Economic Constraints - Experience from the Mediterranean Region”, *Waste Management & Research*, 12(3), 1994.
4. Ogawa, H., “Institutional Arrangements for Waste Management”, presented at UNDP/World Bank Regional Workshop on Integrated Waste Management Policies, Singapore, Malaysia, July 1991.
5. Wilson, D.C., “Waste Management in Developing Countries: Moving Towards the 21st Century”, *International Directory of Solid Waste Management, ISWA Yearbook 1994/5*, James & James Publishers, London, England, 1995.
6. Furedy, C. and M.S. Shivakumar, “Reforming Solid Waste Management Perspectives of Concerned Citizens”, presented at International Workshop on Solid Waste Management and Resource Mobilization, Kathmandu, Nepal, October/November 1990.

CHAPTER XVIII. MANAGEMENT INFORMATION SYSTEMS

A. Introduction

Information management is the process whereby data are collected and analysed for the purpose of planning, evaluating, and monitoring systems. Management information systems (MIS) play a critical role in the planning and operation of solid waste management services. One of the primary reasons for this importance is that several activities in solid waste management are empirical and do not follow a set of theoretical principles. Another reason is the fact that the quantity and composition of the wastes vary substantially as a function of time, as well as among types of generators. These variations further complicate attempts to not only evaluate but also predict the performance of a solid waste management system. Therefore, data acquisition and analysis become the principal steps for describing the operation and performance of solid waste management systems.

As a general rule, those responsible for the management of solid wastes in economically developing countries do not pay adequate attention to the use and importance of information management. Typically, evaluations of performance and effectiveness of the solid waste management system are limited to visual observations of primarily streets and disposal sites. Inadequate coverage by the collection services, uncollected solid waste, and fires and unpleasant odour generation at the disposal site typically are blamed on a lack of equipment and human resources. Rarely is a more fundamental problem considered, i.e., inefficient utilisation of available resources. Invariably, one of the most serious problems that is identified by those involved in the management of solid wastes in developing countries is an insufficient level of funds.

Acquisition of vehicles and hiring of additional employees do not necessarily result in efficient and effective utilisation of available resources. In order to establish efficient solid waste management systems, the efficacy of existing systems and subsystems must be thoroughly assessed. The results of the assessment can be used to plan and implement improved, more efficient systems.

Each of the planning and operational phases of the process requires that accurate information be collected and processed. The emphasis here is on accurate information and proper processing of the information. Unfortunately, on the rare occasions where some type of MIS has been implemented, the accuracy of the data is seldom evaluated and a large amount of data are not analysed. Consequently, the entire effort simply is wasted. In order to facilitate the collection, processing, storage, and utilisation of the data, it is necessary to implement an MIS.

The basic data for the MIS should be obtained not only from the solid waste management system but also from a variety of other sources, such as land use and economic development. In order to be useful, the data collected should be catalogued and filed in a manner that allows easy retrieval and utilisation.

During the planning process, information is utilised to establish solid waste management goals for the planning period, to determine resource requirements; and to make decisions on investments for collection, processing, and disposal services. Information on current and future population, commercial and industrial development, quantity of solid waste generated, land use, and other topics is used to estimate the levels of demand for the solid waste system and to set goals. The information is then used to develop various options to meet the goals. Based on an analysis of the options, a particular alternative is selected using criteria such as level of recycling,

waste diversion from landfill, or cost effectiveness. Using the selected option, resource requirements are determined and an investment schedule is developed.

With respect to the management of operations, information is used to evaluate the efficiency of the service and to improve the performance of the entire system. The types of data that are required include operation and maintenance history of vehicles and equipment, productivity of both equipment and workers, and expenditures.

If available, personal computers should be used to collect, process, store, disseminate, and utilise the information in planning and operational management. Information generated from actual operation of the services should be collected regularly (preferably on a daily basis) and stored on computer. Socioeconomic information relevant to solid waste management should also be collected and stored. These data are then processed to provide information in a useful form for subsequent utilisation. The processed information should be stored on magnetic media (computer disks) and printed on paper for use in planning and operational management. The use of personal computers also allows for online access to the processed information.

In addition to the operational data on solid waste management and socioeconomic statistics indicated in the preceding paragraph, information from technical publications; legal documents; and environmental data such as those required for environmental impact assessment of collection, processing, and disposal facilities should be obtained. This information should be used in planning, designing, and operating solid waste management systems. However, this type of information can be managed more effectively by a system similar to that used for the operation of a library. Therefore, it is advisable that the system for the management of literature should be developed separately from the basic MIS.

B. Evaluation of performance

The performance of a solid waste management system is a function of the amount and quality of resources allocated to carry out the services, as well as on the socioeconomic development and physical characteristics of the service area. The performance can be expressed mathematically as follows:

$$O = f(I, D)$$

where:

- O = the performance of the service,
- I = the resource inputs to the service, and
- D = the socioeconomic development and physical characteristics of the service area.

The variables related to the socioeconomic development and physical characteristics of the service area normally cannot be controlled by the authority. For instance, the width of a street could not be changed to allow passage of solid waste collection vehicles. Instead, the authority must modify its collection fleet to existing conditions in order to perform the required services.

On the other hand, the variables associated with resource inputs can and should be controlled by the authority. In fact, the success of a solid waste management system depends largely on how wisely available resources are utilised. Consequently, in order to improve the performance of its services, the waste authority should allocate available resources optimally. Resource allocation

should take into consideration the nearly continuously changing service demands and constraints due to socioeconomic development and physical characteristics of the service area.

Decisions on operational management usually are made based on the level of socioeconomic development, physical characteristics of the service area, and a predetermined total resource input. In small municipalities in developing countries, the resource input generally is dictated by the central government. Under these conditions, the authority must operate the system such that maximum performance is achieved. Based on the information presented in the equation, this becomes an optimisation problem; that is, O is to be maximised, having I and D as constants. Therefore, the authority must select a set of collection, processing, and disposal methods, among various alternatives, such that O is optimised.

In waste management planning, the desired performance (O) generally is fixed as a future goal of the plan, with the estimated level of socioeconomic development and physical characteristics of the service area (D), and the level of resources required to achieve the goal (I) at a minimum cost. Thus, the problem becomes one of optimisation of I having O and D fixed at a certain time. The minimisation of I is, therefore, a decision criterion used in the planning process.

In addition to these criteria for evaluation, a ratio of the service performance to the resource input or vice versa (i.e., O/I or I/O) can also be used for evaluating the efficiency of solid waste management systems.

In order to make these evaluation processes possible and analytical, the variables in the equation must be determined and measured. These variables generally are called indicators. The indicators typically are divided into: service performance (used to describe O); resource input (used to describe I); efficiency (O/I or I/O); and socioeconomic and physical conditions (used to describe D) [1,3].

C. Indicators

In the previous section, information required for solid waste collection and disposal services was classified into the following major categories: socioeconomic and physical condition indicators, service performance indicators, resource input indicators, and efficiency indicators. The classification was based on evaluation and decision-making processes used in planning and operational management. Unfortunately, the information required for planning is not always the same as that required for operational management. For instance, day-to-day operational instructions require timely information with respect to specific location, personnel, and equipment involved. Additionally, the instructions do not necessarily coincide with the evaluation framework discussed in the previous section. The design of solid waste processing and disposal facilities requires site-specific information that does not fit into the evaluation framework. The general indicators described in this chapter are intended mainly for use in the planning and monitoring of solid waste management systems, as well as for operational management.

A discussion of the indicators, divided by the various key phases of a typical solid waste management system (i.e., generation, storage, collection, transfer and transport, processing and resource recovery, and final disposal), is provided below. A list of specific indicators is presented in Appendix C [2].

C1. GENERATION

The indicators in this phase of the solid waste management system primarily are focused on socioeconomic and physical conditions. These indicators represent the type and level of demand for solid waste management services.

In the list (Appendix B), the indicators (excepting those that describe the administrative area and its corresponding population) represent the generators that require the collection service. Some of these wastes can be disposed properly without utilising the formal public or private collection infrastructure. For instance, the waste generated by some commercial establishments can be privately collected and transported to the disposal facility. In industrialised countries, industrial waste (particularly hazardous industrial waste) is collected, transported, and disposed of separately from other sources of waste. Consequently, as was indicated in previous chapters, it is important to clearly define the types of waste that are collected and disposed of by the municipality, or by individual households, institutions, commercial establishments, or factories, before appropriate indicators are selected.

The quantity of waste generated by each one of these sources (waste generators) is an indicator of primary service demand. These indicators can be used to estimate the quantity of waste generated under different conditions, such as a different population size and increased levels of commercial or industrial activities. Therefore, the indicators are also useful for estimating the demand for collection, treatment, and final disposal.

In addition to the quantities of wastes generated, the characteristics of the wastes (i.e., physical and chemical) provide essential information for determining appropriate management methods.

C2. ONSITE storage

As previously discussed, onsite storage is the point at which the solid waste generated is stored for eventual collection by the municipal authority or by its contractor. Onsite storage can be classified under two general categories: 1) individual storage serving the occupiers of a single dwelling, shop, or office; and 2) communal storage serving the occupiers of multiple houses, apartments, shops, or offices.

Normally, the responsibility for the acquisition and maintenance of individual storage containers rests with the owner/occupier of each unit. On the other hand, the authority usually assumes responsibility for purchasing and maintaining communal storage containers. Indicators relating to individual storage can therefore be classified as socioeconomic and physical condition indicators, while those relating to communal storage are considered to be resource input indicators.

C3. COLLECTION and transport

Indicators for collection and transport can be classified either as service performance indicators or as resource input indicators. These two general types of indicators can be used to calculate efficiency indicators.

C4. PROCESSING and resource recovery

Indicators for describing processing and resource recovery can also be divided into performance, resource input, and efficiency indicators.

C5. FINAL disposal

Indicators that can be used for final disposal are very similar to those for evaluating processing and resource recovery activities. The indicators are also divided into service performance, resource input, and efficiency indicators.

C6. ADMINISTRATION

Administrative activities do not produce measurable outputs in the service and, therefore, the type of information generated in the administrative section is not classified as a service performance indicator. One possible exception is the information generated on the type and number of complaints. This type of information is considered a service performance indicator and normally is processed by the administrative section.

The administrative section generally is responsible for activities associated with enforcement, public education, and public relations. Although these activities do not fall directly under the category of service performance indicator, they indirectly have a profound effect on the performance of the service. The information on these activities is useful for planning and operational management of solid waste management services.

D. Establishment of the management information system

Once the type of information that would be useful for the evaluation of the solid waste management service has been identified, the next task at hand is to determine the procedure for collecting, storing, processing, and distributing the information. A system in which information is collected, stored, processed, utilised, and disseminated is called an MIS. Several approaches have been suggested for the establishment of an MIS. The final form of a particular system is largely a function of the quantity of information to be collected and the level of resources (human, physical, and financial) available for the development and maintenance of the system. It is safe to assume that, in most cases, a large municipality or metropolitan area will generate more data and will, therefore, require a relatively sophisticated computerised system for information management. On the other hand, a small municipality may only require a manual system. A variety of system configurations are possible, depending upon the size of the municipality and resources available. Therefore, this chapter will not suggest a single prototype MIS; instead it will provide special considerations required for designing such a system.

D1. ORGANISATION

The first step in developing an MIS is to identify and designate the personnel who will be involved in collecting, storing, processing, and disseminating the information. In most cases, personnel that are actually working in the field are requested to either generate or collect data that are obtained through some type of reporting system. The data are then stored, processed, and disseminated by staff in the administrative section. However, the personnel who will be participating in the process, and the manner by which the information is to be transmitted from one staff member to another, depend on how the solid waste management system is organised in the municipality.

Large municipalities generally are divided into districts. In turn, personnel assigned to the districts are responsible for providing waste collection services. Processing and final disposal facilities usually are sited throughout the municipality and are utilised by more than one district. Processing and disposal facilities, therefore, do not normally belong to a specific district, but are part of the entire system. In such a situation, the information generated in the field is collected, stored, processed, and utilised for action at the district offices and the information relevant to processing and disposal is assigned to the municipality's headquarters.

Small municipalities normally have only one office responsible for the management and implementation of the waste management service; that office is responsible for collecting information from solid waste collection crews, as well as from personnel at processing centres

and disposal facilities. The office also is responsible for storing, processing, and using the information in the decision-making process.

In some municipalities, solid waste management is carried out by more than one agency. For instance, equipment maintenance is performed by the operations maintenance department, while the collection system may be the responsibility of the health department. In such a case, equipment maintenance records and information on spare parts, downtime, human resources input, and others should be transmitted from the operations maintenance department to the health department for monitoring performance and for the scheduling and purchasing of collection vehicles. This information also is required to evaluate the overall efficiency of the collection service. In designing an MIS for this municipality, both departments should be required to have individual, but compatible, management information systems.

D2. DATA collection

There are various methods for collecting data. Data can be collected from existing sources, by conducting special surveys, by taking measurements, or through regular reporting mechanisms. Of the indicators given in Appendix C, the information on most socioeconomic and physical condition indicators (such as administrative area, population, the number of households, and commercial/business establishments) normally is available from the municipal departments responsible for urban planning and public works. Therefore, such information should be collected from those agencies and should be frequently updated.

Waste characterisation surveys, such as those described in Chapter III, should be carried out to collect information on generation rates, physical composition, bulk density, and storage indicators. Physical and chemical characteristics of the wastes, such as calorific value and chemical composition, are determined through laboratory analyses. If these types of data are required, it is important to determine the capabilities and experience of the laboratories such that reliable data are obtained.

Information on the indicators for collection, transport, processing, resource recovery, final disposal, and administration can be obtained from the respective services through a regular reporting system.

D3. STORAGE and processing

Storage and processing of the data can be performed either manually or electronically. A manual system consists of first labelling and cataloguing the information, followed by an accurate procedure of filing and analysing it.

The development of personal computers has been such that they have become accessible to many institutions and individuals in developing countries. The use of personal computers for information management has become practical and popular due to increases in memory and storage capacities, as well as increasingly affordable prices. In addition, there are various commercially available software packages for general-purpose data management, such as spreadsheet and database management. These packages can easily be applied to municipal solid waste services. Other advantages of using computers include the capability of producing graphs, tables, and maps, and the ease in transferring information (networking), e.g., between departments.

In a municipality where a computerised MIS has already been developed or is in the process of being developed for general accounting or other purposes, the MIS for solid waste management planning and operations should become part of the overall computerised system as a subsystem.

Once this linkage is established, information can be shared among various departments in the municipal government.

E. Conclusions

A large amount of data is used for planning, designing, and operating municipal solid waste collection, processing, and disposal services. Due to the diversity of situations throughout the world, and in many cases within a particular country, it would be difficult to design a single MIS that would be capable of satisfying the needs of all solid waste management functions. Instead of proposing a comprehensive prototype MIS that would be applicable to most situations, in this chapter we suggest that a simple system tailored to local conditions be established with available resources and information specific to the locality. The system should be flexible and capable of expanding, as more resources are made available.

Using this approach, a series of indicators that can be used to evaluate the performance of solid waste management services has been presented. In addition, a general methodology for establishing an MIS has been proposed. It must be emphasised that, due to space limitations, a number of indicators that are useful for certain decision-making processes in waste management have not been extensively covered. These indicators include literature information, environmental data, and various design parameters. As previously discussed, these indicators cannot easily be incorporated into the MIS proposed in this chapter.

Finally, this chapter presents an MIS that would be utilised by municipal government officials and does not describe the type of information that would be required by a national agency.

F. References

1. McFarland, J.M., C.R. Glassey, P.H. McGauhey, D.L. Brink, S.A. Klein, and C.G. Golueke, *Comprehensive Studies of Solid Wastes Management*, Final Report, Sanitary Engineering Research Laboratory, College of Engineering and School of Public Health, University of California, Berkeley, California, USA, SERL Report No. 72-3, May 1972.
2. Sakurai, K., *Improvement of Solid Waste Management in Developing Countries*, Institute for International Cooperation, Japan International Cooperation Agency, Technical Handbook Series, Vol. 1, December 1990.
3. World Health Organization, *Information Management for Municipal Solid Waste Management Services*, Western Pacific Regional Environmental Health Centre, Kuala Lumpur, Malaysia, March 1992.

Appendices

APPENDIX A. PUBLIC HEALTH ASPECTS

Rising urban population growth, limited municipal resources, and the complexity of municipal solid waste management (MSWM) in both industrialised and developing countries have complicated the relationship between environmental management and the health of urban inhabitants. The combined effects of casual disposal of wastes, insufficient waste collection service, and inadequate waste disposal facilities have always had serious, adverse implications for public health. Among these are the direct transmission of diseases and the spread of epidemics, degradation of the quality of the urban and natural environments and, most importantly, the social reinforcement of poor hygienic habits and practices, all of which compose a vicious cycle.

The inclusion of hazardous waste, health care waste, and excreta (although in small quantities) in the urban waste stream complicates the search for practical responses to the problem of maintaining the health of the public. For example, the potential spread of AIDS, SARS, and other infectious diseases through the discharge of health care wastes into the general urban waste stream is a continuous and growing threat. The implications of inadequate municipal waste management upon the health of the public are serious and they cannot be ignored.

This appendix focuses on the public health implications of generating, collecting, processing and disposing solid waste in developing countries, and on methods of managing the risks to the health and safety of the general public and of the personnel involved in collection and disposal of solid waste. The approach adopted for this discussion is to follow the various key stages, from generation through final disposal of municipal solid waste (MSW), and in the process to discuss common public health impacts on both the public and on the workers who directly handle the wastes. The impacts on the environment in general are mentioned where relevant. Some attention is also given to the topic of special and hazardous wastes.

A. The nature of municipal solid waste

From the public health point of view, MSW can be divided into three categories, with subcategories that are based largely on their sources and/or processes of generation: 1) domestic wastes; 2) special and hazardous wastes; and 3) other wastes, as shown in Table A-1. While most of these wastes could be isolated at the source of generation and managed in a rational way, in practice, the municipal waste stream is usually a mixture of two or more of the categories. This is the reality of most developing countries and some of the emerging or transition economies of Central Asia and Eastern Europe, where waste management systems have generally broken down.

Table A-1. Waste categories with potential public health impacts

Category	Description
Domestic wastes	General household wastes with used batteries and drugs containers, street sweepings with small quantities of excreta
Special and hazardous wastes	Health care waste (sharp and infectious components), toxic chemical, pharmaceutical, and other industrial wastes, as well as radioactive wastes
Other wastes	Untreated abattoir waste, construction wastes with asbestos components, and sludges from wastewater treatment plants

B. Potential health impacts in the waste cycle

Public health impacts of MSW can occur along all stages of the waste cycle. Mismanagement of waste at each point along the cycle has the potential of introducing both short- and long-term adverse health impacts; these call for serious attention. Groups at risk from adverse public health impacts associated with MSW are listed in Table A-2. Some types of potential health impacts associated with solid waste are discussed below.

Table A-2. Groups at risk from adverse public health impacts associated with MSW

- The population of unserved areas, especially pre-school children and the elderly
- Waste operators and scavengers
- Workers in facilities that produce infectious, toxic, and cancer-causing materials
- People living close to waste facilities
- The population supplied with water polluted by waste dumping or by inadequately protected landfill sites

B1. GENERAL

The first type of health impact is accidental injuries, such as cuts and punctures from sharp objects in the waste. Workers and other persons who manually collect and process solid waste regularly are especially at risk. Fires in collected and disposed waste also represent potential health and safety hazards to workers as well as the public. Another hazard is that which manifests itself when large volumes of disposed waste become unstable and, in the process, collapse and bury workers, scavengers, or shacks on or near the site containing their inhabitants. Small amounts of hazardous chemical waste in garbage may result in accidental injuries, but may also lead, in some extreme cases, to poisoning. Also, some cases are on record of children playing with radioactive waste illegally collected from health care facilities and land disposed, with the eventual result that the children contract cancer.

The second type of health impact is infections caused by exposure of humans to solid waste or its products of decomposition. Blood borne infections such as tetanus, resulting from injuries caused by infected sharp items in the waste, are common. Ophthalmologic and dermatological infections from exposure to contaminated dust are also possible. Enteric infections may result from accidental ingestion of waste, but more often such infections occur from drinking water from unconfined aquifers or nearby streams polluted by leachate from waste, from consumption of raw vegetables produced on fields irrigated with contaminated leachate from waste piles, and from eating food in garbage. Worm infestation among children results mainly from direct contact with human excreta. Infections may also be transmitted through rodents and insects feeding on waste and acting as passive carriers of disease germs. Many tropical diseases transmitted by vectors such as mosquitoes have their origins in breeding ponds created by indiscriminate waste disposal. Zoonosis, a disease carried by stray, wild, and scavenging animals feeding on waste, is also reported in many parts of the world.

B2. GENERATION and storage

The production and storage of waste represents the first points of physical contact and other routes of exposure between the waste and humans or the environment. The exposure and potential for adverse human health risks are particular concerns in the case of special or hazardous waste, especially during the production of industrial products with toxic byproducts. While the risk is generally less in the case of generation and storage of domestic solid waste, the inclusion of

relatively small quantities of infectious and toxic waste, such as bottles containing hazardous types of pharmaceutical products, photographic material, batteries, infectious health care wastes and sharps (e.g., syringe needles and scalpels), excreta, and other such substances, can turn seemingly benign domestic waste into potentially dangerous waste, with attendant serious public health impacts.

Storage of waste can also lead to adverse public health effects by: 1) creating fertile grounds for the breeding of household pests; 2) animals feeding on the waste; and 3) obstructing natural drainage channels, leading to the formation of ponds that then serve as breeding grounds for insects and other carriers of human pathogens. Backyard dumping or storage of waste often creates noxious odours that results from decomposition of biodegradable materials, and breeding grounds for insects and rodents that are potential carriers of infectious diseases.

B3. WASTE recovery, recycling, and reuse

In developing countries, scavenging is widely practiced and socioeconomic conditions do not allow its abolition or prohibition. Scavengers are extremely vulnerable because they belong to one of the most underprivileged groups of the population and are most often illiterate. They are exposed to serious health hazards from waste and are also exposed to social and economic abuses from waste recycling traders. In some cities, scavengers live in shacks built on the disposal sites. Some may be born, live, work, die, and be buried in the dump. Street children very often survive by scavenging materials from waste set out for collection. Health surveys have shown that the health status of scavengers is very low, and that they suffer from infections, including persistent skin infections. Their life expectancy is far below the average in their respective countries.

Scavengers may be protected in the same way as regular solid waste crews, but in low-income countries, occupational health and safety services are most often deficient for such crews, and scavengers can expect none of those services. However, the scavenger's situation may be improved if they are organised and receive assistance to improve both working conditions and their housing and sanitation, as the Zabbaleen communities in Cairo, Egypt have demonstrated.

B4. COLLECTION and transfer

One important hygienic requirement in public health is that all MSW produced, even in low-income areas, be collected and removed from the point of generation. These sanitation activities minimise or eliminate the potential of humans coming into direct contact with putrefying waste. If uncollected garbage piles up in human settlements, inhabitants will be exposed to direct health impacts. Domestic solid waste properly handled at home but inadequately stored prior to collection will also expose people to negative health impacts.

In cities of low-income developing countries, local governments are often unable to collect most of the MSW produced in their cities. Collection coverage below 50% is common for several cities, which means that there is practically no collection in low-income neighbourhoods. This situation results in waste piling up in those neighbourhoods. All inhabitants of unserved settlements are exposed to direct contact with waste, but pre-school children are the most exposed, as they seldom move out of their neighbourhood and are more likely to play around the uncollected waste heaps.

The organic fraction of uncollected waste undergoes uncontrolled fermentation, which creates conditions favourable to the survival and growth of microbiological pathogens, especially if wastes are mixed with human excreta due to lack of proper and adequate sanitary facilities. If the waste undergoes anaerobic fermentation, methane gas, which is combustible, is generated, which with a source of ignition can expose humans to fire, smoke, or even an explosion. Organic waste

is also the feeding stock and natural environment for insects and rodents, which are potential carriers of enteric pathogens. Such waste is also ideal for feeding and harbouring stray and scavenging animals -- potential carriers of zoonosis. Uncollected waste might also contain sharp objects, which are potential sources of infective wounds, and also small amounts of hazardous chemical waste.

Finally, inadequate collection of waste means open and indiscriminate dumping. One public health consequence of open dumping can be obstruction of stormwater runoff. This results in flooding and creation of ponds during the rainy season, which become habitats and breeding places for waterborne vectors of tropical diseases. Helminths, such as hookworm, survive on soil polluted by waste and will infect barefooted people. Waste collection or disposal operators are exposed to direct impacts from waste. Solid waste workers are particularly vulnerable because of their low educational status, and are therefore difficult to reach by health education and preventive actions. As shown in Table A-3, waste workers are exposed to a multitude of health hazards that result from direct handling of and contact with waste.

The most practical public health problems arising from transfer and transportation of waste are related to improper safeguards in the transfer or transportation process. Uncovered transportation vehicles or containers cause littering of the waste and the possible spread of airborne contaminants; leachates from trucks used for transportation are another source of pollution. Worst-case scenarios are en route accidents that result in ground and surface water contamination. The choice of low-risk transportation routes is very important.

Table A-3. Occupational hazards associated with waste handling

<p><i>Accidents</i></p> <ul style="list-style-type: none"> ● Muscular-skeletal disorders resulting from the handling of heavy containers ● Wounds, most often infected wounds, resulting from contact with sharp waste ● Intoxication and injuries resulting from contact with small amounts of hazardous chemical waste collected with garbage ● Trauma, burns, and other injuries resulting from occupational accidents at waste disposal sites, or from methane gas fires or explosions at landfill sites <p><i>Infections</i></p> <ul style="list-style-type: none"> ● Dermal and blood infection resulting from direct contact with waste and from infected wounds ● Ophthalmologic and respiratory infections resulting from exposure to infected dust, especially during landfilling operations ● Zoonosis resulting from bites by wild or stray animals feeding on wastes ● Enteric infections transmitted by insects feeding on wastes <p><i>Chronic diseases</i></p> <ul style="list-style-type: none"> ● Incineration operators are especially exposed to chronic respiratory diseases resulting from exposure to dust, to toxic and carcinogenic risks resulting from exposure to hazardous compounds, to cardiovascular disorders and heat stress resulting from exposure to excessive temperature, and to loss of hearing function due to exposure to excessive noise
--

B5. TREATMENT and disposal

Waste treatment and disposal facilities have the potential to create health hazards for waste workers; they also create health hazards and nuisances to populations living in their vicinity. For

this reason, the location of such facilities reasonably far away from human habitat is desirable. Waste disposal facilities also create wide-ranging environmental impacts. The most significant of these indirect impacts are groundwater pollution by leachate generated as a result of uncontrolled land disposal of waste, and air pollution caused by uncontrolled incineration of waste.

Waste disposal operators, scavengers, and occasional visitors to solid waste facilities are exposed to infectious wounds, inhalation of infected dust, skin contact with infected material, bites from disease-transmitting insects or animals, and burns or injuries from many kinds of accidents (see Table A-3).

These accidents may result from the movement of trucks and bulldozers on the site, from spontaneous fires started inside the waste, from methane gas explosions inside or adjacent to land disposal sites, or from the slides of unstable slopes. Nearby populations are exposed to high noise levels from disposal operations, to air pollution from dust and smoke produced at the dump, to strong odours, and to infective bites from animals and insects that live and breed on the dump. Human habitation should thus not be permitted close to treatment and land disposal sites. Unfortunately, scavengers and their families tend to build their domiciles very close to if not on waste disposal sites; their removal may be a very sensitive issue. An example is the lengthy negotiation over the closure of the "Smoky Mountain" dump in Manila, Philippines.

The above-listed hazards may be mitigated by the practice of modern sanitary landfilling, discussed in the main body of this publication. Due to modern landfill design and operation, odours, dust emissions, fires, the proliferation of insects, rodents, and stray animals, and other impacts are controlled.

B5.1. Composting and reuse

Composting and reuse are largely environmentally friendly operations; however, if improperly carried out, they may generate some health hazards. Workers at composting facilities, when poorly protected, are exposed to infection from dust inhalation and to infective wounds from sharps. They are also exposed to occupational accidents during waste shredding operations. In developing countries, farmers working barefoot are exposed to infective wounds from small sharps included in poorly processed compost.

Separate collection of even small quantities of hazardous waste can expose poorly protected or poorly trained workers to health and safety hazards. These hazards may be infectious or toxic. Recycling of non-disinfected infectious waste represents serious health and safety risks to both operating personnel and the public. Discarded medical equipment such as syringes and scalpels should not be reused. Precautions should be taken such that these items are prevented from entering the waste stream where there is potential for contact by scavengers plying their trade.

The indiscriminate reuse of contaminated containers, particularly for the storage of drinking water, beverages, and food items, can lead to health and safety issues.

B5.2. Incineration

Proper siting and proper emission control facilities are very important in limiting exposure of humans to air pollution produced as a result of incineration of solid waste, particularly in densely inhabited, large cities.

Besides air pollution, environmental impacts of incinerators result from the need to dispose of bottom ash, fly ash, and wastewater produced by exhaust gas cleaning processes. Fly ash and acidic wastewater from gas cleaning systems are hazardous chemical wastes. Incinerator

operators are exposed to occupational and industrial accidents. They are also exposed to high levels of noise, temperature, and air pollution.

Nearby populations will not only be exposed to the consequences of any industrial accidents, but also to significant levels of noise and air pollution. The best way to protect the public from incinerator air emissions is to limit settlements to beyond the boundary of minimally acceptable air quality. The determination of this boundary requires qualified and experienced professionals to analyse many issues, including types and levels of emissions emitted at the facility and dispersed downwind, meteorological conditions, applicable routes of human exposure, and types of health risks. The public may also be affected by water pollution if ash and wastewater from the incinerator are not properly treated and disposed. Many industrialised countries, as well as the European Union and the Nordic Council, are enforcing standards limiting incinerator emissions; those standards cover HCl, HF, particulates, NO_x, CO_x, SO_x, Pb, Cd, Hg, As, Zn, dioxins, furans, and other compounds.

Ash from incinerators has been reused in civil engineering works. However, in industrialised countries, the most prevalent method of management is disposal of the ash in lined landfills to control the risk of underground pollution by soluble toxic chemicals leached out of the ash. Both fly ash and bottom ash contain chemical constituents that pose potential serious risks to operating personnel and the public. The chemical constituents of concern include heavy metals, dioxins, and furans. Fly ash in particular tends to be very hazardous because of its fine particulate size distribution and the fact that heavy metals and other non-combustible toxic chemicals in the waste are concentrated in the mass remaining after combustion of the waste. Proper methods of transporting, treating, and disposing of bottom and fly ash are required to minimise health and safety risks to both operating personnel and the general public.

Untreated wastewater produced by incinerator gas cleaning systems is highly acidic. To protect both the public and the environment, this acidity must be neutralised with alkali before discharging such wastewater into any sewer system for treatment. Under no circumstances should the effluent be discharged into the environment without prior treatment.

B5.3. Open dumps and landfills

Dumps and landfill sites can have a substantial impact on both surface and groundwater quality, with subsequent potential health hazards for people who depend on such resources for subsistence. Rainwater runoff from poorly designed and operated landfills or from open dumps can reach nearby streams after having been heavily polluted through contact with waste. However, the most serious threat usually is that associated with leachate generated within the waste and its subsequent infiltration into unconfined aquifers below or adjacent to disposal sites. This results in chemical and viral pollution of groundwater. The health hazard from polluted groundwater is far greater than from polluted surface water, because rural populations around the landfill may drink from shallow wells without treating the water. Even if the well water or surface water source is subjected to treatment, the treatment may not be effective against some of the chemical pollutants contained in leachate produced from solid waste.

To protect surface water quality, it is necessary to prevent water flowing over or infiltrating through waste before reaching the surface source. Proper location and design and operation of land disposal facilities is required in order to minimise the risk of pollution of ground and surface waters by solid waste leachate.

Communities near the disposal sites also are impacted by the traffic in and out of the facility.

C. Special and hazardous wastes

In most communities in the developing world, small amounts of infectious material, sludge, sharps, chemical waste, and waste with high heavy metals content are regularly collected together with normal municipal waste. These categories of wastes create special health hazards for waste management operators, scavengers, and eventually the general population. While exposure to solid waste is frequent in poor neighbourhoods, the quantities of hazardous waste that are present in the waste are usually low. On the other hand, people in wealthy neighbourhoods tend to use more chemical consumer products and store medical products at home. The likelihood, therefore, of the presence of small amounts of hazardous waste in their garbage is high.

C1. INFECTIOUS waste

Infectious waste generated from health care activities performed in hospitals, veterinarian offices, and small clinics are most often disposed together with regular garbage. This situation can create particularly serious health hazards, of which the transmission of viral blood infections (such as AIDS and hepatitis B and C, through wounds caused by discarded syringe needles) is but one example.

C2. HAZARDOUS chemicals

Chemical consumer products used at home are often hazardous; they may be flammable, reactive, or corrosive, or they may be toxic and carcinogenic. At home, these products should be stored in a safe place, out of reach of children. If stores of domestic chemicals are adequately managed, the resulting waste will be only the packaging, with residues of chemicals, and it will be acceptable to dispose those small amounts of hazardous waste in the garbage container. Unfortunately, oftentimes a large quantity (e.g., a half-full bottle) of hazardous chemicals, whether solvents, pesticides, or varnish, finishes in the garbage container. The collection, handling, and improper disposal of even small amounts of dangerous chemicals represent substantial hazards to the health and safety of both the waste generators and the waste collectors.

D. Suggested public health and occupational safeguards

D1. OVERVIEW

From the information presented in the preceding sections, it is clear that adverse health impacts can and do result along the whole cycle of the MSWM process. A proper understanding by municipal waste managers and workers of the health and safety impacts associated with solid waste and the methods of exposure is the basis for confronting these problems. Three generic types of waste-linked health impacts have been identified, as summarised in Table A-4: 1) injuries and exposure to chronic diseases; 2) bacterial, viral, or parasitic infections; and 3) indirect creation of endemic conditions for specific tropical waterborne diseases.

From the lists of impacts, the conclusion can be drawn that safe handling and appropriate disposal of all municipal waste streams are paramount in ensuring a healthy living environment. Given the poor state of the economies of most developing countries and the sheer magnitude of their waste management problems, only strategies based on incremental improvements to the existing situation are practical in most cases.

E. Hygienic requirements at home

Any solid waste produced at home must be collected and stored in a safe container. Organic waste must not be kept indoors for more than 48 hours in a warm climate, or 5 days in a cool

climate. Containers for storing waste are best placed outdoors or in a space dedicated only to waste storage. Any infectious waste, sharps, or chemical waste must be properly packed before being put in storage containers. Large quantities of highly hazardous chemical waste, such as solvents, should not be put in domestic waste containers, but should be labelled, packaged properly, and stored separately for collection and disposal.

Garbage chutes must be avoided or bypassed in low-cost, high-rise apartments when regular maintenance is uncertain, because waste will accumulate. Existing chutes and indoor waste storage rooms of apartment houses must be kept clean and periodically disinfected. Visual evidence of insects and rodents in the building is an indicator of mismanagement of waste.

Urban populations must be educated in hygienic waste management at home and in the neighbourhood. Community leaders in low-income settlements must be motivated to contribute to hygienic waste management in their neighbourhood. Selection of safe and appropriate garbage containers in developing countries is not always easy. Uncollected waste from suburban areas may be temporarily managed by either recycling on the plot or buried onsite, but every effort must be made to put in place an appropriate collection system for all sections of the population.

Table A-4. Summary of waste-linked diseases and conditions, with their causes or pathways of transmission

Injuries and chronic diseases

- Cuts and infective wounds from sharp waste
- Burns and respiratory trauma from burning waste
- Trauma from collapses of large volumes of disposed waste
- Burns or wounds from hazardous chemicals in waste
- Toxication and cancers from exposure to hazardous waste
- Chronic respiratory diseases from exposure to dust

Bacterial, viral, or parasitic infections

- Bacterial (tetanus, staphylococcus, streptococcus) or viral (hepatitis B, AIDS) blood infections resulting from injuries caused by infectious sharp waste
- Eye (trachoma, conjunctivitis) and skin (mycosis, anthrax) infections from waste-generated infected dust
- Respiratory infections (bacterial or viral pneumonia) from exposure to waste-generated infectious dust
- Vector-borne diseases, viral (dengue, yellow fever) or parasitic, (malaria, filariasis, schistosomiasis), transmitted by vectors living or breeding in waste-generated ponds; and worm infestation, transmitted by contact with polluted soil (hookworm)
- Bacterial (cholera, diarrhea), viral (dysentery), or parasitic (helminthiasis, amoebiasis, giardiasis) enteric diseases, transmitted:
 - by insects and rodents feeding on wastes
 - by accidental ingestion of waste food
 - through drinking water contaminated by leachate from waste
 - through eating food contaminated by leachate from waste
- Zoonosis carried by stray animals and rodents feeding on waste (rabies, plague, leishmaniasis, hydatidiasis, tick-borne fevers)

Tropical diseases transmitted by waterborne vectors in urban areas

- Malaria transmitted by anopheles mosquitoes
- Dengue and yellow fever transmitted by aedes mosquitoes
- Filariasis (Bancroftian) transmitted by culex mosquitoes
- Schistosomiasis harbored by bulinus and other snails

F. Hygienic requirements in the neighbourhood

As a primary goal, all municipal waste generated in any neighbourhood should be collected and removed promptly for proper disposal. Garbage and organic municipal waste must be collected prior to reaching an advanced stage of fermentation; this stage is indicated by strong odours.

Suggested collection frequencies that are consistent with good sanitation practice are listed in Table A-5. These collection frequencies should be goals. It is recognised that limitations of human and financial resources in developing countries may limit the ability to achieve the goals. A range of values is given in the table for each type of climate because waste stored in tightly

closed containers can be collected less often than waste stored in open containers, exposing them to the elements and vectors.

Table A-5. Collection frequencies commensurate with good sanitation practice

Area	Collection Frequency
Tropical countries	Daily or every other day collection
Warm-temperate countries	Every two or three days in summer, every three or four days in winter
Cool-temperate countries	Once or twice a week in summer, once a week or biweekly in winter

If waste containers are handled manually, their size and weight should be limited to avoid muscular-skeletal disorders among waste collectors. The use of 200-L drums should be avoided. Waste containers with tight fitting lids should be used to store waste for collection, thus serving as a deterrent to human or animal intrusions, and minimising exposure of the waste to precipitation. The highest safety level is reached through the use of closed and puncture-resistant garbage containers. The use of plastic bags for storage of waste is risky to the solid waste personnel, who may be exposed to protruding sharps, etc. during the collection activity, and is problematic because the bags can be punctured or opened when handled by the collector or by rodents and stray animals. Populations of domestic stray or wild animals must be controlled in urban areas to prevent zoonosis and to avoid damage to waste containers such as plastic bags, with subsequent spreading of garbage on the roadway. Any waste spread on roadways must be removed by street cleaning operations.

G. Occupational health and safety requirements

To reduce the risks listed above, waste workers must wear protective clothes, boots, and gloves. At waste disposal sites, facemasks or simple scarves wrapped around the face should be used. Incinerator operators must also be protected against excessive noise and temperature. Waste workers should receive health education and be trained in accident prevention and emergency measures. They should have access to showers and cleaning facilities after their work shift and be immunised against tetanus and hepatitis B. Periodic medical examinations or screening should also be carried out on waste workers.

Where affordable, there should be separate collection of domestic chemical waste and waste with high heavy metal content, such as batteries, broken thermometers, and infectious and other toxic health care wastes. Used syringes should be packed in tamper-proof, puncture-resistant plastic containers or metal containers before being placed into a trash container. In countries and health care facilities that can afford it, segregation and separate collection of infectious waste should be employed to reduce to a minimum the quantities of infectious waste that require management and to render the waste more suitable for disinfection or sterilisation at a designated infectious waste disposal facility.

Waste managers in developing countries may also wish to use chemical encapsulation to encapsulate and immobilise discarded sharps, and to serve as a form of protection against the risk of injury and infection to humans. In this process, sharps are placed into a metallic barrel or a tough plastic drum. When this container is approximately 70% full, fluid cement mortar is poured into the container until all of the sharps are engulfed. After the mortar has solidified, the sharps are immobilised and the container may be disposed in a landfill. After a few weeks, due to natural mortality of microbiological pathogens, the sharps so treated will have lost their infective nature.

In case hazardous waste or health care wastes are intended for composting, it is necessary to collect the biodegradable materials separately or to carefully monitor for and segregate any hazardous chemical waste or infectious waste that could adversely affect the bacteriological processes during composting and/or the characteristics, quality, and use of the compost. These admonitions limit the exposure of the compost facility operators, the public, and the environment to dangerous and toxic waste. The segregated hazardous waste and infectious waste must then be properly collected, treated, and disposed.

H. Management framework for the minimisation of health impacts

Since many serious public health problems are directly or indirectly related to poor management of solid waste, good solid waste management practice serves to protect the public health and, therefore, the overall well being of communities. Consequently, the first two priorities should be to ensure: 1) complete coverage of the population by an appropriate and efficient municipal waste collection service, and 2) proper disposal of the collected waste in a suitable processing or disposal facility.

During the planning and implementation of the first two priorities, those in charge of waste management should also develop occupational health and safety procedures and services for solid waste workers, including not only waste collection and disposal operators but also scavengers.

The only rational way of dealing with the public health aspects in a comprehensive way is to put the health impacts into a strategic planning context for the overall MSWM system. In this way, planning can take due cognisance of causalities and mitigation measures required to prevent the adverse impacts from occurring in the first place. A comprehensive public health impact assessment should be made at the project design stage, either separately or as part of the environmental impact assessment. The process should be repeated every five years to keep track of unforeseen developments and to establish the information base for rational decision-making in the future. In the final analysis, public education and consciousness raising should be the cornerstone of any mitigation effort.

I. Bibliography

1. *Management of Solid Waste in Developing Countries*, WHO/New-Delhi, 1974.
2. *Solid Waste Management*, selected topics, WHO/Copenhagen, 1985.
3. *Emissions of Heavy Metals and PAH from Municipal Solid Waste Incinerators, Control Technology and Health Impact*, WHO/Copenhagen, 1989.
4. *Urban Solid Waste Management*, published by IRIS, Florence, Italy, on behalf of WHO/Copenhagen, 1991.
5. Giroult, E., et al., *International Source Book on Environmentally Sound Technologies for Municipal Solid Waste Management*, Appendix 1, UNEP, Osaka, Japan, 1996.

APPENDIX B. CHARACTERISTICS OF COMPOSTED YARD WASTE

Table B-1. Concentration of soluble metals in yard waste compost (saturated media in mg/kg)

Metal	Site 1 ^a	Site 2 ^b
Calcium	50	59
Magnesium	16	23
Iron	3.70	3.70
Manganese	0.80	2
Zinc	0.14	0.17
Copper	0.08	0.07
Boron	0.20	0.20
Sulphur	12	6
Sodium	21	31
Aluminium	4.80	3.30

Source: *Portland Area Compost Market Study*, Final Report, prepared by CalRecovery, Inc. for the Metropolitan Service District, Portland, Oregon, October 1988.

^a One sample.

^b Average of seven samples.

Table B-2. Concentrations of pathogens found in yard waste compost

Pathogen	Site 1	Site 2
<i>Salmonella</i>	negative	negative
<i>E. coli</i>	$> 1.0 \times 10^3$	$< 1.0 \times 10^4$
Faecal coliform	2.3×10^3	9.3×10^4
Total coliform	1.4×10^3	3.0×10^5
<i>Pseudomonas</i> spp.	positive	positive

Source: *Portland Area Compost Market Study*, Final Report, prepared by CalRecovery, Inc. for the Metropolitan Service District, Portland, Oregon, October 1988.

Note:

1. *Aspergillus fumigatus* (rhizopus and geotrichum found), human parasitic ova, dog parasitic ova, *Entamoeba coli*, *Entamoeba histolytica*, *Ascaris lumbricoides* (roundworm), *Taenia* spp. (tapeworm), and *Trichuris trichuria* (hookworm) not found in either site.

Table B-3. Nutrient content and other parameters of yard waste compost

Parameter	Units	Site 1	Site 2
Total (Acid Digestion) CEC^a	meq/100g	26.8	28.2
Nitrogen	%	0.90	0.63
Sulphur	%	0.26	0.20
Phosphorus	%	0.16	0.14
Potassium	%	0.72	0.62
Water Soluble			
Nitrogen	ppm	2.0	< 1.0
Sulphur	ppm	12.0	6.0
Phosphorus	ppm	143 ^b	121 ^c
Potassium	ppm	3,132 ^b	2,604 ^c
NH ₄ -N	ppm	21 ^b	20 ^c
NO ₃ -N	ppm	6 ^b	4 ^c
Bulk Density	kg/m ³	353 ^b	431 ^c
Moisture Content	%	48.5 ^b	48.9 ^c
Organic Matter	%	67.3 ^b	64.5 ^c
pH		7.1 ^b	6.7 ^c
Specific Conductance	mmho/cm ^d	1.4 ^b	1.4 ^c
Particle Size			
9.5 mm	% passing	94.2 ^b	95.0 ^c

Source: *Portland Area Compost Market Study*, Final Report, prepared by CalRecovery, Inc. for the Metropolitan Service District, Portland, Oregon, October 1988.

^a CEC = cationic exchange capacity, expressed in miliequivalents (meq) exchangeable cations per 100 grams of dry soil.

^b Average of eight samples.

^c Average of five samples.

^d mmho/cm = millimho per centimetre.

APPENDIX C. PERFORMANCE INDICATORS FOR SOLID WASTE SERVICES

A. Generation

A1. DEMOGRAPHIC information

- administrative or political area (area bounded by the administrative boundaries of the municipality in km²)
- service area (area requiring solid waste management services in km²)
- total population in the administrative area
- population in the service area
- number of households, commercial establishments, and institutions (e.g., schools, public libraries, religious buildings, hospitals) in the service area
- number of parks and other public places in the service area
- number of markets in the service area
- number of factories in the service area
- length of roads and streets requiring sweeping (km)
- length of drains requiring cleaning (km)

A2. QUANTITIES of waste generated

- household
- commercial/business
- institutional
- park/public
- market
- street sweeping
- drain cleaning
- industrial
- total waste

Generally, waste generation (by source) is expressed in terms of daily wt/unit. Therefore, the indicators presented in the previous paragraph can be expressed as:

- household waste (kg/cap/day)
- commercial waste (kg/x/day, where x can be m² of floor area of commercial establishment, unit volume or dollar value in sales, number of employees, etc.)

- institutional waste (kg/x/day, where x can be number of students, m² of the area of park or public place, number of visitors, etc.)
- market waste (kg/x/day, where x can be the number of market spaces, m² of floor area, dollar in sales, etc.)
- industrial waste (kg/x/day, where x can be unit volume or dollar of production output, m² of floor area, number of employees, etc.)
- street sweeping waste (kg/km/day)
- drain cleaning waste (kg/km/day)
- total waste (kg/cap/day)

B. Waste characterisation

B1. PHYSICAL composition (% wet or dry wt basis)

- putrescible matter
- bones
- paper
- plastics
- yard/garden
- wood
- glass
- metals
- rubber and leather
- miscellaneous inert material

B2. CHARACTERISTICS

- moisture content (%)
- bulk density (kg/m³)
- higher and lower calorific values (kcal/kg)
- chemical composition (N, C, P, Ca, K, etc.)

C. Storage

C1. INDIVIDUAL containers

- type (e.g., bin, bag, basket)
- size or capacity (L)
- material (e.g., plastic, metal, bamboo)
- maintenance condition

- number and location of storage units (on a map)
- cover or lid
- use of standardised containers (%)

C2. COMMUNAL receptacles

- type (e.g., bin, bag, basket)
- size or capacity (L or m³)
- material (e.g., plastic, metal, wood, bamboo)
- number and location (on a map)
- maintenance condition
- cover or lid
- maximum distance from house (m)
- average lifespan of container

C3. COST

- purchase cost of individual container (cost/ container)
- purchase cost of communal container (cost/ container)
- repair cost of communal container (cost/ container/yr)

D. Collection and transport

D1. SERVICE performance indicators

D1.1. Coverage

Indicators are shown in the following list for household waste only. Similar indicators could apply to the other categories of waste.

- household waste collected (area in km² or % of the service area; population or % of the population; number of houses or % of the number of houses; quantity or % of household waste generated in the service area)
- commercial/business waste collected
- institutional waste collected
- park/public place waste collected
- market waste collected
- street sweeping waste collected
- drain cleaning waste collected
- total waste collected

In localities where solid waste is collected and transported by contractors and/or by private individuals or institutions, the following indicators can be used:

- number of contractors
- population or number of houses or establishments served by contractors or by private haulers for each category of waste
- percentage of population or number of houses or establishments served by contractors or by private haulers for each category of waste
- the quantity of waste collected by contractors or private haulers for each category of waste

D1.2. Frequency

Collection frequency varies from more than once a day to once a week, or even less frequently. Indicators relating to collection frequency can be actual collection frequency or the percentage of the actual to the required collection frequency. This information can be arranged according to generators of solid waste as well as types of on-site storage.

D1.3. Complaints

Type and number of complaints made to the solid waste management authority are good indicators of the quality of the service. Some of the types of complaints that can be used are: uncollected waste, odour, flies and insects, spillage during transportation, or complaints about the attitudes of collection workers. The number and type of complaints should be recorded by collection zone.

D2. RESOURCE input indicators

D2.1. Human resources

For each category of staff, the number of workers; the average and total wages (daily, monthly, and annually); and the fringe benefits (e.g., health insurance, pension, paid leave), if any, are the resource input indicators.

- supervisors
- drivers
- collection workers
- street sweepers
- vehicle maintenance workers
- others (e.g., drain cleaners)

D2.2. Physical resources

Examples of the types of equipment are as follows:

- compactor trucks
- dump trucks
- fixed-bed trucks

- tractors
- trailers
- others (e.g., tilt frame vehicles, mechanical sweepers)
- pushcarts
- collection bins/baskets
- brooms

The following information should be collected for each category of equipment:

- number
- type or make
- capacity
- year of purchase
- purchase cost
- amount and cost of fuel consumed
- cost of regular service/maintenance
- cost of repair and spare parts
- average downtime

In situations where private contractors are employed for the collection service, the contractor's human and physical resource inputs and the contractual fees must be recorded.

D3. EFFICIENCY indicators

- weight or volume of solid waste collected daily per dollar of collection cost
- weight or volume of solid waste collected directly by the municipal authority daily per dollar of collection
- weight or volume of solid waste collected daily by contractors per dollar of contractual fees
- population served per collection worker
- population served per vehicle
- households served per collection worker
- length of street swept per sweeper

E. Processing and resource recovery

E1. SERVICE performance indicators

Processing plants can be categorised as follows:

- size reduction
- compaction

- transfer station
- composting
- materials recovery
- incineration

It is suggested that the following indicators be recorded for each facility:

- design capacity (Mg/day)
- amount of waste processed (Mg/day)
- amount of product generated (Mg/day)
- amount of residue generated (Mg/day)
- revenue from sales of products (cost/yr)
- savings due to reduced disposal cost (cost/yr)
- number of complaints by type (e.g., odour, flies and insects, unsightliness)

E2. RESOURCE input indicators

E2.1. Human resources

- plant manager
- engineers
- technicians
- labourers

For each category of human resource, the following indicators should be recorded:

- number
- average and total salaries
- fringe benefits (e.g., health insurance, pension, paid leave)

E2.2. Physical resources

- land
- facilities and equipment
- utilities consumed (electricity, gas, water, etc.)
- spare parts and other materials

Capital, as well as operation and maintenance, costs of these resources should also be recorded as resource input indicators.

In situations where contractors are employed, the contractor's human and physical resources and the contractual fees should be recorded as resource input indicators.

E3. EFFICIENCY indicators

There are a number of efficiency indicators that can be calculated based on the data collected; the following list provides some of the most common ones.

- annual revenue from sales of products per annual total cost
- annual revenue from sales of products, plus annual savings due to reduced disposal cost per annual total cost
- quantity of waste processed per total cost
- quantity of materials recovered per sorter

F. Final disposal

F1. SERVICE performance indicators

The following list provides representative service performance indicators for final disposal facilities:

- total capacity (m³)
- amount of waste disposed (Mg or m³/day or /yr)
- remaining capacity (m³)
- number of complaints by type (e.g., odour, flies, etc.)

F2. RESOURCE input indicators

Human resource inputs can be categorised as:

- plant managers
- engineers
- technicians
- labourers

For each category of human resource, the following indicators should be recorded:

- number
- average and total salaries
- fringe benefits

Physical resources include:

- land
- support facilities (e.g., office, fencing, weigh bridge, garage, surface water diversion system, liners, leachate collection and treatment facilities, landfill gas extraction system, groundwater monitoring wells)
- equipment (e.g., bulldozers, backhoes, compactors)

- electrical power and water supplies

Capital, as well as operation and maintenance, costs for the human and physical resources are also resource input indicators.

In the event that private contractors are employed, their human and physical resources and the contractual fees should be recorded.

F3. EFFICIENCY indicators

The most useful and commonly used efficiency indicator is the unit cost of waste disposed (cost/Mg).

F4. ADMINISTRATIVE indicators

Some of the most common administrative indicators include:

- number of violations (e.g., littering, illegal dumping, requirement for provision of storage containers)
- number of organised public communication activities (e.g., mass-media campaign, exhibitions, community cleanup contests, community meetings, recycling bazaars)
- number of public education activities
- number of participants in each of these activities

APPENDIX D. COSTS OF SOLID WASTE MANAGEMENT TECHNOLOGIES

Before making an investment in an MSW treatment technology, decision-makers must know what costs are entailed. Predicting such costs is possible to some extent, but it is necessary to specify the exact technology under consideration and the circumstances in which it will be used.

Making general comparisons between technologies, to be used as guides across a wide variety of situations, is very difficult. When specifying costs for an MSWM technology, one has to take into account a large range of factors that may vary considerably from one country to another and even within one country.

Definitions can be problematic. For example, in estimating the cost of a municipally sponsored materials recovery program, the specification of what is to be collected, and the method of including (or not including) avoided landfill costs, can have large effects on the estimates of costs. For example, the cost of landfilling depends significantly on conditions at the site chosen and on the methods that will be employed for monitoring and controlling leachate and landfill gas production. As another example, there are many types of vehicles and methods that can be used for waste collection and, consequently, the costs of collection can vary substantially among the alternatives.

When making comparisons among countries, fluctuating (and sometimes overvalued) exchange rates complicate the process of estimating costs. High rates of inflation in many countries make it difficult to consistently translate dollar costs into local costs. Subsidisation or taxation of local or imported inputs into MSWM activities can lead to a significant difference between the simple financial cost of implementing a technology and the real economic cost of doing so.

With the above discussion in mind, it is possible to make some very broad generalisations about MSWM costs. Table D-1 presents estimated costs of some MSWM technologies as a function of income level, i.e., low, middle, and high. High-income levels are associated with highly industrialised regions or countries. Both waste generation rates and costs of solid waste management systems reflect the level of industrial development. The technologies listed in the table are collection, transfer, and sanitary landfill. Also shown in the table are estimates of the cost of solid waste management as a percentage of income. As indicated by the data in the table, the proportion of income spent on MSWM in high-income regions is generally lower than that in low-income regions.

Table D-2 compares the disposal costs of some alternative technologies for large cities, listed approximately in order of increasing cost of disposal.

Table D-1. Costs of solid waste management as a function of income

	Low Income	Middle Income	High Income
Avg. Waste Generation (Mg/cap/yr)	0.1	0.2	0.7
Income (US\$/cap/yr)	500	3,000	25,000
Collection cost (US\$/Mg)	15 to 40	25 to 75	75 to 150
Transfer cost (US\$/Mg)	4 to 10	6 to 20	20 to 25
Sanitary landfill (US\$/Mg) (US\$/Mg)	5 to 25	15 to 20	30 to 100
Total Cost without Transfer	20 to 65	40 to 95	105 to 250
Total Cost with Transfer	24 to 75	46 to 115	125 to 275
Cost as % of Income	0.4 to 1.6%	0.2 to 0.7%	0.3 to 0.8%

1. Average income values based on selected world development indicators from the World Development Report 2000/2001, published for The World Bank by Oxford University Press.
2. Costs are for owning, operation, maintenance, and debt service in 2002, and assuming no equipment provision through grants.

Table D-2. Disposal costs of alternative technologies for large cities

	Low Income	Middle Income	High Income
Open dumping (US\$/Mg)	0.5 to 2	1 to 3	Not applicable
Sanitary landfill (US\$/Mg)	5 to 25	15 to 30	30 to 100
Composting (US\$/Mg)	5 to 25	15 to 40	30 to 80
Incineration (US\$/Mg)	30 to 60 (Note 5)	30 to 80 (Note 4)	70 to 100 (Note 4)

1. The above sanitary landfill costs are for cities of over 500,000 people, or over 250 tonnes/day, in order to capture economies-of-scale. For smaller cities, costs could be higher.
2. The higher range of costs for sanitary landfill is for systems with plastic membrane bottom liners and leachate collection and treatment systems; while the lower range of costs is for natural attenuation landfills, where site conditions do not require leachate management.
3. The higher range of costs for composting is for systems with mechanised classification, pulverisation, and forced aeration, while the lower range of costs is for systems with hand sorting, trommel screening, and simple turned windrows.
4. The higher range of costs for incineration is for systems with modern air pollution control and ash handling systems, while the lower range of costs is for systems with limited air pollution control equipment and no specialised ash handling equipment.
5. Limited air pollution control equipment and no specialised ash handling.

BIBLIOGRAPHY

Books, guides, reports, and monographs

- Accra Metropolitan Assembly. *Solid Waste Management Practices in Accra*. Accra: AMA Department of Waste Management, 1992.
- Ahmed, R., A. van de Klundert, and I. Lardinois. *Rubber Waste*. Urban Solid Waste Series, Vol., 3. Amsterdam and Gouda: Tool, Transfer of Technology for Development and WASTE Consultants, 1996.
- American Public Works Association. *Refuse Collection Practice*. Chicago: Public Administration Service, 1975 (fourth edition).
- Asociación Interamericana de Ingeniería Sanitaria y Ambiental (AIDIS). *Memoria del XXII Congreso AIDIS Camino al 2000; Forjando Hoy una Mejor Calidad de Vida* (Annals of the XXII AIDIS Congress). San Juan, Puerto Rico, September 1990, and conference proceedings from other years.
- Association of Plastics Manufacturers in Europe (APME). *Proceedings of 1995 APME Conference*. Brussels: APME, 1995.
- Bartone, Carl, Janis Bernstein, Josef Leitmann, and Jochen Eigen. *Toward Environmental Strategies for Cities: Policy Considerations for Urban Environmental Management in Developing Countries*. Urban Management Programme Policy Paper No. 18. Washington: World Bank, 1994.
- Bartone, Carl, Janis Bernstein, and Frederick Wright. *Investments in Solid Waste Management. Opportunities for Environmental Improvement*. World Bank Policy Research Working Paper Series No. 405. Washington: World Bank, 1990.
- Batstone, Roger, James E. Smith, Jr., and David Wilson, eds. *The Safe Disposal of Hazardous Wastes: The Special Needs and Problems of Developing Countries*, World Bank Technical Paper Number 93. Washington: World Bank, 1989.
- Bhide, A. D., and B.B. Sundaesan. *Solid Waste Management in Developing Countries*. New Delhi: Indian National Scientific Documentation Centre, 1983.
- Blumberg, L., and R. Gottlieb. *War on Waste - Can America Win its Battle with Garbage?* Washington: Island Press, 1989.
- Bubel, A Z. *Waste Picking & Solid Waste Management*. In *Environmental Sanitation Reviews*, No. 34. Bangkok: ENSIC, Asian Institute of Technology, 1990.
- CalRecovery, Inc., *Handbook of Solid Waste Properties*, Governmental Advisory Associates, Inc., New York, New York, 1993.
- Centre for Environmental Health Activities (CEHA). *Solid Waste Management in Some Countries of the Eastern Mediterranean Region*. Special Studies SS-4. Amman: World Health Organization and Centre for Environmental Health Activities, 1995.

- Center for Policy and Implementation Studies (CPIS). *Enterprises for the Recycling and Composting of Municipal Solid Waste in Jakarta, Indonesia*. Discussion Paper 433. Cambridge, Massachusetts, Harvard Institute for International Development, 1992.
- Centro Panamericano de Ingeniería Sanitaria y Ciencias del Ambiente (CEPIS). *Proceedings of the International Course on Sanitary and Secure Landfills*. Lima: CEPIS, 1995.
- CITYNET. *Innovative Approaches to Municipal Environmental Management*. A CITYNET publication prepared with the support of UNDP. New York: United Nations, 1992.
- Cointreau, Sandra. *Environmental Management of Urban Solid Wastes in Developing Countries: A Project Guide*. World Bank Urban Development Technical Paper No. 5. Washington: World Bank, 1982.
- Cointreau-Levine, Sandra. *Private Sector Participation in Municipal Solid Waste Services in Developing Countries*. Urban Management Program Discussion Paper No. 13. Washington: World Bank, 1994.
- Convard, Nancy. *Land-Based Pollutants Inventory for the South Pacific Region*. Apia: South Pacific Regional Environment Programme, 1993.
- Denison, Richard A., and John Ruston (Environmental Defense Fund). *Recycling and Incineration: Evaluating the Choices*. Washington: Island Press, 1991.
- Diaz, Luis F., George M. Savage, Linda L. Eggerth, and Clarence G. Golueke, *Solid Waste Management for Economically Developing Countries*. Copenhagen: International Solid Waste Association, 1996.
- DiGregorio, Michael, *Urban Harvest. Recycling as a Peasant Industry in Northern Vietnam*. East-West Center Occasional Papers, Environment Series, No. 17. Honolulu: East-West Center, 1994.
- Donahue, John D., *The Privatization Decision: Public Ends, Private Means*. New York: Basic Books, 1989.
- Dwivedi, O.P. and D. K. Vaipeyi, eds. *Environmental Policies in the Third World*. Westport, Connecticut, Greenwood Press, 1995.
- Environment Ontario. *Waste Management Planning -Volume 1: Sectoral Environmental Assessment Proposal for Waste Management Planning*. 1994.
- Environmental Campaigns Committee (ECC) and Hong Kong University (HKU). *Final Report. Survey on Community Attitudes to the Environment*. Hong Kong: Hong Kong University, 1993.
- Environmental Defense Fund. *Coming Full Circle: Successful Recycling Today*, Washington.
- Environmental Industry Associations (formerly National Solid Wastes Management Association). *Privatizing Municipal Waste Services: Saving Dollars and Making Sense*. Position paper. Washington, 1991.

- Furedy, Christine. *Social Aspects of Solid Waste Recovery in Asian Cities*. In *Environmental Sanitation Reviews*, No. 30, pp. 2-52. Bangkok: ENSIC, Asian Institute of Technology, December 1990.
- Gabbay, Shoshana. *The Environment in Israel*. Jerusalem: State of Israel, Ministry of Environment, 1994.
- Gale Research Inc. *Gale Environmental Sourcebook: A Guide to Organizations, Agencies, and Publications*. Detroit.
- Global Environment Centre Foundation (GEC). *The State of Solid Waste Management in Developing Countries: How Can Developing Countries and Japan Cooperate?* Proceedings of GEC International Environmental Seminar, Osaka, February 1994.
- Government Institutes, Inc. *Medical Waste Incineration Handbook*. Rockville, Maryland.
- Haight, Murray E., ed. *Municipal Solid Waste Management. Making Decisions in the Face of Uncertainty*. University of Waterloo Press, 1991.
- Hardoy, Jorge, David Satterthwaite, and Diana Mitlin. *Environmental Problems in Third World Cities*. London: Earthscan, 1992.
- Harris, P., and M. Allison. *Waste Utilization by Near-urban Farmers: A Literature Review*. Chatham: Natural Resources Institute, 1996.
- Holmes, John R., ed. *Managing Solid Wastes in Developing Countries*. Chichester: John Wiley & Sons, 1984.
- Hong Kong, Government of. *Monitoring of Municipal Solid Wastes 1989-1990*. Hong Kong: Environmental Protection Department, 1992.
- Hong Kong, Government of, Environmental Protection Department. *Annual Reports*. Hong Kong: Environmental Protection Department, 1990 onwards.
- Human Settlements Management Institute and Housing and Urban Development Corporation. *City-wide Best Practices in Solid Waste Management in Collection, Transportation and Disposal*. New Delhi: Human Settlements Management Institute, 1995.
- Inbar Y., et al. *Solid Waste Management in Israel*. Tel Aviv: Division of Solid Waste Management, Ministry of the Environment, Israel, 1995.
- INFORM, Inc. *Making Less Garbage: A Planning Guide for Communities*. New York.
- Institute for Local Self-Reliance. *Beyond 40 Percent. Record-Setting Recycling and Composting Programs*. Washington: Island Press, 1991.
- Instituto de Pesquisas Tecnológicas (IPT) and Compromisso Empresarial para Reciclagem (CEMPRE). *Lixo Municipal - Manual de Gerenciamento Integrado (Municipal Waste - Manual on Integrated Management)*. São Paulo: 1995.
- Instituto de Promoción de la Economía Social (IPES). *La Basura en Lima, Problemas y Soluciones (Garbage in Lima, Problems and Solutions)*. Includes annex: "Environmental Management Microenterprises: An Experience in Social Privatization of Public Services." Lima: 1995.

- International Solid Waste Association (ISWA). This organization, whose contact information appears under Europe in the Regional Overviews, has a long list of useful publications that it has produced. These works cover a very wide range of topics within MSWM.
- Japan, Government of, Japanese International Cooperation Agency (JICA). *Report. Solid Waste Management Study for Pulau Pinang & Seberang Perai Municipalities*, Malaysia. Tokyo: JICA, 1989.
- Jaramillo Pérez, Jorge Alberto; and Francisco Zepeda Porras. *Residuos Sólidos Municipales; Guía para el Diseño, Construcción y Operación de Rellenos Sanitarios Manuales* (Municipal Solid Wastes; Guidelines for the Design, Construction, and Operation of Manual Sanitary Landfills). Washington: Pan American Health Organization, 1991.
- Kreith, Frank, ed. *Handbook of Solid Waste Management*. New York: McGraw-Hill, 1994.
- Lardinois, I., and A. van de Klundert. *Organic Waste*. Urban Solid Waste Series, Vol. 1. Amsterdam and Gouda: Tool, Transfer of Technology for Development and WASTE Consultants, 1994.
- Lardinois, I., and A. van de Klundert. *Plastic Waste*. Urban Solid Waste Series, Vol. 2. Amsterdam and Gouda: Tool, Transfer of Technology for Development and WASTE Consultants, 1994.
- Lewcock, C.P. *Case Study of the Use of Urban Waste by Near-urban Farmers of Kano, Nigeria* (Project No. A0354). London: Natural Resources Institute and Overseas Development Administration, 1994.
- Maclaren, V.W. *Sustainable Urban Development in Canada: from Concept to Practice, Vol. 1: Summary Report*. Toronto: Intergovernmental Committee on Urban and Regional Research, 1992.
- Maclaren, V.W., R. Soemantojo, and J. Dooley. *Industrial Waste Minimization Practices in Jakarta and Vicinity*, Toronto: University Consortium on the Environment, York University, Faculty of Environmental Studies, 1995.
- Malaysia, Government of, Department of Environment and Engineering Science Inc./SEATEC International. *Report: Klang Valley Environmental Improvement Project. Kuala Lumpur*. Department of Environment, Malaysia, 1987.
- Malaysia, Government of, Local Government Division, Ministry of Housing & Local Government. *Annual Report*. Kuala Lumpur: various years.
- McBean, Edward A., Frank A. Rovers, and Grahame J. Farquhar. *Solid Waste Landfill Engineering and Design*. Englewood Cliffs, NJ.: Prentice Hall, 1995.

- Mega Cities Project and Environmental Quality International for the United Nations Development Program. *Urban Environment - Poverty Case Study Series: Zabbaleen Environmental anti Development Program*. Cairo: 1994.
- Mehta, Rekha. *Women and Waste Recycling in Ho Chi Minh City*. Washington: International Center for Research on Women, Collaborative Research Report, September 1994.
- Melosi, Martin V. *Garbage in the Cities: Refuse, Reform, and the Environment, 1880-1980*. College Station, Texas: Texas A&M University Press, 1981.
- Mougeot, L.J.A., and D. Massé, eds. *Urban Environment Management. Developing a Global Research Agenda*. Ottawa: International Development Research Centre, 1993.
- Muttamara, S., C. Visvanathan, and K.U. Alwis, *Solid Waste Recycling and Reuse in Bangkok*. In *Environmental Sanitation Reviews*. No. 33. Bangkok: ENSIC, 1993.
- Nepal, His Majesty's Government of, Ministry of Housing and Physical Planning and Ministry of Local Development, with German Technical Cooperation, Urban Development through Local Efforts Project. *Urban Environmental Guidelines for Nepal*. Eschborn: Deutsche Gesellschaft für Technische Zusammenarbeit (GTZ).
- Nicolaisen, D., U. Plog, E. Spreen, and S.B. Thapa. *Solid Waste Management with People's Participation*. Eschborn: Deutsche Gesellschaft für Technische Zusammenarbeit (GTZ), 1988.
- Ofosu-Amaah, Waafas, et al. *Success Stories of Women and the Environment*. Washington: United Nations Environment Programme and WorldWIDE Network Inc., 1991.
- Organization for Economic Cooperation and Development. *Technical Cooperation, Technical Transfer and Environmentally Sustainable Development*. DCD/DAC/ENV (93) 1993.
- Pan American Health Organization (PAHO). *El Manejo de Residuos Sólidos Municipales en América Latina y el Caribe* (Management of Municipal Solid Waste in Latin America and the Caribbean). Washington: 1995.
- Pearce, D., et al. *Solid and Hazardous Waste. Blueprint 3: Measuring Sustainable Development*. London: Earthscan, 1993.
- Pfammatter, Roger, and Roland Schertenleib. *Non-Governmental Refuse Collection in Low-income Urban Areas*. Report on a Project Tour. Dübendorf: SANDEC, 1996.
- Porteous, Andrew, *Dictionary of Environmental Science and Technology*. Chichester: John Wiley and Sons, 1996.
- Public Technology Inc. *Landfill Methane Recovery and Utilization: A Handbook for Local Governments*. Washington.
- Rico Posada, Ana Lucia. *Guía para la Formación de Cooperativas de Segregadores* (Guidelines for the Development of Waste Picker Cooperatives). Manuscript (available through CEPIS), 1991.
- Rouse, J. and M. Ali, *Vehicles for People or People for Vehicles?*. WEDC, Loughborough University, United Kingdom, 2002.

- Sakurai, Kunitoshi, *Improvement of Solid Waste Management in Developing Countries*. Technical Handbook Series, Vol, 1, Institute for International Cooperation. Tokyo: Japan International Cooperation Agency UICA), 1993.
- Savage, G.M., et al. *Guidance for Landfilling Waste in Economically Developing Countries*, in association with the U.S. Environmental Protection Agency, the International Solid Waste Association (ISWA), and U.S. Technology for International Environmental Solutions, 1998.
- Shanghai Municipal Bureau of Environmental Protection. *Proceedings, International Symposium on Urban Development and Environment*, 1994. Unpublished.
- Shekdar, A.V. *Solid Waste Management in India: Compost Facility Planning Guide*. Alexandria, Virginia: Composting Council, 1991.
- Shivaramakrishnan, K.C. *Metropolitan Management*. Washington: World Bank, 1986.
- Singapore, Government of, Ministry of the Environment, *Annual Report*. Singapore: 1993 and succeeding years.
- Stren, Richard E., and Rodney R. White, eds. *African Cities in Crisis: Managing Urban Growth*. Boulder, Colorado: Westview Press, 1989.
- Suriardi, Charles, et al. *Household Environmental Problems in Jakarta*. Stockholm: Stockholm Environment Institute, 1994.
- Tarver, James D., ed. *Urbanization in Africa: A Handbook*, Westport, Connecticut, Greenwood Press, 1994.
- Tchobanoglous, George, Hilary Theisen, and Samuel Vigil. *Integrated Solid Waste Management. Engineering Principles and Management Issues*. New York: McGraw-Hill, 1993.
- UNEP Industry and Environment, and UNEP Infoterra. *Wastes and their Treatment. Information Sources*. Nairobi: 1994.
- United Nations Centre for Human Settlements. *Promotion of Solid Waste Recycling and Reuse in Developing Countries of Asia*. Training Manual. Bangkok: ENSIC, 1994.
- United Nations Centre for Human Settlements. *Refuse Collection Vehicles for Developing Countries*. Nairobi: UNCHS, 1992.
- United Nations Centre for Human Settlements. *Report of the Regional Workshop on the Promotion of Waste Recycling and Reuse in Developing Countries*. Manila: UNCHS, 1993.
- United Nations Centre for Human Settlements. *Solid Waste Management in Low-Income Housing Projects: The Scope for Community Participation*. Nairobi: UNCHS, 1989.
- United Nations Economic and Social Commission for Asia and the Pacific. *State of Urbanization in Asia and the Pacific*. New York: United Nations, 1993.

- United Nations Environment Programme, International Environmental Technology Centre, *Environmental Risk Assessment for Sustainable Cities*. Technical Publication Series, No. 3. Osaka/Shiga: UNEP IETC, 1996.
- United States, Government of, Environmental Protection Agency. *Decision-Makers Guide to Solid Waste Management*. Washington: United States Environmental Protection Agency, 1989.
- United States, Government of, Office of Technology Assessment (OTA). *Facing America's Trash: What Next for Municipal Solid Waste?* Washington: OTA, 1989.
- United States Composting Council. *A Review of Composting Literature*. Holbrook, New York.
- United States Composting Council. *Compost Facility Operating Guide*. Holbrook, New York.
- United States Composting Council. *Uses and Benefits of MSW Compost. A Literature Review*. Holbrook, New York.
- United States Conference of Mayors. *Recycling in America's Cities: A Summary of 163 City Recycling Programs*. Washington.
- Universidade Federal do Rio de Janeiro. *Memórias do Curso Latino Americano de Limpeza Urbana e Administração de Resíduos Industriais* (Annals of the Latin American Course on Public Cleansing and Industrial Waste Management). Rio de Janeiro: 1991.
- World Health Organization. *Rapid Assessment of Sources of Air, Water and Land Pollution*. Geneva: WHO, 1992.
- World Resources Institute, United Nations Environment Programme, United Nations Development Programme, and World Bank. *World Resources, A Guide to the Global Environment 1996-97. The Urban Environment*. New York: Oxford University Press, 1996.
- Yap, Nonita, and S.K. Awasthi, eds. *Waste Management for Sustainable Development in India: Policy, Planning and Administrative Dimensions in Kanpur*. New Delhi: Tata McGraw-Hill, 1995.
- Yayasan Dian Desa. *Community Involvement in Primary Collection of Solid Waste in Four Indonesian Cities*. Yogyakarta: UNDP/World Bank Water and Sanitation Program, Regional Water and Sanitation Group for East Asia and the Pacific, 1993.

Articles, book chapters, and conference papers and proceedings

- Ahsan, R.M., N.N. Huque, and A. Huque. "Potentiality of Compost Making from Solid Waste in Dhaka City." *Oriental Geographer*, Vol. 36, July 1992: 1-14.
- Alabaster, Graham. "Waste Minimization for Developing Countries: Can We Afford to Neglect It?," *Habitat Debate*, Vol. 1, No. 3, Nov. 1995.
- Ali, M., A. Coad, and A. Cotton. "Municipal and Informal Systems in Solid Waste Management." In *Education for Real*, edited by N. Hamdi. London: Intermediate Technology (forthcoming).

- Ali, M. and D. Saywell. "Community Initiatives in Solid Waste." In *Proceedings of the 21st WEDC Conference: Sustainability of Water and Sanitation Systems*. Loughborough: Loughborough University Press, 1995.
- Ali, M. and D. Saywell. "Public/Private Municipal Sweepers Valued in Karachi, Pakistan." *Voices from the City*, Vol. 6, March 1996.
- Bartone, C.R. "Economic and Policy Issues in Resource Recovery from Municipal Solid Wastes." *Resources, Conservation and Recycling*, Vol. 4, 1990.
- Beede, David N., and David E. Bloom. "The Economics of Municipal Solid Waste." *The World Bank Research Observer*, Vol. 10, No. 2, August 1995: 113-150.
- Bose, A., and I. Blore. "Public Waste and Private Property." *Public Administration and Development*, Vol. 13, 1993: 1-10.
- Fernandez, Antonio. "Public-Private Partnerships in Solid Waste Management." *Regional Development Dialogue*, Vol. 14, No. 3, 1993: 3-21.
- Furedy, Christine. "Challenges in Reforming the Philosophy and Practice of Solid Waste Management: A Social Perspective." *Regional Development Dialogue*, Vol. 10, No. 3, 1989: iii-x.
- Furedy, Christine. "Garbage: Exploring Non-Conventional options in Asian Cities." *Environment and Urbanization*, Vol. 4, No. 2, 1992, 42-53.
- Furedy, Christine. "Liquidation of Solid Wastes." *Down to Earth*, Dec. 15, 1995: 52-53.
- Furedy, Christine. "One world of Waste: Should Countries Like India Solve Solid Waste Problems through Source Separation?." In *Enriched by South Asia*, pp. 87-107. Edited by E. Tepper and J. R. Wood. Montréal: Canadian Asian Studies Association and Shastri Indo-Canadian Institute, 1994.
- Furedy, Christine. "Social Considerations in Solid Waste Management in Asian Cities." *Regional Development Dialogue*, Vol. 10, No. 3, 1989.
- Furedy, Christine. "Solid Waste Management and Urban Agriculture: Dilemmas in Developing Countries - the Bad News and the Good News," Paper delivered at annual meeting of American Society of Community Planners, Toronto, July, 1996.
- Furedy, Christine. "Women and Wastes in Poor Communities." In *Infrastructure for Low-Income Communities. Proceedings of WEDC Conference*, pp. 25-28. Edited by M. Smith. Loughborough: Loughborough University Press, 1991.
- Furedy, Christine. "Working with the Waste Pickers, Asian Approaches to Urban Solid Waste Management." *Alternatives*, Vol. 19, No. 2, 1993.
- Indrayana, Eddy, and Johan Silas. "Waste Management in Surabaya: a Partnership Approach." *Regional Development Dialogue*, Vol. 14, No. 3, Autumn, 1993: 51-66.
- Lardinois, I., and A. van der Klundert, "Recycling Urban Organics in Asia and Africa." *BioCycle*, Vol. 35, No. 6, 1994.

- Maqsood Sinha, A.H.M., and A.T.M. Nurul Amin. "Dhaka's Waste Recycling Economy." *Regional Development Dialogue*, Vol. 16, No. 2, 1995: 173-195.
- Meyer, Werner. "Community Involvement in Municipal Solid Waste Collection in Two West African Cities - Findings Of A Mission." *IRCWD NEWS*, No. 27, August 1993: 11-15.
- Ogawa, Hisashi. "Key Issues on Solid Waste Management in the Pacific Island Countries." Paper presented at the WHO Regional Workshop on Solid Waste Management in the Pacific Countries. Kuala Lumpur: WHO, Environmental Health Centre, 1992.
- Ouano, E.A.R. "Imperatives for Recycling and Resource Recovery." *Regional Development Dialogue*, Vol. 14, No. 3, 1993: v-ix.
- Ouano, E.A.R. and Hisashi Ogawa. "Partnership toward Responsive Solid Waste Management." *Regional Development Dialogue*, Vol. 14, No. 3, Autumn, 1993.
- Pacheco, M. "Recycling in Bogotá: Developing a Culture for Urban Sustainability." *Environment and Urbanization*, Vol. 4, No. 2, 1992.
- Scheinberg, Anne, "Going Dutch: Netherlands Organics Collection Matures." *Resource Recycling*, January 1996.
- Schertenleib, R. and W. Meyer, "Municipal Solid Waste Management in Developing Countries: Problems and Issues; Needs for Further Research." *IRCWD NEWS*, No. 26, March 1992: 2-9.
- Schertenleib, R. and W. Meyer. "Synergetic Effects of Municipal Solid Waste Collection, Recycling and Disposal." *IRCWD News*, No. 26, March 1992: 9-12.
- Smit, Jac and Joe Nasr. "Urban Agriculture for Sustainable Cities: Using Wastes and Idle Land and Water Bodies as Resources." *Environment and Urbanization*, Vol. 4, No. 2, 1992: 141-151.
- Whitney, Joseph. "Waste Economy and the Dispersed Metropolis in China." In *The Dispersed Metropolis: A Phase of the Settlement Transition in Asia*, pp. 177-191. Edited by N. Ginsberg, Bruce Koppel, and T. G. McGee. Honolulu: University of Hawaii Press, 1991.
- Yhdego, Michael. "Urban Solid Waste Management in Tanzania." *Waste Management & Research*, Vol. 6, No. 3, 1988: 175-194.

Journals and newsletters

- ASEP News*. Asian Society for Environmental Protection, Asian Institute of Technology, Box 2754, Bangkok 1,0501, Thailand.
- Asian Environment, Journal of Environmental Science and Technology for Balanced Development*. PO Box 90 MCC, Makati, Philippines.
- BioCycle: Journal of Composting & Recycling*. J.G. Press, 419 State Avenue, Emmaus, Pennsylvania 18049, USA.
- Compost Science & Utilization*. J.G. Press, 419 State Avenue, Emmaus, Pennsylvania 18049, USA.

- ENFO: Newsletter of Environmental Systems Information Centre.* ENSIC, Asian Institute of Technology, Box 2754, Bangkok 10501, Thailand.
- ENSEARCH.* No. 30A, Jalan S 21/35, 47400 Petaling Jaya, Malaysia.
- Environment Reporter.* Bureau of National Affairs, Inc., 1231 25th Street NW, Washington, DC 20037, USA.
- Infectious Wastes News.* Environmental Industry Associations, 4301 Connecticut Avenue NW, Suite 300, Washington, DC 20008, USA.
- Ingenieria Sanitaria.* (Sanitary Engineering). AIDIS, Rua Nicolau Gagliardi 354, CEP 05429-010, São Paulo, Brazil.
- International Environment Reporter.* Bureau of National Affairs, Inc., 1231 25th Street NW, Washington, DC 20037, USA.
- Journal of Material Cycles & Waste Management.* Springer-Verlag, Haberstrasse 7, 69126 Heidelberg, Germany.
- Journal of Waste Management & the Environment, Asia/Pacific Edition.* Shiny Offset Printing Co. Ltd., Flat A1, 3F, Fortune Factory Building, 40 Lee Ching Street, Chai Wan, Hong Kong.
- Newsletter.* INTEP, Department of Urban Engineering, University of Tokyo, 7-3-1 Hongo, Bunkyo-ku, Tokyo 113, Japan.
- Newsletter.* Specialist Group on Appropriate Waste Management Technologies for Developing Countries. c/o International Association on Water Quality (IAWQ), Duchess House, 20 Masons Yard Duke Street, St James's London SW1Y 6BU, England, UK.
- Newsletter, Environmental Engineering Society of Singapore.* Kent Ridge, PO Box 1007, Singapore 9111.
- Newsletter of Environmental Engineers Association of Thailand.* c/o Faculty of Engineering, Chulalongkorn University, Bangkok 10330, Thailand.
- Newsletter of Global Environment Centre Foundation.* UNEP, International Environmental Technology Centre, 2-110 Ryokuchi-koen, Tsurumi-ku, Osaka 538, Japan.
- Recycling Times.* Environmental Industry Associations, 4301 Connecticut Avenue NW, Suite 300, Washington, DC 20008, USA.
- Regional Development Dialogue.* United Nations Centre for Regional Development, 1-47-1 Nagono, Nakamura-ku, Nagoya 450, Japan.
- Resource Recycling.* PO Box 42270, Portland, Oregon 97242, USA.
- Resources, Conservation & Recycling.* Elsevier, PO Box 211, 1000 AE Amsterdam, The Netherlands.
- SWMNet. Information Network on Solid Waste Management for the Western Pacific Region.* c/o Dr. Hisashi Ogawa, WHO Environmental Health Centre, PO Box 12550, 50782 Kuala Lumpur, Malaysia.

UWEP News. Urban Waste Expertise Programme, WASTE, Crabethstraat 38 F, 2801 AN Gouda, the Netherlands.

Waste Age. PO Box 12997, Overland Park, Kansas 66282-2997, USA.

Waste Management. Elsevier, PO Box 211, 1000 AE Amsterdam, The Netherlands.

Waste Management & Research. International Solid Waste Association, Vesterbrogade 74, 3. floor, DK-1620 Copenhagen V, Denmark.

GLOSSARY

Aerobic composting - a method of composting organic wastes using bacteria that need oxygen. This requires that the waste be exposed to air, either via turning or by forcing air through perforated pipes that pass through the material.

Anaerobic digestion - a method of composting that does not require oxygen. This composting method produces methane. Also known as anaerobic composting.

Ash - the non-combustible, solid byproducts of incineration or other combustion process.

Autoclaving - sterilisation via a pressurised, high-temperature steam process.

Baghouse - a combustion plant emission control device that consists of an array of fabric filters through which flue gases pass in an incinerator flue. Particles are trapped and thus prevented from passing into the atmosphere.

Basel Convention - an international agreement on the control of transboundary movements of hazardous wastes and their disposal, drawn up in March 1989 in Basel, Switzerland, with over 100 countries as signatories.

Biodegradable material - any organic material that can be broken down by microorganisms into simpler, more stable compounds. Most organic wastes (e.g., food, paper) are biodegradable.

Bottom ash - relatively coarse, non-combustible, generally toxic residue of incineration that accumulates on the grate of a furnace.

Bulky waste - large wastes, such as appliances, furniture, and trees and branches, that cannot be handled by normal MSW processing methods.

Cell - the basic unit by which a landfill is developed. It is the general area where incoming waste is tipped, spread, compacted, and covered.

Cleaner production - processes designed to reduce the wastes generated by production.

Co-disposal - the disposal of different types of waste in one area of a landfill or dump. For instance, sewage sludges may be disposed of with regular solid wastes.

Cogeneration - production of both electricity and steam from one facility, from the same fuel source.

Collection - the process of picking up wastes from residences, businesses, or a collection point, loading them into a vehicle, and transporting them to a processing, transfer, or disposal site.

Combustibles - burnable materials in the waste stream, including paper, plastics, wood, and food and garden wastes.

Combustion - in MSWM, the burning of materials in an incinerator.

Commingled - mixed recyclables that are collected together after having been separated from mixed MSW.

Communal collection - a system of collection in which individuals bring their waste directly to a central point, from which it is collected.

Compactor vehicle - a collection vehicle using high-power mechanical or hydraulic equipment to reduce the volume of solid waste.

Composite liner - a liner system for a landfill consisting of an engineered soil layer and a synthetic sheet of material.

Compost - the material resulting from composting. Compost, also called humus, is a soil conditioner.

Composting - biological decomposition of solid organic materials by bacteria, fungi, and other organisms into a soil-like product.

Construction and demolition debris -waste generated by construction and demolition of buildings, such as bricks, concrete, drywall, lumber, miscellaneous metal parts and sheets, packaging materials, etc.

Controlled dump - a planned landfill that incorporates to some extent some of the features of a sanitary landfill: siting with respect to hydrogeological suitability, grading, compaction in some cases, leachate control, partial gas management, regular (not usually daily) cover, access control, basic recordkeeping, and controlled scavenging.

Curing - allowing partially composted materials to reside in a pile for a specified period of time as part of the maturing process in composting.

Disposal - the final handling of solid waste, following collection, processing, or incineration. Disposal most often means placement of wastes in a dump or a landfill.

Diversion rate - the proportion of waste material diverted for recycling, composting, or reuse and away from landfilling.

Drop-off centre - an area or facility for receiving compostables or recyclables that are dropped off by waste generators.

Dump - see *Controlled dump* and *Open dump*.

Emissions - gases released into the atmosphere.

Energy recovery - the process of extracting useful energy from waste, typically from the heat produced by incineration or via methane gas from landfills.

Environmental impact assessment (EIA) -an evaluation designed to identify and predict the impact of an action or a project on the environment and human health and well being. Can include risk assessment: as a component, along with economic and land use assessment.

Environmental risk assessment (EnRA) - an evaluation of the interactions of agents, humans, and ecological resources. Comprised of human health risk assessment and ecological risk assessment, typically evaluating the probabilities and magnitudes of harm that could come from environmental contaminants.

Fabric filter - see *Baghouse*.

Flaring - the burning of landfill gas/methane captured and emitted from collection pipes at a landfill.

Fluidised-bed incinerator - a type of incinerator in which the stoker grate is replaced by a bed of limestone or sand that can withstand high temperatures. The heating of the bed and the high air velocities used cause the bed to bubble, which gives rise to the term “fluidised”.

Fly ash - the highly toxic particulate matter captured from the flue gas of an incinerator by the air pollution control system.

Garbage - in everyday usage, refuse in general. Some MSWM manuals use garbage to mean “food wastes”, although this usage is not common.

Groundwater - water beneath the earth’s surface that fills underground pockets (known as aquifers), supplying wells and springs.

Hazardous waste - waste that is reactive, toxic, corrosive, or otherwise dangerous to living things and/or the environment. Many industrial byproducts are hazardous.

Heavy metals - metals of high atomic weight and density, such as mercury, lead, and cadmium, that are toxic to living organisms.

Household hazardous waste - products used in residences, such as paints and some cleaning compounds, that are toxic to living organisms and/or the environment.

Humus - the end product of composting, also called compost.

Incineration - the process of combusting solid waste under controlled, approximately stoichiometric conditions to reduce its weight and volume, and often to produce energy.

Informal sector - the part of an economy that is characterised by private, usually small-scale, labour-intensive, largely unregulated, and unregistered manufacturing or provision of services.

Inorganic waste - waste composed of material other than plant or animal matter, such as sand, dust, glass, and many synthetics.

Integrated solid waste management - coordinated use of a set of waste management methods, each of which can play a role in an overall MSWM plan.

International NGO - an organisation that has an international headquarters and branches in major world regions, often with the purpose of undertaking development assistance.

In-vessel composting - composting in an enclosed vessel or drum with a controlled internal environment, mechanical mixing, and aeration.

Itinerant waste buyer - a person who moves around the streets buying (or bartering for) reusable and recyclable materials.

Kerbside collection - collection of compostables, recyclables, or trash at the edge of a sidewalk in front of a residence or shop.

Landfill gases - gases arising from the decomposition of organic wastes; principally methane, carbon dioxide, and hydrogen sulphide. Such gases may cause explosions at landfills.

Landfilling - the final disposal of solid waste by placing it in a controlled fashion in a place intended to be permanent. The term is applied to both controlled dumps and sanitary landfills.

Leachate - liquid (which may be partly produced by decomposition of organic matter) that has seeped through a landfill or a compost pile and has accumulated bacteria and other possibly harmful dissolved or suspended materials. If uncontrolled, leachate can contaminate both groundwater and surface water.

Leachate pond - a pond or tank constructed at a landfill to receive the leachate from the area. Usually the pond is designed to provide some treatment of the leachate, by allowing settlement of solids or by aeration to promote biological processes.

Lift - the completed layer of compacted waste in a cell at a landfill.

Liner - a protective layer, made of soil and/or synthetic materials, installed along the bottom and sides of a landfill to prevent or reduce the flow of leachate into the environment.

Manual landfill - a landfill in which most operations are carried out without the use of mechanised equipment.

Market waste - primarily organic waste, such as leaves, skins, and unsold food, discarded at or near food markets.

Massburn incinerator - a type of incinerator in which solid waste is burned without prior sorting or processing.

Materials recovery - obtaining materials that can be reused or recycled.

Materials recovery facility (MRF) - a facility for separating commingled recyclables by manual or mechanical means. Some MRFs are designed to separate recyclables from mixed MSW. MRFs then bale and market the recovered materials.

Methane - an odourless, colourless, flammable, explosive gas, CH₄, produced by anaerobically decomposing MSW at landfills.

Microenterprise - a synonym for small-scale enterprise: a business, often family-based or a cooperative, that usually employs fewer than ten people and may operate “informally”.

Mixed waste - unsorted materials that have been discarded into the waste stream.

Modular incinerator - a relatively small type of prefabricated solid waste combustion unit.

Monofill - a landfill intended for one type of waste only.

MSW - municipal solid waste.

MSWM - municipal solid waste management.

Municipal solid waste - all solid waste generated in an area except industrial and agricultural wastes. Sometimes includes construction and demolition debris and other special wastes that may enter the municipal waste stream. Generally excludes hazardous wastes, except to the extent that they enter the municipal waste stream. Sometimes defined to mean all solid wastes that a city authority accepts responsibility for managing in some way.

Municipal solid waste management - planning and implementation of systems to handle MSW.

NGO – Non-governmental organisation. May be used to refer to a range of organisations, from small community groups, through national and international organisations. Frequently these are not-for-profit organisations.

Nightsoil - human excreta.

NIMBY - “Not In My Back Yard”. An expression of resident opposition to the siting of a solid waste facility based on the particular location proposed.

Open dump - an unplanned “landfill” that incorporates few if any of the characteristics of a controlled landfill. There is typically no leachate control, no access control, no cover, no management, and many scavengers.

Organic waste - technically, waste containing carbon, including paper, plastics, wood, food wastes, and yard wastes. In practice in MSWM, the term is often used in a more restricted sense to mean material that is more directly derived from plant or animal sources, and which can generally be decomposed by microorganisms.

Pathogen - an organism capable of causing disease.

Pollution - the contamination of soil, water, or the atmosphere by the discharge of waste or other offensive materials.

Post-consumer materials - materials that a consumer has finished using, which the consumer may sell, give away, or discard as wastes.

Primary material - a commercial material produced from virgin materials used for the manufacture of basic products. Examples include wood pulp, iron ore, and silica sand.

Privatisation - a general term referring to a range of contracts and other agreements that transfer the provision of some services or production from the public sector to private firms or organisations.

Processing - preparing MSW materials for subsequent use or management, using processes such as baling, magnetic separation, crushing, and shredding. The term is also sometimes used to mean separation of recyclables from mixed MSW.

Producer responsibility - a system in which a producer of products or services takes responsibility for the waste that results from the products or services marketed, by reducing materials used in production, making repairable or recyclable goods, and/or reducing packaging.

Putrescible - subject to decomposition or decay. Usually used in reference to food wastes and other organic wastes that decay quickly.

Pyrolysis - chemical decomposition of a substance by heat in the absence of oxygen, resulting in the production of various hydrocarbon gases and carbon-like residue.

Recyclables - items that can be reprocessed into feedstock for new products. Common examples are paper, glass, aluminium, corrugated cardboard, and plastic containers.

Recycling - the process of transforming materials into raw materials for manufacturing new products, which may or may not be similar to the original product.

Refuse - a term often used interchangeably with solid waste.

Refuse-derived fuel (RDF) – solid fuel produced from MSW that has undergone processing. Processing can include separation of recyclables and non-combustible materials, shredding, size reduction, and pelletizing.

Resource recovery - the extraction and utilisation of materials and energy from wastes.

Reuse - the use of a product more than once in its original form, for the same or a new purpose.

Rubbish - a general term for solid waste. Sometimes used to exclude food wastes and ashes.

Sanitary landfill - an engineered method of disposing of solid waste on land, in a manner that meets most of the standard specifications, including sound siting, extensive site preparation, proper leachate and gas management and monitoring, compaction, daily and final cover, complete access control, and recordkeeping.

Scavenger - a person who picks out recyclables from mixed waste wherever it may be temporarily accessible or disposed of.

Scrubber - emission control device in an incinerator, used primarily to control acid gases, but also to remove some heavy metals.

Secondary material- a material recovered from post-consumer wastes for use in place of a primary material in manufacturing a product.

Secure landfill - a disposal facility designed to permanently isolate wastes from the environment. This entails burial of the wastes in a landfill that includes clay and/or synthetic liners, leachate collection, gas collection (in cases where gas is generated), and an impermeable cover.

Septage - sludge removed from a septic tank (a chamber that holds human excreta).

Setout container - a box or bucket used for residential waste that is placed outside for collection.

Sewage sludge - a semi-liquid residue that settles to the bottom of canals and pipes carrying sewage or industrial wastewaters, or in the bottom of tanks used in treating wastewaters.

Site remediation - treatment of a contaminated site by removing contaminated solids or liquids or treating them onsite.

Source reduction - the design, manufacture, acquisition, and reuse of materials so as to minimise the quantity and/or toxicity of waste produced.

Source separation - setting aside of compostable and recyclable materials from the waste stream before they are collected with other MSW, to facilitate reuse, recycling, and composting.

Special wastes - wastes that are ideally considered to be outside of the MSW stream, but which sometimes enter it and must often be dealt with by municipal authorities. These include household hazardous waste, medical waste, construction and demolition debris, war and earthquake debris, tires, oils, wet batteries, sewage sludge, human excreta, stoichiometric-condition slaughterhouse waste, and industrial waste. In combustion chemistry, the condition whereupon the quantity of oxygen provided to the combustion process is exactly that needed to completely oxidise all carbon in the fuel to carbon dioxide.

Subsidy - direct or indirect payment from government to businesses, citizens, or institutions to encourage a desired activity.

Tipping fee - a fee for unloading or dumping waste at a landfill, transfer station, incinerator, or recycling facility.

Tipping floor - unloading area for vehicles that are delivering MSW to a transfer station, processing facility, or incinerator.

Transfer - the act of moving waste from a collection vehicle to a larger transport vehicle.

Transfer point - a designated point, often at the edge of a neighbourhood, where small collection vehicles transfer waste to larger vehicles for transport to disposal sites.

Transfer station - a major facility at which MSW from collection vehicles is consolidated into loads that are transported by larger trucks or other means to more distant final disposal facilities, typically landfills.

Transition countries - the countries of Eastern Europe and the former Soviet Union that are in various stages of restructuring their economies. The changes involve a move away from being substantially state-run toward a variety of new configurations, ranging from moderate economic liberalisation to a significant dismantling of the state's role in the economy.

Vectors - organisms that carry disease-causing pathogens. At landfills, rodents, flies, and birds are the main vectors that spread pathogens beyond the landfill site.

Vermiculture - see *Worm culture*.

Virgin materials - any basic material for industrial processes that has not previously been used, for example, wood pulp trees, iron ore, crude oil, bauxite.

Waste characterisation study - an analysis of samples from a waste stream to determine its composition.

Waste collector - a person employed by a local authority or a private firm to collect waste from residences, businesses, and community bins.

Waste dealer - an intermediary who buys recyclable materials from waste generators and itinerant buyers and sells them, after sorting and some processing, to wholesale brokers or recycling industries.

Waste management hierarchy - a ranking of waste management operations according to their environmental or energy benefits. The purpose of the waste management hierarchy is to make waste management practices as environmentally sound as possible.

Waste picker – see *Scavenger*.

Waste reduction - all means of reducing the amount of waste that is produced initially and that must be collected by solid waste authorities. This ranges from legislation and product design to local programs designed to keep recyclables and compostables out of the final waste stream.

Waste stream - the total flow of waste from a community, region, or facility.

Waste-to-energy (WTE) plant - a facility that uses solid waste materials (processed or raw) to produce energy. WTE plants include incinerators that produce steam for district heating or industrial use, or that generate electricity; they also include facilities that convert landfill gas to electricity.

Water table - level below the earth's surface at which the ground becomes saturated with water.

Wetland - an area that is regularly wet or flooded and has a water table that stands at or above the land surface for at least part of the year.

Windrow - an elongated pile of aerobically composting materials that are turned periodically to expose the materials to oxygen and to control the temperature to promote biodegradation.

Working face - the length and width of the area in which waste is being deposited at a landfill. Also known as the tipping face.

Worm castings - the material produced from the digestive tracts of worms as they live in earth or compost piles. The castings are rich in nitrates, potassium, phosphorus, calcium, and magnesium.

Worm culture - a relatively cool, aerobic composting process that uses worms and microorganisms. Also known as vermiculture.

Yard waste - leaves, grass clippings, prunings, and other natural organic matter discarded from yards and gardens.

About CalRecovery, Inc.

CalRecovery, Inc. was established in California, USA in 1975 to provide services in waste management and the production and use of non-conventional sources of energy to public and private entities. The range of services includes: project management, field test evaluations, technical assistance, research and development, conduct of feasibility studies, preparation of master plans, and system design and implementation with emphasis on resource recovery and waste diversion from landfills. CalRecovery has an international clientele, having performed work in more than 40 countries in most regions of the world. Additionally, the company is proud to have been amongst the first few entities to have worked with NASA on the management of solid waste in space.

In addition to the sound experience in developing countries, CalRecovery has a multi-disciplinary staff capable of working on a variety of tasks, from training to financial analyses and public participation. Members of CalRecovery devote a considerable amount of their time to providing formal and informal education and training at various universities and other institutions throughout the world.

Over the years, the firm has been involved in projects involving the technologies of waste minimization, source separation, composting, recycling, energy recovery, and landfill disposal. Based on the extensive experience from working in many industrialized and developing countries, members of CalRecovery typically combine methods and solutions that are practical and cost-effective, under a wide range of social, political, and economic conditions.

The firm is a leader in integrating solid waste management systems with other key community services such wastewater treatment and power production aimed at maximum waste minimization and the optimization resource recovery. CalRecovery is well-versed in waste characterization. The company has an extensive database on the characteristics of solid wastes from many countries around the world, as well as basic design data on many solid waste treatment facilities in a variety of countries.

Other pertinent titles by members of CalRecovery include:

- *Organic Wastes for Fuel and Fertilizer in Developing Countries* (1980)
- *Resource Recovery from Municipal Solid Wastes, Volumes I and II* (1982)
- *Unit Operations Models for Solid Waste Processing* (1986)
- *Handbook of Solid Waste Properties* (1993)
- *Material Recovery Facility Design Manual* (1993)
- *Recycling Equipment and Technology for Municipal Solid Waste: Material Recovery Facilities* (1993)
- *Composting and Recycling Municipal Solid Waste* (1993)
- *Material Recovery Facility Design Manual* (1993)
- *Guidance for Landfilling Waste in Economically Developing Countries* (1998)
- *Modern Composting Technologies* (2005)

For additional information, please refer to www.calrecovery.com

About the UNEP Division of Technology, Industry and Economics

The UNEP Division of Technology, Industry and Economics (DTIE) helps governments, local authorities and decision-makers in business and industry to develop and implement policies and practices focusing on sustainable development.

The Division works to promote:

- > sustainable consumption and production,
- > the efficient use of renewable energy,
- > adequate management of chemicals,
- > the integration of environmental costs in development policies.

The Office of the Director, located in Paris, coordinates activities through:

- > **The International Environmental Technology Centre** - IETC (Osaka, Shiga), which implements integrated waste, water and disaster management programmes, focusing in particular on Asia.
- > **Production and Consumption** (Paris), which promotes sustainable consumption and production patterns as a contribution to human development through global markets.
- > **Chemicals** (Geneva), which catalyzes global actions to bring about the sound management of chemicals and the improvement of chemical safety worldwide.
- > **Energy** (Paris), which fosters energy and transport policies for sustainable development and encourages investment in renewable energy and energy efficiency.
- > **OzonAction** (Paris), which supports the phase-out of ozone depleting substances in developing countries and countries with economies in transition to ensure implementation of the Montreal Protocol.
- > **Economics and Trade** (Geneva), which helps countries to integrate environmental considerations into economic and trade policies, and works with the finance sector to incorporate sustainable development policies.

UNEP DTIE activities focus on raising awareness, improving the transfer of knowledge and information, fostering technological cooperation and partnerships, and implementing international conventions and agreements.

For more information,
see **www.unep.fr**

This publication looks at the use of technologies that are environmentally sound for managing municipal solid wastes in developing countries. It is designed as a sourcebook on solid waste management, covering a multitude of topics including the principles of solid waste management, processing and treatment, and final disposal. It also covers key non-technical aspects, and offers regional overviews on SWM.

www.unep.org

United Nations Environment Programme
P.O. Box 30552 Nairobi, Kenya
Tel.: ++254-(0)20-62 1 234
Fax: ++254-(0)20-62 3927
E-mail: cpinfo@unep.org



For more information, contact:

**UNEP DTIE
International Environmental
Technology Centre**

E-mail: ieto@unep.or.jp
www.unep.or.jp/

Osaka Office
2-110 Ryokuchi Koen,
Tsurumi-ku Osaka 538-0036, Japan
Tel.: +81-6 6915 4581
Fax: +81 6 6915 0304

Shiga Office
1091 Oroshimo-cho, Kusatsu City
Shiga 525-0001, Japan
Tel.: +81 77 568 4581
Fax: +81 77 568 4587

CalRecovery, Inc.

2454 Stanwell Drive
Concord CA 94520
U.S.A.
Tel.: +1 925 356 3700
Fax: +1 925 356 7956
www.calrecovery.com

DTI/0782/JA