



UNITED
NATIONS

EP

UNEP/MED WG.482/16



UNITED NATIONS
ENVIRONMENT PROGRAMME
MEDITERRANEAN ACTION PLAN

2 November 2020
Original: English

Integrated Meetings of the Ecosystem Approach Correspondence Groups on IMAP Implementation (CORMONs)

Videoconference, 1-3 December 2020

Agenda item 5: Parallel CORMON Sessions for Pollution, including Marine Litter and Biodiversity

Monitoring Guidelines/Protocols for Sample Preparation and Analysis of Seawater for IMAP Common Indicator 17: Heavy and Trace Elements and Organic Contaminants

For environmental and economic reasons, this document is printed in a limited number. Delegates are kindly requested to bring their copies to meetings and not to request additional copies.

Table of Contents

1	Introduction	1
2	Technical note for the preparation and analysis of seawater samples to be analysed for heavy metals	2
2.1	Protocol for SPM digestion using nitric acid and hydrofluoric acid	4
2.2	Protocol for the analysis of heavy metals in seawater with GF-AAS	5
2.3	Protocol for the analysis of heavy metals in seawater with ICP-MS	6
2.4	Protocol for the analysis of Total Mercury in seawater with CV-AFS	6
3	Technical note for the preparation and analysis of seawater samples to be analysed for organic contaminants.....	6
3.1	Protocol for the analysis of organochlorine pesticides and PCBs in seawater using GC-ECD or GC-MS.....	8
3.2	Protocol for the analysis of PAHs in seawater using GC-FID or GC-MS	8

Annexes

Annex I: HELCOM (2012a). Manual for marine monitoring in the COMBINE programme. Annex B-11, Appendix 1. Technical Note on the determination of trace metals (Cd, Pb, Cu, Co, Zn, Ni, Fe) including mercury in seawater.

Annex II: IAEA (2012). Laboratory Procedure Book: Analysis of trace metals in biological and sediment samples (4.1.1);

Annex III: US EPA (1995). Method 1640: Determination of trace elements in ambient waters by on-line chelation preconcentration and Inductively Coupled Plasma Mass Spectrometry. (6.1.1);

Annex IV: UNEP/IAEA (2011). Sample work-up for the analysis of selected chlorinated hydrocarbons in the marine environment. Reference Methods for Marine Pollution Studies No 71 (4.2.1);

Annex V: UNEP/IAEA (2011b). Recommended method on the determination of petroleum hydrocarbons in sediment samples (4.2.4);

Annex VI: HELCOM (2012b). Manual for marine monitoring in the COMBINE programme. Annex B-11 Technical note on the determination of heavy metals and persistent organic compounds in seawater. Appendix 2. Technical note on the determination of persistent organic pollutants in seawater (6.2.);

Annex VII: ICES/OSPAR (2012). JAMP Guidelines for monitoring contaminants in seawater (6.3.)

Annex VIII: References.

Note by the Secretariat

In line with the Programme of Work 2020-2021 adopted by COP21 the MED POL Programme has prepared the Monitoring Guidelines related to IMAP Common Indicators 13, 14, 17 and 20 for consideration of the Integrated Meeting of the Ecosystem Approach Correspondence Groups on Monitoring (December 2020), whilst the Monitoring Guidelines for Common Indicator 18, along with the Monitoring Guidelines related to data quality assurance and reporting are under finalization for consideration of the Meeting on CorMon on Pollution Monitoring planned to be held in April 2021.

These Monitoring Guidelines present coherent manuals to guide technical personnel of IMAP competent laboratories of the Contracting Parties for the implementation of the standardized and harmonized monitoring practices related to a specific IMAP Common Indicator (i.e. sampling, sample preservation and transportation, sample preparation and analysis, along with quality assurance and reporting of monitoring data). For the first time, these guidelines present a summary of the best available known practices employed in marine monitoring by bringing integrated comprehensive analytical practices that can be applied in order to ensure the representativeness and accuracy of the analytical results needed for generation of quality assured monitoring data.

The Monitoring Guidelines/Protocols build upon the knowledge and practices obtained over 40 years of MED POL monitoring implementation and recent publications, highlighting the current practices of the Contracting Parties' marine laboratories, as well as other Regional Seas Conventions and the EU. A thorough analysis of presently available practices of UNEP/MAP, UNEP and IAEA, as well the HELCOM, OSPAR and European Commission Joint Research Centre was undertaken to assist an innovative approach for preparation of the IMAP Monitoring Guidelines/Protocols.

The Monitoring Guidelines/Protocols also address the problems identified during realization of the Proficiency testing being organized by UNEP/MAP-MEDPOL and IAEA for two decades now, given that many unsatisfactory results within inter-laboratory testing may be connected to inadequate laboratory practices of the IMAP/MEDPOL competent laboratories.

In order to support national efforts, this Monitoring Guidelines for Sample Preparation and Analysis of Seawater for IMAP Common Indicator 17 provides the two Technical Note: a) Technical Note for the analysis of seawater samples for heavy metals, which includes the four following Protocols: i) Protocol for SPM digestion using nitric acid and hydrofluoric acid; ii) Protocol for the analysis of heavy metals in seawater with Graphite Furnace Atomic Absorption Spectroscopy (GF-AAS); iii) Protocol for the analysis of heavy metals in seawater with Inductive Coupled Plasma – Mass Spectroscopy (ICP-MS); iv) Protocol for the analysis of THg in seawater with Cold Vapour- Atomic Fluorescence Spectroscopy (CV-AFS); b) Technical Note for the analysis of seawater samples for organic contaminants, which included the two following Protocols: i) Protocol for the analysis of organochlorine pesticides and PCBs in seawater using Gas Chromatography - Electron Capture Detector (GC-ECD) or Gas Chromatography - Mass Spectroscopy (GC-MS); ii) Protocol for the analysis of PAHs in seawater using Gas Chromatography - Flame Ionization Detector (GC-FID) or Gas Chromatography - Mass Spectroscopy (GC-MS), for consideration of Integrated Meeting of the Ecosystem Approach Correspondence Groups on Monitoring (CORMON) Biodiversity and Fisheries, Pollution and Marine Litter, and Coast and Hydrography.

The Monitoring Guidelines/Protocols, including this one related to sample preparation and analysis of seawater for IMAP Common Indicator 17 establish a sound ground for further regular update of monitoring practice for the purpose of successful IMAP implementation.

List of Abbreviations / Acronyms

CI	Common Indicator
COP	Conference of the Parties
CORMON	Correspondence Group on Monitoring
EcAp	Ecosystem Approach
EEA	European Environmental Agency
EC	European Commission
EFSA	European Food Safety Authority
EU	European Union
FAO	Food and Agriculture Organization of the United Nation
HELCOM	Baltic Marine Environment Protection Commission - Helsinki Commission
IAEA	International Atomic Energy Agency
IOC	International Oceanographic Commission
IMAP	Integrated Monitoring and Assessment Programme of the Mediterranean Sea and Coast and Related Assessment Criteria
MAP	Mediterranean Action Plan
MED POL	Programme for the Assessment and Control of Marine Pollution in the Mediterranean Sea
MED QSR	Mediterranean Quality Status Report
OECD	Organization for Economic Co-operation and Development
OSPAR	Convention for the Protection of the Marine Environment for the North-East Atlantic
PoW	Programme of Work
QA/QC	Quality Assurance/Quality Control
QSR	Quality Status Report
US EPA	United States Environmental Protection Agency

1 Introduction

1. According to IMAP requirements (UNEP/MAP, 2019¹ and UNEP/MAP, 2019a²) seawater is not included in the mandatory matrices to be analysed in the framework of the UNEP/MAP's Integrated Monitoring and Assessment Programme (IMAP), therefore no list of contaminants has been designated as mandatory for analysis. However, seawater pollution is an issue of concern that might be introduced at latter stage of the IMAP implementation. Therefore, at this stage of IMAP implementation, it is recommended that seawater monitoring is carried out on a country decision basis, including contaminants that countries consider more appropriate and technically feasible to be monitored.

2. Seawater analysis is a complex endeavour including sampling, sample processing and analysis, requiring careful design and implementation. The major analytical challenge of heavy metals and organic contaminants analysis in seawater, is their extremely low concentrations (especially in offshore areas), which requires an ultra-clean laboratory's environment to avoid cross-contamination of the samples, appropriate analytical equipment to accurately measure ultra-low concentration and appropriate staff expertise for this kind of analysis.

3. The Protocols prepared in the framework of this Monitoring Guidelines for Sample Preparation and Analysis of Seawater for IMAP Common Indicator 17, as provided here-below, describe appropriate methodologies for the analysis of seawater for the determination of heavy metals and organic contaminants, in order to ensure quality assured data. They are not intended to be analytical training manuals, but guidelines for Mediterranean laboratories, which should be tested and modified in order to validate their final results. These Protocols aim at streamlining marine seawater sample preparation and analysis for heavy metals and organic contaminants in a view of assuring comparable quality assurance of the data, as well as comparability between sampling areas and different national monitoring programmes, by providing a step-by-step guidance on the methods to be applied in the Mediterranean.

4. In order to avoid unnecessary repetitions, reference is also made to the protocols already published and publicly accessible, which can also be used by the Contracting Parties' competent laboratories participating in IMAP implementation. Regarding the analysis of heavy metals, here-below elaborated IMAP Protocols build on the Guidelines/Protocols developed by GEOTRACES, HELCOM (Annexes I and VI), ICES/OSPAR (Annex VII) and US EPA (Annex III), as well as on analytical methods which have been developed by UNEP/IAEA for sediment (Annexes II, IV and V). Given the suitability of any of these Guidelines in the context of IMAP, they could be further used by interested IMAP competent Mediterranean laboratories for developing their laboratory specific sampling and sample processing methodologies. The Contracting Parties' laboratories should accommodate and always test and modify each step of the procedures to validate their results.

5. The below flow diagram informs on the category of this Monitoring Guideline related to sample preparation and analysis of seawater for IMAP Common Indicator 17 within the structure of all Monitoring Guidelines prepared for IMAP Common Indicators 13, 14, 17, 18 and 20.

¹ UNEP/MAP (2019). UNEP/MED WG.467/5. IMAP Guidance Factsheets: Update for Common Indicators 13, 14, 17, 18, 20 and 21: New proposal for candidate indicators 26 and 27;

² UNEP (2019 a). UNEP/MED WG.463/6. Monitoring Protocols for IMAP Common Indicators related to pollution;

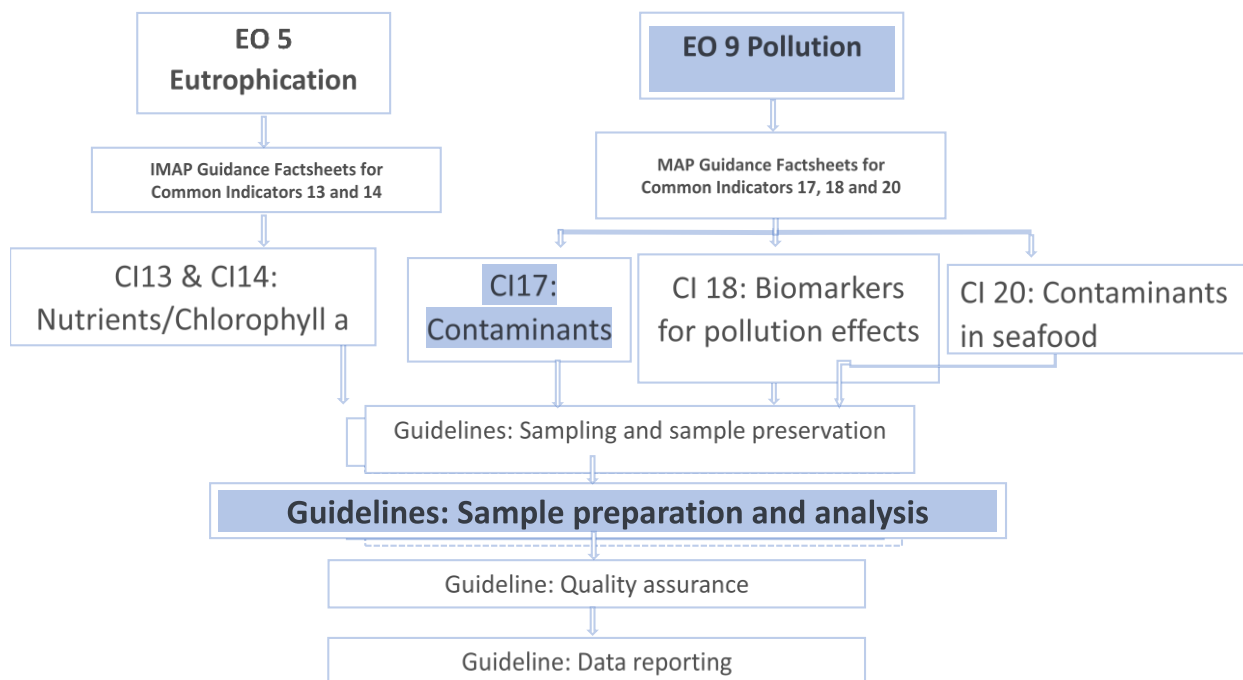

Flow Diagram: Monitoring Guidelines for IMAP Ecological Objectives 5 and 9

2 Technical note for the preparation and analysis of seawater samples for heavy metals³

6. Given no list of heavy metals has been agreed as mandatory for analysis in seawater, at this stage of IMAP implementation, Contracting Parties to the Barcelona Convention may decide to include in their seawater monitoring programmes the analysis of metals according to their national priorities. However, since Cadmium (Cd), Lead (Pb) and Total Mercury (THg) are the mandatory metals to be determined in marine sediment and biota samples in the framework of IMAP (UNEP/MAP, 2019), it makes sense to include these contaminants in any voluntary seawater monitoring programme.

7. National laboratories may decide to use any validated analytical method they consider appropriate, which meets specific performance criteria (LOD, LOQ, precision, recovery and specificity). However, in order to assist analytical laboratories of the Contracting Parties, the IMAP Protocols were developed in order to be used as guidelines for the analysis of heavy metals in seawater samples. Analytical laboratories should accommodate, test and modify each step of the procedures presented in the Protocols in order to validate their final results. The list of methods and analytical equipment is not exhaustive, and laboratories are encouraged to use their own equipment/methods that consider adequate for the required analyses.

a) Analysis of heavy metals

8. Seawater analysis could be performed using unfiltered or filtered (0.45 µm) seawater samples. If the analysis is performed on unfiltered seawater, the sample is analysed following directly the appropriate protocol. In this case a seawater sub-sample has to be filtered to record the suspended particulate matter (SPM) content. If both the filtered seawater and the relative SPM are analysed, the later has to be digested following the protocols for sediment digestion, as presented in Protocol for SPM digestion using nitric acid and hydrofluoric acid of the present Guideline.

³ The term “heavy metals” used in the Guideline refers to both heavy metals and trace elements

9. Because of the expected dissolved metal concentration range (10^{-4} - 10^{-6} mg kg⁻¹) and the salt matrix interference during the measurement process, preconcentration techniques and/or the elimination of sea salt has to be carried out prior to the analysis of the dissolved phase. For the analysis of the SPM retained in the filter, a first step of digestion is required, using an acid mixture (HCl, HNO₃ and HF). The determination of metals in seawater and digested SPM samples could be done with analytical techniques, such as GF-AAS, ICP-MS, ICP-AES (ICP-atomic emission spectrometry), electrochemical methods, or total-reflection X-ray fluorescence (TXRF).

10. Regardless of the analytical method used, heavy metal analysis follow some procedures common to all analytical methodologies, such as the calibration of the analytical equipment and the cleaning and handling procedures to avoid the contamination of the samples from the laboratory's environment and the tools and containers used in the analysis.

b) Calibration

11. Calibration standards should be prepared from single standard stock solutions or multielement standards by dilution of the stock solution using dilute acid, as required. All standard solutions have to be stored in polyethylene, borosilicate or quartz volumetric flasks. Standard solutions with lower concentrations, if prepared correctly and controlled in a QA system (checking of old versus new standards, and checking with standards from a different source), can be kept for a period no longer than one month.

12. The calibration procedure has to meet some basic criteria in order to give the best estimate of the true element concentration of the sample analysed (HELCOM, 2012a⁴) (Annex I):

- i) The concentrations of standards for the preparation of the calibration curve (function) should cover the range of concentrations as related to practical conditions; the mean of the range should be roughly equal to the expected analyte concentration in the sample;
- ii) The required analytical precision should be known and achievable throughout the entire range of concentrations;
- iii) The measured value (instrument signal) at the lower end of the range has to be significantly different from the procedural analytical blank;
- iv) The chemical and physical properties of the calibration standards must closely resemble those of the sample under investigation, i.e. the difference in density between the standard and environmental sample should be minimized (this is of particular importance in flame atomic absorption determinations);

13. The concentrations of standards for the preparation of the calibration curve should cover the range of concentrations as related to practical conditions; the mean of the range should be roughly equal to the expected analyte concentration in the sample.

c) Avoiding sample contamination

14. To avoid metal contamination in the laboratory all glassware and plastic vessels used should be carefully cleaned. The general cleaning guidelines include:

- i) Allow the vessels to soak overnight in a plastic container in an alkaline surfactant solution (e.g., Micro solution 2% in tap or distilled water).
- ii) Rinse thoroughly first with tap water then with ultrapure deionised water.
- iii) Leave the vessels to stand in 10% (v/v) concentrated analytical grade HNO₃ solution at room temperature for at least 6 days.
- iv) Rinse thoroughly with ultrapure deionised water (at least 4 times).
- v) Allow the vessels to dry under a laminar flow hood.

⁴ HELCOM (2012a). Manual for marine monitoring in the COMBINE programme. Annex B-11, Appendix 1. Technical Note on the determination of trace metals (Cd, Pb, Cu, Co, Zn, Ni, Fe) including mercury in seawater.

- vi) Store the vessels in closed plastic polyethylene zip-lock bags to prevent the risk of contamination prior to use.
15. This procedure should be used for all plastic ware use in the laboratory as tips, cup for autosampler, plastic containers.
16. Under this Technical Note, this Guidelines for sample preparation and analysis of sea water samples for heavy metals provides the following IMAP Protocols:
- Protocol for SPM digestion using nitric acid and hydrofluoric acid;
 - Protocol for the analysis of heavy metals in seawater with Graphite Furnace Atomic Absorption Spectroscopy (GF-AAS);
 - Protocol for the analysis of heavy metals in seawater with Inductive Coupled Plasma – Mass Spectroscopy (ICP-MS);
 - Protocol for the analysis of THg in seawater with Cold Vapour- Atomic Fluorescence Spectroscopy (CV-AFS).
17. These Protocols are based on Guidelines developed by GEOTRACES⁵, HELCOM (2012a) (Annex I), ICES/OSPAR (2012⁶) (Annex VII) and US EPA (1995⁷) (Annex III). Analytical methods are also based on similar methods, which have been developed for other media (sediment) (IAEA, 2012⁸ (Annex II).

2.1 Protocol for SPM digestion using nitric acid and hydrofluoric acid

18. Suspended Particulate Matter (SPM) samples have to be digested prior to analysis. The rate of digestion and the efficiency of acid decomposition increase substantially with elevated temperatures and pressure, therefore microwave digestion in closed vessels is the preferred method. However, in case no such equipment is available, sample digestion over a hot plate is an alternative method. The digestion method dissolves completely the filter material, therefore it is of paramount importance to use a filter material with very low metal content, to avoid misinterpretation of the results (polycarbonate or cellulose acetate).

19. The use of hydrofluoric acid (HF) is required for a complete disintegration of the silicate matter of SPM and the determination of the total metal load. Furthermore, Certified Reference Materials (CRMs) of sediments, which can be used also for SPM analysis, provide certified values for total metal concentrations, therefore their use to strengthen data quality assurance requires the measurement of the total metal content in SPM samples.

a) Microwave acid digestion in closed systems (for heavy metals for GFAAS and ICP-MS analysis)

20. SPM digestion can be performed in Teflon closed vials, under heat and pressure, following the methodology proposed for sediments (Loring and Rantala, 1991⁹). Filters with SPM, with already known weight of SPM, are transferred to a Teflon vial inside a laminar hood compatible with acid fume. Then the protocol for sediment digestion is followed (IAEA, 2012¹⁰). Approximately 5 ml of nitric acid and 2 ml of hydrofluoric acid are added and each vessel and let to react for at least 1 hour (or more if possible). After the room temperature pre-digestion, 2ml of hydrogen peroxide are added carefully, the vessels are closed and placed in the microwave apparatus and digestion steps are followed, following the IAEA's "Analysis of trace metals in biological and sediment samples: Laboratory procedure book" (Annex II, IAEA 2012). Because closed vessels retain the HF, boric acid

⁵ GEOTRACES (2017). Sampling and Sample-handling Protocols for GEOTRACES Cruises (Version 3), edited by the 2017 GEOTRACES Standards and Intercalibration Committee.

⁶ ICES/OSPAR (2012). JAMP guideline on monitoring of contaminants in seawater: Annex 1: Guidelines for Monitoring of Contaminants in Seawater. ICES Advice 2012, Book 1

⁷ US EPA (1995). Method 1640: Determination of trace elements in ambient waters by on-line chelation preconcentration and Inductively Coupled Plasma Mass Spectrometry.

⁸ IAEA (2012). Analysis of trace metals in biological and sediment samples: Laboratory procedure book

⁹ Loring DH and Rantala RTT (1991). Manual for the geochemical analyses of marine sediments and suspended particulate matter. Earth-Science Review, 32: 235:283. Elsevier Science Publishers B.V

¹⁰ IAEA (2012). Analysis of trace metals in biological and sediment samples: Laboratory procedure book

is added after the HF digestion to complex the remaining HF and make the resulting solution less hazardous, as well as preventing aluminium fluoride precipitation. After digestion the vessels are removed from the microwave apparatus and placed in a ventilated fume hood to cool. When the pressure is adequate, the vessels are opened and their content is transferred to a volumetric flask and made to a known volume. All reagents used are analytical grade.

b) Acid digestion on a hot plate

21. A method for the digestion of filters and SPM using HF and HNO₃ in Teflon containers on a hot plate are proposed by GEOTRACES (2017). The use of HF is essential because it is the only acid that completely dissolves the silicate lattices and releases all the metals.

22. Digestion procedure with complete destruction of the filter material

- i) Ideally, one filter is to be digested per digestion vial.
- ii) 10% HF/50% HNO₃ (v/v) digest solution is recommended in order to achieve complete dissolution of all particle types, and in particular to bring all lithogenic material in solution.
- iii) MF-Millipore filters are placed in the bottom of the vial because a complete digestion of the cellulose filter is achieved in under these conditions.
- iv) 47 mm filters are cleanly cut in half using a ceramic blade scalpel, or rotary cutter and the halves placed on opposite sides of the vial for refluxing.
- v) Typically, for a 25 mm diameter filter, add 1 mL of 50% HNO₃/10% HF solution to each vial. Roll acid around inside vial to ensure full contact with filter.
- vi) Close the caps tightly and place vials on a Teflon or silicone surface hot plate at 130° C for 4 hours.
- vii) After a cool down period, collect all the droplets from the cap and inside of the vials down to the bottom of the vial by either tapping the sealed vials or rolling the solution around.
- viii) Dry down the solution on the hot plate at 130° C. Watch it until near dryness, reducing heat as necessary. Remove when droplet is reduced to <5 µL volume.
- ix) This step reduces the HF in the sample and allows the matrix to be switched to dilute nitric acid for analysis. Heat lamps cleanly mounted above the hot plate may help prevent condensation on vial walls.
- x) If desired, add 100 µL concentrated HNO₃, directly onto residual droplet, and dry down again to same size droplet. This ensures sufficient HF removal so that glass and quartz components of the introduction system of the analytical instrument are not etched or degraded.

2.2 Protocol for the analysis of heavy metals in seawater with GF-AAS

23. In seawater Al, Cd, Pb, Cu, Cr, Ni, as well as other metals, can be determined by Graphite Furnace Atomic Absorption Spectroscopy (GF-AAS), which has adequate sensitivity for these determinations. Direct analysis of seawater is limited by very low metal concentrations and spectral and non-spectral interferences caused by the sea water matrix, therefore a preconcentration step for matrix removal is often used before analysis.

24. Prior to analysis, dissolved metals can be pre-concentrated on Chelex-100 resin (Kingston, et al, 1978¹¹). The pH of the seawater samples is adjusted to 5 – 5.5 and the sample is passed through a Chelex-100 resin. Alkali and alkaline earth metals are then eluted from the resin with ammonium acetate (CH₃COONH₄) and the trace elements are eluted with two 5 ml aliquots of 2.5 M HNO₃. The whole processing of seawater samples, including metal pre-concentration has to be done under clean conditions (ISO Class 5 clean room) taking precautions to avoid any metal contamination of the samples (appropriate clothing including gloves). All reagents are analytical grade. The pre-concentration system consists of a column of a chelating resin, a sample loop constructed for a narrow-bore, high pressure inert tubing (such as ethylene tetra-fluoroethylene - ETFE), an eluent

¹¹ Kingston, H.M., Barnes, I.L., Brady, T.J., Rains, T.C., and Champ, M.A. (1978). Separation of eight transition elements from alkali and alkaline earth elements in estuarine and seawater with chelating resin and their determination by graphite furnace atomic absorption spectrometry. *Analytical Chemistry*, 50 (14): 2064-2070.

pumping system to deliver one or two eluents, argon gas supply and solution reservoirs (US EPA Method 1640, 1995; Annex III).

25. Automatic pre-concentration of metals in seawater can be achieved using the SeaFAST system, which improves elemental detection limits in undiluted seawater by both preconcentrating analyte and eliminating matrix components. The system can be operated off-line using a chelation column to pre-concentrate metals prior to analysis.

26. The pre-concentrated seawater sample is then analysed for heavy metals by GF-AAS, following the analytical protocol prepared by IAEA (2012) presented in the Annex II. Analysis of trace metals in biological and sediment samples

2.3 Protocol for the analysis of heavy metals in seawater with ICP-MS

27. Inductive Coupled Plasma – Mass Spectroscopy (ICP-MS) is currently state-of-the-art instrumentation for metal analysis, with the possibility to determine at sub- $\mu\text{g/L}$ concentrations of a large number of elements in water. However, direct analysis of seawater is limited by spectral and non-spectral interferences caused by the sea water matrix, therefore a preconcentration step for matrix removal is often used before analysis.

28. ICP-MS allows a rapid analysis of a wide range of heavy metals. Most routine instruments utilize a quadrupole mass spectrometer, so mass resolution is not high enough to avoid overlap of double charged elements or multi-element ions (mainly hydrides, oxides and hydroxides) formed in the plasma. The main concern is for the Argon (Ar) interferences as the plasma is usually an argon plasma, overlapping with As. Some elements are prone to memory effects (particularly Hg) and needs extra precautions to avoid carry over effects (HELCOM 2012a).

29. A multi-elemental determination of heavy metals by ICP-MS in water samples is described in the US EPA Method 1640 (1994). The method includes a first preconcentration step with a chelating resin (i.e. Chelex 100) using a system consisting of a column with the chelating resin, a sample loop constructed for a narrow-bore, high pressure inert tubing, an eluent pumping system to deliver one or two eluents, argon gas supply and solution reservoirs. The preconcentration system is linked with the ICP-MS for metal determination. The US EPA Method 1640 is presented in Annex III. . The automate SeaFAST metal preconcentration system can be operated in-line, linked to the ICP-MS.

2.4 Protocol for the analysis of Total Mercury in seawater with CV-AFS

30. Total mercury in seawater can be analysed efficiently using Cold Vapour Atomic Fluorescence Spectroscopic (CV- AFS) and Inductively Coupled Plasma-Mass Spectrometry (ICP-MS) (with isotope dilution). Cold Vapour Atomic Absorption Spectrometry (CV-AAS) is not a preferable method for Mercury analysis because according to GEOTRACES's (2017) intercalibration exercises, the method does not exhibit adequate sensitivity to detect total Hg. CV-AFS has the advantage to allow rapid determination of total Hg and DGM ($\text{Hg}^0 + (\text{CH}_3)_2\text{Hg}$) at sea, while ICP-MS has the potential for a lower absolute detection limit. A recommended Hg workflow for the determination of total Hg in seawater with CV-AFS is presented in the Sampling and Sample-handling Protocols for GEOTRACES Cruises (GEOTRACES, 2017).

3 Technical note for the preparation and analysis of seawater samples for organic contaminants

31. As already elaborated above for metals, the Contracting Parties to the Barcelona Convention may decide to include in their seawater monitoring programmes the analysis of organic contaminants according to their national priorities, given no list of organic contaminants has been agreed as mandatory for analysis in seawater, at this stage of IMAP implementation. However, since chlorinated hydrocarbons and PAHs are mandatory contaminants to be determined in marine sediments and biota in the framework of IMAP (UNEP/MAP, 2019; UNEP/MAP 2019a), it makes sense to include these contaminants in any voluntary seawater monitoring programme.

32. Same analytical methods can be used for the determination of lipophilic pollutants in extracts of water samples as are used for extracts of sediments. However, the distribution of contaminants in

seawater are influenced by their polarity. Therefore, more hydrophilic organic compounds (such as 2- and 3-ring PAHs and HCH isomers) are distributed in the dissolved phase, while more lipophilic compounds (such as 4- to 6-ring PSHs, DDT group and PCBs) are mainly found in SPM.

33. In monitoring programmes, total seawater (unfiltered) is usually analysed for organic contaminants. The analytical procedure includes the simultaneous extraction of organic contaminants from seawater, clean-up and analytical determination. The extraction of the organic contaminants is also concentrating the compounds enabling their enrichment in the solution to be analysed. This is an important step, since the concentrations of the organic contaminants in total seawater are extremely low (from 10 pg L^{-1} to 10 ng L^{-1} , HELCOM, 2012b¹²). Extraction can be done by liquid-liquid extraction (LLE) (using a non-polar solvent such as hexane) or by solid-phase extraction (SPE). It has to be emphasized that all steps of the procedure are susceptible to insufficient recovery and/or contamination. Therefore, regular quality control procedures must be applied to check the performance of the whole method.

34. A description of the procedures for the extraction seawater by liquid-liquid extraction (LLE) and solid-phase extraction (SPE) are presented in the “Technical Note on the determination of persistent organic pollutants in seawater” of HELCOM (2012b). It is noted that the SPE has the advantage of being able to extract very large water volumes (up to 1000 l) and to incorporate a phase separation to obtain separate samples for SPM and the solute phase. However, the method requires longer sampling time, more complex instrumentation, and problems with validation and control of the extraction efficiency. On the other hand, the LLE has the advantage that it can be easily validated and controlled, as internal standards can be added before extraction. The limitation in sample volume is only relative, since sampling volume of 100 l is sufficient for nearly all monitoring tasks. HELCOM (2012b) concludes that “Because of the robustness of the method, there is a preference LLE for routine monitoring purposes for all lipophilic organic contaminants”.

35. Although there are less interferences from matrix compounds in seawater samples than in sediments or biota, extracts require a clean-up before the chromatographic separation and determination. A clean-up procedure using short silica gel chromatography columns that can be applied with GC-ECD and GC-MS methods, is proposed by HELCOM (2012b), using silica dried at 200°C and subsequently washed with CH_2Cl_2 and hexane. The hexane sample extract is applied on top of the column and eluted with CH_2Cl_2 /hexane and then with acetone. Fraction 1 contains all lipophilic compounds of interest (PAHs and all chlorinated hydrocarbons (from HCB to HCH)); this fraction can be used for GC-MS determination after concentration to 50–300 μl . All reagents are of analytical grade.

36. Following the simultaneous extraction and clean-up, the determination of organochlorine pesticides - PCBs and PAHs will be done following the respective analytical procedures. National laboratories may decide to use any validated analytical method they consider appropriate, which meets specific performance criteria (LOD, LOQ, precision, recovery and specificity). The here-below proposed IMAP analytical Protocols are based on the HELCOM (2012b) guidelines for organic contaminants analysis in seawater and the analytical methods developed by UNEP/IAEA (2011a¹³) (Annex IV), UNEP/IAEA(2011b¹⁴) (Annex V) for the analysis of these contaminants in sediment matrix. Analytical laboratories should accommodate, test and modify each step of the procedures presented in here-below provided IMAP Protocols in order to validate their final results. The list of methods and analytical equipment is not exhaustive, and laboratories are encouraged to use their own equipment/methods that consider adequate for the required analyses.

¹² HELCOM (2012b). Manual for marine monitoring in the COMBINE programme. Annex B-11 Appendix 2: Technical annex on the determination of heavy metals and persistent organic compounds in seawater. Appendix 2. Technical note on the determination of persistent organic compounds in seawater

¹³ UNEP/IAEA (2011a). Sample work-up for the analysis of selected chlorinated hydrocarbons in the marine environment. Reference Methods for Marine Pollution Studies No 71

¹⁴ UNEP/IAEA (2011b). Recommended method on the determination of petroleum hydrocarbons in sediment samples.

37. Under this Technical Note, this Guidelines for sample preparation and analysis of sea water samples for organic compounds provides the following IMAP Protocols:

- Protocol for the analysis of organochlorine pesticides and PCBs in seawater using Gas Chromatography - Electron Capture Detector (GC-ECD) or Gas Chromatography - Mass Spectroscopy (GC-MS);
- Protocol for the analysis of PAHs in seawater using Gas Chromatography - Flame Ionization Detector (GC-FID) or Gas Chromatography - Mass Spectroscopy (GC-MS).

38. These protocols are based on Analytical Methods developed by UNEP/IAEA (Annex IV: Sample work-up for the analysis of selected chlorinated hydrocarbons in the marine environment. Reference Methods for Marine Pollution Studies No 71; Annex V: Recommended method for the determination of petroleum hydrocarbons in sediment samples), HELCOM (Annex VI: Manual for marine monitoring in the COMBINE programme. Annex B-11, Appendix 2. Technical note on the determination of persistent organic pollutants in seawater) and ICES/OSPAR (Annex VII: JAMP Guidelines for monitoring contaminants in seawater).

3.1 Protocol for the analysis of organochlorine pesticides and PCBs in seawater using GC-ECD or GC-MS

39. Following extraction and clean-up, as described in the Technical Note for the preparation and analysis of seawater samples for organic contaminants, organochlorine pesticides and PCBs can be analysed by GC-ECD or GC-MS following the guidelines for the analysis of sediment and biota matrices proposed by UNEP/IAEA (2011a) (Annex IV), HELCOM (2012b) (Annexes VI) or ICES/OSPAR (Annex VII).

3.2 Protocol for the analysis of PAHs in seawater using GC-FID or GC-MS

40. Following extraction and clean-up, as described in the Technical Note for the preparation and analysis of seawater samples for organic contaminants, PAHs can be analysed by GC-FID or GC-MS following the guidelines for the analysis of sediment and biota matrices proposed by UNEP/IAEA (2011b) (Annex V), HELCOM (2012b) (Annex VI) or ICES/OSPAR (Annex VII).

Annex I

HELCOM (2012a). Manual for marine monitoring in the COMBINE programme. Annex B-11, Appendix 1. Technical Note on the determination of trace metals (Cd, Pb, Cu, Co, Zn, Ni, Fe) including mercury in seawater.

HELCOM Manual for marine monitoring in the COMBINE programme

ANNEX B-11 TECHNICAL NOTE ON THE DETERMINATION OF HEAVY METALS AND PERSISTENT ORGANIC COMPOUNDS IN SEAWATER

ANNEX B-11, APPENDIX 1. TECHNICAL NOTE ON THE DETERMINATION OF TRACE METALS (CD, PB, CU, CO, ZN, NI, FE), INCLUDING MERCURY, IN SEAWATER

Introduction

General techniques which address the questions of water sampling, storage, filtration procedures and determination of trace metals in natural sea water are described by Sturgeon and Berman (1987) and Gill and Fitzgerald (1985, 1987).

For the determination of mercury in sea water, the chemical species of this element are of importance. Therefore, a differentiation between the several Hg species, including ionic, volatile, dissolved (organic) complexes or particulate adsorbed Hg, has to be considered during sample preparation.

Several definitions of mercury compounds are common (Cossa et al., 1996, 1997), for example:

Reactive mercury (HgR): A methodologically defined fraction consisting mostly of inorganic Hg(II).

Total mercury (HgT): Mercury content of an unfiltered sample, after digestion with an oxidizing compound (e.g., K MnO₄).

Total dissolved mercury: Mercury content of a filtered sample, after digestion with an oxidizing compound (e.g., K MnO₄).

Dissolved gaseous mercury (DGM): This includes elemental mercury (Hg), monomethylmercury (MM-Hg) and dimethylmercury (DM-Hg).

1. CLEAN LABORATORY; CLEAN BENCHES

Particles are everywhere, including dust in the air or on clothes, hair or skin. Owing to the clothes, the person who is working with the samples for trace metal analysis is the main source of contamination because this person is a particle producer. One of the most important things during sample pretreatment for trace metal analysis is to eliminate particles that can contaminate the samples or the sample containers from the laboratory environment.

The best way to eliminate most of this contamination is to work under a laminar flow box with a laminar horizontal flow (sample protection). Recommended conditions for a 'clean bench' or a 'clean lab' are class 100 (US Norm) which means that there are still about one hundred particles present per cubic foot or class 3 (DIN-Norm), which equals 3000 particles per m³ (corresponding to class 100 US Norm).

2. PREPARATIONS

Chemicals

High purity water (e.g., 'Milli-Q water', 18 M cm⁻¹) freshly prepared, is termed 'water' in the following text.

A sub-boiling quartz still is recommended for the distillation of highly purified acids and solvents. A teflon still is recommended for the distillation of HF.

Amalgamation (filtration of oversaturated solutions with goldnet) and volatilization (bubbling with ultrapure argon) are effective methods to purify (clean) chemicals and solutions for mercury analysis.

In order to avoid contamination problems, all plastic ware, bottles and containers must be treated with acids (HCl or HNO₃) for several weeks and then rinsed with water and covered in plastic bags until use.

The following procedures (Patterson and Settle, 1976) are suggested:

Laboratory ware

Store in 2M HCl (high purity) for one week, rinse with water, store in water for one week and dry under dust-free conditions (clean bench).

Samplers and bottles

Sampling devices: Fill with 1% HNO₃ (high purity), store at room temperature for three weeks, and rinse with water .

Teflon/quartz bottles: Store in warm (40 C ±5 C) 1:1 diluted HCl for one week. Then rinse with water and store with 1M HNO₃ (high purity) until the final use (a minimum of three weeks).

Modified cleaning procedures are required for mercury. Glass containers (borosilicate, quartz) used for the collection and storage of samples for the determination of mercury are usually cleaned using an oxidizing procedure described by Sturgeon and Berman (1987). Bottles are filled with a solution of 0.1 % KMnO₄, 0.1% K₂S₂O₈ and 2.5 % HNO₃ and heated for 2 hours at 80 C. The bottles are then rinsed with water and stored with 2 % HNO₃ containing 0.01 % K₂Cr₂O₇ or KMnO₄ until ready for use.

Filters

Polycarbonate filters (e.g., Nuclepore) (0.4 m, 47 mm diameter) are recommended for trace metals except mercury. Store the filters in 2M HCl (high purity) for a minimum of three weeks. After rinsing with water, store for one more week in water.

For the determination of mercury, glass microfibre filters (GF/F grade, Millipore type) and teflon filters are recommended for the filtration of natural water samples. Cleaning of these filters is comparable to the procedure used for polycarbonate filters. For GF/F filters, an additional drying step has to be considered (450 C for 12-24 hr) to volatilize gaseous mercury. This procedure is described in detail by Queremais & Cossa (1997).

If trace metals in suspended particulate matter (SPM) are to be determined, filters have to be placed in precleaned plastic dishes, dried in a clean bench for two days, and stored in a desiccator until they are weighed using an electronic microbalance with antistatic properties. Each filter has to be weighed daily for several days until the weight is constant. The same procedure for drying and weighing should be applied to the filters loaded with SPM (Pohl, 1997).

3. SAMPLING AND SAMPLE HANDLING

The basis for the reliable measurement of extremely low concentrations of trace metals in sea water is a well-performed sampling to avoid contamination risk from the ship. Careful handling is recommended because copper and tin are still the main substances used in antifouling paints on ships and there is also a risk of contamination by zinc (anodes of the ship), iron or lead.

In coastal and continental shelf waters, samples are collected using 30 l teflon-coated GO-FLO (General Oceanics, close-open-close system) bottles with teflon O-rings deployed on Kevlar or on a Hostalen coated wire. Niskin bottles deployed on rosettes using standard stainless steel hydrowire are also acceptable. For surface waters, an all-teflon MERCOS-Sampler (Hydrobios) could be chosen.

PVC gloves should be worn during subsampling into the precleaned quartz or teflon bottles (teflon has an extra low content of trace metals). Subsampling should be carried out in a clean lab or a clean-lab container, if available.

Pumping of samples using peristaltic or teflon piston pumps must be carried out using precleaned silicon- or teflon-lined tubes.

In the absence of clean-lab conditions, sampling and sample handling must be carried out in a closed system, or contamination cannot be avoided.

For mercury analysis, it should be noted that the integrity during sampling and storage may be jeopardized by the addition of mercury to the sample as well as by unexpected losses owing to volatilization.

4. FILTRATION PROCEDURE

In the environmental and geochemical scientific community concerned with water analysis, it has generally been accepted that the term 'dissolved' refers to that fraction of water and its constituents which have passed through a 0.45 µm membrane filter. This is an operationally defined fraction. Coastal and shelf water samples have to be filtered to eliminate particles from the water. A number of metal species pass through this filter pore size, including metals bound to colloids or clays or to humic, fulvic, amino, and fatty acids.

To prevent desorption of metal ions from particle surfaces or from biological degradation of SPM, separation between the dissolved phase and the particulate phase has to be done immediately after sampling by filtering the water through a 0.45 µm polycarbonate filter. This procedure should be carried out under clean conditions (clean benches are recommended on board the ship).

If metals in both the dissolved and particulate phases are to be analysed, pressure filtration with nitrogen is recommended. After filtration the filter should be rinsed with high purity isotonic solution to remove sea salt residues. Only a few millilitres are necessary because a change of pH could cause desorption of metal ions from the particles. In pumping systems, on-line filtration is possible.

5. STORAGE OF SAMPLES

To avoid wall adsorption of metal ions, 1.5 ml HNO₃ or HCl (high purity) should be added per litre of seawater sample immediately after filtration for acidification to pH 1.0-1.6. The sample containers should be stored in plastic bags under controlled environmental conditions. The filters should be stored in plastic dishes at -18 °C or below. Under these conditions, both water samples and SPM on filters can be stored for at least one year.

Special consideration must be given to samples destined for Hg determinations. It is necessary to add either oxidants (Cr₂O₇²⁻) in addition to acidification or complexing agents (cysteine) to neutral or alkaline samples to prevent Hg losses during storage.

6. SAMPLE PRETREATMENT

Water samples

Depending on the expected concentration range (10⁻⁷-10⁻⁹ g kg⁻¹) of trace metals (dissolved) in Baltic Sea water and because of the salt matrix interfering during the measurement process, preconcentration techniques and/or the elimination of sea salt has to be carried out prior to the analytical measurement. Detailed method information is available in the open literature (e.g., Danielsson et al., 1978; Kremling et al., 1983; and Pohl, 1994).

Filters

Different methods to analyse the material on the filter are described by Hovind and Skei (1992) and Loring and Rantala (1991). Pressure decomposition with an acid mixture (HCl, HNO₃, HF) is recommended. If the silica content is high due to diatoms, the HF concentration should be increased accordingly. If the organic content increases, it is advisable to work with perchloric acid.

Depending on the digestion system used (high pressure autoclave, microwave digestion, wet ashing in an open system, or dry ashing), the completeness of the digestion is a function of temperature, time, digestion material and pressure, and has to be tested and validated in pilot studies with (certified) reference materials (see the detailed remarks in Annex B-7, Section 4.3).

Digestion of samples for mercury analysis must always be carried out in a closed system to prevent losses by evaporation.

7. INSTRUMENTATION

For the analytical measurements, several analytical techniques can be used, such as GFAAS (graphite furnace atomic absorption spectrometry), electrochemical methods, ICP-MS (inductively coupled plasma-mass spectrometry), ICP-AES (inductively coupled plasma-atomic emission spectrometry), or total-reflection X-ray fluorescence (TXRF).

Because of the very low mercury concentrations in sea water, the most widely used technique for mercury is the cold vapour technique (reduction of mercury with SnCl₂ to elemental Hg) and preconcentration of mercury by amalgamation on a gold trap. This is followed by atomic absorption spectrometry or by atomic fluorescence spectrometry, with detection limits adequate for the purpose. In the case of anoxic (sulfur-containing waters), see Annex B-11.

8. QUALITY CONTROL

The internal quality control is described in Chapter B.5 of the Manual.

Blank

Particularly in the case of trace metal analysis, with high contamination risks at each step of the analytical work, a satisfactory blank control is necessary. Therefore, it is important to control the blank daily, for reproducibility and constancy over a longer time. The blank should include all analytical pretreatment procedures, including the addition of the same quantities of chemical substances as for the sample.

Calibration

For calibration purposes, single element standard stock solutions at a concentration of 1000 mg dm⁻³, purchased from a qualified manufacturer, should be available. Preparation date and concentration should be marked on the bottle. From this stock solution, a multi-element working standard solution can be prepared using dilute HCl or HNO₃ as required (normally 1M acid is used).

Traceability can be ensured by the use of CRMs or participation in intercomparison exercises.

The working standard should be prepared from the stock standard solution for every batch of samples and kept no longer than two weeks. Precleaned teflon containers are preferable for storage.

To evaluate effects from the matrix, the method of standard addition can be used, particularly in connection with the analytical method of voltammetric stripping. For other techniques, the method of standard addition should generally be used with care (Cardone, 1986a, 1986b).

Reference materials

Owing to problems in defining the blank, the use of a low-concentration CRM is important. Regular participation in intercomparison exercises should be considered mandatory.

REFERENCES

Cardone, M. 1986a. New technique in chemical assay calculations. 1. A survey of calculational practices on a model problem. *Analytical Chemistry*, 58: 433-438.

Cardone, M. 1986b. New technique in chemical assay calculations. 2. Correct solution of the model problem and related concepts. *Analytical Chemistry*, 58: 438-445.

Cossa, D., Coquery, M., Gobeil, C., and Martin, J.M. 1996. Mercury fluxes at the ocean margins. In *Global and regional mercury cycles: sources, fluxes and mass balances*, pp. 229-247. Ed. by W. Baeyens et al. Kluwer Academic Publishers.

Cossa, D., Martin, J.M., Takayanagi, K., and Sanjuan, J. 1997. The distribution and cycling of mercury species in the western Mediterranean. *Deep Sea Research II*, 44(3-4): 721-740.

Danielsson, L.G., Magnusson, B., Westerlund, S. 1978. An improved metal extraction procedure for the determination of trace metals in sea-water by atomic absorption spectrometry with electrothermal atomization. *Analytica Chimica Acta*, 98: 47-57.

Gill, G.A., Fitzgerald, W.F. 1985. Mercury sampling of open ocean waters at the picomolar level. *Deep Sea Research*, 32(3): 287-297.

Gill, G.A., and Fitzgerald, W.F. 1987. Picomolar mercury measurements in seawater and other materials using stannous chloride reduction and two-stage gold amalgamation with gas phase detection. *Marine Chemistry*, 20: 227-243.

Hovind, H., and Skei, J. 1992. Report of the Second ICES Intercomparison Exercise on the Determination of Trace Metals in Suspended Particulate Matter. ICES Cooperative Research Report, No.184. 31 pp.

Kremling, K., Olafsson, I., Andreae, M., and Koroleff, F. 1983. Determination of trace metals. In *Methods of seawater analysis*. Ed. by K. Grasshoff, M. Ehrhardt, and K. Kremling. Verlag Chemie, Weinheim. 419 pp.

Loring, D.H., and Rantala, R.T.T. 1991. Manual for the geochemical analyses of marine sediments and suspended particulate matter. *Earth Science Reviews*, 32: 235-283.

Patterson, C., and Settle, D. 1976. The reduction of orders of magnitude errors in lead analysis of biological materials and natural waters by evaluating and controlling the extent and sources of industrial lead contamination introduced during sample collecting, handling, and analysis. In *Accuracy in trace analysis: Sampling, Sample handling, Analysis*, pp 321-351. Ed. by P. LaFleur. United States National Bureau of Standards Special Publication, No. 422.

Pohl, C. 1994: Meerwasser-Probennahme, Anreicherung und Analytik. In *Probenahme und Aufschluß*. Ed. by M. Stoeppler. Springer-Labormanual, Heidelberg, 181 pp.

Pohl, C. 1997. Trace Metals (Cu, Pb, Zn, Cd, Al, Li, Fe, Mn, Ni, Co) in Marine Suspended Particulate Matter: An International ICES Intercomparison Exercise. *Accreditation and Quality Assurance*, 2: 2-10.

Quémerais, B., and Cossa, D. 1997. Procedures for sampling and analysis of mercury in natural waters. Environment Canada-Quebec region, Environmental Conservation, St. Lawrence Centre. Scientific and Technical Report ST-31E, 34 pp.

Sturgeon, R., and Berman, S. 1987. Sampling and storage of natural water for trace metals. In *Critical reviews in Analytical Chemistry*. 18(3): 209-244. CRC Press.

Last updated: 29.10.2012 (Annex number changed from Annex B 12 to Annex B 11)

Annex II:

IAEA (2012). Laboratory Procedure Book: Analysis of trace metals in biological and sediment samples (4.1.1)



REPORT

Laboratory Procedure Book ANALYSIS OF TRACE METALS IN BIOLOGICAL AND SEDIMENT SAMPLES

**IAEA/NAEL Marine Environmental Studies Laboratory in co-operation with
UNEP/MAP MED POL**

November 2012

For further information on this method, please contact:

IAEA-Environment Laboratories
Marine Environmental Studies Laboratory
4a Quai Antoine 1er
MC-98000 Principality of Monaco

Tel. (377) 979 772 72; Fax. (377) 979 772 76
E-mail: NAEL-MESL.Contact-Point@iaea.org

Laboratory Procedure Book
ANALYSIS OF TRACE METALS IN BIOLOGICAL AND SEDIMENT SAMPLES

DISCLAIMER

This is not an official IAEA publication. The views expressed do not necessarily reflect those of the International Atomic Energy Agency or its Member States.

The material has not undergone an official review by the IAEA. This document should not be quoted or listed as a reference.

The use of particular designations of countries or territories does not imply any judgment by the IAEA, as to the legal status of such countries or territories, of their authorities and institutions or of the delimitation of their boundaries.

The mention of names of specific companies or products (whether or not indicated as registered) does not imply any intention to infringe proprietary rights, nor should it be construed as an endorsement or recommendation on the part of the IAEA.

Limited Distribution

Reproduced by the IAEA

TABLE OF CONTENTS

I. MICROWAVE-OVEN DIGESTION PROCEDURES.....	1
I-1. DIGESTION OF SEDIMENT FOR THE DETERMINATION OF.....	2
TRACE METAL	2
I-2. DIGESTION OF BIOTA FOR THE DETERMINATION OF TRACE METAL..	4
II. HOT PLATE DIGESTION PROCEDURES.....	6
II-1. DIGESTION OF SEDIMENT FOR THE DETERMINATION OF	7
TRACE METAL	7
II-2. DIGESTION OF BIOTA FOR THE DETERMINATION OF TRACE METAL.	9
II-3. DIGESTION OF BIOTA OR SEDIMENT FOR THE DETERMINATION OF TOTAL MERCURY BY COLD VAPOUR-AAS	11
III. INSTRUMENTAL TECHNIQUES	13
III.1. PREPARATION OF METAL STANDARD SOLUTIONS FOR THE CALIBRATION CURVE.....	14
III-2. DETERMINATION OF TRACE METALS IN SEDIMENT AND BIOLOGICAL MATERIALS BY GF-AAS	16
III-3. MATRIX MODIFIERS	25
TABLE 1. EXAMPLES OF GRAPHITE FURNACE CONDITIONS	27
III-4. DETERMINATION OF TRACE METALS IN SEDIMENT AND BIOLOGICAL MATERIALS BY FLAME-AAS	28
III-5. DETERMINATION OF TOTAL MERCURY IN SEDIMENT AND BIOLOGICAL SAMPLES BY VGA-AAS.....	33
IV. CLEANING PROCEDURES.....	39
IV-1. CLEANING GENERAL LABWARE FOR THE DETERMINATION OF	40
TRACE ELEMENTS	40
IV-2. CLEANING OF DIGESTION TEFLON VESSELS FOR THE DETERMINATION OF TRACE ELEMENTS.....	41
IV-3. CLEANING TEFLON LABWARE FOR THE DETERMINATION OF MERCURY AND METHYL MERCURY	42
IV-4. CLEANING LABWARE FOR THE DETERMINATION OF MERCURY BY VGA-CV-AAS; SIMPLIFIED PROCEDURE FOR TEFLON AND GLASSWARE	43

I. MICROWAVE-OVEN DIGESTION PROCEDURES

I-1. DIGESTION OF SEDIMENT FOR THE DETERMINATION OF TRACE METAL

Principle:

The sediment samples are treated in closed Teflon vessels with hydrofluoric acid (HF) in combination with nitric acid, in order to decompose the samples. The use of HF is essential as it is the only acid that completely dissolves the silicate lattices and releases all the metals.

Reagents:

- HNO₃ (65%, Suprapur, Merck).
- HF (48%, analytical grade ISO, Merck).
- H₂O₂ (analytical grade), to be kept in the fridge after opening.
- Boric acid crystals, H₃BO₃ (analytical grade ISO, Merck).
- Milli-Q deionised water (> 18MΩ cm, Millipore).

Procedure:

1. Shake the sample bottles for about 2 min. for homogenization.
2. Wait a few minutes before opening the bottles.
3. Weigh accurately about 0.2 g of dry sample in labeled Teflon reactor (CEM)
4. Slowly add 5 ml of HNO₃ and 2 ml of concentrated hydrofluoric acid (HF). If the samples are strongly reactive, leave them at room temperature for at least 1 hour.
5. After room temperature digestion add 2 ml of H₂O₂
6. Close the reactor and put them in a microwave oven.
7. Set up the correct program:

Step	Power (W)	% Power	Ramp time (min sec)	PSI	°C	Hold time (min sec)
1	1200	100	10.00	600	190	12.00

8. Allow for the samples to cool to room temperature, release pressure carefully by opening the valve, and then open the reactor.
9. Weigh 0.8 g of boric acid into a polyethylene weighing boat, transfer it to the reactor, then add about 15 ml of Milli-Q water

10. Close the reactor and put them in a microwave oven.

11. Set up the correct program:

Step	Power (W)	% Power	Ramp time (min sec)	PSI	°C	Hold time (min sec)
1	1200	100	10.00	600	170	12.00

12. Allow for the samples to cool to room temperature, release pressure carefully by opening the valve, and then open the reactor.

13. Label some polyethylene 50 ml tubes and record the weight of the empty tubes.

14. Transfer the samples into 50 ml polypropylene graduated tubes. Rinse the Teflon reactor with Milli-Q water 3 times.

15. Shake the tubes.

16. Allow them to cool and then dilute to the mark (50 ml) with Milli-Q water, weigh each tube and record the weight.

Reagent blanks:

At least 2 blanks should be prepared for each batch of analysis. They are prepared in a similar manner as the samples, except that no sample is added to the digestion vessels.

Reference materials:

At least one certified reference material should be used and prepared in duplicate for each digestion batch. These digestions are prepared in a similar manner as the samples. A reference material of similar composition and concentration range should be used.

I-2. DIGESTION OF BIOTA FOR THE DETERMINATION OF TRACE METAL

Principle:

The biological samples are treated with concentrated nitric acid in order to decompose the samples and solubilize all metals.

Reagents:

- HNO₃ (65%, Suprapur, Merck).
- H₂O₂ (analytical grade) to be kept in the fridge after opening.
- Milli-Q deionised water (> 18MΩ cm, Millipore).

Procedure:

1. Shake the samples bottles for about 2 min. for homogenization.
2. Wait a few minutes before opening the bottles.
3. Weigh accurately about 0.2 g of dry sample in labeled Teflon reactor (CEM)
4. Add 5 ml of concentrated Nitric acid (HNO₃). Leave the samples at room temperature for at least 1 hour.
5. Add 2 ml of H₂O₂.
6. Close the reactor and place them in a microwave oven.
7. Run the appropriate program:

Step	Power (W)	% Power	Ramp time (min sec)	PSI	°C	Hold time (min sec)
1	1200	100	5 00	600	50	5 00
2	1200	100	5 00	600	100	5 00
3	1200	100	10 00	600	200	8 00

8. Allow for the samples to cool to room temperature, release pressure carefully by opening the valve, and then open the reactor.
9. Label some polyethylene 50 ml tubes and record the weight of the empty tubes.
10. Transfer samples into the labeled 50 ml polypropylene graduated tubes. Rinse the Teflon tubes with Milli-Q water 3 times.
11. Dilute to the mark (50 ml) with Milli-Q water and shake.

12. Allow them to cool and then dilute to the mark (50 ml) with Milli-Q water, weigh each tube and record the weight.

Reagent blanks:

At least 2 blanks should be prepared for each batch of analysis. They are prepared in a similar manner as the samples, except that no sample is added to the digestion vessels.

Reference materials:

At least one certified reference material should be used and prepared in duplicate for each digestion batch. These digestions are prepared in a similar manner as the samples. A reference material of similar composition and concentration range should be used.

II. HOT PLATE DIGESTION PROCEDURES

II-1. DIGESTION OF SEDIMENT FOR THE DETERMINATION OF TRACE METAL

Principle:

The sediment samples are treated in closed Teflon vessels with hydrofluoric acid (HF) in combination with aqua regia, in order to decompose the samples. The use of HF is essential as it is the only acid that completely dissolves the silicate lattices and releases all the metals.

Reagents:

- HNO₃ (65%, Suprapur, Merck).
- HF (48%, analytical grade ISO, Merck).
- HCl (30%, Suprapur, Merck).
- Boric acid crystals, H₃BO₃ (analytical grade ISO, Merck).
- Milli-Q deionised water (> 18MΩ cm, Millipore).

Procedure:

1. Shake the sample bottles for about 2 min. for homogenization.
2. Wait a few minutes before opening the bottles.
3. Weigh accurately about 0.2 g of dry sample in labeled Teflon tubes (FEP, 50 ml, Nalgene)
4. Slowly add 1 ml of aqua regia (HNO₃: HCl, 1:3 v/v) and 6 ml of concentrated hydrofluoric acid (HF). Leave the samples at room temperature for at least 1 hour.
5. Close the tubes and place them in an aluminum block on a hot plate at 120°C for 2hrs 30min.
6. Weigh 2.70 g of boric acid into the labeled 50 ml polypropylene graduated tubes or volumetric flask, then add about 20 ml of Milli-Q water and shake.
7. Allow samples to cool to room temperature then open the tubes.
8. Transfer the samples into the 50 ml polypropylene graduated tubes (containing the boric acid). Rinse the Teflon tubes with Milli-Q water 3 times.
9. Put in ultrasonic bath (at 60°C) for at least 30 minutes, until all the boric acid is dissolved.

10. Allow them to cool to room temperature and then dilute to the mark (50 ml) with Milli-Q water. If using glass, transfer the solution in plastic container. Allow particles to settle before analysis.

Reagent blanks:

At least 2 blanks should be prepared for each batch of analysis. They are prepared in a similar manner as the samples, except that no sample is added to the digestion vials.

Reference materials:

At least one certified reference material should be used and prepared in duplicate for each digestion batch. These digestions are prepared in a similar manner as the samples. A reference material of similar composition and concentration range should be used.

II-2. DIGESTION OF BIOTA FOR THE DETERMINATION OF TRACE METAL

Principle:

The biological samples are treated with concentrated nitric acid, in order to decompose the samples and solubilize all metals.

Reagents:

- HNO₃ (65%, Suprapur, Merck).
- Milli-Q deionised water (> 18MΩ cm, Millipore).

Procedure:

1. Shake the samples bottles for about 2 min. for homogenization.
2. Wait a few minutes before opening the bottles.
3. Weigh accurately about 0.2 g of dry sample in labeled Teflon tubes (FEP, 50 ml, Nalgene)
4. Add 5 ml of concentrated Nitric acid (HNO₃). Leave samples at room temperature for at least 1 hour.
5. Close the tubes and place them in an aluminum block on a hot plate at 90°C for 3hrs.
6. Allow the samples to cool to room temperature then open the tubes carefully.
7. Transfer the samples in the labeled 50 ml polypropylene graduated tubes or volumetric flask. Rinse the Teflon tubes with Milli-Q water 3 times.
8. Dilute to the mark (50 ml) with Milli-Q water and shake. If using glass transfer the solution in plastic container.

Reagent blanks:

At least 2 blanks should be prepared for each batch of analysis. They are prepared in a similar manner as samples, except that no sample is added to the digestion vials.

Reference materials:

At least one certified reference material should be used and prepared in duplicate for each digestion batch. These digestions are prepared in a similar manner as the samples. A reference material of similar composition and concentration range should be used.

II-3. DIGESTION OF BIOTA OR SEDIMENT FOR THE DETERMINATION OF TOTAL MERCURY BY Cold vapour-AAS

Principle:

The biological or sediment samples are treated with concentrated nitric acid, in order to decompose the samples and solubilize all metals.

Reagents:

- HNO₃ (65%, analytical grade, low in mercury, Merck).
- Milli-Q deionised water (> 18MΩ cm, Millipore).
- 10% K₂Cr₂O₇ (w/v) solution (e.g. 10 g K₂Cr₂O₇ diluted into 100 ml with Milli-Q water).

Procedure:

1. Shake the samples bottles for about 2 min. for homogenization.
2. Wait a few minutes before opening the bottles.
3. Number the Teflon tubes.
4. Weigh accurately about 0.2 g to 1.5 g of dry sample in Teflon tubes (FEP, 50 ml, Nalgene) depending of the expected concentration.
5. If processing plants or high weight of bivalve (> 1g), add 40 mg of V₂O₅ to each tube (including blanks).
6. Add 5 ml of concentrated Nitric acid (HNO₃). If large amount of sample is used add more acid until the mixture becomes liquid.
7. Leave the samples at room temperature for at least 1 hour.
8. Close the tubes and place them in an aluminum block on a hot plate at 90°C for 3hrs.
9. Allow for the samples to cool to room temperature then open the tubes carefully.
10. Add about 20 ml of Milli-Q water
11. Add 1 ml of K₂Cr₂O₇ solution (*NOTE*: final concentration should be 2% v/v).
12. Dilute to 50 ml preferably in Teflon, but glass is also good.

Reagent blanks:

At least 2 blanks should be prepared for each batch of analysis. They are prepared in a similar manner as the samples, except that no sample is added to the digestion vials.

Reference materials:

At least one certified reference material should be used and prepared in duplicate for each digestion batch. These digestions are prepared in a similar manner as the samples. A reference material of similar composition and concentration range should be used.

III. INSTRUMENTAL TECHNIQUES

III.1. PREPARATION OF METAL STANDARD SOLUTIONS FOR THE CALIBRATION CURVE

Principle:

The calibration curve must be made by at least 3 points (standard solutions of different concentration) plus a zero calibration. The concentration of the standard solutions must be calculated so that they bracket the concentrations of the samples and the Reference Materials.

If the concentration of the samples is unknown, the calibration curve will be centered on the Reference Materials. If the concentration of the samples exceeds the limit of the calibration curve, either the samples must be diluted to the appropriate concentration, or the calibration curve must be extended with a higher concentration standard. If, on the contrary, the concentration of the samples is lower than the lowest calibration curve's point, a new calibration curve must be prepared.

Reagent:

- Milli-Q deionised water (> 18M Ω cm, Millipore).
- Commercial standard solution 1000 $\mu\text{g ml}^{-1}$: Use a certified reference material solution; this solution should be accompanied by a certificate stipulating at the minimum the traceability of the certified concentration as well as the expiration date. The density of the solution or the certified content in mg kg^{-1} should also be defined.
- Acid solutions used for sample preparation.

Standards preparation:

1. Put approximately 10 ml of Milli-Q water into clean polypropylene tubes (50 ml)
2. MATRIX MATCH the standards: add reagents in order to obtain a similar matrix as in the samples. Ex: for BIOTA: 5 ml of concentrated nitric acid and 2 ml of H₂O₂. For SEDIMENTS (hot plate digestion): 2.7 g Boric acid, 1 ml of aqua regia, 6 ml of HF.
3. Add the appropriate quantity of standard solution with a micropipette.
4. Dilute to the mark (50 ml) with Milli-Q water.
5. Shake well.

External Calibration Verification (ECV):

In order to check the accuracy of the prepared curve an independent standard is prepared. The concentration of this ECV should be in the calibration curve. This solution is prepared as describe above but using a second source of stock standard solution.

NOTE:

Some standard producers are selling specific multi-element solution for ECV purpose.

III-2. DETERMINATION OF TRACE METALS IN SEDIMENT AND BIOLOGICAL MATERIALS BY GF-AAS

Principle:

The samples are digested with strong acids (see Digestion Procedures).

For graphite furnace (GF) AAS, an aliquot of sample solution (10-50 μl) is introduced into a graphite tube of the GF-AAS and atomized by rapid heating at high temperature. A light beam is directed through the graphite tube, into a monochromator, and onto a detector that measures the amount of light absorbed by the atomized element in the tube. Each metal has its own characteristic wavelength, so a source hollow cathode lamp composed of that element is used. The amount of energy absorbed at the characteristic wavelength is proportional to the concentration of the element in the sample.

Reagents:

- Argon.
- Standard solution of the element of interest 1000 mg l^{-1} (Merck).
- Milli-Q deionized water ($>18 \text{ M}\Omega \text{ cm}$, Millipore).

Materials:

- Volumetric material, polypropylene tubes with caps (50 ml) cleaned according to Cleaning Procedures or glass volumetric flask and plastic container (for transferring).
- Atomic Absorption Spectrometer.
- Micropipettes.
- Polypropylene cups for automatic sampler.

Reagent solutions:

Metal standard solutions for the calibration curve: (See procedure III.1)

1. Put approximately 10 ml of Milli-Q water into clean polypropylene tubes (50 ml) or in volumetric flasks.
2. Add reagents in order to obtain a similar matrix as the sample (e.g. if sample is in 10% nitric acid add 5 ml of nitric acid).

3. Add the appropriate quantity of stock standard solution (1000 mg l⁻¹ or an intermediate stock standard) with a micropipette.
4. Dilute to the mark (50 ml) with Milli-Q water.
5. Shake well.
6. If glass is used then transfer the solution into a polypropylene container.

These solutions can be kept for a few days if stored in the refrigerator (+4°C).

Depending on the element, it may be necessary to make an intermediate stock standard solution. This intermediate stock is prepared as described above in a 2% HNO₃ matrix.

Before analysis:

Analytical conditions may change for each element, so it is necessary to first carefully read the relevant manufacturer manual before starting. Nowadays instrument software have integrated cookbook and already develop program to be used as starting point. Example of working conditions is given in table 1.

Determine the calibration curve according to the expected concentrations of the samples and the linearity of the AAS response for the element considered, software will usually provide recommended working range.

ANALYSIS BY GF-AAS

General operation:

1. Switch on the instrument (make sure the lamp of interest is on).
2. Make sure the rinsing the bottle is filled with fresh Milli-Q water (as this bottle is under argon pressure it should be disconnected before opening the gas).
3. Switch on argon and cooling system.
4. Open the furnace and take out the graphite tube.
5. Clean the inside, outside and quartz window with alcohol.
6. Install an appropriate graphite tube and close the furnace.
7. Optimize the lamp position and record the gain in the instrument logbook.
8. Install the auto sampler.
9. Make sure there is no air inside the syringe system.
10. Set up the capillary position (including length).
11. Run a “tube clean” cycle.

Operation when using a develop program:

Calibration curve:

The automatic sampler can make the calibration curve by mixing an appropriate volume of standard and zero calibration solutions, so only one standard solution needs to be prepared. It can be the highest standard solution of the calibration curve, or a solution more concentrated in case of standard additions. The solution must be chosen so that the volumes pipetted by the automatic sampler to make the standards are not lower than 2 µl. The calibration curve can also be prepared manually.

Sequence:

At least one blank, one reference material and one check standard (ECV, See procedure III.1) are measured before the samples, so it is possible to check that the system is under control before allowing the instrument to work automatically.

A reslope should be measured every 5 to 10 samples, as well as either a reference material or the ECV or a sample. This allows checking the accuracy of the reslope and the precision of the instrument over the run.

The instrument is recalibrated regularly (every 10-20 samples) to correct for instrumental drift and graphite tube efficiency.

Running a sequence:

1. Fill the carousel with samples, standard, zero calibration and matrix modifier if needed.
2. Select the program needed and carefully check all parameters (type of measurements, matrix modifier, the temperature program, reslope standard and rate, type of calibration, etc....)
3. Check that the number of fires from the graphite tube in use is low enough to allow for the full sequence to be run.
4. Program the auto sampler and the sequence.
5. Make an instrument zero.
6. Measure the zero calibration as a sample and record the absorbance in the logbook. It should be low or comparable with previous data.
7. Inject a known volume one standard solution, calculate the M_0 (quantity in pg to get a signal of 0.0044ABS) and record it in the logbook. Compare with previous records. Check the peak shape and the RSD of the reading (should be <5%).

$$M_{0(\text{pg})} = \frac{C_{\text{standard}} (\text{ng ml}^{-1}) \times Q_{\text{ut standard injected}} (\mu\text{l})}{\text{ABS standard}} \times 0.0044$$

8. Inject a reference material solution and check if the concentration is correct. Check the peak shape and the RSD of the reading (should be <5%).
9. Run the sequence.
10. Even if the instrument is all automatic, stay around to check the beginning of the sequence (calibration curve, procedure blank, reference material and check std ECV), and ideally return regularly to check the reslope, so that the sequence can be stopped if needed.

Minimum quality control checks

The ECV should be within 10% of the true value, in case of failure any results obtained after the last acceptable ECV should be rejected. The samples can be measured again after the ECV is under acceptable limit again (i.e. changing graphite tube, verifying calibration curve...)

The Zero calibration blanks measured during the run stay under acceptable limit (to be defined during the method validation), in case of failure the calibration should be redone and all results obtained after last acceptable blank should be re-measured.

The sample blanks measured during the run stay under acceptable limit (to be defined during the method validation), in case of failure all samples prepared along the failing blanks should be redone (prepared again).

The Certified Reference Material: At least one certified reference material of a representative matrix will be prepared with each batch of sample; the calculated result should fall in the value of the certificate and within the coverage uncertainty, to show evidence of unbiased result. The results for the CRM should be recorded for quality control purpose and plotted on a control chart

Verify the RSD of reading (<5%).

Check that all samples were within the concentration limits of the calibration curve. If not, take the appropriate action (dilution or new calibration curve) and restart the sequence.

Developing a program:

The AAS software generally gives typical electrothermal programs for each element for 10 µl of sample in diluted HNO₃ (0.1%) and indications concerning maximum ashing and atomization temperatures. More specific information may also be found in the literature, such as recommendations regarding matrix modifiers and the use of partition tubes or tubes with platform. Some examples of working conditions are listed in table 1.

When a program is optimized for the determination of an element in a specific matrix, all information should be reported in the logbook of methods of the laboratory, with all needed information such as:

- Matrix
- Type of tube
- Volume of injection
- Type of calibration (direct or standard addition)
- Matrix modifier used and quantity
- Examples of a typical sample and standard peak
- Maximum number of fires

A program is ideally optimized when:

The sensitivity is correct (comparable to the one in the literature)

The background is minimal

The peak shape is correct and comparable in the standard and the sample

It is possible to have a reference material of the same matrix and the same concentration as the sample, and the concentration found in the reference material is acceptable.

NOTE:

The optimization is done first on the sample solution (reference material can be a good one to start with).

Some software has the option of automatic program optimization where ashing and atomization temperature can be varied automatically, it is highly recommended to use those options with each new matrix or new element.

Optimization of drying stage:

The drop of sample should be dry before beginning the ashing stage to avoid boiling, which would spread the sample through the entire graphite tube.

A typical drying stage would bring the solution close to 100°C slowly, and then just above 100°C.

The drying is correct when no noise can be heard when ashing stage starts.

The signal can be measured from the beginning of the temperature program; if the drying stage is correctly set, no perturbations should be seen before ashing stage.

Optimization of ashing stage:

The ashing temperature should be set so that no element is lost.

This stage is separated into three steps: ramping (time to optimize), staying (time to optimize) and staying without gas (generally 2 seconds).

To find this optimal temperature, fix the atomization T° at the recommended T° and increase ashing T° by increments of 50°C until the absorbance decreases.

When the optimum T° is found, the time can be optimized the same way: increase the ashing time (ramp and stay) until the ratio between Abs and Background is maximum.

Matrix modifier:

For some elements and some matrices, the results obtained are still not satisfactory (e.g. maximum ashing T° is not sufficient to eliminate the background), this procedure should be redone with the addition of a matrix modifier. Different matrix modifiers could be tried before finding the best solution.

Often the matrix modifier solution is added to the injection (e.g. 2 or 4 µl for 20 µl injection). If the total volume of injection changes, it is necessary to check that the drying stage is still correct.

The absence of analyte of interest in the matrix modifier should be checked.

The main matrix modifiers are listed in section III.3.

The ashing temperature optimization protocol will be repeated with the addition of matrix modifier, to define the optimum temperature using a specific matrix modifier.

Optimization of atomization stage:

Before the atomization stage, the argon must be stopped. There are two steps in the atomization stage: ramping and staying. The read command should be on during these two-steps.

WARNING: if the Zeeman correction is on, the reading time cannot exceed 4s.

The T° of ashing is fixed at the T° found in the optimization procedure, and the atomization T° is increased. The best T° is the lowest one that gives the best signal.

The ramping should also be optimized.

Cleaning stage:

Add a cleaning stage after the atomization, by increasing the T° to 100-200°C and opening the argon. To increase the lifetime of the graphite tube, it is recommended to do this gradually, in two steps. First open the argon at 0.5 ml/min, and second open argon at maximum gas flow (3 ml/min).

Cooling stage:

It is highly recommended to impose the cooling stage to increase the lifetime of the graphite furnace. It can also be helpful to add a last step at injection T° for 2 or 3 second to stabilize the T° before the next injection.

Check for matrix effect:

When developing a program for a new matrix it is necessary to evaluate the accuracy of the method.

Each unknown type of samples should be spike to check for potential matrix effect.

This spike is considered as a single point standard addition, and should be performed with a minimum dilution factor. The recovery for spike calculated using equation 2 should be 85-115%. If this test fails, it is recommended to run analyses with standard addition method.

Spike solution: mix a fixed volume (V1) of the sample solution with a known volume (V2) of a standard solution of a known concentration (C_{standard}).

Unspike solution: mix the same fixed volume (V1) of the sample solution with the same volume (V2) of reagent water.

Measure concentration C (mg l⁻¹) in both solutions on the calibration curve, and calculate recovery as:

$$\text{Equation 1} \quad C_{\text{spike}} = \frac{C_{\text{standard}} \times V_2}{(V_1 + V_2)}$$

$$\text{Equation 2} \quad R = \frac{C_{\text{Spike Solution}} - C_{\text{Unspike solution}}}{C_{\text{spike}}} \times 100$$

To be valid, the concentrations of spike and unspike solutions should be in the linearity range of the calibration curve and Spike concentration (equation 1) should be in the range of 50-150% of the concentration of unspike solution.

When the program is ready, save all information and run it as described in the previous section.

Standard addition:

Main points to check before standard addition run:

Determine the linearity of the instrument.

Make sure the last point of the curve is in the linearity range (quantity of analyte in sample + quantity of analyte in last addition).

The zero addition should be above the DL. Generally the quantity of sample injected is smaller to permit the addition.

The curve should contain at least 3 points plus zero addition, adequately chosen. Best results will be obtained using additions representing 50, 100, 150 and 200% of the expected concentration of sample.

The standard addition curve should be done for each matrix; a fish should not be quantified on a mussel calibration curve!

Switching off the instrument

Print and save the results.

Verify that all needed information is recorded in the logbook.

Switch off the gas, cooling system and instrument.

Empty the carousel and the waste bottle.

Calculation:

The software can calculate the final concentrations. Alternatively, it can be done by hand using the following formula. If the same volume is always injected

$$C(\mu\text{g} / \text{g}) = \frac{(C_d - C_b) \times V \times F}{W}$$

Where:

C = Concentration of element in original sample ($\mu\text{g g}^{-1}$ dry weight);

C_d = Concentration of element in sample solution ($\mu\text{g ml}^{-1}$);

C_b = Mean concentration of element in reagent blanks ($\mu\text{g ml}^{-1}$);

V = Volume of dilution of digested solution (ml);

W = Dry weight of sample;

F = Dilution factor, if needed (=1 in case of no additional dilution other than that resulting from digestion procedure).

III-3. MATRIX MODIFIERS

1) AMMONIUM PHOSPHATE AND MAGNESIUM NITRATE

Make the following 2 solutions in ultra pure deionized water:

- $\text{NH}_4\text{H}_2\text{PO}_4$ (Suprapure, Merck) 25 g/l
- $\text{Mg}(\text{NO}_3)_2$ (Suprapure, Merck) 10 g/l

In a polyethylene cup (for AAS autosampler) make a solution with:

1000 μl $\text{NH}_4\text{H}_2\text{PO}_4$ solution

+ 50 μl $\text{Mg}(\text{NO}_3)_2$ solution

Add about 4 μl of modifier solution for 20 μl of sample.

2) PALLADIUM NITRATE AND MAGNESIUM NITRATE

SOLUTION (A): $\text{Pd}(\text{NO}_3)$ (0.2%)

$\text{Pd}(\text{NO}_3)$ pure (1g)

- In a Teflon beaker, dissolve 1 g of $\text{Pd}(\text{NO}_3)$ in aqua regia on a hot plate using a minimum amount of acid.
- Transfer into a 100 ml volumetric flask and complete to 100 ml with ultrapure deionized water. Keep this solution (1%) in the refrigerator (+4 °C).
- Dilute the $\text{Pd}(\text{NO}_3)$ solution (1%) with ultrapure deionized water to make a 0.2% solution:
Add 20 ml of solution in a 100 ml volumetric flask and complete to the volume.
- This 0.2% solution can be kept in the refrigerator (+4°C) for 6 months.

SOLUTION (B): $\text{Mg}(\text{NO}_3) 6\text{H}_2\text{O}$ (1%)

$\text{Mg}(\text{NO}_3) 6\text{H}_2\text{O}$ Suprapure, Merck

Make a 10 g/l solution in ultra pure deionized water.

SOLUTION A+B:

In a polyethylene cup (for AAS autosampler) make the following mixture every day of analysis:

800 μl $\text{Pd}(\text{NO}_3)$ (0.2 %) + 200 μl $\text{Mg}(\text{NO}_3) 6\text{H}_2\text{O}$ (1%)

Use about 4 µl of this solution for 20 µl sample.

3) PALLADIUM NITRATE, MAGNESIUM NITRATE AND AMMONIUM PHOSPHATE:

Make the following 2 solutions in ultrapure deionized water:

- $\text{NH}_4\text{H}_2\text{PO}_4$ (Suprapure, Merck) 25 g/l
- $\text{Mg}(\text{NO}_3)_2$ (Suprapure, Merck) 10 g/l

And a palladium nitrate solution (1%) as described in 2)

In a plastic container make the following mixture every day:

2 ml $\text{Pd}(\text{NO}_3)_2$ + 1 ml $\text{Mg}(\text{NO}_3)_2 \cdot 6\text{H}_2\text{O}$ + 400 µl $\text{NH}_4\text{H}_2\text{PO}_4$ + 6.6 ml of Milli-Q water.

Use about 4 µl of this solution for 20 µl sample.

4) Permanent modification with Iridium:

Use commercial solution of iridium 1000 µg ml⁻¹

- Inject 50 µl of the solution and run the temperature program below
- Repeat this 3 times
- The coating is stable for about 200 injections and can be repeated

Step	Temperature (°C)	Ramp Time (s)	Hold Time (s)
1	100	5	30
2	1200	20	5
3	100	5	2
4	2500	2	10

TABLE 1. EXAMPLES OF GRAPHITE FURNACE CONDITIONS

Element	Cu	Cu	Cd	Cd	Pb	Pb	As	As	Cr	Cr
Sample type	Sediment	Biota	Sediment	Biota	Sediment	Biota	Sediment	Biota	Sediment	Biota
Wavelength (nm)	327.4	327.4	228.8	228.8	283.3	283.3	193.7	193.7	357.9	357.9
Lamp current (mA)	4	4	4	4	5	5	10	10	7	7
Slit	0.5	0.5	0.5	0.5	0.5	0.5	0.5	0.5	0.5R	0.5R
Graphite tube	Partition Tube	Partition Tube	platform	platform	platform	platform	platform	platform	Partition Tube	Partition Tube
Matrix Modifier	none	none	none	Pd, Mg, Amonium Phosphate	none	Pd, Mg, Amonium Phosphate	Pd, Mg	Pd, Mg	none	none
Peak Measurement	area	area	area	area	area	area	area	area	area	area
M ₀ (pg/0.0044 UA) on standard	13	13	1	1	16	16	15	15	2.5	2.5
Ashing T° (C°)	700	700	300	700	400	925	1400	1400	1100	1100
Atomisation T° (C°)	2300	2300	1800	1900	2100	2200	2600	2600	2600	2600
Remark							Data for Ultra Lamp only!! Number of Fire is critical	Data for Ultra Lamp only!! Standard Addition often required. Number of fire is critical	Use peak Height for lower concentration (peak shape)	Standard Addition often required. Use peak Height for lower concentration (peak shape)

III-4. DETERMINATION OF TRACE METALS IN SEDIMENT AND BIOLOGICAL MATERIALS BY FLAME-AAS

Principle:

The samples are digested with strong acids (see procedure). Atomic absorption spectrometry resembles emission flame photometry in the fact that the sample solution is aspirated into a flame and atomized. In case of flame-AAS, a light beam is directed through the flame, into a monochromator, and onto a detector that measures the amount of light absorbed by the element in the flame. Each metal has its own characteristic wavelength so a source hollow cathode lamp composed of that element is used. The amount of energy absorbed at the characteristic wavelength is proportional to the concentration of the element in the sample.

In case of flame emission, the amount of light emitted at the characteristic wavelength for the element analyzed is measured.

Reagents:

- Acetylene (pure quality).
- Air (pure quality).
- Standard solution of the element of interest 1000 mg l⁻¹ (Merck).
- Milli-Q deionised water (>18 MΩ cm, Millipore).

Material:

- Volumetric material, polypropylene tubes with caps (50 ml, Sarstedt), cleaned according to Cleaning Procedures or glass volumetric flask and plastic container (for transferring).
- AAS Varian Spectra-AA10.
- Micropipettes (Finnpipette).
- 1 polyethylene bottle (500 ml) for Milli-Q water.

Reagent solutions:

Metal standard solutions for the calibration curve (See procedure III-1):

1. Put about 10 ml of Milli-Q water into clean polypropylene tubes (50 ml) or in volumetric flask.

2. Add reagents in order to obtain a similar matrix as in the sample (e.g. if sample is in 10% nitric acid add 5 ml of nitric acid).
3. Add the appropriate quantity of stock standard solution (1000 mg l⁻¹ or an intermediate stock standard) with a micropipette.
4. Dilute to the mark (50 ml) with Milli-Q water.
5. Shake well.
6. If glass is used then transfer the solution into a polypropylene container.

These solutions can be kept for a few days if stored in the refrigerator (+4°C).

Depending on the element, it may be necessary to make an intermediate stock standard solution. This intermediate stock is prepared as described above in a 2% HNO₃ matrix.

Before analysis:

Analytical conditions may change for each element, so it is necessary to first carefully read the analytical methods book of the AAS before starting an analysis.

Determine the calibration curve according to the expected concentrations of the samples, and the linearity of the AAS response for the element considered (absorbance versus concentration curve given in the analytical methods book).

If ionization or interferences are likely, choose the right option according to the analytical method book, e.g. use of correction for non atomic absorption by using deuterium lamp background corrector, use of oxidizing air-acetylene flame; use of nitrous oxide-acetylene flame; addition of a releasing agent or ionization suppressant.

Prepare a standard solution in 2% HNO₃ for optimization and sensitivity check. The concentration is given in the method book (Concentration for 0.2 abs).

ANALYSIS BY FLAME-AAS:

Calibration curve:

Prepare standards with at least three concentrations plus zero. The zero calibration solution is prepared as other standard solutions without adding analyte.

If the samples are not within the calibration range, dilute them in the same matrix, or prepare a new calibration curve.

General operation:

1. Switch on the instrument and the gas.
2. Make sure the rinsing bottle is filled with fresh water.
3. Make sure the lamp of interest is on.
4. Before beginning optimization, wait approximately 15 minutes so that the lamp is stable.
5. Optimize the lamp position in order to get maximum energy. Record the gain in the logbook.
6. Use a card to optimize the burner position.
7. Switch the flame on.
8. Make instrument zero with **no solution**.
9. Aspirate the sensitivity standard solution.
10. Adjust the burner position slightly in order to get the maximum signal.

WARNING: make sure that the burner is not in the light !! The signal should be zero when no solution is aspirated.

11. Adjust flame composition in order to get the maximum signal.
12. Put the capillary back in the rinsing solution.

Running a sequence:

1. Make an instrument zero while aspirating **NO SOLUTION**.
2. **MEASURE THE ZERO CALIBRATION AS A SAMPLE** and record the absorbance in the logbook. It should be low or comparable with previous data. This should be done before calibration, because while the zero calibration is set up, the instrument automatically subtracts

it from all measurements! If the absorbance of the zero solution is high, it is necessary to check for the source of contamination before beginning an analysis.

3. Run a calibration curve.
4. At least one blank, one reference material and one check standard (ECV See procedure III-1) are measured before any samples, so that it is possible to verify that the system is under control before running the samples.
5. Run the samples, a zero calibration and reslope should be measured every 5 to 10 samples, as well as either a reference material or the ECV or a sample. This allows to check the accuracy of the reslope and the precision of the instrument over the run, as well as to see if the instrument is still under control.
6. During the run verify that the RSD between reading (abs) is below 5%, if it increases the nebulizer should be checked.

Switching off:

1. Save and print out results.
2. Rinse the flame with at least 500 ml of Milli-Q water (by aspirating)
3. Switch off the flame, the instrument and the computer
4. Empty the waste bottle
5. Switch off the gas

Calculation:

The software can calculate the final concentration. Alternatively, it can be done by hand using the following formula. If the same volume is always injected

$$C(\mu\text{g} / \text{g}) = \frac{(C_d - C_b) \times V \times F}{W}$$

Where:

C = Concentration of element in original sample ($\mu\text{g g}^{-1}$ dry weight);

C_d = Concentration of element in sample solution ($\mu\text{g ml}^{-1}$);

C_b = Mean concentration of element in reagent blanks ($\mu\text{g ml}^{-1}$);

V = Volume of dilution of digested solution (ml);

W = Dry weight of sample;

F = Dilution factor, if needed (=1 in case of no additional dilution other than that resulting from digestion procedure).

III-5. DETERMINATION OF TOTAL MERCURY IN SEDIMENT AND BIOLOGICAL SAMPLES BY VGA-AAS

Principle and application:

The sediment or biological samples are mineralized with strong acids. The inorganic mercury is reduced to its elemental form with stannous chloride. The cold mercury vapor is then passed through the quartz absorption cell of an AAS where its concentration is measured. The light beam of Hg hollow cathode lamp is directed through the quartz cell, into a monochromator and onto a detector that measures the amount of light absorbed by the atomized vapor in the cell. The amount of energy absorbed at the characteristic wavelength is proportional to the concentration of the element in the sample.

Reagents:

- HNO₃ (65%, analytical grade, low in Hg, Merck).
- K₂Cr₂O₇ (analytical grade, low in Hg, Merck).
- SnCl₂ (analytical grade, Merck).
- HCl (30%, Suprapur, Merck)
- HgCl₂ (salt, Merck) or standard Hg solution (1000 mg l⁻¹, Merck).
- Milli-Q deionised water (>18 MΩ cm, Millipore).
- Argon (pure quality).

Material:

- AAS Varian-Spectra AA-10 and VGA-76.
- Glass volumetric flasks from 50 to 1000 ml (Class A),
- Micropipettes (Finnpipette).

Reagent solutions:

20% w/v SnCl₂ in 20 % v/v HCl (200 ml):

1. Weigh accurately 40 g of SnCl₂ into a clean glass beaker using a plastic spatula (beaker and spatula are used only for SnCl₂).
2. Add 40 ml of concentrated HCl directly to the SnCl₂ and transfer to a 200 ml volumetric flask. Mix and wait for complete dissolution of SnCl₂.

3. Add Milli-Q water to the mark (200 ml).
4. With older stock of SnCl_2 it may be necessary to warm up the solution on a hot plate to obtain complete dissolution of SnCl_2 (do not allow to boil).
5. If SnCl_2 is found to be contaminated, it should be purged with nitrogen for 30 minutes before use.

This solution should be made fresh for each day of analysis.

NOTE:

All glassware used for preparation of SnCl_2 solution should be kept separately from remaining laboratory ware in order to avoid cross contamination of ware for trace element determination.

Nitric acid 10% v/v (500 ml):

1. Put about 400 ml of Milli-Q water into a 500 ml volumetric flask.
2. Add carefully 50 ml of concentrated nitric acid.
3. Make up to the mark with Milli-Q water.
4. Shake well.
5. This solution can be stored if kept in a tightly closed flask.

$\text{K}_2\text{Cr}_2\text{O}_7$ 10% (w/v) in Milli-Q water:

1. Weigh 50 g of $\text{K}_2\text{Cr}_2\text{O}_7$ into a clean 500 ml glass volumetric flask.
2. Add about 250 ml of Milli-Q water and shake until $\text{K}_2\text{Cr}_2\text{O}_7$ is dissolved.
3. Make up to the mark with Milli-Q water.

Mercury standards

Preferably use a commercial stock of Hg

Solution stock 1: 1 mg ml⁻¹ Hg in 10% nitric acid

1. Weigh exactly 1.354 g of HgCl_2 into a 1 liter glass volumetric flask.
2. Add about 500 ml of Milli-Q water.
3. Add 10 ml of concentrated nitric acid (low in Hg).

4. Complete to the mark with Milli-Q water
5. Shake well until complete dissolution is achieved.
6. Transfer into a 1 liter Teflon bottle.

Closed tightly with a torque wrench and keep in the refrigerator (+4° C).

Calibration curve (at least 3 standards and zero calibration) (See procedure III-1):

1. Put about 10 ml of Milli-Q water into a clean 50 ml glass volumetric (or plastic tube).
2. Add reagents as in the digested samples.
3. Add the appropriate quantity of stock standard solution (stock 1 or stock 2 depending on the samples concentrations) with a micropipette.
4. 1 ml of $K_2Cr_2O_7$ solution.
5. Dilute to the mark (50 ml) with Milli-Q water.
6. Shake well.

These solutions should be done fresh every day of analysis.

Sample digestion procedure:

It is strongly recommended to use the digestion procedure for Hg.

In case you use the digestion prepared by microwave oven for trace metal determination, it is strongly recommended that an aliquot of the solution be treated with 2% v/v $K_2Cr_2O_7$ solution as a preservative. Or that Hg is measured in the day following the digestion.

For sediment, the blank as to be checked as generally boric acid is not clean enough! It might be better to use Suprapur boric acid if mercury has to be measured in the sediment digestion solution.

ANALYSIS BY CV-AAS:

Calibration curve:

Prepare standard solutions with at least three standard concentrations plus one zero. The zero calibration is prepared as standard solutions without adding the mercury standard.

If the samples are not within the calibration curve, dilute them in the same matrix, or prepare a new calibration curve.

General operation:

1. Switch on the instrument.
2. Make sure the mercury lamp is on.
3. Before beginning optimization, wait approximately 15 minutes so that the lamp is stable.
4. Optimize the lamp position **without the cell** in order to get maximum energy. Record the gain in the logbook.
5. Optimize the burner position with the cell, the maximum energy should be read.
6. Make instrument zero.

Operation of the VGA:

1. Switch on the argon.
2. Put each of the 3 Teflon capillary tubes into the appropriate solutions:
 - a) SnCl₂ solution
 - b) Milli-Q water
 - c) Rinse solution (10% HNO₃)
3. Switch on the VGA and slowly tighten the pressure adjusting screw on the peristaltic pump until the liquids are pumped (do not over tighten as this will shorten the life of the pump tubes).
4. Check that there are no leaks.
5. Let the system running for about 10 min. in order to clean the system. Disconnect the black tube from the quartz absorption cell if the system has not been running for a while (to prevent contamination of the cell).

Running a sequence:

1. Make an instrument zero without connecting the VGA to the cell.
2. Connect the VGA to the cell.
3. Set up the delay time (about 50s for VGA Varian), this can be optimized under the optimized signal, aspirate a standard solution and measure the time needed to reach the maximum (stable) signal.

NOTE: this is for online determination system.

4. Measure **AS SAMPLE** the signal, obtained when only SnCl₂ and Milli-Q water are aspirating. It should be zero.
5. Measure **AS SAMPLE** the signal, obtained when all three solution are measured, it should be zero, so the next instrument zero can be done on that.
6. **MEASURE THE ZERO CALIBRATION AS A SAMPLE** and record the absorbance in the logbook. It should be low or comparable with previous data. This should be done before calibration, because while the zero calibration is set up, the instrument automatically subtracts it from all measurements! If the absorbance of the zero solution is high, it is necessary to check for the source of contamination before beginning an analysis.
7. Run a calibration curve.
8. At least one blank, one reference material and one check standard (ECV See procedure III-1) are measured before any samples, so that it is possible to verify that the system is under control before running the samples.
9. Run the samples, a zero calibration and reslope should be measured every 5 to 10 samples, as well as either a reference material or the ECV or a sample. This allows to check the accuracy of the reslope and the precision of the instrument over the run, as well as to see if the instrument is still under control.

Shutdown procedure:

1. Rinse all tubing with Milli-Q water for about 20 min. (make sure to keep separate the tube for the SnCl₂ solution from the other tubes).
2. Turn off the VGA system.
3. Release the tension from the tubing.
4. Turn off the gas and instrument.
5. Empty the waste bottle.

Calculation:

$$C(\mu\text{g} / \text{g}) = \frac{(C_d - C_b) \times V \times F}{W}$$

Where:

C = Concentration of total mercury in dry sample ($\mu\text{g g}^{-1}$ dry);

C_d = Concentration of mercury in sample solution ($\mu\text{g ml}^{-1}$);

C_b = Mean concentration of mercury in reagent blanks ($\mu\text{g ml}^{-1}$);

V = Volume of dilution of digested samples (ml)=57.5 ml;

W = Dry weight of sample (g);

F = Dilution factor, if needed (=1 in case of no additional dilution other than that resulting from digestion procedure).

IV. CLEANING PROCEDURES

IV-1. CLEANING GENERAL LABWARE FOR THE DETERMINATION OF TRACE ELEMENTS

Reagents:

- HNO₃ (65% analytical grade, ISO, Merck).
- Special laboratory detergent (Micro).
- Milli-Q deionised water (>18 MΩ cm, Millipore).

Procedure:

1. Allow the vessels to soak overnight in a plastic container in a soap solution (Micro solution 2% in tap water).
2. Rinse thoroughly first with tap water then with Milli-Q water.
3. Leave the vessels to stand in 10% (v/v) concentrated HNO₃ solution at room temperature for at least 6 days.
4. Rinse thoroughly with Milli-Q water (at least 4 times).
5. Allow the vessels to dry under a laminar flow hood.
6. Store the vessels in closed plastic polyethylene bags to prevent the risk of contamination prior to use.

This procedure should be used for all plastic ware use in the laboratory as tips, cup for autosampler, plastic container.....

IV-2. CLEANING OF DIGESTION TEFLON VESSELS FOR THE DETERMINATION OF TRACE ELEMENTS

Reagents:

- HNO₃ (65% analytical grade, ISO, Merck).
- HCl (25% analytical grade, Merck).
- Special laboratory detergent (Micro).
- Milli-Q deionised water (>18 MΩ cm, Millipore).

Procedure:

1. Soak the vessels (Teflon reactors, CEM) and their caps overnight in a detergent solution (Micro solution 2% in tap water) in a plastic container.
2. Rinse thoroughly first with tap water then with Milli-Q water.
3. Fill the Teflon reactor with 5 ml of HNO₃ (conc), close the reactor and put them in the microwave oven.
4. Set up the correct program:

Step	Power (W)	% Power	Ramp time (min sec)	PSI	°C	Hold time (min sec)
2	1200	100	10.00	600	100	5 00
3	1200	100	10 00	600	200	10.00

5. Allow the samples to cool to room temperature, release pressure carefully by opening the valve, and then open the reactor.
6. Empty the reactor (acid can be kept for some run of cleaning) and rinse them carefully with Milli-Q water.
7. Put them to dry under a laminar flow hood.
8. Once dry, the vessels should be closed and put into polyethylene bags to prevent the risk of contamination prior to use.

IV-3. CLEANING TEFLON LABWARE FOR THE DETERMINATION OF MERCURY AND METHYL MERCURY

Reagents:

- HNO₃ (65% analytical grade, ISO, Merck).
- HCl (25% analytical grade, Merck).
- HCl (30%, Suprapur, Merck).
- Special laboratory detergent (Micro).
- Milli-Q deionised water (>18 MΩ cm, Millipore).

Procedure:

1. Allow the vessels to soak overnight in a plastic container in a soap solution (Micro solution 2% in tap water).
2. Rinse thoroughly first with tap water then with Milli-Q water.
3. Put the vessels in 50% (v/v) concentrated HNO₃ solution and heat at 60° C for 2 days.
4. Rinse thoroughly with Milli-Q water (at least 4 times).
5. Transfer the vessels into 10% (v/v) concentrated HCl solution for a further 3 days (at least) at room temperature.
6. Rinse thoroughly with Milli-Q water (at least 4 times).
7. Allow the vessels to dry in a laminar flow hood.
8. All vessels are stored in polyethylene plastic bags. When possible (especially for Teflon bottles), the vessels are filled with 1% HCl (Suprapur, Merck) heated on a hot plate for one night and hermetically closed with a torque wrench.

IV-4. CLEANING LABWARE FOR THE DETERMINATION OF MERCURY BY VGA-CV-AAS; SIMPLIFIED PROCEDURE FOR TEFLON AND GLASSWARE

Reagents:

- HNO₃ (65% analytical grade, ISO, Merck).
- Special laboratory detergent (Micro).
- Milli-Q deionised water (>18 MΩ cm, Millipore).

Procedure:

1. Allow the vessels to soak overnight in a plastic container in a soap solution (Micro solution 2% in tap water).
2. Rinse thoroughly first with tap water then with Milli-Q water.
3. Fill the glass or Teflon vessels with 10% (v/v) concentrated HNO₃ solution.
4. Heat at 60°C for 2 days. In case of volumetric flasks, let stand for 6 days at room temperature.
5. Rinse thoroughly with Milli-Q water (at least 4 times).
6. Allow the vessels to dry in a laminar flow hood.
7. All vessels are stored in polyethylene plastic bags. Clean volumetric flasks are filled with Milli-Q water.

NOTE:

For contaminated labware, a precleaning step with 50% (v/v) concentrated HNO₃ solution should be used. In this case, steps 3) to 5) should be done twice: first with 50% acid solution, then with 10% acid solution.

Annex III:

US EPA (1995). Method 1640: Determination of trace elements in ambient waters by on-line chelation preconcentration and Inductively Coupled Plasma Mass Spectrometry. (6.1.1)



Method 1640: Determination of Trace Elements in Ambient Waters by On-Line Chelation Preconcentration and Inductively Coupled Plasma-Mass Spectrometry

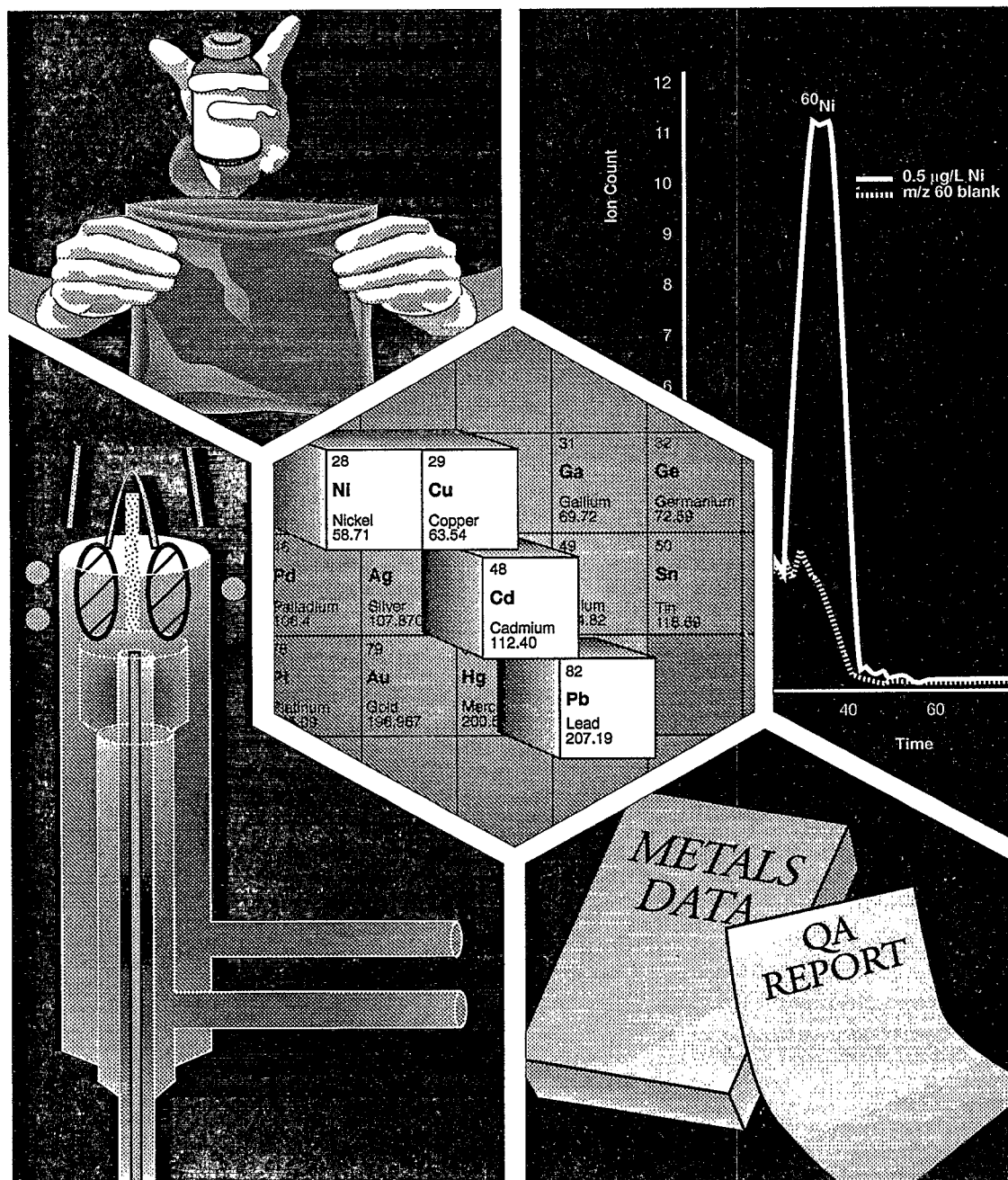



Method 1640: Determination of Trace Elements in Ambient Waters by On-Line Chelation Preconcentration and Inductively Coupled Plasma-Mass Spectrometry

Acknowledgments

Method 1640 was prepared under the direction of William A. Telliard of the U.S. Environmental Protection Agency's (EPA's) Office of Water (OW), Engineering and Analysis Division (EAD). The method was prepared under EPA Contract 68-C3-0337 by the DynCorp Environmental Programs Division with assistance from Interface, Inc.

The following researchers contributed to the philosophy behind this method. Their contribution is gratefully acknowledged:

Shier Berman, National Research Council, Ottawa, Ontario, Canada
Nicholas Bloom, Frontier Geosciences Inc, Seattle, Washington
Paul Boothe and Gary Steinmetz, Texas A&M University, College Station, Texas
Eric Crecelius, Battelle Marine Sciences Laboratory, Sequim, Washington
Russell Flegal, University of California/Santa Cruz, California
Gary Gill, Texas A&M University at Galveston, Texas
Carlton Hunt and Dion Lewis, Battelle Ocean Sciences, Duxbury, Massachusetts
Carl Watras, Wisconsin Department of Natural Resources, Boulder Junction, Wisconsin
Herb Windom and Ralph Smith, Skidaway Institute of Oceanography, Savannah, Georgia

In addition, the following personnel at the EPA Office of Research and Development's Environmental Monitoring Systems Laboratory in Cincinnati, Ohio, are gratefully acknowledged for the development of the analytical procedures described in this method:

J.T. Creed
T.D. Martin
S.E. Long (DynCorp, formerly Technology Applications, Inc.)

Disclaimer

This method has been reviewed and approved for publication by the Engineering and Analysis Division of the U.S. Environmental Protection Agency. Mention of trade names or commercial products does not constitute endorsement or recommendation for use.

Questions concerning this method or its application should be addressed to:

W.A. Telliard
USEPA Office of Water
Analytical Methods Staff
Mail Code 4303
401 M Street, SW
Washington, DC 20460
Phone: 202/260-7120
Fax: 202/260-7185

Introduction

This analytical method was designed to support water quality monitoring programs authorized under the Clean Water Act. Section 304(a) of the Clean Water Act requires EPA to publish water quality criteria that reflect the latest scientific knowledge concerning the physical fate (e.g., concentration and dispersal) of pollutants, the effects of pollutants on ecological and human health, and the effect of pollutants on biological community diversity, productivity, and stability.

Section 303 of the Clean Water Act requires states to set a water quality standard for each body of water within its boundaries. A state water quality standard consists of a designated use or uses of a waterbody or a segment of a waterbody, the water quality criteria that are necessary to protect the designated use or uses, and an antidegradation policy. These water quality standards serve two purposes: (1) they establish the water quality goals for a specific waterbody, and (2) they are the basis for establishing water quality-based treatment controls and strategies beyond the technology-based controls required by Sections 301(b) and 306 of the Clean Water Act.

In defining water quality standards, the state may use narrative criteria, numeric criteria, or both. However, the 1987 amendments to the Clean Water Act required states to adopt numeric criteria for toxic pollutants (designated in Section 307(a) of the Act) based on EPA Section 304(a) criteria or other scientific data, when the discharge or presence of those toxic pollutants could reasonably be expected to interfere with designated uses.

In some cases, these water quality criteria are as much as 280 times lower than those that can be achieved using existing EPA methods and required to support technology-based permits. Therefore, EPA developed new sampling and analysis methods to specifically address state needs for measuring toxic metals at water quality criteria levels, when such measurements are necessary to protect designated uses in state water quality standards. The latest criteria published by EPA are those listed in the National Toxics Rule (57 *FR* 60848). This rule includes water quality criteria for 13 metals, and it is these criteria on which the new sampling and analysis methods are based. Method 1640 was specifically developed to provide reliable measurements of four of these metals at EPA WQC levels using on-line chelation preconcentration and inductively coupled plasma-mass spectrometry techniques.

In developing these methods, EPA found that one of the greatest difficulties in measuring pollutants at these levels was precluding sample contamination during collection, transport, and analysis. The degree of difficulty, however, is highly dependent on the metal and site-specific conditions. This analytical method, therefore, is designed to provide the level of protection necessary to preclude contamination in nearly all situations. It is also designed to provide the procedures necessary to produce reliable results at the lowest possible water quality criteria published by EPA. In recognition of the variety of situations to which this method may be applied, and in recognition of continuing technological advances, the method is performance-based. Alternative procedures may be used, so long as those procedures are demonstrated to yield reliable results.

Requests for additional copies should be directed to:

U.S. EPA NCEPI
11029 Kenwood Road
Cincinnati, OH 45242
513/489-8190

Note: This method is intended to be performance based, and the laboratory is permitted to omit any step or modify any procedure provided that *all* performance requirements set forth in this method are met. The laboratory is *not* allowed to omit any quality control analyses. The terms "must," "may," and "should" are included throughout this method and are intended to illustrate the importance of the procedures in producing verifiable data at water quality criteria levels. The term "must" is used to indicate that researchers in trace metals analysis have found certain procedures essential in successfully analyzing samples and avoiding contamination; however, these procedures can be modified or omitted if the laboratory can show that data quality is not affected.

Method 1640

Determination of Trace Elements in Ambient Waters by On-Line Chelation Preconcentration and Inductively Coupled Plasma-Mass Spectrometry

1.0 Scope and Application

1.1 This method is for the determination of dissolved elements in ambient waters at EPA water quality criteria (WQC) levels using on-line chelation preconcentration and inductively coupled plasma-mass spectrometry (ICP-MS). It may also be used for determination of total recoverable element concentrations in these waters. This method was developed by integrating the analytical procedures contained in EPA Method 200.10 with the quality control (QC) and sample handling procedures necessary to avoid contamination and ensure the validity of analytical results during sampling and analysis for metals at EPA WQC levels. This method contains QC procedures that will assure that contamination will be detected when blanks accompanying samples are analyzed. This method is accompanied by Method 1669: *Sampling Ambient Water for Determination of Trace Metals at EPA Water Quality Criteria Levels* (the "Sampling Method"). The Sampling Method is necessary to ensure that contamination will not compromise trace metals determinations during the sampling process.

1.2 This method is applicable to the following elements:

Analyte	Symbol	Chemical Abstract Services Registry Number (CASRN)
Cadmium	(Cd)	7440-43-9
Copper	(Cu)	7440-50-8
Lead	(Pb)	7439-92-1
Nickel	(Ni)	7440-02-0

Table 1 lists the EPA WQC levels, the method detection limit (MDL) for each metal, and the minimum level (ML) for each metal in this method. Linear working ranges will be dependent on the instrumentation and selected operating conditions but should be essentially independent of the matrix because elimination of the matrix is a feature of the method.

1.3 This method is not intended for determination of metals at concentrations normally found in treated and untreated discharges from industrial facilities. Existing regulations (40 CFR Parts 400-500) typically limit concentrations in industrial discharges to the mid to high part-per-billion (ppb) range, whereas ambient metals concentrations are normally in the low part-per-trillion (ppt) to low ppb range.

- 1.4 The ease of contaminating ambient water samples with the metal(s) of interest and interfering substances cannot be overemphasized. This method includes suggestions for improvements in facilities and analytical techniques that should maximize the ability of the laboratory to make reliable trace metals determinations and minimize contamination. These suggestions are given in Section 4.0 and are based on findings of researchers performing trace metals analyses (References 1-8). Additional suggestions for improvement of existing facilities may be found in EPA's *Guidance for Establishing Trace Metals Clean Rooms in Existing Facilities*, which is available from the National Center for Environmental Publications and Information (NCEPI) at the address listed in the introduction to this document.
- 1.5 Clean and ultraclean—The terms "clean" and "ultraclean" have been applied to the techniques needed to reduce or eliminate contamination in trace metals determinations. These terms are not used in this method because they lack an exact definition. However, the information provided in this method is consistent with the summary guidance on clean and ultraclean techniques (Reference 9).
- 1.6 This method follows the EPA Environmental Methods Management Council's "Format for Method Documentation" (Reference 10).
- 1.7 This method is "performance based"; i.e., an alternate procedure or technique may be used, as long as the performance requirements in the method are met. Section 9.1.2 gives details of the tests and documentation required to support and document equivalent performance.
- 1.8 For dissolved metal determinations, samples must be filtered through a 0.45- μ m capsule filter at the field site. The Sampling Method describes the filtering procedures. The filtered samples may be preserved in the field or transported to the laboratory for preservation. Procedures for field preservation are detailed in the Sampling Method; provides procedures for laboratory preservation are provided in this method.
- 1.9 Acid solubilization is required before the determination of total recoverable elements to aid breakdown of complexes or colloids that might influence trace element recoveries.
- 1.10 This method should be used by analysts experienced in the use of inductively coupled plasma mass spectrometry (ICP-MS), including the interpretation of spectral and matrix interferences and procedures for their correction; and should be used only by personnel thoroughly trained in the handling and analysis of samples for determination of metals at EPA WQC levels. A minimum of six months' experience with commercial instrumentation is recommended.
- 1.11 This method is accompanied by a data verification and validation guidance document, *Guidance on the Documentation and Evaluation of Trace Metals Data Collected for CWA Compliance Monitoring*. Before using this method, data users should state the data quality objectives (DQOs) required for a project.

2.0 Summary of Method

- 2.1 This method is used to preconcentrate trace elements using an iminodiacetate functionalized chelating resin (References 11-12). Following acid solubilization, the sample is buffered prior to the chelating column using an on-line system. Group I and II metals, as well as most

anions, are selectively separated from the analytes by elution with ammonium acetate at pH 5.5. The analytes are subsequently eluted into a simplified matrix consisting of dilute nitric acid and are determined by ICP-MS using a directly coupled on-line configuration.

- 2.2 The determinative step in this method is ICP-MS (Reference 13-15). Sample material in solution is introduced by pneumatic nebulization into a radiofrequency plasma where energy transfer processes cause desolvation, atomization, and ionization. The ions are extracted from the plasma through a differentially pumped vacuum interface and separated on the basis of their mass-to-charge (m/z) ratio by a mass spectrometer having a minimum resolution capability of 1 amu peak width at 5% peak height at m/z 300. An electron multiplier or Faraday detector detects ions transmitted through the mass analyzer, and a data handling system processes the resulting current. Interferences relating to the technique (Section 4) must be recognized and corrected. Such corrections must include compensation for isobaric elemental interferences and interferences from polyatomic ions derived from the plasma gas, reagents, or sample matrix. Instrumental drift must be corrected for by the use of internal standardization.

3.0 Definitions

- 3.1 Apparatus—Throughout this method, the sample containers, sampling devices, instrumentation, and all other materials and devices used in sample collection, sample processing, and sample analysis activities will be referred to collectively as the Apparatus.
- 3.2 Other definitions of terms are given in the glossary (Section 18) at the end of this method.

4.0 Contamination and Interferences

- 4.1 Preventing ambient water samples from becoming contaminated during the sampling and analytical process constitutes one of the greatest difficulties encountered in trace metals determinations. Over the last two decades, marine chemists have come to recognize that much of the historical data on the concentrations of dissolved trace metals in seawater are erroneously high because the concentrations reflect contamination from sampling and analysis rather than ambient levels. More recently, historical trace metals data collected from freshwater rivers and streams have been shown to be similarly biased because of contamination during sampling and analysis (Reference 16). Therefore, it is imperative that extreme care be taken to avoid contamination when collecting and analyzing ambient water samples for trace metals.
- 4.2 There are numerous routes by which samples may become contaminated. Potential sources of trace metals contamination during sampling include metallic or metal-containing labware (e.g., talc gloves that contain high levels of zinc), containers, sampling equipment, reagents, and reagent water; improperly cleaned and stored equipment, labware, and reagents; and atmospheric inputs such as dirt and dust. Even human contact can be a source of trace metals contamination. For example, it has been demonstrated that dental work (e.g., mercury amalgam fillings) in the mouths of laboratory personnel can contaminate samples that are directly exposed to exhalation (Reference 3).

4.3 Contamination Control

- 4.3.1 Philosophy—The philosophy behind contamination control is to ensure that any object or substance that contacts the sample is metal free and free from any material that may contain metals.
- 4.3.1.1 The integrity of the results produced cannot be compromised by contamination of samples. Requirements and suggestions for control of sample contamination are given in this method and the Sampling Method.
- 4.3.1.2 Substances in a sample cannot be allowed to contaminate the laboratory work area or instrumentation used for trace metals measurements. Requirements and suggestions for protecting the laboratory are given in this method.
- 4.3.1.3 Although contamination control is essential, personnel health and safety remain the highest priority. Requirements and suggestions for personnel safety are given in Section 5 of this method and the Sampling Method.
- 4.3.2 Avoiding contamination—The best way to control contamination is to completely avoid exposure of the sample to contamination in the first place. Avoiding exposure means performing operations in an area known to be free from contamination. Two of the most important factors in avoiding/reducing sample contamination are (1) an awareness of potential sources of contamination and (2) strict attention to work being done. Therefore it is imperative that the procedures described in this method be carried out by well-trained, experienced personnel.
- 4.3.3 Use a clean environment—The ideal environment for processing samples is a class 100 clean room (Section 6.1.1). If a clean room is not available, all sample preparation should be performed in a class 100 clean bench or a nonmetal glove box fed by particle-free air or nitrogen. Digestions should be performed in a nonmetal fume hood situated, ideally, in the clean room.
- 4.3.4 Minimize exposure—The Apparatus that will contact samples, blanks, or standard solutions should be opened or exposed only in a clean room, clean bench, or glove box so that exposure to an uncontrolled atmosphere is minimized. When not being used, the Apparatus should be covered with clean plastic wrap, stored in the clean bench or in a plastic box or glove box, or bagged in clean zip-type bags. Minimizing the time between cleaning and use will also minimize contamination.
- 4.3.5 Clean work surfaces—Before a given batch of samples is processed, all work surfaces in the hood, clean bench, or glove box in which the samples will be processed should be cleaned by wiping with a lint-free cloth or wipe soaked with reagent water.
- 4.3.6 Wear gloves—Sampling personnel must wear clean, nontalc gloves (Section 6.10.7) during all operations involving handling of the Apparatus, samples, and blanks. Only clean gloves may touch the Apparatus. If another object or substance is touched, the glove(s) must be changed before again handling the Apparatus. If it is even suspected that gloves have become contaminated, work must be halted, the contaminated gloves removed, and a new pair of clean gloves put on. Wearing multiple layers of clean

gloves will allow the old pair to be quickly stripped with minimal disruption to the work activity.

- 4.3.7 Use metal-free Apparatus—All Apparatus used for determination of metals at ambient water quality criteria levels must be nonmetallic, free of material that may contain metals, or both.
- 4.3.7.1 Construction materials—Only the following materials should come in contact with samples: fluoropolymer (FEP, PTFE), conventional or linear polyethylene, polycarbonate, polypropylene, polysulfone, or ultrapure quartz. PTFE is less desirable than FEP because the sintered material in PTFE may contain contaminants and is susceptible to serious memory contamination (Reference 6). Fluoropolymer or glass containers should be used for samples that will be analyzed for mercury because mercury vapors can diffuse in or out of the other materials resulting either in contamination or low-biased results (Reference 3). All materials, regardless of construction, that will directly or indirectly contact the sample must be cleaned using the procedures described in Section 11 and must be known to be clean and metal-free before proceeding.
- 4.3.7.2 The following materials have been found to contain trace metals and should not contact the sample or be used to hold liquids that contact the sample, *unless* these materials have been shown to be free of the metals of interest at the desired level: Pyrex, Kimax, methacrylate, polyvinylchloride, nylon, and Vycor (Reference 6). In addition, highly colored plastics, paper cap liners, pigments used to mark increments on plastics, and rubber all contain trace levels of metals and must be avoided (Reference 17).
- 4.3.7.3 Serialization—It is recommended that serial numbers be indelibly marked or etched on each piece of Apparatus so that contamination can be traced, and logbooks should be maintained to track the sample from the container through the labware to injection into the instrument. It may be useful to dedicate separate sets of labware to different sample types; e.g., receiving waters vs. effluents. However, the Apparatus used for processing blanks and standards must be mixed with the Apparatus used to process samples so that contamination of all labware can be detected.
- 4.3.7.4 The laboratory or cleaning facility is responsible for cleaning the Apparatus used by the sampling team. If there are any indications that the Apparatus is not clean when received by the sampling team (e.g., ripped storage bags), an assessment of the likelihood of contamination must be made. Sampling must not proceed if it is possible that the Apparatus is contaminated. If the Apparatus is contaminated, it must be returned to the laboratory or cleaning facility for proper cleaning before any sampling activity resumes.
- 4.3.8 Avoid Sources of Contamination—Avoid contamination by being aware of potential sources and routes of contamination.

- 4.3.8.1 Contamination by carryover—Contamination may occur when a sample containing low concentrations of metals is processed immediately after a sample containing relatively high concentrations of these metals. To reduce carryover, the sample introduction system may be rinsed between samples with dilute acid and reagent water. When an unusually concentrated sample is encountered, it is followed by analysis of a laboratory blank to check for carryover. For samples containing high levels of metals, it may be necessary to acid-clean or replace the connecting tubing or inlet system to ensure that contamination will not affect subsequent measurements. Samples known or suspected to contain the lowest concentration of metals should be analyzed first followed by samples containing higher levels. For instruments containing autosamplers, the laboratory should keep track of which station is used for a given sample. When an unusually high concentration of a metal is detected in a sample, the station used for that sample should be cleaned more thoroughly to prevent contamination of subsequent samples, and the results for subsequent samples should be checked for evidence of the metal(s) that occurred in high concentration.
- 4.3.8.2 Contamination by samples—Significant laboratory or instrument contamination may result when untreated effluents, in-process waters, landfill leachates, and other samples containing high concentrations of inorganic substances are processed and analyzed. As stated in Section 1.0, this method is not intended for application to these samples, and samples containing high concentrations should not be permitted into the clean room and laboratory dedicated for processing trace metals samples.
- 4.3.8.3 Contamination by indirect contact—Apparatus that may not directly come in contact with the samples may still be a source of contamination. For example, clean tubing placed in a dirty plastic bag may pick up contamination from the bag and then subsequently transfer the contamination to the sample. Therefore, it is imperative that every piece of the Apparatus that is directly or indirectly used in the collection, processing, and analysis of ambient water samples be cleaned as specified in Section 11.
- 4.3.8.4 Contamination by airborne particulate matter—Less obvious substances capable of contaminating samples include airborne particles. Samples may be contaminated by airborne dust, dirt, particles, or vapors from: unfiltered air supplies; nearby corroded or rusted pipes, wires, or other fixtures; or metal-containing paint. Whenever possible, sample processing and analysis should occur as far as possible from sources of airborne contamination.
- 4.4 Interferences—Interference sources that may cause inaccuracies in the determination of trace elements by ICP-MS are given below and must be recognized and corrected for. Internal standards should be used to correct for instrumental drift as well as suppressions or enhancements of instrument response caused by the sample matrix.
- 4.4.1 Isobaric elemental interferences—Are caused by isotopes of different elements that form singly or doubly charged ions of the same nominal m/z and that cannot be resolved by the mass spectrometer. All elements determined by this method have, at a

minimum, one isotope free of isobaric elemental interferences. If an alternative isotope that has a higher natural abundance is selected to achieve greater sensitivity, an isobaric interference may occur. All data obtained under such conditions must be corrected by measuring the signal from another isotope of the interfering element and subtracting the contribution the isotope of interest based on the relative abundance of the alternate isotope and isotope of interest. A record of this correction process should be included with the report of the data. It should be noted that such corrections will only be as accurate as the accuracy of the relative abundance used in the equation for data calculations. Relative abundances should be established before any corrections are applied.

- 4.4.2 Abundance sensitivity—Is a property defining the degree to which the wings of a mass peak contribute to adjacent m/z 's. Ion energy and quadrupole operating pressure affect the abundance sensitivity. Wing overlap interferences may result when a small m/z peak is being measured adjacent to a large one. The potential for these interferences should be recognized and the spectrometer resolution adjusted to minimize them.
- 4.4.3 Isobaric polyatomic ion interferences—Are caused by ions consisting of more than one atom which have the same nominal m/z as the isotope of interest, and which cannot be resolved by the mass spectrometer in use. These ions are commonly formed in the plasma or interface system from support gases or sample components. Such interferences must be recognized, and when they cannot be avoided by selecting alternative analytical isotopes, appropriate corrections must be made to the data. Equations for the correction of data should be established at the time of the analytical run sequence because the polyatomic ion interferences will be highly dependent on the sample matrix and chosen instrument conditions.
- 4.4.4 Physical interferences—Are associated with the physical processes that govern the transport of sample into the plasma, sample conversion processes in the plasma, and the transmission of ions through the plasma-mass spectrometer interface. These interferences may result in differences between instrument responses for the sample and the calibration standards. Physical interferences may occur in the transfer of solution to the nebulizer (e.g., viscosity effects), at the point of aerosol formation and transport to the plasma (e.g., surface tension), or during excitation and ionization processes within the plasma itself. Internal standardization may be effectively used to compensate for many physical interference effects (Reference 18). Internal standards ideally should have similar analytical behavior to the elements being determined.
- 4.4.5 Memory interferences—Result when isotopes of elements in a previous sample contribute to the signals measured in a new sample. Memory effects can result from sample deposition on the sampler and skimmer cones, and from the buildup of sample material in the plasma torch and spray chamber. The site where these effects occur depends on the element and can be minimized by flushing the system with a rinse blank between samples (Section 7.6.3). The possibility of memory interferences should be recognized within an analytical run and suitable rinse times should be used to reduce them. The rinse times necessary for a particular element should be estimated before it is analyzed. This estimation may be achieved by aspirating a standard containing elements corresponding to ten times the upper end of the linear range for a normal sample analysis period, followed by analysis of the rinse blank at designated

intervals. The length of time required to reduce analyte signals below the ML should be noted. Memory interferences may also be assessed within an analytical run by using a minimum of three replicate integrations for data acquisition. If the integrated signal values drop consecutively, the analyst should be alerted to the possibility of a memory effect, and should examine the analyte concentration in the previous sample to identify if the memory effect was high. If a memory interference is suspected, the sample should be reanalyzed after a long rinse period.

- 4.4.6 A principal advantage of this method is the selective elimination of species giving rise to polyatomic spectral interferences on certain transition metals (e.g., removal of the chloride interference on vanadium). As most of the sample matrix is removed, matrix-induced physical interferences are also substantially reduced.
- 4.4.7 Low recoveries may be encountered in the preconcentration cycle if the trace elements are complexed by competing chelators in the sample or are present as colloidal material. Acid solubilization pretreatment is used to improve analyte recovery and to minimize adsorption, hydrolysis, and precipitation effects.

5.0 Safety

- 5.1 The toxicity or carcinogenicity of reagents used in this method have not been fully established. Each chemical should be regarded as a potential health hazard and exposure to these compounds should be as low as reasonably achievable.
 - 5.1.1 Each laboratory is responsible for maintaining a current awareness file of OSHA regulations for the safe handling of the chemicals specified in this method (References 19-22). A reference file of material safety data sheets (MSDSs) should also be available to all personnel involved in the chemical analysis. It is also suggested that the laboratory perform personal hygiene monitoring of each analyst who uses this method and that the results of this monitoring be made available to the analyst. The references and bibliography at the end of Reference 22 are particularly comprehensive in dealing with the general subject of laboratory safety.
 - 5.1.2 Concentrated nitric and hydrochloric acids present various hazards and are moderately toxic and extremely irritating to skin and mucus membranes. Use these reagents in a fume hood whenever possible and if eye or skin contact occurs, flush with large volumes of water. Always wear protective clothing and safety glasses or a shield for eye protection, and observe proper mixing when working with these reagents.
- 5.2 The acidification of samples containing reactive materials may result in the release of toxic gases such as cyanides or sulfides. Samples should be acidified in a fume hood.
- 5.3 All personnel handling environmental samples known to contain or to have been in contact with human waste should be immunized against known disease-causative agents.
- 5.4 Analytical plasma sources emit radiofrequency radiation in addition to intense UV radiation. Suitable precautions should be taken to protect personnel from such hazards. The inductively coupled plasma should only be viewed with proper eye protection from UV emissions.

6.0 Apparatus, Equipment, and Supplies

Disclaimer: The mention of trade names or commercial products in this method is for illustrative purposes only and does not constitute endorsement or recommendation for use by the Environmental Protection Agency. Equivalent performance may be achievable using apparatus and materials other than those suggested here. The laboratory is responsible for demonstrating equivalent performance.

6.1 Facility

6.1.1 Clean room—Class 100, 200-ft² minimum, with down-flow, positive-pressure ventilation, air-lock entrances, and pass-through doors.

6.1.1.1 Construction materials—Nonmetallic, preferably plastic sheeting attached without metal fasteners. If painted, paints that do not contain the metal(s) of interest should be used.

6.1.1.2 Adhesive mats—for use at entry points to control dust and dirt from shoes.

6.1.2 Fume hoods—nonmetallic, two minimum, with one installed internal to the clean room.

6.1.3 Clean benches—class 100, one installed in the clean room; the other adjacent to the analytical instrument(s) for preparation of samples and standards.

6.2 Preconcentration system—System containing no metal parts in the analyte flow path, configured as shown in Figure 1.

NOTE: *An alternate preconcentration system to the one described below may be used provided that all performance criteria listed in this method can be met. If low recoveries are encountered in the preconcentration cycle for a particular analyte, it may be necessary to use an alternate preconcentration system.*

6.2.1 Column—Macroporous iminodiacetate chelating resin (Dionex Metpac CC-1 or equivalent).

6.2.2 Sample loop—10-mL loop constructed from narrow-bore, high-pressure inert tubing, Tefzel ETFE (ethylene tetra-fluoroethylene) or equivalent.

6.2.3 Eluent pumping system (P1)—Programmable-flow, high-pressure pumping system, capable of delivering either one of two eluents at a pressure up to 2000 psi and a flow rate of 1–5 mL/min.

6.2.4 Auxiliary pumps

- 6.2.4.1 On-line buffer pump (P2)—Piston pump (Dionex QIC pump or equivalent) for delivering 2M ammonium acetate buffer solution.
 - 6.2.4.2 Carrier pump (P3)—Peristaltic pump (Gilson Minipuls or equivalent) for delivering 1% nitric acid carrier solution.
 - 6.2.4.3 Sample pump (P4)—Peristaltic pump for loading sample loop.
 - 6.2.5 Control valves—Inert, double-stack, pneumatically operated four-way slider valves with connectors.
 - 6.2.6 Argon gas supply regulated at 80–100 psi
 - 6.2.7 Solution reservoirs—Inert containers, e.g., high density polyethylene (HDPE), for holding eluent and carrier reagents.
 - 6.2.8 Tubing—High pressure, narrow bore, inert tubing (e.g., Tefzel ETFE or equivalent) for interconnection of pumps and valve assemblies and a minimum length for connection of the preconcentration system to the ICP-MS instrument.
- 6.3 Inductively coupled plasma mass spectrometer
- 6.3.1 Instrument capable of scanning the mass range 5–250 amu with a minimum resolution capability of 1-amu peak width at 5% peak height. Instrument may be fitted with a conventional or extended dynamic range detection system.
 - 6.3.2 Radio-frequency generator compliant with FCC regulations.
 - 6.3.3 Argon gas supply—High-purity grade (99.99%). When analyses are conducted frequently, liquid argon is more economical and requires less frequent replacement of tanks than compressed argon in conventional cylinders.
 - 6.3.4 A variable-speed peristaltic pump is required for solution delivery to the nebulizer.
 - 6.3.5 A mass-flow controller on the nebulizer gas supply is required. A water-cooled spray chamber may be of benefit in reducing some types of interferences (e.g., from polyatomic oxide species).
 - 6.3.6 If an electron multiplier detector is being used, precautions should be taken, where necessary, to prevent exposure to high ion flux. Otherwise changes in instrument response or damage to the multiplier may result. Samples having high concentrations of elements beyond the linear range of the instrument and with isotopes falling within scanning windows should be diluted before analysis.
- 6.4 Analytical balance—with capability to measure to 0.1 mg, for use in weighing solids and for preparing standards.
- 6.5 Temperature-adjustable hot plate—capable of maintaining a temperature of 95°C.

- 6.6 Centrifuge with guard bowl, electric timer, and brake (optional)
- 6.7 Drying oven—gravity convection, with thermostatic control capable of maintaining 105°C (\pm 5°C).
- 6.8 Alkaline detergent—Liquinox®, Alconox®, or equivalent.
- 6.9 pH meter or pH paper
- 6.10 Labware—For determination of trace levels of elements, contamination and loss are of prime consideration. Potential contamination sources include improperly cleaned laboratory apparatus and general contamination within the laboratory environment from dust, etc. A clean laboratory work area should be designated for handling trace element samples. Sample containers can introduce positive and negative errors in the determination of trace elements by (1) contributing contaminants through surface desorption or leaching, and (2) depleting element concentrations through adsorption processes. All labware must be metal free. Suitable construction materials are fluoropolymer (FEP, PTFE), conventional or linear polyethylene, polycarbonate, and polypropylene. Fluoropolymer should be used when samples are to be analyzed for mercury. All labware should be cleaned according to the procedure in Section 11.4. Gloves, plastic wrap, storage bags, and filters may all be used new without additional cleaning unless results of the equipment blank pinpoint any of these materials as a source of contamination. In this case, either an alternate supplier must be obtained or the materials must be cleaned.

NOTE: *Chromic acid must not be used for cleaning glassware.*

- 6.10.1 Volumetric flasks, graduated cylinders, funnels, and centrifuge tubes
- 6.10.2 Assorted calibrated pipets
- 6.10.3 Beakers—fluoropolymer (or other suitable material), 250-mL with fluoropolymer covers.
- 6.10.4 Storage bottles—Narrow-mouth, fluoropolymer with fluoropolymer screw closure, 125- to 250-mL capacities.
- 6.10.5 Wash bottle—One-piece stem fluoropolymer, with screw closure, 125-mL capacity.
- 6.10.6 Tongs—For removal of Apparatus from acid baths. Coated metal tongs may not be used.
- 6.10.7 Gloves—clean, nontalc polyethylene, latex, or vinyl; various lengths. Heavy gloves should be worn when working in acid baths since baths will contain hot, strong acids.
- 6.10.8 Buckets or basins—5- to 50-L capacity, for acid soaking of the Apparatus.
- 6.10.9 Brushes—Nonmetallic, for scrubbing Apparatus.

- 6.10.10 Storage bags—Clean, zip-type, nonvented, colorless polyethylene (various sizes) for storage of Apparatus.
- 6.10.11 Plastic wrap—Clean, colorless polyethylene for storage of Apparatus.
- 6.11 Sampling Equipment—The sampling team may contract with the laboratory or a cleaning facility that is responsible for cleaning, storing, and shipping all sampling devices, sample bottles, filtration equipment, and all other Apparatus used for the collection of ambient water samples. Before the equipment is shipped to the field site, the laboratory or facility must generate an acceptable equipment blank (Section 9.6.3) to demonstrate that the sampling equipment is free from contamination.
- 6.11.1 Sampling Devices—Before ambient water samples are collected, consideration should be given to the type of sample to be collected and the devices to be used (grab, surface, or subsurface samplers). The laboratory or cleaning facility must clean all devices used for sample collection. Various types of samplers are described in the Sampling Method. Cleaned sampling devices should be stored in polyethylene bags or wrap.
- 6.11.2 Sample bottles—Fluoropolymer, conventional or linear polyethylene, polycarbonate, or polypropylene; 500-mL with lids. Cleaned sample bottles should be filled with 0.1% HCl (v/v) until use.

NOTE: *If mercury is a target analyte, fluoropolymer or glass bottles must be used.*

6.11.3 Filtration Apparatus

- 6.11.3.1 Filter—Gelman Supor 0.45- μ m, 15-mm diameter capsule filter (Gelman 12175, or equivalent).
- 6.11.3.2 Peristaltic pump—115-V a.c., 12-V d.c., internal battery, variable speed, single-head (Cole-Parmer, portable, "Masterflex L/S," Catalog No. H-07570-10 drive with Quick Load pump head, Catalog No. H-07021-24, or equivalent).
- 6.11.3.3 Tubing for use with peristaltic pump—styrene/ethylene/butylene/silicone (SEBS) resin, approx 3/8-in i.d. by approximately 3 ft (Cole-Parmer size 18, Catalog No. G-06464-18, or approximately 1/4-in i.d., Cole-Parmer size 17, Catalog No. G-06464-17, or equivalent). Tubing is cleaned by soaking in 5–10% HCl solution for 8–24 h, rinsing with reagent water in a clean bench in a clean room, and drying in the clean bench by purging with metal-free air or nitrogen. After drying, the tubing is double-bagged in clear polyethylene bags, serialized with a unique number, and stored until use.

7.0 Reagents and Standards

Reagents may contain elemental impurities that might affect the integrity of analytical data. Because of the high sensitivity of ICP-MS, high-purity reagents should be used. Each reagent lot should be tested for the metals of interest by diluting and analyzing an aliquot from the lot using the techniques and instrumentation to be used for analysis of samples. The lot will be acceptable if the concentration of the metal of interest is below the MDL listed in this method. All acids used for this method must be ultra high-purity grade. Suitable acids are available from a number of manufacturers or may be prepared by sub-boiling distillation.

- 7.1 Reagents for cleaning Apparatus, sample bottle storage, and sample preservation and analysis
- 7.1.1 Nitric acid—concentrated (sp gr 1.41), Seastar or equivalent
 - 7.1.2 Nitric acid (1+1)—Add 500 mL concentrated nitric acid to 400 mL of reagent water and dilute to 1 L.
 - 7.1.3 Nitric acid (1+9)—Add 100 mL concentrated nitric acid to 400 mL of reagent water and dilute to 1 L.
 - 7.1.4 Nitric acid 1.25M—Dilute 79 mL (112 g) concentrated nitric acid to 1000 mL with reagent water.
 - 7.1.5 Nitric acid 1%—Dilute 10 mL concentrated nitric acid to 1000 mL with reagent water.
 - 7.1.6 Hydrochloric acid—concentrated (sp gr 1.19).
 - 7.1.7 Hydrochloric acid (1+1)—Add 500 mL concentrated hydrochloric acid to 400 mL of reagent water and dilute to 1 L.
 - 7.1.8 Hydrochloric acid (1+4)—Add 200 mL concentrated hydrochloric acid to 400 mL of reagent water and dilute to 1 L.
 - 7.1.9 Hydrochloric acid (HCl)—1N trace metal grade
 - 7.1.10 Hydrochloric acid (HCl)—10% wt, trace metal grade
 - 7.1.11 Hydrochloric acid (HCl)—1% wt, trace metal grade
 - 7.1.12 Hydrochloric acid (HCl)—0.5% (v/v), trace metal grade
 - 7.1.13 Hydrochloric acid (HCl)—0.1% (v/v) ultrapure grade
 - 7.1.14 Acetic acid, glacial (sp gr 1.05)
 - 7.1.15 Ammonium hydroxide (20%)

- 7.1.16 Ammonium acetate buffer 1M, pH 5.5—Add 58 mL (60.5 g) of glacial acetic acid to 600 mL of reagent water. Add 65 mL (60 g) of 20% ammonium hydroxide and mix. Check the pH of the resulting solution by withdrawing a small aliquot and testing with a calibrated pH meter, adjusting the solution to pH 5.5 (± 0.1) with small volumes of acetic acid or ammonium hydroxide as necessary. Cool and dilute to 1 L with reagent water.
- 7.1.17 Ammonium acetate buffer 2M, pH 5.5—Prepare as for Section 7.1.16 using 116 mL (121 g) glacial acetic acid and 130 mL (120 g) 20% ammonium hydroxide, diluted to 1000 mL with reagent water.

NOTE: *The ammonium acetate buffer solutions may be further purified by passing them through the chelating column at a flow rate of 5.0 mL/min. With reference to Figure 1, pump the buffer solution through the column using pump P1, with valves A and B off and valve C on. Collect the purified solution in a container at the waste outlet. Then elute the collected contaminants from the column using 1.25M nitric acid for 5 min at a flow rate of 4.0 mL/min.*

- 7.1.18 Oxalic acid dihydrate (CASRN 6153-56-6), 0.2M—Dissolve 25.2 g reagent grade $C_2H_2O_4 \cdot 2H_2O$ in 250 mL reagent water and dilute to 1000 mL with reagent water.

CAUTION: *Oxalic acid is toxic; handle with care.*

- 7.2 Reagent water—Water demonstrated to be free from the metal(s) of interest and potentially interfering substances at the MDL for that metal listed in Table 1. Prepared by distillation, deionization, reverse osmosis, anodic/cathodic stripping voltammetry, or other technique that removes the metal(s) and potential interferent(s).
- 7.3 Standard stock solutions—May be purchased from a reputable commercial source or prepared from ultra high-purity grade chemicals or metals (99.99–99.999% pure). All salts should be dried for 1 h at 105°C, unless otherwise specified.

CAUTION: *Many metal salts are extremely toxic if inhaled or swallowed. (Wash hands thoroughly after handling.) Stock solutions should be stored in plastic bottles.*

The following procedures may be used for preparing standard stock solutions:

NOTE: *Some metals, particularly those that form surface oxides, require cleaning before they are weighed. This may be achieved by pickling the surface of the metal in acid. An amount over the desired weight should be pickled repeatedly, rinsed with water, dried, and weighed until the desired weight is achieved.*

- 7.3.1 Bismuth solution, stock 1 mL = 1000 μg Bi—Dissolve 0.1115 g Bi_2O_3 in 5 mL concentrated nitric acid. Heat to effect solution. Cool and dilute to 100 mL with reagent water.
- 7.3.2 Cadmium solution, stock 1 mL = 1000 μg Cd: Pickle cadmium metal in (1+9) nitric acid to an exact weight of 0.100 g. Dissolve in 5 mL (1+1) nitric acid, heating to effect solution. Cool and dilute to 100 mL with reagent water.
- 7.3.3 Copper solution, stock 1 mL = 1000 μg Cu: Pickle copper metal in (1+9) nitric acid to an exact weight of 0.100 g. Dissolve in 5 mL (1+1) nitric acid, heating to effect solution. Cool and dilute to 100 mL with reagent water.
- 7.3.4 Indium solution, stock 1 mL = 1000 μg In: Pickle indium metal in (1+1) nitric acid to an exact weight of 0.100 g. Dissolve in 10 mL (1+1) nitric acid, heating to effect solution. Cool and dilute to 100 mL with reagent water.
- 7.3.5 Lead solution, stock 1 mL = 1000 μg Pb: Dissolve 0.1599 g PbNO_3 in 5 mL (1+1) nitric acid. Dilute to 100 mL with reagent water.
- 7.3.6 Nickel solution, stock 1 mL = 1000 μg Ni: Dissolve 0.100 g nickel powder in 5 mL concentrated nitric acid, heating to effect solution. Cool and dilute to 100 mL with reagent water.
- 7.3.7 Scandium solution, stock 1 mL = 1000 μg Sc: Dissolve 0.1534 g Sc_2O_3 in 5 mL (1+1) nitric acid, heating to effect solution. Cool and dilute to 100 mL with reagent water.
- 7.3.8 Terbium solution, stock 1 mL = 1000 μg Tb: Dissolve 0.1176 g Tb_4O_7 in 5 mL concentrated nitric acid, heating to effect solution. Cool and dilute to 100 mL with reagent water.
- 7.3.9 Yttrium solution, stock 1 mL = 1000 μg Y—Dissolve 0.1270 g Y_2O_3 in 5 mL (1+1) nitric acid, heating to effect solution. Cool and dilute to 100 mL with reagent water.
- 7.4 Multielement stock standard solution—When multielement stock standards are prepared, care must be taken that the elements are compatible and stable. Originating element stocks should be checked for the presence of impurities that might influence the accuracy of the standard. Freshly prepared standards should be transferred to acid-cleaned, new FEP or HDPE bottles for storage and monitored periodically for stability. A multielement stock standard solution containing cadmium, copper, lead, and nickel (1 mL = 10 μg) may be prepared by diluting 1 mL of each single element stock in the list to 100 mL with reagent water containing 1% (v/v) nitric acid.
- 7.4.1 Preparation of calibration standards—Fresh multielement calibration standards should be prepared every 2 weeks or as needed. Dilute the stock multielement standard solution to levels appropriate to the operating range of the instrument using reagent water containing 1% (v/v) nitric acid. Calibration standards should be prepared at a minimum of three concentrations, one of which must be at the ML (Table 1), and another that must be near the upper end of the linear dynamic range. If the direct addition procedure is being used (Method A, Section 10.3), add internal standards

(Section 7.5) to the calibration standards and store in fluoropolymer bottles. Calibration standards should be verified initially using a quality control sample (Section 7.8).

- 7.5 Internal standard stock solution—1 mL = 100 µg. Dilute 10 mL of scandium, yttrium, indium, terbium and bismuth stock standards (Section 7.3) to 100 mL with reagent water, and store in a FEP bottle. Use this solution concentrate for addition to blanks, calibration standards and samples, or dilute by an appropriate amount using 1% (v/v) nitric acid, if the internal standards are being added by peristaltic pump (Method B, Section 10.3).

NOTE: *Bismuth should not be used as an internal standard using the direct addition method (Method A, Section 10.3) because it is not efficiently concentrated on the iminodiacetate column.*

- 7.6 Blanks—The laboratory should prepare the following types of blanks. A calibration blank is used to establish the analytical calibration curve; the laboratory (method) blank is used to assess possible contamination from the sample preparation procedure and to assess spectral background; and the rinse blank is used to flush the instrument between samples in order to reduce memory interferences. In addition to these blanks, the laboratory may be required to analyze field blanks (Section 9.6.2) and equipment blanks (Section 9.6.3).
- 7.6.1 Calibration blank—Consists of 1% (v/v) nitric acid in reagent water. If the direct addition procedure (Method A, Section 10.3) is being used, add internal standards.
- 7.6.2 Laboratory blank—Must contain all the reagents in the same volumes as used in processing the samples. The laboratory blank must be carried through the same entire preparation scheme as the samples including digestion, when applicable (Section 9.6.1). If the direct addition procedure (Method A, Section 10.3) is being used, add internal standards to the solution after preparation is complete.
- 7.6.3 Rinse blank—Consists of 1% (v/v) nitric acid in reagent water.
- 7.7 Tuning solution—This solution is used for instrument tuning and mass calibration before analysis (Section 10.2). The solution is prepared by mixing nickel, yttrium, indium, terbium, and lead stock solutions (Section 7.3) in 1% (v/v) nitric acid to produce a concentration of 100 µg/L of each element. Internal standards are not added to this solution. (Depending on the sensitivity of the instrument, this solution may need to be diluted 10-fold.)
- 7.8 Quality control sample (QCS)—The QCS should be obtained from a source outside the laboratory. The concentration of the QCS solution analyzed will depend on the sensitivity of the instrument. To prepare the QCS, dilute an appropriate aliquot of analytes to a concentration ≤ 100 µg/L in 1% (v/v) nitric acid. Because of lower sensitivity, selenium may be diluted to a concentration of < 500 µg/L. If the direct addition procedure (Method A, Section 10.3) is being used, add internal standards after dilution, mix, and store in a FEP bottle. The QCS should be analyzed as needed to meet data quality needs and a fresh solution should be prepared quarterly or more frequently as needed.

- 7.9 Ongoing precision and recovery (OPR) Sample—To an aliquot of reagent water, add aliquots of the multielement stock standard (Section 7.4) to prepare the OPR. The OPR must be carried through the same entire preparation scheme as the samples including sample digestion, when applicable (Section 9.7). If the direct addition procedure (Method A, Section 10.3) is being used, add internal standards to this solution after preparation has been completed.

8.0 Sample Collection, Filtration, Preservation, and Storage

- 8.1 Before an aqueous sample is collected, consideration should be given to the type of data required, (i.e., dissolved or total recoverable), so that appropriate preservation and pretreatment steps can be taken. The pH of all aqueous samples must be tested immediately before they are aliquotted for processing or direct analysis to ensure the sample has been properly preserved. If properly acid-preserved, the sample can be held up to 6 months before analysis.
- 8.2 Sample collection—Samples are collected as described in the Sampling Method.
- 8.3 Sample filtration—For dissolved metals, samples and field blanks are filtered through a 0.45- μm capsule filter at the field site. Filtering procedures are described in the Sampling Method. For the determination of total recoverable elements, samples are not filtered but should be preserved according to the procedures in Section 8.4.
- 8.4 Sample preservation—Preservation of samples and field blanks for both dissolved and total recoverable elements may be performed in the field when the samples are collected or in the laboratory. However, to avoid the hazards of strong acids in the field and transport restrictions, to minimize the potential for sample contamination, and to expedite field operations, the sampling team may prefer to ship the samples to the laboratory within 2 weeks of collection. Samples and field blanks should be preserved at the laboratory immediately when they are received. For all metals, preservation involves the addition of 10% HNO_3 (Section 7.1.3) to bring the sample to $\text{pH} < 2$. For samples received at neutral pH, approx 5 mL of 10% HNO_3 per liter will be required.
- 8.4.1 Wearing clean gloves, remove the cap from the sample bottle, add the volume of reagent grade acid that will bring the pH to < 2 , and recap the bottle immediately. If the bottle is full, withdraw the necessary volume using a precleaned pipet and then add the acid. Record the volume withdrawn and the amount of acid used.

NOTE: Do not dip pH paper or a pH meter into the sample; remove a small aliquot with a clean pipet and test the aliquot. When the nature of the sample is either unknown or known to be hazardous, the sample should be acidified in a fume hood. See Section 5.2.

- 8.4.2 Store the preserved sample for a minimum of 48 h at 0–4°C to allow the acid to completely dissolve the metal(s) adsorbed on the container walls. The sample pH should be verified as < 2 immediately before an aliquot is withdrawn for processing or direct analysis. If, for some reason such as high alkalinity, the sample pH is verified to be > 2 , more acid must be added and the sample held for 16 h until verified to be $\text{pH} < 2$. See Section 8.1.

- 8.4.3 With each sample batch, preserve a method blank and an OPR sample in the same way as the sample(s).
- 8.4.4 Sample bottles should be stored in polyethylene bags at 0–4°C until analysis.

9.0 Quality Assurance/Quality Control

- 9.1 Each laboratory that uses this method is required to operate a formal quality assurance program (Reference 23). The minimum requirements of this program consist of an initial demonstration of laboratory capability, analysis of samples spiked with metals of interest to evaluate and document data quality, and analysis of standards and blanks as tests of continued performance. Laboratory performance is compared to established performance criteria to determine that results of the analysis meet the performance characteristics of the method.
- 9.1.1 The analyst shall make an initial demonstration of the ability to generate acceptable accuracy and precision with this method. This ability is established as described in Section 9.2.
- 9.1.2 In recognition of advances that are occurring in analytical technology, the analyst is permitted to exercise certain options to eliminate interferences or lower the costs of measurements. These options include alternate digestion, preconcentration, cleanup procedures, and changes in instrumentation. Alternate determinative techniques, such as the substitution of a colorimetric technique or changes that degrade method performance, are not allowed. If an analytical technique other than the techniques specified in the method is used, then that technique must have a specificity equal to or better than the specificity of the techniques in the method for the analytes of interest.
- 9.1.2.1 Each time the method is modified, the analyst is required to repeat the procedure in Section 9.2. If the the change will affect the detection limit of the method, the laboratory is required to demonstrate that the MDL (40 *CFR* Part 136, Appendix B) is lower than the MDL for that analyte in this method, or one-third the regulatory compliance level, whichever is higher. If the change will affect calibration, the analyst must recalibrate the instrument according to Section 10.
- 9.1.2.2 The laboratory is required to maintain records of modifications made to this method. These records include the following, at a minimum:
- 9.1.2.2.1 The names, titles, addresses, and telephone numbers of the analyst(s) who performed the analyses and modification, and of the quality control officer who witnessed and will verify the analyses and modification.
- 9.1.2.2.2 A listing of metals measured, by name and CAS Registry number.
- 9.1.2.2.3 A narrative stating reason(s) for the modification(s).

9.1.2.2.4 Results from all quality control (QC) tests comparing the modified method to this method, including:

- (a) Calibration
- (b) Calibration verification
- (c) Initial precision and recovery (Section 9.2)
- (d) Analysis of blanks
- (e) Accuracy assessment

9.1.2.2.5 Data that will allow an independent reviewer to validate each determination by tracing the instrument output (peak height, area, or other signal) to the final result. These data are to include, where possible:

- (a) Sample numbers and other identifiers
- (b) Digestion/preparation or extraction dates
- (c) Analysis dates and times
- (d) Analysis sequence/run chronology
- (e) Sample weight or volume
- (f) Volume before the extraction/concentration step
- (g) Volume after each extraction/concentration step
- (h) Final volume before analysis
- (i) Injection volume
- (j) Dilution data, differentiating between dilution of a sample or extract
- (k) Instrument and operating conditions (make, model, revision, modifications)
- (l) Sample introduction system (ultrasonic nebulizer, flow injection system, etc.)
- (m) Preconcentration system
- (n) Operating conditions (background corrections, temperature program, flow rates, etc.)
- (o) Detector (type, operating conditions, etc.)
- (p) Mass spectra, printer tapes, and other recordings of raw data
- (q) Quantitation reports, data system outputs, and other data to link raw data to results reported

9.1.3 Analyses of blanks are required to demonstrate freedom from contamination. Section 9.6 describes the required types, procedures, and criteria for analysis of blanks.

9.1.4 The laboratory shall spike at least 10% of the samples with the metal(s) of interest to monitor method performance. Section 9.3 describes this test. When results of these spikes indicate atypical method performance for samples, an alternative extraction or cleanup technique must be used to bring method performance within acceptable limits. If method performance for spikes cannot be brought within the limits given in this method, the result may not be reported for regulatory compliance purposes.

- 9.1.5 The laboratory shall, on an ongoing basis, demonstrate through calibration verification and through analysis of the ongoing precision and recovery aliquot that the analytical system is in control. These procedures are described in Sections 10.5 and 9.7 of this method.
- 9.1.6 The laboratory shall maintain records to define the quality of data that are generated. Development of accuracy statements is described in Section 9.3.4.
- 9.2 Initial demonstration of laboratory capability
- 9.2.1 Method detection limit—To establish the ability to detect the trace metals of interest, the analyst shall determine the MDL for each analyte according to the procedure in 40 *CFR* 136, Appendix B using the apparatus, reagents, and standards that will be used in the practice of this method. The laboratory must produce an MDL that is less than or equal to the MDL listed in Table 1, or one-third the regulatory compliance limit, whichever is greater. MDLs should be determined when a new operator begins work or whenever, in the judgment of the analyst, a change in instrument hardware or operating conditions would dictate that they be redetermined.
- 9.2.2 Initial precision and recovery (IPR)—To establish the ability to generate acceptable precision and recovery, the analyst shall perform the following operations.
- 9.2.2.1 Analyze four aliquots of reagent water spiked with the metal(s) of interest at 2–3 times the ML (Table 1), according to the procedures in Section 12. All digestion, extraction, and concentration steps, and the containers, labware, and reagents that will be used with samples must be used in this test.
- 9.2.2.2 Using results of the set of four analyses, compute the average percent recovery (X) for the metal(s) in each aliquot and the standard deviation of the recovery (s) for each metal.
- 9.2.2.3 For each metal, compare s and X with the corresponding limits for initial precision and recovery in Table 2. If s and X for all metal(s) meet the acceptance criteria, system performance is acceptable and analysis of blanks and samples may begin. If, however, any individual s exceeds the precision limit or any individual X falls outside the range for accuracy, system performance is unacceptable for that metal. Correct the problem and repeat the test (Section 9.2.2.1).
- 9.2.3 Linear calibration ranges—Linear calibration ranges are primarily detector limited. The upper limit of the linear calibration range should be established for each analyte by determining the signal responses from a minimum of three different concentration standards, one of which is close to the upper limit of the linear range. Care should be taken to avoid potential damage to the detector during this process. The analyst should judge the linear calibration range that may be used for the analysis of samples from the resulting data. The upper limit should be an observed signal no more than 10% below the level extrapolated from lower standards. Determined sample analyte concentrations that are greater than 90% of the determined upper limit must be diluted and reanalyzed. The upper limits should be verified whenever, in the judgement of the

analyst, a change in analytical performance caused by either a change in instrument hardware or operating conditions would dictate they be redetermined.

9.2.4 Quality control sample (QCS)—When beginning the use of this method, quarterly or as required to meet data quality needs, verify the calibration standards and acceptable instrument performance with the preparation and analyses of a QCS (Section 7.8). To verify the calibration standards the determined mean concentration from 3 analyses of the QCS must be within $\pm 10\%$ of the stated QCS value. If the QCS is not within the required limits, an immediate second analysis of the QCS is recommended to confirm unacceptable performance. If the calibration standards, acceptable instrument performance, or both cannot be verified, the source of the problem must be identified and corrected before proceeding with further analyses.

9.3 Method accuracy—To assess the performance of the method on a given sample matrix, the laboratory must perform matrix spike (MS) and matrix spike duplicate (MSD) sample analyses on 10% of the samples from each site being monitored, or at least one MS sample analysis and one MSD sample analysis must be performed for each sample batch (samples collected from the same site at the same time, to a maximum of 10 samples), whichever is more frequent. Blanks (e.g., field blanks) may not be used for MS/MSD analysis.

9.3.1 The concentration of the MS and MSD is determined as follows:

9.3.1.1 If, as in compliance monitoring, the concentration of a specific metal in the sample is being checked against a regulatory concentration limit, the spike must be at that limit or at 1–5 times the background concentration, whichever is greater.

9.3.1.2 If the concentration is not being checked against a regulatory limit, the concentration must be at 1–5 times the background concentration or at 1–5 times the ML in Table 1, whichever is greater.

9.3.2 Assessing spike recovery

9.3.2.1 Determine the background concentration (B) of each metal by analyzing one sample aliquot according to the procedure in Section 12.

9.3.2.2 If necessary, prepare a QC check sample concentrate that will produce the appropriate level (Section 9.3.1) in the sample when the concentrate is added.

9.3.2.3 Spike a second sample aliquot with the QC check sample concentrate and analyze it to determine the concentration after spiking (A) of each metal.

9.3.2.4 Calculate each percent recovery (P) as $100(A - B)/T$, where T is the known true value of the spike.

9.3.3 Compare the percent recovery (P) for each metal with the corresponding QC acceptance criteria found in Table 2. If any individual P falls outside the designated range for recovery, that metal has failed the acceptance criteria.

- 9.3.3.1 For a metal that has failed the acceptance criteria, analyze the ongoing precision and recovery standard (Section 9.7). If the OPR is within its respective limit for the metal(s) that failed (Table 2), the analytical system is in control and the problem can be attributed to the sample matrix.
- 9.3.3.2 For samples that exhibit matrix problems, further isolate the metal(s) from the sample matrix using dilution, chelation, extraction, concentration, hydride generation, or other means, and repeat the accuracy test (Section 9.3.2).
- 9.3.3.3 If the recovery for the metal remains outside the acceptance criteria, the analytical result for that metal in the unspiked sample is suspect and may not be reported for regulatory compliance purposes.
- 9.3.4 Recovery for samples should be assessed and records maintained.
- 9.3.4.1 After the analysis of five samples of a given matrix type (river water, lake water, etc.) for which the metal(s) pass the tests in Section 9.3.3, compute the average percent recovery (R) and the standard deviation of the percent recovery (SR) for the metal(s). Express the accuracy assessment as a percent recovery interval from $R - 2SR$ to $R + 2SR$ for each matrix. For example, if $R = 90\%$ and $SR = 10\%$ for five analyses of river water, the accuracy interval is expressed as 70–110%.
- 9.3.4.2 Update the accuracy assessment for each metal in each matrix on a regular basis (e.g., after each five to ten new measurements).

9.4 Precision of matrix spike and duplicate

- 9.4.1 Calculate the relative percent difference (RPD) between the MS and MSD per the equation below using the concentrations found in the MS and MSD. Do not use the recoveries calculated in Section 9.3.2.4 for this calculation because the RPD is inflated when the background concentration is near the spike concentration.

$$RPD = 100 \frac{(|D1 - D2|)}{(D1 + D2)/2}$$

Where:

D1 = concentration of the analyte in the MS sample

D2 = concentration of the analyte in the MSD sample

- 9.4.2 The relative percent difference between the matrix spike and the matrix spike duplicate must be less than 20%. If this criterion is not met, the analytical system is judged to be out of control. In this case, correct the problem and reanalyze all samples in the sample batch associated with the MS/MSD that failed the RPD test.

- 9.5 Internal standards responses—The analyst is expected to monitor the responses from the internal standards throughout the sample batch being analyzed. Ratios of the internal standards responses against each other should also be monitored routinely. This information may be used to detect potential problems caused by mass dependent drift, errors incurred in adding the internal standards, or increases in the concentrations of individual internal standards caused by background contributions from the sample. The absolute response of any one internal standard must not deviate more than 60–125% of the original response in the calibration blank. If deviations greater than these are observed, flush the instrument with the rinse blank and monitor the responses in the calibration blank. If the responses of the internal standards are now within the limit, take a fresh aliquot of the sample, dilute by a further factor of 2, add the internal standards, and reanalyze. If, after flushing, the response of the internal standards in the calibration blank are out of limits, terminate the analysis and determine the cause of the drift. Possible causes of drift may be a partially blocked sampling cone or a change in the tuning condition of the instrument.
- 9.6 Blanks—Blanks are analyzed to demonstrate freedom from contamination.
- 9.6.1 Laboratory (method) blank
- 9.6.1.1 Prepare a method blank with each sample batch (samples of the same matrix started through the sample preparation process (Section 12) on the same 12-hour shift, to a maximum of 10 samples). Analyze the blank immediately after the OPR is analyzed (Section 9.7) to demonstrate freedom from contamination.
- 9.6.1.2 If the metal of interest or any potentially interfering substance is found in the blank at a concentration equal to or greater than the MDL (Table 1), sample analysis must be halted, the source of the contamination determined, the samples and a new method blank prepared, and the sample batch and fresh method blank reanalyzed.
- 9.6.1.3 Alternatively, if a sufficient number of blanks (3 minimum) are analyzed to characterize the nature of a blank, the average concentration plus two standard deviations must be less than the regulatory compliance level.
- 9.6.1.4 If the result for a single blank remains above the MDL or if the result for the average concentration plus two standard deviations of three or more blanks exceeds the regulatory compliance level, results for samples associated with those blanks may not be reported for regulatory compliance purposes. Stated another way, results for all initial precision and recovery tests (Section 9.2) and all samples must be associated with an uncontaminated method blank before these results may be reported for regulatory compliance purposes.
- 9.6.2 Field blank
- 9.6.2.1 Analyze the field blank(s) shipped with each set of samples (samples collected from the same site at the same time, to a maximum of 10 samples). Analyze the blank immediately before analyzing the samples in the batch.

- 9.6.2.2 If the metal of interest or any potentially interfering substance is found in the field blank at a concentration equal to or greater than the ML (Table 1) or greater than one-fifth the level in the associated sample, whichever is greater, results for associated samples may be the result of contamination and may not be reported for regulatory compliance purposes.
- 9.6.2.3 Alternatively, if a sufficient number of field blanks (3 minimum) are analyzed to characterize the nature of the field blank, the average concentration plus two standard deviations must be less than the regulatory compliance level or less than one-half the level in the associated sample, whichever is greater.
- 9.6.2.4 If contamination of the field blanks and associated samples is known or suspected, the laboratory should communicate this to the sampling team so that the source of contamination can be identified and corrective measures taken prior to the next sampling event.
- 9.6.3 **Equipment Blanks**—Before any sampling equipment is used at a given site, the laboratory or cleaning facility is required to generate equipment blanks to demonstrate that the sampling equipment is free from contamination. Two types of equipment blanks are required: bottle blanks and sampler check blanks.
- 9.6.3.1 **Bottle blanks**—After undergoing appropriate cleaning procedures (Section 11.4), bottles should be subjected to conditions of use to verify the effectiveness of the cleaning procedures. A representative set of sample bottles should be filled with reagent water acidified to pH<2 and allowed to stand for a minimum of 24 h. Ideally, the time that the bottles are allowed to stand should be as close as possible to the actual time that sample will be in contact with the bottle. After standing, the water should be analyzed for any signs of contamination. If any bottle shows signs of contamination, the problem must be identified, the cleaning procedures corrected or cleaning solutions changed, and all affected bottles recleaned.
- 9.6.3.2 **Sampler check blanks**—Sampler check blanks are generated in the laboratory or at the equipment cleaning contractor's facility by processing reagent water through the sampling devices using the same procedures that are used in the field (see Sampling Method). Therefore, the "clean hands/dirty hands" technique used during field sampling should be followed when preparing sampler check blanks at the laboratory or cleaning facility.
- 9.6.3.2.1 Sampler check blanks are generated by filling a large carboy or other container with reagent water (Section 7.2) and processing the reagent water through the equipment using the same procedures that are used in the field (see Sampling Method). For example, manual grab sampler check blanks are collected by directly submerging a sample bottle into the water, filling the bottle, and capping. Subsurface sampler check blanks are collected by immersing the sampler into the water and pumping water into a sample container.

- 9.6.3.2.2 The sampler check blank must be analyzed using the procedures given in this method. If any metal of interest or any potentially interfering substance is detected in the blank, the source of contamination or interference must be identified and the problem corrected. The equipment must be demonstrated to be free from the metal(s) of interest before the equipment may be used in the field.
- 9.6.3.2.3 Sampler check blanks must be run on all equipment that will be used in the field. If, for example, samples are to be collected using both a grab sampling device and a subsurface sampling device, a sampler check blank must be run on both pieces of equipment.

9.7 Ongoing precision and recovery

- 9.7.1 Prepare an ongoing precision and recovery sample (laboratory fortified method blank) identical to the initial precision and recovery aliquots (Section 9.2) with each sample batch (samples of the same matrix started through the sample preparation process (Section 12) on the same 12-hour shift, to a maximum of 10 samples) by spiking an aliquot of reagent water with the metal(s) of interest.
- 9.7.2 Analyze the OPR sample before the method blank and samples from the same batch are analyzed.
- 9.7.3 Compute the percent recovery of each metal in the OPR sample.
- 9.7.4 For each metal, compare the concentration to the limits for ongoing recovery in Table 2. If all metals meet the acceptance criteria, system performance is acceptable and analysis of blanks and samples may proceed. If, however, any individual recovery falls outside of the range given, the analytical processes are not being performed properly for that metal. Correct the problem, reprepare the sample batch, and repeat the ongoing precision and recovery test (Section 9.7).
- 9.7.5 Add results that pass the specifications in Section 9.7.4 to initial and previous ongoing data for each metal in each matrix. Update QC charts to form a graphic representation of continued laboratory performance. Develop a statement of laboratory accuracy for each metal in each matrix type by calculating the average percent recovery (R) and the standard deviation of percent recovery (SR). Express the accuracy as a recovery interval from $R - 2SR$ to $R + 2SR$. For example, if $R = 95\%$ and $SR = 5\%$, the accuracy is 85–105%.
- 9.8 The specifications contained in this method can be met if the instrument used is calibrated properly and then maintained in a calibrated state. A given instrument will provide the most reproducible results if dedicated to the settings and conditions required for the analyses of metals by this method.
- 9.9 Depending on specific program requirements, the laboratory may be required to analyze field duplicates collected to determine the precision of the sampling technique. The relative percent

difference (RPD) between field duplicates should be less than 20%. If the RPD of the field duplicates exceeds 20%, the laboratory should communicate this to the sampling team so that the source of error can be identified and corrective measures taken before the next sampling event.

10.0 Calibration and Standardization

10.1 Operating conditions—Because of the diversity of instrument hardware, no detailed instrument operating conditions are provided. The analyst is advised to follow the recommended operating conditions provided by the manufacturer. The analyst is responsible for verifying that the instrument configuration and operating conditions satisfy the quality control requirements in this method. Table 5 lists instrument operating conditions that may be used as a guide for analysts in determining instrument configuration and operating conditions.

10.2 Precalibration routine—The following precalibration routine should be completed before calibrating the instrument until it can be documented with periodic performance data that the instrument meets the criteria listed below without daily tuning.

10.2.1 Initiate proper operating configuration of instrument and data system. Allow a period of not less than 30 min for the instrument to warm up. During this period, conduct mass calibration and resolution checks using the tuning solution. Resolution at low mass is indicated by nickel isotopes 60, 61, 62. Resolution at high mass is indicated by lead isotopes 206, 207, 208. For good performance, adjust the spectrometer resolution to produce a peak width of approximately 0.75 amu at 5% peak height. Adjust mass calibration if it has shifted by more than 0.1 amu from unit mass.

10.2.2 Instrument stability must be demonstrated by running the tuning solution (Section 7.7) a minimum of five times with resulting relative standard deviations of absolute signals for all analytes of less than 10%.

10.3 Internal standardization—Internal standardization must be used in all analyses to correct for instrument drift and physical interferences. For full mass range scans, a minimum of three internal standards must be used. Internal standards must be present in all samples, standards, and blanks at identical levels. This may be achieved by directly adding an aliquot of the internal standards to the CAL standard, blank, or sample solution (Method A), or alternatively by mixing with the solution before nebulization using a second channel of the peristaltic pump and a mixing coil (Method B). The concentration of the internal standard should be sufficiently high that good precision is obtained in the measurement of the isotope used for data correction and to minimize the possibility of correction errors if the internal standard is naturally present in the sample. Internal standards should be added to blanks, samples, and standards in a like way so that dilution effects resulting from the addition may be disregarded.

NOTE: *Bismuth should not be used as an internal standard using the direct addition method (Method A, Section 10.3) because it is not efficiently concentrated on the iminodiacetate column.*

10.4 Calibration—Before initial calibration, set up proper instrument software routines for quantitative analysis and connect the ICP-MS instrument to the preconcentration apparatus.

The instrument must be calibrated at a minimum of three points for each analyte to be determined.

10.4.1 Inject the calibration blank (Section 7.6.1) and calibration standards A and B (Section 7.4.1) prepared at three or more concentrations, one of which must be at the ML (Table 1), and another that must be near the upper end of the linear dynamic range. The calibration solutions should be processed through the preconcentration system using the procedures described in Section 12. A minimum of three replicate integrations are required for data acquisition. Use the average of the integrations for instrument calibration and data reporting.

10.4.2 Compute the response factor at each concentration, as follows:

$$RF = \frac{A_s \times C_{is}}{A_{is} \times C_s}$$

Where:

C_s = concentration of the analyte in the standard or blank solution

C_{is} = concentration of the internal standard in the solution

A_s = height or area of the response at the m/z for the analyte

A_{is} = height or area of the m/z for the internal standard

10.4.3 Using the individual response factors at each concentration, compute the mean RF for each analyte.

10.4.4 Linearity—If the RF over the calibration range is constant (< 20% RSD), the RF can be assumed to be invariant and the mean RF can be used for calculations.

Alternatively, the results can be used to plot a calibration curve of response ratios, A_s/A_{is} , vs. RF.

10.5 Calibration verification—Immediately following calibration, an initial calibration verification should be performed. Adjustment of the instrument is performed until verification criteria are met. Only after these criteria are met may blanks and samples be analyzed.

10.5.1 Analyze the mid-point calibration standard (Section 10.4).

10.5.2 Compute the percent recovery of each metal using the mean RF or calibration curve obtained in the initial calibration.

10.5.3 For each metal, compare the recovery with the corresponding limit for calibration verification in Table 2. If all metals meet the acceptance criteria, system performance is acceptable and analysis of blanks and samples may continue using the response from the initial calibration. If any individual value falls outside the range given, system performance is unacceptable for that compound. In this event, locate and correct the problem and/or prepare a new calibration check standard and repeat the test (Sections 10.5.1–10.5.3), or recalibrate the system according to Section 10.4.

- 10.5.4 Calibration must be verified following every ten samples by analyzing the mid-point calibration standard. If the recovery does not meet the acceptance criteria specified in Table 2, analysis must be halted, the problem corrected, and the instrument recalibrated. All samples after the last acceptable calibration verification must be reanalyzed.
- 10.6 A calibration blank must be analyzed following every calibration verification to demonstrate that there is no carryover of the analytes of interest and that the analytical system is free from contamination. If the concentration of an analyte in the blank result exceeds the MDL, correct the problem, verify the calibration (Section 10.5), and repeat the analysis of the calibration blank.

11.0 Procedures for Cleaning the Apparatus

- 11.1 All sampling equipment, sample containers, and labware should be cleaned in a designated cleaning area that has been demonstrated to be free of trace element contaminants. Such areas may include class 100 clean rooms as described by Moody (Reference 24), labware cleaning areas as described by Patterson and Settle (Reference 6), or clean benches.
- 11.2 Materials, such as gloves (Section 6.10.7), storage bags (Section 6.10.10), and plastic wrap (Section 6.10.11), may be used new without additional cleaning unless the results of the equipment blank pinpoint any of these materials as a source of contamination. In this case, either an alternate supplier must be obtained or the materials must be cleaned.
- 11.3 Cleaning procedures—Proper cleaning of the Apparatus is extremely important, because the Apparatus may not only contaminate the samples but may also remove the analytes of interest by adsorption onto the container surface.

NOTE: *If laboratory, field, and equipment blanks (Section 9.6) from the Apparatus cleaned with fewer cleaning steps than those detailed below show no levels of analytes above the MDL, those cleaning steps that do not eliminate these artifacts may be omitted if all performance criteria outlined in Section 9 are met.*

11.3.1 Bottles, labware, and sampling equipment

- 11.3.1.1 Fill a precleaned basin (Section 6.10.8) with a sufficient quantity of a 0.5% solution of liquid detergent (Section 6.8), and completely immerse each piece of ware. Allow to soak in the detergent for at least 30 min.
- 11.3.1.2 Using a pair of clean gloves (Section 6.10.7) and clean nonmetallic brushes (Section 6.10.9), thoroughly scrub down all materials with the detergent.
- 11.3.1.3 Place the scrubbed materials in a precleaned basin. Change gloves.

- 11.3.1.4 Thoroughly rinse the inside and outside of each piece with reagent water until there is no sign of detergent residue (e.g., until all soap bubbles disappear).
 - 11.3.1.5 Change gloves, immerse the rinsed equipment in a hot (50–60°C) bath of concentrated reagent grade HNO₃ (Section 7.1.1) and allow to soak for at least 2 h.
 - 11.3.1.6 After soaking, use clean gloves and tongs to remove the Apparatus and thoroughly rinse with distilled, deionized water (Section 7.2).
 - 11.3.1.7 Change gloves and immerse the Apparatus in a hot (50–60°C) bath of 1N trace metal grade HCl (Section 7.1.9), and allow to soak for at least 48 h.
 - 11.3.1.8 Thoroughly rinse all equipment and bottles with reagent water. Proceed with Section 11.3.2 for labware and sampling equipment. Proceed with Section 11.3.3 for sample bottles.
- 11.3.2 Labware and sampling equipment
- 11.3.2.1 After cleaning, air-dry in a class 100 clean air bench.
 - 11.3.2.2 After drying, wrap each piece of ware or equipment in two layers of polyethylene film.
- 11.3.3 Fluoropolymer sample bottles—These bottles should be used if mercury is a target analyte.
- 11.3.3.1 After cleaning, fill sample bottles with 0.1% (v/v) ultrapure HCl (Section 7.1.13) and cap tightly. It may be necessary to use a strap wrench to assure a tight seal.
 - 11.3.3.2 After capping, double-bag each bottle in polyethylene zip-type bags. Store at room temperature until sample collection.
- 11.3.4 Bottles, labware, and sampling equipment (polyethylene or material other than fluoropolymer)
- 11.3.4.1 Apply the steps outlined in Sections 11.3.1.1–11.3.1.8 to all bottles, labware, and sampling equipment. Proceed with Section 11.3.4.2 for bottles or Section 11.3.4.3 for labware and sampling equipment.
 - 11.3.4.2 After cleaning, fill each bottle with 0.1% (v/v) ultrapure HCl (Section 7.1.13). Double-bag each bottle in a polyethylene bag to prevent contamination of the surfaces with dust and dirt. Store at room temperature until sample collection.

- 11.3.4.3 After rinsing labware and sampling equipment, air-dry in a class 100 clean air bench. After drying, wrap each piece of ware or equipment in two layers of polyethylene film.

NOTE: Polyethylene bottles cannot be used to collect samples that will be analyzed for mercury at trace (e.g., 0.012 µg/L) levels because of the potential for vapors to diffuse through the polyethylene.

- 11.3.4.4 Polyethylene bags—If polyethylene bags need to be cleaned, clean according to the following procedure:

11.3.4.4.1 Partially fill with cold, (1+1) HNO₃ (Section 7.1.2) and rinse with distilled deionized water (Section 7.2).

11.3.4.4.2 Dry by hanging upside down from a plastic line with a plastic clip.

11.3.5 Silicone tubing, fluoropolymer tubing, and other sampling apparatus—Clean any silicone, fluoropolymer, or other tubing used to collect samples by rinsing with 10% HCl (Section 7.1.10) and flushing with water from the site before sample collection.

11.3.6 Extension pole—Because of its length, it is impractical to submerge the 2-m polyethylene extension pole (used in with the optional grab sampling device) in acid solutions as described above. If such an extension pole is used, a nonmetallic brush (Section 6.10.9) should be used to scrub the pole with reagent water and the pole wiped down with acids described in Section 11.3.4. After cleaning, the pole should be wrapped in polyethylene film.

11.4 Storage—Store each piece or assembly of the Apparatus in a clean, single polyethylene zip-type bag. If shipment is required, place the bagged apparatus in a second polyethylene zip-type bag.

11.5 All cleaning solutions and acid baths should be periodically monitored for accumulation of metals that could lead to contamination. When levels of metals in the solutions become too high, the solutions and baths should be changed and the old solutions neutralized and discarded in compliance with state and federal regulations.

12.0 Procedures for Sample Preparation and Analysis

12.1 Aqueous sample preparation—dissolved analytes

12.1.1 For determination of dissolved analytes in ground and surface waters, pipet an aliquot (≥ 20 mL) of the filtered, acid-preserved sample into a clean 50-mL polypropylene centrifuge tube. Add an appropriate volume of (1+1) nitric acid to adjust the acid concentration of the aliquot to approximate a 1% (v/v) nitric acid solution (e.g., add 0.4 mL (1+1) HNO₃ to a 20-mL aliquot of sample). Add the internal standards, cap the tube, and mix. The sample is now ready for analysis. Allowance for sample dilution should be made in the calculations.

12.2 Aqueous sample preparation—total recoverable analytes

NOTE: To preclude contamination during sample digestion, it may be necessary to perform the open-beaker, total-recoverable digestion procedure described in Sections 12.2.1–12.2.6 in a fume hood that is located in a clean room. An alternate digestion procedure is provided in Section 12.2.7; however, this procedure has not undergone interlaboratory testing.

12.2.1 For the determination of total recoverable analytes in ambient water samples, transfer a 100-mL (± 1 mL) aliquot from a well-mixed, acid-preserved sample to a 250-mL Griffin beaker (Section 6.10.3). If appropriate, a smaller sample volume may be used.

12.2.2 Add 2 mL (1+1) nitric acid to the beaker and place the beaker on the hot plate for digestion. The hot plate should be located in a fume hood and previously adjusted to provide evaporation at a temperature of approximately but no higher than 85°C. (See the following note.) The beaker should be covered or other necessary steps should be taken to prevent sample contamination from the fume hood environment.

NOTE: For proper heating, adjust the temperature control of the hot plate so that an uncovered Griffin beaker containing 50 mL of water placed in the center of the hot plate can be maintained at a temperature approximately but no higher than 85°C. (Once the beaker is covered with a watch glass, the temperature of the water will rise to approximately 95°C.)

12.2.3 Reduce the volume of the sample aliquot to about 20 mL by gentle heating at 85°C. Do not boil. This step takes about 2 h for a 100-mL aliquot with the rate of evaporation rapidly increasing as the sample volume approaches 20 mL. (A spare beaker containing 20 mL of water can be used as a gauge.)

12.2.4 Cover the lip of the beaker with a watch glass to reduce additional evaporation and gently reflux the sample for 30 min. (Slight boiling may occur, but vigorous boiling must be avoided.)

12.2.5 Allow the beaker to cool. Quantitatively transfer the sample solution to a 100-mL volumetric flask, make to volume with reagent water, stopper, and mix.

12.2.6 Allow any undissolved material to settle overnight, or centrifuge a portion of the prepared sample until clear. (If, after centrifuging or standing overnight, the sample contains suspended solids that would clog the nebulizer, a portion of the sample may be filtered to remove the solids before analysis. However, care should be exercised to avoid potential contamination from filtration.) The sample is now ready for analysis. Because the effects of various matrices on the stability of diluted samples cannot be characterized, all analyses should be performed as soon as possible after the completed preparation.

12.2.7 Alternate total recoverable digestion procedure

- 12.2.7.1 Open the preserved sample under clean conditions. Add ultrapure nitric acid at the rate of 10 mL/L. Remove the cap from the original container only long enough to add the aliquot of acid. The sample container should not be filled to the lip by the addition of the acid. However, only minimal headspace is needed to avoid leakage during heating.
- 12.2.7.2 Tightly recap the container and shake thoroughly. Place the container in an oven preheated to 85°C. The container should be placed on an insulating piece of material such as wood rather than directly on the typical metal grating. After the samples have reached 85°C, heat for 2 h. (Total time will be 2.5–3 h depending on the sample size). Temperature can be monitored using an identical sample container with distilled water and a thermocouple to standardize heating time.
- 12.2.7.3 Allow the sample to cool. Add the internal standards and mix. The sample is now ready for analysis. Remove aliquots for analysis under clean conditions.
- 12.3 Before first use, the preconcentration system should be thoroughly cleaned and decontaminated using 0.2M oxalic acid.
- 12.3.1 Place approximately 500 mL 0.2M oxalic acid in all the eluent/solution containers and fill the sample loop with 0.2M oxalic acid using the sample pump (P4) at a flow rate of 3–5 mL/min. With the preconcentration system disconnected from the ICP-MS instrument, use the pump program sequence listed in Table 3, to flush the complete system with oxalic acid. Repeat the flush sequence three times.
- 12.3.2 Repeat the sequence described in Section 12.3.1 using 1.25M nitric acid and again using reagent water in place of the 0.2M oxalic acid.
- 12.3.3 Rinse the containers thoroughly with reagent water, fill them with their designated reagents (see Figure 1), and run through the sequence in Table 3 once to prime the pump and all eluent lines with the correct reagents.
- 12.4 Sample Analysis
- 12.4.1 Initiate ICP-MS instrument operating configuration. Tune the instrument for the analytes of interest (Section 10).
- 12.4.2 Establish instrument software run procedures for quantitative analysis. Because the analytes are eluted from the preconcentration column in a transient manner, it is recommended that the instrument software be configured in a rapid scan/peak hopping mode. The instrument is now ready to be calibrated.
- 12.4.3 Reconnect the preconcentration system to the ICP-MS instrument. With valves A and B in the off position and valve C in the on position, load the sample through the sample loop to waste using pump P4 for 4 min at 4 mL/min. Switch on the carrier

pump (P3) and pump 1% nitric acid to the nebulizer of the ICP-MS instrument at a flow rate of 0.8–1.0 mL/min.

- 12.4.4 Switch on the buffer pump (P2), and pump 2M ammonium acetate at a flow rate of 1.0 mL/min.
- 12.4.5 Preconcentration of the sample may be achieved by running through an eluent pump program (P1) sequence similar to that illustrated in Table 3. The exact timing of this sequence should be modified according to the internal volume of the connecting tubing and the specific hardware configuration used.
 - 12.4.5.1 Inject sample—With valves A, B and C on, load sample from the loop onto the column using 1M ammonium acetate for 4.5 min at 4.0 mL/min. The analytes are retained on the column, while most of the matrix is passed through to waste.
 - 12.4.5.2 Elute analytes—Turn off valves A and B and begin eluting the analytes by pumping 1.25M nitric acid through the column at 4.0 mL/min, then turn off valve C and pump the eluted analytes into the ICP-MS instrument at 1.0 mL/min. Initiate ICP-MS software data acquisition and integrate the eluted analyte profiles.
 - 12.4.5.3 Column Reconditioning—Turn on valve C to direct column effluent to waste, and pump 1.25M nitric acid, 1M ammonium acetate, 1.25M nitric acid and 1M ammonium acetate alternately through the column at 4.0 mL/min. During this process, the next sample can be loaded into the sample loop using the sample pump (P4).
- 12.4.6 Repeat the sequence described in Section 12.4.5 for each sample to be analyzed. At the end of the analytical run, leave the column filled with 1M ammonium acetate buffer until it is next used.
- 12.4.7 Samples having concentrations higher than the established linear dynamic range should be diluted into range with 1% HNO₃ (v/v) and reanalyzed.

13.0 Data Analysis and Calculations

- 13.1 Elemental equations recommended for sample data calculations are listed in Table 4. Sample data should be reported in units of µg/L (parts-per-billion; ppb). Report results at or above the ML for metals found in samples and determined in standards. Report all results for metals found in blanks, regardless of level.
- 13.2 For data values less than the ML, two significant figures should be used for reporting element concentrations. For data values greater than or equal to the ML, three significant figures should be used.
- 13.3 Compute the concentration of each analyte in the sample using the response factor determined from calibration data (Section 10.4) and the following equation:

$$C_s \text{ (mg/L)} = \frac{A_s \times C_{is}}{A_{is} \times RF}$$

Where the terms are as defined in Section 10.4.2.

- 13.4 Corrections for characterized spectral interferences should be applied to the data. Chloride interference corrections should be made on all samples, regardless of the addition of hydrochloric acid, because the chloride ion is a common constituent of environmental samples.
- 13.5 If an element has more than one monitored m/z, examination of the concentration calculated for each m/z, or the relative abundances, will provide useful information for the analyst in detecting a possible spectral interference. Consideration should therefore be given to both primary and secondary m/z's in the evaluation of the element concentration. In some cases, the secondary m/z may be less sensitive or more prone to interferences than the primary recommended m/z; therefore, differences between the results do not necessarily indicate a problem with data calculated for the primary m/z.
- 13.6 The QC data obtained during the analyses provide an indication of the quality of the sample data and should be provided with the sample results.
- 13.7 Do not perform blank subtraction on the sample results. Report results for samples and accompanying blanks.

14.0 Method Performance

- 14.1 The method detection limits (MDLs) listed in Table 1 and the quality control acceptance criteria listed in Table 2 were validated in two laboratories (Reference 25) for dissolved analytes.

15.0 Pollution Prevention

- 15.1 Pollution prevention encompasses any technique that reduces or eliminates the quantity or toxicity of waste at the point of generation. Many opportunities for pollution prevention exist in laboratory operation. The EPA has established a preferred hierarchy of environmental management techniques that places pollution prevention as the management option of first choice. Whenever feasible, laboratory personnel should use pollution prevention techniques to address their waste generation. When wastes cannot be feasibly reduced at the source, the Agency recommends recycling as the next best option. The acids used in this method should be reused as practicable by purifying by electrochemical techniques. The only other chemicals used in this method are the neat materials used in preparing standards. These standards are used in extremely small amounts and pose little threat to the environment when managed properly. Standards should be prepared in volumes consistent with laboratory use to minimize the volume of expired standards to be disposed.

- 15.2 For information about pollution prevention that may be applicable to laboratories and research institutions, consult *Less is Better: Laboratory Chemical Management for Waste Reduction*, available from the American Chemical Society's Department of Government Relations and Science Policy, 1155 16th Street NW, Washington DC 20036, 202/872-4477.

16.0 Waste Management

- 16.1 The Environmental Protection Agency requires that laboratory waste management practices be conducted consistent with all applicable rules and regulations. The Agency urges laboratories to protect the air, water, and land by minimizing and controlling all releases from hoods and bench operations, complying with the letter and spirit of any sewer discharge permits and regulations, and by complying with all solid and hazardous waste regulations, particularly the hazardous waste identification rules and land disposal restrictions. For further information on waste management consult *The Waste Management Manual for Laboratory Personnel*, available from the American Chemical Society at the address listed in the Section 15.2.

17.0 References

- 1 Adeloju, S.B.; Bond, A.M. "Influence of Laboratory Environment on the Precision and Accuracy of Trace Element Analysis," *Anal. Chem.* **1985**, *57*, 1728.
- 2 Berman, S.S.; Yeats, P.A. "Sampling of Seawater for Trace Metals," *CRC Reviews in Analytical Chemistry* **1985**, *16*, 1.
- 3 Bloom, N.S. "Ultra-Clean Sampling, Storage, and Analytical Strategies for the Accurate Determination of Trace Metals in Natural Waters"; Presented at the 16th Annual EPA Conference on the Analysis of Pollutants in the Environment, Norfolk, VA, May 5, 1993.
- 4 Bruland, K.W. "Trace Elements in Seawater," *Chemical Oceanography* **1983**, *8*, 157.
- 5 Nriagu, J.O.; Larson, G.; Wong, H.K.T.; Azcue, J.M. "A Protocol for Minimizing Contamination in the Analysis of Trace Metals in Great Lakes Waters," *J. Great Lakes Research* **1993**, *19*, 175.
- 6 Patterson, C.C.; Settle, D.M. "Accuracy in Trace Analysis"; In *National Bureau of Standards Special Publication 422*; LaFleur, P.D., Ed., U.S. Government Printing Office, Washington, DC, 1976.
- 7 Fitzgerald, W.F.; Watras, C.J. *Science of the Total Environment* **1989**, *87/88*, 223.
- 8 Gill, G.A.; Fitzgerald, W.F. *Deep Sea Res.* **1985**, *32*, 287.
- 9 Prothro, Martha G., "Office of Water Policy and Technical Guidance on Interpretation and Implementation of Aquatic Life Metals Criteria," EPA Memorandum to Regional Water Management and Environmental Services Division Directors, Oct. 1, 1993.

- 10 "Format for Method Documentation", Distributed by the EPA Environmental Monitoring Management Council, Washington, DC, Nov. 18, 1993.
- 11 Siraraks, A.; Kingston, H.M.; Riviello, J.M. *Anal Chem.* **1990**, *62*, 1185.
- 12 Heithmar, E.M., Hinnars, T.A.; Rowan, J.T.; Riviello, J.M. *Anal Chem.* **1990**, *62*, 857.
- 13 Gray, A.L.; Date, A.R. *Analyst*, **1983**, *108*, 1033.
- 14 Houk, R.S. et al. *Anal Chem.* **1980**, *52*, 2283.
- 15 Houk, R.S. *Anal. Chem.* **1986**, *58*, 97A.
- 16 Windom, H.L; Byrd, J.T.; Smith, R.G., Jr.; Huan, F. "Inadequacy of NASQAN Data for Assessing Metal Trends in the Nation's Rivers," *Environ. Sci. Technol.* **1991**, *25*, 1137.
- 17 Zief, M.; Mitchell, J.W. "Contamination Control in Trace Metals Analysis"; In *Chemical Analysis 1976*, Vol. 47, Chapter 6.
- 18 Thompson, J.J.; Houk, R.S. *Appl. Spec.* **1987**, *41*, 801.
- 19 *Carcinogens - Working With Carcinogens*; Department of Health, Education, and Welfare, Public Health Service. Centers for Disease Control. National Institute for Occupational Safety and Health Publication No. 77-206, Aug. 1977. Available from the National Technical Information Service (NTIS) as PB-277256.
- 20 "OSHA Safety and Health Standards, General Industry," 29 *CFR* 1910, Occupational Safety and Health Administration, OSHA 2206 (revised January 1976).
- 21 *Safety in Academic Chemistry Laboratories*, American Chemical Society Publication, Committee on Chemical Safety, 3rd Edition, 1979.
- 22 "Proposed OSHA Safety and Health Standards, Laboratories, Occupational Safety and Health Administration," *Fed. Regist.*, July 24, 1986.
- 23 *Handbook of Analytical Quality Control in Water and Wastewater Laboratories*; U.S. Environmental Protection Agency. EMSL-Cincinnati, OH, March 1979; EPA-600/4-79-019.
- 24 Moody, J.R. "NBS Clean Laboratories for Trace Element Analysis," *Anal. Chem.* **1982**, *54*, 1358A.
- 25 "Results of the Validation Study for Determination of Trace Metals at EPA Water Quality Criteria Levels," April 1995. Available from the Sample Control Center (operated by DynCorp), 300 N. Lee Street, Alexandria, VA 22314, 703/519-1140.

18.0 Glossary

Many of the terms and definitions listed below are used in the EPA 1600-series methods, but terms have been cross-referenced to terms commonly used in other methods where possible.

- 18.1 **Ambient Water**—Waters in the natural environment (e.g., rivers, lakes, streams, and other receiving waters), as opposed to effluent discharges.
- 18.2 **Analyte**—A metal tested for by the methods referenced in this method. The analytes are listed in Table 1.
- 18.3 **Apparatus**—The sample container and other containers, filters, filter holders, labware, tubing, pipets, and other materials and devices used for sample collection or sample preparation, and that will contact samples, blanks, or analytical standards.
- 18.4 **Calibration Blank**—A volume of reagent water acidified with the same acid matrix as in the calibration standards. The calibration blank is a zero standard and is used to calibrate the ICP instrument (Section 7.6.1).
- 18.5 **Calibration Standard (CAL)**—A solution prepared from a dilute mixed standard and/or stock solutions and used to calibrate the response of the instrument with respect to analyte concentration.
- 18.6 **Dissolved Analyte**—The concentration of analyte in an aqueous sample that will pass through a 0.45- μ m membrane filter assembly prior to sample acidification (Section 8.3).
- 18.7 **Equipment Blank**—An aliquot of reagent water that is subjected in the laboratory to all aspects of sample collection and analysis, including contact with all sampling devices and apparatus. The purpose of the equipment blank is to determine if the sampling devices and apparatus for sample collection have been adequately cleaned before they are shipped to the field site. An acceptable equipment blank must be achieved before the sampling devices and apparatus are used for sample collection. In addition, equipment blanks should be run on random, representative sets of gloves, storage bags, and plastic wrap for each lot to determine if these materials are free from contamination before they are used.
- 18.8 **Field Blank**—An aliquot of reagent water that is placed in a sample container in the laboratory, shipped to the field, and treated as a sample in all respects, including contact with the sampling devices and exposure to sampling site conditions, storage, preservation, and all analytical procedures, which may include filtration. The purpose of the field blank is to determine if the field or sample transporting procedures and environments have contaminated the sample.
- 18.9 **Field Duplicates (FD1 and FD2)**—Two separate samples collected in separate sample bottles at the same time and place under identical circumstances and treated exactly the same throughout field and laboratory procedures. Analyses of FD1 and FD2 give a measure of the precision associated with sample collection, preservation, and storage, as well as with laboratory procedures.

- 18.10 **Initial Precision and Recovery (IPR)**—Four aliquots of the OPR standard analyzed to establish the ability to generate acceptable precision and accuracy. IPRs are performed before the first time a method is used and any time the method or instrumentation is modified.
- 18.11 **Instrument Detection Limit (IDL)**—The concentration equivalent to the analyte signal which is equal to three times the standard deviation of a series of ten replicate measurements of the calibration blank signal at the selected analytical mass(es).
- 18.12 **Internal Standard**—Pure analyte(s) added to a sample, extract, or standard solution in known amount(s) and used to measure the relative responses of other method analytes that are components of the same sample or solution. The internal standard must be an analyte that is not a sample component (Sections 7.5 and 9.5).
- 18.13 **Laboratory Blank**—An aliquot of reagent water that is treated exactly as a sample including exposure to all glassware, equipment, solvents, reagents, internal standards, and surrogates that are used with samples. The laboratory blank is used to determine if method analytes or interferences are present in the laboratory environment, the reagents, or the apparatus (Sections 7.6.2 and 9.6.1).
- 18.14 **Laboratory Control Sample (LCS)**—See Ongoing Precision and Recovery (OPR) Standard.
- 18.15 **Laboratory Duplicates (LD1 and LD2)**—Two aliquots of the same sample taken in the laboratory and analyzed separately with identical procedures. Analyses of LD1 and LD2 indicates precision associated with laboratory procedures, but not with sample collection, preservation, or storage procedures.
- 18.16 **Laboratory Fortified Blank (LFB)**—See Ongoing Precision and Recovery (OPR) Standard.
- 18.17 **Laboratory Fortified Sample Matrix (LFM)**—See Matrix Spike (MS) and Matrix Spike Duplicate (MSD).
- 18.18 **Laboratory Reagent Blank (LRB)**—See Laboratory Blank.
- 18.19 **Linear Dynamic Range (LDR)**—The concentration range over which the instrument response to an analyte is linear (Section 9.2.3).
- 18.20 **Matrix Spike (MS) and Matrix Spike Duplicate (MSD)**—Aliquots of an environmental sample to which known quantities of the method analytes are added in the laboratory. The MS and MSD are analyzed exactly like a sample. Their purpose is to quantify the bias and precision caused by the sample matrix. The background concentrations of the analytes in the sample matrix must be determined in a separate aliquot and the measured values in the MS and MSD corrected for background concentrations (Section 9.3).
- 18.21 **m/z**—mass-to-charge ratio
- 18.22 **May**—This action, activity, or procedural step is optional.
- 18.23 **May Not**—This action, activity, or procedural step is prohibited.

- 18.24 **Method Blank**—See Laboratory Blank.
- 18.25 **Method Detection Limit (MDL)**—The minimum concentration of an analyte that can be identified, measured, and reported with 99% confidence that the analyte concentration is greater than zero (Section 9.2.1 and Table 1).
- 18.26 **Minimum Level (ML)**—The lowest level at which the entire analytical system gives a recognizable signal and acceptable calibration point (Reference 9).
- 18.27 **Must**—This action, activity, or procedural step is required.
- 18.28 **Ongoing Precision and Recovery (OPR) Standard**—A laboratory blank spiked with known quantities of the method analytes. The OPR is analyzed exactly like a sample. Its purpose is to determine whether the methodology is in control and to assure that the results produced by the laboratory remain within the method-specified limits for precision and accuracy (Sections 7.9 and 9.7).
- 18.29 **Preparation Blank**—See Laboratory Blank.
- 18.30 **Primary Dilution Standard**—A solution containing the analytes that is purchased or prepared from stock solutions and diluted as needed to prepare calibration solutions and other solutions.
- 18.31 **Quality Control Sample (QCS)**—A sample containing all or a subset of the method analytes at known concentrations. The QCS is obtained from a source external to the laboratory or is prepared from a source of standards different from the source of calibration standards. It is used to check laboratory performance with test materials prepared external to the normal preparation process.
- 18.32 **Reagent Water**—Water demonstrated to be free from the method analytes and potentially interfering substances at the MDL for that metal in the method.
- 18.33 **Should**—This action, activity, or procedural step is suggested but not required.
- 18.34 **Stock Standard Solution**—A solution containing one or more method analytes that is prepared using a reference material traceable to EPA, the National Institute of Science and Technology (NIST), or a source that will attest to the purity and authenticity of the reference material.
- 18.35 **Total Recoverable Analyte**—The concentration of analyte determined by analysis of the solution extract of an unfiltered aqueous sample following digestion by refluxing with hot dilute mineral acid(s) as specified in the method (Section 12.2).
- 18.36 **Tuning Solution**—A solution used to determine acceptable instrument performance before calibration and sample analyses (Section 7.7).

Table 1

List of Analytes Amenable to Analysis Using Method 1640: Lowest Water Quality Criterion for Each Metal Species, Method Detection Limits, Minimum Levels, and Recommended Analytical Masses

Metal	Lowest Ambient Water Quality Criterion (µg/L) ¹	Method Detection Limit (MDL) and Minimum Level (ML); µg/L		Recommended Analytical m/z
		MDL ²	ML ³	
Cadmium	0.32	0.0024	0.01	111
Copper	2.5	0.024	0.1	63
Lead	0.14	0.0081	0.02	206, 207, 208
Nickel	7.1	0.029	0.1	60

1. Lowest of the freshwater, marine, and human health WQC promulgated by EPA for 14 states at 40 *CFR* Part 131 (57 *FR* 60848), with hardness-dependent freshwater aquatic life criteria adjusted in accordance with 57 *FR* 60848 to reflect the worst case hardness of 25 mg/L CaCO₃, and all aquatic life criteria adjusted in accordance with the Oct. 1, 1993 Office of Water guidance to reflect dissolved metals criteria.
2. Method Detection Limit as determined by 40 *CFR* Part 136, Appendix B.
3. Minimum Level (ML) calculated by multiplying laboratory-determined MDL by 3.18 and rounding result to nearest multiple of 1, 2, 5, 10, etc. in accordance with procedures used by EAD and described in the EPA Draft National Guidance for the Permitting, Monitoring, and Enforcement of Water Quality-Based Effluent Limitations Set Below Analytical Detection/Quantitation Levels, March 22, 1994.

**TABLE 2: QUALITY CONTROL ACCEPTANCE CRITERIA FOR PERFORMANCE TESTS
IN EPA METHOD 1640¹**

Metal	Initial Precision and Recovery (Section 9.2)		Calibration Verification (Section 10.5)	Ongoing Precision and Recovery (Section 9.7)	Spike Recovery (Section 9.3)
	s	X			
Cadmium	23	75-121	86-110	73-123	73-123
Copper	43	67-154	77-119	63-159	63-159
Lead	44	56-144	78-122	52-144	52-144
Nickel	27	74-128	87-115	71-130	71-130

1. All specifications expressed as percent.

TABLE 3: ELUENT PUMP PROGRAMMING SEQUENCE FOR PRECONCENTRATION OF TRACE ELEMENTS

Time (min)	Flow (mL/min)	Eluent	Valve A,B	Valve C
0.0	4.0	1M ammonium acetate	ON	ON
4.5	4.0	1.25M HNO ₃	ON	ON
5.1	1.0	1.25M HNO ₃	OFF	ON
5.5	1.0	1.25M HNO ₃	OFF	OFF
7.5	4.0	1.25M HNO ₃	OFF	ON
8.0	4.0	1M ammonium acetate	OFF	ON
10.0	4.0	1.25M HNO ₃	OFF	ON
11.0	4.0	1M ammonium acetate	OFF	ON
12.5	0.0		OFF	ON

TABLE 4: RECOMMENDED ANALYTICAL ISOTOPES AND ELEMENTAL EQUATIONS FOR DATA CALCULATIONS

Element	Isotope	Elemental Equation	Note
Cd	106,108, <u>111</u> ,114	$(1.000)(^{111}\text{C}) - (1.073)[(^{108}\text{C}) - (0.712)(^{106}\text{C})]$	(1)
Cu	<u>63</u> ,65	$(1.000)(^{63}\text{C})$	
Pb	<u>206</u> , <u>207</u> , <u>208</u>	$(1.000)(^{206}\text{C}) + (1.000)(^{207}\text{C}) + (1.000)(^{208}\text{C})$	(2)
Ni	60	$(1.000)(^{60}\text{C})$	

C—counts at specified m/Z.

(1)—correction for MoO interference. An additional isobaric elemental correction should be made if palladium is present.

(2)—allowance for variability of lead isotopes.

NOTE: As a minimum, all isotopes listed should be monitored. Isotopes recommended for analytical determination are underlined.

TABLE 5: RECOMMENDED INSTRUMENTAL OPERATING CONDITIONS

Chromatography

Instrument	Dionex chelation system
Preconcentration column	Dionex MetPac CC-1

ICP-MS Instrument Conditions

Instrument	VG PlasmaQuad Type I
Plasma forward power	1.35 kW
Coolant flow rate	13.5 L/min
Auxiliary flow rate	0.6 L/min
Nebulizer flow rate	0.78 L/min

Internal standards	Sc, Y, In, Tb
--------------------	---------------

Data Acquisition

Detector mode	Pulse counting
Mass range	45–240 amu
Dwell time	160 μ s
Number of MCA channels	2048
Number of scan sweeps	250

Figure 1. Configuration of Preconcentration System

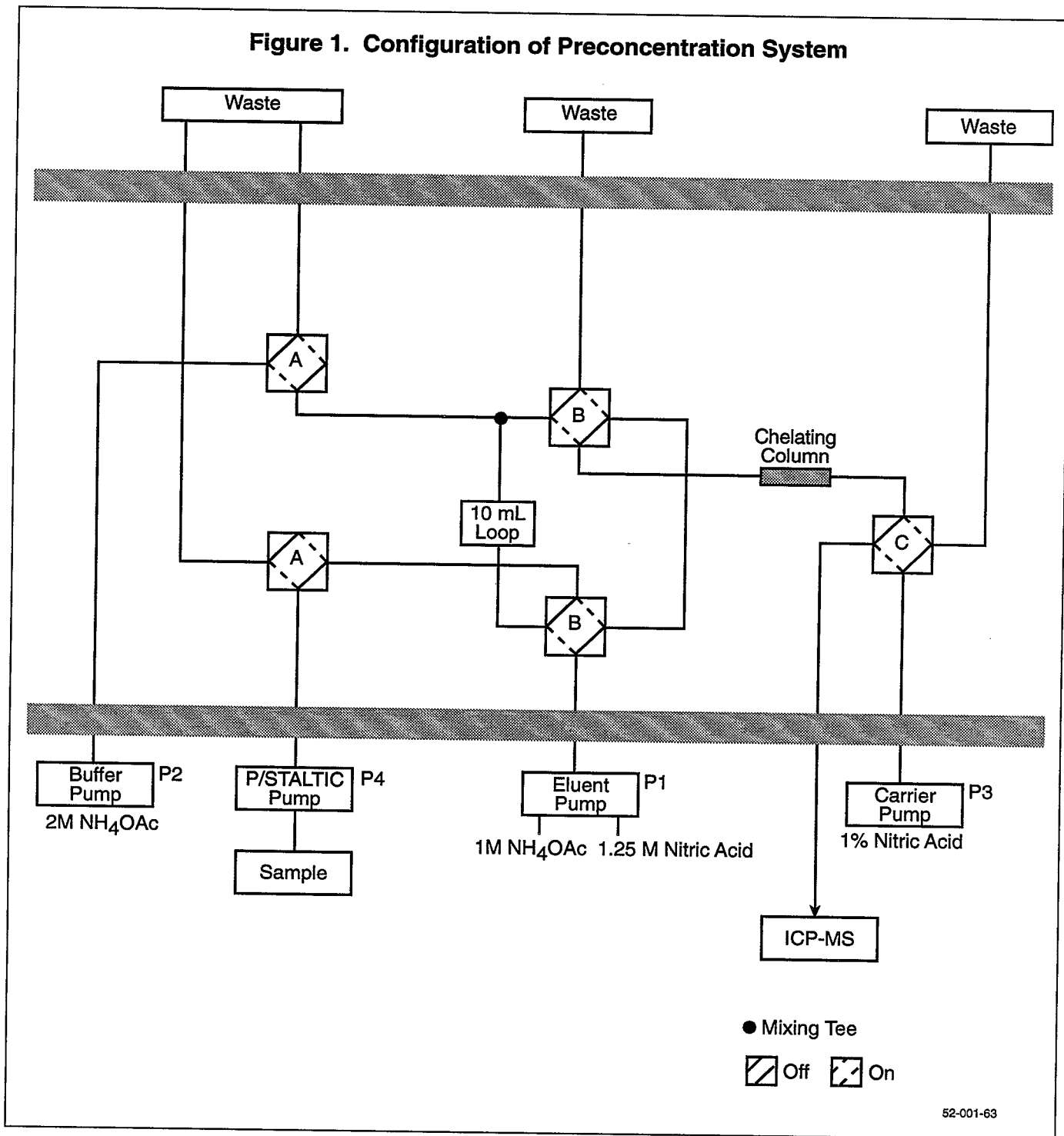

52-001-63

Annex IV:

UNEP/IAEA (2011). Sample work-up for the analysis of selected chlorinated hydrocarbons in the marine environment. Reference Methods for Marine Pollution Studies No 71 (4.2.1)



REGIONAL SEAS

UNITED NATIONS ENVIRONMENT PROGRAMME

November 2011

Sample work-up for the analysis of selected chlorinated hydrocarbons in the marine environment

Recommended Methods For Marine Pollution Studies 71

Prepared in co-operation with



MEDPOL

NOTE: This recommended method is not intended to be an analytical training manual. Therefore, the method is written with the assumption that it will be used by formally trained analytical chemists. Several stages of this procedure are potentially hazardous; users should be familiar with the necessary safety precautions.

For bibliographic purposes this document may be cited as:

UNEP/IAEA: Sample work-up for the analysis of selected chlorinated hydrocarbons in the marine environment. Reference Methods for Marine Pollution Studies No 71, UNEP, 2011.

PREFACE

The Regional Seas Programme was initiated by UNEP in 1974. Since then, the Governing Council of UNEP has repeatedly endorsed a regional approach to the control of marine pollution and the management of marine and coastal resources and has requested the development of regional action plans. The Regional Seas Programme at present includes thirteen regions and has over 140 coastal States participating in it (1).

One of the basic components of the action plans sponsored by UNEP in the framework of the Regional Seas Programme is the assessment of the state of the marine environment, its resources and the sources and trends of the pollution and its impact on human health, marine ecosystems and amenities. In order to assist those participating in this activity and to ensure that the data obtained through this assessment can be compared on a world-wide basis and thus contribute to the Global Environment Monitoring System (GEMS) of UNEP, a set of Reference Methods and Guidelines for marine pollution studies are being developed as part of a programme of comprehensive technical support which includes the provision of expert advice, reference methods and materials, training and data quality assurance (2). The Methods recommended for adoption by Governments participating in the Regional Seas Programme.

The methods and guidelines are prepared in co-operation with the relevant specialised bodies of the United Nations system as well as other organisations and are tested by a number of experts competent in the field relevant to the methods described.

In the description of the methods and guidelines, the style used by the International Organisation for Standardisation (ISO) has been followed as closely as possible.

The methods and guidelines published in UNEP's series of Reference Methods for Marine Pollution Studies are not considered as definitive. They are planned to be periodically revised taking into account the new developments in analytical instrumentation, our understanding of the problems and the actual need of the users. In order to facilitate these revisions, the users are invited to convey their comments and suggestions to:

Marine Environmental Studies Laboratory
IAEA Environment Laboratories
4, Quai Antoine 1^{er}
MC 98000 MONACO

which is responsible for the technical co-ordination of the development, testing and inter-calibration of Reference Methods.

References:

- (1) www.unep.org/regionalseas (2011)
- (2) UNEP/IAEA/IOC: Reference Methods and Materials: A Programme of comprehensive support for regional and global marine pollution assessment. UNEP, 1990.

CONTENTS

	Page
1. Scope and field of application	1
2. Principles	1
3. Reagents, solvents, standards	1
3.1. Reagents	1
3.1.1. List of reagents	1
3.1.2. Cleaning of solvents	3
3.1.3. Cleaning of reagents and adsorbents	3
3.1.3.1. Cleaning of reagents	3
3.1.3.2. Cleaning of adsorbents	4
3.2. Apparatus and equipment	4
3.2.1. List of materials	4
3.2.2. Cleaning of glassware	5
4. Sediments	7
4.1. Sampling	7
4.2. Cleaning of extraction thimbles	7
4.3. Extraction of sediment	7
4.3.1. Extraction of freeze-dried samples	7
4.3.2. Extraction of wet samples	7
4.3.3. Example of determination of percent moisture	8
4.4. Concentration of the extract	8
4.5. Extractable organic matter	9
4.6. Clean-up procedure and fractionation	10
4.6.1. Sulphur and sulphur compounds removal	10
4.6.2. Fractionation	11
4.6.2.1. Florisil	11
4.6.2.2. Gel permeation chromatography	13
4.6.2.3. Alumina and HPLC (silica column)	13
4.6.2.4. High pressure chromatography	13
5. Biota	14
5.1. Sampling	14
5.2. Cleaning of extraction thimbles	14
5.3. Extraction of tissues	16
5.3.1. Extraction procedure for freeze-dried samples	16
5.3.2. Extraction procedure without freeze-drying	16
5.4. Concentration of the extract	16
5.5. Extractable organic matter (EOM)	16
5.6. Clean-up procedure and fractionation	16
5.6.1. Removal of lipids by concentrated sulphuric acid	16
5.6.2. Fractionation	16
6. Capillary Gas chromatographic determinations	17
6.1. Gas chromatography conditions	17
6.2. Column preparation	17
6.3. Column test	18
6.4. Electron capture detector	19
6.5. Quantification	19
7. Computerized gas chromatography/Mass spectrometry (GC/MS)	20
7.1. Operating conditions	20
7.2. Example of a selected ion monitoring programme useful for quantitative analysis of chlorinated compounds	25
8. Notes on water analysis	25
9. Alternative procedures	25
9.1. Combining sample preparation and extraction for chlorinated and petroleum hydrocarbons	25
9.2. Supercritical fluid extraction (SFE) of marine samples	26
9.3. Microwave assisted extraction for marine samples	28
9.3.1. Sediment	28
9.3.2. Biota	28

10. Data interpretation	29
10.1. DDT	29
10.2. PCBs congeners	29
10.3. Typical profiles of commercial mixtures	30
11. Quality assurance / quality control	31
11.1. Precision	31
11.2. Accuracy	31
11.3. Blanks	31
11.4. Recovery	31
11.5. Archiving and reporting of results	31
12. References	34
 Annex:	
Explanations sent to all laboratories with sets of standard provided by IAEA-EL/MESL.	36

1. SCOPE AND FIELD OF APPLICATION

This reference method is intended for use in monitoring programmes and pilot research studies. The document describes procedures for the isolation of purified fractions amenable for the determination of DDTs and PCBs in marine sediments and marine organisms by capillary GC/ECD. It is assumed that most of the participants in the UNEP Regional Seas Programmes are equipped with advanced high resolution capillary gas chromatographs and will be able to implement most, if not all, of the procedures described in Reference Method No 40, "Determination of DDTs and PCBs by capillary gas chromatography and electron capture detection" (UNEP 1988). Assuming consistent results are routinely being obtained with these methods by the analytical laboratory, the determination of specific compounds (as opposed to generic mixture of PCBs) opens up the possibility not only of identifying environmental "hot spots", but also for characterising sources, elucidating transport pathways and developing data of greater toxicological relevance. The organisation and content of this document, however, deserves further comment. Under the sections devoted to SEDIMENTS and ORGANISMS, subsections are provided relating to procedures for: 1) Sampling, 2) Extraction and 3) Clean-up and fractionation. In each subsection, several alternative procedures are described. These various procedures have been previously tested and are provided to accommodate the range of capabilities in participating laboratories. For example, laboratories which have access to an HPLC may consider the benefits of using HPLC fractionation procedures in lieu of more conventional low pressure column chromatographic method. Participants are generally encouraged to implement the most effective procedures within the constraints of their individual laboratories.

Several other halogenated pesticides and other electron capturing organic compounds may be present in environmental samples and many of these compounds could also be isolated by the methods described here. However, not all residues will be stable to the clean-up procedures applied for the determination of PCBs and DDTs. Consequently, every analyst must test for analyte recovery and analytical reproducibility prior to applying these methods for other analytes on a routine basis. Primary emphasis should be placed on obtaining the cleanest possible purified fraction for capillary GC/ECD analysis so that interferences and misidentification are minimised, if not eliminated.

2. PRINCIPLES

Following collection of sediment or biota samples using appropriate techniques, samples are stored in trace organic free vessels at -20°C until analysis. For analysis, the samples are prepared for solvent extraction. To achieve a satisfactory recovery of the chlorinated hydrocarbons, samples are dried by either desiccation with anhydrous sodium sulphate or by freeze-drying. Lipids are then Soxhlet extracted from sediments using hexane and dichloromethane, and from biota using hexane or petroleum ether. Following initial clean-up treatments (removal of sulphur from sediment extracts and treatment of biota extracts with concentrated sulphuric acid to destroy some interfering lipids), extracts are fractionated using column chromatography. Detailed protocols for absorption chromatographic fractionation are described for both low and high pressure systems, using Florisil and silica gel respectively. (Additional information concerning alternative techniques including gel permeation chromatography is provided).

3. REAGENTS, SOLVENTS, STANDARDS

3.1. Reagents

3.1.1. List of reagents

- Demineralized distilled water produced by distillation over potassium permanganate (0.1 g/l KMnO₄) or equivalent quality, demonstrated to be free from interfering substances.
- Detergent.
- Potassium dichromate.
- HCl. 32%.
- Concentrated H₂SO₄ (d 20°C: 1.84 g/ml).
- Sulfochromic cleaning solution made from concentrated sulphuric acid and potassium

- dichromate.
- KOH.
- Anhydrous sodium sulphate.
- Copper fine powder (particle size 63µm).
- Carborundum boiling chips.
- Hg.
- Glass wool
- Alumina (200-240).
- Silica gel (60-100).
- Florisil PR (60-100).
- Bio-Beads SX-3 (200-400).
- Sephadex LX-20.

Solvents:

- Hexane, Dichloromethane, Methanol, Pentane, Cyclohexane, Toluene and Ethyl Acetate, all “distilled in glass” quality.

Standards:

- PCB congeners: 29, 30, 121, 198.
- ε HCH.
- Endosulfan Id₄.
- n-C₁₄ d₃₀, n-C₁₉ d₄₀, n-C₃₂ d₆₆.
- Naphthalene d₈.
- Hexamethylbenzene.
- Cadalene: 1, 6-dimethyl-4-(1-methylethyl)naphthalene.
- DDT reference solutions - Prepare a stock solution of the DDT series (pp' DDT, op DDT, pp' DDD, op DDD, pp' DDE, op DDE) by dissolving 50 mg of each compound in 100 ml of hexane. Store stock solution in sealed glass ampoules.
- Other reference solutions - should be prepared if other residues are to be quantified in these procedures.

NOTES:

Working solutions obtained from the stock reference solutions should be prepared on a regular basis depending on their use and stored in clean glass volumetric flasks tightly capped with non-contaminating materials such as Teflon or glass. Extreme care must be taken to ensure that the concentrations of the standards have not altered due to solvent evaporation.

In order to achieve acceptable accuracy for the standard solutions, at least 50 mg of pure individual compound should be weighed and dissolved into 100 ml of hexane. This will give stock solutions of 500ng/µl.

Example of preparation of stock solutions:

Preparation of a stock solution of pp' DDE at approximately 500ng/µl:

The pp' DDE stock solution is prepared by dissolving approximately (but weighed accurately) 50 mg of pp' DDE in hexane in a 100 ml volumetric flask and bringing the volume to exactly 100 ml with hexane. If the actual weight of pp' DDE is 52 mg, then

$$\frac{52 \text{ mg DDE}}{100 \text{ ml solvent}} \times \frac{1000 \mu\text{g}}{\text{mg}} \times \frac{\text{ml}}{1000 \mu\text{l}} = \frac{52 \text{ mg DDE}}{100 \text{ ml of solution}}$$

$$52 \text{ mg}/100 \text{ ml} \Rightarrow 0.52 \text{ mg/ml} \Rightarrow 520 \mu\text{g/ml} \Rightarrow 520 \text{ ng}/\mu\text{l}$$

The concentration of the stock solution will be: 520ng/µl

Preparation of an intermediate solution:

Use the stock solution to prepare the intermediate solution. The concentration of pp' DDE intermediate solution should be approximately 5ng/μl. To prepare the 5ng/μl intermediate solution, transfer 1 ml of the pp' DDE stock solution into a 100 ml volumetric flask and dilute with hexane to 100 ml.

$$\frac{1 \text{ ml DDE stock solution}}{100 \text{ ml final volume}} \times \frac{520 \text{ ng DDE}}{\mu\text{l}} = \frac{5.2 \text{ ng}}{\mu\text{l intermediate solution}}$$

The concentration of the intermediate solution will be: 5.2 ng/μl

Preparation of the working solution:

Use the intermediate solution to prepare the working solution. The concentration of pp' DDE in the working solution could be approximately 50pg/μl.

To prepare the 50 pg/μl working solution, transfer 1 ml of the pp' DDE intermediate solution into a 100 ml volumetric flask and dilute with hexane to 100 ml.

$$\frac{1 \text{ ml DDE intermediate solution}}{100 \text{ ml final volume}} \times \frac{5.2 \text{ ng}}{\mu\text{l}} \times \frac{1000 \text{ pg}}{\text{ng}} = \frac{52 \text{ pg}}{\mu\text{l working solution}}$$

The concentration of the working solution will be: 52 pg/μl

3.1.2. Cleaning of solvents

All reagents, including the distilled water should be of analytical quality. Commercially available solvents like acetone, acetonitrile, dichloromethane, hexane and pentane are invariably contaminated with ECD-active substances; their concentrations vary from batch to batch and with supplier. Reagent quality should be checked by injection of 2 μl of a 100 ml batch of solvent, after concentration to 50 μl in a rotary evaporator. No peak in the GC-ECD chromatogram (90 - 250 °C) should be larger than that for 1pg of lindane. Otherwise, the solvent must be distilled. The following procedure has been found to be both efficient and cost effective, as it allows the use of technical grade solvents as the basic material (reducing the cost by one order of magnitude). 130 - 150 cm height columns are required; the packing material must be glass (to allow subsequent cleaning with an oxidising acid). The entire equipment is cleaned prior to use by 2 consecutive distillation procedures with 500 ml water in each case. It is essential that a current of nitrogen gas (15 ml/min) flows from the distillation flask during distillation of the organic solvents: the condenser serves as exhaust. Ambient air is not in contact with the solvent in this way. Problems are associated with other methods of excluding room air (e.g., active carbon or molecular sieves), the most important one being discontinuity. The condensate is distilled into a 1 litre flask at a 1:20 ratio. This large volume allows for direct transfer into the appropriate solvent containers which should be made of glass and of a sufficient size to provide solvent for not more than 6 analyses. A bottle with sufficient solvent for 10 - 15 analysis has to be opened and closed many times and even when kept closed, when not in use, contamination from the surrounding atmosphere takes place. For more detailed information, consult the Reference Method No 65: UNEP/IOC/IAEA: Reagent and laboratory ware clean-up procedures for low-level contaminant monitoring.

3.1.3. Cleaning of reagents and adsorbents

3.1.3.1. Cleaning of reagents

Powdered or crystalline reagents, such as anhydrous sodium sulfate (Na₂SO₄)*, potassium hydroxide (KOH), glass wool * and carbon or carborundum boiling chips *, must be thoroughly cleaned before use. They should be extracted with hexane in a Soxhlet apparatus for 8 hours and then with methanol or dichloromethane for another 8 hours. For those items indicated by an *, this will require pre-combustion in a muffle furnace at approximately 400°C.

3.1.3.2. Cleaning of adsorbents

Silica gel, alumina and Florisil have to be solvent extracted. Each reagent is first refluxed with methanol or dichloromethane in a Soxhlet apparatus for 8 hours, then with n-hexane for the same period. The solvent is removed by a rotary evaporator operating at low speed, until the sorbent starts falling down as fine particles. Reagents are dried in a drying oven at 0.01 mbar. If this is not available, they are dried in a normal oven at 120°C for 4 hours. This serves to activate silica and alumina. Florisil has to be activated at 130°C for 12 hours. The sorbent is allowed to cool in the oven (if possible under vacuum to avoid uptake of contaminants from the atmosphere) or alternatively, in a dessicator. As active sorbents attract water and contaminants from the atmosphere, controlled deactivation should be carried out by adding water to the fully active sorbent (5% by weight to silica, 2% by weight to alumina, and 0.5% by weight to Florisil). The deactivation procedure should be carried out by adding the water to the sorbent and mixing by gentle shaking for a few minutes. The equilibration takes one day. The activity can be maintained for longer periods of time by sealing the required amount of sorbent in glass ampoules. Otherwise, the activation/deactivation has to be done the day before use.

3.2. Apparatus and equipment

The laboratory used for organic trace analysis must be a dedicated facility, isolated from other projects that could be sources of contamination. It must be properly constructed with fume hoods and benches with electric sockets that are safe for use with flammable solvents. The laboratory must have extractors and rotary evaporators cooling water to run the stills. In tropical regions and in dry climates, a refrigerated re-circulating system should be used to reduce temperatures to the required levels and/or to conserve water. Stainless steel or ceramic tiles make good non-contaminating surfaces. If necessary, benches can be coated with a hard epoxy resin and walls can be painted with epoxy paint. A sheet of aluminium foil on the workbench provides a surface which can be cleaned with solvent. A vented storage facility for solvents is essential. Benches must be fitted with frames to hold stills, extractors, etc. The emergency cut-off switch should be accessible from both inside and outside the laboratory. Fire fighting equipment should be mounted in obvious places and laboratory personnel trained in their use.

3.2.1. List of materials

- A coring device with liners and plunger or a grab sampler (thoroughly cleaned with detergents and solvents before use).
- Glass jars and aluminium foil, stainless steel knives, scoops, forceps, labels, marking pens, logbook.
- Insulated plastic boxes for transporting samples. Ice or dry ice.
- Deep freezer (-18 to -20°C) for sample preservation (frost free type freezers heat to above zero during frost removal cycles and they cannot be used for long term storage).
- Rotary evaporator.
- Kuderna-Danish (or similar) concentrator and heater.
- Soxhlet extraction apparatus and heaters.
- Glassware including boiling flasks, ground glass stoppers, beakers, Erlenmeyer flasks, separatory funnels, centrifuge tubes, weighing bottles, pipettes, tissue grinders.
- Drying oven (temperature range up to at least 300°C) for determining sample dry weights, baking of contaminant residues from glassware and reagents.

Note: A muffle furnace is better for baking materials at greater than 300°C, if required.

- Centrifuge and tubes.
- Freeze-dryer and porcelain pestle and mortar.
- Analytical balance with an accuracy of 0.1 mg and an electro-balance with an accuracy of at least 1 µg.
- Stainless steel tweezers and spatulas.

- Dessicator - completely free of organic contamination and with no grease applied to sealing edges.
- Supply of clean, dry nitrogen.
- Columns for silica gel, alumina and Florisil chromatography.
- Mechanical blender (food mixer).
- Vacuum pump (water-jet air pump).

3.2.2. Cleaning of glassware

Scrub all glassware vigorously with brushes in hot water and detergent. Rinse five times with tap water and twice with distilled water. Rinse with acetone or methanol followed by hexane or petroleum ether. Bake overnight in an oven at 300 °C. All glassware should be stored in dust free cabinets and tightly sealed with pre-cleaned aluminium foil when not in use. Ideally glassware should be cleaned just before use.

For more detailed information, consult Reference Method No 65: UNEP/IOC/IAEA: Reagent and laboratory ware clean-up procedures for low level contaminant monitoring.

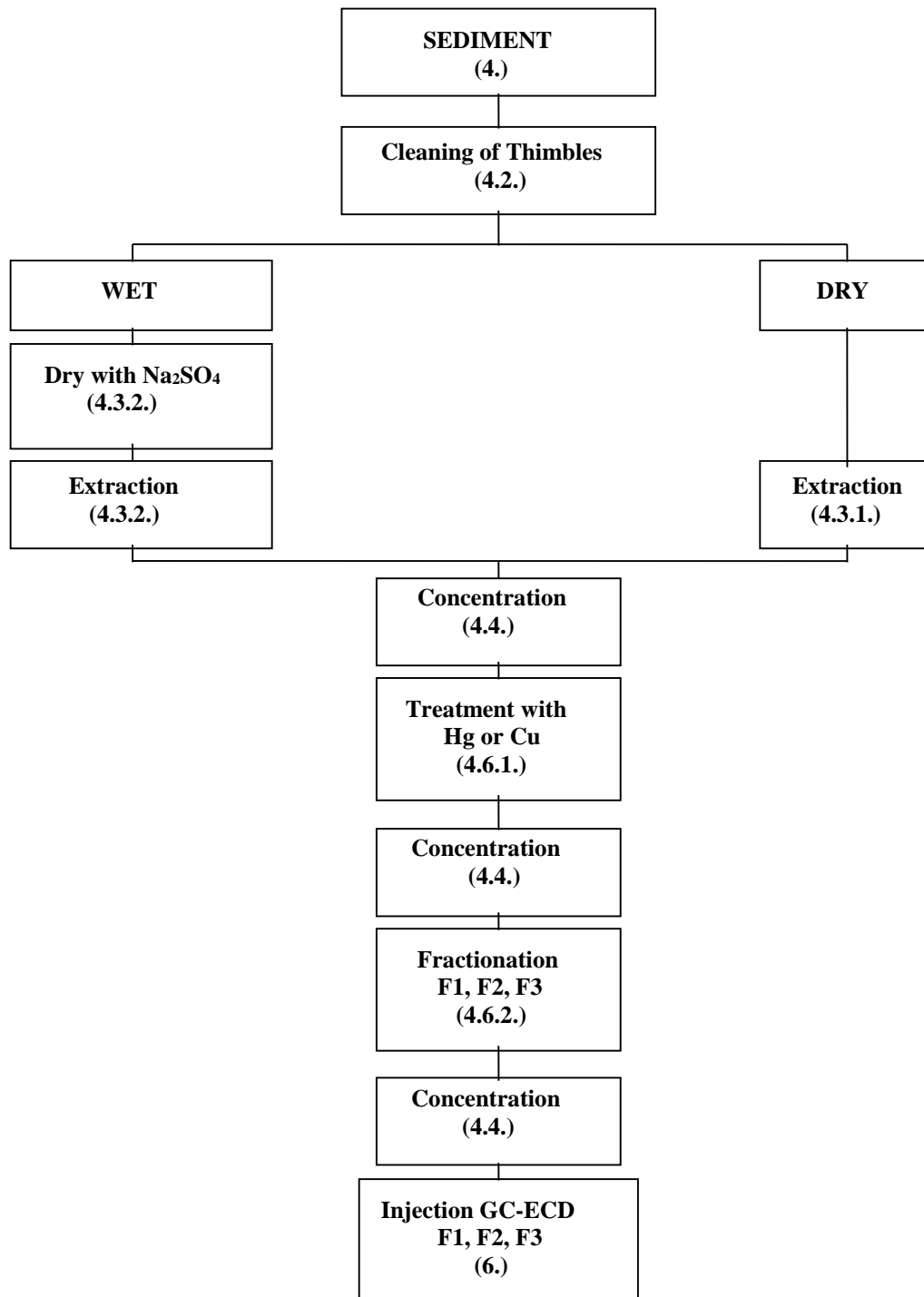

Diagram of the extraction procedure for sediment samples.

4. SEDIMENTS

4.1. Sampling

For the preparation of the samples (including selection of sites, collection of samples and storage) the reader should refer to the Reference Method N° 58: Guidelines for the use of sediments for the marine pollution monitoring programmes, to the Reference Method N° 20: UNEP/IOC/IAEA: Monitoring of petroleum hydrocarbons in sediments and to UNEP(DEC)/MEDW.C282/Inf.5/Rev1: Methods for sediment sampling and analysis (2006).

4.2. Cleaning of extraction thimbles

Paper extraction thimbles should be cleaned prior to sample extraction. For use in the extraction of sediment samples, the extraction can be performed in the Soxhlet apparatus with 250 ml of a mixture hexane / dichloromethane (50:50) for 8 hours cycling the solvent through at a rate of 4 to 5 cycles per hour. Add into the solvent a few carborundum boiling chips to get a regular ebullition.

The use of disposable paper thimbles for the extraction procedure rather than re-usable glass fibre thimbles is recommended due to the difficulties encountered in cleaning the latter.

4.3. Extraction of sediments

4.3.1. Extraction of freeze-dried samples

Select a 50-100 g sub-sample of the sediment, weigh this sub-sample and freeze-dry it. When dried, re-weigh it and calculate the dry to wet ratio. Then pulverise the sample using a pestle and mortar and sieve it using a 250 µm stainless steel sieve. Accurately weigh about 20 g of ground sample and place it in the pre-cleaned extraction thimble. Add 1 ml of a solution of 25 pg/µl of 2,4,5 trichlorobiphenyl (PCB N° 29), 20.9 pg/µl of 2,2',3,3',4,5,5',6 octachlorobiphenyl (PCB N° 198), 20 pg/µl of ε HCH and 21 pg/µl of Endosulfan Id₄ as internal standards and extract for 8 hours in a Soxhlet apparatus with 250 ml of a mixture hexane / dichloromethane (50:50), cycling the solvent through at a rate of 4 to 5 cycles per hour, add into the solvent a few carborundum boiling chips to get a regular ebullition. Alternatively (or in addition), PCB congeners No 30, 121, or octachloronaphthalene and PCB congeners can be used as internal standards. Prepare a procedural blank by extracting an empty thimble using the same procedure as for the samples.

4.3.2. Extraction of wet samples

The sediment is thawed, sieved at 250 µm and homogenised manually with a stainless steel spatula or clean glass rod. A sub-sample of 1-2 g is weighed into a flask and placed in a drying oven at 105 °C for 24 hours, then allowed to cool to room temperature and re-weighed. Calculate the dry to wet ratio and discard the dry sediment (unless it is being used for other analysis e.g. TOC, total organic carbon).

Place a 30-40 g sub-sample of thawed, homogenised sediment into a blender. Slowly, add 100g of anhydrous sodium sulphate (desiccant) and blend the mixture at high speed for 10 minutes. Transfer the dried sample quantitatively to the pre-cleaned extraction thimble in the Soxhlet apparatus, add the internal standard solution (see above) and apply the same extraction procedure as above. Extract the same amount of sodium sulphate as a procedural blank, making sure to add an appropriate amount of internal standard solution.

4.3.3. Example of determination of percent moisture

Many environmental measurements require the results to be reported on a dry weight basis. The percent moisture or water content in the sample is determined by weighing an aliquot, not used for analysis, of the sample before and after drying. The drying can be done by heating a few grams (1-2 g) of the sample in an oven to constant weight.

Weigh an empty glass beaker that will be used to hold the sample while it is dried.
Empty beaker weight = 10.4417 g

Add the wet sample to the beaker and reweigh. Calculate the wet weight of the sample.
Empty beaker weight + wet sample = 12.2972 g
Wet sample weight = 12.2972 g - 10.4417 g = 1.8555 g

Dry the sample to constant weight: dry the sample for 24 hours, weigh it, dry again for 12 hours, re-weigh it, when the difference in weight is less than 5%, it means that the sample is dried.

Empty beaker weight + dry sample weight = 10.9396 g
Dry sample weight = 10.9396 g - Empty beaker weight
Dry sample weight = 10.9396 g - 10.4417 g = 0.4979 g

Calculate the percent dry sample weight.

$$\begin{aligned} \% \text{ Sample weight} &= \frac{\text{Sample dry weight}}{\text{Sample wet weight}} \times 100 \\ &= \frac{0.4979}{1.8555} \times 100 = 26.8 \% \end{aligned}$$

Calculate the percent moisture.

$$\begin{aligned} \text{Water content} &= \text{wet weight} - \text{dry weight} \\ &= 1.855 \text{ g} - 0.4979 \text{ g} = 1.3576 \text{ g} \end{aligned}$$

$$\% \text{ Moisture} = \frac{\text{Sample water weight}}{\text{Sample wet weight}} \times 100$$

$$\% \text{ moisture} = \frac{1.3576}{1.8555} \times 100 = 73.2 \%$$

4.4. Concentration of the extract

For both extraction procedures, the extracts are concentrated in a rotary evaporator to about 15 ml. Under good vacuum conditions the temperature of the water bath must not exceed 30 °C. Dry the extract with anhydrous sodium sulphate (when the sodium sulphate moves freely in the flask it means that the extract is dried). Collect the dried extract in the graduated tube of a Kuderna-Danish concentrator. Concentrate the extract to approximately 5 ml with the Kuderna-Danish concentrator and adjust the volume to exactly 1 ml by evaporating excess solvent under a gentle stream of clean dry nitrogen. The sample extract will be analysed gravimetrically for extractable organic matter (EOM) content at the 1 ml volume as a starting point. If measurements of the EOM are outside the calibration range of the balance, the total volume of the extract is adjusted accordingly using either dilution with hexane or evaporating under a stream of nitrogen gas.

4.5. Extractable organic matter

Before carrying out the clean-up procedure, it is advisable to determine the extractable organic matter.

The EOM is determined in the following manner. On the weighing pan of an electro-balance, evaporate a known volume of the sediment or biota extract (up to 100 µl) and weigh the residue with a precision of about ± 1 µg. If the residue is less than 2 µg, pre-concentration of the original extract is required. The quantity of EOM is:

$$\text{EOM } (\mu\text{g/g}) = \frac{\text{Weight of residue } (\mu\text{g}) \times \text{volume of the extract (ml)} \times 1000}{\text{Volume evaporated } (\mu\text{l}) \times \text{quantity of sample extracted (g)}}$$

Note that extreme care must be taken to ensure balance and pans are clean, dry and stable to obtain accurate readings at the ± 1 µg level. A small hot plate is used to warm pans and forceps and thus keep these instruments dry after solvent cleaning. If no electro-balance is available, a known volume of the extract can be transferred into a clean pre-weighed beaker. The solvent is evaporated with dry and clean nitrogen until a constant weight of about 1 mg is reached. Calculate the amount of “lipids” in the sample taking into account the volume of the lipid extract which was dried.

Example of calculation of E.O.M.

The extractable organic matter content of a sample is operationally defined as the weight of material extracted with the solvent employed (H.E.O.M. in case hexane is used as solvent). An aliquot of the sample extract is taken (few µl), the solvent is evaporated and the residue is weighed to determine the quantity of lipids extracted in the aliquot and from it to the total sample. The results are normally reported in mg lipids per gram dry weight extracted.

A 1 µl aliquot is removed from a 2.5 ml sample extract for determination of E.O.M. The 1 µl aliquot is evaporated on the pan of an electro-balance and the residue is weighed. Three determinations are made and the average taken.

Measurements:

Sample dry weight extracted: 4.443 g

Total volume of the extract: 2.5 ml

Sample aliquot removed: 1 µl

(1) Weight of a 1 µl aliquot after solvent evaporation: 32.2 µg

(2) Weight of a 1 µl aliquot after solvent evaporation: 32.1 µg

(3) Weight of a 1 µl aliquot after solvent evaporation: 32.3 µg

Average weight of a 1 µl aliquot : 32.2 µg

Total volume of the extract: 2.5 ml

Total quantity of lipids in the sample:

$$32.2 \mu\text{g}/\mu\text{l} \times 2.5 \text{ ml} \times \frac{1000 \mu\text{l}}{\text{ml}} = 80500 \mu\text{g} \text{ or: } 80.5 \text{ mg}$$

With 4.443 g of sample extracted:

$$80.5 \text{ mg} / 4.443 \text{ g} = 18.1 \text{ mg lipids/g}$$

4.6. Clean-up procedure and fractionation

Purposes of the clean-up: removal of lipids, whenever present at a significant amount; removal of elementary sulphur and sulphur compounds. Both these compound classes can interfere with the gas-chromatographic separation.

4.6.1. Sulphur and sulphur compounds removal

Elementary sulphur and sulphur compounds such as mercaptans should be removed from the extract. This could be done by using either mercury or activated copper.

a) Mercury method.

Add one drop (a few ml) of mercury to the sediment extract and shake vigorously for one minute. Centrifuge and carefully recover and transfer the extract in another tube with a Pasteur pipette. If the mercury is still tarnished, repeat the treatment with another drop of mercury, shake, transfer the hexane into another tube. Repeat this treatment until the mercury stays brilliant in the extract. Rinse the mercury with 5 ml of hexane and combine the extracts. Then, concentrate the resulting solution to ca. 1 ml with a gentle stream of nitrogen.

Cleaning of mercury:

Caution: When removing mercury from the sample, always use a plastic tray to keep the glassware in and work under a fume hood.

Fit a folded filter paper in a 10 cm diameter conical glass funnel and fix the funnel over a 250 ml glass beaker. Using a needle, make a small hole in the bottom of the filter paper. Carefully put the mercury onto the funnel. The mercury flows through the small hole in the filter paper leaving the solid impurities on its surface. The mercury collected is washed three times by shaking it carefully with dichloromethane and by removing dichloromethane layer with the help of a clean glass syringe. Allow the rest of dichloromethane evaporate and store the clean mercury in a thick walled glass bottle with a ground glass stopper. In order to avoid escape of mercury vapour, store the mercury under methanol.

Another way of cleaning the mercury involves sucking the dirty mercury through a capillary tube, such as a Pasteur pipette, connected to a guard-flask and then to a vacuum pump. The mercury will pass through the Pasteur pipette and will be collected and cleaned in the guard-flask. Then it should be transferred into a thick wall glass bottle with a ground glass stopper. The mercury is covered with a layer of methanol to protect it from oxidation.

b) Activated copper method.

Transfer about 20 grams of the copper powder in an Erlenmeyer. Add enough concentrated HCl to cover the copper powder, agitate. Sonicate for 10 min., agitate, put again in ultrasonic bath and sonicate for 10 min. Throw the used HCl, add some fresh HCl, transfer in ultrasonic bath and sonicate for 20 min. repeat that procedure four times in total. Wash with distilled water, agitate, discard, add water again, transfer in ultrasonic bath and sonicate for 15 min., discard the used water, repeat that procedure again, up to pH neutral. Wash with acetone, agitate, transfer in ultrasonic bath and sonicate for 15 min. repeat that procedure four times in total. Then use the same procedure with hexane as a solvent.

Keep in hexane (use it immediately, avoids Cu to be in contact with air).

Transfer 3 to 4 Pasteur pipettes per sample in the flasks containing the hexane extracts. Let the copper react all night. The presence of sulphur compounds in the sample will be detected by the tarnishing of the copper powder. Then, concentrate the resulting solution to ca. 1 ml with a gentle stream of pure nitrogen.

4.6.2. Fractionation

An adsorption chromatography step is used to remove interfering lipids and to fractionate the extract into classes of compounds. Many variations of adsorption chromatography clean-up procedures have been published to date. Four procedures are reported here in order of increasing complexity.

Preparation of the columns: Glass burettes (1 cm diameter) with Teflon stopcocks make convenient adsorption columns. The column is plugged with pre-cleaned cotton or glass wool. Prepare separate columns for each sample and blank determination. The column is partially filled with hexane. The appropriate amount of sorbent is mixed with hexane in a small beaker to form a slurry. A glass funnel and a glass rod are used to pour the adsorbent into the column. Several rinses with hexane are necessary to fill the column to the desired height. Tap with a pencil or a hard silicone tube against the column in order to settle the adsorbent into an even bed. Flush the material adhering to the wall of the column down to the bed with solvent. Prepare each column freshly immediately before use. Never let the column get dry.

4.6.2.1. Florisil

A Florisil column is used for this fractionation, which is prepared in the following way. The Florisil should be pre-extracted in the Soxhlet apparatus to remove any contaminants, using methanol or dichloromethane for 8 hours, followed by hexane for another 8 hours. It is then dried in an oven. Activation is achieved by heating the dried Florisil at 130°C for 12 hours. It is then partially deactivated with 0.5% water by weight and stored in a tightly sealed glass jar with ground glass stopper. The water should be well mixed into the Florisil and the mixture should be allowed to equilibrate for one day before use. The activation/deactivation procedure should be carried out one day before use. A 1 cm burette with Teflon stopcock is plugged with pre-cleaned glass wool. A column with a sintered glass disk could also be used. 17 grams of Florisil are weighed out in a beaker and covered with hexane. A slurry is made by agitation and poured into the glass column. The Florisil is allowed to settle into an even bed and any Florisil adhering to the column is rinsed down with hexane. The solvent is drained to just above the Florisil bed. It should be rinsed with a further 5 ml of hexane; one gram of anhydrous sodium sulphate is added to the top of the column in order to protect the surface of the Florisil from any disturbance. The column should never run dry. Individual columns should be prepared immediately before use and a new column of Florisil used for each sample.

The extract, reduced to 1 ml, is put onto the Florisil column. It is carefully eluted with 65 ml of hexane and the first fraction collected. Then the column is eluted with 45 ml of a mixture containing 70 % of hexane and 30 % of dichloromethane and the second fraction collected. The third fraction will be eluted with 60 ml of pure dichloromethane.

Fraction one will contain the PCBs, pp' and op DDE and some other pesticides such as HCB, aldrin, heptachlor, DDMU.

Fraction two will contain the DDTs, DDDs, most of the toxaphene, and some pesticides such as the HCH isomers and chlordane components.

Fraction three will contain mainly dieldrin, endrin, heptachlor epoxide and endosulfan components. Typical chromatograms obtained are shown below.

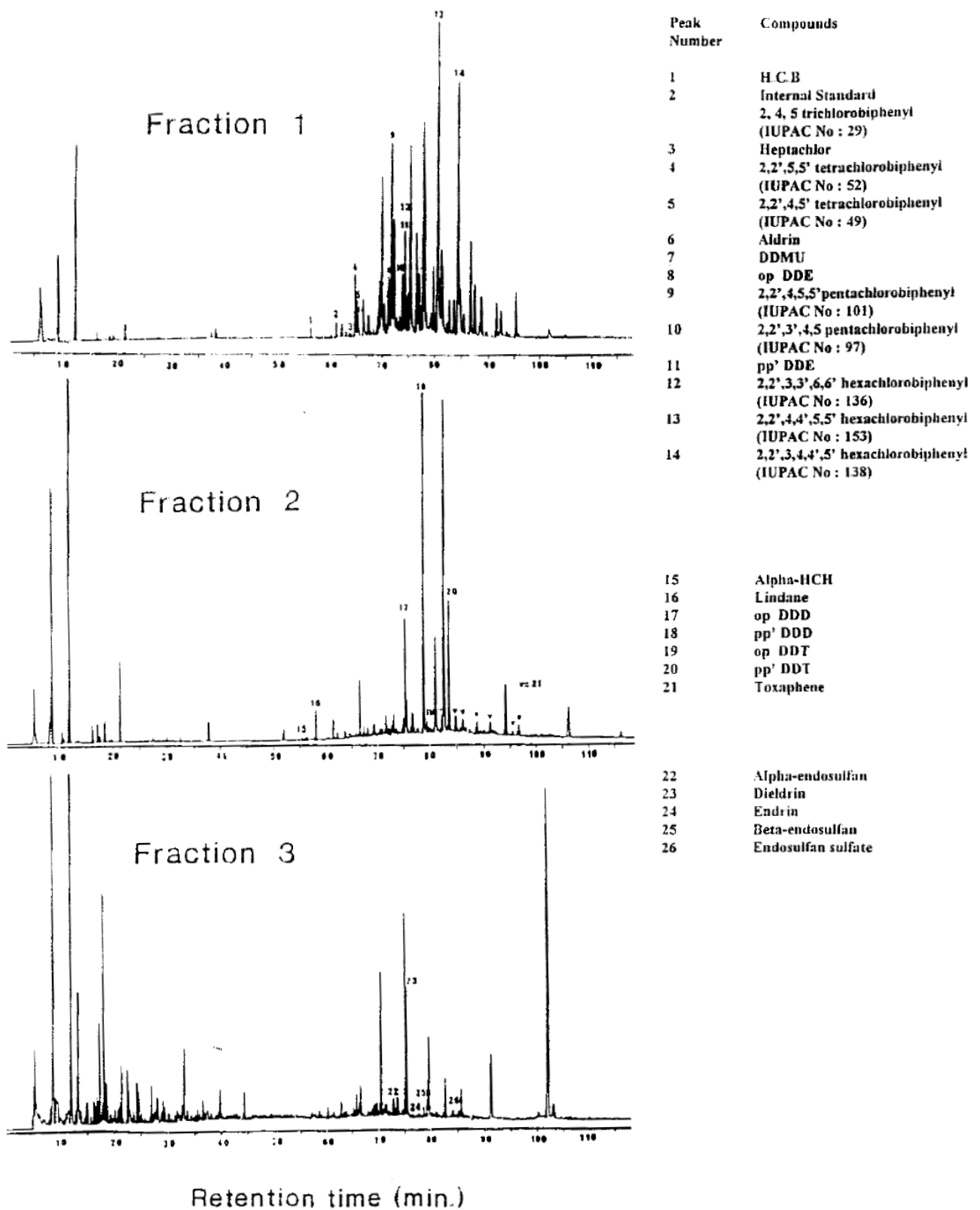

Figure 2: GC-ECD organohalogen analyses

4.6.2.2. Gel permeation chromatography

Low pressure GPC can be used as an alternative clean-up technique to remove high molecular weight co-extractable lipidic material from polycyclic aromatic compounds and halogenated aromatics. Concurrently, elemental sulphur could be also removed from the whole organic extract.

The main feature of the semi-preparative-GPC as a clean-up technique relies on the compatibility of this analytical procedure with labile components of the extract (i.e. DDTs, chlorinated cyclohexadiene derivatives), which are not stable in other types of extract clean-up procedures. Further, GPC as a clean-up technique has already been automated, enabling a high sample throughput, taking into account the short analysis time involved.

The GPC retention mechanism may involve adsorption, partition and size exclusion mechanisms. The predominance of one mechanism over the others is largely determined by the choice of the mobile phase and the pore size of the packing. In the case of GPC packings with large pore size (1000-2000 daltons) size exclusion and adsorption mechanisms prevail (Bio-Beads SX-3 using cyclohexane, dichloromethane-hexane, dichloromethane-cyclohexane, toluene-ethylacetate and ethylacetate-cyclohexane) (Ericksson *et al.*, 1986). On the other hand, when smaller pore sizes (400 daltons) are used in combination with highly polar solvents, (THF, DMF) size exclusion predominates (Lee *et al.*, 1981). While using the first approach, a chemical class fractionation could be obtained, however, if smaller pore sizes are used it should be combined with another fractionation technique (i.e. adsorption chromatography) to achieve this selectivity. It has yet to be demonstrated that using GPC as a single clean-up step produces a completely clean extract for GC-ECD determination. Nevertheless, taking into account the increasing availability of high-resolution low molecular weight exclusion packings, they could definitively integrate fractionation and clean-up in a single step.

Low resolution packing (Sephadex LH and Bio-Beads SX, 200-400 mesh size) are the most widely used because they are inexpensive and afford relatively high sample loading (500 mg in 10 mm i.d. columns). The implementation of low resolution GPC requires a solvent delivery system and a UV detector and may be useful. For method development, it is advisable to inject a broad range of standard compounds covering the whole range of molecular weights of the analytes to be determined in order to determine the cut-off points to fractionate real samples. Reported recoveries of PCBs and PAHs range from 60 to 80 % for the concentration level (ng) injected. (Fernandez and Bayona, 1992).

4.6.2.3. Alumina and HPLC (silica column)

The first step in this clean-up procedure is an adsorption step using an alumina column to remove most of the lipid material. Prepare an alumina column (4 x 0.5 cm i.d., made from a Pasteur pipette). Apply the concentrated extract to the top of the column and elute with 10 ml hexane. Concentrate the eluate to about 200 µl. It is followed by a second step to more completely remove interfering compounds and at the same time to separate the compounds of interest into different fractions, containing aliphatics, PCBs, PAHs, pesticides and toxaphene. Between 20 and 200 µl of the extract (after alumina clean-up) are eluted on a stainless steel column (200 x 4 mm i.d.), packed with Nucleosil 100-5 with n-pentane, 20 % dichloromethane in n-pentane and finally dichloromethane. The eluate is collected in fractions containing 1) n-hydrocarbons, 2) PCBs, 3) PAHs and toxaphene, 4) pesticides and toxaphene and 5) acids, etc. (polar compounds). The size of the fractions has to be determined with standard solutions containing the compounds of interest, collecting the eluate in 0.5 ml fractions. Each fraction is then analysed by GC-ECD. Full details have been given in the literature (Petrick *et al.*, 1988 and IOC, 1993).

4.6.2.4. High pressure chromatography

High pressure liquid chromatography (HPLC) columns packed with microparticles are available and have the advantages of high reproducibility, low consumption of solvents, high efficiency and high sample loading capacity.

This method can be used to separate fractions containing aliphatic hydrocarbons, PCBs and aromatic hydrocarbons from interfering compounds. These fractions can then be analysed separately for their constituents by GC-FID and/or GC-ECD.

HPLC methods have been developed using synthetic solutions of n-alkanes, PAHs, pesticides, PCBs and toxaphene and have been applied to samples in which interfering substances were present in such high concentrations as to render the analysis of HC and PCBs extremely difficult without this clean-up procedure (e.g. sediments and biological tissues with OCs in the ng/g range). The samples are eluted with n-hexane, subjected to clean-up over alumina, concentrated down to 20-200 µl and treated by HPLC. With the use of n-hexane, n-pentane and 10 %, 20 % and 50 % dichloromethane in n-hexane, respectively, the following five fractions are obtained : 1) n-hydrocarbons and alkenes, 2) PCBs and alkylbenzenes, 3) PAHs and toxaphene, 4) pesticides, 5) acids, etc.(polar compounds). (Petrick *et al.* 1988).

5. BIOTA

5.1. Sampling

Organisms accumulate many contaminants from their environment (i.e., from sea water, suspended particulate matter, sediment and food). Field and laboratory studies have shown that contaminant concentrations in some marine plants and animals reflect concentrations in their environment. Scientists use this process (termed bio-accumulation) to assess marine contamination resulting from human activity (e.g., pipeline discharges, dumping from ships).

There are problems with using biota as bio-accumulators (bio-indicators). For example, tissues from individuals of a species exposed to the same contaminant concentration may contain different levels of contamination after the same exposure time. These deviations reflect individual differences in factors such as age, sex, size, and physiological and nutritional states. Also, various species show different contaminant concentrations following identical exposure; differences in elimination rates may partially account for this. These factors must be considered when planning a monitoring programme in order to control their effects on the precision of the analysis (by reducing the variances). Variance reduction is necessary in order to detect smaller differences in mean contaminant concentrations observed in monitoring programmes.

For proper sampling and sample preparation, refer to Reference Method No 6 “Guidelines for monitoring chemical contaminants in the sea using marine organisms” and Reference Method No 12 Rev.2 “Sampling of selected marine organisms and sample preparation for the analysis of chlorinated hydrocarbons”.

5.2. Cleaning of extraction thimbles

As for extraction of sediment samples, thimbles should be extracted first with the same solvent used for the extraction of the sample. As the extraction of biota sample is achieved with hexane, a pre-extraction of these thimbles is made with 250 ml of hexane for 8 hours in the Soxhlet apparatus, cycling the solvent through at a rate of 4 to 5 cycles per hour. Add into the solvent a few carborundum boiling chips to get a regular ebullition.

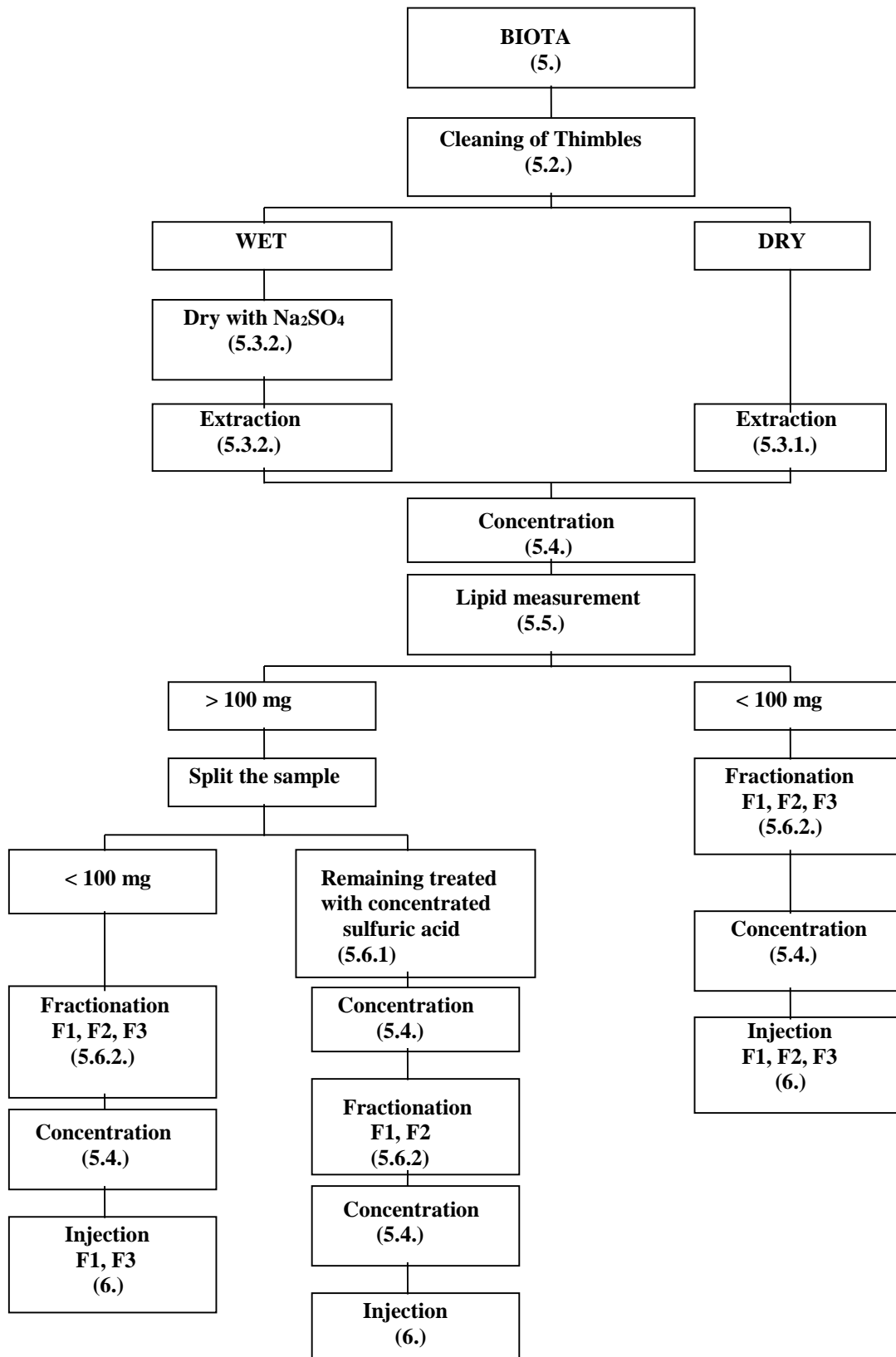

Figure 3: Diagram of the extraction procedure for biota samples.

5.3. Extraction of tissues

5.3.1. Extraction procedure for freeze-dried samples.

Take a 50 to 100 g fresh weight sub-sample from the sample. Weigh this sub-sample and freeze-dry it. When the sub-sample appears to be dry, re-weigh it and freeze-dry it for a further 24 hours and then re-weigh it. If the difference between the two dry weights is greater than 5%, continue the freeze-drying process. Special care must be taken to ensure that the freeze-drier is clean and does not contaminate the samples. The freeze drying procedure should be tested by drying 100 g Na₂SO₄ as a blank and extracting this as a sample. Pulverise the freeze-dried sub-sample carefully using a cleaned pestle and mortar. Accurately weigh about 5 to 10 g of this pulverised material, note the exact weight to be extracted, and place it into a pre-cleaned extraction thimble in a Soxhlet apparatus. The size of the sub-sample should be adjusted so that about 100 mg of extractable organic matter ("lipid") will be obtained. Smaller sub-samples should be used if residue concentrations are expected to be high. Add a known amount of internal standard to the sub-sample in the thimble before Soxhlet extraction. It is important to spike the sample at levels that are near to that of the analyte concentrations in the samples. If, in the end, the analyte and the internal standard concentrations do not fall within the established calibration range of the GC-ECD, the analysis must be repeated. Consequently, it may be advisable to perform range-finding analysis for samples of unknown character beforehand. Candidate internal standards are the same as for sediment samples (see 5.3.). Add about 200 ml of hexane or petroleum ether to the extraction flask with a few carborundum boiling chips, and extract the sample for 8 hours cycling the solvent through at a rate of 4 to 5 cycles per hour. Extract an empty thimble as a procedural blank, making sure to spike it with internal standards in the same fashion as the sample. If unacceptable procedural blanks are found, the source of contamination must be identified and eliminated rather than subtracting high blank values from the analytical results.

5.3.2. Extraction procedure without freeze-drying

Select a 25 to 100 g fresh weight sub-sample and place in a blender. Add anhydrous sodium sulphate to the sample, manually homogenise and determine whether the sample is adequately dried. If not, more sodium sulphate should be added until a dry mixture is obtained. Normally, 3 times by the sample weight used should be enough. Once this has been achieved, blend the mixture at high speed for 1 or 2 minutes until the mixture is well homogenised and the sample appears to be dry. Transfer the mixture to a pre-cleaned extraction thimble, add internal standards as described above and extract the dehydrated tissue with about 200 ml hexane or petroleum ether for 8 hours in a Soxhlet apparatus, cycling 4 to 5 times per hour. Extract the same amount of sodium sulphate as the procedural blank, making sure to add internal standards in the same fashion as the sample.

5.4. Concentration of the extract

Refer to section (4.4.)

5.5. Extractable Organic Matter (EOM)

Refer to section (4.5.)

5.6. Clean-up procedure and fractionation

5.6.1. Removal of lipids by concentrated sulphuric acid

If the lipid content of the extracts is higher than 100-150 mg, a preliminary step for the removal of the lipids is necessary before further sample purification. This can be carried out by using concentrated sulphuric acid. Treatment with sulphuric acid is used when chlorinated hydrocarbons are to be determined. However, sulphuric acid will destroy dieldrin and endrin so that an aliquot of the untreated extract must be set aside for the determination of these compounds.

CAUTION: During all this procedure it is very important to wear safety glasses.

Take an aliquot of the concentrated extract, containing about 200 mg of “lipids”, transfer into a separatory funnel and add to this extract enough hexane in order to dilute the sample (40 to 50 ml should be enough), this will allow recovery of the hexane after acid treatment, because if the sample is too concentrated, the destroyed “lipids” will become almost solid and it will be difficult then to recover the hexane from this solid mass. Add 5 ml concentrated sulphuric acid to the extract and tightly fit the glass stopper and shake vigorously. Invert the funnel and carefully vent the vapours out through the stopcock. Repeat this procedure for several minutes. Place the separatory funnel in a rack and allow the phases to separate. Four or five samples and a spiked blank are convenient to process at one time. The extract should be colourless. Recover the hexane phase into a glass beaker. Dry with sodium sulphate and transfer the hexane into a Kuderna-Danish concentrator. Reduce the volume of the extract by evaporating the solvent with a gentle stream of pure nitrogen to about 1 ml.

5.6.2. Fractionation

Refer to section (4.6.2.)

6. CAPILLARY GAS CHROMATOGRAPHIC DETERMINATIONS

6.1. Gas chromatographic conditions

- Gas chromatograph with a split/splitless injection system, separate regulation system for inlet and column pressures and temperatures; multi-ramp temperature programming facilities (preferably microprocessor controlled), electron capture detector interfaced with the column with electronic control unit and pulsed mode facilities. An integrator with a short response time (0.25 s) is essential.
- Narrow-bore (0.22 mm internal diameter), 25 m long, fused silica open tubular column, coated with SE-54 (0.17 µm film thickness, preferably chemically bonded) with sufficient resolution to separate the relevant peaks in the standards provided for PCB analysis.
- Carrier gas should be high purity H₂. If this is not available or if the GC is not equipped with a special security system for hydrogen leak, He may be used. Gas purification traps should be used with molecular sieves to remove oxygen, moisture and other interfering substances.
- High purity nitrogen gas (99.995 %) as ECD make-up gas can be used (Argon/methane high purity gas is another option).

Conditions:

- H₂ or He carrier gas at inlet pressure of 0.5 to 1 Kg/cm² to achieve a flow rate of 1 to 2 ml/min.
- Make-up gas N₂ or Ar/CH₄ at the flow rate recommended by the manufacturer (between 30 and 60 ml/min.).
- ECD temperature: 300°C

6.2. Column preparation

Fused silica columns are the columns of choice for their inertness and durability (they are extremely flexible). They are made of material that is stable up to 360 °C. The 5 % phenyl methyl silicone gum (SE-54) liquid phase, is present as a thin, (0.17 µm), uniform film which can tolerate temperatures up to 300 °C. SE-54 is relatively resistant to the detrimental effects of solvents, oxygen and water, at least at low temperatures. These columns are even more resistant and durable if the liquid phase is chemically bonded to the support by the manufacturer.

For GC/MS work, it is advised to restrict the film thickness to 0.17 µm because with thicker films some of the phase could be released, resulting in an increase of the noise signal in the GC/MS.

The flexible fused silica columns can be conveniently connected directly to the inlet and outlet systems without the transfer lines used in conventional glass capillary chromatography which often lead to increased dead volume. Low bleed graphite or vespel ferrules provide a good seal.

The presence of extraneous peaks and elevated baseline drift will result in poor detector performance. This can be caused by components which elute from the column, such as residual solvents and low molecular weight liquid phase fractions on new columns and build-up of later eluting compounds on old columns. Conditioning is a necessary step to remove these contaminants. New columns are connected to the inlet (while left unconnected to the detector). Columns are flushed with carrier gas at low temperature for 15 min. to remove the oxygen, then heated at 70-100 °C for 30 min. and finally at 170 °C overnight. The column can be then connected to the detector. Old columns can be heated directly to elevated temperatures overnight. The final temperature is selected as a compromise between time required to develop a stable baseline and expected column life. Thus, it may be necessary for older columns to be heated to the maximum temperature of the liquid phase resulting in shorter column life. The temperature of the ECD, when connected to the column, should always be at least 50 °C higher than the column, in order to avoid condensation of the material onto the detector foil. It is essential that carrier gas flows through the column at all times when at elevated temperatures. Even short exposure of the column to higher temperature without sufficient flow will ruin the column.

CAUTION: if H₂ is used as a carrier gas, position the column end outside of the oven to avoid explosion risk.

6.3. Column test

When the column has been connected to the detector, the carrier gas flow is set to 30 ml per minute for a column with 4 mm internal diameter. The column performance is then measured according to the criteria of the “number of theoretical plates” for a specific compound and can be achieved according to the following procedure.

- Set injector and detector temperatures at 200 and 300°C respectively and the column oven temperature at 180 °C.
- Inject pp’ DDT standard and measure the retention time (Tr). Adjust the column temperature to get a pp’ DDT retention time relative to Aldrin of 3.03.
- Measure the width of the pp’ DDT peak at its half height ($b_{1/2}$), in minutes and the retention time (Tr) also in minutes.
- Calculate the number of theoretical plates using the formula:

$$N = 5.54 \left(\frac{Tr}{b_{1/2}} \right)^2$$

- A parameter which is independent of the column length is the height equivalent to a theoretical plate (HETP):

$$HEPT = \frac{L}{N}$$

Where L is the column length. Adjust the flow rate of the carrier gas to obtain optimum performance. The HETP should be as low as possible (i.e. the number of theoretical plates should be as great as possible).

The column remains in optimum condition as long as the liquid phase exists as a thin, uniform film. The quality of the film at the inlet side may be degraded as a result of repeated splitless

injections. Decreased column quality may be remedied by the removal of the end of the column (10 to 20 cm) at the inlet side. Chemically bonded liquid phases require less maintenance.

6.4. Electron capture detector

High-energy electrons, emitted by a radioactive source within the detector (e.g. a ^{63}Ni foil), are subject to repeated collisions with carrier gas molecules, producing secondary electrons. These electrons, upon returning to their normal state, can be captured by sample molecules, eluting from a GC column. The resulting reduction in cell current is the operating principle of an electron capture detector. The detector current produced is actually a non-linear function of the concentration of electron-capturing material. However, the useful linear range of an ECD may be greatly improved if the instrument is operated at a constant current, but in a pulsed mode, i.e. with short voltage pulses being applied to the cell electrodes. The current in the cell is kept constant by varying the frequency of the pulses.

Contamination of the detector (and thus lower sensitivity) may result from high-boiling organic compounds eluting from the column. Periodic heating to 350°C may overcome this problem. The ^{63}Ni ECD can be used at 320°C under normal operational conditions, in order to limit such contamination.

The optimum flow for an ECD (30 to 60 ml/min.) is much higher than carrier gas flow through the column of one or two ml/min. Thus an additional detector purge flow is necessary (N_2 or Ar/CH_4). Once leaving the outlet of the column, the compounds have to be taken up into an increased gas flow in order to avoid extra-volume band broadening within the detector. Thus, the detector purge flow also serves as the sweep gas.

6.5. Quantification

The most widely used information for identification of a peak is its retention time, or its relative retention time (i.e., the adjusted retention time relative to that of a selected reference compound). Retention behaviour is temperature dependent and comparison of retention times obtained at two or more temperatures may aid in determining a peak's identity. However, retention times are not specific and despite the high resolution offered by capillary columns, two compounds of interest in the same sample may have identical retention times.

One way of using retention indexes could be to inject di-n-alkyl-phthalates such as a mixture containing di-n-methyl-phthalate, di-n-ethyl-phthalate, di-n-propyl-phthalate, di-n-butyl-phthalate, di-n-hexyl-phthalate and di-n-heptyl-phthalate, which will cover the elution range from 70°C to 260°C . An arbitrary index of 100 is given to the di-n-methyl phthalate, 200 to the di-n-ethyl phthalate, and so on up to 700 to the di-n-heptyl phthalate; it is possible to identify all chlorinated pesticides by a proper retention index. This will be used also for unknown compounds which can be found easily on the GC/MS using the same index and so, identified. (Villeneuve J.P. 1986).

PCBs represent a complex mixture of compounds that cannot all be resolved on a packed column. Also there is no simple standard available for their quantification. Each peak in a sample chromatogram might correspond to a mixture of more than one individual compound. These difficulties have led to the recommendation of various quantification procedures. The usual method to quantify PCBs is to compare packed-column chromatograms of commercially available industrial formulations (Aroclors, Clophens, Phenoclor) with the sample chromatogram. Most commonly, it is possible to match one single formulation, such as Aroclor 1254 or Aroclor 1260 with the sample chromatogram. An industrial formulation (or mixture of formulations) should be chosen to be as close a match as possible and in the case of sample extracts from sediment or organisms, Aroclor 1254 and Aroclor 1260 are most frequently chosen.

For the second fraction obtained on Florisil separation, it is possible to quantify DDTs after comparison with the retention times of peaks in the sample chromatogram to those in the corresponding standard, the peak heights (or peak areas) are measured and related to the peak height (or peak area) in the standard according to the formula:

$$[\text{Concentration}] = \frac{h \times C \times V \times 1000}{h' \times V(\text{inj}) \times M \times R} \text{ ng/g (or pg/g)}$$

Where:

- V = total extract volume (ml)
- M = weight of sample extracted (g)
- H = peak height of the compound in the sample
- h' = peak height of the compound in the standard
- C = quantity of standard injected (ng or pg)
- V (inj) = volume of sample injected (µl)
- R = Recovery of the sample

7. COMPUTERIZED GAS CHROMATOGRAPHY/MASS SPECTROMETRY (GC/MS)

7.1. Operating conditions

The chemical ionisation source of a mass spectrometer can be used to produce negative ions by electron capture reactions (CI-NI-MS) using a non-reactive enhancement gas such as methane or argon. CI-NI has the advantage of being highly selective, permitting the detection of specific compounds in complex matrices. Under CI-NI conditions, methane (99.99 %) is used as the reagent gas. Samples are introduced through a SE-54, 30 m x 0.25 mm i.d., fused silica column. The film thickness used is 0.17 µm in order to minimise the bleeding of the phase into the system. Helium is used as carrier gas with an inlet pressure of 13 psi, which gives a carrier flow of 1.5 ml/min. or a gas velocity of 44 cm/sec.

The temperature of the injection port is held at 250°C.

The temperature of the source is set at 240°C, the quadrupole at 100°C and the interface at 285°C.

Injections of 1-3 µl are made in the splitless mode.

The temperature programme of the oven starts at 70°C, for 2 minutes, then it is increased at 3°C/min. to 260°C and kept under isothermal conditions for 40 minutes.

File : C:\HPCHEM\1\DATA\AR1254.D
Operator : jpv
Acquired : 12 Jul 95 8:02 am using AcqMethod OC
Instrument : 5989B
Sample Name: standard ar1254
Misc Info :
Vial Number: 1

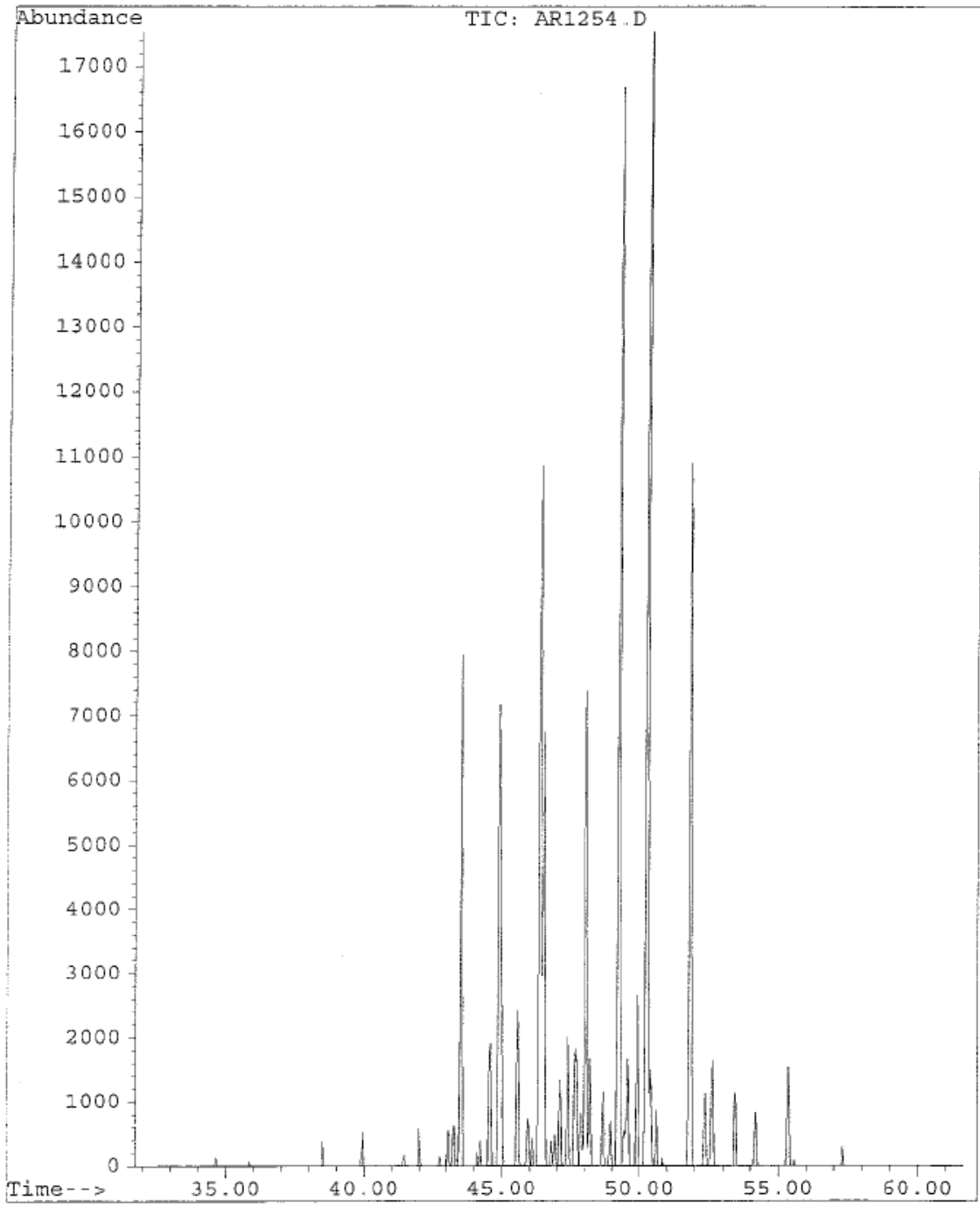

Figure 4: TIC of Aroclor 1254

File : C:\HPCHEM\1\DATA\AR1254.D
Operator : jpv
Acquired : 12 Jul 95 8:02 am using AcqMethod OC
Instrument : 5989B
Sample Name: standard ar1254
Misc Info :
Vial Number: 1

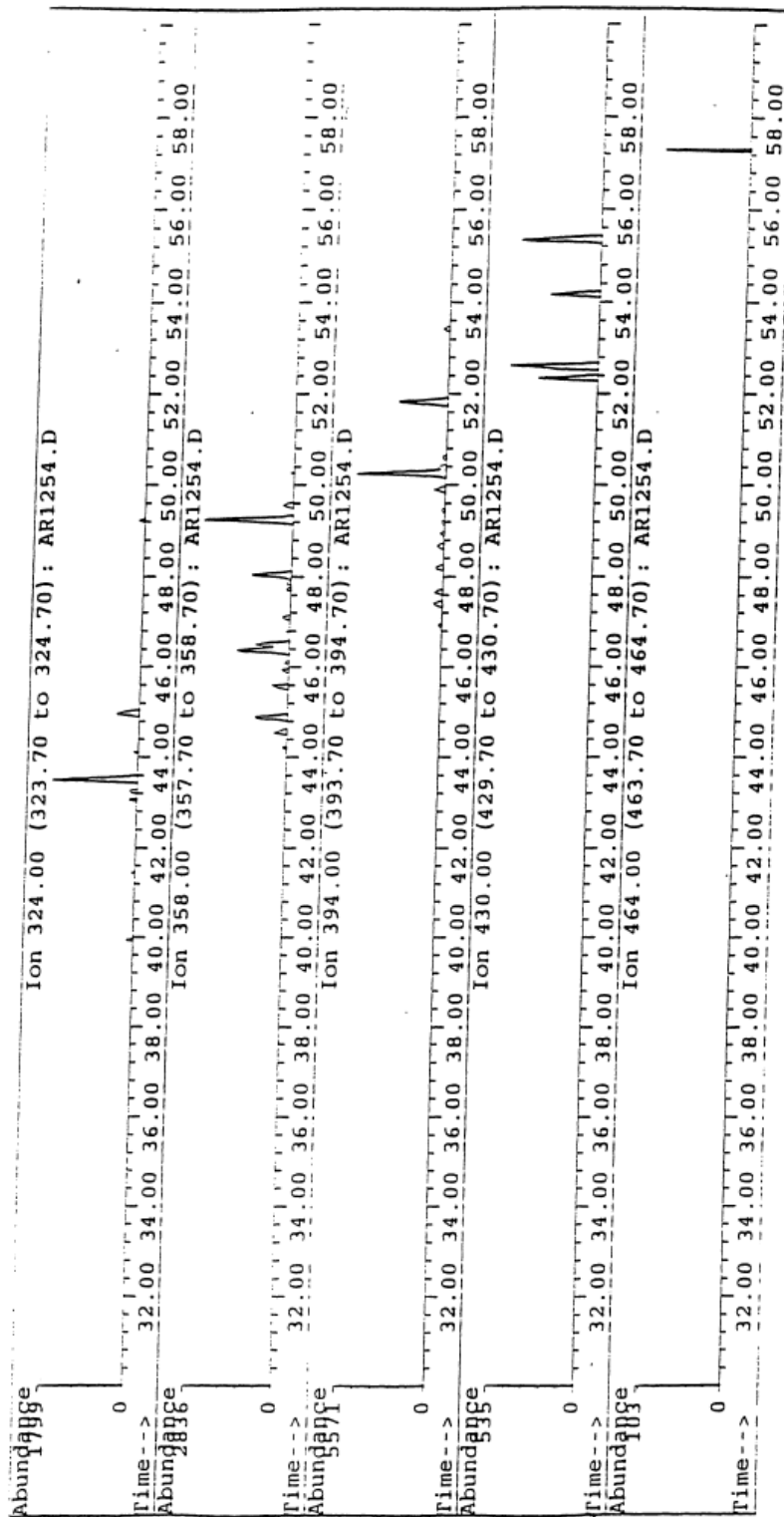

Figure 5: RIC of Aroclor 1254 main compounds

File : C:\HPCHEM\1\DATA\AR1260.D
Operator : jpv
Acquired : 12 Jul 95 9:42 am using AcqMethod OC
Instrument : 5989B
Sample Name: standard ar1260
Misc Info :
Vial Number: 1

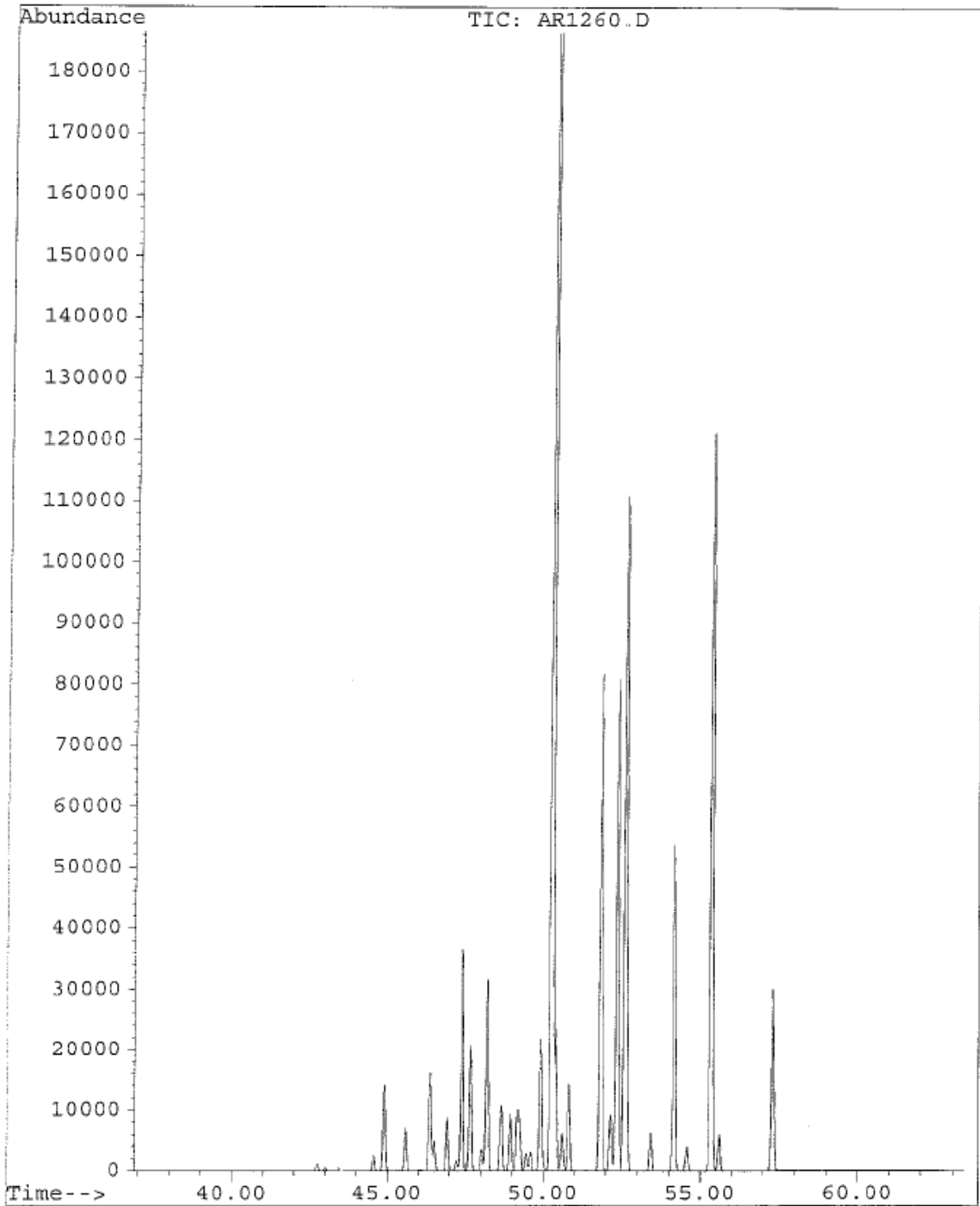

Figure 6: TIC of Aroclor 1260

File : C:\HPCHEM\1\DATA\AR1260.D
 Operator : jpv
 Acquired : 12 Jul 95 9:42 am using AcqMethod OC
 Instrument : 5989B
 Sample Name: standard ar1260
 Misc Info :
 Vial Number: 1

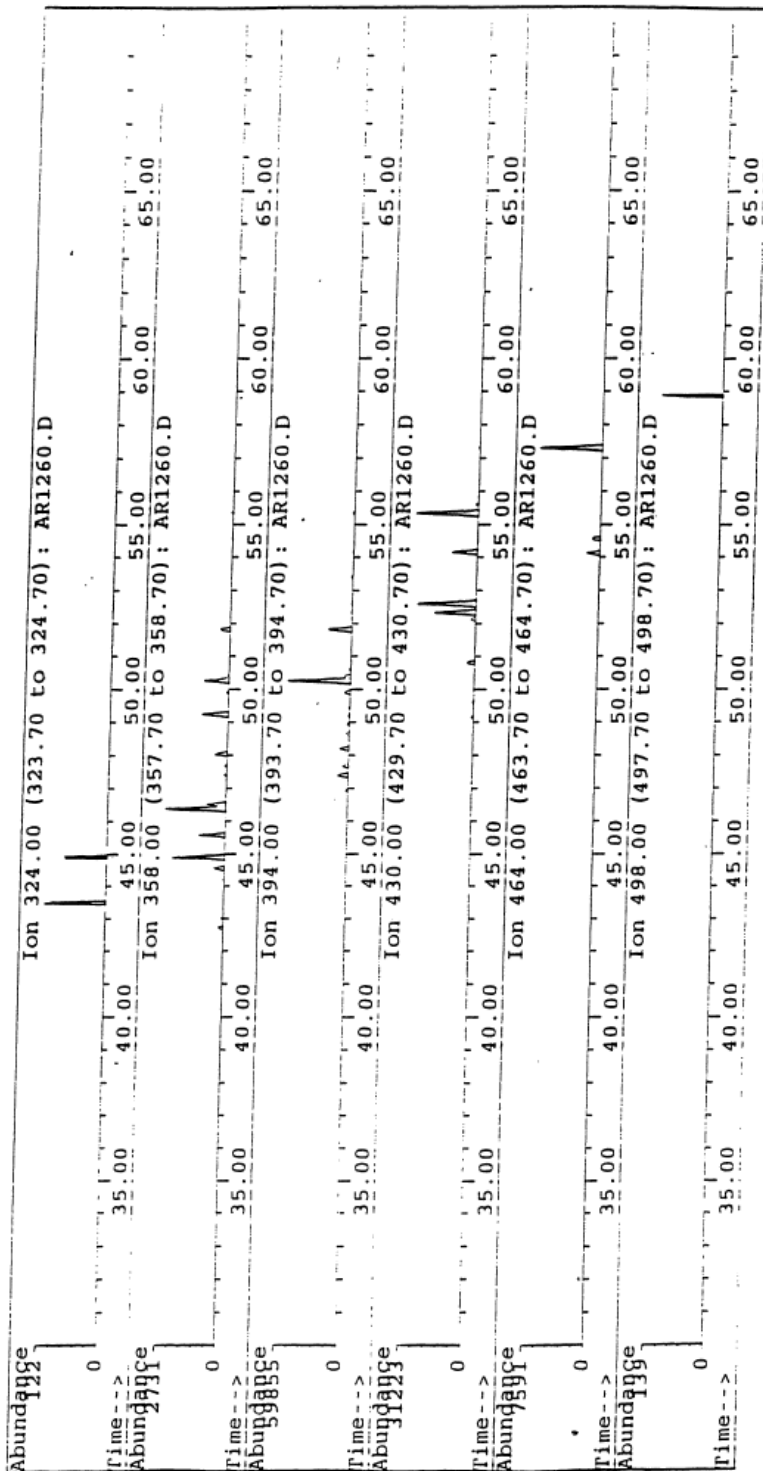

Figure 7: RIC of Aroclor 1260 main compounds

7.2. Example of a selected ion monitoring programme useful for quantitative analysis of chlorinated compounds.

Compounds	Fraction N° on Florisil	Retention Time (min.)	Target Ion (daltons)
HCB	1	37-38	284
Heptachlor	1	44-45	266
Aldrin	1	46-48	237
op DDE	1	51-53	246
Transnonachlor	1	52-54	444
pp' DDE	1	53-55	281
PCBs			
3 Cl	1		258
4 Cl	1		292
5 Cl	1	40-55	324
6 Cl	1	40-55	358
7 Cl	1	45-55	394
8 Cl	1	45-60	430
9 Cl	1	50-60	464
10 Cl	1	58-60	498
α HCH	2	37-39	255
β HCH	2	39-41	255
γ HCH (Lindane)	2	39-41	255
δ HCH	2	41-43	255
γ Chlordane	2	51-53	410
α Chlordane	2	52-54	266
op DDD	2	54-56	248
pp' DDD	2	56-58	248
op DDT	2	56-58	246
pp' DDT	2	58-60	283
Heptachlor epoxide	3	49-51	318
α Endosulfan	3	52-54	406
Dieldrin	3	53-55	346
Endrin	3	55-57	346
β Endosulfan	3	55-57	406
Endosulfan sulfate	3	58-60	386

8. NOTES ON WATER ANALYSIS

The levels of lipophilic compounds in tissues of aquatic organisms and organic fractions of sediments are determined to a large extent by the levels of these compounds in the surrounding water (marine mammals are an obvious exception). Data for CBs and hydrocarbons in sea water is therefore extremely useful for an understanding of the levels in organisms. However, the levels in sea water are extremely low and consequently, their determination needs considerable experience. Large volumes of water are required and extreme care has to be taken in order to avoid contamination during sampling, extraction and clean-up of the samples. Details are described in Manual and guide No 27 of IOC, 1993 and Villeneuve J.P. (1986).

9. ALTERNATIVE PROCEDURES

9.1. Combining sample preparation and extraction for chlorinated and petroleum hydrocarbons in sediment samples.

In the event that analyses for petroleum hydrocarbons and chlorinated compounds (and/or sterols) are of interest, the following extraction procedure can be used. To the freeze-dried sample introduce internal standards for each compound class. The following are suggested: 1) aliphatic hydrocarbons: - n-C₁₄ d₃₀, n-C₁₉ d₄₀, n-C₃₂ d₆₆, 2) polycyclic aromatic hydrocarbons: Naphthalene d₈,

Hexamethylbenzene, Cadalene (deuterated PAHs are also useful), 3) organochlorine compounds: PCB congeners 29, 30, 121 or 198, ϵ HCH and Endosulfan Id₄, 4) sterols: 5 α (H)-androstan-3 β -ol. These standards are used for quantifying the recovery of the total procedure. Samples are Soxhlet extracted for 8 hours with 250 ml of a mixture hexane / dichloromethane (50:50), cycling the solvent through at a rate of 4 to 5 cycles per hour. The solvent extract is concentrated by rotary evaporation down to 15 ml and transferred to a Kuderna-Danish tube. It is then further concentrated down to 5-6 ml under nitrogen gas. Following removal of sulphur and water, the extract is separated into aliquots: 1/3 for petroleum hydrocarbons and sterols and 2/3 for chlorinated hydrocarbons.

Note: Mercury method should be used only if chlorinated pesticides and PCBs are analysed. If the combined method is used for petroleum and chlorinated hydrocarbons, then the copper method should be used instead of mercury that will destroy some of the PAHs.

9.2. Supercritical fluid extraction (SFE) of marine samples

Sample preparation is probably the most time-consuming and labor-intensive analytical task performed in a laboratory. Studies shows that 60 % of the overall sample analysis time is spent in sample preparation which is the main source of error and of contamination. In addition, the amount of hazardous chemicals used for sample preparation is a continuous source of concern. Due to safe handling and disposal requirements, the reduction of their use is a priority for laboratories worldwide.

Supercritical fluids are gases (i.e. N₂O and CO₂) at room temperature and pressures above the critical point. The SFE technique allows an efficient extraction of a variety of contaminants with considerable reduction in the analysis cost, sample amount and allows the extraction of the thermal sensitive substances, reducing the amount of environmentally hazardous solvents.

A small change in the pressure of a supercritical fluid results in a big change in its density and the solvent strength of the fluid changes with changing density. As a result, one supercritical fluid easily performs the work of many solvents. If this is not enough, it is possible to add a modifier, such as methanol (a few per cent) to increase the solvating range of the fluid. Therefore, SFE should speed up the sample preparation process, minimising the wastes associated with the analysis.

Until now, the main fields of analytical applications of SFE are related to environmental studies and to the food-processing industry (Hawthorne, 1990, Bayona, 1993). A method using carbon dioxide (80°C-340 atm) for the extraction of total petroleum hydrocarbons has been approved as an EPA standard method. The extraction efficiency of modified CO₂ for the recovery of 41 organochlorine and 47 organophosphorus pesticides spiked on sand at different pressures and temperatures were higher than 80%. Furthermore, by increasing the extraction temperature up to 200°C, PCBs and PAHs can be extracted from naturally occurring samples with neat CO₂. Nam *et al.* (1991), have developed a method for rapid determination of polychlorinated organics in complex matrices. The method is based on direct coupling of supercritical fluid extraction with tandem supercritical fluid chromatography and gas chromatography. The on-line system permits simultaneous extraction and analysis with high reproducibility and accuracy.

Selection guide for CO₂ extraction of common pollutants (from Hewlett-Packard)

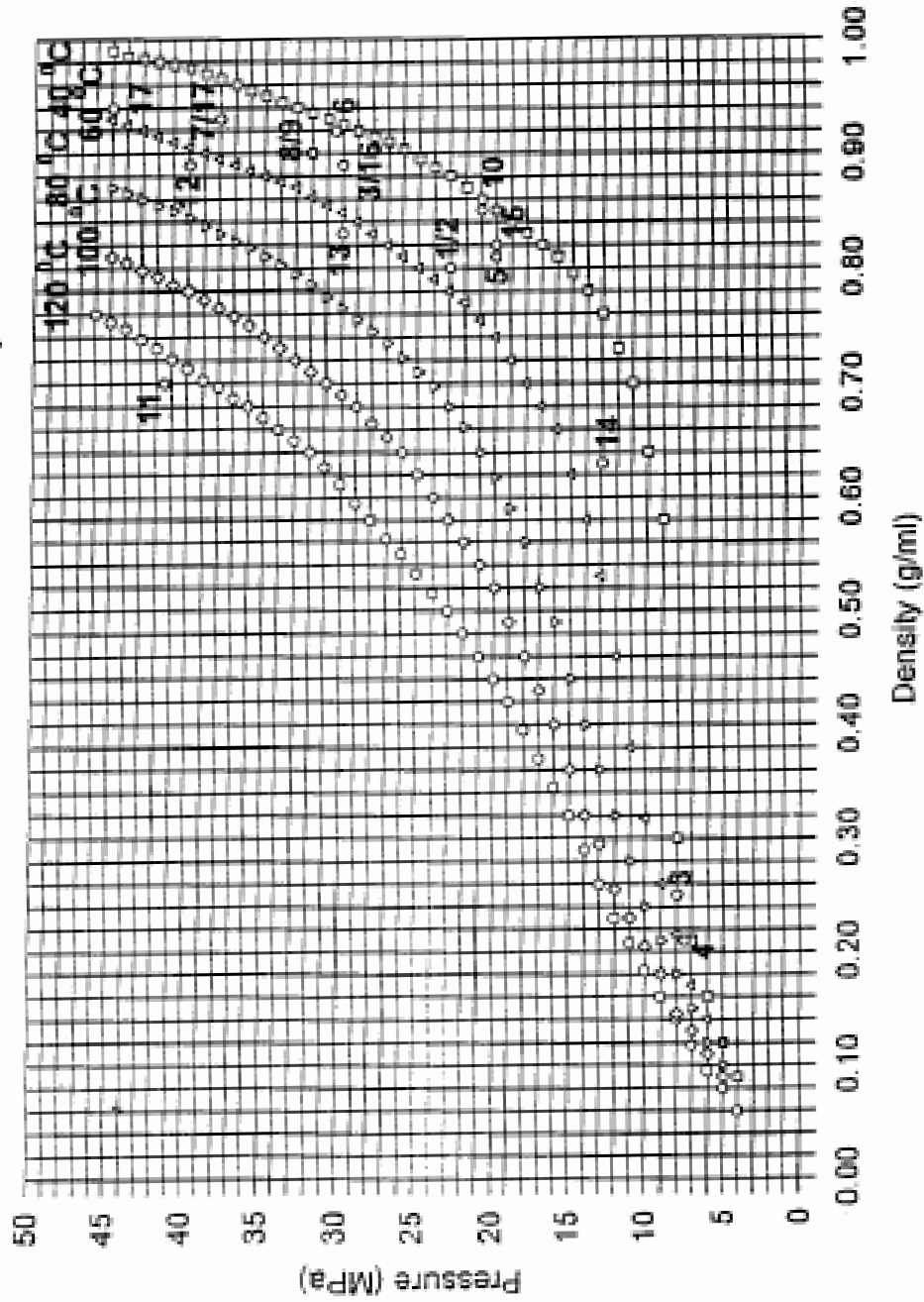

Figure 8: Guide for CO₂ extractions

9.3. Microwave assisted extraction for marine samples

9.3.1 Sediment

Another alternative method for the extraction of chlorinated hydrocarbons in sediment samples (or combined extraction for chlorinated hydrocarbons and petroleum hydrocarbons) is the use of the Microwave oven instead of the Soxhlet extractor. The main advantage of the microwave oven is the fact that, for one sample, only 40 ml of solvent mixture are used instead of 250 ml for clean-up of extraction thimbles and 250 ml for the extraction itself.

10 to 15 grams of freeze-dried sediment sample, ground and sieved at 250 µm, are put in the glass tube of the reactor. Appropriate internal standards (for OCs and/or PHs, see 10.1.) are added to the sample for recovery and samples are extracted with 40 ml of a mixture of hexane / dichloromethane (50:50).

Extraction is realised within the following cycle:

- Power of the microwaves: 1200 watts
- Temperature increase to 115 °C in 10 minutes.
- Extraction maintained at 115 °C for 30 minutes
- Cooling to ambient temperature within one hour.

The carousel containing 14 reactors, 12 samples could be extracted together with one blank and one Reference Material within 1 and half hour and with 10 times less solvent mixture than the standard Soxhlet extraction.

After cooling down to room temperature the solvent mixture is recovered in a 100 ml glass flask. The sediment is poured in a glass funnel containing a plug made of glass wool. The extracted sediment is washed with 10 - 20 ml of hexane. The extract follows then the procedure of clean-up and fractionation.

9.3.2 Biota

3 to 8 grams of freeze-dried biota sample is accurately weighted, the weight to be extracted is noted, and it is placed into the pre-cleaned glass tube of the reactor. A known amount of internal standard is added to the sub-sample in the tube before extraction. Candidate internal standards are the same than for sediment samples refers to section (5.3.1.)

Extraction is realized with 30 ml of a mixture hexane / acetone (90:10) within the following cycle:

- Power of the microwaves: 1200 watts
- Temperature increase to 115 °C in 10 minutes.
- Extraction maintained at 115 °C for 20 minutes
- Cooling to ambient temperature within one hour.

The carousel containing 14 reactors, 12 samples could be extracted with one blank and one Reference Material within 1 and half hour and with 10 times less solvent mixture than the standard Soxhlet extraction.

After cooling down to room temperature the solvent mixture is recovered in a 100 ml glass flask. The powder of biota is poured in a glass funnel containing a plug made of glass wool. The extracted biota is washed with 10 - 20 ml of hexane. The extract is then concentrated with rotary evaporator and ready for E.O.M, clean-up and fractionation procedure.

10. DATA INTERPRETATION

10.1. DDT

The residence time of total DDT in the environment is relatively short ($t_{1/2} = 3-5$ years), so, at least 75-80 % of the current total DDT should be in the form of DDE or DDD if it was introduced into the environment before the 1975 ban. Values of Henry's law constant indicate that these compounds can reach the troposphere as vapour. These vapours are little adsorbed by airborne particulate matter and represent the major component in atmospheric chlorinated hydrocarbon levels. Vapour movements of these pollutants suggest that restrictions and regulations operating in the more technically advanced countries could only be partially effective on a worldwide basis.

The presence of the *op* DDT together with anomalous *pp'* DDT values in environmental samples indicates a recent treatment with this insecticide.

10.2. PCBs congeners

Among the 209 possible PCB congeners, seven of them: 28, 52, 101, 118, 138, 153 and 180, were selected as the most relevant because of their distribution in the chromatogram and in the chlorination range.

Recently, attention has been paid to congeners having 2 *para*-chlorines and at least 1 *meta*-chlorine. These congeners are called "coplanar" PCBs. Among the 209 congeners, 20 members attain coplanarity due to non-ortho chlorine substitution in the biphenyl ring. Three of these show the same range of toxicity as the 2,3,7,8 tetrachlorodibenzo-*p*-dioxin and the 2,3,7,8 tetrachlorodibenzofuran, these are the IUPAC N^o: 77, 126 and 169. These compounds should be identified and quantified in the environmental samples with high priority. They can be separated using fractionation with carbon chromatography (Tanabe *et al.*, 1986).

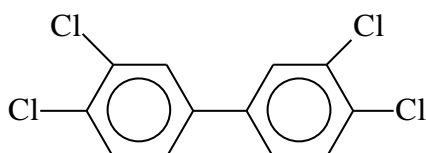

3,3',4,4' tetrachlorobiphenyl
IUPAC N^o: 77

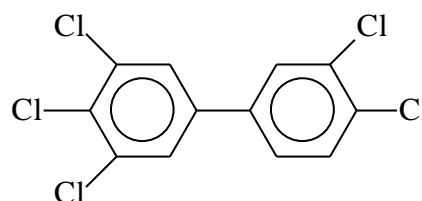

3,3',4,4',5 pentachlorobiphenyl
IUPAC N^o: 126

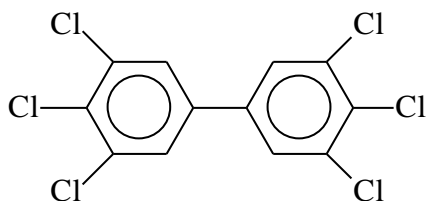

3,3',4,4',5,5' hexachlorobiphenyl
IUPAC N^o: 169

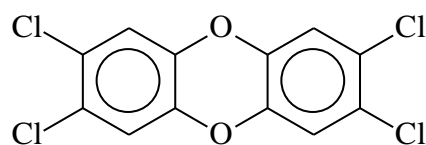

2,3,7,8 tetrachlorodibenzo-*p*-dioxin

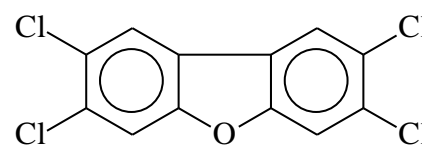

2,3,7,8 tetrachlorodibenzofuran

10.3. Typical profiles of commercial mixtures

Formulations available in different countries are slightly different in their composition (Aroclor in USA, Kanechlor in Japan, Clophen in Germany, Phenoclor in France, Fenclor in Italy or Sovol in Russia). For the same global composition, such as Aroclor 1254, KC-500 or Phenoclor DP-5, the composition of individual congeners differs by 5-10 %. If a sample is collected on the French coast (therefore, contaminated with DP-5), and is quantified with DP-5 and Aroclor 1254, the difference observed in concentration could be in the order of 5-10 %. This shows the importance of choosing one common standard for the quantification of global industrial formulations or the importance of quantifying with individual congeners.

Percent contribution of individual chlorobiphenyls to Clophen A 50 and Aroclor 1254.

PCB N°	Clophen A50	Aroclor 1254	PCB N°	Clophen A50	Aroclor 1254
17	0	0.19	115	0.28	0.3
18	0	0.41	118	10.9	6.39
28	0.05	0.25	119	0.19	0.14
31	0.05	0.22	122	0.19	0.5
33	0.11	0.14	123	0.85	0.81
40	0.28	0.2	126	0.08	0
41	0.83	0.64	128	3.04	2.07
42	0.13	0.23	129	0.83	0.23
44	2.46	2.03	130	0.83	0.63
47	0.18	0.11	131	0.06	0.16
48	0.17	0.14	132	2.57	1.98
49	1.96	1.64	134	0.52	0.49
52	5.53	5.18	135	1.61	1.62
53	0.06	0.09	136	0.91	1.12
56	0.44	0.58	137	0.25	0.25
60	0.34	0.54	138	3.61	3.2
63	0.15	0.05	141	0.98	1.04
64	0.71	0.45	146	0.8	0.83
66	0.5	0.59	149	4.5	2.21
67	0.13	0.09	151	1.22	1.17
70	3.85	3.21	153	4.17	4.26
74	1.35	0.78	156	1.43	1.62
82	1.05	0.95	157	0.31	0
83	0.53	0.45	158	0.98	0.77
84	2.08	1.95	167	0.35	0.21
85	1.85	1.66	170	0.65	0.31
87	4.22	3.78	171	0.5	0.5
90	0.85	0.93	172	0.09	0.05
91	0.92	0.83	173	0.09	0.09
92	1.53	1.58	174	0.37	0.34
95	6	6.02	175	0.11	0.05
96	0.05	0.08	176	0.43	0.32
97	2.8	2.55	177	0.21	0.21
99	4.06	3.6	178	0.19	1.35
100	0.15	0.1	179	0.2	0.21
101	7.72	7.94	180	0.53	0.38
105	1.9	3.83	183	0.21	0.17
107	0.94	0.72	187	0.3	0.32
110	6.27	5.85	190	0.05	0.08
			201	0.6	0.68

11. QUALITY ASSURANCE / QUALITY CONTROL

Guidelines on the QA/QC requirements for analysis of sediments and marine organisms are detailed in Reference Method No 57, "Contaminant monitoring programs using marine organisms: Quality assurance and good laboratory practice". Brief descriptions of issues that must be addressed in the course of understanding the procedures described here are given below.

11.1. Precision

The precision of the method should be established by replicate analysis of samples of the appropriate matrix. Estimate the precision of the entire analytical procedure by extracting five sub-samples from the same sample after homogenisation. Alternatively, perform replicate analysis of an appropriate certified reference material (RM; see below) containing the analytes of interest. The principal advantage of using a RM is that the material permits the simultaneous evaluation of accuracy while offering a well homogenised sample. Precision should be evaluated as a matter of course during the initial implementation procedure just before initiation of sample analysis.

11.2. Accuracy

The accuracy of the methods described here must be confirmed by analysis of a suitable RM (i.e. appropriate matrix, analytes) prior to initiation of sample analysis. Agreement between measured and certified concentrations for any individual analyte should be within 35 % and on average within 25%. It is advisable to introduce RMs on a regular basis (e.g. every 10-20 samples) as a method of checking the procedure. Further description of the preparation of control charts and criteria for data acceptance are discussed in Reference Method N° 57.

11.3. Blanks

Blanks represent an opportunity to evaluate and monitor the potential introduction of contaminants into samples during processing. Contributions to the analyte signal can arise from contaminants in the reagents, those arising from passive contact between the sample and the environment (e.g. the atmosphere) and those introduced during sample handling by hands, implements or glassware. It is essential to establish a consistently low (i.e. with respect to analytes) blank prior to initiating analysis or even the determination of the method detection limit. In addition, it is necessary to perform blank determinations on a regular basis (e.g. every batch of samples).

11.4. Recovery

Recovery reflects the ability of the analyst to fully recover surrogate compounds introduced to the sample matrix or blank at the beginning of the procedure. The primary criteria for selection of compounds to be used for testing recovery are that they: 1) have physical (i.e. chromatographic/partitioning) properties similar to and if necessary spanning those of the analytes of interest, 2) do not suffer from interferences during gas chromatographic analysis, 3) are baseline resolved from the analytes of interest.

Recovery should be tested on all samples and blanks as a routine matter of course. Recoveries below 70% are to be considered unacceptable. Recoveries in excess of 100 % may indicate the presence of interference.

11.5. Archiving and reporting of results

Every sample should have an associated worksheet which follows the samples and the extracts through the various stages of the procedure and upon which the analyst notes all relevant details. An example of such a worksheet is given below. Each laboratory should construct and complete such a worksheet. Relevant chromatograms should be attached to the worksheet. Analyses should be grouped

and composite or summary analysis sheets archived with each group. Final disposal of the data will depend on the reasons for which it was collected but should follow the overall plan model.

All processed samples should be archived at all steps of the procedure:

- deep frozen (in the deep-freezer as it was received).
- freeze-dried (in sealed glass container kept in a dark place).
- extracted (after injection on the GC, sample extracts should be concentrated down to 1 ml and transferred into sealed glass vials, a Pasteur pipette sealed with a butane burner is adequate and cheap).

Sample: IAEA-357 : Marine Sediment

wet wt.

----- =, % water in freeze dried sample determined by drying at 105°C :
dry wt.

.....g freeze-dried wt. extracted with hexane in Soxhlet extractor for 8 hours.

.....pg PCB N°29,pg PCB N°198,pg ϵ HCH and pg Endosulfan Id₄ were added as internal standard.

Theml extract was reduced by rotary evaporator to approximatelyml.

This was treated with sodium sulfate to dry the extract. Then treated with mercury to remove sulphur. This was further reduced toml for lipid determinations. Corrected dry wt. :g.

Lipid determinations:

.....ml total extract;

10 μ l aliquots weighed on micro-balance:mg;mg;mg.

HEOM =mg/g dry weight.

.....mg lipid subjected to column chromatography fractionation on Florisil.

F1:ml hexane

F2:ml hexane/dichloromethane (70:30)

F3:ml dichloromethane

GC determinations:

PCB N°29 :ng recovered in F1 :% Recovery.

PCB N°198 :ng recovered in F1 :% Recovery.

ϵ HCH :ng recovered in F2 :% Recovery.

Endosulfan Id₄:ng recovered in F3 :% Recovery.

Attach tabulation of individual compounds quantified in sample.

Sample worksheet for analysis of chlorinated compounds in marine sediments.

12. REFERENCES

- Bayona, J.M. (1993). The role of supercritical fluid extraction in sample preparation. *Robotics Lab. Autom.* 5, 156-187.
- Eganhouse, R.P. and Kaplan, I.R. (1988). Depositional history of recent sediments from San Pedro shelf, California: Reconstruction using elemental abundance, isotopic composition and molecular markers. *Mar. Chem.*, 24 (2), 163-191.
- Eisenreich, S.J., Capel, P.D., Robbins, J.A. and Bourbonniere, R. (1989). Accumulation and diagenesis of chlorinated hydrocarbons in lacustrine sediments. *Environ. Sci. and Technol.*, 23, 1116-1126.
- Ericksson, M.D. (1986). *Analytical Chemistry of PCBs*, Butterworth, Stonehaus, 149-153.
- Fernandez, P., Porte, C., Barcelo, D., Bayona, J.M. and Albaiges, J. (1988). Selective enrichment procedures for the determination of polychlorinated biphenyls and polycyclic aromatic hydrocarbons in environmental samples by gel permeation chromatography. *J. Chromatogr.* 456, 155-164.
- Fernandez, P. and Bayona, J.M. (1992). Use of off-line gel permeation chromatography - normal phase liquid chromatography for the determination of polycyclic aromatic compounds in environmental samples and standard reference materials (air particulate matter and marine sediment). *J. Chromatogr.*, 625, 141-149.
- Hawthorne, S.B. (1990). Analytical-scale supercritical fluid extraction, *Anal. Chem.*, 62, 633A-642A.
- Hom, W., Risebrough, R.W., Soutar, A. and Young, D.R. (1974). Deposition of DDE and polychlorinated biphenyls in dated sediments of the Santa Barbara basin. *Science*, 184, 1197-1199.
- Langenfeld, J.J., Hawthorne, S.B., Miller, D.J. and Pawliszyn, J. (1993). Effects of temperature and pressure on supercritical fluid extraction efficiencies of polycyclic aromatic hydrocarbons and polychlorinated biphenyls. *Anal. Chem.* 65, 338-344.
- Lee, M.L., Novotny, M.V. and Bartle, K.D. (1981), in *Analytical Chemistry of Polycyclic Aromatic Compounds*, Academic Press, New York, 143-152.
- Lopez-Avila, V., Dohiwala, N.S. and Beckert, W.F. (1990). "Supercritical fluid extraction and its applications to environmental analysis. *J. Chromatogr. Sci.* , 28, 468-79.
- Lopez-Avila, V., Benedicto, J., Dohiwala, N.S., Young, R. and Beckert, W.F. (1992). Development of an off-line SFR-IR method for petroleum hydrocarbons in solids. *J. Chromatogr. Sci.*, 30, 335-343.

Manuals and Guides No 27. IOC (1993).

- Nam, K.S., Kapila, S., Yanders, A.F. and Puri, R.K. (1991). A multiple sample extraction and on-line system for the analysis of chlorinated compounds. *Chemosphere*, 23, 1109-1116.
- Petrick, G., Schulz, D.E. and Duinker, J.C. (1988). Clean-up of environmental samples by high-performance liquid chromatography for analysis of organochlorine compounds by gas chromatography with electron-capture detection. *J. Chromatogr.*, 435, 241-248.
- Reference Method No 6, UNEP/FAO/IOC/IAEA: Guidelines for monitoring chemical contaminants in the sea using marine organisms. UNEP, 1993.
- Reference Method No 12 Rev.2, UNEP/FAO/IOC/IAEA: Sampling of selected marine organisms and sample preparation for the analysis of chlorinated hydrocarbons. UNEP, 1991.
- Reference Method No 20, UNEP/IOC/IAEA: Determination of petroleum hydrocarbons in sediments. UNEP, 1992.
- Reference Method No 57, UNEP/IOC/IAEA/FAO: Contaminant monitoring programme using marine organisms: Quality assurance and good laboratory practice. UNEP, 1990.

- Reference Method No 58: Guidelines for the use of sediments for marine pollution monitoring programmes. (in preparation).
- Reference Method No 65, UNEP/IOC/IAEA: Reagent and laboratory ware clean-up procedures for low-level contaminants monitoring. (in preparation).
- Tanabe, S., Kannan, N., Wakimoto, T. and Tatsukawa, R. (1986). Method for the determination of three toxic non-ortho-chlorine substituted co-planar PCBs in environmental samples at part-per-trillion levels. *Intern. J. Environ. Anal. Chem.* Vol. 29, 199-213.
- UNEP (DEC)/MED WG.282/Inf.5/Rev1: Methods for sediment sampling and analysis (2006).
- Villeneuve, J.P. (1986). *Géochimie des composés organochlorés dans l'environnement marin*. Thèse de Doctorat de l'Université Paris VI. 180 pages.

ANNEX

**PREPARATION OF THE SOLUTION OF INTERNAL STANDARDS:
PCB No 29, PCB No 198, ϵ HCH and Endosulfan I d4**

Stock Solution of PCB No 29:

1 ml from the original vial (250ng/ μ l) should be transferred into a 100 ml volumetric flask, and then the volume is adjusted to 100 ml with hexane. This stock solution contains:

2.5 ng/ μ l of PCB No 29

Stock Solution of Endosulfan I d4:

1 ml from the original vial (250ng/ μ l) should be transferred into a 100 ml volumetric flask, and then the volume is adjusted to 100 ml with hexane. This stock solution contains:

2.5 ng/ μ l of Endosulfan I d4

Working solution of internal standards:

0.5 ml from the stock solution of PCB No 29 (2.5 ng/ μ l) should be transferred into a 50 ml volumetric flask, then, 0.5 ml from the stock solution of Endosulfan I d4 (2.5 ng/ μ l) should be transferred into the volumetric flask, then 1 ml from the original vial (1ng/ μ l) of ϵ HCH should be transferred into that volumetric flask, then 0.5 ml from the concentrated solution (2ng/ μ l) of PCB No 198, and the volume adjusted to 50 ml with hexane. This working solution contains:

25 pg/ μ l of PCB No 29

20 pg/ μ l of PCB No 198

20 pg/ μ l of ϵ HCH

25 pg/ μ l of Endosulfan I d4

CAUTION: VIALS SHOULD BE COOLED AT 20°C PRIOR TO OPENING

Preparation of the Aroclor 1254 solution

Preparation of the stock solution:

1 ml from the original vial should be transferred into a 100 ml volumetric flask, then, the volume is adjusted to 100 ml with hexane. This stock solution contains:

6.5 ng/μl of Aroclor 1254

Preparation of the working solution:

1 ml from this stock solution should be transferred into a 50 ml volumetric flask and the volume adjusted to 50 ml with hexane. This working solution contains :

0.13 ng/μl of Aroclor 1254

CAUTION : VIAL SHOULD BE COOLED TO 20 °C PRIOR TO OPENING

Preparation of the Aroclor 1260 solution

Preparation of the stock solution:

1 ml from the original vial should be transferred into a 100 ml volumetric flask, then the volume is adjusted to 100 ml with hexane. This solution contains:

5.44 ng/μl of Aroclor 1260

Preparation of the working solution:

1 ml from the stock solution should be transferred into a 50 ml volumetric flask, then the volume is adjusted to 50 ml with hexane. This working solution contains

0.1088 ng/μl of Aroclor 1260

CAUTION: VIAL SHOULD BE COOLED TO 20 °C PRIOR TO OPENING

Preparation of the pp' DDE, pp' DDD and pp' DDT solution

pp' DDE:

Stock solution: 1 ml from the original vial should be transferred into a 100 ml volumetric flask, then the volume is adjusted to 100 ml with hexane. This stock solution contains:

5 ng/μl of pp' DDE

pp' DDD:

Stock solution: 1 ml from the original vial should be transferred into a 100 ml volumetric flask, then the volume is adjusted to 100 ml with hexane. This solution contains:

5 ng/μl of pp' DDD

pp' DDT:

Stock solution: 1 ml of the original vial should be transferred into a 100 ml volumetric flask, then the volume is adjusted to 100 ml with hexane. This stock solution contains:

5 ng/μl of pp' DDT

Working solution: pp' DDE, pp' DDD and pp' DDT together.

1 ml from the stock solution of pp' DDE, 2 ml of the stock solution of pp' DDD and 3 ml of the stock solution of pp' DDT should be transferred into a 100 ml volumetric flask and the volume adjusted to 100 ml with hexane. This solution contains

- pp' DDE : 50 pg/μl
- pp' DDD : 100 pg/μl
- pp' DDT : 150 pg/μl

NOTE: Further dilution may be necessary depending on the sensitivity of the EC Detector.

CAUTION: VIAL SHOULD BE COOLED TO 20 °C PRIOR TO OPENING

Preparation of Aldrin, Dieldrin and Endrin standard solutions:

Aldrin:

Stock solution: 1 ml from the original vial should be transferred into a 100 ml volumetric flask, then the volume is adjusted to 100 ml with hexane. This solution contains:

5 ng/μl of Aldrin

Dieldrin:

Stock solution: 1 ml from the original vial should be transferred into a 100 ml volumetric flask, then the volume is adjusted to 100 ml with hexane. This solution contains:

5 ng/μl of Dieldrin

Endrin:

Stock solution: 1 ml from the original vial should be transferred into a 100 ml volumetric flask, then the volume is adjusted to 100 ml with hexane. This solution contains:

5 ng/μl of Endrin

Working solution: Aldrin, Dieldrin and Endrin together.

1 ml from the stock solution of Aldrin, 1 ml from the stock solution of Dieldrin and 1 ml from the stock solution of Endrin are transferred into a 100 ml volumetric flask and the volume is adjusted to 100 ml with hexane. This working solution contains:

Aldrin : 50 pg/μl
Dieldrin : 50 pg/μl
Endrin : 50 pg/μl

NOTE: Further dilution may be necessary depending on the sensitivity of the detector.

CAUTION: VIALS SHOULD BE COOLED TO 20 °C PRIOR TO OPENING

Preparation of the HCB and Lindane standard solutions:

HCB:

Stock solution: 1 ml from the original vial should be transferred into a 100 ml volumetric flask, then the volume is adjusted to 100 ml with hexane. This solution contains:

5 ng/μl of HCB

Lindane:

Stock solution: 1 ml from the original vial should be transferred into a 100 ml volumetric flask, then the volume is adjusted to 100 ml with hexane. This solution contains:

5 ng/μl of lindane

Working solution:

1 ml from the stock solution of HCB and 1 ml from the stock solution of Lindane are transferred into a 100 ml volumetric flask, then the volume is adjusted to 100 ml with hexane. This solution contains:

HCB : 50 pg/μl
Lindane : 50 pg/μl

NOTE: further dilution may be necessary depending on the sensitivity of the EC Detector.

CAUTION: VIALS SHOULD BE COOLED TO 20 °C PRIOR TO OPENING

Preparation of the PCB congeners solution

In a 100 ml volumetric flask, transfer 1 ml from the original vial. Adjust to 100 ml with hexane in order to obtain the working solution with the following concentrations:

CB N°:	Compounds:	Concentrations (pg/μl)
8	2,4'	17.50
18	2,2',5	12
31	2,4',5	10.6
28	2,4,4'	4.6
52	2,2',5,5'	8.6
49	2,2',4,5'	12.1
44	2,2',3,5'	10.7
66	2,3',4,4'	5.5
95	2,2',3,5',6	5.7
101	2,2',4,5,5'	9.3
110	2,3,3',4',6	11.1
149	2,2',3,4',5',6	12.1
118	2,3',4,4',5	8.5
153	2,2',4,4',5,5'	8.4
138	2,2',3,4,4',5'	13.8
183	2,2',3,4,4',5',6	10.3
174	2,2',3,3',4',5,6'	9.4
177	2,2',3,3',4',5,6	9.5
180	2,2',3,4,4',5,5'	16.3
170	2,2',3,3',4,4',5	13.4
199	2,2',3,3',4,5,5',6'	9.3
194	2,2',3,3',4,4',5,5'	12.6

Separate into 10 volumetric flasks of 10 ml, seal with Teflon tape and keep in refrigerated place in order not to evaporate them.

CAUTION: VIAL SHOULD BE COOLED TO 20 °C PRIOR TO OPENING

EUNOCI 221-02937-0, E05 SED @ BHIMADZU

14:241	15.223	15.961	17.859	19.88	21.880	21.728	22.598	25.523	8	34.133	56.927	31	58.927	49	62.827	66 + 95	65.511	66.928	101	68.501	52	68.927	49	62.827	44	62.827	66 + 95	65.511	66.928	101	68.501	110	149	71.867	72.791	153	72.791	138	74.828	183	76.747	174	76.194	180	78.298	170	80.298	179	82.178	84.751	86.664	86.664	194
--------	--------	--------	--------	-------	--------	--------	--------	--------	---	--------	--------	----	--------	----	--------	---------	--------	--------	-----	--------	----	--------	----	--------	----	--------	---------	--------	--------	-----	--------	-----	-----	--------	--------	-----	--------	-----	--------	-----	--------	-----	--------	-----	--------	-----	--------	-----	--------	--------	--------	--------	-----

Issued and printed by

Oceans and Coastal Areas Programme Activity Centre
United Nations Environment Programme

Additional copies of this and other publications issued by
the Oceans and Coastal Areas Programme Activity Centre
can be obtained from:

Oceans and Coastal Areas Programme Activity Centre
United Nations Environment Programme
P.O. Box 30552
Nairobi
Kenya

Or from:

Marine Environmental Studies Laboratory
International Atomic Energy Agency
Environment Laboratories
4 Quai Antoine 1^{er}
98000 MONACO

Annex V:

UNEP/IAEA (2011b). Recommended method on the determination of petroleum hydrocarbons in sediment samples (4.2.4)



RECOMMENDED METHOD ON THE DETERMINATION OF PETROLEUM HYDROCARBONS IN SEDIMENT SAMPLES

NAEL/Marine Environmental Studies Laboratory in co-operation with MED POL

November 2011

For further information on this method, please contact:

IAEA-Environment Laboratories
Marine Environmental Studies Laboratory
4a Quai Antoine 1er
MC-98000 Principality of Monaco

Tel. (377) 979 772 72; Fax. (377) 979 772 76

E-mail: NAEL-MESL.Contact-Point@iaea.org

RECOMMENDED METHOD ON THE DETERMINATION OF PETROLEUM
HYDROCARBONS IN SEDIMENT SAMPLES

DISCLAIMER

This is not an official IAEA publication. The views expressed do not necessarily reflect those of the International Atomic Energy Agency or its Member States.

The material has not undergone an official review by the IAEA. This document should not be quoted or listed as a reference.

The use of particular designations of countries or territories does not imply any judgment by the IAEA, as to the legal status of such countries or territories, of their authorities and institutions or of the delimitation of their boundaries.

The mention of names of specific companies or products (whether or not indicated as registered) does not imply any intention to infringe proprietary rights, nor should it be construed as an endorsement or recommendation on the part of the IAEA.

Limited Distribution

Reproduced by the IAEA

TABLE OF CONTENTS

1. Sampling	1
2. General discussion.....	1
3. Apparatus	1
4. Reagents	2
4.1. List of reagents.....	2
4.2. Cleaning of reagents and adsorbents.....	3
4.2.1. Cleaning of reagents.....	3
4.2.2. Cleaning of adsorbents.....	3
4.2.3. Cleaning of glassware	4
5. Procedure.....	4
5.1. Extraction of freeze-dried samples.....	4
5.1.1. Cleaning of extraction thimbles	4
5.2. Concentration of the extract.....	5
5.3. Extractable organic matter (EOM).....	5
5.4. Clean-up procedure and fractionation.....	5
5.4.1. Sulfur and sulfur compounds removal	5
5.4.2. Fractionation.....	6
5.4.3. Fractionation: Alternative Method using SPE columns	6
6. Gas Chromatography Conditions	7
6.1. Quantification of petroleum hydrocarbons	7
6.2. Quantification of PAHs.....	7
6.3. Target and Confirmation ions for GC/MS analyses of PAHs	8
7. Quantification.....	10
7.1. External Calibration.....	10
7.2. Internal Calibration.....	10
8. Quality assurance/quality control.....	12
8.1. Accuracy	12
8.2. Blanks	12
8.3. Recovery	12
8.4. Archiving and reporting of results	13
9. References.....	13

NOTE: This recommended method is not intended to be an analytical training manual. Therefore the method is written with the assumption that it will be used by formally trained analytical chemists. Several stages of this procedure are potentially hazardous; users should be familiar with the necessary safety precautions.

1. SAMPLING

Detailed guidelines for collecting the sediment samples are available in UNEP(DEC)/MEDWG.282/Inf.5/Rev.1

2. GENERAL DISCUSSION

Following collection of sediment samples using appropriate techniques, samples are stored in non-contaminating jars at -20 °C until analysis. For analysis, the samples are defrosted and prepared for solvent extraction. To achieve a satisfactory recovery of the petroleum hydrocarbons, samples are freeze-dried. Sediments are then Soxhlet extracted using hexane and dichloromethane. Following initial clean-up treatments (removal of sulfur), extracts are fractionated using column chromatography with silica and alumina. Quantification is done by GC-FID and GC-MS.

3. APPARATUS

- A coring device with liners and plunger or a grab sampler. Thoroughly cleaned with detergents and solvents before use.
- Glass jars and aluminium foil, stainless steel knives, scoops, forceps, labels, marking pens, log book.
- Insulated plastic boxes for transporting samples. Ice or dry ice.
- Deep freezer (-18 to -20°C) for sample preservation (frost free type freezers heat to above zero during frost removal cycles and they cannot be used for long term storage).
- Rotary evaporator.
- Soxhlet extraction apparatus and heaters.
- Microwave oven.
- Glassware including boiling flasks, ground glass stoppers, beakers, Erlenmeyer flasks, separatory funnels, centrifuge tubes, weighing bottles, pipettes, tissue grinders.

- Drying oven (temperature range up to at least 300 °C) for determining sample dry weights, baking of contaminant residues from glassware and reagents.
- Centrifuge and tubes.
- Freeze-dryer and porcelain mortar and pestle.
- Analytical balance with a precision of 0.1 mg and an electro-balance with a precision of at least 1 µg.
- Stainless steel tweezers and spatulas.
- Dessicator - completely cleaned and with no grease applied to sealing edges.
- Supply of clean dry nitrogen.
- Columns for the silica/alumina chromatography.
- Mechanical blender (food mixer).
- Vacuum pump (water-jet air pump).
- Ultrasonic bath.
- Solid Phase Extraction glass columns: Upti-Clean SPE Glass Columns Si/CN-S (1g/0.5g)/6ml-PTFE Frits
- 12 or 24 ports Glass Vacuum manifold for simultaneous use of multiple SPE columns. Manifold must be fitted with flow control valves to allow a fine adjustment of flow through the SPE column.

4. REAGENTS

4.1. LIST OF REAGENTS

- Demineralized distilled water produced by distillation over potassium permanganate (0.1 g KMnO_4 per liter) or equivalent quality, demonstrated free from interfering substances.
- Detergent.
- Sulfochromic cleaning solution made from concentrated sulfuric acid and potassium dichromate.
- Concentrated H_2SO_4 (d 20°C: 1.84 g/ml).
- Potassium dichromate.
- HCl, 32 % (Merck).
- Hexane, "distilled in glass" quality.

- Dichloromethane, “distilled in glass” quality.
- Methanol, “distilled in glass” quality.
- Acetone, “distilled in glass” quality.
- Anhydrous sodium sulfate.
- Carborundum.
- Copper powder (Merck, $63\mu\text{m}$, 99 % purity).
- Glass wool
- Silica gel Merck Kieselgel 60 (0.04-0.063 mm, 230-400 mesh).
- Aluminium oxide neutral Merck 90 Active (0.063-0.200 mm, 70-230 mesh).
- n-C₁₄ d30, n-C₁₉ d40, n-C₃₂ d66.
- Hexamethylbenzene, Cadalene: 1,6-dimethyl-4-(1-methylethyl)naphthalene, Naphthalene-d8.
- Standard solutions of aliphatic and aromatic hydrocarbons.

Working solutions from the stock reference solutions are prepared on a regular basis and stored in clean glass volumetric flasks tightly capped with non-contaminating materials such as Teflon or glass. Extreme care must be taken to ensure that standards have not changed their concentrations through solvent evaporation.

4.2. CLEANING OF REAGENTS AND ADSORBENTS

4.2.1. Cleaning of reagents

Powdered or crystalline reagents, such as anhydrous sodium sulfate (Na₂SO₄)*, glass wool* and carborundum boiling chips*, are thoroughly cleaned before use. They are extracted with hexane in a Soxhlet apparatus for 8 hours and then with methanol or dichloromethane for another 8 hours. For those indicated by an *, this will require pre-combustion in a muffle furnace at approximately 400 °C.

4.2.2. Cleaning of adsorbents

Silica gel and Alumina are treated chemically. Reagents are first refluxed with methanol or dichloromethane in a Soxhlet apparatus for 8 hours, then with n-hexane for the same period. The solvent is removed in a rotary evaporator at a low speed, until the sorbent starts falling down as fine particles. Reagents are then dried in a drying oven at 120 °C for 4 hours. Silica and alumina are activated at 200 °C for 4 hours. Sorbents are allowed to cool in the oven. As active sorbents attract water and contaminants from the atmosphere, controlled deactivation is carried out by adding water to the fully active sorbent (5 % by weight).

The deactivation procedure is carried out by adding the water to the sorbent, and mixing by gentle shaking for a few minutes. The equilibration takes one day.

4.2.3. Cleaning of glassware

Scrub all glassware vigorously with brushes in hot water and detergent. Rinse five times with tap water and twice with distilled water. Rinse with acetone or methanol followed by hexane or petroleum ether. Bake overnight in an oven at 300 °C. All glassware should be stored in dust free cabinets and tightly sealed with pre-cleaned aluminium foil when not in use. Ideally glassware should be cleaned just before use.

For more detailed information, consult Reference Method No 65: UNEP/IOC/IAEA: Reagent and laboratory ware clean-up procedures for low level contaminant monitoring.

5. PROCEDURE

5.1. EXTRACTION OF FREEZE-DRIED SAMPLES

10 to 20 grams of freeze-dried sediment sample, ground and sieved at 250 µm, are extracted in a Soxhlet extractor with a mixture of hexane and dichloromethane (50:50). Internal standards are added to the sample for recovery: 50 µl of a mixture containing: 30ng/ µl of n-C₁₄ d30, 32.444 ng/µl of n-C₁₉ d40, 40 ng/µl of n-C₃₂ d66 for the first fraction and 30 ng/µl of Hexamethylbenzene and 32.688 ng/µl of Cadalene and 33.3588 ng/µl of Naphthalene-d8 for the second fraction.

Extraction is realized in the Soxhlet with 250 ml of the mixture hexane/dichloromethane (50:50), the siphon cycle is about 10 minutes during 8 hours.

5.1.1. Cleaning of extraction thimbles

Paper extraction thimbles should be cleaned prior to sample extraction. For use in the extraction of sediment samples, the extraction can be performed in the Soxhlet apparatus with 250 ml of a mixture hexane / dichloromethane (50:50) for 8 hours cycling the solvent through at a rate of 4 to 5 cycles per hour. Add into the solvent a few carborundum boiling chips to get a regular ebullition.

The use of disposable paper thimbles for the extraction procedure rather than re-usable glass fibre thimbles is recommended due to the difficulties encountered in cleaning the latter.

Alternative method:

Using microwave oven: 10-15 g of sediment is placed in a glass tube with 40 ml of mixture hexane/methylene chloride (50:50), the oven is set at 1200 Watts, the temperature is programmed to reach 115 °C in 10 min. and then isothermal at 115 °C for 30 min. (a

combined extraction could be performed for both OC and PH if proper internal standards are added before extraction starts).

5.2. CONCENTRATION OF THE EXTRACT

When the extraction is completed, the extract is evaporated with a rotary evaporator to a volume of about 15 ml (the temperature of the water bath does not exceed 30 °C).

The extract is dried with anhydrous sodium sulfate and transferred in a graduated tube and concentrated down to 4 to 5 ml using a flow of clean nitrogen.

5.3. EXTRACTABLE ORGANIC MATTER (EOM)

The EOM is determined in the following manner. On the weighing pan of an electro-balance, a known volume of the sediment extract is evaporated (up to 100 µl) and the residue is weighted with a precision of about ± 1 µg. If the residue is less than 2 µg, pre-concentration of the original extract is required. The quantity of EOM is:

$$\text{EOM } (\mu\text{g/g}) = \frac{\text{Weight of residue } (\mu\text{g}) \times \text{volume of the extract (ml)} \times 1000}{\text{Volume evaporated } (\mu\text{l}) \times \text{quantity of sample extracted (g)}}$$

5.4. CLEAN-UP PROCEDURE AND FRACTIONATION

Purposes of the clean-up: removal of lipids, whenever present in significant amount; removal of elementary sulfur and sulfur compounds. Both these compound classes can interfere with the gas-chromatographic separation.

5.4.1. Sulfur and sulfur compounds removal

Preparation of Copper:

Transfer about 20 g of the copper powder in an Erlenmeyer. Add enough concentrated HCl to cover the copper powder, agitate. Sonicate for 10 min., agitate, put again in ultrasonic bath and sonicate for 10 min. Throw the used HCl, add some fresh HCl, transfer in ultrasonic bath and sonicate for 20 min., repeat that procedure four times in total. Wash with distilled water, agitate, discard, add water again, transfer in ultrasonic bath and sonicate for 15 min., discard the used water, does it again, up to pH neutral. Wash with acetone, agitate, transfer in ultrasonic bath and sonicate for 15 min., repeat that procedure four times in total. Then use the same procedure with hexane as a solvent.

Keep in hexane (use it immediately, avoids Cu to be in contact with air).

Transfer 3 to 4 Pasteur pipettes per sample in the flasks containing the hexane extracts. Let the copper react all night. The presence of sulfur compounds in the sample will be detected by the tarnishing of the copper powder.

5.4.2. Fractionation

The clean-up and separation are achieved by a simple column chromatographic partition as follows:

Preparation of silica and alumina: silica gel and alumina are pre-cleaned by Soxhlet extraction, first for 8 hours with methanol and then for 8 hours with hexane. They are dried at 60 °C to remove the solvent, then at 200 °C for 8 hours and then stored in amber bottle.

Before use, they are activated at 200 °C for 4 hours and partially deactivated with 5 % water.

A chromatography column is prepared using 50 ml burette in which a piece of glass wool is added near the stopcock to maintain the packing material. Then, 5 g of silica are transferred into the column, then 10 g of alumina and on top 1 g of sodium sulfate is added in order to avoid the disturbance of the first layer when solvents are poured into the column.

Separation of compounds:

The sample (maximum 100 mg lipids for sediment) is applied on top of the column. A first fraction is obtained by eluting the sample with 20 ml of hexane (F1), this fraction will contain the saturated aliphatics. The second fraction (F2) is obtained by eluting with 30 ml of a mixture of hexane and dichloromethane (90:10), this fraction will contain the unsaturated and aromatic hydrocarbons.

5.4.3. Fractionation: Alternative Method using SPE columns

An alternative method using commercially available Solid Phase Extraction cartridges have been implemented.

This method requires Solid Phase Extraction glass columns (Upti-Clean SPE Glass Columns Si/CN-S 1g/0.5g/6ml-PTFE Frits) and a 12 or 24 ports Glass Vacuum manifold for simultaneous separation on multiple SPE columns. Manifold must be fitted with flow control valves to allow a fine adjustment of flow through the SPE column and disposable Teflon liners.

Once placed onto the manifold, SPE columns are rinsed with 10 ml of n-Hexane.

The sample is applied on top of the Solid Phase Extraction columns. The first fraction containing aliphatics compounds is obtained by eluting with 4 ml of n-Hexane. The second fraction containing PAHs is obtained by eluting 5 ml of a n-Hexane: Dichloromethane (1:1) solution.

6. GAS CHROMATOGRAPHY CONDITIONS

6.1. QUANTIFICATION OF PETROLEUM HYDROCARBONS

Gas Chromatograph:	FISONS GC 8000
Detector:	FID
Injection Technique:	On column
Injector temperature:	30 °C
Injection Volume:	1 µl
Carrier gas:	Helium
Flow rate:	1.9 ml/min.
Column used:	
Type of column:	Capillary
Length:	30 m
Diameter:	0.32 mm
Phase:	HP-5MS
Film thickness:	0.25 µm
Temperature program:	
Initial temperature:	60 °C
Rate:	3.5 °C/min.
Final temperature:	300 °C
Isothermal:	22 min.
Detector temperature:	310 °C
Air flow:	320 ml/min.
Hydrogen flow:	27 ml/min.

6.2. QUANTIFICATION OF PAHs

GC/MS:	Agilent MSD5975
Detector:	MS - SIM
Injection Technique:	Splitless
Injector temperature:	270 °C
Injection Volume:	1 µl
Splitter closing time:	1 min.
Carrier gas:	Helium
Flow rate:	1.6 ml/min.

Column used:

Type of column:	Capillary
Length:	30 m
Diameter:	0.25 mm
Phase:	DB-XLBMS
Film thickness:	0.25 µm
Temperature program:	
Initial temperature:	60 °C
Isothermal:	1 min.
First rate:	10 °C/min.
To:	100 °C
Second rate:	3.5 °C/min.
To:	290 °C
Isothermal:	10 min.
Interface temperature:	290 °C
Source temperature:	230 °C

6.3. TARGET AND CONFIRMATION IONS FOR GC/MS ANALYSES OF PAHs

Compound	Target	Confirming	% Abundance
Benzene	78		
C ₁ - benzene	92		
C ₂ - benzene	106		
C ₃ - benzene	120		
C ₄ - benzene	134		
Naphthalene	128	127	10
C ₁ - naphthalene	142	141	80
C ₂ - naphthalene	156	141	47 - 95
C ₃ - naphthalene	170	155	61 - 300
C ₄ - naphthalene	184	169	189
d ₁₀ - diphenyl	164	162	32
Acenaphthylene	152	151	20
Acenaphthene	154	153	86

Fluorene	166	165	80
C ₁ - fluorene	180	165	95 - 144
C ₂ - fluorene	194	179	25
C ₃ - fluorene	208	193	
d ₁₀ - phenanthrene	188	187	98
Phenanthrene	178	179	16
Anthracene	178	176	20
C ₁ - phenanthrene/anthracene	192	191	39 - 66
C ₂ - phenanthrene/anthracene	206	191	16 - 150
C ₃ - phenanthrene/anthracene	220	205	
C ₄ - phenanthrene/anthracene	234	219, 191	73 - 297
Dibenzothiophene	184	185	14
C ₁ - dibenzothiophene	198	197	53
C ₂ - dibenzothiophene	212	211	
C ₃ - dibenzothiophene	226	211	
C ₄ - dibenzothiophene	240	211	
Fluoranthene	202	200	17
Pyrene	202	200	21
C ₁ - fluoranthene/pyrene	216	215	36 - 64
Benz[a]anthracene	228	226	19
Chrysene	228	226	21
C ₁ - benzanthracene/chrysene	242	243	20
C ₂ - benzanthracene/chrysene	256	241	75 - 131
C ₃ - benzanthracene/chrysene	270	255	
C ₄ - benzanthracene/chrysene	284	269, 241	
d ₁₂ - perylene	264	260	21
Perylene	252	253	22
Benzo[b or k]fluoranthene	252	253	23
Benzo[a or e]pyrene	252	253	22
Indeno[1,2,3-c,d]pyrene	276	138	50
Dibenz[a,h]anthracene	278	279	24
Benzo[g,h,i]perylene	276	138	37

7. QUANTIFICATION

The most widely used information for identification of a peak is its retention time, or its relative retention time (i.e., the adjusted retention time relative to that of a selected reference compound). Retention behavior is temperature dependent and comparison of retention times obtained at two or more temperatures may aid in determining a peak's identity. However, retention times are not specific and despite the high resolution offered by capillary columns, two compounds of interest in the same sample may have identical retention times.

In gas chromatography, results are usually quantified by either external calibration or internal calibration.

7.1. EXTERNAL CALIBRATION

An external calibration is performed by injecting standard samples containing varying concentrations of the compound to be analyzed and creating a calibration curve (area vs. concentration). A response factor (RF) is calculated, for each target compounds, using the following equation:

$$RF = \frac{\text{Peak Area}}{\text{Sample Amount}}$$

The unknown samples are injected and the amounts of target compounds are then calculated with the following equation:

$$\text{Amount} = \frac{\text{Peak Area}}{\text{Response Factor}}$$

The method based on the external calibration doesn't take into account any variance in gas chromatograph performance.

7.2. INTERNAL CALIBRATION

This method is based on the use of an *internal standard* which is defined as a non-interfering compound added to a sample in known concentration in order to eliminate the need to measure the sample size in quantitative analysis and for correction of instrumental variation.

In this method, the internal standard is added to each sample and standard solution.

In a multiple point internal calibration each analyses contains the internal standard whose total amount is kept constant and the analyte of interest whose amount covers the range of concentrations expected. The ratio of the areas of the internal standard and analyte are then used to construct the calibration curve.

A multiple points relative response factor (RRF) calibration curve is established for analytes of interest for each working batch. A RRF is determined, for each analyte, for each calibration level using the following equation:

$$\text{Where: } RRF(X) = \frac{\text{Area}(X)}{\text{Area}(IS)} \times \frac{\text{Qty}(IS)}{\text{Qty}(X)}$$

Area (X) = the area of the analyte to be measured (target compound)

Area (IS) = the area of the specific internal standard

Qty (X) = the known quantity of the analyte in the calibration solution

Qty (IS) = the known quantity of the internal standard in the calibration solution

The relative response factors determined for each calibration level are averaged to produce a mean relative response factor (mRRF) for each analyte. The percent relative standard deviation (%RSD) for the 3 response factor must be less than or equal to 15%, for each analyte.

$$\%RSD = \frac{\text{Standard deviation of the RRFs}}{\text{Average of the RRFs}} \times 100$$

Sample analyte concentrations are calculated based on the quantity and response of the internal standard.

The following equation gives the amount of analyte in the solution analysed.

$$\text{Qty}(X) = \text{Qty}(IS) \times \frac{\text{Area}(X)}{\text{Area}(IS)} \times \frac{1}{\text{mRRF}(X)}$$

Where:

Qty (X) = the unknown quantity of the analyte in the sample

Qty (IS) = the known quantity of the internal standard added to the sample

Area (X) = the area of the analyte

Area (IS) = the area of the internal standard

mRRF (X) = the average response factor of the analyte

Sample analyte concentrations are then calculated by dividing the amount found (Qty) by the grams of samples extracted.

8. QUALITY ASSURANCE/QUALITY CONTROL

Guidelines on the QA/QC requirements for analysis of sediments and marine organisms are detailed in Reference Method No 57, "Contaminant monitoring programs using marine organisms: Quality assurance and good laboratory practice".

The precision of the method is established by the replicate analysis of samples of the appropriate matrix. The precision of the entire analytical procedure is estimated by extracting five sub-samples from the same sample after homogenization. Precision is evaluated as a matter of course during the initial implementation procedure just before initiation of sample analysis.

8.1. ACCURACY

The accuracy of the methods is confirmed by analysis of a suitable RM (i.e. appropriate matrix, analytes) prior to initiation of sample analysis. Agreement between measured and certified concentrations for any individual analyte should be within 35 % and on average within 25 %. Reference Materials are introduced on a regular basis (e.g. every 10-15 samples) as a method of checking the procedure. Further description of the preparation of control charts and criteria for data acceptance is elaborated in Reference Method No 57.

8.2. BLANKS

Blanks represent an opportunity to evaluate and monitor the potential introduction of contaminants into samples during processing. Contributions to the analyte signal can arise from contaminants in the reagents, those arising from passive contact between the sample and the environment (e.g. the atmosphere) and those introduced during sample handling by hands, implements or glassware. It is essential to establish a consistently low (i.e. with respect to analytes) blank prior to initiating analysis or even the determination of the method detection limit. In addition, it is necessary to perform blank determinations on a regular basis (e.g. every batch of samples).

8.3. RECOVERY

Recovery reflects the ability of the analyst to fully recover surrogate compounds introduced to the sample matrix or blank at the beginning of the procedure. The primary criteria for selection of compounds to be used for testing recovery are that they: 1) have physical (i.e. chromatographic/partitioning) properties similar to and if necessary spanning those of the analytes of interest, 2) do not suffer from interferences during gas chromatographic analysis, 3) are baseline resolved from the analytes of interest.

Recovery should be tested on all samples and blanks as a routine matter of course. Recoveries below 70% are to be considered unacceptable. Recoveries in excess of 100 % may indicate the presence of interference.

8.4. ARCHIVING AND REPORTING OF RESULTS

Every sample should have an associated worksheet which follows the samples and the extracts through the various stages of the procedure and upon which the analyst notes all relevant details. An example of such a worksheet is given below. Each laboratory should construct and complete such a worksheet. Relevant chromatograms should be attached to the worksheet. Analyses should be grouped and composite or summary analysis sheets archived with each group. Final disposal of the data will depend on the reasons for which it was collected but should follow the overall plan model.

All processed samples should be archived at all steps of the procedure:

- deep frozen (in the deep-freezer as it was received).
- freeze-dried (in sealed glass container kept in a dark place).
- extracted (after injection on the GC, sample extracts should be concentrated down to 1 ml and transferred into sealed glass vials, a Pasteur pipette sealed with a butane burner is adequate and cheap).

9. REFERENCES

Review Meeting of MED POL – Phase III Monitoring Activities. Palermo (Sicily), Italy 12-15 December, 2005. UNEP(DEC)/MEDWG.282/Inf.5/Rev.1. Methods for Sediments Sampling and Analysis.

Reference Method No 65, UNEP/IOC/IAEA: Reagent and laboratory ware clean-up procedures for low-level contaminants monitoring. UNEP, 1995.

Reference Method No 20, UNEP/IOC/IAEA: Determination of petroleum hydrocarbons in sediments. UNEP, 1992.

Reference Method No 57, UNEP/IOC/IAEA/FAO: Contaminant monitoring programs using marine organisms: Quality assurance and good laboratory practice. UNEP, 1990.

Alzaga R., Montuori P., Ortiz L., Bayona J., Albaiges J. *Journal of Chromatography A*, 1025 (2004) 133-138

Annex VI:

**HELCOM (2012b). Manual for marine monitoring in the COMBINE programme. Annex B-11
Technical note on the determination of heavy metals and persistent organic compounds in
seawater. Appendix 2. Technical note on the determination of persistent organic pollutants in
seawater (6.2.)**

HELCOM Manual for marine monitoring in the COMBINE programme

ANNEX B-11 APPENDIX 2: TECHNICAL ANNEX ON THE DETERMINATION OF HEAVY METALS AND PERSISTENT ORGANIC COMPOUNDS IN SEAWATER

TECHNICAL NOTE ON THE DETERMINATION OF PERSISTENT ORGANIC POLLUTANTS IN SEAWATER

1. INTRODUCTION

These guidelines concentrate on the sampling and extraction of lipophilic persistent organic pollutants from seawater and special aspects of the sampling matrix. This group of pollutants comprises the group of polycyclic aromatic hydrocarbons (PAHs) and chlorinated hydrocarbons (e.g., HCH, HCB, DDT group, chlorinated biphenyls (PCBs)).

For general aspects and the analytical determination, reference is made to the following guidelines:

- "Determination of Polycyclic Aromatic Hydrocarbons (PAHs) in Sediments: Analytical Methods", ICES ACME Report 1997;
- "Guidelines for the determination of chlorobiphenyls in sediments: Analytical methods", ICES ACME Report 1996;
- "Determination of Polycyclic Aromatic Hydrocarbons (PAH)s in Biota", ICES ACME Report 1998; and
- Annex B-14 (these Guidelines).

As the same analytical methods can be used for the determination of lipophilic pollutants in extracts of water samples as are used for extracts of sediments, it is felt that it is a useful way to unify analytical procedures to refer to these publications only.

However, it should be taken into consideration (e.g., for calibration) that the relative concentrations of the individual pollutants are generally quite different in water and sediment samples. The concentration patterns of the pollutants are mainly influenced by their polarity which can be expressed by their octanol/water coefficient ($\log K_{ow}$; $K_{ow} = \text{Concentration in octanol phase} / \text{Concentration in aqueous phase}$). Thus, in water samples the more hydrophilic compounds with $\log K_{ow}$ values of 3 to 4 predominate (e.g., 2- and 3-ring aromatics and HCH isomers), while in sediments and biota the pollutants with $\log K_{ow}$ values >5 are enriched (4- to 6-ring aromatics, DDT group, PCBs).

These guidelines provide advice on lipophilic persistent organic pollutant (POPs) analyses in total seawater with a $\log K_{ow} > 3$. The analysis of POPs generally includes:

1. • sampling and extraction of the water;
2. • clean-up; and
3. • analytical determination.

The extraction of the POPs simultaneously enables an enrichment of the analytes. Because of the very low concentration range of 10 pg l^{-1} to 10 ng l^{-1} , the enrichment of the contaminants is a very important step in the procedure. Extraction and enrichment can be done by solid phase extraction (SPE) or liquid-liquid extraction (LLE).

Determination depends on the chemical structure of the compounds. PAHs can be determined by high performance liquid chromatography (HPLC) with fluorescence detection or gas chromatographic (GC) separation with flame ionization (FID) or mass spectrometric (MS) detection (Fetzer and Vo-Dinh, 1989; Wise et al., 1995). Chlorinated hydrocarbons are generally analysed by gas

chromatographic (GC) separation with electron capture detectors (ECD) or mass spectrometric (MS) detection.

All steps of the procedure are susceptible to insufficient recovery and/or contamination. Therefore, regular quality control procedures must be applied to check the performance of the whole method. These guidelines are intended to encourage and assist analytical chemists to critically reconsider their methods and to improve their procedures and/or the associated quality control measures, where necessary.

These guidelines are not intended as a complete laboratory manual. If necessary, guidance should be sought from specialized laboratories. Whichever procedure is adopted, each laboratory must demonstrate the validity of each step of its procedure. In addition, the use of a second (and different) method, carried out concurrently to the routine procedure, is recommended for validation. The participation in analytical proficiency tests is highly recommended.

2. SAMPLING AND STORAGE

Plastic materials must not be used for sampling and storage owing to possible adsorption on the container material or contamination. Especially the very lipophilic compounds (4- to 6-ring aromatic hydrocarbons, DDT, PCBs) tend to adsorb on every surface. Therefore, the seawater samples should not be stored longer than 2 h and should not be transferred into other containers before extraction. It is highly recommended to extract the water sample as soon as possible after sampling and to use as little manipulation as possible. It is recommended that sampling and extraction should be done in the same device. Extracts in organic solvents are less susceptible to adsorption onto surfaces.

3. BLANKS AND CONTAMINATION

In many cases, the procedural detection limit is determined by the blank value. In order to keep the blank value as low as possible, the compounds to be analysed or other interfering compounds should be removed from all glassware, solvents, chemicals, adsorption materials, etc., that are used in the analysis. The following procedures should be used:

- Glassware should be thoroughly washed with detergents and rinsed with an organic solvent prior to use. Further cleaning of the glassware, other than calibrated instruments, can be carried out by heating at temperatures > 250 °C.
- All solvents should be checked for impurities by concentrating the amount normally used to 10 % of the normal end volume. This concentrate is then analysed in the same way as a sample by HPLC or GC and should not contain significant amounts of the compounds to be analysed or other interfering compounds.
- All chemicals and adsorption materials should be checked for impurities and purified (e.g., by heating or extraction), if necessary. Soxhlet thimbles should be pre-extracted. Glassfiber thimbles are preferred over paper thimbles. Alternatively, full glass Soxhlet thimbles, with a G1 glass filter at the bottom, can be used. The storage of these supercleaned materials for a long period is not recommended, as laboratory air can contain PAHs that will be adsorbed by these materials. Blank values occurring despite all the above-mentioned precautions may be due to contamination from the air. The most volatile compounds will usually show the highest blanks (Gremm and Frimmel, 1990).

As the concentrations of the PAHs and chlorinated hydrocarbons in seawater are very low, possible blank and contamination problems might be even more difficult to control than with sediment samples. Therefore, it is recommended to rewash all equipment (vials, pipettes, glass bottles) with solvent just before use. If possible, critical steps should be done in a clean bench.

The more volatile compounds (especially naphthalene and phenanthrene) show the largest blank problems.

4. PRE-TREATMENT

For the extraction of whole water samples, no pre-treatment is necessary.

If the suspended particulate material (SPM) will be analysed separately from the solute phase, a phase separation has to be done. Because of the necessary additional manipulation step, this is a difficult operation which affords a number of additional quality control procedures (adsorption losses, contamination problems). There are two possible ways for phase separation: filtration and centrifugation.

Filtration is done by GF/F glass fibre filters. As flat-bed filters have a very limited capacity, the use of coiled glass fibre filters is recommended for volumes larger than 10 l and water samples with high amounts of suspended matter. A pump is necessary to force the water through the filter.

Centrifugation needs a high volume centrifuge which must be operable onboard a ship. Such centrifuges with a throughput of 1 m³ h⁻¹ and more are commercially available and used for sampling SPM; however, they are expensive and generally not a standard equipment. For centrifugation, blanks and adsorption problems have to be controlled as well as the separation efficiency.

The sampled SPM is analysed like a sediment. The solute phase is analysed like the whole water sample.

Validation of the phase separation procedures is very difficult; thus, it might be wise to analyse the whole water sample for monitoring purposes and to determine separately only the amount of SPM in the water for reference or normalization purposes.

5. EXTRACTION

The volume of the water sample is the most important parameter which influences the limit of determination of the method. As POP concentrations down to 10 pg l⁻¹ and less are observed in seawater, large water volumes of 10 l to 100 l have to be sampled and extracted. Large volumes are required not only to obtain a sufficiently high detector signal, but also to discriminate from blank problems.

Principally, there are two different extraction principles in current use: solid phase extraction (SPE) and liquid-liquid extraction (LLE). Unfortunately, the two procedures do not always yield comparable results, as the physical extraction principles are quite different (Sturm et al., 1998, Gomez-Belinchon et al., 1988).

SPE has the advantage of being able to extract very large water volumes (up to 1000 l) and to incorporate a phase separation to obtain separate samples for SPM and the solute phase. The drawbacks of the method are a longer sampling time demand, a more complex instrumentation, and problems with validation and control of the extraction efficiency.

LLE has the advantage that it can be easily validated and controlled, as internal standards can be added before extraction. Also, standard addition techniques can be used for accuracy testing. As LLE is a classical extraction technique, a great deal of experience is available and the robustness of the principle is proven. The limitation in sample volume is only relative, as techniques have been described for sampling 10 l and 100 l on a routine basis (Gaul and Ziebarth, 1993; Theobald et al., 1990). It has been shown that a sampling volume of 100 l is sufficient for nearly all monitoring tasks.

Because of the robustness of the method, there is a preference LLE for routine monitoring purposes for all lipophilic organic contaminants.

5.1 Solid phase extraction

The extraction device consists of a filter holder, an adsorption column filled with an adsorbing material (e.g., XAD resin, C18 modified silica gel), a pump which forces the water sample through the column, a flow meter, an electronic control unit, and a power supply. Sampling can be done either by deploying the whole extraction device into the water (in situ pumping) or by pumping the water with a separate pump onboard a ship and then through the extraction device. A suitable in situ system is described in detail in Patrick et al. (1996). After sampling, the columns are stored at 4 °C and the filters at -20 °C.

The adsorption column is eluted with an organic solvent (acetone or acetonitril). Prior to the extraction, internal standards are added to the solvent. The extract obtained is pre-cleaned and analysed.

Analytical procedures for the use of XAD-2 adsorption resins are published by the IOC (1993), Ehrhardt (1987), and Bruhn and McLachlan (2001).

Although the SPE technique has many advantages, one has to be aware of some problems. Especially for large volume sampling, validation of the method is extremely difficult and has not yet been achieved. Some publications have shown that the extraction efficiency is dependent on, e.g., the amount and kind of humic substances which can complex lipophilic compounds (Johnson et al., 1991; Kulovaara, 1993; Sturm et al., 1998).

5.2 Liquid-liquid extraction

The decision to sample 10 l, 20 l, or 100 l of water depends on the anticipated concentrations of the compounds to be analysed in natural samples. For remote sea areas with expected concentration of pg l^{-1} or less, a volume of 100 l is recommended. The technique and principle are identical for all volumes, only the sampling bottle and the equipment are different. Details of the sampling and extraction techniques are described in Gaul and Ziebarth (1993) for the 10 l sampler and in Theobald et al. (1990) for the 100 l sampler.

The all-glass bottle sampler fixed in a stainless steel cage is lowered by a hydrographic wire down to the sampling depth and opened under water. After filling, the sampler is brought on deck of the ship and immediately extracted with a non-polar solvent such as pentane or hexane. Prior to extraction, a solution with appropriate internal standards (e.g., deuterated PAHs, e-HCH, PCB 185) is added to the water sample. After phase separation, the organic extract is dried with Na_2SO_4 and carefully concentrated to about 1 ml in a rotary evaporator. Further evaporation is done under a gentle stream of nitrogen.

Extreme care has to be taken to avoid contamination during sampling, extraction, and work up. Blank samples must be taken in every sampling campaign; this can be done, e.g., by rinsing the cleaned sampling bottle with the extraction solvent and treating this extract like a normal sample. The sampling bottle must be cleaned with detergent, water, and organic solvents (acetone and hexane or pentane) before use. After using in open sea areas, it can be of advantage not to perform the whole cleaning/washing procedure but just to use the sampler directly after emptying the glass bottle from the extracted previous water sample.

Extracts should be stored in the refrigerator and in the dark.

6. CLEAN-UP

Interferences from matrix compounds in seawater samples are generally smaller than in sediment or biota samples. Nevertheless, the crude extracts require a clean-up before chromatographic separation and determination can be done. The clean-up is dependent on the compounds to be analysed, the

sample, the determination method used, and the concentration range to be analysed. For all GC methods, it is essential to remove polar and non-volatile compounds in order to protect the GC column from rapid destruction. A detection system with low selectivity (eg., GC-FID) needs a far better clean-up than a detector with a high selectivity such GC-MS or even GC-MS/MS. HPLC with fluorescence detection (for PAH analyses) has a relative high selectivity but the method will fail if petrogenic aromatic compounds (from an oil spill) are present in the sample. GC-ECD (for chlorinated compounds) has a high selectivity but some interferences (e.g., phthalate esters) may disturb the detection; therefore, for GC-ECD a good clean-up is necessary as well.

A clean-up procedure for this is presented here that uses short silica gel chromatography columns that can be applied with any determination technique: HPLC, GC or GC-MS. The method is simple and is sufficient in most cases of PAH and chlorinated hydrocarbon determinations in seawater (ICES, 1996, 1997, 1999).

A 3 ml glass column with glass fibre frit (commercially available for SPE) is filled with 500 mg silica gel (dried for 2 h at 200° C) and subsequently washed with 30 ml CH₂Cl₂ and 30 ml hexane. The hexane sample extract (concentrated to 500 µl) is applied on top of the column and eluted with 5 ml CH₂Cl₂/hexane (15/85 v/v) and then with 5 ml of acetone. Fraction 1 contains all lipophilic compounds of interest (PAHs and all chlorinated hydrocarbons (from HCB to HCH)); this fraction can be used for GC-MS determination after concentration to 50–300 µl.

If the water sample has been extremely rich in biological material (algae) or if detection limits far below 10 pg l⁻¹ are requested, additional clean-up (HPLC, GPC) might become necessary.

7. CHROMATOGRAPHIC DETERMINATION

Details for the chromatographic determinations are comprehensively described in the 1996 ACME report (ICES, 1996) for chlorobiphenyls in sediments (GC-ECD and GC-MS), the 1997 ACME report (ICES, 1997) for PAHs in sediments (HPLC-Fluorescence detection, GC-FID and GC-MS), and the 1998 ACME report (ICES, 1999) for PAHs in biota (HPLC and GC-MS).

As the cleaned extracts from the seawater samples can be analysed in the same way as the extracts from sediments and biota, the above guidelines can be used. When a GC-MS system can be used, all compounds can be determined in one single GC analysis; if not, the samples have to be analysed separately for PAHs (HPLC-F, GC-FID) and chlorinated hydrocarbons (GC-ECD).

7.1 Gas chromatography-mass spectrometry

As GC-MS has the advantage of being both very selective and quite universal, it is strongly recommended to use GC-MS as the determination method. It especially has the advantage that both PAHs and chlorinated hydrocarbons can be determined in one single analysis. This is not possible with any of the other techniques.

Because of the sensitivity required, the mass spectrometric detector must be operated in the selected ion mode (SIM). By this, absolute sensitivities in the range of 1 pg to 10 pg can be achieved for most compounds. Ion-trap instruments can be operated in full-scan mode and are in principle as sensitive as quadrupole detectors; however, with real samples and matrix underground they can lose considerably sensitivity.

With GC-MS, detection limits of 5–30 pg l⁻¹ can be reached with water sample volumes of 10 l to 100 l. In most cases, it is not the absolute signal strength of the detector which limits the detection; therefore, the injection of a larger aliquot of the analysis solution would not improve it. For some compounds, blank values are the limiting parameter (especially naphthalene and phenanthrene and, to a lesser extent, other PAHs); for this, only a larger sample volume can improve the detection limits. Many other compounds do not exhibit blank problems, if appropriate care is applied; for these, matrix

noise often limits the detection. For such situations, only a better clean-up (e.g., HPLC, GPC) or a more specific detection method (GC-NCI-MS or GC-MS/MS) will improve the detection limit. Negative chemical ionization (NCI) mass spectrometric detection can be used for highly chlorinated compounds (e.g., HCB, PCBs with five or more Cl atoms, HCH) and shows extremely high sensitivity and selectivity for these compounds. More universally applicable is tandem mass spectrometry (MS/MS), which yields a similar absolute sensitivity as normal MS but much higher selectivity. Some MS/MS transitions for the detection of selected chlorinated hydrocarbons are listed in Table 1 in Appendix 2 to Annex B-13: Technical note on the determination of polycyclic aromatic hydrocarbons in biota, from the full "Guidelines".

7.2 Quantification

A multilevel calibration with at least five concentration levels is recommended. The response of the FID detector is linear. For UV and fluorescence detection, the linear range is also large. The working range should be linear and must be covered by a calibration curve.

Since the mass spectrometric detector often has no linear response curve, the use of stable deuterated isotopes is a prerequisite. Furthermore, the response of PAHs in standard solutions is often much lower than in sample extracts. Only a combination of different techniques, e.g., the use of internal standards and standard addition, might give reliable quantitative results.

The calibration curve can be checked by recalculating the standards as if they were samples and comparing these results with the nominal values. Deviations from the nominal values should not exceed 5%.

When chromatograms are processed using automated integrators, the baseline is not always set correctly, and always needs visual inspection. Because the separation of the peaks is often incomplete in HPLC analysis, the use of peak heights is recommended for quantification. In case of GC techniques, either peak heights or peak areas can be used.

Prior to running a series of samples and standards, the GC or HPLC systems should be equilibrated by injecting at least one sample extract, the data from which should be ignored. In addition, standards used for multilevel calibration should be regularly distributed over the sample series so matrix- and non-matrix-containing injections alternate. A sample series should include:

- a procedural blank,
- a laboratory reference material,
- at least five standards,
- one standard that has been treated similarly to the samples (recovery determination).

The limit of determination should depend on the purpose of the investigation. A limit of 2 ng g^{-1} (dry weight) or better should be attained for single compounds. The method for calculating the limit of determination should reflect QUASIMEME advice (Topping et al., 1992). The limit of determination that can be achieved depends on the blank, the sample matrix, concentrations of interfering compounds, and the volume of water taken for analysis. The typical concentration ranges of PAHs and other POPs in seawater can be found in HELCOM assessments (HELCOM, 2003a, 2003b).

8. QUALITY ASSURANCE

A number of measures should be taken to ensure a sufficient quality of the analysis. Five main areas can be identified:

1. extraction efficiency and clean-up;

2. calibrant and calibration;
3. system performance;
4. long-term stability; and
5. internal standards.

8.1 Extraction efficiency and clean-up

A check on extraction efficiency and clean-up can be performed by analysing a reference material (Annex B-7). To determine the recovery rates of the clean-up and concentration steps, it is recommended to pass a standard solution through the entire procedure. Additionally, at least one internal standard should be added to each sample before extraction, to check for recovery during the analytical procedures. If major losses have occurred, then the results should not be reported. CB29 is suggested as a recovery standard because, owing to its high volatility, losses due to evaporation are easily detected. CB29 elutes relatively late from alumina and silica columns. Small peaks that may be present in the gas chromatogram at the retention time of CB29 do not hinder the use of this CB because the recovery standard only indicates major errors in extraction or clean-up. In case of GC/MS, labelled CBs can be used as recovery standards. This allows correction for recovery, provided that each chlorination stage is represented.

8.2 Calibrant and calibration

PAH determinations should preferably be carried out using calibration solutions prepared from certified crystalline PAHs. However, the laboratory should have the appropriate equipment and expertise to handle these hazardous crystalline substances. Alternatively, certified PAH solutions, preferably from two different suppliers, can be used. Two independent stock solutions should always be prepared simultaneously to allow cross-checks to be made. Calibration solutions should be stored in ampoules in a cool, dark place. Weight loss during storage should be recorded for all standards.

CB determinations should always be carried out using calibration solutions prepared from crystalline CBs. Preferably, certified CBs should be used. Two independent stock solutions of different concentrations should always be prepared simultaneously to allow a cross-check to be made. Calibration solutions should preferably be stored in a cool, dark place. For all containers with standards, the weight loss during storage should be recorded.

After clean-up and before GC analysis, both in PAH and CB analysis, an additional internal standard is added for volume correction. Internal standards should be added in a fixed volume or weighted to all standards and samples.

8.3 System performance

The performance of the HPLC or GC system can be monitored by regularly checking the resolution of two closely eluting PAHs or CBs. A decrease in resolution indicates deteriorating HPLC or GC conditions. The signal-to-noise ratio of a low concentration standard yields information on the condition of the detector. For example, a dirty MS-source can be recognized by the presence of a higher background signal, together with a reduced signal-to-noise ratio. Additionally, the peak can be affected.

8.4 Long-term stability

One laboratory reference sample should be included in each series of samples. A quality control chart should be recorded for selected PAHs, e.g., fluoranthene (stable results), pyrene (sensitive to quenching), benzo[a]pyrene (sensitive to light), or, correspondingly, for selected CBs. If the warning

limits are exceeded, the method should be checked for possible errors. When alarm limits are exceeded, the results obtained should not be reported.

A certified reference material (CRM) should be analysed at least once a year, when available, and each time the procedure is changed. Each laboratory analysing PAHs and CBs in water should participate in interlaboratory analytical performance tests on a regular basis.

8.5 Internal standards

Internal standards should be added to all standards and samples either in a fixed volume or by weight. The PAH internal standards should preferably be non-natural PAHs which are not found in water and do not co-elute with the target PAHs; several predeuterated PAHs have proved to be suitable for GC/MS as well as for HPLC analysis. For example, for GC/MS it is recommended to add four internal standards representing different ring-sizes of PAHs.

The following compounds can be used (Wise et al., 1995):

- for HPLC analysis: phenanthrene-d10, fluoranthene-d10, perylene-d12, 6-methyl-chrysene;
- for GC/MS analysis: naphthalene-d8, phenanthrene-d10, chrysene-d12, perylene-d12;
- for GC/FID analysis: 1-butylpropylene, m-tetraphenyl.

Similarly the ideal internal standard for PCBs is a compound which is not found in the samples and does not co-elute with other CBs, e.g., CBs 29, 112, 155, 198 or all 2,4,6-substituted CB congeners. Alternatively, 1,2,3,4-tetrachloronaphthalene can be used.

9. REFERENCES

- Bruhn, R., and McLachlan, M.S. 2001: Seasonal variation of polychlorinated biphenyl concentrations in the southern part of the Baltic Sea. *Marine Pollution Bulletin*, in press
- Ehrhardt, M., 1987: Lipophilic organic material: An apparatus for extracting solids used for their concentration from sea water. *ICES Techniques in Marine Environmental Sciences*, 4.
- Fetzer, J.C., and Vo-Dinh, T. 1989: *Chemical analysis of polycyclic aromatic compounds*. Wiley, New York.
- Gaul, H., and Ziebarth, U., 1993: Method for the analysis of lipophilic compounds in water and results about the distribution of different organochlorine compounds in the North Sea. *Dt. Hydrog. Z.*, 36: 191–121.
- Gomez-Belinchon, J.I., Grimalt, J.O., and Albeiges, J. 1988, *Environmental Science and Technology*, 22: 677–685.
- HELCOM. 2003a. Fourth Periodic Assessment of the State of the Baltic Sea Environment, 1994–1998. *Baltic Sea Environmental Proceedings*, No. 82B. 218 pp.
- HELCOM. 2003b. The Baltic Marine Environment 1999–2002. *Baltic Sea Environmental Proceedings*, No. 87. 48 pp.
- ICES. 1996. Guidelines for the determination of chlorobiphenyls in sediments: Analytical methods. In *Report of the ICES Advisory Committee on the Marine Environment, 1996*. ICES Cooperative Research Report, 217: 100–104. Manual for marine monitoring in the COMBINE programme 128
- ICES. 1997: Determination of polycyclic aromatic hydrocarbons (PAHs) in sediments: Analytical methods. In *Report of the ICES Advisory Committee on the Marine Environment, 1997*. ICES Cooperative Research Report, 222: 118–124.

ICES. 1999. Determination of polycyclic aromatic hydrocarbons (PAHs) in biota In Report of the ICES Advisory Committee on the Marine Environment, 1998. ICES Cooperative Research Report, 233: 230–237.

IOC. 1993: Chlorinated biphenyls in open ocean waters: sampling, extraction, clean-up and instrumental determination. Manual and Guides No. 27. UNESCO Press, Paris

Johnson, W.E., Fendinger, N.J., and Plimmer, J.R. 1991: Solid-phase extraction of pesticides from water: Possible interferences from dissolved organic material. *Analytical Chemistry*, 63: 1510–1513.

Kulovara, M., 1993. Distribution of DDT and Benzo[a]pyrene between water and dissolved organic matter in natural humic water. *Chemosphere*, 27: 2333–2340.

Patrick, G., Schulz-Bull, D.E., Martens, V., Scholz, K., and Duinker, J.C. 1996: An in-situ filtration/extraction system for the recovery of trace organics in solution and on particles – tested in deep ocean water. *Marine Chemistry*, 54: 97–105.

Sturm, B., Knauth, H.D., Theobald, N., and Wünsch, G. 1998. Hydrophobic organic micropollutants in samples of coastal waters: efficiencies of solid-phase extraction in the presence of humic substances. *Fresenius Journal of Analytical Chemistry*, 361: 803–810.

Theobald, N., Lange, W., Rave, A., Pohle U., and Koennecke, P. 1990: Ein 100-l Glaskugelschöpfer zur kontaminationsfreien Entnahme von Seewasser für die Analyse lipophiler organischer Stoffe. *Dt. Hydrogr. Z.*, 43: 311.

Topping G. 1992: The role and application of quality assurance in marine environmental protection. *Marine Pollution Bulletin*, 25(1-4): 61–66.

Wise, S.A., Schantz, M.M., Brenner, B.A., Hays, M.J., and Schiller, S.B. 1995: Certification of polycyclic aromatic hydrocarbons in a marine sediment standard reference material. *Analytical Chemistry*, 67: 1171–1178.

Last updated: 29.10.2012 (Annex number changed from Annex B 12 to Annex B 11)

Annex VII:

ICES/OSPAR (2012). JAMP Guidelines for monitoring contaminants in seawater (6.3.)

1.5.5.4

Special request, Advice May 2012

ECOREGION **General advice**
SUBJECT **Development of a JAMP guideline on monitoring of contaminants in seawater**

Advice summary

ICES has developed a guideline document on monitoring of contaminants in seawater under the Joint Assessment and Monitoring Programme (JAMP) (Annex 1). The document also includes a technical annex on specifics of suitable sampling equipment. ICES advises that the document is included in the JAMP guidelines.

Request

Development of a JAMP guideline on monitoring of contaminants in seawater (OSPAR 2011/1)

To develop the general text for a JAMP guideline on monitoring contaminants in seawater, which could act as the overarching chapeau to technical annexes concerning specific substances. The technical annex on analysis of PFC compounds in seawater developed by ICES in 2009 is the first such document. The development of the overarching text should take into account the need to address the following issues: purposes; quantitative objectives; sampling strategy; sampling equipment; storage and pre-treatment of samples; analytical procedures; analytical quality assurance; reporting requirements.

ICES advice

ICES has developed guidelines for monitoring of contaminants in seawater (Annex 1), complementing the corresponding JAMP Guideline for Monitoring of Contaminants in Sediment and JAMP Guideline for Monitoring of Contaminants in Biota. The guideline document in Annex 1 covers monitoring for organic contaminants and trace metals and is structured along the sections outlined in the request (purposes, quantitative objectives, sampling strategy, sampling equipment, storage and pre-treatment of samples, analytical procedures, analytical quality assurance, and reporting requirements). In addition, an annex to the guideline has been developed on technical specifics of the sampling equipment suitable for subsequent analysis of organic contaminants and trace metals. The document includes references to the EU Water Framework Directive (WFD) and EU Marine Strategy Framework Directive (MSFD) where applicable.

ICES advises that this document is included in the JAMP guidelines.

Source

ICES. 2012. Report of the Marine Chemistry Working Group (MCWG), 20–24 February 2012, Southampton, UK. ICES CM 2012/SGHIE:05.

Annex 1: Guidelines for Monitoring of Contaminants in Seawater

1. Introduction

These guidelines provide advice on the sampling and analysis of seawater, for determination of trace metals and organic contaminants, including oceanic, coastal, and estuarine waters. Monitoring contaminants in seawater is a complex task which requires carefully designed and conducted sampling campaigns, appropriate sampling equipment and its correct handling, as well as suitable pre-treatment and storage methods for the analytes in question. There are numerous steps that will affect data quality prior to the chemical analysis itself.

Contaminants in seawater can originate from direct point sources, riverine discharges, and atmospheric dry and wet deposition. Their distribution in seawater depends on the physical-chemical characteristics of the compound or element, interactions with the water matrix, sediment and biota as well as hydrographical conditions, such as mixing of water masses. Organic contaminants and metals can occur freely dissolved in water, bound to colloids, or suspended particulate matter. Trace metals can form complexes with organic or inorganic material. This partitioning is the result of environmental conditions and the partitioning may change during sampling and storage, and has implications for analysis and interpretation.

These guidelines are general recommendations on contaminant monitoring in seawater. The techniques described are useful for routine monitoring and ship/campaign-based work. However, this guideline is not intended as a complete laboratory manual. Requirements for specific contaminants or contaminant groups should be further specified by expert groups, for example in associated technical annexes, in order to meet the objectives of the monitoring programme and to ensure consistent and comparable data sets.

2. Purposes

Monitoring of contaminants in seawater of the Northeast Atlantic Ocean is performed within the framework of OSPAR as the regional convention for the protection of the marine environment of this area. OSPAR monitoring also can assist member states of the European Union to fulfil their obligations under the relevant EU directives, such as the Marine Strategy Framework Directive (MSFD) (EU, 2008) and the Water Framework Directive (WFD) (EU, 2000) with its related directives such as the daughter directive on Environmental Quality Standards in the field of water policy (2008/105/EC).

One of the aims of OSPAR's Hazardous Substances Strategy is that concentrations of naturally occurring chemicals should approach background concentrations, and concentrations of man-made chemicals should be zero. Progress on the implementation of this strategy is monitored through the Joint Monitoring and Assessment Programme (JAMP) of chemicals for priority action and hazardous substances in general. The main objectives of the JAMP for the period 2010–2014, which seek to support the implementation of the OSPAR strategies and the EU MSFD are:

1. the continued implementation and development of existing OSPAR monitoring programmes and, where necessary, the development of additional coordinated monitoring programmes to take account of criteria, methodological standards and indicators for good environmental status, and the pressures and impacts of human activities;
2. development of tools for the delivery of integrated environmental assessments of the OSPAR maritime area or its regions, linking human activities, their pressures, the state of the marine environment, and management responses. Where relevant, these tools should support the exploration of new and emerging problems in the marine environment;
3. the preparation of integrated environmental assessments of the implementation of the OSPAR strategies, including in particular the assessment of the effects of relevant measures on the improvement of the quality of the marine environment. Such assessments will provide additional information and assessments in respect of the MSFD, enhance the OSPAR quality status reports (QSRs), take into account the Directive's obligations for regional cooperation, and help inform the debate on the development of further measures.

Aqueous inputs (direct or riverine) of contaminants, together with atmospheric deposition, are important sources of contaminants to OSPAR marine waters. Dynamic equilibria exist between the dissolved fractions of the total burden of contaminants, such that contaminants are partitioned between the dissolved state and particulate and colloidal phases in the water column, as well as becoming associated with bottom sediments and biota. The rates of exchange of contaminants between the water and the sediment or biota mean that changes in inputs are likely to be reflected more rapidly in the water than in, for example, bottom sediments. However, this sensitivity to change, and the partitioning between components of the aqueous phase, are also reflected in relatively high spatial and temporal variances in the observed concentrations. The selection of water as a monitoring matrix can therefore be appropriate for a number of reasons. These include the ability to observe short-term variations in contaminant pressure on organisms. Focusing on contaminants that partition strongly into the water rather than the sediment or biota can lead to water being the preferred

matrix for monitoring. OSPAR background documents on chemicals for priority action may provide valuable information with regard to the preferred monitoring matrix. In the context of the JAMP, coordinated monitoring of contaminants in seawater may be carried out in relation to the temporal changes in the degree of pollution, its spatial variation, or as an element of integrated monitoring and assessment of contaminants and biological effects.

Temporal trend monitoring can assess the effectiveness of measures taken to reduce contamination of the marine environment. The statistical assessment of a trend over a longer period also supplies a more reliable assessment for the environmental status within a certain period. The fitted value of the last year measured has been used in OSPAR CEMP assessments as the optimum value for comparing against assessment criteria and hence for assessment of the actual environmental status. In such a way, the within- and between-year variability is taken into account.

Spatial distribution monitoring can describe the existing level of marine contamination widely through the convention area. The measured levels can be compared to background or close to background concentrations, as well as to levels describing thresholds below which no chronic effects are expected to occur in marine species, i.e. environmental assessment criteria (OSPAR, 2009).

Contaminant analysis of seawater can be an element of integrated monitoring and assessment, where chemical and biological effects measurements are combined, in order to assess potential harm to living resources and marine life (OSPAR, 2012). The role of chemical measurements in integrated chemical and biological effects monitoring programmes is to support biological effects programmes by providing information to help identify the chemical causes of observed biological effects. In general, chemical measurements in seawater should contribute to improve and extend OSPAR's monitoring framework and better link it with the understanding of biological effects and ecological impacts of individual substances and the cumulative impacts of mixtures of substances.

Furthermore, beyond the objectives of the JAMP, monitoring of contaminants in water can provide information on the fate of contaminants in the environment, e.g. transformation, partitioning, and transport processes.

3. Quantitative objectives

Seawater monitoring should provide concentrations of target analytes in water, which are representative of the location and time of sampling. General considerations regarding the specification of quantitative objectives for monitoring are given in the JAMP (OSPAR, 2010). More specifically, the following issues should be considered prior to water monitoring: contaminant speciation, detection limits, detectability of temporal and spatial trends, and costs.

3.1. Contaminant speciation

Trace metals and organic contaminants can exist as freely dissolved species in water or bound to colloids and suspended particulate matter (SPM). Trace metals can also exist as inorganic and organic complexes. The targeted contaminant fraction determines which sampling and/or pre-treatment method to use:

- Analysis of unfiltered water samples yields the sum of the concentrations of contaminants that are freely dissolved, complexed, and bound to colloids and SPM. These samples are also referred to as total water or whole water samples.
- Filtered water samples can yield the concentrations in SPM (by analysis of the residue on the filter) and the concentrations of contaminants that are freely dissolved, complexed, and bound to colloids (filtrate). However, many organic contaminants are known to exchange freely between dissolved and other phases in the water. The removal of components of the particulate matter is very likely to alter the position of these equilibria, while the introduction of filter material, container walls, etc. provides additional phases taking part in the equilibration processes. The complete separation of dissolved, colloidal, particulate matter is therefore a difficult task.
- Passive sampling yields the concentrations of freely dissolved contaminants (organics) or freely dissolved and complexed contaminants (trace metals).

The choice of the targeted contaminant fraction may be pre-defined by legal obligations. For example, monitoring under the Water Framework Directive requires the monitoring of metal concentrations in filtered water, and of organic contaminants in total (i.e. unfiltered) water.

3.2. Detection limits

The sample size has to be sufficient to support the desired detection limits for the contaminants of interest, for example to enable descriptions of spatial and temporal trends. For example, one litre discrete water samples may be sufficient for time trend monitoring of PAHs in contaminated harbours, but may be insufficient for monitoring programmes in open waters. For consistency with Commission Directive 2009/90/EC, a limit of quantification (LOQ) should be equal to or below a value of 30% of the relevant assessment criterion, e.g. the Environmental Quality Standard.

3.3. Statistical significance and power

In the context of temporal trend monitoring, it is important to know the statistical power of a time-series to detect changes, i.e. the probability of detecting true trends in concentration in the presence of variance associated with sampling, analysis, and field variability. The necessary or possible power of a monitoring programme will vary with the contaminant and area being investigated. One approach would be to estimate the power of the time series based on the “random” between-year variation. Alternatively, the lowest detectable trend could be estimated at a fixed power. A quantifiable objective could be to detect an annual change (dC/dt) of 5% within a time period of 6 years with a power of 90% at a significance level (α) of 5%. In the case of an expected decrease, the null hypothesis would be chosen as $dC/dt=0$ and the alternative hypothesis as $dC/dt < 0$.

A spatial monitoring programme should enable Contracting Parties to describe the distribution of contaminant concentrations in the survey area, for example to draw maps. These data can provide information to assist in the identification of representative stations for temporal trend studies, or for refinement of spatial surveys, and to implement measures where considered necessary. Statistical procedures can be used to estimate the number of samples and sampling sites needed to meet the required confidence level (i.e. to avoid Type I errors) and statistical power (to avoid Type II errors).

3.4. Costs

The concentrations of contaminants in water, as determined by discrete sampling, are commonly found to be quite variable, both in space and time, and meeting ambitious quantitative objectives may require extensive replication. Seawater sampling for contaminant analysis often requires equipment that is expensive to buy and maintain in good condition to keep the process blanks at low levels. The need for, and cost, of replicate water samples should be carefully considered in determining achievable quantitative objectives for a water-based monitoring programme. Therefore, it is often necessary to balance the scope and performance of monitoring programmes with available budgets.

4. Sampling strategy

The sampling strategy should reflect the purpose of the monitoring programme according to the JAMP (OSPAR, 2010) in relation to the OSPAR Hazardous Substances Strategy. Where applicable, the sampling strategy should consider requirements of the EU WFD (EU, 2000) and MSFD (EU, 2008); in all cases the quantitative objectives of the monitoring programme should be met (see Section 3). In accordance with the JAMP Guideline on Integrated Monitoring of Contaminants and Their Effects, seawater sampling should be carried out at the same time and locations as the sampling of other matrices (sediment, biota) and biological effects measurements (OSPAR, 2012).

A coherent approach to the detailed definition of a sampling strategy should take into account knowledge of the physical and biological oceanography of the area and requires consideration of temporal sources of field variance, such as seasonal factors, and spatial factors, such as the changes in location and water depth within the survey area. The analyte in question (its physical-chemical characteristics and expected concentration), as well as environmental conditions and practicalities, will further determine how samples are taken, e.g. what equipment is used and what volumes are required. However, sampling strategies also include compromises between scientifically advisable approaches and the economical and logistical frames of the sampling effort (see Section 3). It is therefore important that the objectives of monitoring programmes are expressed in quantitative terms and that they are achievable.

4.1. Temporal trend monitoring

The ability of a programme to identify temporal trends strongly depends on the extent to which unwanted sources of variability can be controlled. The short-term (< 1 year) temporal variability of contaminant concentrations in water is potentially very large. Concentrations may be subject to day-night variations in input and removal processes (Jaward *et al.*, 2004). In addition, concentrations at a fixed geographical position may vary over the tidal cycle (e.g. in estuaries). Further temporal variability may arise from variation in local inputs, such as discharges from ships, seasonality in the riverine discharge, changes in atmospheric deposition during rainfall events, and seasonal differences in seawater stratification. Some measures can be taken to reduce short-term temporal variability. These include sampling at pre-defined times of the year and at the same phase of the tidal cycle (e.g. always at high tide), although for ship-based discrete sampling it should be recognized that logistic constraints do not always allow such measures to be taken.

4.2. Spatial distribution monitoring

Analyte concentrations in seawater will vary between locations and with water depth, due to various physical and biogeochemical processes and the distribution of inputs. The expected spatial variability is an important factor in the development of an adequate geographical sampling scheme, i.e. the outline of the station grid and its vertical resolution (Brügman and Kremling, 1999). It should be recognized that the identification of spatial patterns may be obscured by

temporal variability (see Section 3.1), and that the same measures to reduce this source of variability also apply here. If the aim of the programme is to identify local sources of contaminants, then the sampling grid should be denser in the vicinity of suspected sources. Often, the variability of salinity or SPM content of the water can give an indication of the variability of pollutants and may even act as "normalization" factors.

4.3. Sampling method considerations

The proportion of the total concentration of a contaminant which is freely dissolved in the water phase increases with polarity of the pollutants (see Section 3). On the other hand, non-polar pollutants sorb to SPM and sediments and are thereby removed from the water column by sedimentation. For these contaminants, additional factors that should be taken into account are the SPM content and the volume of water that is sampled (see Section 3). These factors are important in filtration-extraction methods because the particle-bound and colloiddally bound contaminant fractions that escape phase separation depend on the extent of filter clogging (Hermans *et al.*, 1992). The measurement of SPM concentrations is even more important for monitoring contaminants in total water. The required water volume should be estimated before the sampling campaign, taking into account the method detection limits (see Section 3).

4.4. Supporting data

It is important that as much information as possible is collected concerning the waterbody being sampled. This includes co-factors such as salinity, SPM concentrations, and temperature. Whenever possible, sampling should be done as part of an integrated monitoring programme that includes the measurement of biological effects. These data should be obtained at the same time and locations as sampling for contaminant analysis.

4.5. Statistical considerations

Prior to starting a full-scale monitoring study, the available information on temporal variability should be carefully evaluated, possibly amended by a small-scale pilot programme. This evaluation should include a statistical assessment certifying that the objectives of the monitoring study can be met (see Section 3).

If no previous information exists, the sampling strategy can be based on a combination of general statistical principles and expert knowledge about sources and fate of the studied substances in the investigated sea basin. The statistical approach could include the principles of stratified sampling: First, the sampling area under consideration is partitioned into smaller more homogeneous areas, so-called strata. This can be based on simple information, such as depth, distance to land, or measured or modelled salinity. A successful stratification is characterized by a small variation of the measured concentrations within each stratum and a substantial variation between strata. For optimal allocation of the samples, the size (volume or area) of each stratum should be determined. Assuming that there are m strata with volumes V_1, \dots, V_m and that the standard deviation of the target variable is about the same in all strata, the number of samples n_j in stratum j shall be taken approximately proportional to the volume V_j , i.e.

$$n_j \approx n \frac{V_j}{V}$$

where V is the total volume of the investigated sea basin and n is the total number of samples.

If the standard deviation of the target variable varies from stratum to stratum, more samples should be taken in strata with high standard deviation. More specifically, the sample numbers chosen should aim at making n_j proportional to $S_j V_j$, where S_j is the standard deviation in the j th stratum, i.e. letting

$$n_j \approx n \frac{S_j V_j}{\sum_{j=1}^m S_j V_j}$$

Finally, the average concentration in the study area is estimated to be

$$\sum_{j=1}^m V_j \bar{X}_j / V$$

where \bar{X}_j is the average observed concentration in the j th stratum.

4.6. Discrete sampling versus time-integrated sampling

Concentrations of contaminants in water respond quickly to changes in inputs and other environmental conditions, unlike concentrations in sediments and biota. This low level of time integration can be of advantage in detecting peak events but, on the other hand, concentrations in water are likely to show relatively high variability, which can have drawbacks in long-term monitoring and may require high sampling frequencies, causing high costs.

The influence of temporal variability may be reduced by time-integrated sampling. However, continuous water intake over a prolonged time period, followed by filtration and extraction, may often prove to be impractical and costly, particularly for ship-based sampling programmes. Unattended integrative devices, such as passive samplers (PSDs) also yield a time-integrated concentration if the necessary calibration parameters are available for the target analytes. Considerations for evaluating whether the necessary PSD calibration parameters are available for non-polar organic analytes are given by Lohmann *et al.* (2012). PSDs for polar contaminants (pharmaceuticals, detergents, and personal care products) are insufficiently mature for quantitative spatial and temporal trend monitoring at present, but may be useful in initial surveys. Diffusive gradients in thin films (DGT) is a mature PSD technique for trace metals, but its application in the marine environment has been quite limited so far (Mills *et al.*, 2011). All PSDs require suitable deployment sites, such as jetties, buoys, bottom landers, long-term moorings, etc, which always have to be visited twice and some losses due to other marine activities may be expected. If the monitoring programme requires sampling of total water, this will limit the applicability of PSDs.

5. Sampling equipment

The choice of sampling equipment depends on the physical-chemical properties and expected concentrations of the analytes, on the depth and location of the sampling site, and on the available infrastructure. All materials used for the sampling equipment (sample containers, tubing, connectors, valves, pumps, filters) should neither absorb nor release the target analytes, or any non-target substance that interferes with the chemical analysis. Contaminants are held in a range of dissolved, colloid, and particulate phases. These have a potential to interact differently with sampling equipment, and also for contaminants to exchange between phases during sample processing. Sampling equipment and processing therefore needs to be rigorously tested before adoption in large-scale monitoring programmes.

Since concentrations of organic contaminants and metals in seawater are usually very low, large volumes of water must be sampled. Contamination of the sample by compounds that leach out of the sampling equipment as well as analyte loss due to wall sorption are serious issues which may affect the integrity of seawater samples.

Sample contamination from the atmosphere should be avoided (e.g. paint and rust particles, engine exhausts, atmospheric background). To minimize contamination from the atmosphere, the surfaces of the sampling equipment in contact with the sample should be isolated from the atmosphere before and after the sampling, including storage of the equipment. These surfaces should be cleaned using appropriate solvents prior to sampling. Equipment blanks and recovery samples yield important quality control information that can be used to assess sample contamination and analyte losses, bearing in mind the potentially site-specific nature of airborne contamination.

Concentrations of target analytes in the water may be elevated because of leaching from the sampling platform itself (e.g. polyaromatic hydrocarbons (PAHs), organotin, polychlorinated biphenyls (PCBs), iron, and chlorofluoroalkanes can be released from the ship during ship-based sampling). The ship's keel should be at an angle of 20 to 40 degrees to any current coming from the bow at the sampling side (typically starboard side), to minimize any influence from the ship's hull.

Since the sampling equipment passes through the air-water interface, contamination from the sea surface microlayer is a significant risk. Concentrations of dissolved and particulate matter are elevated in this microlayer, and the associated analytes may therefore contaminate samples that are taken at larger depth. Sample contamination from the microlayer can be avoided by closing the sampling equipment during passage through the sea surface and only allowing sample intake at the intended depth.

5.1. Trace metals (including MeHg)

Contamination from the ship has to be avoided at all times. For analyses of trace metals, all contact between the seawater sample and metal must be avoided. On approaching a station, the sampling for trace metals has to be performed immediately. Hydrographical information about water depth and the stratification of the water column should be available.

Discrete samplers that are specially designed for trace metal analysis should be used, e.g. GO-FLO (from General Oceanic), available in sizes from 1.7 to 100 litres, or MERCOS samplers (from Hydrobios; or modified version, size 0.5 litre). They are typically operated on a Teflon, polymer, or Kevlar jacketed stainless steel hydrographic wire, tensioned

by a coated bottom weight. The messengers should also be free of metals; any essential metal parts should be of seawater resistant stainless steel (V4A).

Samples should be taken so as to avoid contamination by leachate from the hull of the ship. Sampling bottles should be made of plastic with low metal content, e.g. special low-density polyethylene (LDPE) bottles. For mercury, glass should be preferred if the samples are stored for a longer period. Teflon bottles may also be used, but they are relatively expensive and, depending on the manufacturing process, may have a relatively rough inner surface.

Pumping using metal-free devices may be an alternative to discrete sampling, e.g. for separating SPM by subsequent centrifugation, but is not preferable when sampling from a ship at distinct sampling depths or in the open sea where concentrations are very low. More details on sampler types are described in the Technical Annex.

After sampling, the sampler should be placed immediately in a plastic bag or box or an aluminium container (if aluminium is not determined), followed by transport to a clean-room or laboratory with a clean-air bench. These measures are particularly critical for open sea samples where the expected concentrations of trace metals are very low.

5.2. Organic contaminants

Concentrations of organic contaminants in seawater are usually very low. In order to reach the projected LOQs in the low pg l^{-1} range, large water volumes (10 to 100 l or more) have to be collected and extracted. With modern analytical equipment, these LOQs are often not limited by the signal intensity in the instrumental analysis, but by blank levels and interferences from the matrix background.

Hydrophobic compounds occur in a continuum of dissolved, colloidal, and particulate-bound forms. Unless a total concentration is to be determined, the compound partitioning must not be altered during sampling and subsequent treatment. This is very challenging, as the separation process must be contamination-free and should not change the concentration distribution. It should be applied during or immediately after sampling. For details, see Section 6.2.

Sometimes blank problems can only be overcome by increasing the sample size. However, the maximum sample size may be limited by operational constraints, such as container size for discrete samplers, pumping time, and the ability to process large water volumes. Blank levels can be reduced by minimizing the size of the sampling equipment (e.g. short inlet tubes) and by using sampler designs and handling procedures that minimize exposure to the atmosphere (short assembly/disassembly times). The use of *in situ* filtration/extraction equipment that is both compact and easy to operate combines the advantages of small size and short exposure to the atmosphere. This holds even stronger for passive samplers (see Section 4.6), provided that the sampling phase is sufficiently clean and that times of exposure to the atmosphere during deployment and retrieval are sufficiently short.

The materials used for the sampling equipment depend on the target contaminants. Sampling equipment for organic contaminants in seawater is preferably made of glass or stainless steel. Teflon parts are often used for legacy persistent organic pollutants (POPs), while they cannot be used for sampling of fluorinated compounds. Before use, the equipment has to be cleaned, e.g. rinsed with appropriate organic solvents. Examples of sampling equipment suitable for organic contaminants are presented in the Technical Annex.

6. Storage and pre-treatment of samples

The storage and pre-treatment of samples should be carried out in full awareness of the risks of contamination or analyte loss if samples are handled incorrectly. Appropriate measures should be taken to avoid contamination, such as wearing clean gloves, pre-cleaning equipment, etc. All storage and pre-treatment steps should be fully documented for each sample. Field control samples (for assessing sample contamination) and surrogate spikes (for assessing analyte losses) should be processed regularly as part of the quality assurance and control procedures (see Section 8). All storage and pre-treatment steps should be fully validated prior to the start of a monitoring programme.

6.1. Storage

It is advisable to process samples as soon as possible rather than store them for a longer period of time. Storage of samples increases the risk of changing concentrations, by microbial degradation or sorption processes. However, appropriate laboratory facilities for handling of samples for trace analyses need to be available. If this is not the case, samples may have to be conserved. Water samples for metal analysis are typically acidified for conservation purposes. Sub-sampling of seawater, if required, should preferably be performed immediately after sampling.

Water samples for organic pollutants generally are impractical to store because of their large volumes. Instead, they are extracted onboard by liquid-liquid extraction (LLE) or solid-phase extraction (SPE) and the extracts or adsorbent cartridges are stored under cool ($< 4^{\circ}\text{C}$) and dark conditions. If water samples must be stored, this should also be in the

dark and in a refrigerator (4°C). Preferably, internal standards (e.g. isotopically labelled analogues) should be added before extraction or/and storage. Storage times should be kept as short as possible and the stability of all compounds during storage must be checked.

Only appropriate (pre-cleaned) containers should be used for short- or long-term storage. The analytes of interest determine the appropriate container material (plastic, glass, metal), the need for acidification, and the optimal storage temperature. All storage conditions should be fully validated by the laboratory that carries out the monitoring, since sample contamination and loss of analyte may be affected by subtle changes in the materials and procedures for sample storage. SPM samples should always be stored frozen until further analysis.

6.2. Sample pre-treatment

The need for filtration of samples is mainly determined by the monitoring programme which typically will specify the analysis of either filtered or unfiltered water (total water, whole water). No pre-treatment is required for the analysis of whole water, although acidification may be necessary as part of the extraction procedure, depending on the analyte and on the extraction method used.

Filtration is the preferred technique to separate the dissolved phase from the SPM for small volume samples (e.g. for metal analysis). Polycarbonate or cellulose acetate filters with a pore size of 0.45 µm are frequently used for trace metal determinations, whereas glass fibre filters (0.7 µm or 1.2 µm pore size) are commonly used in the analysis of non-polar and polar organic contaminants. The efficiency of the separation between dissolved and particulate contaminants depends on the pore size of the filters, and may also depend on SPM content of the water and on the sample intake (see Section 4). Adsorption of dissolved analytes to the filter may be an issue for some compounds, and should be addressed during method validation.

A flow-through centrifuge is suitable for obtaining SPM from large volume samples, but less suitable for obtaining particle free water as the separation is incomplete. In general, the efficiency of the separation depends on the geometry and operating conditions of the centrifugation equipment (residence time, effective gravity force), as well as on the density and size of the SPM. Filtration is more effective in this respect, but also more susceptible to artefacts and more time consuming. Ideally, filtration should occur online while sampling or immediately after sampling.

7. Analytical procedures

Analytical methods should be specific to the target analytes and sufficiently sensitive to allow analyses of seawater samples which generally have low concentrations of contaminants. They should meet minimum performance criteria consistent with Commission Directive 2009/90/EC, including an uncertainty on measurements < 50%, estimated at the level of the relevant Environmental Quality Standard, and an LOQ ≤ 30% of the Environmental Quality Standard. If no method meets the minimal performance criteria, the best available analytical method, not entailing excessive costs, should be used. All analytical methods should be capable of being brought under statistical control to ensure adequate quality assurance and quality control. It should be noted that analyses at such low concentrations require extensive experience.

7.1. Trace metals

Analysis of trace metals in seawater generally includes pre-treatment and pre-concentration steps, followed by detection using element-specific spectrometric instrumental procedures, e.g. graphite furnace atomic absorption spectrometry (GFAAS), inductively coupled plasma mass spectrometry (ICP-MS), anodic stripping voltammetry (ASV), and total reflection x-ray fluorescence (TXRF). For mercury, further methods and instruments are used, such as cold vapour atomic absorption spectrometry (CVAAS) and cold vapour atomic fluorescence spectrometry (CVAFS). These techniques are usually combined with a pre-concentration by amalgamation. ICP-MS is also used for mercury analysis.

7.2. Organic contaminants

Organic contaminants are usually found in the water phase at low concentrations, entailing the need for an extraction and enrichment step (e.g. SPE, LLE, solid-phase micro extraction (SPME)) and a selective chromatographic/detection step (e.g. GC-MS⁽ⁿ⁾, GC-ECD, LC-MS⁽ⁿ⁾, LC-FL.) within every analytical procedure. Depending on the analytes chosen, the water body studied and expected pollutant concentration, clean-up may be necessary. Although GC-MS/MS and HPLC-MS/MS are very selective techniques, it is good practice to use a second MS transition as a qualifier.

8. Quality assurance (QA)

The quality assurance programme should ensure that the data conform to the quantitative objectives of the programme (see Section 3). The laboratory must establish a quality assurance / quality control system, if necessary consistent with

requirements in Commission Directive 2009/90/EC. All field and laboratory procedures should be fully validated, and the laboratory should also participate in intercalibration exercises and proficiency testing to provide external verification of results. The quality assurance procedures should cover sampling design, sampling, sample storage, analytical procedures (including field controls, analytical blanks, and recoveries), equipment maintenance and handling, training of personnel, data management, and an audit trail.

The use of a second (and different) sampling method, carried out simultaneously to the routine procedure, can be included in the validation process. All QA and QC data should be fully documented.

Because of the extremely low concentrations of pollutants in seawater, blank problems are generally more relevant and more difficult to control than in other matrices. Even ultra-pure chemicals and solvents used sometimes have to be purified before use. Concentrations are often close to the LOQs, which means difficult calibration and integration, and reduced analytical precision.

In addition, the following problems are encountered specifically in seawater analyses of organic contaminants:

- Because of the large sample volumes, it is not possible to analyze replicate samples on a routine basis or to take samples for back-up analysis. However, it is often possible to make a plausibility check by comparing the results with those of samples taken from adjacent stations in a homogeneous water body. Homogeneity can be assessed from oceanographic parameters, like salinity.
- No certified reference materials are available for organic contaminants in seawater. Therefore, laboratory reference materials have to be used, which should preferably be a natural or spiked extract from a typical monitoring station. Extraction efficiencies should be checked by standard addition tests.
- Laboratory performance studies (e.g. by QUASIMEME) are difficult to perform and to evaluate because sample volumes in these studies (max. 1 l) differ from those used in real analysis (>10 l). Thus, concentration ranges in the tests are often higher than in real-life samples.

For temporal trend monitoring in particular, it is extremely important to perform reliable and reproducible high-quality analyses over decades. Therefore, such analyses require well-documented procedures and experienced analysts (see Section 7).

9. Reporting requirements

Secure data storage and appropriate access to the data should be ensured by submission of data to national databases and to the ICES database. Reporting requirements will depend on the database. For entry of OSPAR data into the ICES database, data of trace metals and organic contaminants should be reported in accordance with the latest ICES reporting formats.

The calculation of results and the reporting of data can be major sources of error. Control procedures should be established in order to ensure that data are correct and to avoid transcription errors. This could include comparisons with independently obtained results for the same area or with typical concentration intervals. Data stored in databases should be checked and validated, and checks are also necessary when data are transferred between databases.

Concentrations of trace metals and organic contaminants in seawater should be given in weight per volume (e.g. ng l^{-1}). To ensure correct interpretation, reporting should include information on the sampling method, filtration (filter type and pore size), storage/conservation, and analytical method. Minimum performance criteria such as LOQ and uncertainty measurement along with relevant QA/QC data such as reference material analyses should be included in the report.

The purpose of the monitoring, geographical coordinates, and the name of the sampling stations should be reported in the data as well as being defined in the OSPAR Station Dictionary (<http://www.ices.dk/datacentre/accessions/>). Sample depth, suspended particulate matter concentration, and physicochemical parameters at the time of sampling, such as air and water temperatures, salinity, pH, and weather conditions, should also be reported.

10. References

- Brügmann, L., and Kremling, K. 1999. Sampling. In Graßhoff, K., Ehrhardt, M., and Kremling, K. (Eds.). *Methods of seawater analysis*. 3rd edition. Wiley-VCH, pp. 1–26.
- EU. 2000. Directive 2000/60/EC of the European Parliament and of the Council of 23 October 2000, establishing a framework for Community action in the field of water policy (Water Framework Directive).
- EU. 2008. Directive 2008/56/EC of the European Parliament and of the Council of 17 June 2008, establishing a framework for Community action in the field of marine environmental policy (Marine Strategy Framework Directive).

- Hermans, J. H., Smedes, F., Hofstraat, J. W., and Cofino, W. P. 1992. A method for estimation of chlorinated biphenyls in surface waters: influence of sampling method on analytical results. *Journal of Environmental Science and Technology*, 26: 2028–2034.
- Jaward, F., Barber, J. L., Booij, K., Dachs, J., Lohmann, R., and Jones, K. C. 2004. Evidence for dynamic air-water coupling of persistent organic pollutants over the open Atlantic Ocean. *Journal of Environmental Science and Technology*, 38: 2617–2625.
- Lohmann, R., Booij, K., Smedes, F., and Vrana, B. 2012. Use of passive sampling devices for monitoring and compliance checking of POP concentrations in water. *Environmental Science and Pollution Research*. doi: 10.1007/s11356-012-0748-9.
- Mills, G. A., Fones, G. R., Booij, K., and Greenwood, R. 2011. Passive sampling technologies. *In* Quevauviller, P., Roose, P., and Verreet, G. (Eds.). *Chemical Marine Monitoring. Policy Framework and Analytical Trends*. John Wiley and Sons, Chichester, pp. 397–432.
- OSPAR. 2009. Background Document on CEMP Assessment Criteria for QSR 2010.
- OSPAR. 2010. Joint Assessment and Monitoring Programme 2010–2014. OSPAR Agreement 2010-4.
- OSPAR. 2012. JAMP Guideline for the Integrated Monitoring and Assessment of Contaminants and their effects. Currently in preparation. http://www.ospar.org/content/content.asp?menu=00900301400135_000000_000000.

Technical Annex: Sampling equipment for analysis of trace metals and organic contaminants in seawater

1. Trace metals

1.1 Discrete sampling

An example of a discrete sampler is the GO-FLO sampler by General Oceanics (Figure 1). This sampler consists of a cylinder with an inner Teflon-coating which can be closed and lowered into the water column and opens automatically at a certain depth (ca. 10 m) by hydrostatic pressure. This avoids contact of the sample with the water surface where some contaminants can accumulate. At the desired depth, a messenger is sent on the hydrographic wire (made of Teflon coated stainless steel, polymer, or preferably Kevlar) to release the closing valves in both ends of the sampler. Each bottle can be equipped with a second messenger that is released when the valves close. Water samples can be collected from a range of depths by mounting a series of bottles along the cable.

A variety of the GO-FLO sampler is the reversing water sampler. The messenger releases the sampler from the upper attachment, it rotates, and closes the two valves. If a special thermometer type is attached to the sampler, it fixes the actual temperature at the sampling depth, which can be determined later on board. This accessory can be used when no CTD-sensor is used to record the temperature profile.

Generally, all samplers must be cleaned before the first use by rinsing the inner surfaces with diluted hydrochloric acid. In the open sea, this may not be necessary between sampling where rinsing with deionised water is sufficient in most cases. In the open sea, seawater is sufficiently clean to rinse the outer surface. Samplers with rubber parts which cannot be acid-cleaned or cannot be closed during deployment should be avoided.



Figure 1 Picture of a GO-FLO sampler (General Oceanics; photo courtesy of IFREMER, France).

The MERCOS sampler (Hydrobios Kiel) is designed for two 500 ml thick-walled cylindrical or ball-shaped Teflon bottles, which are closed by two silicone tubes of different diameters in the water. As the bottles are filled with air, the operating depth is restricted to about 50 m for the cylindrical and about 200 m for the globular type. However, this sampler is no longer offered by the manufacturer (<http://www.hydrobios.de>, 2012).

A modified version for four bottles was developed by the Bundesamt für Seeschifffahrt und Hydrographie (BSH, Germany), maintaining the triggering device, but using LDPE bottles of low metal content material (NALGENE) that are protected against the water pressure by a polyacrylate mantle. The LDPE bottles are cheaper and easier to clean due to the smooth inner surface compared to the relatively rough texture of the thick-walled Teflon bottles. Therefore, the LDPE usually show much lower blank values.

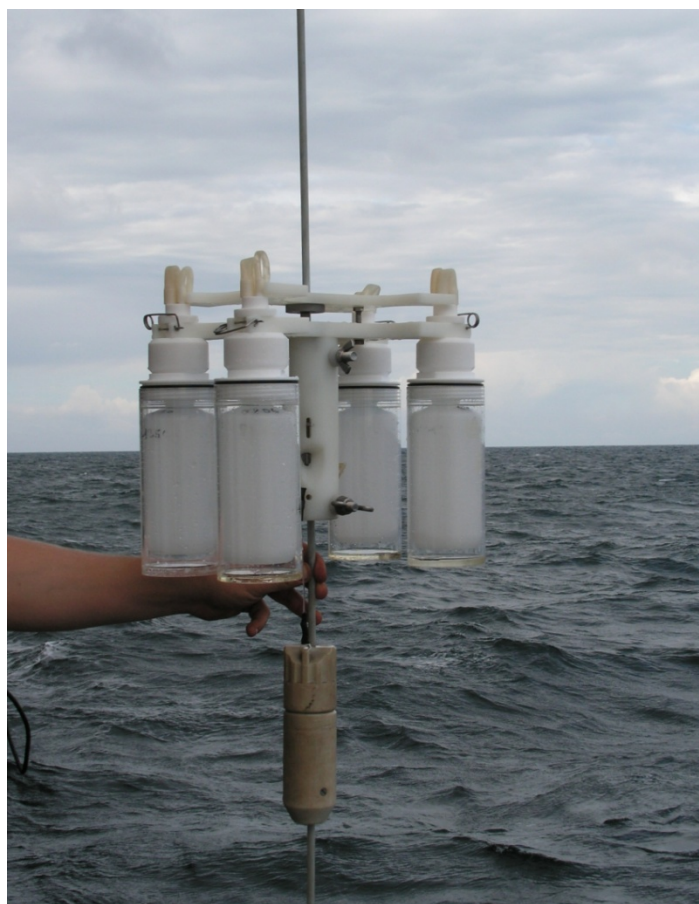

Figure 2 Modified MERCOS water sampler of the second generation for four bottles, manufactured by BSH, Germany (photo courtesy of S. Schmolke, BSH, Germany).

1.2 Sampling by pumping

For depths down to 100 m, perhaps even 200 m, it can be practicable to pump seawater up through silicone or Teflon tubing, optionally including in-line filtration. The tubing should be cleaned by pumping acid (e.g. 10% hydrochloric acid) prior to sampling. The first litres of seawater sampled should be subsequently discarded. A peristaltic pump or Teflon piston pumps are suitable. The peristaltic pump can be placed between the sampling tube and the filter. The outflow from the in-line filter can then be collected in polyethylene bottles, Teflon bottles, or in glass or quartz bottles for mercury analyses.

2. Organic contaminants

Large volumes of seawater samples are usually needed for the analysis of organic contaminants. Sampling devices depend on the amount of sample to be processed and the method of extraction (liquid–liquid extraction (LLE) or solid-phase extraction (SPE)).

LLE and SPE do not yield exactly the same concentrations as they use different extraction principles. While SPE effectively extracts only freely dissolved compounds, LLE extracts freely dissolved compounds and also compounds complexed with humic acids and, in part, compounds bound to particles (Sturm *et al.*, 1998). Non-polar compounds can be extracted by either LLE or SPE, whereas the extraction of polar compounds generally requires SPE.

Volumes of 1 to 100 l can be sampled by discrete sampling and/or pumping and are usually extracted either by LLE or SPE. Sample volumes >100 l are generally sampled by pumping and extracted by SPE.

2.1 Discrete sampling

Several different sampling devices have been designed for discrete sampling depending on the volumes needed and the extraction techniques to be applied.

All-glass bottle samplers for volumes of 10 L and 100 L are shown in Figure 3. They are mounted in a stainless steel cage and lowered on a hydrographic wire down to the desired sampling depth and opened under water. After filling, the sampler is brought on deck of the ship and the sample can be extracted by LLE directly in the sampler (using a non-polar solvent) or by SPE. For example, non-polar pollutants like organohalogen pesticides (e.g. DDX, HCH, HCB, dieldrin, endrin) can be extracted and enriched from seawater by means of LLE using hexane or pentane.

Gaul and Ziebarth (1983) described a 10 l glass sampler allowing extraction in the sampling flask itself, thereby minimizing uncertainties arising from sample handling, blanks, adsorption, etc. Later, the same principle was expanded to a 100 l flask, thus increasing the sample volume and lowering the limit of quantification (LOQ) by a factor of 10 (Theobald *et al.*, 1990). Figure 3 shows pictures of 10 l and 100 l sampling bowls. Extraction is done by agitating the samplers with 0.2 and 1 liter of pentane, respectively, using a stirrer. The glass sampler can be used to a depth of 2000 m (10 l) and 100 m (100 l).

Collecting samples at greater depth can be done with stainless steel bottles (Figure 4) holding about 30 litres. This type of sampler was developed based on experience with Niskin and Go-Flo type bottles, and has been used in analyzing dissolved herbicides in water samples collected down to 3000 m depth.



Figure 3 Left: BSH all-glass bottle water sampler (10 l). Right: 100 l glass flask sampler for sampling seawater for the analysis of organic contaminants.



Figure 4 A stainless steel sampling bottle, for subsequent analysis of organic contaminants in seawater.

2.2 Sampling by pumping – *In situ* filtration and extraction

For larger volumes of 200 to 1000 l, Schulz-Bull *et al.* (1995) described an SPE procedure using large extraction cartridges filled with XAD resins. With this adsorbent, they obtained good extraction recoveries for PCBs, DDT, and PAHs, but not for HCH.

Sampling by pumping can be performed with compressed air Teflon pumps (not suitable for subsequent analysis of perfluorinated compounds). In order to equilibrate the system with the sampling water, the water is pumped for about ten minutes before the actual sampling begins. Then the sampling bottles are thoroughly rinsed with the sample, before beginning the sampling itself. The hose is kept away from the ship's hull while the system is being rinsed, and during the collection of the sub-surface samples.

In situ filtration and solid-phase extraction sampling devices may minimize the risk of sample contamination during sampling. A typical *in situ* pump system, the Kiel In-Situ Pump (KISP), has been widely applied to the extraction of organic contaminants in seawater (Petrick *et al.*, 1996). A modified KISP has been described for seawater sampling on-board research vessels (Ebinghaus and Xie, 2006). Briefly, as shown in Figure 5, KISP includes a filter holder, a polymeric resin column, a pump, and a flowmeter. A glass fibre filter (pore size 0.7 μm) is used to recover the particulate phase and a glass column packed with polymeric resin for the dissolved phase. The KISP can be easily operated on board by connecting it to the ship's seawater intake system for sampling seawater at certain depths. The pump system assembly with batteries can be deployed at different depths on a hydrographic wire, and the pumping can be started and ended by remote control.

The original KISP contains some plastic parts and connections, which may present a contamination risk for some organic contaminants, such as brominated flame retardants, alkylphenols, and plasticizers. Low blanks and detection limits have been obtained from KISP samples for legacy persistent organic pollutants (POPs), such as PCBs, DDTs, and HCHs (Lakaschus *et al.*, 2002; Sobek and Gustafsson, 2004). However, it is recommended that these parts are replaced by stainless steel or glass if KISP is to be applied for sampling seawater for the determination of other organic contaminants. Surrogate standards can be added to the resin column before sampling to control the extraction recoveries and storage. It should be noted that the validation of the *in situ* pump sampling method is difficult, and extraction efficiency may depend on dissolved organic matter and humic substances.

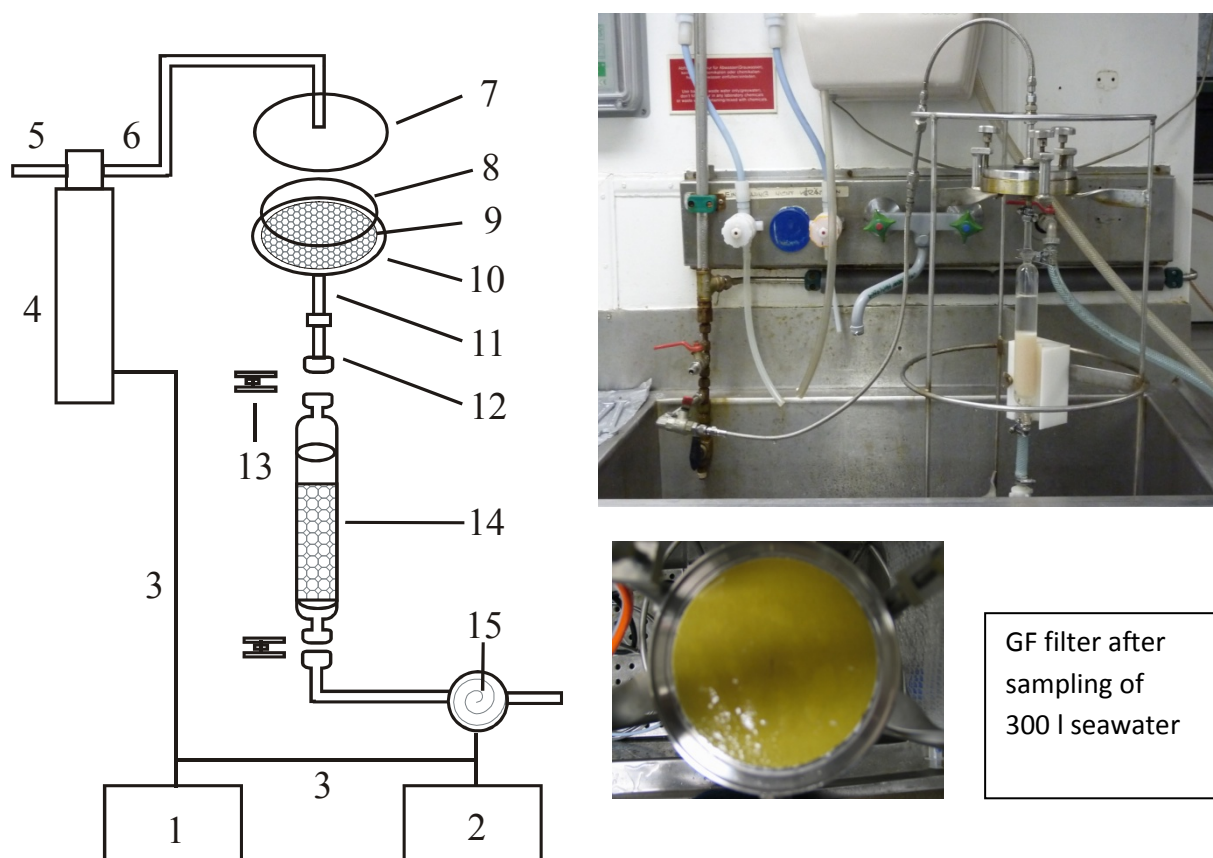

Figure 5 Schematic presentation of the Kiel In-Situ Pump (KISP). 1: flowmeter controller; 2: flowmeter; 3: cable connections; 4: pump; 5: pump inlet; 6: pump outlet; 7: stainless steel deck of filter holder; 8: GF 52 filter; 9: glass plate; 10: filter holder; 11: stainless steel tubing; 12 glass connect; 13 adjustable clip; 14: resins column; 15: counter of flow meter.

References:

- Ebinghaus, R., and Xie, Z. 2006. Occurrence and air/sea-exchange of novel organic pollutants in the marine environment. *Journal de Physique IV*, 139: 215–241.
- Gaul, H., and Ziebarth, U. 1983. Methods for the analysis of lipophilic compounds in water and results about the distribution of different organochlorine compounds in the North Sea. *Deutsche Hydrographische Zeitschrift*, 36: 191–212. (Journal now re-named *Ocean Dynamics*.)
- Lakaschus, S., Weber, K., Wania, F., Bruhn, R., and Schrems, O. 2002. The air-sea equilibrium and time trend of hexachlorocyclohexanes in the Atlantic Ocean between the Arctic and Antarctica. *Journal of Environmental Science and Technology*, 36: 138-45.
- Petrick, G., Schulz-Bull, D. E., Martens, V., Scholz, K., and Duinker, J. C. 1996. An *in-situ* filtration/extraction system for the recovery of trace organics in solution and on particles – tested in deep ocean water. *Marine Chemistry*, 54: 97–105.
- Schulz-Bull, D. E., Petrick, G., Kannan, N., and Duinker, J. C. 1995. Distribution of individual chlorobiphenyls in solution and suspension in the Baltic Sea. *Marine Chemistry*, 48: 245–270.
- Sobek, A., and Gustafsson, O. 2004. Latitudinal Fractionation of Polychlorinated Biphenyls in Surface Seawater along a 62° N–89° N Transect from the Southern Norwegian Sea to the North Pole Area. *Journal of Environmental Science and Technology*, 38(10): 2746–2751.
- Sturm, B., Knauth, H. D., Theobald, N., and Wünsch, G. 1998. Hydrophobic organic micropollutants in samples of coastal waters: efficiencies of solid phase extraction in the presence of humic substances. *Fresenius Journal of Analytical Chemistry*, 361: 803–810. (Journal now re-named *Analytical and Bioanalytical Chemistry*.)
- Theobald, N., Lange, W., Rave, A., Pohle U., and Koennecke, P. 1990. Ein 100-l-Glaskugelschöpfer zur kontaminationsfreien Entnahme von Seewasser für die Analyse lipophiler organischer Stoffe. *Deutsche Hydrographische Zeitschrift*, 43: 311–322. (Journal now re-named *Ocean Dynamics*.)

Annex VIII:

References

GEOTRACES (2017). Sampling and Sample-handling Protocols for GEOTRACES Cruises (Version 3), edited by the 2017 GEOTRACES Standards and Intercalibration Committee.

HELCOM (2012a). Manual for marine monitoring in the COMBINE programme. Annex B-11, Appendix 1. Technical Note on the determination of trace metals (Cd, Pb, Cu, Co, Zn, Ni, Fe) including mercury in seawater.

HELCOM (2012b). Manual for marine monitoring in the COMBINE programme. Annex B-11 Appendix 2: Technical annex on the determination of heavy metals and persistent organic compounds in seawater. Appendix 2. Technical note on the determination of persistent organic compounds in seawater

IAEA (2012). Analysis of trace metals in biological and sediment samples: Laboratory procedure book (IAEA/Marine Environmental Studies Laboratory in co-operation with UNEP/MAP MED POL)

ICES/OSPAR (2012). JAMP guideline on monitoring of contaminants in seawater: Annex 1: Guidelines for Monitoring of Contaminants in Seawater. ICES Advice 2012, Book 1

Kingston, H.M., Barnes, I.L., Brady, T.J., Rains, T.C., and Champ, M.A. (1978). Separation of eight transition elements from alkali and alkaline earth elements in estuarine and seawater with chelating resin and their determination by graphite furnace atomic absorption spectrometry. *Analytical Chemistry*, 50 (14): 2064-2070.

Loring DH and Rantala RTT (1991). Manual for the geochemical analyses of marine sediments and suspended particulate matter. *Earth-Science Review*, 32: 235:283. Elsevier Science Publishers B.V

UNEP/IAEA (2011a). Sample work-up for the analysis of selected chlorinated hydrocarbons in the marine environment. Reference Methods for Marine Pollution Studies No 71.

UNEP/IAEA (2011b). Recommended method on the determination of petroleum hydrocarbons in sediment samples.

UNEP/MAP (2019). UNEP/MED WG.467/5. IMAP Guidance Factsheets: Update for Common Indicators 13, 14, 17, 18, 20 and 21: New proposal for candidate indicators 26 and 27.

UNEP (2019 a). UNEP/MED WG.463/6. Monitoring Protocols for IMAP Common Indicators related to pollution.

US EPA (1995). Method 1640: Determination of trace elements in ambient waters by on-line chelation preconcentration and Inductively Coupled Plasma Mass Spectrometry.