

# Study report on mercury from non-ferrous metals mining and smelting

**Draft – 10 November 2021**

## About the Study Report

1. The present study report has been developed in the context of the UNEP Global Mercury Partnership (hereinafter referred to as “the Partnership”). Initiated in 2005, the Partnership aims to protect human health and the environment from the releases of mercury and its compounds to air, water and land. With over 200 partners to date from Governments, intergovernmental and non-governmental organizations, industry and academia, the Partnership focuses its work on supporting the implementation of the Minamata Convention on Mercury, on providing state of the art knowledge and science and on raising awareness towards global action on mercury<sup>1</sup>.

2. Recognizing the non-ferrous metals sector was estimated to be a major source of mercury emissions and releases, the Partnership Advisory Group (PAG) decided at its tenth meeting (Geneva, 23 November 2019) to initiate work on the topic. In follow up to expert consultations in April 2020, Partnership area leads agreed to guide a process for developing a study report, with the aim to better understand the mercury mass balance globally between supply, storage, and waste treatment related to non-ferrous metals mining and smelting operations. As per the leads guidance, the report could also include a review of existing knowledge and information gaps concerning mercury volumes from different stages of the processes; a showcase of the different methods currently in use for reducing mercury releases and disposing mercury at different key stages of the processes, highlighting best practices, including methods of detection and monitoring of mercury releases along the processes; and potential ideas for further research and cooperation, including opportunities for capacity development.

3. Macquarie University (Australia) was commissioned to draft the report, under the overall coordination of Peter Nelson, Professor Emeritus of Environmental Studies, Department of Earth and Environmental Sciences at Macquarie University. The report also benefitted from the input of partners of the Global Mercury Partnership as well as experts and stakeholders from various organizations and background. The study report indeed benefitted from a consultative process, involving experts from governments, the private sector, civil society, academia and intergovernmental organizations, members of the Partnership, as well as from other relevant organizations. Experts provided input to the preparation of the study report and gave feedback on the draft study report and its annotated outline, including through open call for comments and an expert consultation held in April 2021. Finally, UNEP would like to acknowledge the financial contribution from the Government of Sweden who supported the development of this work.

---

<sup>1</sup>For more information, please visit: [www.unep.org/globalmercurypartnership/](http://www.unep.org/globalmercurypartnership/)

**Acknowledgements:**

*The UNEP Global Mercury Partnership wishes to thank all individuals and organizations that have contributed their expertise, time, and energy to this work, in particular Macquarie University, commissioned to draft the report, under the overall coordination of Peter Nelson, Professor Emeritus of Environmental Studies, Department of Earth and Environmental Sciences, Macquarie University.*

*The Partnership also wishes to thank the co-chairs of the Partnership Advisory Group, Mr. Rodges Ankrah (Environmental Protection Agency of the United States) and Ms. Teeraporn Wiriwutikorn (Ministry of Natural Resources and Environment of Thailand) as well as the co-leads of the Partnership Areas on Mercury Air Transport and Fate Research, Ms. Celia Chen (Toxic Metals Superfund Research Program, Dartmouth College), Mr. Nicola Pirrone (Institute of atmospheric pollution research, National Research Council of Italy), Mr. David Evers (Biodiversity Research Institute), on Mercury Releases from Coal Combustion, Ms. Lesley Sloss (International Centre for Sustainable Carbon) and Mr. Peter Nelson (Macquarie University), on Mercury Supply and Storage, Ms. Ana García (Ministry for the Ecological Transition of Spain) and Ms. Judith Torres (Ministry of Housing, Territorial Planning and Environment of Uruguay) and on Mercury Waste Management, The Ministry of the Environment of Japan and Ms. Misuzu Asari (Graduate School of Global Environmental Studies, Kyoto University) for their guidance and support.*

*Finally, the Partnership is grateful to all partners and stakeholders who provided their input to this work, including: Claudine Albersammer (International Council on Mining and Metals), Melissa Barbanell (Barbanell Environmental), Alberto Santos Capra (Secretariat of Mining, Argentina), Lilian Corra (International Society of Doctors for the Environment), Alison Dickson (Environment and Climate Change Canada, Government of Canada), Mik Gilles (International Zinc Association), Evan Granite (US Department of Energy), Katja Kraus (Federal Environment Agency, Germany), Itsuki Kuroda (Ministry of Environment, Japan), Dave Lennett (Natural Resources Defense Council), Suyu Liu (UNEP), Jianbin Meng (International Lead and Zinc Study Group and International Nickel Study Group), Guia Morelli (Institute of Geosciences and Earth Resources of the National Research Council of Italy), Dieter Offenthaler (Batrec), Mitsugu Saito (UNEP), Eisaku Toda (Secretariat of the Minamata Convention on Mercury), Shuxiao Wang (Tsinghua University) and all the experts who participated and contributed through consultative meetings to the development of the present report.*

*Internal review at UNEP: Jacqueline Alvarez (UNEP), Sandra Averous (UNEP), Kenneth Davis (UNEP), Imelda Imelda Dossou Etui (UNEP), Stéphanie Laruelle (UNEP), Monika G. MacDevette (UNEP), Akshat Rawat (UNEP).*

**Disclaimer:** *The designations employed and the presentation of the material in this publication do not imply the expression of any opinion whatsoever on the part of the United Nations Environment Programme concerning the legal status of any country, territory, city or area or of its authorities, or concerning delimitation of its frontiers or boundaries. Moreover, the views expressed do not necessarily represent the decision or the stated policy of the United Nations Environment Programme, nor does citing of trade names or commercial processes constitute endorsement.*

# Study report on mercury from non-ferrous metals mining and smelting

Draft – 10 November 2021

## CONTENTS

<b>EXECUTIVE SUMMARY – KEY HIGHLIGHTS .....</b>	<b>5</b>
<b>1. INTRODUCTION .....</b>	<b>7</b>
1.1. MERCURY IN THE ENVIRONMENT – THE NEED FOR ACTION .....	7
1.2. OBJECTIVE, METHODOLOGY AND SCOPE OF THE REPORT .....	7
1.3. MERCURY EMISSIONS AND RELEASES FROM THE NON-FERROUS SECTOR.....	8
1.3.1. Emissions of mercury to the atmosphere from the non-ferrous sector .....	9
1.3.2. Releases of mercury to land and water from non-ferrous mineral processing and mercury-containing by-products and waste .....	10
1.4. CONTRIBUTIONS OF THE NON-FERROUS SECTOR TO GLOBAL MERCURY SUPPLY.....	11
1.5. FUTURE GROWTH IN THE NON-FERROUS SECTOR.....	12
<b>2. EXISTING ACTIVITIES RELATED TO MERCURY IN THE NON-FERROUS SECTOR .....</b>	<b>14</b>
2.1. NATIONAL AND REGIONAL REGULATIONS AND GUIDELINES .....	14
2.2. INTERGOVERNMENTAL ORGANIZATIONS, INTERNATIONAL AGREEMENTS AND PARTNERSHIPS.....	15
2.2.1. UNEP Global Mercury Partnership .....	15
2.2.2. Minamata Convention on Mercury .....	15
2.2.3. The International Study Groups.....	17
2.3. INDUSTRY SECTOR ACTIVITIES.....	18
2.3.1. The International Council on Mining & Metals (ICMM) .....	18
<b>3. LIFE CYCLE OF MERCURY IN NON-FERROUS METALS MINING AND SMELTING .....</b>	<b>19</b>
3.1. INDICATIVE PROCESSES.....	19
3.1.1. Gold processing.....	19
3.1.2. Zinc extraction and processing .....	19
3.2. QUANTITATIVE STUDIES AND DATA .....	20
3.2.1. Mercury material flows in the German non-ferrous sector.....	21
3.2.2. Mercury material flows in the Japanese non-ferrous sector.....	24
3.2.3. Case Studies.....	26
3.2.4. Effects of global supply chains on embodied mercury emissions.....	26
<b>4. MERCURY EMISSIONS AND RELEASES ESTIMATES FROM THE NON FERROUS SECTOR – EXISTING KNOWLEDGE AND KNOWLEDGE GAPS .....</b>	<b>28</b>
4.1. BACKGROUND ON PREVIOUS WORK ON ESTIMATION OF MERCURY EMISSIONS AND RELEASES AND MERCURY RELEASE MECHANISMS AND SPECIATION .....	28
4.2. METHODOLOGY FOR ESTIMATING EMISSIONS AND RELEASES FROM THE NON-FERROUS SECTOR – KEY INPUTS AND KNOWLEDGE GAPS.....	31
4.3. THE IMPACT OF GLOBAL TRADE IN CONCENTRATES ON THE LOCATION OF MERCURY EMISSIONS AND RELEASES .....	35
<b>5. CONTROL OF MERCURY EMISSIONS AND RELEASES.....</b>	<b>36</b>
5.1. PROCESS DESCRIPTIONS .....	36
5.2. EMISSION CONTROL TECHNIQUES .....	37
5.2.1. Boliden Norzink Process .....	37
5.2.2. Selenium Filter.....	37
5.2.3. Activated Carbon .....	37

5.2.4.	<i>DOWA filter process</i> .....	37
5.2.5.	<i>Co-benefits of air pollution abatement technologies</i> .....	38
5.2.6.	<i>Acid plants in mercury control</i> .....	38
5.2.7.	<i>Sulfuric acid</i> .....	38
5.2.8.	<i>Process changes to eliminate smelting and emissions from that source</i> .....	38
5.3.	SMELTER/ ROASTING WASTE AND BY-PRODUCT MANAGEMENT AND RELEASES TO LAND AND WATER .....	39
5.4.	CASE STUDIES PREPARED FOR BAT/BEP GUIDANCE.....	40
<b>6.</b>	<b>MAJOR CONCLUSIONS AND IDENTIFIED NEEDS FOR FURTHER INVESTIGATION, RESEARCH AND COOPERATION</b> .....	<b>41</b>
<b>7.</b>	<b>GUIDANCE ON BEST PRACTICES</b> .....	<b>44</b>
7.1.	AVAILABLE GUIDANCE, TOOLS AND RESOURCES: <sup>[1]</sup> <sub>SEP</sub> .....	44
<b>8.</b>	<b>REFERENCES AND BIBLIOGRAPHY</b> .....	<b>45</b>
<b>9.</b>	<b>ATTACHMENT: CASE STUDIES</b> .....	<b>50</b>
1.	CASE STUDY – ZINC/LEAD SMELTER AND REFINERY .....	50
2.	CASE STUDY ON MERCURY CONTROLS FOR A GOLD ORE ROASTING FACILITY .....	52
3.	CASE STUDY: MERCURY SCRUBBING DURING ZINC SMELTING IN ISF FURNACE.....	56
4.	CASE STUDY ZINC/LEAD/COPPER PRODUCTION AT BOLIDEN RÖNNSKÄR (SWEDEN) .....	58
5.	MERCURY AIR EMISSION SOURCES AND CONTROLS - PT. SMELTING - GRESIK SMELTER & REFINERY.....	63

DRAFT

## EXECUTIVE SUMMARY – KEY HIGHLIGHTS

The present study report has been developed in the context of the UNEP Global Mercury Partnership (hereinafter referred to as “the Partnership”). Initiated in 2005, the Partnership aims to protect human health and the environment from the releases of mercury and its compounds to air, water and land.

Mercury is an extremely harmful pollutant, which due to its toxicity, long range mobility, and persistence poses a global threat to human health and the environment. Mercury can not only cause localized harm, to which children and pregnant women are especially vulnerable, through air borne emissions or soil and water contamination, but also travel long distances through the air that can reach around the globe. Mercury is a trace element in the earth’s crust, often found as cinnabar (mercuric sulfide), and present in non-ferrous metal ores such as copper, zinc, lead, aluminum, and gold. In the large-scale thermal processing, electrolysis, or refining of these ores to produce these important metals, mercury will be released.

The report aims to elucidate the fate of mercury within commercial smelters and refiners; estimate the magnitude of potential emissions and releases from the production of non-ferrous metals; and illustrate various technologies for controlling them. It has been compiled from expert consultations, and open access sources of information to present a critical review of existing knowledge and information gaps concerning mercury from the non-ferrous sector, showcase the different reduction methods, and provide relevant suggestions for further work including capacity development.

Non-ferrous metals are all metals apart from iron. The emphasis in this report is on copper, lead, zinc and large scale gold, which all have significant emissions and releases of mercury and are included in the Minamata Convention as a point source category of emissions. It does not include consideration of the primary mining of mercury, nor the use of mercury in artisanal and small-scale gold mining (ASGM).

### **Key highlights:**

The non-ferrous sector is a large anthropogenic source of mercury emissions estimated to account for more than 300 tonnes per year - around 10-15 %of global mercury emissions to the atmosphere, the third largest source. Estimates of releases to water from the sector represent about 40% of total releases with more than 200 tonnes per year, mostly from large scale gold production. Much larger amounts are estimated to be released to land, but these include secure impoundments such as controlled tailings piles or engineered landfills, and it is clear that a great deal remains unknown about this pathway of mercury pollution.

By-product mercury recovery from non-ferrous mining and processing operations is an important source of global mercury supply, estimated at around 500 tonnes per year or about 15% of total global supply. Many countries generate by-product mercury, however, due to restrictions on mercury export (e.g. in the United States of America and the European Union), which may reduce this potential source of supply, not all generated by-product makes its way to the market. Available data should be strengthened to better understand the importance of the sector as a source of mercury supply.

The non-ferrous metals sector is likely to grow considerably over the next 30 years. It is hence critical to address existing uncertainties and knowledge gaps in order to improve our understanding and assist global efforts to reduce the contribution from the sector. Enhanced information is particularly needed with respect to mercury content in ores and concentrates, including at plant and country level; mercury air emissions test data (e.g., stack testing); mercury concentrations in reject material and mercury distributions between emissions and other releases; activity data (amounts of ores and concentrates processed) as well as effects of pollution control technologies and how it may be affecting the distribution of mercury between emissions to air, and capture in solid and liquid waste streams.

Additional quantitative information on how mercury departs to emissions and releases to air, land, water, waste and by-products would also further support a better understanding of mercury fate and transport in non-ferrous metals mining and smelting.

The development of effective and sustainable regional solutions to secure sufficient capacity for the safe and long term storage of mercury is a high priority. Innovative methods for the secure storage of mercury would also support the sound management of mercury by-products and mercury containing wastes, especially that the non-ferrous sector is expected to grow considerably in the future as additional uses grow in infrastructure and devices, and as the world population and GDP increases.

Geographical distribution of the sector also impacts effective quantification of mercury concentrations and therefore influences measures for the reduction of emissions and releases.

In terms of best practices and control measures, the choice of the processing technology may greatly impact mercury emissions and further research and development on improvements to mineral processing should be a high priority.

Finally a number of priority areas would benefit from capacity-building. These relate in particular to further investigations and information sharing on mercury fate and other impurities during the mining and smelting of copper, lead and zinc, which belong to the top 5 largest internationally traded commodities; collection of additional information on large scale gold production identified as a significant contributor to emissions and releases; and support towards further dissemination of information and awareness-raising on existing best practices and case studies on mercury in the non-ferrous sector, including mercury removal systems, off-gas cleaning systems in smelters, risks mitigation measures as well as options for environmentally sound interim storage and disposal of mercury.

DRAFT

# 1. INTRODUCTION

## 1.1. Mercury in the Environment – the need for action

“Mercury is a chemical of global concern owing to its long-range atmospheric transport, its persistence in the environment once anthropogenically introduced, its ability to bioaccumulate in ecosystems and its significant negative effects on human health and the environment”. (first preamble of the Minamata Convention on Mercury).

Mercury is emitted to the atmosphere and released to water and land as a result of anthropogenic activities, as well as from natural sources such as volcanoes and rock weathering. Mercury in the air can be carried around the world, eventually being deposited onto soils, waters, or plants. From there, mercury can re-volatilize into the air, or be transported further by water, or be taken into the food web<sup>2</sup>. It can persist in the elemental form for long periods of time. Elemental mercury is highly water insoluble. Elemental mercury in the atmosphere, Hg<sup>0</sup><sub>(gas)</sub>, has a residence time of at least several months, and can circle the globe before it is oxidized by species such as halogens and ozone. Compounds of mercury typically have some water solubility and are scrubbed from the atmosphere by precipitation. The mercury scrubbed by precipitation may enter the food chain, methylated by microorganisms present within ponds, streams, rivers, lakes, and oceans. Once transformed into methylmercury, mercury can contaminate the food chain, as it bioaccumulates and biomagnifies in fish and shellfish. It can be present at particularly high levels in large predator fish at the top of the aquatic food chain such as swordfish, shark, tuna, and mackerel.

Mercury is considered by WHO as one of the top ten chemicals or groups of chemicals of major public health concern. It harms the nervous system, heart, kidneys, and other systems of the body. Children, infants and fetuses are at the highest risk because of their developing nervous systems. A significant pathway for human exposure is through the ingestion of contaminated seafood. As globally fish provides over 3.3 billion people with almost 20% of their animal protein<sup>3</sup>, and this can have major impacts on the global burden of disease (UNEP 2013b). In small island states and coastal regions this amount can increase to 50% or more (FAO 2020). A US study estimated cumulative lifetime benefits from measures to be implemented through the Minamata Convention for individuals affected by 2050 at \$339 billion (Giang and Selin 2016).

## 1.2. Objective, methodology and scope of the report

The present report has been developed in the context of the UNEP Global Mercury Partnership (GMP), where in spite of the significance of the non-ferrous sector as a source of mercury emissions and releases (Kerfoot *et al.* 2004, AMAP/UNEP 2019), the issue had received less attention than other significant sources.

The report aims to present a critical review of existing knowledge and information gaps concerning mercury from the non-ferrous sector; a showcase of the different methods currently in use for reducing mercury emissions and releases and disposing of mercury from mining and smelting at different key stages of the processes; and suggestions for further work including capacity development. It compiles information from expert consultations<sup>4</sup>, and open access sources of information, including published reports and toolkits, websites and the peer reviewed scientific research literature.

---

<sup>2</sup> UNEP 2019, Global Mercury Assessment -2018

<sup>3</sup> Average between 2015 and 2017. FAO. 2020. The State of World Fisheries and Aquaculture 2020. Sustainability in action. Rome

<sup>4</sup> A draft annotated outline of the study report was presented for consideration by the PAG at its eleventh meeting (15 and 16 December 2020). Together with the information collected, the finalized annotated outline was used as a basis to develop the study report. Online expert consultations took place on 29 and 30 April 2020. The consultations were an opportunity to provide input to the draft study report developed in the context of the Partnership, share additional knowledge, data and best practice, and discuss

Non-ferrous metals are all metals apart from iron. The emphasis in this report is on copper, lead, zinc and large scale gold, which all have significant emissions and releases of mercury and are included in the Minamata Convention as a point source category of emissions. In addition, the report includes some consideration of aluminium, for which the UNEP Global Mercury Assessment also includes estimates of mercury emissions and releases, as well as of other non-ferrous metals such as nickel, for which the UNEP Mercury Toolkit enables mercury estimates from extraction and processing.

The report does not include consideration of the primary mining of mercury, or the use of mercury in artisanal and small scale gold mining (ASGM) as these have been extensively addressed in other global reports and toolkits (O'Neill and Telmer 2017; Intergovernmental Forum on Mining Minerals Metals and Sustainable Development (IGF) 2018). Current research activities include considerations of mercury geochemical speciation in bauxite (Staun *et al.* 2018) and environmental control of mercury in aluminium processing (Mimna *et al.* 2016), however these are not covered in the scope of the present report.

Secondary metals smelting is also not included in the scope of the present report. This is based on the assumption that recovered scrap metal used as secondary sources would only contain negligible amounts of mercury, as processes to produce metals from primary mineral concentrates results in the removal of their potential mercury content during the thermal processing. There may be small amounts of mercury released during the recycling of zinc batteries, however the mercury content of batteries is expected to decrease significantly in the future, as all applications are now able to be performed without mercury (International Zinc Association 2021). As the amounts of metals recycled increase and as these activities occur in more locations, mercury emissions from secondary metals smelting may however benefit from enhanced attention. This issue may prove particularly relevant for general waste recovery facilities or secondary smelting of electronic material, which may produce significant mercury emissions (UNEP 2019b).

### **1.3. Mercury emissions and releases from the non-ferrous sector**

Mercury exists as a trace element in many ore bodies of non-ferrous metals and the mining and processing of these ores has the potential to mobilize mercury and emit it to the atmosphere, or to release it to land and water. Waste rock and tailings that are created during the mining may result in exposure of the mercury to oxygen and water which can result in releases to water systems or in leaching processes which result in mercury release to soil. These processes are addressed below in Section 1.3.2 on releases. However, unlike ASGM, the mining process is not considered to be a significant source of mercury emissions to the atmosphere for industrial scale processing (UNEP 2019c).

Mercury may also be recovered during processing as a by-product and then contribute to mercury supply, trade and demand (see Section 1.4).

Thermal processing (such as smelting, roasting and other high temperature operations) of metallurgical raw materials have the potential to release mercury to the atmosphere, and to land and water. The main aim of the smelting and roasting processes, which are forms of extractive metallurgy, is to convert metals from their native state in ores to pure metals. Metals commonly exist in nature as oxides, sulfides, or carbonates and the smelting process requires a chemical reaction in the presence of a reducing agent to liberate the metal. At high temperatures mercury becomes highly volatile and is released to the gas phase, or may condense on fine particles produced in the processing.

The reduction of mercury emissions to the atmosphere potentially results in residual mercury in residues, slags and sludges from the processing operations, and solid and liquid streams from the air pollution control devices. Some of this mercury is recovered as a by-product and used in specific applications (limited by national regulatory frameworks) or treated as waste, but significant quantities may be released to land and water in

---

suggestions for future work. Participants were invited to attend in their expert capacity, to share views and ideas, as well as any useful background information.



the absence of environmentally sound management. The stability and ultimate disposition of mercury contained within the spent sorbents such as activated carbons; the used scrubbing solutions such as sulfuric acid; or in the solid particle by-products collected from electrostatic precipitators or baghouses, needs to be determined. Permanent sequestration of the mercury is a long-term goal for pollution control, so that mercury captured at a smelter for instance does not have the opportunity to be re-emitted into the environment elsewhere.

### 1.3.1. Emissions of mercury to the atmosphere from the non-ferrous sector

The UNEP Global Mercury Assessments (GMAs) (AMAP/UNEP 2008; AMAP/UNEP 2013; AMAP/UNEP 2019) all conclude that metal production in general, and non-ferrous metal production in particular, is a large anthropogenic source of mercury emissions estimated to account for around 10-15 % of global mercury emissions to the atmosphere. In the most recent GMA non-ferrous metals mining and smelting was estimated<sup>5</sup> (AMAP/UNEP 2019) to be the third largest source of mercury emissions to air. Table 1 presents details of the estimated contribution of various sectors to emissions to air in 2015 (UNEP 2019a).

Table 1: The estimated quantities of mercury emitted to air from anthropogenic sources in 2015, by different sectors (UNEP 2019a)

Sector	Mercury Emissions (range), tonnes	Sector % of total
Artisanal and small-scale gold mining (ASGM)	838 (675-1000)	37.7
Biomass burning (domestic, industrial and power plant)	51.9 (44.3-62.1)	2.33
Cement production (raw materials and fuel, excluding coal)	233 (117-782)	10.5
Chlor-alkali production (mercury process)	15.1 (12.2-18.3)	0.68
Non-ferrous metal production (primary Al, Cu, Pb, Zn)	228 (154-338)	10.3
Large-scale gold production	84.5 (72.3-97.4)	3.8
Mercury production	13.8	0.62
Stationary combustion of coal (domestic/residential, transportation)	55.8 (36.7-69.4)	2.51
Stationary combustion of coal (power plants)	292 (255-346)	13.1
Vinyl-chloride monomer (mercury catalyst)	58.2 (28.0-88.8)	2.6
Waste (incineration and other emissions from all waste streams)	162 (129-255)	7.3
<b>Total</b>	<b>2220 (2000-2820)</b>	

With respect to emissions, the latest GMA assessment (UNEP 2019a) estimated that 326 tonnes of mercury originated in 2015 from the production of non-ferrous metals (aluminum, copper, large scale gold, lead, zinc and mercury), representing about 15% of total emissions. Zinc, large scale gold, copper and lead dominated these estimates, of which they respectively accounted for 43%, 26% , 15% and 10%, followed by primary mercury and aluminum. Total mercury emissions were estimated at 140 tonnes for zinc, 84.5 tonnes for large scale gold, 50 tonnes for copper and 30 tonnes for lead.

<sup>5</sup> <https://www.unep.org/globalmercurypartnership/resources/report/global-mercury-assessment-2018>, metals included were aluminium, lead, copper, zinc and large scale gold

The GMA noted that estimated emissions from non-ferrous metal production had relatively large uncertainties, with a range 32% lower to 48% higher for primary production of aluminum, copper, lead and zinc, and similar uncertainties for large scale gold production. An alternative estimate (International Zinc Association 2021) has been made for mercury emissions from zinc production has been made which is substantially lower than the GMA assessment (UNEP 2019a). This will be discussed in further detail in Section 0 below.

### **1.3.2. Releases of mercury to land and water from non-ferrous mineral processing and mercury-containing by-products and waste**

The GMA report also noted that with an estimated 240 tonnes per year, the sector was responsible for roughly **40% of total releases to water, which makes it the largest source of mercury releases to water after artisanal and small-scale gold mining**. A quarter of these releases was estimated to be from large-scale gold production. However this estimate is based on the assumption that where wet gas cleaning technology is used, the mercury is “re-allocated from the air pathway” to water and land among other pathways. At many mines, the normal practice is for water that is used in gas cleaning to be re-circulated back into the process and not released to the environment<sup>6</sup>.

In addition to direct releases to water, **non-ferrous metals are estimated to contribute large quantities to the land, waste products and storage of mercury** (UNEP 2019a). The industrial waste materials include carbon contaminated with mercury, recovered elemental mercury and calomel (mercurous chloride, Hg<sub>2</sub>Cl<sub>2</sub>). All of these indirect releases contribute to the complex processes of the global mercury cycle. Zinc production is responsible for an estimated 4200 tonnes of mercury per year (UNEP 2019a). Large-scale gold mining is estimated to put 2700 tonnes of mercury into soils each year (UNEP 2019a), 45 times more than it releases directly to water. A rough estimate of anthropogenic mercury input to soils is 7000-8000 tonnes and hence the non-ferrous sector is a major contributor (UNEP 2019a). These estimates may not reflect current industrial practice where process water is often recycled, and by-products and waste are disposed of in engineered facilities. However this mercury remains a potential secondary source of emissions to the atmosphere and releases to water depending on the long term stability of the storage solutions. **A great deal remains unknown (UNEP 2019a) about this pathway of mercury pollution, making it an important subject for future study.**

Somewhat lower estimates of mercury resulting from zinc production have been made by the IZA (International Zinc Association 2021) at 1470 tonnes/year if tailings are included, compared to 4200 tonnes/year estimated in the GMA (AMAP/UNEP 2019). It is clear that much of the mercury from contemporary mineral processing operations is not released in an uncontrolled fashion to the environment but is collected in hazardous waste disposal facilities or stabilized as cinnabar and disposed in purpose built facilities (International Zinc Association 2021). Some may also form part of the mercury supply chain but this is declining (International Zinc Association 2021). The long term security of these forms of storage requires continuing management and monitoring/verification to ensure mercury is not slowly released to the environment.

Identified as a source category in the UNEP Mercury Inventory Toolkit (UNEP 2017b; UNEP 2019b), countries with occurrence of non-ferrous metals mining and smelting production have reported mercury releases from the sector in the inventory conducted as part of their Minamata Initial Assessment. While information currently available from these inventories does not allow for a global picture of the mercury generated by the sector, the 2019 Global Mercury Synthesis report produced by UNEP in partnership with the Biodiversity Research Institute (Burton and Evers 2019), indicated the prevalence of primary metal production in the studied inventories, with industrial gold production appearing as a dominant sector. Regarding the latter, **the need for more information on the mercury content in ores, including at country level, was highlighted** (Burton and Evers 2019), in order to properly assess the burden of the sector and further refine and develop the Toolkit.

---

<sup>6</sup> C Albersammer, ICM, personal communication

It should be noted that the default factors suggested in the Toolkit are based on a limited data base and as such, should be considered subject to revisions as the data base grows. Therefore, it may be appropriate to review, and confirm to the extent feasible, main source specific data for local/national conditions, hence allowing to determine the costs and benefits of mitigation measures prior to their implementation.

The issue of releases to land and water more broadly is currently under discussion in the Group of Technical Experts on releases established by the Conference of the Parties to the Minamata Convention at its second meeting (decision MC-2/3). The work program<sup>7</sup> of this group of technical experts was established to produce a report including:

- draft guidance on the methodology for preparing inventories of releases,
- the proposed categories of point sources of releases, and
- a road map for the development of guidance on best available techniques and best environmental practices.

Non-ferrous metals have been listed as point sources of releases. The work of this group will inform the issues concerning releases from the non-ferrous sector.

#### **1.4. Contributions of the non-ferrous sector to global mercury supply**

**By-product mercury recovery from non-ferrous mining and processing operations is an important source of global mercury supply, estimated at about 15% in the UNEP Global Mercury Supply, Trade and Demand report 2017<sup>8</sup>** (UNEP 2017a). As noted above, mercury occurs at low concentrations in many non-ferrous ores. If the concentration of mercury is high enough to justify removal, methods exist to produce mercury of the necessary purity for sale and/or supply. This by-product mercury is typically in the form of calomel, metallic (elemental) mercury, or it may be adsorbed on activated carbon filters or at other points in the removal process (UNEP 2017a).

Subject to adequate controls being in place to avoid any potential for secondary sale to illegal applications, use of this by-product mercury is preferable to extracting mercury from new mining operations. However it is probable that most of the recovered mercury still goes to disposal or is released to the environment (AMAP/UNEP 2013; AMAP/UNEP 2019). In some locations such as the US a substantial amount of this mercury may go to long-term storage (USEPA Office of Air and Radiation 2021). For these and other reasons, including a paucity of reliable data, estimates of how much by-product mercury from the non-ferrous sector is eventually marketed is problematic (UNEP 2017a). In any case the environmentally sound disposal of mercury is the best case solution but if it is to be sold it should only be done in ways allowed by the Minamata Convention. The worst case is if the by-product mercury is improperly disposed, or if it is sold to ASGM or non-allowed uses.

The Global Mercury Supply, Trade and Demand Report (UNEP 2017a) describes in detail, using government and industry data, estimations of by-product mercury production and marketing for a range of major non-ferrous metal producing countries. The estimates are presented in Table 2, and show that **many countries generate by-product mercury but not all makes its way to market. Restrictions on mercury export (e.g., in the United States and Europe) reduce this source of supply but it is still significant.**

---

<sup>7</sup> <https://www.mercuryconvention.org/en/implementation/intersessional-work#sec968>

<sup>8</sup> <https://www.unep.org/globalmercurypartnership/resources/report/global-mercury-supply-trade-and-demand>

Table 2: Global by-product mercury production, 2015 (from (UNEP 2017a))

Country/Region	By-product Source	Mercury captured (tonnes)	Mercury marketed (Tonnes)
Russia	Gold ores	40-70	40-70
Peru, Chile, Argentina	Gold, zinc, copper ores	150-200	100-150
Tajikistan	Antimony ores	30-40	20-30
China	Zinc, antimony ores	120-240	100-200
United States	Gold, silver ores	150-250	20-30
European Union	Non-ferrous concentrates	No estimate	50-100
Mexico	Silver ores	25	25
Japan	Zinc ores	20-30	20-30
Other countries	Zinc ores	100-300	20-60
Other countries	Gold, copper, lead, antimony ores	100-200	30-50
<b>Total</b>		<b>735-1355</b>	<b>425-745</b>

The International Council on Mining & Metals (ICMM) recently provided an overview of mercury waste in metal production<sup>9</sup>. Commercial sale of elemental mercury or calomel is often now not possible due to the absence of internal markets and export bans. **“Most western world plants report that they no longer sell mercury or calomel”**<sup>9</sup>. Disposal of elemental mercury and calomel is also subject to location specific environmental regulations, in some countries in hazardous waste disposal facilities (e.g., Germany, Canada)<sup>9</sup>. In the view of the ICMM, **“Companies are increasingly treating by product mercury as waste and managing it by using long term secure storage facilities or permitted disposal facilities”**<sup>9</sup>. **Effective and sustainable regional solutions to secure sufficient capacity for the safe and long term storage of mercury is hence a high priority.**

### 1.5. Future growth in the non-ferrous sector

**The non-ferrous sector is likely to grow considerably over the next 30 years.** In a study (Elshkaki *et al.* 2018) of resource demand scenarios for the major metals (in this case manganese, aluminium, copper, nickel, zinc and lead) several scenarios of future metal demand were calculated from 2010 to 2050 under alternative patterns of global development. **The calculated demand for each metal doubles or triples relative to 2010 levels by mid-century.** Hence, if these projections come to pass, without mitigation measures in place, this sector could make increasing contributions to global mercury emissions and releases.

There is also a recognition ((World Economic Forum 2010; World Economic Forum 2014; World Economic Forum 2015) that the production of metals requires a long term commitment to increased recycling and reuse while ensuring energy efficient and environmentally friendly production. In mining dependent countries there may also be a need to adjust economies to ensure adding a significant share of downstream value to their mining sectors (World Economic Forum 2015). Such adjustments would represent significant change: for

<sup>9</sup> Presentation at Minamata Online webinar on “Mercury Waste in Metal Production”, 15 October 2020, at [https://www.mercuryconvention.org/sites/default/files/inline-files/news/Portals/11/documents/Presentations/15Oct\\_Melissa\\_Barbanell.pdf](https://www.mercuryconvention.org/sites/default/files/inline-files/news/Portals/11/documents/Presentations/15Oct_Melissa_Barbanell.pdf)

example, in Peru mineral production represents a value of 16% of GDP, and contributes 63% to exports; in Zambia the corresponding figures are 43% and 84%.

**As the non-ferrous sector has the potential to make significant and growing contributions to mercury emissions and releases to the global cycling of mercury, it is important for effective environmental engineered controls to remain in place where they already exist and for them to be introduced where they are still needed.**

It is also notable that non-ferrous metals are abundant in South America<sup>10</sup> and are more likely to be developed in coming years. The continent's copper reserves represent more than one-quarter (International Bank for Reconstruction and Development/The World Bank 2017) of the world's known reserves, nearly all of which are found in Chile and Peru<sup>10</sup>. In Chile the Chuquicamata deposits of the northern Atacama Desert contain the largest amounts of copper known in the world and have ores containing 2.5 % copper. Peru's most important deposits are found in the country's central Andean ranges, as well as in the south. Lead and zinc are dispersed among many countries but are found in greatest abundance in the central Andes of Peru; in the state of Minas Gerais, Brazil; in highland Bolivia; and in the northern Argentine Andes.

#### **Mercury and the non-ferrous metals sector**

- Mercury exists as a trace element in many ore bodies of the non-ferrous metals and the mining and mineral processing of these ores has the potential to mobilize mercury and emit it to the atmosphere, or to release it to land and water
- The non-ferrous sector is a large anthropogenic source of mercury emissions estimated to account for more than 300 tonnes per year - around 10-15 per cent of global mercury emissions to the atmosphere, the third largest source
- Estimates of releases to water are also high at more than 200 tonnes per year, about 40% of the total releases much of it from large scale gold production
- Much larger amounts are estimated to be released to land, but a great deal remains unknown about this pathway of mercury pollution
- By-product mercury recovery from non-ferrous mining and processing operations is an important source of global mercury supply, estimated at around 500 tonnes per year or about 15% of the total global supply
- The non-ferrous sector is likely to grow considerably over the next 30 years

---

<sup>10</sup> <https://www.britannica.com/place/South-America/Mineral-fuels>

## 2. EXISTING ACTIVITIES RELATED TO MERCURY IN THE NON-FERROUS SECTOR

### 2.1. National and regional regulations and guidelines

Regulations to control industrial emissions and releases, including from the non-ferrous sector have been in operation and development for many years at both national and regional levels. It is beyond the scope of this report to describe these measures in detail but some brief comments are provided below.

In the US extensive study of the issue of mercury pollution resulted in the Mercury Study Report to Congress (USEPA 1997a; USEPA 1997b), and follow up studies and regulations were completed for certain sectors, for example, gold mining and processing. In 2011, the U.S. Environmental Protection Agency (EPA) promulgated National Emissions Standards for Hazardous Air Pollutants for gold ore processing and production facilities<sup>11</sup>, the seventh largest source of mercury air emission in the United States. It was estimated that this measure would reduce mercury emissions by 1,460 pounds per year, or about a 77 % reduction from 2007 levels. The Nevada Mercury Air Emissions Control Program<sup>12</sup>, which requires controls at precious metal mining facilities, also resulted in significant reductions in mercury emissions and releases. Standards were also introduced for other mineral processing facilities.

Similarly in Canada, “Canada-wide Standards for Mercury Emissions” (Canadian Council of Ministers of the Environment 2000) from base metal smelting facilities were adopted in 2000<sup>13</sup>, and in 2006 the federal government published a Pollution Prevention Plan Notice for the sector with targets for mercury emissions to air.

In Europe, the Best Available Techniques (BAT) Reference Document for the Non-Ferrous Metals Industries (European Commission (Joint Research Centre) *et al.* 2017) includes BAT-associated emission limits (AEL) for mercury. The European Environment Agency also tracks emissions of heavy metals over time<sup>14</sup>, extending back to 1990. Legislation and multinational agreements are in place to address heavy metals, including:

- the 1998 Aarhus Protocol on Heavy Metals (to the 1979 United Nations Economic Commission for Europe (UNECE) Convention on LRTAP), which targets three particularly harmful substances: Cd, Hg and Pb;
- EU Directive 2001/80/EC on the limitation of emissions of certain pollutants into the air from large combustion plants (the LCP Directive), which aims to limit heavy metal emissions via dust control and absorption of heavy metals;
- EU Directive 2010/75/EU on industrial emissions (integrated pollution prevention and control) (EU, 2010), which aims to prevent or minimize pollution of water, air and soil; this directive targets certain industrial, agricultural and waste treatment installations;
- the European Pollutant Release and Transfer Register (E-PRTR) Regulation (166/2006/EC), under the requirements of which emissions of a number of heavy metals released from certain industrial facilities are also estimated and reported

Many countries also have reporting systems in place for national emissions to air (e.g., the US National Emissions Inventory (NEI)<sup>15</sup> and the Toxics Releases Inventory (TRI)<sup>16</sup>; Australian National Pollutant

---

<sup>11</sup> <https://www.epa.gov/stationary-sources-air-pollution/gold-mine-ore-processing-and-production-national-emission-standards>

<sup>12</sup> <https://ndep.nv.gov/air/nevada-mercury-control-program-nmcp>

<sup>13</sup> [https://ccme.ca/en/res/cws\\_mercury\\_emissions\\_e.pdf](https://ccme.ca/en/res/cws_mercury_emissions_e.pdf)

<sup>14</sup> <https://www.eea.europa.eu/data-and-maps/indicators/eea32-heavy-metal-hm-emissions-2>

<sup>15</sup> <https://www.epa.gov/air-emissions-inventories/national-emissions-inventory-nei>

<sup>16</sup> <https://www.epa.gov/toxics-release-inventory-tri-program>

Inventory<sup>17</sup>; the UK National Atmospheric Emissions Inventory (NAEI)<sup>18</sup>; the Canadian National Pollutant Release Inventory and Air Pollutant Emissions Inventory<sup>19</sup>), which include mercury and other heavy metals.

In the most recent GMA, national estimates of emission were compared with the results of the previous GMAs. It was noted (AMAP/UNEP 2019) that the recent initiatives of Minamata Initial Assessments (MIAs) or Minamata National Action Plans (NAPs) have resulted in a large increase in the numbers of countries preparing new national inventories or national emission/release estimates. The importance of the non-ferrous sector to mercury emissions and releases in a number of Latin American countries<sup>20</sup> was highlighted in the inventories carried out in the context of Minamata Initial Assessments.

## **2.2. Intergovernmental Organizations, International Agreements and Partnerships**

### **2.2.1. UNEP Global Mercury Partnership**

Initiated in 2005 by the UNEP Governing Council, the UNEP Global Mercury Partnership aims to protect human health and the environment from the releases of mercury and its compounds to air, water and land. With over 200 partners to date from Governments, intergovernmental and non-governmental organizations, industry and academia, the Partnership focuses on supporting timely and effective implementation of the Minamata Convention on Mercury, providing state of the art knowledge and science and raising awareness towards global action on mercury.

The Partnership is structured around eight partnership areas- that are reflective of the major mercury emission and release sectors, or source categories<sup>21</sup>. Despite discussions on the relevance of an area of work on “mercury releases from non-ferrous metals mining” dedicated to “non-ferrous metals”, none is currently devoted to the sector. Work under the Partnership is undertaken within as well as across Partnership areas on topics identified as cross cutting, as in the present case. The Partnership areas on mercury waste management, mercury air transport and fate research and mercury supply and storage are of relevance to various aspects related to mining and metal production.

In spite of the lack of a Partnership Area, it is also clear from the material gathered from this report that there has been substantial progress in addressing the issue of mercury emissions and releases from the non-ferrous sector, not least because it is addressed under the Minamata Convention. Government regulators, industry and NGOs have all contributed to this progress.

### **2.2.2. Minamata Convention on Mercury**

Adopted in 2013, the Minamata Convention on Mercury is an international legally binding instrument aiming at protecting human health and the environment from anthropogenic emissions and releases of mercury and mercury compounds. The Minamata Convention contains provisions that relate to the entire life cycle of mercury and addresses issues of mercury supply, trade, uses, emissions, releases, storage and disposal, providing the framework for countries to take coordinated actions to reduce the concentration of this toxic metal in the environment. Articles 3 (mercury supply sources and trade), 8 (emissions), 9 (releases), 11 (mercury wastes), and 12 (contaminated sites) are all of potential relevance to the non-ferrous sector.

---

<sup>17</sup> <https://www.npi.gov.au/>

<sup>18</sup> <https://naei.beis.gov.uk/>

<sup>19</sup> <https://www.canada.ca/en/environment-climate-change/services/pollutants/air-emissions-inventory-overview.html>

<sup>20</sup> [https://www.mercuryconvention.org/sites/default/files/inline-files/news/Portals/11/documents/Presentations/15Oct\\_Gabriela\\_Medina.pdf](https://www.mercuryconvention.org/sites/default/files/inline-files/news/Portals/11/documents/Presentations/15Oct_Gabriela_Medina.pdf)

<sup>21</sup> Areas are: artisanal and small scale gold mining (ASGM), mercury releases from coal combustion, mercury cell chlor-alkali production, mercury in products, mercury air transport and fate research, mercury waste management, mercury supply and storage, mercury releases from the cement industry

Article 8 of the Convention stipulates measures to be taken by parties to control and, where feasible, reduce emissions of mercury and mercury compounds. In addition, it suggests separate approaches for new and existing sources. For new sources, these measures require the use of best available techniques and best environmental practices (BAT/BEP). For existing sources, Parties shall include in any national plan and shall implement one or more of the following measures: a quantified goal; emission limit values; BAT/BEP; a multi-pollutant strategy capable of producing co-benefits for control of mercury emissions; and, alternative measures.

The Convention identifies smelting and roasting processes used in the production of lead, zinc, copper and industrial gold among the source categories (listed in its annex D) for which Parties are required to take measures to control emissions of mercury and mercury compounds to the atmosphere.

#### *Minamata Convention Article 8 Guidance*<sup>22</sup>

A BAT/BEP guidance was developed by a technical experts group and adopted by the first meeting of the Conference of the Parties to the Minamata Convention to support Parties in meeting the requirements of Article 8. Details of the guidance for the non-ferrous sector can be found under section 6 of this document.

The guidance (UNEP 2019b) includes:

- guidance on best available techniques and best environmental practices,
- guidance on criteria that parties might develop pursuant to paragraph 2 (b) of article 8,
- guidance on preparing inventories of emissions, and
- guidance on support for parties in implementing the measures set out in paragraph 5 of article 8, in particular in determining goals and in setting emissions limit values.

The guidance functions as a crucial source of information, criteria and support as Parties to the Convention develop responses to the requirements to reduce and where possible eliminate mercury emissions from the sources included in Annex D, amongst which smelting and roasting processes used in the production of non-ferrous metals, namely for the purpose of this Annex, lead, zinc, copper and industrial gold). The guidance includes a section dedicated to addressing sound management measures for smelting and roasting processes for industrial gold, lead, zinc and copper. Amongst other issues, it also provides recommendations in terms of the production of sulfuric acid that takes place as part of the exhaust gas cleaning process at many metals production sites.

While Article 8 focuses on emissions to the atmosphere, Article 9 addresses the releases to land and water of mercury and mercury compounds from significant anthropogenic point sources that are not addressed in other provisions of the Convention. In contrast to Article 8, the sources of releases are not identified, and Parties are to identify relevant sources in their territories, which are any significant point sources of release not addressed in other provisions of the treaty.

At the request of the Convention's Conference of the Parties, a group of technical experts<sup>23</sup> was established to produce a report including draft guidance on the methodology for preparing inventories of releases to land and water bodies, the proposed categories of point sources of releases and a road map for the development of guidance on best available techniques and best environmental practices. The guidance is to support Parties to identify relevant point sources and control their mercury releases. Non-ferrous metals have been proposed as point sources of release. It is expected that the fourth meeting of the Conference of the Parties to the Minamata Convention (COP-4) will be presented for consideration and possible adoption the inventory guidance and for consideration the road map to develop BAT/BEP guidance on releases.

---

<sup>22</sup> <https://www.mercuryconvention.org/en/about/forms-guidance>

<sup>23</sup> <http://mercuryconvention.org/Meetings/Intersessionalwork/tabid/8279/language/en-US/Default.aspx>



Article 11, which deals with mercury waste, requires the Conference of the Parties to establish thresholds for defining those. Managing mercury waste is a long-term imperative of the Convention and work is currently in progress. COP-3 agreed on the definition of certain types of mercury waste and requested the group of technical experts established at COP-2, to further work on the thresholds for waste contaminated with mercury and for mine tailings. Work to update the guidelines for the environmentally sound management of mercury waste, which Parties to the Minamata Convention shall take into account in the environmentally sound management of mercury waste, is currently underway under the Basel Convention<sup>24</sup>.

### **2.2.3. The International Study Groups**

The International Lead and Zinc (ILZSG)<sup>25</sup> and International Copper (ICSG)<sup>26</sup> Study Groups have also engaged with the global initiatives in environmental mercury management.

The International Copper Study Group (ICSG), the International Lead and Zinc Study Group (ILZSG) and the International Nickel Study Group (INSG) are intergovernmental organizations with a total membership of 37 countries plus the European Union across Asia, Africa, Europe, the Americas and Oceania that mine, smelt, refine, use, trade and recycle lead, zinc, nickel and copper.

The Study Groups' main mandate is to promote market transparency and provide a forum in which stakeholders including governments, industry and NGOs can discuss issues of common concern and interest including environmental and health and safety issues related to resource extraction and metal production.

Since the Study Groups were admitted as observers at meetings of the Conference of the Parties to the Minamata Convention, they have been actively engaged in helping relevant industries in their member countries with the implementation and compliance with the Convention.

The Joint Secretariat of the Study Groups keeps member governments informed of the most recent developments regarding UNEP and the Minamata Convention's activities related to mercury control in the non-ferrous metals sector. It coordinates with member governments, industrial associations and companies for the better implementation and compliance with the Convention's provisions. The Joint Secretariat is actively involved in the UNEP Global Mercury Partnership's expert consultations on mercury emissions and releases from the non-ferrous metals sector. In supporting the work of the Minamata Convention, the Study Groups have provided relevant publications and studies related to environmental and health and safety issues concerning non-ferrous metals production. The Study Groups' relevant publications and studies in assisting the implementation of Minamata Convention include the Lead and Zinc Mine and Smelter Database, the Directory of Copper Mines and Plants, Environment and Health Controls on Lead, Environment and Health Controls on Zinc, Social Acceptance for Mineral and Metal Projects, Risk Factors in Developing Mineral and Metal Projects, By-Products of Lead, Zinc, Copper and Nickel, and Managing Mining, Smelting and Refining Waste<sup>27</sup>.

---

<sup>24</sup> The Conference of the Parties to the Basel Convention on the Control of Transboundary Movements of Hazardous Wastes and their Disposal adopted at its twelfth meeting the "Technical guidelines for the environmentally sound management of wastes consisting of elemental mercury and wastes containing or contaminated with mercury" (Decision BC-12/4), which it decided at its fourteenth meeting to update (Decision BC-14/8)

<sup>25</sup> <https://www.ilzsg.org/static/home.aspx?from=3>

<sup>26</sup> <http://www.icsg.org/>

<sup>27</sup> Visit <https://www.ilzsg.org/> and <https://www.icsg.org/>

## 2.3. Industry Sector activities

### 2.3.1. The International Council on Mining & Metals (ICMM)

The International Council on Mining & Metals (ICMM) brings together 28 major mining and metals companies and over 35 national, regional and commodities associations. ICMM member companies, who represent about 30% of the metals market today, have taken a number of commitments related to mercury, including to:

- Not open any mines designed to produce mercury as the primary product.
- Apply materials stewardship to promote the responsible management of the mercury produced from ICMM members' operations including the mercury which naturally occurs in their products.
- Identify and quantify point source mercury air emissions from their operations and minimize them through the application of cost effective best available technology, using a risk based approach.
- Report significant point source mercury air emissions from their operations consistent with their commitment to report in accordance with the Global Reporting Initiative (GRI)<sup>28</sup> framework.
- Participate in government-led partnerships to transfer low- to no-mercury technologies into the ASM sector in locations where ICMM member companies have operations in close proximity to ASM activity such that livelihoods are enhanced through increased productivity and reduced impacts to human health.
- Through ICMM, encourage the development of sound science on the fate and transport of mercury as well as natural sources of mercury in the environment.
- Work on an integrated multi-stakeholder strategy through ICMM to reduce and eventually cease supplying mercury into the global market once policy and economically viable long-term technological solutions for the retirement of mercury are developed.

ICMM participated as an observer in the development of the Minamata Convention (INC and COP processes), in the experts groups on air emissions, and is currently involved in the experts groups on waste and releases. In addition, ICMM provided comments to the contaminated sites guidelines, the interim storage guidelines developed in the context of the Minamata Convention and the Basel Convention technical guidelines on mercury waste management.

---

<sup>28</sup> <https://www.globalreporting.org/about-gri/mission-history/>

### 3. LIFE CYCLE OF MERCURY IN NON-FERROUS METALS MINING AND SMELTING

#### 3.1. Indicative processes

The major steps and considerations for mercury emissions, releases and control from the non-ferrous sector are described in Section 4.3 of the UNEP report “Guide for Major Uses and Releases of Mercury” (UNEP 2006). In practice these processes are complex and have important differences particularly in the case of gold. The Minamata Convention BAT/BEP guidance includes pictorial generic descriptions of the four metals covered under the Convention (lead, copper, zinc and large scale gold). Here general descriptions are given for gold and zinc (drawn from the Minamata online presentation<sup>9</sup> on mercury waste in metal production, by ICMM on 15 October 2020) in order to illustrate the complexities of metal processing, pollutant capture and waste management.

##### 3.1.1. Gold processing

Large scale gold mining now usually relies on cyanide leaching to extract gold, as large scale extraction of gold using mercury amalgamation was largely discontinued between 1950-1960s. Prior to leaching, ores may require milling, floatation, and/or pre-treatment. Most mercury will typically follow the gold concentrates. Figure 1 illustrates how mercury may be recovered from the gas stream throughout the process (from roasters, autoclaves, electrowinning, carbon regeneration, or retorts) as calomel (Boliden Norzinc scrubbers), elemental mercury (retorts), or carbon contaminated with mercury (mercury filter)<sup>9</sup>.

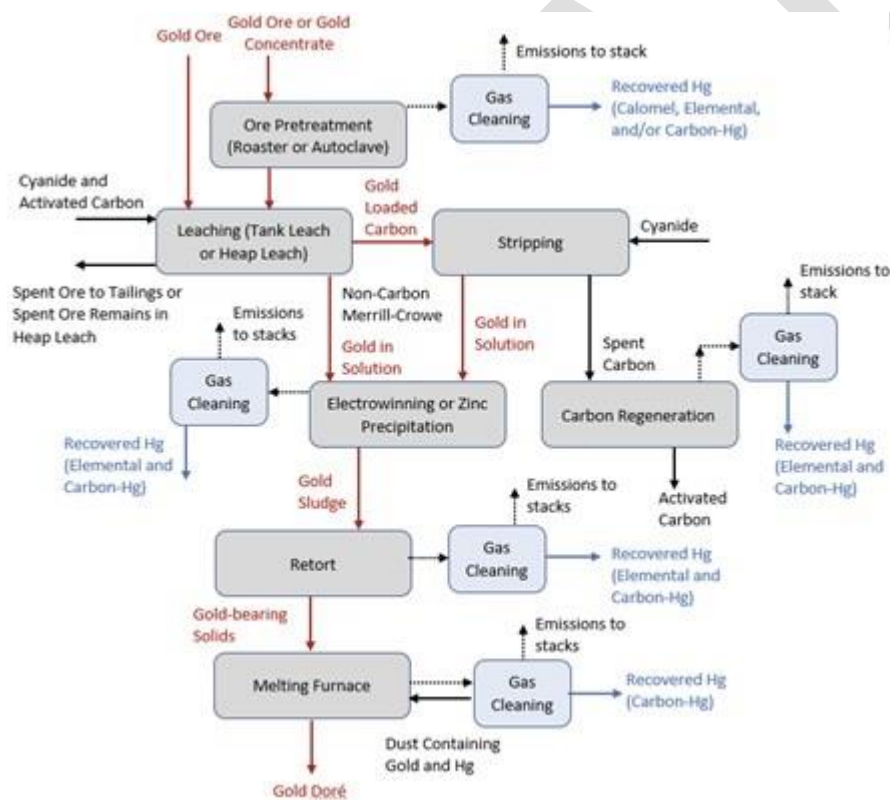

Figure 1: Example of gold production processing<sup>9</sup>

##### 3.1.2. Zinc extraction and processing

As an example of the other non-ferrous metals, Figure 2 shows the major steps in zinc processing<sup>9</sup>. The processing of other non-ferrous metals have similarities with that of zinc (further details for lead and copper are given in the Minamata Convention BAT/BEP guidance (UNEP 2019b)). Mercury flows in zinc mining initially

consist of the milling of zinc deposits and separation from gangues by sulfide flotation. Most mercury will typically follow the zinc concentrate. In the refining steps most of the mercury is recovered from the gas stream during concentrate roasting. The mercury is then recovered as a waste acid or in a more concentrated form from a mercury filter. Removal of mercury is required to achieve quality specification for commercial sulfuric acid.

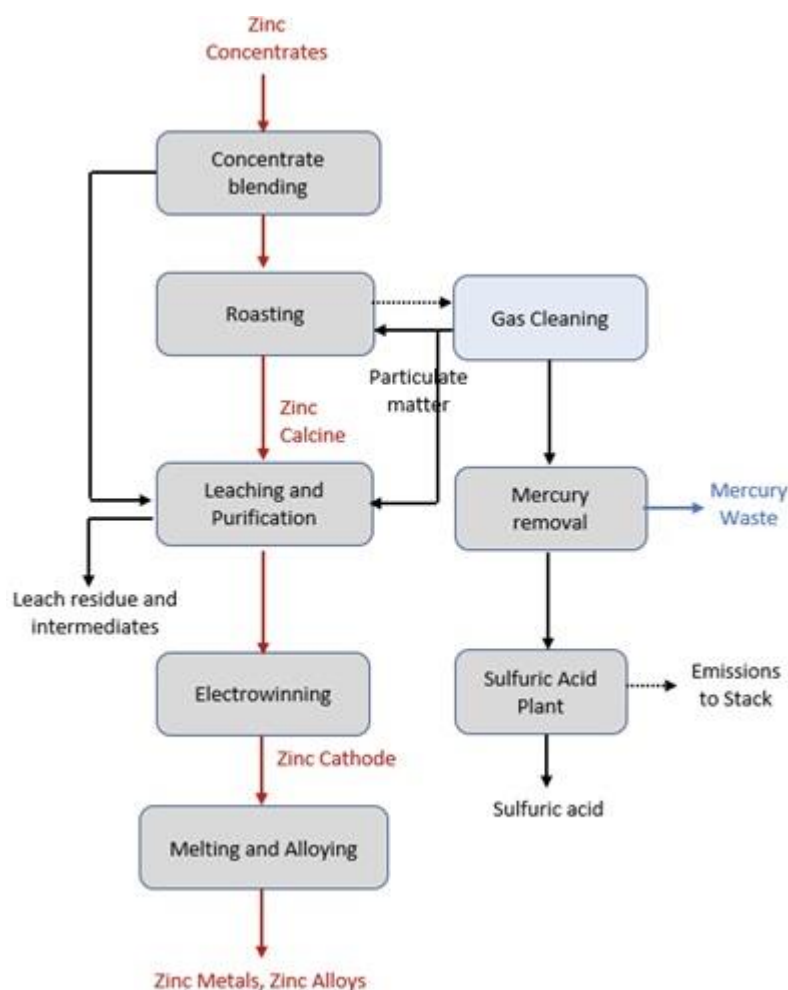

Figure 2: Zinc production process<sup>9</sup>

### 3.2. Quantitative studies and data

As described above additional quantitative information on how mercury reports to emissions and releases to land and water and to waste and by product material are needed.

Recent studies from China have provided some of this information (Tsinghua University 2019; Zhang *et al.* 2019). The Natural Resources Defence Council (NRDC) has recently produced two reports in China, partnering with experts and local NGOs to promote more effective mercury air emissions controls, quantify and reduce mercury production from mercury mining and other sources, and reduce the use of mercury in products and industrial processes. In one NRDC study (Zhang *et al.* 2019), a technology-based probabilistic emission factor model was used to estimate mercury emissions in the non-ferrous metal smelting (NFMS) industry in China by province. The total mercury emission from the sector in 2015 was 75.6 t, 34% lower than in 2010. The reduction of mercury emission from 2010 to 2015 was achieved by phasing out outdated production capacity and the widespread application of the double contact and double absorption (DCDA) acid plants. In addition, the mercury flow in the treatment processes for by-products from non-ferrous metal smelters was evaluated (see Section 3 for additional detail).

In another NRDC study (Tsinghua University 2019) mercury emissions and releases were estimated for the zinc smelter sector in China. It was found that substantial quantities of mercury were released in the waste streams, exceeding that of the air emissions. The results of this important study are summarised in **Erreur ! Source du renvoi introuvable.** Additional studies of this type and quality are a high priority for improving understanding of mercury from this sector.

Table 3: Mercury emissions from different processes in zinc smelters in China (Tsinghua University 2019)

Process	Emission point	Emissions (t)	Note
<b>Production process</b>	Smelting furnace	27	Mainly from hydrometallurgical process
<b>Waste disposal process</b>	Waste acid disposal process	7	Recovering Hg from SUL slag and calomel; Smelting slag in the furnace
	Leaching slag treatment	25	Recovering ZnO from leaching slag
	Metal slag disposal	12	Metal slag from the leaching step of production process was treated to recover metal. The pyrometallurgical process led to mercury emissions.
	Sulfuric acid disposal	5	Smelter using sulfuric acid to produce metals

Chung and co-workers investigated mercury flows in a zinc smelter in Korea (Chung *et al.* 2017). They determined zinc ores and sulfuric acid as inputs into the study, and wastewater sludge, effluence water, spent catalyst, and emissions from the casting and roasting processes as outputs. Mercury concentrations were also measured in end products (zinc ingots, cadmium ingots, and sulfuric acid). The authors conclude that **the wastes discharged through the zinc smelting process should be thoroughly controlled, as approximately 89 % of the mercury contained in the original input was found in the waste.**

A similar study was undertaken in China by Wu and co-workers (Wu *et al.* 2016b). This study investigated the flow of mercury associated with zinc, lead, and copper concentrates and provided new insights on the mercury emissions and recovery in both metals-production and wastes disposal processes in China. **Total mercury input from concentrates consumed in China reached 1005.4 t, of which 31.7% was dumped as discarded slags and 2.3% was stabilized (permanent storage). Approximately 202.1 t of mercury were directly emitted to air, water, and soil.** More specifically, metals production processes emitted an estimated 100.4 t mercury to air. Wastes disposal processes contributed to an additional 47.8 t of atmospheric mercury emissions and 32.7 and 21.3 t of mercury to water and soil, respectively. At the same time, out of the 62.6 t of recovered mercury, 95.2% was reclaimed from acid slags. Interim storage of 398.9 t of mercury also highlights the significance of acid slags as potential mercury recovery sources due to the global ban on primary mercury production.

### 3.2.1. Mercury material flows in the German non-ferrous sector

Comprehensive assessments of mercury material flows for all industrial sources have been undertaken in Germany (Umwelt Bundesamt 2020b; Umwelt Bundesamt 2020a). For each sector the mercury input was estimated by studying the input fractions. Mercury output was analysed by studying emissions to air and water, as well as mercury in waste, products and by products. Overall results for the non-ferrous sector are

considered but the full report includes substantial information on individual facilities. For all metals the report notes that here is a considerable need for research on both the entry and the exit side in order to improve the balance sheet.

### Lead

The mercury input via raw materials was determined using literature data on the mercury content in ores and the current ore import volumes. Mercury inputs via aggregates and fuels could only be quantified for the primary lead smelters.

The air-side mercury load was estimated using the emissions declarations from one primary and two secondary smelters by extrapolating to two primary and five secondary smelters. Mercury discharges through the discharge of wastewater into bodies of water were determined on the basis of measurements from 2016 (primary smelters) and estimates (secondary smelters). Mercury in waste from primary smelters was calculated from 1997 literature waste factors; In comparison with the analysis data and disposal quantities of a primary lead smelter for 2016, the data are probably overestimated. In the sulfuric acid, the discharge was calculated using the typical Hg content in the sulfuric acid and the production quantities for 2016 to be around 10 - 55 kg / a.

The estimated input appears to be 56% too low compared to the mercury discharge (a maximum of around 7,815 kg / a input to a maximum of more than 18,000 kg / a discharge). This is probably due to the fact that, on the one hand, the input data for primary raw materials are not based on ore analyzes specific to Germany and, on the other hand, little data is available on the input of secondary raw materials (Umwelt Bundesamt 2020b; Umwelt Bundesamt 2020a). In addition, no data was available for air emissions and assumptions had to be made for the disposal quantities.

The results are summarized in Figure 3.

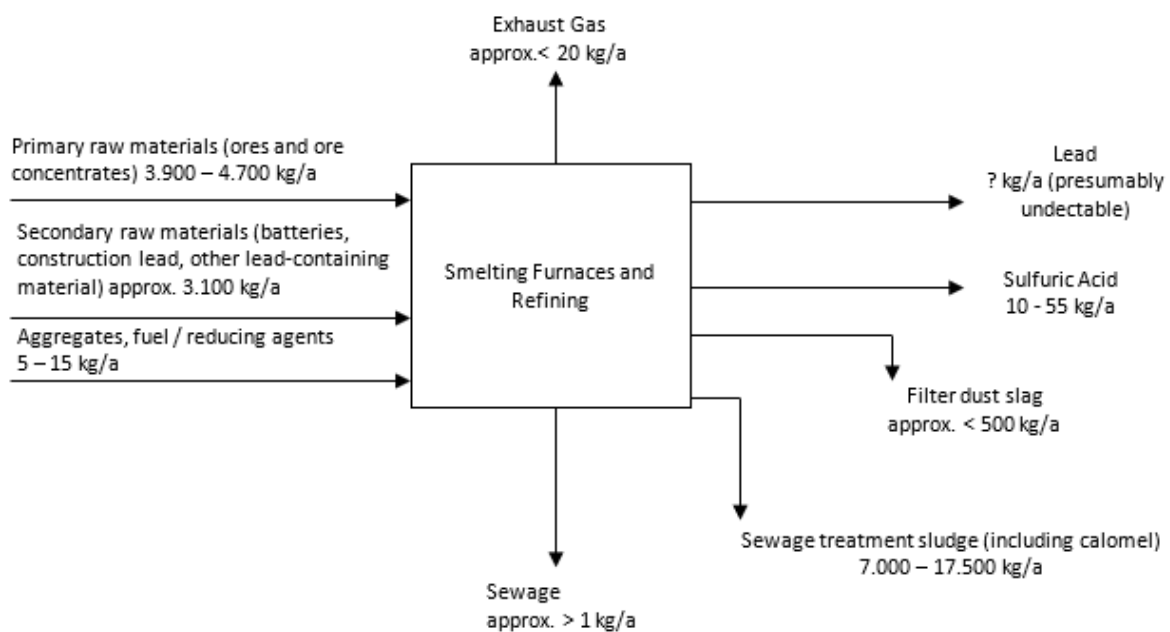

Figure 3: Mercury balance for lead production in Germany (adapted from Umwelt Bundesamt 2020b)

### Copper

Due to the lack of representative ore analyzes, the most important mercury input via raw materials into primary ore smelting could only be determined using literature data on the Hg content in copper ores and the current ore import volume. A representative mercury content in copper scrap is difficult to determine due to

the small amount of laboratory sample. Mercury inputs via aggregates and fuels were quantified on the basis of the assumption of a range of Hg mean values for the large primary / secondary copper smelter and neglected for the secondary copper smelter due to the relatively small amount.

For the mercury load that is released into the air, the Pollutant Release and Transfer Register (PRTR) notifications for 2016 were used from two locations, which account for more than 90% of the total production of copper. The sources included in the report and the number of underlying mercury measurements are not known.

The greatest amount of mercury is discharged through waste disposal, in particular through the amount of mercury contained in the sludge from the waste gas treatment or wastewater treatment of the combined primary and secondary smelter, which is dumped underground. Another relatively high discharge, which is used in zinc smelters, takes place via the filter dust disposal (approx. 600 kg / a). The determination was made on the basis of disposal quantities in 2016; it is associated with high uncertainties, since only one mercury analysis is available for each of the waste fractions. Compared to the entries (based on literature values), the determined discharge exceeds the entry.

The mercury emissions into the water were determined on the basis of measured values from the combined primary and secondary smelter from 2016. No wastewater data is available from the secondary copper smelters as there is no direct discharge.

In the sulfuric acid, the discharge was calculated using typical Hg contents in sulfuric acid, which are required by customers as a minimum criterion, and using the production volume in 2016.

The estimated input appears to be 56% too low compared to the mercury discharge (a maximum of around 4,550 kg / a input to a maximum of around 8,170 kg / a discharge). This is probably due to the fact that, on the one hand, the input data for the primary raw materials are not based on ore analyzes specific to Germany and, on the other hand, the input of secondary raw materials from discharges had to be calculated back. In addition, the disposal quantities are based as above described on very few waste analyzes. The results are summarized in Figure 4.

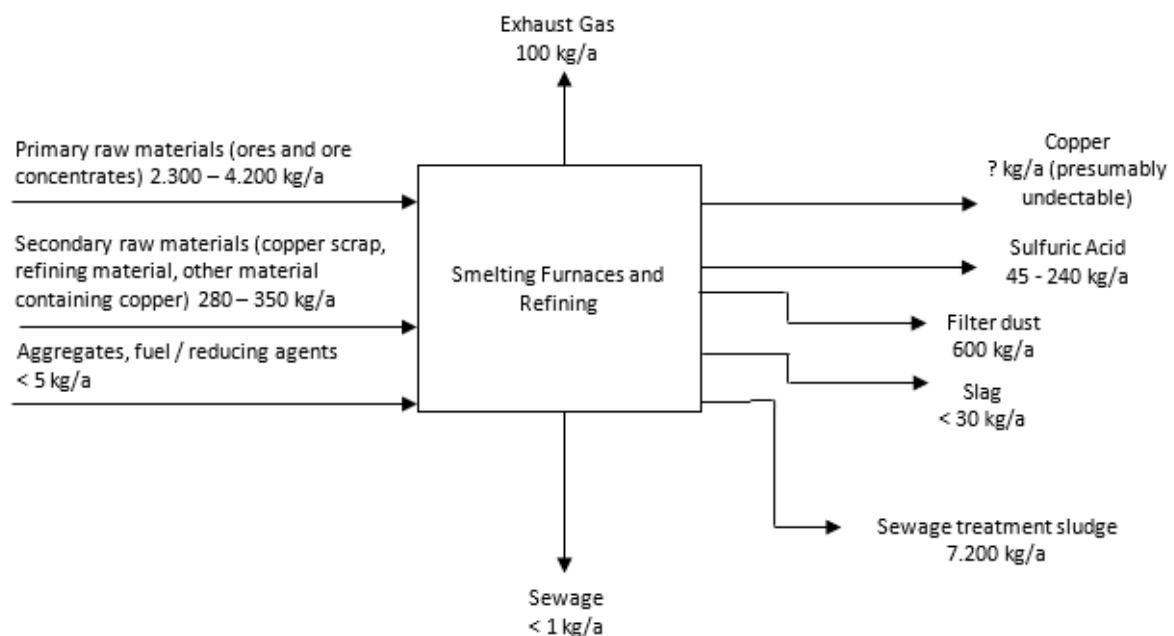

Figure 4: Mercury balance for copper production in Germany (adapted from Umwelt Bundesamt 2020b)

## Zinc

For the mercury balance of primary zinc production, the mercury input via raw materials, in particular ores, and the mercury output via emissions to air, the waste and sulfuric acid as a by-product were determined (Umwelt Bundesamt 2020b).

For the mercury load released into the air via the main chimney, the estimate is based on a few individual measurements. The sulfuric acid discharge was calculated using the typical Hg content in the sulfuric acid and the production volume in 2016. Data on emissions in wastewater are not available. Mercury in the waste was calculated on the basis of data on the discharge of HgSe-containing sludge. Further waste data (in particular on slag and filter dust) are not available.

The estimated input appears to be 75% too low compared to the mercury discharge (a maximum of around 12,200 kg / a input to a maximum of around 47,755 kg / a discharge). Only literature data was available for the mercury input (the magnitude of which was approximately confirmed by the processing company).

The results are summarized in Figure 5.

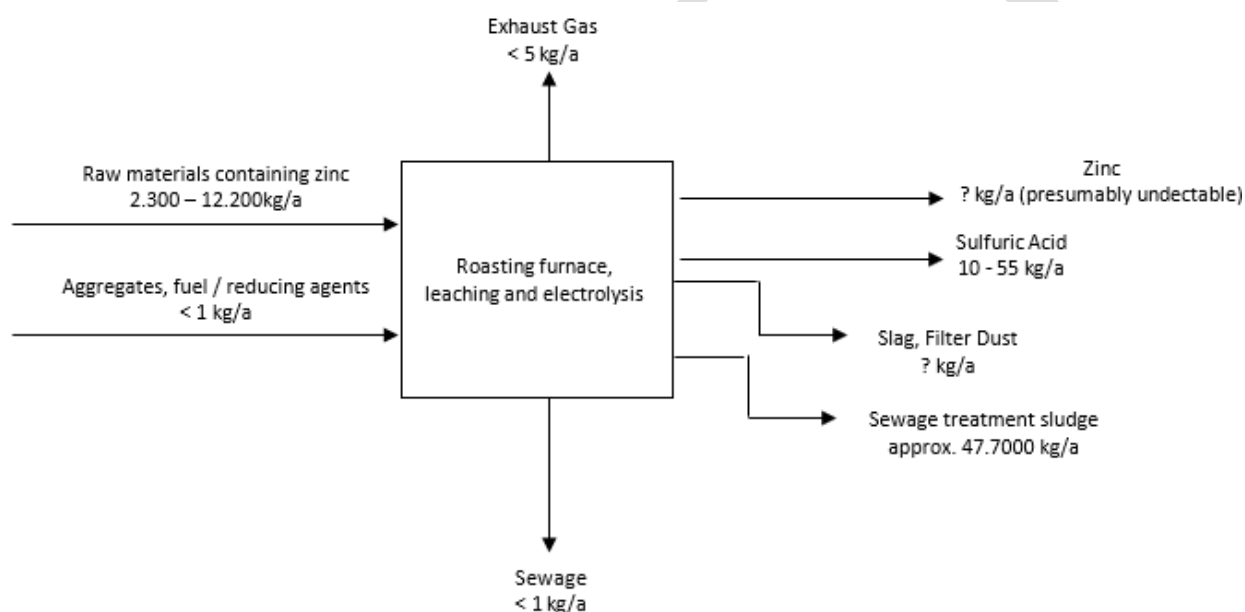

Figure 5: Mercury balance for primary zinc production in Germany (adapted from Umwelt Bundesamt 2020b)

### 3.2.2. Mercury material flows in the Japanese non-ferrous sector

The Japanese Ministry of the Environment of Japan (MOEJ) has published Mercury Material Flow for the Financial Years 2010, 2014<sup>29</sup> and most recently for 2016 (Ministry of the Environment Japan (MOEJ) 2018). The results for the non-ferrous sector are presented in Table 4 and Figure 6.

The results of this material flow analysis will be used for national policy-making, for identifying mercury emission hotspots in the respective countries, and for inventory development and reporting. The information obtained through reporting material flows will also be useful for evaluating the effectiveness of the Minamata Convention. In order to develop the mercury material flow, the MOEJ took the lead in data collection, but in close cooperation with other governmental bodies and industries. A Technical Committee with experts from

<sup>29</sup> Results of Material Flow for mercury (FY2014) [http://www.env.go.jp/chemi/tmms/materialflow/materialflow\\_2014.pdf](http://www.env.go.jp/chemi/tmms/materialflow/materialflow_2014.pdf)



academia and industry was also employed to assist in the preparation of the report. A variety of approaches were used to ensure the most accurate results, including statistical and monitoring data, interviews with industries, surveys of local government and research results (Ministry of the Environment Japan (MOEJ) 2018).

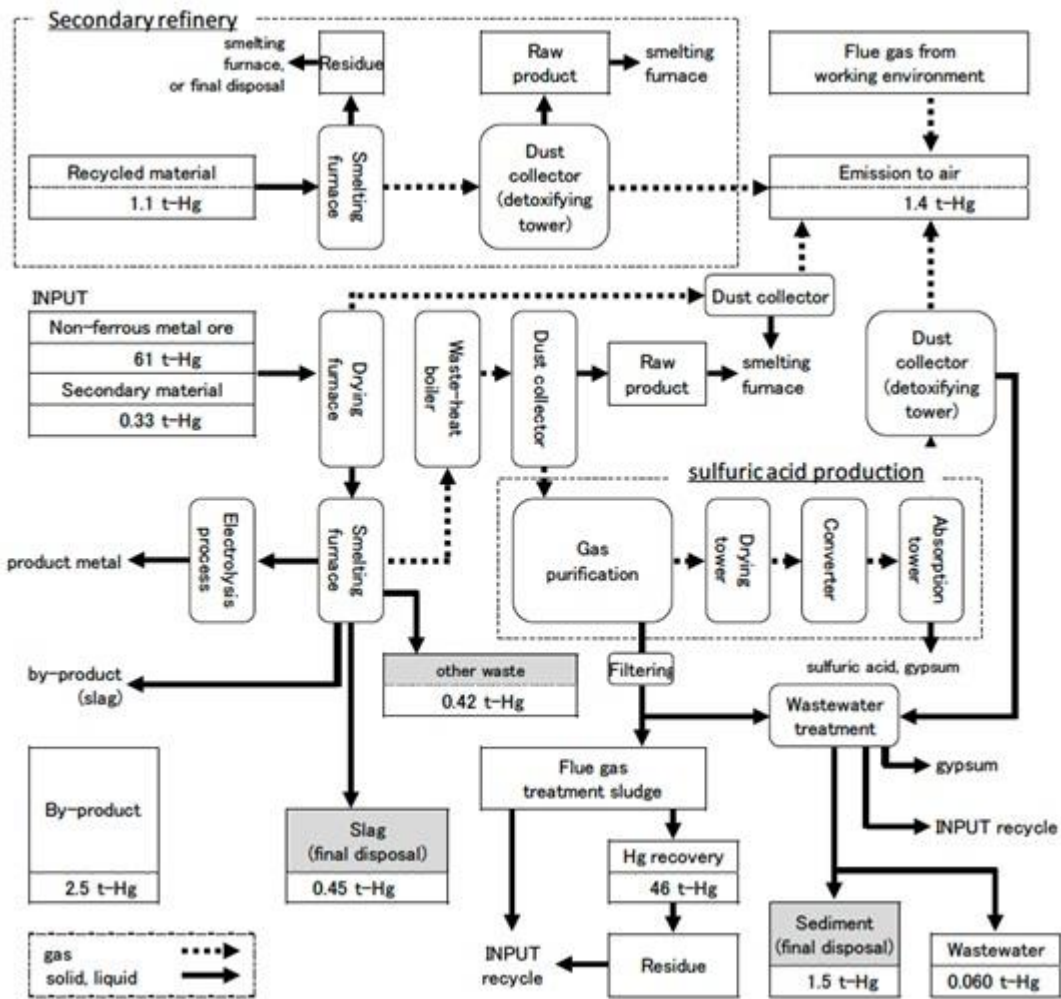

Figure 6: Mercury flow for non-ferrous metal smelting facilities in Japan (Ministry of the Environment Japan (MOEJ) 2018)

Table 4: Mercury emission from non-ferrous metal smelting facilities (FY2016) in Japan (Ministry of the Environment Japan (MOEJ) 2018)

Non-ferrous metal	Producer <sup>Note 1</sup>	Estimation method <sup>Note 2, Note 3</sup>	Amount of Hg emission (t-Hg)
Electrolytic copper (primary + secondary)	Member	Σ (Average flue gas mercury concentration x average gas amount (Dry))	0.21
Electrolytic zinc or distilled zinc (primary)	Member		0.020
Electrolytic zinc or distilled zinc (secondary)	Member		0.49
Recycled zinc (secondary)	Non-member	Overall emission factor x production volume	0.000069
Emissions from roasting furnaces, sintering furnaces, blast furnaces and drying furnaces used for zinc recovery (Soot and dust from electric furnaces used for steelmaking, limited to the collection of zinc from dust collected by dust collectors)			0.30
Electrical lead (primary)	Member	Σ (Average flue gas mercury concentration x average gas amount (Dry))	0.030
Electrical lead (secondary)	Member		0.29
Recycled lead (secondary)	Non-member	Overall emission factor x production volume	0.0013
Gold (secondary)	Member	Σ (Average flue gas mercury concentration x average gas amount (Dry))	0.00011
Total			1.4

#### Notes to Table 4:

Note 1: Producers are distinguished between members of the Japan Mining Association and non-members, and the overall emission factor is also separately calculated between members and non-members.

Note 2: The emission factor for production by the Japan Mining Association is calculated using the following formula with the results of measurements of 41 facilities of the Japan Mining Association's member companies (100% member coverage) in the 2015 Mercury Atmosphere Emissions Survey.

Mercury atmospheric emissions (ton-Hg/year) = Σ (mercury concentration in average flue gas (μg-Hg/Nm<sup>3</sup>) x average gas amount (dry) (Nm<sup>3</sup>/h) x annual operating time (h/year))

Note 3: As for production data of recycled zinc (secondary) and recycled lead (secondary), produced by non-members of the Japan Mining Association, production data for one facility for recycled zinc and two facilities for recycled lead were obtained and the overall emission factor is calculated individually. Since the sample size is small, the accuracy of the emission factor is poor and needs to be reviewed in the future.

[Recycled zinc (secondary)] Overall emission factor (0.0034 g-Hg/ton) x production volume (28,000 ton/year)

[Recycled lead (secondary)] Overall emission factor (0.033 g-Hg/ton) x Production volume (39,000 ton/year)

### 3.2.3. Case Studies

The case studies appended to this report also contain useful information for specific processes and mineral processing facilities. However obtaining accurate data on mercury concentration and masses or volumes in the different stages of these complex processes is challenging.

### 3.2.4. Effects of global supply chains on embodied mercury emissions

In their study, Li and co-workers (Li *et al.* 2017) claim that on a global scale, the inter-connected global economy that features an intensive correlated supply chain has large impacts on mercury emissions. Global non-ferrous metal related mercury emission flows (including ASGM) among 186 individual economies for the year 2010 are tracked, by applying an empirically validated multi-regional input-output (MRIO) model. The

study notes that total amount of direct mercury emissions is 974 tonnes, to which gold production contributed a dominant proportion. It further indicates that for that same year **two thirds of mercury emissions from non-ferrous metal production were effectively traded internationally (as they were linked to exports of non-ferrous metals to other economies), primarily as exports from emerging economies such as mainland China and Colombia to wealthy economies including the USA and Germany through global supply chains.** This paper therefore traces embodied mercury emissions flowing from the economy where they are produced to other economies where the final consumption happens as a result of the production of non-ferrous metals to meet demand in other markets. These results for the embodied mercury fluxes are presented in Figure 7. The authors conclude that understanding the redistribution of mercury emissions along the global supply chains can facilitate international efforts to reduce mercury emissions from non-ferrous metal production. This study would benefit from additional investigation.

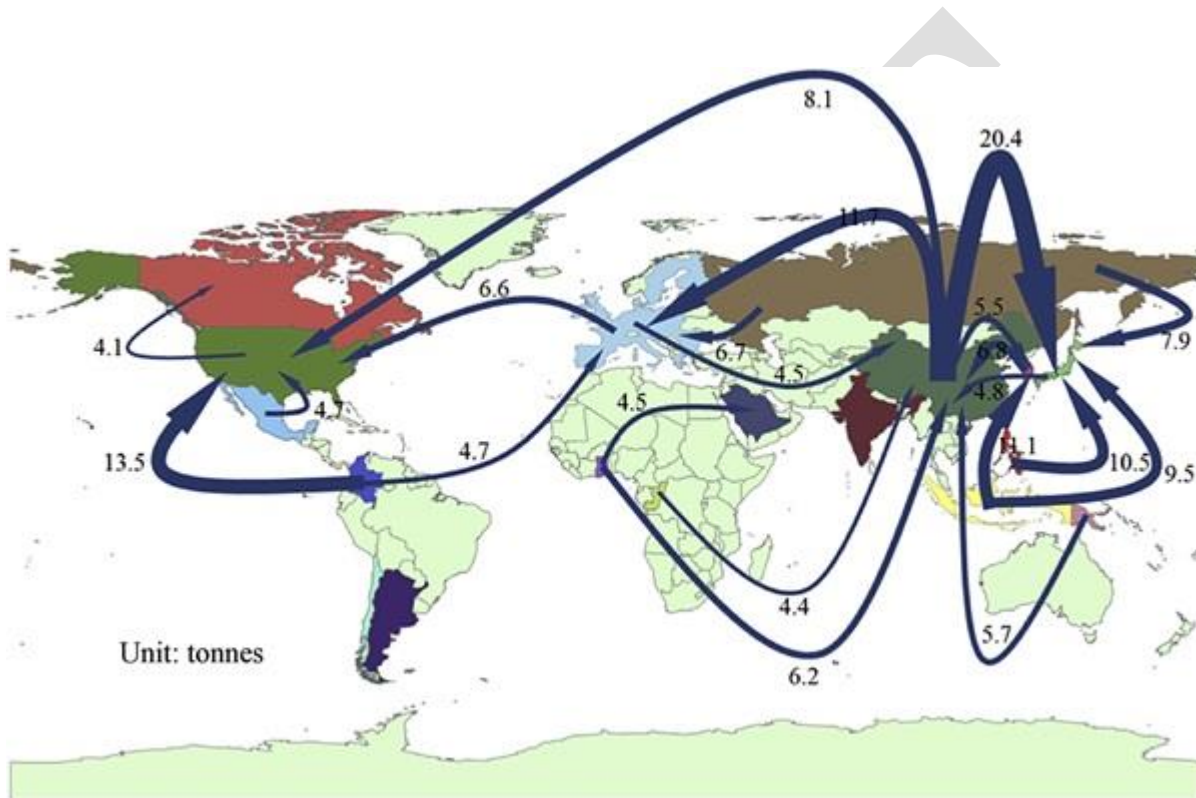

Figure 7 : Embodied mercury fluxes (>4 tonnes) from the non-ferrous sector between trading centers (Li et al. 2017)

(REDESIGN IN PROCESS)

## 4. MERCURY EMISSIONS AND RELEASES ESTIMATES FROM THE NON FERROUS SECTOR – EXISTING KNOWLEDGE AND KNOWLEDGE GAPS

### 4.1. Background on previous work on estimation of mercury emissions and releases and mercury release mechanisms and speciation

Concern over human health and environmental impacts of heavy metals have increased substantially as analytical methods to detect trace amounts have been developed, and impacts have been quantified. Detailed knowledge of the sources, transport, transformations and fate of these metals are essential to successfully manage this major environmental issue.

Pioneering work on quantifying global sources of heavy metals was undertaken by Nriagu and co-workers (Nriagu and Pacyna 1988; Nriagu 1989; Nriagu 1990). The focus on mercury as a major contributor to this concern followed, and global emission inventories of mercury emissions have been developed by a range of researchers (Pacyna and Pacyna 2002; Pacyna *et al.* 2003; Pacyna *et al.* 2006a; Pacyna *et al.* 2006b; Wilson *et al.* 2006; Lindberg *et al.* 2007; Pacyna *et al.* 2009; Selin 2009; Pacyna *et al.* 2010; Driscoll *et al.* 2013; Beckers and Rinklebe 2017). Table 5 summarizes the estimates of emissions from the non-ferrous sector and in some cases large scale gold production separately. In all cases emissions from the non-ferrous mining and minerals processing sector are estimated to make major contributions to anthropogenic emissions. Data in Table 5, which presents emissions estimates from the non-ferrous sector from 1995 to 2015 from different sources, suggests that both the absolute quantities of emissions and the proportions have increased. It is important to also note the range of uncertainties in these estimates as well as the fact there may be differences in methodology and improvements in data quality with time.

Table 5: Estimates of emissions from the non-ferrous sector for various years (references given in Table)

Source	Year of Estimate	Non-ferrous contribution (tonnes)	Proportion of Total Anthropogenic Emissions (%)	Large scale gold (tonnes)	Proportion of Total Anthropogenic Emissions (%)
(Pacyna and Pacyna 2002)	1995	166	8.7		
(Pacyna <i>et al.</i> 2006b)	2000	149	6.8		
GMA2008 (AMAP/UNEP 2008)	2005	141	9.5	111	7.5
GMA2013 (UNEP 2013a)	2010	193 (82-660) <sup>a</sup>	10	97 (0.7-247) <sup>a</sup>	5
GMA2018 (UNEP 2019a)	2015	228 (154-338) <sup>a</sup>	10.3	84.5 (72.3-97.4) <sup>a</sup>	3.8

<sup>a</sup> Range of estimate accounting for uncertainties

Estimates have also been made of emissions from both anthropogenic and natural sources (or more accurately natural and re-emitted) (Pirrone *et al.* 2009; Pirrone *et al.* 2010). Reconstructions of historical emissions and projections of future emissions (Selin 2009; Streets *et al.* 2009; Streets *et al.* 2011; Amos *et al.* 2013) have also enriched our understanding of the contribution of the non-ferrous sector in the past and its possible contributions in the future. The total mercury released to the environment by human activities has also been

estimated (Streets *et al.* 2017), including emissions to the atmosphere and releases to land and water. A total of 1540 Gg (1 Gg = 10<sup>9</sup> g) mercury emissions (472 Gg) and releases (1070 Gg) are estimated. Non-ferrous metals are the major contributors to these emissions and releases: mercury production (26.8% of the total), silver (23.7%), large scale gold (8.8%), zinc smelting (2.3%), copper smelting (1.1%) and lead smelting (0.9%). In all cases for the non-ferrous metals releases exceeded emissions significantly.

Useful information can also be derived from considerations of the global mercury biogeochemical cycle (Selin 2009; Beckers and Rinklebe 2017), and regional estimates of emissions for Europe (Pacyna *et al.* 2005), Russia (Russian Federal Service for Environmental Technological and Atomic Supervision and Danish Environmental Protection Agency 2005), Australia (Nelson *et al.* 2012; Fisher and Nelson 2020), and Asia, particularly China, and increasingly for the non-ferrous sector in China where large contributions are made to global emissions from this sector (Wu *et al.* 2006; Jaffe and Strode 2008; Li *et al.* 2010; Fu *et al.* 2012; Wu *et al.* 2012; Gustafsson *et al.* 2013; Wang *et al.* 2014; Wu *et al.* 2015; Ye *et al.* 2015; Wu *et al.* 2016a; Wu *et al.* 2016b; Li *et al.* 2017; Wu *et al.* 2018; Jiang and Wang 2019; Tsinghua University 2019; Zhang *et al.* 2019).

Estimates have also been made for contributions to the global mercury budget from contaminated sites (Kocman *et al.* 2013). Both contaminated sites related to non-ferrous and precious metal processing made significant contributions to this budget, but the most substantial amounts were due to primary mercury mining and ASGM (Kocman *et al.* 2013).

Legacy and health issues associated with historical mining are also the subject of current research (Wu *et al.* 2020; Corella *et al.* 2021; Li *et al.* 2021), and include consideration of the contribution of mercury.

Specific estimates of emissions from the non-ferrous sector and considerations of global mercury supply chains (Maxson 2005; Li *et al.* 2017) and global metal cycles (Rauch and Pacyna 2009) also provide useful information. Most recently estimates of emissions and releases prepared for the UNEP Global Mercury Assessments (AMAP/UNEP 2008; AMAP/UNEP 2013; AMAP/UNEP 2019) have been collected and used the best available estimation techniques, and country specific data where available. The UNEP Toolkit for Identification and Quantification of Mercury Sources (UNEP 2005; UNEP 2017b) complements the GMAs and enables country specific emissions and releases to be estimated. Both the GMA and the Toolkit include extensive background information on data for the non-ferrous sector and the methodology for making the estimates.

In contrast to the data reported in the GMA2018 (AMAP/UNEP 2019) significantly lower emissions for zinc have been reported by the International Zinc Association (IZA, (International Zinc Association 2021). This estimate is based on information on releases or on installed abatement technology reported to IZA, information from Pollutant Release and Transfer Registers (PRTR) and information on national limit values for releases. The basis for the IZA estimate were data from all 116 zinc smelters worldwide reported in the ILZSG zinc smelters database (International Zinc Association 2021). The IZA estimate is 5912 kg (5.9 tonnes/year). By contrast the GMA2018 estimate is 141 tonnes per year but with a range of 96-208 tonnes/year based on the quoted uncertainty in GMA2018 for the non-ferrous sector as a whole (AMAP/UNEP 2019).

The GMA methodology and sources of data are comprehensively documented (AMAP/UNEP 2019), In some cases national data (including that from PRTRs) made available by countries were also incorporated. The GMA2018 includes detailed comparisons with national inventories and other compilations including those from the inventories prepared under the auspices of the UNECE Convention on Long-range Transboundary Air Pollution (CLRTAP) reporting for 2015; national inventories (including PRTR data) provided by Australia, Canada, Japan, Republic of Korea, Russia and USA and national estimates by China from published sources. These comparisons show that the GMA results “match to differing degrees for different sectors, and that this also varies between countries. However, ...the degree of consistency between national inventory estimates and the GMA estimates for this group of countries is generally good, and (with some exceptions) well within the bounds of associated uncertainties” (AMAP/UNEP 2019).

However the magnitude of the difference between the GMA2018 estimate and that of the IZA (International Zinc Association 2021) clearly requires further examination.

It is beyond the scope of this report to repeat in detail or further analyze the detailed information in these publications and reports but a consideration of the methodologies employed and the knowledge gaps is useful for informing future studies and research on the non-ferrous sector. These will be addressed in Section 4.2 below.

An understanding of mercury release from ores during smelting and other high temperature processing is important for accurate estimates of mercury emissions and releases. Mercury speciation as elemental mercury ( $\text{Hg}^0$ ), oxidized mercury ( $\text{Hg}^{2+}$ ), or particulate mercury ( $\text{Hg}_p$ ) is also important for determining mercury fate in the atmosphere, water, soils and vegetation. Hence knowledge of the forms of mercury in emissions and releases is crucial for modelling mercury transport and fate.

Commercially non-ferrous metals are predominantly produced from sulfide ores. Mercury is often present in such ores, albeit in highly variable concentrations. Emissions and releases of mercury usually occur during high temperature processing of the ores, which typically consist of four stages: dehydration, smelting and/or roasting, extraction and refining (Wang *et al.* 2010; Zhang *et al.* 2012; Wu *et al.* 2015; Zhang *et al.* 2016). The major releases occur during the smelting or roasting of concentrates.

Temperatures exceed  $800^\circ\text{C}$  in smelting/roasting, extraction and refining (Wang *et al.* 2010) and at these temperatures formation of elemental mercury ( $\text{Hg}^0$ ) is favoured (Hylander and Herbert 2008) and release rates of mercury for non-ferrous metals apart from industrial gold are almost complete (usually more than 98% (Zhang *et al.* 2016)).

In the case of industrial gold smelting, based on in situ measurements (Zhang *et al.* 2016) of a gold concentrate roaster (at  $600^\circ\text{C}$ ), release of only 85% of the mercury was observed. It has been suggested (Zhang *et al.* 2016) that temperatures of more than  $780^\circ\text{C}$  are required to release mercury from certain chemical associations in the gold ore.

Speciation of mercury however also depends on the transformations of elemental mercury that can occur in air pollution control devices (APCDs) for the smelting/ roasting flue gases, including dust collectors, purification systems, dedicated mercury removal systems such as the Boliden-Norzink process (see Section 5.2), and sulfuric acid plants. Zhang *et al.* (2016) provide a detailed overview of these processes; Figure 8 presents a summary of these transformations and Table 6 presents data for mercury speciation profiles as a function of control technology in Chinese smelters (Zhang *et al.* 2016).



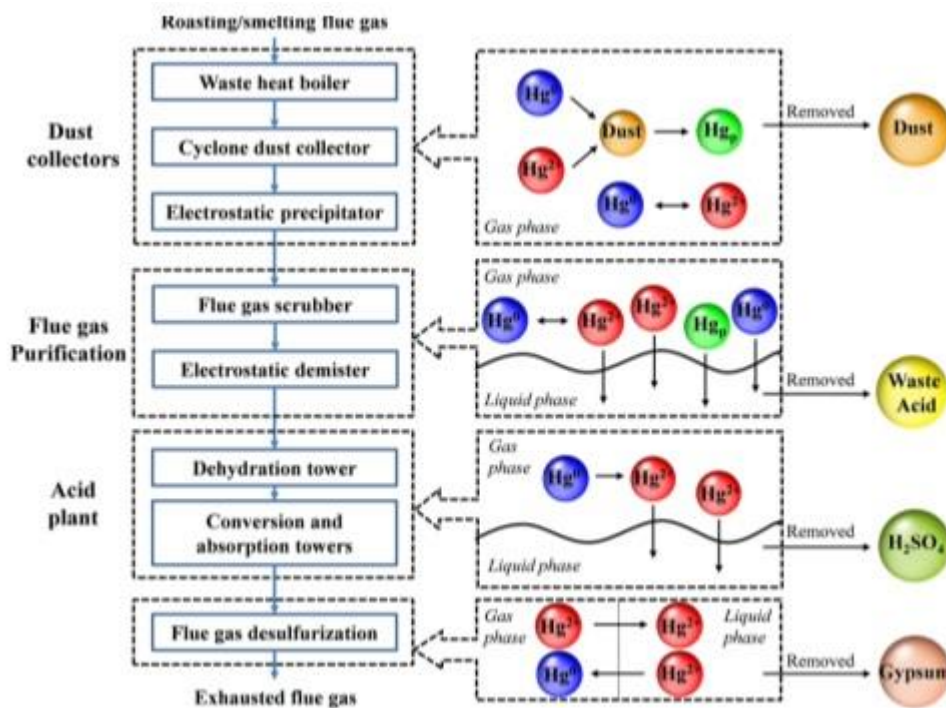

Figure 8: Mercury transformation and removal in roasting and/or smelting flue gas (Zhang et al. 2016).

Table 6: Average speciation profiles of mercury emissions from non-ferrous metal smelters by control technology(%)

Metal Type	APCD combination	$Hg^0$	$Hg^{2+}$	$Hg_p$	Reference
<b>Non-ferrous metal</b>	NS	80	15	5	(Streets et al. 2005)
					(Pacyna et al. 2006b)
					(Wu et al. 2006)
<b>Zinc</b>	DC + PS + MRT + AP <sub>d</sub>	71	28	1	(Wu et al. 2015)
<b>Zinc</b>	DC + PS + AP <sub>d</sub>	55	44	1	(Zhang et al. 2012)
					(Wu et al. 2015)
<b>Lead</b>	DC + PS + AP <sub>s</sub>	40	60	0	(Zhang et al. 2012)
	DC + PS + AP <sub>d</sub>	39	61	0	(Zhang et al. 2012)
<b>Copper</b>	DC + PS + AP <sub>d</sub>	50	50	0	(Zhang et al. 2012)
<b>Gold</b>	DC + PS + AP <sub>d</sub>	32	57	11	(Yang 2015)

Notes: NS – not specific; DC – dust collector; PS- purification system; MRT – mercury reclaiming tower; AP<sub>d</sub> – acid plant with double-conversion-double-absorption processes; AP<sub>s</sub> – acid plant with single-conversion-single-absorption processes.

Some work has also been done in China on estimating mercury speciation for all industrial sources, including the non-ferrous sector (Wu et al. 2012; Zhang et al. 2015). However more detailed measurements at a larger number of plants of different types and technologies are required to develop robust estimates of speciation profiles in mercury emissions.

#### 4.2. Methodology for estimating emissions and releases from the non-ferrous sector – key inputs and knowledge gaps

The 2018 Global Mercury Assessment (AMAP/UNEP 2013; AMAP/UNEP 2019), as illustrated in Figure 9, used a mass balance approach to produce its global inventory of emissions to air and data required are the amounts of raw materials used or commodities produced (activity data); associated mercury content in raw materials and the types of processes involved (reflected in “unabated” emission factors); and technology applied to reduce emissions to air.

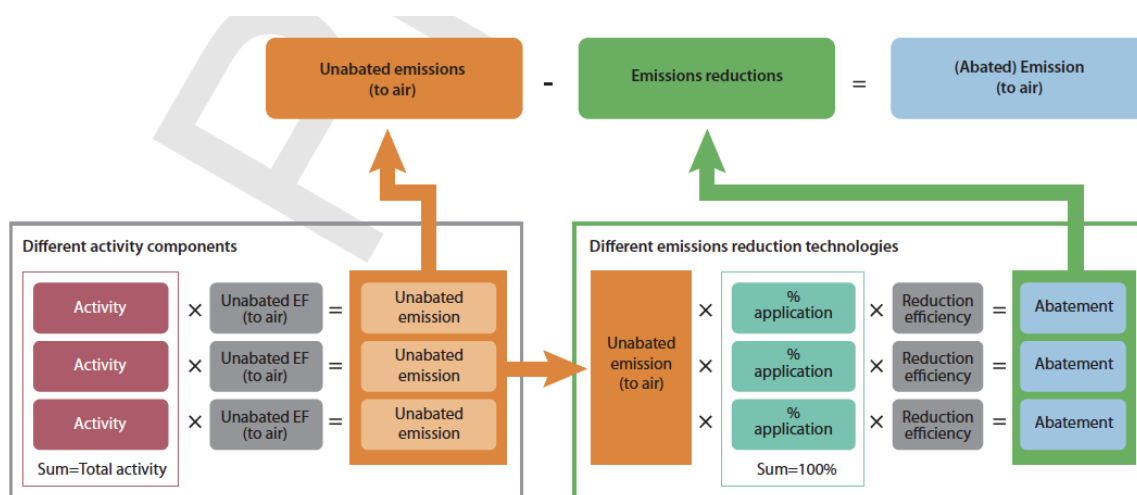

Figure 9: General methodology employed to produce the 2015 global inventory of anthropogenic emissions to air (AMAP/UNEP 2019)

The approach for releases from the non-ferrous sector are classified as Group 1 releases in the 2018 GMA, and combine the GMA emission estimates (AMAP/UNEP 2019) and UNEP Toolkit distribution factors (UNEP 2017b) which are used to proportionally distribute total mercury releases between emissions to air and releases to water and land. In some cases specific country data were also used to estimate emissions and the distribution factors were adjusted accordingly (AMAP/UNEP 2019). A potential shortcoming of this methodology is that it ignores the incorporation of mercury into wastes which are securely stored and by-products, and the complexities around what constitutes a release.

The general approach in the Toolkit is illustrated for the case of copper extraction and initial processing in Table 7 (UNEP 2017b; UNEP 2019c).

Table 7: overview of activity rate data and mercury input factor types needed to estimate releases from copper extraction and initial processing (UNEP 2017b)

Life-cycle phase	Activity rate data needed	Mercury input factor
<b>Waste from mining and production of concentrates</b>	Metric tons of reject material produced per year	g mercury/metric ton in reject material produced
<b>Input to extraction of primary copper from concentrate</b>	Metric tons of concentrate used per year	g mercury/metric ton concentrate

The major principles and processes occurring during mining and mineral processing relating to mercury emissions and releases are discussed in some detail in the Toolkit, the EU Best Available Techniques Report (European Commission (Joint Research Centre) *et al.* 2017), the BAT/BEP Guidance for Article 8 of the Minamata Convention (UNEP 2019b) and the case studies appended to this report. As can be seen from these references and the brief discussion included here the input data crucial for estimating emissions and releases includes:

- Mercury concentrations in ores and concentrates
- Mercury concentrations in reject material
- Mercury distributions between emissions and releases



- Activity data (amounts of ores and concentrates processed)
- Effects of pollution control technologies on affecting distribution of mercury between emissions to air, and capture in solid and liquid waste streams

There are significant challenges however in obtaining this data. The UNEP Mercury Inventory Toolkit (UNEP 2017b) highly recommends in all cases of the non-ferrous metals “to use a point source approach in the inventory, and, if feasible, compile point source specific data from the operating companies themselves, as well as from other relevant data sources with knowledge of the specific production facilities”. Such recommendation derives from the fact that “large scale industrial mining and metal extraction operations are few in number in any country where they operate, their feed materials and production configurations vary significantly, and they may be potent mercury release sources”.. .

The Toolkit (UNEP 2017b) also notes that actual data on mercury levels in the particular ore or concentrate composition used will lead to the best estimates of emissions and releases.

Obtaining measurement data on the outputs, such as emissions test data from release points (e.g., furnace stacks), is also very useful. The most important site specific data include (UNEP 2017b):

- Measured data or literature data on the mercury concentrations in the ores and concentrates extracted and processed at the source;
- Amount of ore/concentrates extracted and processed; and
- Measured data on the distribution of mercury outputs with (preferably all) output streams, including mercury percentages retained by emission reduction equipment applied on the mercury source (or similar sources with very similar equipment and operating conditions).

**One major challenge is that the concentrations of mercury in ores and concentrates can vary considerably.**

The presence of anomalous concentrations of mercury in many types of mineral types has long been recognized and exploited for the geochemical exploration of these ores (Rytuba 2003). For example, Hylander and Herbert (2008) collected data for mercury concentrations in concentrates for zinc, copper and lead production for mines globally. Individual data were proprietary but the results are summarised in Figure 10.

This variability is at least as marked for gold ores and concentrates. The Toolkit (UNEP 2017b; UNEP 2019c) advises:

Booz Allen & Hamilton (2001) reports, based on review of literature, that typical concentrations of mercury in gold ore in the Western USA range from 1-200 g/ton ore. Jones and Miller (2005) stated that mercury concentrations can range from less than <0.1 to above 100 g mercury/metric ton of ore. According to the US (2010) submission to UN Environment for the so-called §29 study on mercury, the gold mercury concentration in mined ores in the USA varies, from less than 0.1 parts per million (ppm = g/ton ore) to about 30 ppm. The gold mine ores in Nevada have the higher mercury concentrations. The mines in other States have lower mercury in the ores. Outotec (2012) inform that mercury concentrations in gold ore vary; examples of countries with high mercury concentrations are the USA and Australia.

The case of Australia is further illustrated by geochemical data collected for the Kalgoorlie deposit, which demonstrates large variability for mercury concentrations in this single deposit. There non-anthropogenic mercury occurs naturally in the mineral coloradoite (HgTe), and also as native mercury. Figure 11 shows mercury concentrations for samples collected in Kalgoorlie with orders of magnitude variation in mercury concentrations (1 ppb = 1 mg/kg, so the range at Kalgoorlie exceeds 10 mg/kg to 10 g/kg).

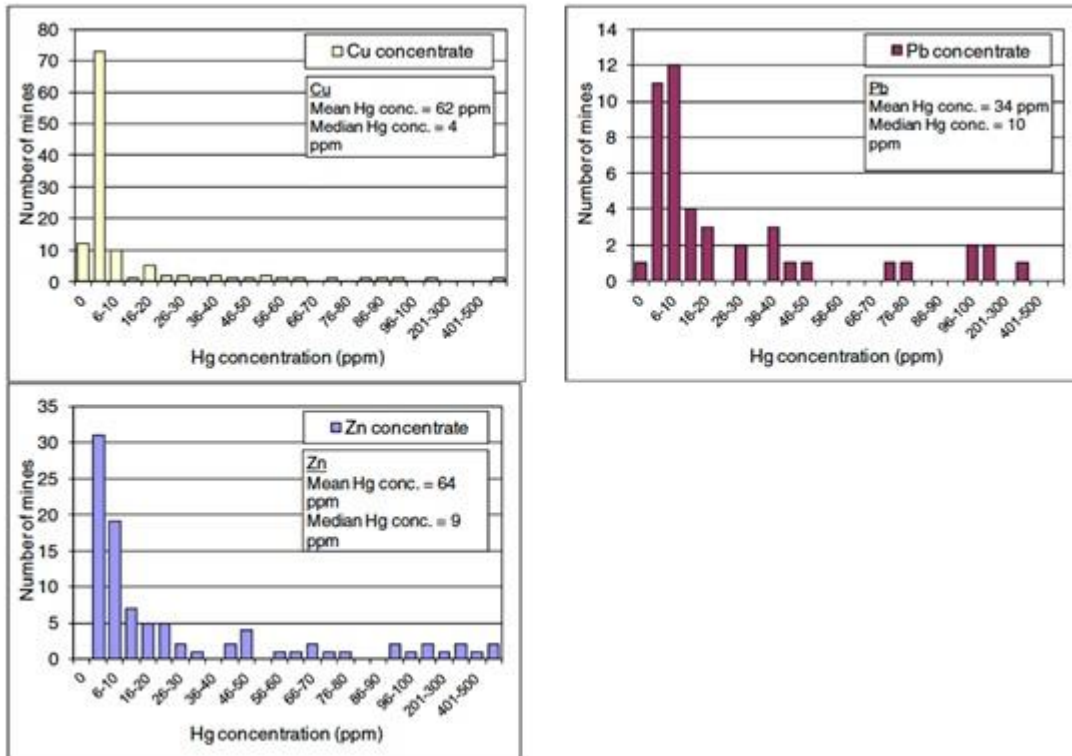

Figure 10: Histograms showing number of mines in the Brook Hunt database and Histograms showing number of mines in the Brook Hunt database and the reported Hg concentrations in a) Cu concentrates, b) Pb concentrates, and c) Zn concentrates. For Cu concentrates, mean Hg concentration = 64 ppm, median Hg concentration = 9 ppm,  $n = 120$  mines with Hg data, 264 mines in database. For Pb concentrates, mean Hg concentration = 34 ppm, median Hg concentration = 10 ppm,  $n = 45$  mines with Hg data, total 46 mines in database. For Zn concentrates, mean Hg concentration = 64 ppm, median Hg concentration = 9 ppm,  $n = 93$  mines with Hg data, total 274 mines in database (see Supplementary Information (Hylander and Herbert 2008)).

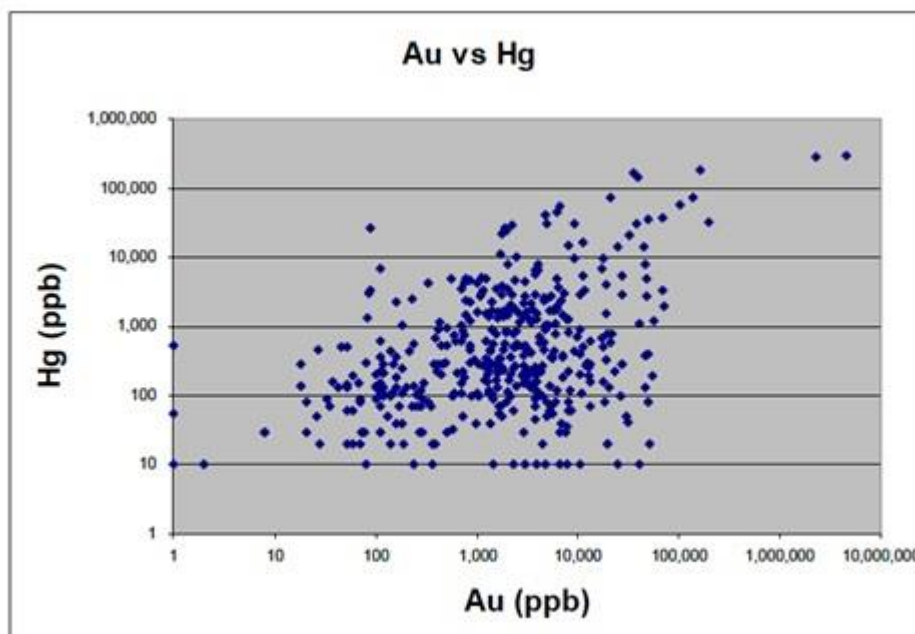

Figure 11: Mercury concentrations as a function of gold concentrations; samples from the Kalgoorlie deposit (Eviron 2006)

**A better understanding of mercury concentrations in ores, concentrates, and waste or byproduct materials would therefore seem to be a high priority for improving estimates of mercury emissions and releases, and for reducing the range of the estimates.** Organisations may have relevant concentration data (e.g. mining companies and industry bodies; US Geological Survey and other government bodies) but commercial reasons may preclude access to some of these sources.

Increasingly as mercury controls and management is implemented, improved understanding of the efficiency of air pollution technologies for controlling emissions, and the fate of the by-products and wastes collected by these technologies **would also improve understanding for source estimates and fate of mercury.**

In support of this, the most recent GMA Report (UNEP 2019a) identifies the following gaps and needs to improve factors and profiles for the non-ferrous sector: (1) Information on the mercury and metal content of concentrates processed in different countries, including details of co-production of non-ferrous metals; (2) Information base for assumptions regarding technology profiles, especially detailed information on the amount of production in different countries that is associated with facilities with integrated acid plants as opposed to artisanal production or production at larger facilities with no integrated acid plant.

There is increasing awareness of the contribution that the non-ferrous sector makes to releases. The GMA 2018 (AMAP/UNEP 2019; UNEP 2019a) presents an estimate of releases from copper, lead, zinc, aluminium and large-scale gold in 2015 of 242 tons/yr., almost three-fold higher than releases from these sectors in 2010 (AMAP/UNEP 2013). This change is largely the result of changes in methodology in the 2015 inventory (AMAP/UNEP 2019): country/ group-specific abatement technologies were used to derive the release estimates, resulting in more releases to water when wet gas cleaning technologies dominate the technology mix in specific locations. Using this new approach, the largest releases are associated with zinc production mostly in East and Southeast Asia (58%), followed by large scale gold (25%), copper (8%) and aluminium (5%).

However in contemporary mineral processing most of the mercury is disposed of in approved hazardous waste disposal facilities. These are lined to prevent contaminated water from draining into the groundwater. Other mercury containing material is stabilized as cinnabar and disposed in special facilities (e.g., salt mines in Germany). Today, there is also a part of the mercury that is marketed to satisfy demand for mercury, but this is declining. The long-term retention of mercury in such repositories requires verification and quantification.

#### **4.3. The impact of global trade in concentrates on the location of mercury emissions and releases**

Ores in the non-ferrous sector (apart from gold deposits) are commonly converted to concentrates before smelting or roasting. Whereas gold production is fully integrated with its mining operations and takes place on the same site, the smelting or roasting of other non-ferrous metals may take place on the same site or the concentrates may be transported to other places (including in other countries). In some cases, the produced concentrate is transported to extraction plants, which may be receiving concentrate from mines nearby, but also from the global market. For example, historically (Environment Canada 2002) some plants in Canada received mainly concentrate from local mines, while large parts of the concentrate processed in European zinc production plants have been imported from the global market (European Commission (Joint Research Centre) *et al.* 2017; UNEP 2017b). Similarly concentrates may be shipped long distances for smelting in China (Wu *et al.* 2016b).

This is a potential knowledge gap in the location of mercury emissions which will have impacts on country based inventories, and also on the modelling of mercury transport and deposition on local and global scales.

Releases of mercury are similarly complex. Waste material from the initial mining and concentrate producing operations may result in releases locally, but processing of the concentrates at the receptor location will also potentially contribute to releases from waste and by-products.

## 5. CONTROL OF MERCURY EMISSIONS AND RELEASES

Extensive work has been undertaken in the context of the Minamata Convention to identify the best practices available in the management of metal production. Many of the practices are common with other industry sectors and the equipment used to control emissions should be readily available in many countries.

This work draws on many years of research and development. Highly efficient commercial processes are now available to minimize emissions. For example, the USEPA Mercury Study Report to Congress presented a review of developments available at the time of its publication (USEPA 1997b).

More recently the European Commission and the Expert Group dealing with Article 8 of the Minamata Convention have produced comprehensive reports on Best Available Technology/ Best Environmental Practices (BAT/BEP) for the non-ferrous sector (UNECE 2013; European Commission (Joint Research Centre) *et al.* 2017; UNEP 2019b), which include detailed process descriptions and BAT/BEP approaches.

The NRDC report (Zhang *et al.* 2019) provides a detailed overview of pollution control options and costs for Chinese smelters, and the Swedish Environmental Protection Agency has undertaken a baseline study (Gustafsson *et al.* 2013) for the non-ferrous metal industry in China.

The UNEP Toolkit (UNEP 2017b; UNEP 2019c) also provides some detailed background discussion on mineral processing and control measures.

The process flow diagrams presented in Figure 1 and Figure 2 illustrate the complexities of the mineral processing systems employed for the non-ferrous sector, and the reader is referred to the references for BAT/BEP given above to obtain more detail on the control processes employed. In this report some brief general comments are provided in Section 5.2.

With respect to releases to land and water as well as waste, BAT/BEP approaches are less well developed globally, although the Toolkit (UNEP 2017b; UNEP 2019c) provides useful discussion and the European Commission Report (European Commission (Joint Research Centre) *et al.* 2017) includes approaches to the management of wastewater and other waste streams.

This issue is also currently under discussion in the context of the Minamata Convention Experts Group on releases referred to above<sup>30</sup>. The work program<sup>30</sup> of this group of technical experts includes the proposed categories of point sources of releases and a road map for the development of guidance on best available techniques and best environmental practices. The Basel Convention also adopted guidelines for the environmentally sound management of wastes consisting of elemental mercury and wastes containing or contaminated with mercury<sup>31</sup>.

Information on the removal of mercury from sulfur-containing gases in order to produce sulfuric acid has been developed by DKL Engineering and is available on the website “Sulphuric Acid on the Web<sup>TM</sup>” .

### 5.1. Process Descriptions

Detailed general descriptions of the processes used for the metals included in Annex D of the Minamata Convention (Lead, Zinc, Copper and Industrial Gold) are given in the Convention BAT/BEP guidance document for Article 8 (UNEP 2019b). Figure 1 and Figure 2 give examples of process flows for gold and zinc processing, and considerably more detail of processing is given in the European Commission BAT/BEP report for the non-ferrous sector (European Commission (Joint Research Centre) *et al.* 2017).

---

<sup>30</sup> <http://www.mercuryconvention.org/Meetings/Intersessionalwork/tabid/8279/language/en-US/Default.aspx>

<sup>31</sup> <http://www.basel.int/Implementation/MercuryWastes/TechnicalGuidelines/tabid/5159/Default.aspx>

## 5.2. Emission Control Techniques

In the following sections the major mercury air emission abatement techniques relevant to the non-ferrous roasting and smelting and refining sector are briefly described (these descriptions are drawn from the Article 8 BAT/BEP Guidance document (UNEP 2019b), and further details can be found there). In general, these rely on some form of mercury oxidation and interactions with materials such as mercury(II) chloride. Control of mercury emissions from smelting gases is also a very active area of research (Liao *et al.* 2020; Liu *et al.* 2020; Wang *et al.* 2021; Yang *et al.* 2021a; Yang *et al.* 2021b).

### 5.2.1. Boliden Norzink Process

The Boliden Norzink process (also called the Outotec chloride scrubber process or the Outotec BN process) removes elemental mercury from waste gases of primary ore smelters by converting mercury into mercury(I) chloride,  $\text{Hg}_2\text{Cl}_2$  (also known as “calomel”). Calomel results from the reaction of mercury with mercury(II) chloride,  $\text{HgCl}_2$ . Mercury(II) chloride is then recovered from some of the calomel by oxidation with chlorine and returned to the gas-cleaning process.

Removal efficiency depends on the mercury content of the waste gas inlet and is typically 99.7 per cent. Typical mercury outlet concentrations are 0.3–0.5 ppm (UNEP 2019b).

The calomel can be disposed of or used for elemental mercury production. This process like other gas cleaning technologies reduces emissions to air but increases the generation of mercury waste which in turn will require environmentally sound management or by-products requiring use, storage or disposal.

### 5.2.2. Selenium Filter

The selenium filter process removes low elemental mercury content from waste gases of primary ore smelters by converting selenious acid into red amorphous selenium, which reacts with gaseous mercury to form mercury(II) selenide. The selenium filter is a fixed bed filter with a large surface area, designed to achieve an intimate contact with the active substance. A porous inert material similar to a catalyst support is used.

The red amorphous selenium reacts with the mercury in the gas to form mercury(II) selenide:

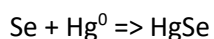

The selenium filter can produce virtually mercury-free waste gases from smelters. It can also be applied as a second waste gas treatment step to lower the mercury content before the gas enters a subsequent acid plant producing mercury-free acids. There are potential impacts on air and water due to vaporization of elemental or oxidized mercury from the production of solid mercury(II) selenide waste. The waste needs to be stabilized before further treatment.

### 5.2.3. Activated Carbon

Sulfur-impregnated activated carbon is a proven technology for removing pollutant gases from process streams in many contexts. In the case of the non-ferrous sector it is widely used in the industrial gold sector to control mercury air emissions. Activated carbon can be applied in either a fixed bed setting or through carbon injection. Mercury contained within the gaseous emissions reacts with the sulfur-impregnated carbon as it passes through the bed, forming mercury(II) sulfide ( $\text{HgS}$ ). Activated carbon has the advantage of removing all types of mercury air emissions, including oxidized, particle-bound and elemental mercury. Spent mercury-loaded sulfur-impregnated carbon may require disposal as hazardous waste.

### 5.2.4. DOWA filter process

The lead(II) sulfide process is a dry media technique used to remove mercury from flue gases generated in non-ferrous metal smelters. The gases containing volatile mercury are passed through a tower packed with lead-sulfide-coated balls, such as granulated pumice, to make the gas contact effectively. Mercury, which has a high vapour pressure, is converted into its sulfide, which has a very low vapour pressure, by contacting the gas with lead(II) sulfide. For the lead(II) sulfide process, a mercury removal efficiency of 99 per cent has been measured, resulting in mercury emission concentrations of 0.01-0.05  $\text{mg}/\text{Nm}^3$ .

### **5.2.5. Co-benefits of air pollution abatement technologies**

Both wet and dry electrostatic precipitators (ESPs) are widely used in the non-ferrous metals sector as a primary stage of particulate matter removal. In dry ESPs, the dust that collects on the charged plates is removed by rapping or vibration. The dust is usually recycled in the smelter process. The use of bag filters is also common in the non-ferrous metals sector, as this technique provides the highest collection efficiency among the particulate control methods.

The non-ferrous metals sector regularly uses wet scrubbers, such as for cooling gases and removing particulate matter and impurities such as SO<sub>3</sub>, HCl and HF as part of the gas cleaning process prior to sulfuric acid production.

ESPs, bag filters and conventional wet scrubbers are typically effective at removing particle bound mercury, and some divalent oxidized mercury, but not elemental mercury vapor (USEPA Office of Air and Radiation 2021). Typically a large portion of the mercury in the gas streams from these type of operations (e.g., smelters, roasters) are in elemental vapor form (USEPA Office of Air and Radiation 2021).

### **5.2.6. Acid plants in mercury control**

The combination of gas cleaning equipment with sulfuric acid plants is a proven technology for sulfur emissions control in the non-ferrous metals industry and its use is common worldwide. A compilation of information<sup>32</sup> on mercury removal systems from off gas cleaning systems in smelters is available<sup>32</sup>.

Under certain conditions, operation of an acid plant with gas cleaning equipment has been shown to be effective in capturing mercury from the gas stream through the use of traditional particulate matter control techniques that result in mercury removal efficiencies equivalent to the use of specific mercury BAT. A recent survey completed in Japan has shown that many companies are successfully relying on gas cleaning and sulfuric acid plants to remove the mercury from the flue gases in metal smelting facilities. The survey shows that mercury is being effectively captured with the use of this method at certain copper, lead and zinc smelters<sup>33</sup>.

### **5.2.7. Sulfuric acid**

Sometimes mercury concentrations are further reduced in the produced sulfuric acid before sale, for example by the use of the so-called "SuperLig Ion Exchange" process (reduces mercury concentrations to < 5 ppm or mg/l) or the "Potassium Iodide" process. In an EU reference document on non-ferrous metal production it is mentioned, that the sulfuric acid "product specification is normally < 0.1 ppm (mg/l)". This value should be seen in a European perspective. Anecdotal evidence indicates that sulfuric acid with higher mercury concentrations may have a market for some technical purposes in some regions of the World (UNEP 2017b).

The web site<sup>34</sup> "Sulphuric acid on the web" includes information about the presence of acid plants, and in some cases mercury-specific emission abatement, on named smelters by country and may thus be useful in the selection of output distribution factors.

### **5.2.8. Process changes to eliminate smelting and emissions from that source**

New developments in mineral processing may also have the potential to significantly reduce atmospheric emissions of mercury. A good example (Fisher and Nelson 2020) is provided by the Kalgoorlie Gold Mining Operation. Historically this was a very large source of mercury emissions (~7 t/y). In 2015, the facility installed a new ultrafine grinding mill to replace the Gidji roaster that was responsible for 90% of the mercury

---

<sup>32</sup> [http://www.sulphuricacid.com/techmanual/GasCleaning/gcl\\_hg.htm](http://www.sulphuricacid.com/techmanual/GasCleaning/gcl_hg.htm)

<sup>33</sup> [JMIA bulletin "Kozan (<http://www.mmf.or.jp/>) " for the April 2015] Takashi Shimizu: Mercury Removal from the Nonferrous Smelter's Off-gas in Japan.

<sup>34</sup> [http://www.sulphuric-acid.com/sulphuric-acid-on-the-web/acid%20plants/Acid\\_Plant\\_Index.htm](http://www.sulphuric-acid.com/sulphuric-acid-on-the-web/acid%20plants/Acid_Plant_Index.htm)

emissions<sup>35</sup>. At the same time, the associated Fimiston processing plant was upgraded with a new carbon regeneration kiln fitted with mercury emission reduction technology<sup>36</sup> (exhaust gas scrubber, regenerative thermal oxidizer, and sulfur impregnated carbon scrubber). Figure 12 shows the change from 2004 to 2017 in mercury emissions from the Kalgoorlie facility, as reported to the Australian National Pollutant Inventory (NPI). Emissions have been separated into contributions from the Gidji roaster (dark blue) and Fimiston processing plant (light blue). The figure shows a long-term decrease in emitted mercury from 2004 to 2014, followed by a drop of 94% from 2014 to 2016 due to the Gidji closure.

This example shows that **changing technology can have a major impact on mercury emissions and that further research and development on improvements to mineral processing should be a high priority.**

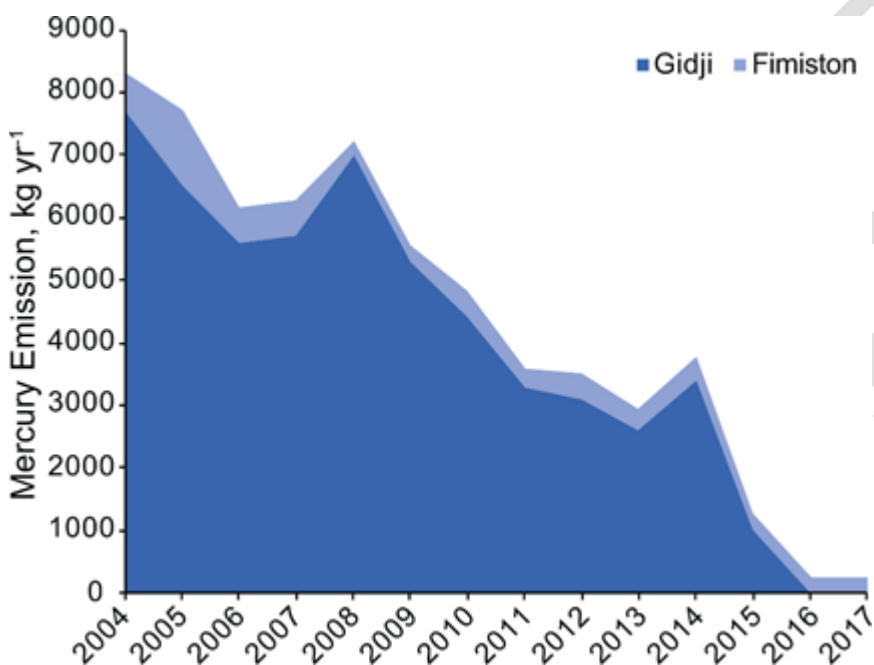

Figure 12: Trend in mercury emissions from gold processing in Kalgoorlie. 2004–2017 NPI-reported mercury emissions (kg yr<sup>-1</sup>) from the Kalgoorlie Consolidated Gold Mines, showing contributions from the Gidji roaster (dark blue) and the Fimiston processing plant (light blue). Note that emissions are reported to NPI on a July–June financial year basis; in the figure, the year given on the x-axis corresponds to the year for the start of the reporting period (e.g., “2004” refers to July 2004–June 2005). DOI:<https://doi.org/10.1525/elementa.2020.070.f2>

From (Fisher and Nelson 2020).

### 5.3. Smelter/ roasting waste and by-product management and releases to land and water

The UNEP BAT/BEP guidance does not discuss these issues in detail but there are two recent studies from China which provide detailed information (Tsinghua University 2019; Zhang *et al.* 2019) for specific plants in China and for the Chinese non-ferrous sector more broadly. See Section 3.2 for discussion of these studies,

<sup>35</sup> Gold mine eliminates processing emissions. Available at <https://www.processonline.com.au/content/business/case-study/gold-mine-eliminates-processing-emissions-315587894>

<sup>36</sup> Fimiston Air Quality Management Plan. Available at [https://superpit.com.au/wp-content/uploads/2015/01/160617-SER\\_ENV\\_PLN1755\\_KCGM-Fimiston-Air-Quality-Management-Plan-Dec-2015.pdf](https://superpit.com.au/wp-content/uploads/2015/01/160617-SER_ENV_PLN1755_KCGM-Fimiston-Air-Quality-Management-Plan-Dec-2015.pdf).

which contain detailed information regarding wastes generated and recommended waste management practices.

The most comprehensive review of techniques to control releases from the non-ferrous sector to water and land, and to manage residues is given in Sections 2.8 and 2.9 of the EU Best available techniques (BAT) reference document for the non-ferrous metals industries. Industrial Emissions Directive 2010/75/EU (integrated pollution prevention and control) (European Commission (Joint Research Centre) et al. 2017). The production of non-ferrous metals by pyrometallurgical and hydrometallurgical methods is associated with the generation of different liquid effluents. The main sources of the most important effluent streams can be classified as shown in Figure 13. Standard water treatment techniques are used to treat these effluents to remove toxic metals including mercury.

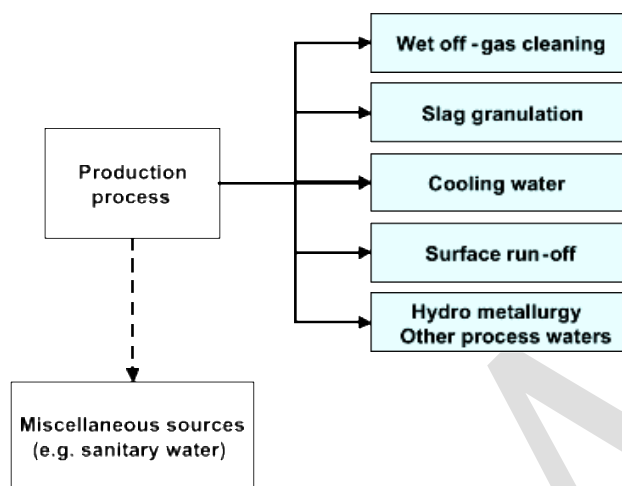

Figure 13: Effluent classification in the non-ferrous sector (European Commission (Joint Research Centre) et al. 2017)

The main residues arising from the smelting of non-ferrous metals are slag, dross and skimmings removed during the pyrometallurgical processes (European Commission (Joint Research Centre) et al. 2017). Most of the slag generated by downstream or refining operations in non-ferrous metals production processes can usually be recycled or used for further metal recovery (European Commission (Joint Research Centre) et al. 2017).

Dross and skimmings arise from the oxidation of metals or by reactions with fireproof material used as furnace linings. The metal content of skimmings and dross is relatively high, therefore they can normally be recycled to the main process or supplied to other non-ferrous metal plants for recovery of metals (European Commission (Joint Research Centre) et al. 2017). Table 2.9 of the *EU Best available techniques (BAT) reference document for the non-ferrous metals industries* (European Commission (Joint Research Centre) et al. 2017) gives a comprehensive overview of the residues produced and their potential for recycling or reuse in the non-ferrous sector.

#### 5.4. Case studies prepared for BAT/BEP guidance

The case studies appended to this report illustrate various issues mostly concerning smelting/ roasting emissions, but also waste handling and acid plants.



## 6. MAJOR CONCLUSIONS AND IDENTIFIED NEEDS FOR FURTHER INVESTIGATION, RESEARCH AND COOPERATION

Non-ferrous metals are all metals apart from iron. The emphasis on this report is on copper, lead, zinc and large-scale gold which all have significant emissions and releases of mercury and are included in the Minamata Convention. It does not include consideration of the primary mining of mercury, or the use of mercury in artisanal and small-scale gold mining (ASGM). Currently the metals included in the Convention make the largest contributions to mercury emissions and releases but this could change in the future as new products are developed.

Non-ferrous metal production is a large anthropogenic source of mercury emissions and estimated to account for around 10-15 % of global mercury emissions to the atmosphere (the third largest source of mercury emissions to air). These emissions largely arise from high temperature processing of ores or concentrates in smelters and roasters. It is also the largest source of mercury releases to water after ASGM, responsible for roughly 40% of total releases to water.

Non-ferrous metals production appears to contribute large quantities of mercury to the land, waste production and storage. Although these quantities are not as well understood based on existing estimates it is likely that they exceed emissions to air and releases to water. In many cases these contributions may be incorporated into secure repositories such as hazardous waste disposal facilities or engineered landfills, potentially removing them from the global mercury cycle.

Mining of non-ferrous ores does not make a major direct contribution to emissions and releases but mining spoilpiles, tailings and stockpiles may result in releases to land and water.

There may also be a need for assessment of mercury releases from deep-sea mining.

Detailed measurements using mass balance techniques on smelters in China and Korea have quantified mercury fluxes in air emissions, land and water releases and waste materials; in some cases, an estimated up to 90% of the mercury departs to the waste.

Additional quantitative information on how mercury partitions between emissions to air, releases to water and land, and generation of wastes and by-products is needed.

A great deal remains unknown about this last pathway of mercury pollution, making it an important subject for future study.

The 2018 AMAP/UNEP Global Mercury Assessment report noted that estimates of mercury emissions to air from non-ferrous metals production had large uncertainties, with a range extending from 154 to 338 tonnes/year for primary total emissions of aluminium, copper, lead, and zinc; and 72-97 tonnes/year for large scale gold production.

Further work to reduce these uncertainties would improve understanding of this major source and assist global efforts to reduce the contribution from this sector. The data required to achieve this include:

- the need for more information on the mercury content in ores and concentrates, including at plant and country level
- More mercury air emissions test data (e.g., stack testing)
- Mercury concentrations in reject material
- Mercury distributions between emissions and other releases
- Activity data (amounts of ores and concentrates processed)
- Effects of pollution control technologies on affecting distribution of mercury between emissions to air and capture in solid and liquid waste streams.

One major challenge is that the concentrations of mercury in ores and concentrates can vary considerably not only between different ore bodies but also in the same ore body depending on its geological associations.

These variations need to be better understood, and standard methods of ore sampling and analysis applied to determine mercury content in specific ores are needed.

By-product mercury recovery from non-ferrous mining and processing operations is an important source of global mercury supply, estimated at about 15% in the 2017 UNEP Global Mercury Supply, Trade and Demand report.

Many countries generate by-product mercury but not all makes its way to market. Restrictions on mercury export (e.g. in the United States and Europe) reduce this source of supply but the available data is incomplete and should be enhanced.

Companies are increasingly treating by-product mercury as waste and managing it by using long term secure storage facilities or permitted disposal facilities.

Given this, development of effective and sustainable regional solutions to secure sufficient capacity for the safe and long-term storage of mercury is a high priority. Innovative methods for the secure storage of mercury would also assist management of mercury by-products and mercury containing wastes.

The non-ferrous sector is likely to grow considerably in the future as additional uses grow in infrastructure and devices, and as the world population and GDP increases.

Production of metals requires a long-term commitment to increased recycling and reuse.

There are geographical complexities to mercury flows in the non-ferrous sector. Mining and the initial production of concentrates may take place in one country but emissions and releases from concentrate processing in another. In addition, embodied emissions from non-ferrous metal production have been estimated to be effectively traded internationally, primarily as exports from emerging economies to wealthy economies through global supply chains.

Understanding the redistribution of mercury along global supply chains should be explored for its potential to facilitate international efforts to reduce mercury emissions and releases from non-ferrous metal production

Mercury speciation as elemental mercury ( $\text{Hg}^0$ ), oxidized mercury ( $\text{Hg}^{2+}$ ), or particulate mercury ( $\text{Hg}_p$ ) is important for determining mercury fate in the atmosphere, water, soils and vegetation. Improved knowledge of the forms of mercury in emissions and releases is crucial for modelling mercury transport and fate.

Recent work done in China on estimating mercury speciation for all industrial sources has enhanced understanding of speciation from the non-ferrous sector but more detailed measurements at a larger number of plants of different types and technologies are required to develop robust estimates of speciation profiles in mercury emissions.

Control techniques for mercury emissions to air from smelting are mature technologies but result in a re-partitioning of mercury from the air to by-products and waste which must be managed in an environmentally sound manner.

Control measures may involve mercury capture in the air pollution control devices associated with the sulfuric acid plants employed at smelters.

It may be appropriate for standards for the levels of mercury in sulfuric acid to be established at national levels. However standards for the level of mercury content in sulfuric acid are well established in industry as the presence of mercury would prevent sales.

Changing technology can have a major impact on mercury emissions and further research and development on improvements to mineral processing should be a high priority.

Capacity Development

- A large number of countries are concerned about the fate of mercury and other impurities released during the mining and smelting of copper, lead and zinc, which belong to the top 5 largest internationally traded commodities.
- Large scale gold production is also a significant contributor to emissions and releases.
- Mineral deposits are increasingly being developed in South America, Africa and Asia and there will be a need for further dissemination of information and awareness-raising on existing best practices and case studies on the issue of mercury in the sector, mercury removal systems, including from off-gas cleaning systems in smelters, risks mitigation measures as well as options for environmentally sound interim storage and disposal of mercury (Sections 3.2, 4.1, 4.2, 5 and 9 (the case studies) address this).

DRAFT

## 7. GUIDANCE ON BEST PRACTICES

### 7.1. Available guidance, tools and resources:<sup>[11]</sup><sub>[SEP]</sub>

- The guidance document on Best Available Techniques and Best Environmental Practices adopted under the Minamata Convention<sup>37</sup>, which addresses the control options for mercury from smelting and roasting processes used in the production of non-ferrous metals (lead, zinc, copper and industrial gold);
- *EU Best available techniques (BAT) reference document for the non-ferrous metals industries* (European Commission (Joint Research Centre) et al. 2017)<sup>38</sup>
- The Basel Convention technical guidelines for the environmentally sound management of wastes consisting of elemental mercury and wastes containing or contaminated with mercury<sup>39</sup>, which is currently being updated;
- The Minamata Convention guidelines on the environmentally sound interim storage of mercury other than waste mercury<sup>40</sup>;
- The “Catalogue of Technologies and Services on Mercury Waste Management - 2020 version” compiled by the leads of the Partnership area on mercury waste management, which highlights services provided by some partners of relevance to the sector<sup>41</sup>.
- A study for the German Environment Agency with mass balances for the national copper, lead, zinc (primary and secondary) industries, among others (Umwelt Bundesamt 2020b; Umwelt Bundesamt 2020a);
- The most recent Overview of Mercury Material Flow in Japan (for Financial Year 2016) (Ministry of the Environment Japan (MOEJ) 2018)  
Reports on specific plants in China and for the Chinese non-ferrous sector more broadly (Tsinghua University 2019; Zhang *et al.* 2019) provide detailed information on emissions, wastes generated and recommended waste management practices

---

<sup>37</sup> [http://mercuryconvention.org/Portals/11/documents/publications/BAT\\_BEP\\_E\\_interractif.pdf](http://mercuryconvention.org/Portals/11/documents/publications/BAT_BEP_E_interractif.pdf)

<sup>38</sup> <https://op.europa.eu/en/publication-detail/-/publication/c0bc6046-651c-11e7-b2f2-01aa75ed71a1>

<sup>39</sup> <http://www.basel.int/Implementation/MercuryWastes/TechnicalGuidelines/tabid/5159/Default.aspx>

<sup>40</sup> <https://www.mercuryconvention.org/en/documents/guidelines-environmentally-sound-interim-storage-mercury-other-waste-mercury-0>

<sup>41</sup> [www.unep.org/globalmercurypartnership/resources/tool/catalogue-technologies-and-services-mercury-waste-management-2021-version](http://www.unep.org/globalmercurypartnership/resources/tool/catalogue-technologies-and-services-mercury-waste-management-2021-version)

## 8. REFERENCES AND BIBLIOGRAPHY

- AMAP/UNEP (2008). Technical Background Report to the Global Atmospheric Mercury Assessment, Arctic Monitoring and Assessment Programme/ UNEP Chemicals Branch, 159 pp. <https://www.unep.org/globalmercurypartnership/resources/report/technical-background-report-global-atmospheric-mercury-assessment-2008>
- AMAP/UNEP (2013). Technical Background Report for the Global Mercury Assessment 2013, Arctic Monitoring and Assessment Programme/ UNEP Chemicals Branch, vi + 263pp.
- AMAP/UNEP (2019). Technical Background Report for the Global Mercury Assessment 2018., viii + 426 pp including E-Annexespp. [www.unep.org/globalmercurypartnership/resources/report/technical-background-report-global-mercury-assessment-2018](http://www.unep.org/globalmercurypartnership/resources/report/technical-background-report-global-mercury-assessment-2018)
- Amos, H. M., Jacob, D. J., Streets, D. G., Sunderland, E. M., 2013. Legacy impacts of all-time anthropogenic emissions on the global mercury cycle. *Global Biogeochemical Cycles* 27, 410-421.
- Beckers, F., Rinklebe, J., 2017. Cycling of mercury in the environment: Sources, fate, and human health implications: A review. *Critical Reviews in Environmental Science and Technology* 47, 693-794.
- Bell, L., DiGangi, J., Weinberg, J. (2014). An NGO Introduction to Mercury pollution and the Minamata Convention on Mercury, International POPs Elimination Network (IPEN), 214pp. <https://ipen.org/documents/ngo-introduction-mercury-pollution-and-minamata-convention-mercury>
- Burton, M. E. H., Evers, D. C. (2019). Global Mercury Inventory Synthesis: An Initial Examination of the MIA Mercury Inventories. Portland, Maine, Biodiversity Research Institute., pp. <https://wedocs.unep.org/bitstream/handle/20.500.11822/31236/HgSynt.pdf?sequence=1&isAllowed=y>
- Canadian Council of Ministers of the Environment (2000). Canada-wide standards for mercury emissions, 13pp. [https://ccme.ca/en/res/cws\\_mercury\\_emissions\\_e.pdf](https://ccme.ca/en/res/cws_mercury_emissions_e.pdf)
- Chung, D., Choi, H.-H., Yoo, H.-Y., Lee, J.-Y., Shin, S.-K., Park, J. M., Kim, J., 2017. Mercury flows in a zinc smelting facility in South Korea. *Journal of Material Cycles and Waste Management* 19, 46-54.
- Corella, J. P., Sierra, M. J., Garralón, A., Millán, R., Rodríguez-Alonso, J., Mata, M. P., de Vera, A. V., Moreno, A., González-Sampériz, P., Duval, B., Amouroux, D., Vivez, P., Cuevas, C. A., Adame, J. A., Wilhelm, B., Saiz-Lopez, A., Valero-Garcés, B. L., 2021. Recent and historical pollution legacy in high altitude Lake Marboré (Central Pyrenees): A record of mining and smelting since pre-Roman times in the Iberian Peninsula. *Science of The Total Environment* 751, 141557.
- Driscoll, C. T., Mason, R. P., Chan, H. M., Jacob, D. J., Pirrone, N., 2013. Mercury as a Global Pollutant: Sources, Pathways, and Effects. *Environmental Science & Technology* 47, 4967-4983.
- Elshkaki, A., Graedel, T. E., Ciacci, L., Reck, B. K., 2018. Resource Demand Scenarios for the Major Metals. *Environmental Science & Technology* 52, 2491-2497.
- Environment Canada (2002). Multi-pollutant emission reduction analysis foundation (MERAF) for the base metal smelter sector. Prepared for Environment Canada and The Canadian Council of Ministers of Environment (CCME), Canada, Environment Canada, Minerals and Metals Division, National Office of Pollution Prevention, pp. <https://www.ec.gc.ca/planp2-p2plan/default.asp?lang=En&n=4AE8C344-1&offset=1&toc=hide>. Accessed 20 January 2021
- European Commission (Joint Research Centre), Delgado Sancho, L., Roudier, S., Farrell, F., Cusano, G., Rodrigo Gonzalo, M. (2017). Best available techniques (BAT) reference document for the non-ferrous metals industries. Industrial Emissions Directive 2010/75/EU (integrated pollution prevention and control), European Union, 1233pp. <https://op.europa.eu/en/publication-detail/-/publication/c0bc6046-651c-11e7-b2f2-01aa75ed71a1>
- Eviron (2006). Public Environmental Review Fimiston Gold Mine Operations Extension (Stage 3) and Mine Closure Planning for KCGM Pty Ltd. Appendix F1: Distribution of Tellurides and Mercury in Fimiston Open Pit (KCGM), 256pp.
- Fisher, J. A., Nelson, P. F., 2020. Atmospheric mercury in Australia: Recent findings and future research needs. *Elementa: Science of the Anthropocene* 8.

- Fu, X. W., Feng, X. B., Sommar, J., Wang, S. F., 2012. A review of studies on atmospheric mercury in China. *Science of the Total Environment* 421, 73-81.
- Giang, A., Selin, N. E., 2016. Benefits of mercury controls for the United States. *Proceedings of the National Academy of Sciences of the United States of America* 113, 286-291.
- Gustafsson, T., Munthe, J., Min, A., Kindbom, K., Sjödin, Å., Si, G. (2013). Mercury management in non-ferrous metal industry in China – a baseline study for the Swedish Environmental Protection Agency, 31pp.
- Hylander, L. D., Herbert, R. B., 2008. Global emission and production of mercury during the pyrometallurgical extraction of nonferrous sulfide ores *Environmental Science & Technology* 42, 5971-5977.
- Intergovernmental Forum on Mining Minerals Metals and Sustainable Development (IGF) (2018). *Global Trends in Artisanal and Small-Scale Mining (ASM): A review of key numbers and issues*. Winnepeg, The International Institute for Sustainable Development, 91pp. <http://pubs.iied.org/G04266/?k=mining>
- International Bank for Reconstruction and Development/The World Bank (2017). *The Growing Role of Minerals and Metals for a Low Carbon Future*, The World Bank, 112pp.
- International Zinc Association 2021. Information provided by the International Zinc Association (IZA): 3.
- Jaffe, D., Strode, S., 2008. Sources, fate and transport of atmospheric mercury from Asia. *Environmental Chemistry* 5, 121-126.
- Jiang, X., Wang, F., 2019. Mercury emissions in China: a general review. *Waste Disposal & Sustainable Energy* 1, 127-132.
- Kerfoot, W. C., Harting, S. L., Jeong, J., Robbins, J. A., Rossmann, R., 2004. Local, Regional, and Global Implications of Elemental Mercury in Metal (Copper, Silver, Gold, and Zinc) Ores: Insights from Lake Superior Sediments. *Journal Of Great Lakes Research* 30, 162-184.
- Kocman, D., Horvat, M., Pirrone, N., Cinnirella, S., 2013. Contribution of contaminated sites to the global mercury budget. *Environmental Research* 125, 160-170.
- Li, G. H., Feng, X. B., Li, Z. G., Qiu, G. L., Shang, L. H., Liang, P., Wang, D. Y., Yang, Y. K., 2010. Mercury emission to atmosphere from primary Zn production in China. *Science of the Total Environment* 408, 4607-4612.
- Li, J. S., Chen, B., Chen, G. Q., Wei, W. D., Wang, X. B., Ge, J. P., Dong, K. Q., Xia, H. H., Xia, X. H., 2017. Tracking mercury emission flows in the global supply chains: A multi-regional input-output analysis. *Journal of Cleaner Production* 140, 1470-1492.
- Li, S., Bi, X., Li, Z., Wang, H., Li, X., Feng, X., Sun, G., Chen, J., Meng, B., 2021. Heavy Metal(loid)s Contamination in Ground Dust and Associated Health Risks at a Former Indigenous Zinc Smelting Area. *International Journal of Environmental Research and Public Health* 18, 893.
- Liao, Y., Liu, W., Xu, H., Hong, Q., Wang, Y., Qu, Z., Yan, N., 2020. Zinc concentrate internal circulation technology for elemental mercury recovery from zinc smelting flue gas. *Fuel* 280, 118566.
- Lindberg, S., Bullock, R., Ebinghaus, R., Engstrom, D., Feng, X. B., Fitzgerald, W., Pirrone, N., Prestbo, E., Seigneur, C., 2007. *pac. Ambio* 36, 19-32.
- Liu, W., Xu, H., Liao, Y., Wang, Y., Yan, N., Qu, Z., 2020. Co-doped ZnS with large adsorption capacity for recovering Hg(0) from non-ferrous metal smelting gas as a co-benefit of electrostatic demisters. *Environ Sci Pollut Res Int* 27, 20469-20477.
- Maxson, P. A., 2005. Global mercury production, use and trade. *Dynamics of Mercury Pollution on Regional and Global Scales: Atmospheric Processes and Human Exposures around the World*, 25-50.
- Mimna, R., Kildea, J., Phillips, E. C., Carlson, W., Keiser, B., Meier, J. 2016. Opportunities for Improved Environmental Control in the Alumina Industry. *Essential Readings in Light Metals: Volume 1 Alumina and Bauxite*. D. Donaldson and B. E. Raahauge. Cham, Springer International Publishing: 903-908.
- Ministry of the Environment Japan (MOEJ) (2018). *Overview of Mercury Material Flow in Japan (FY2016)*, Ministry of the Environment, Japan (MOEJ), 69pp.
- Nelson, P. F., Morrison, A. L., Malfroy, H. J., Cope, M., Lee, S., Hibberd, M. L., Meyer, C., McGregor, J., 2012. Atmospheric mercury emissions in Australia from anthropogenic, natural and recycled sources. *Atmospheric Environment*.
- Nriagu, J. O., 1989. A Global Assessment of Natural Sources of Atmospheric Trace-Metals. *Nature* 338, 47-49.
- Nriagu, J. O., 1990. Global metal pollution: poisoning the biosphere? *Environment* 32, 7-33.

- Nriagu, J. O., Pacyna, J. M., 1988. Quantitative Assessment of Worldwide Contamination of Air, Water and Soils by Trace-Metals. *Nature* 333, 134-139.
- O'Neill, J. D., Telmer, K. (2017). Estimating Mercury Use and Documenting Practices in Artisanal and Small-scale Gold Mining (ASGM). ISBN 978-0-9939459-8-4. Geneva, Switzerland, UNEP, 196pp. [https://wedocs.unep.org/bitstream/handle/20.500.11822/22892/ASGM\\_toolkit\\_eguide\\_EN\\_180216.compressed.pdf?sequence=1&isAllowed=y](https://wedocs.unep.org/bitstream/handle/20.500.11822/22892/ASGM_toolkit_eguide_EN_180216.compressed.pdf?sequence=1&isAllowed=y)
- Pacyna, E. G., Pacyna, J. M., 2002. Global Emission of Mercury from Anthropogenic Sources in 1995. *Water, Air, and Soil Pollution* 137, 149-165.
- Pacyna, E. G., Pacyna, J. M., Fudala, J., Strzelecka-Jastrzab, E., Hlawiczka, S., Panasiuk, D., 2006a. Mercury emissions to the atmosphere from anthropogenic sources in Europe in 2000 and their scenarios until 2020. *Science of the Total Environment* 370, 147-156.
- Pacyna, E. G., Pacyna, J. M., Steenhuisen, F., Wilson, S., 2006b. wils. *Atmospheric Environment* 40, 4048-4063.
- Pacyna, E. G., Pacyna, J. M., Sundseth, K., Munthe, J., Kindbom, K., Wilson, S., Steenhuisen, F., Maxson, P., 2010. amap. *Atmospheric Environment* 44, 2487-2499.
- Pacyna, J. M., Munthe, J., Larjava, K., Pacyna, E. G., 2005. Mercury emissions from anthropogenic sources: Estimates and measurements for Europe. *Dynamics of Mercury Pollution on Regional and Global Scales: Atmospheric Processes and Human Exposures around the World*, 51-64.
- Pacyna, J. M., Pacyna, E. G., Aas, W., 2009. Changes of emissions and atmospheric deposition of mercury, lead, and cadmium. *Atmospheric Environment* 43, 117-127.
- Pacyna, J. M., Pacyna, E. G., Steenhuisen, F., Wilson, S., 2003. Mapping 1995 global anthropogenic emissions of mercury. *Atmospheric Environment* 37, S109-S117.
- Pirrone, N., Cinnirella, S., Feng, X., Finkelman, R. B., Friedli, H. R., Leaner, J., Mason, R., Mukherjee, A. B., Stracher, G. B., Streets, D. G., Telmer, K., 2010. Global mercury emissions to the atmosphere from anthropogenic and natural sources. *Atmospheric Chemistry and Physics* 10, 5951-5964.
- Pirrone, N., Cinnirella, S., Feng, X. B., Finkelman, R. B., Friedli, H. R., Leaner, J., Mason, R., Mukherjee, A. B., Stracher, G., Streets, D. G., Telmer, K. 2009. Global Mercury Emissions to the Atmosphere from Natural and Anthropogenic Sources. *Mercury Fate and Transport in the Global Atmosphere: Emissions, Measurements and Models*. N. Pirrone and R. Mason: 3-49.
- Rauch, J. N., Pacyna, J. M., 2009. Earth's global Ag, Al, Cr, Cu, Fe, Ni, Pb, and Zn cycles. *Global Biogeochemical Cycles* 23.
- Russian Federal Service for Environmental Technological and Atomic Supervision, Danish Environmental Protection Agency (2005). Assessment of Mercury Releases from the Russian Federation. Prepared for the Arctic Council, 344pp.
- Rytuba, J. J., 2003. Mercury from mineral deposits and potential environmental impact. *Environmental Geology* 43, 326-338.
- Selin, N. E., 2009. Global Biogeochemical Cycling of Mercury: A Review. *Annual Review of Environment and Resources* 34, 43-63.
- Staun, C., Vaughan, J., Lopez-Anton, M. A., Rumayor, M., Martínez-Tarazona, M. R., 2018. Geochemical speciation of mercury in bauxite. *Applied Geochemistry* 93, 30-35.
- Streets, D. G., Devane, M. K., Lu, Z. F., Bond, T. C., Sunderland, E. M., Jacob, D. J., 2011. All-Time Releases of Mercury to the Atmosphere from Human Activities. *Environmental Science & Technology* 45, 10485-10491.
- Streets, D. G., Hao, J., Y., W., Jiang, J., Chan, M., Tian, H., Feng, X., 2005. Anthropogenic mercury emissions in China. *Atmospheric Environment* 39, 7789-7806.
- Streets, D. G., Horowitz, H. M., Jacob, D. J., Lu, Z., Levin, L., ter Schure, A. F. H., Sunderland, E. M., 2017. Total Mercury Released to the Environment by Human Activities. *Environmental Science & Technology*.
- Streets, D. G., Zhang, Q., Wu, Y., 2009. Projections of Global Mercury Emissions in 2050. *Environmental Science & Technology* 43, 2983-2988.
- Tsinghua University (2019). Mercury emissions and release in zinc smelters in China. Natural Resources Defence Council Project, Natural Resources Defence Council Project, 42pp.

- Umwelt Bundesamt (2020a). Quecksilberemissionen aus industriellen Quellen – Status Quo und Perspektiven Abschlussbericht - Teil 2: Quecksilberminderungstechniken und Überführung von Quecksilber in Senken, Umwelt Bundesamt, 343pp. <https://protect-au.mimecast.com/s/Zc94CgZ05Jf0oYpmCoxbrg?domain=umweltbundesamt.de>
- Umwelt Bundesamt (2020b). Quecksilberemissionen aus industriellen Quellen – Status Quo und Perspektiven Abschlussbericht – Teil 1: Quecksilber-Entstehungs- und Verbreitungspfade der Industriebranchen in Deutschland, Umweltbundesamt, 513pp. <https://protect-au.mimecast.com/s/xqUhCOYKgRso7rZMcwkrti?domain=umweltbundesamt.de>
- UNECE (2013). Guidance document on best available techniques for controlling emissions of heavy metals and their compounds from the source categories listed in annex II to the Protocol on Heavy Metals, UN Economic Commission for Europe: Executive Body for the Convention on Long-range Transboundary Air Pollution, 33pp. [http://www.unece.org/net4all.ch/fileadmin/DAM/env/documents/2012/EB/ECE\\_EB.AIR\\_116\\_E.pdf](http://www.unece.org/net4all.ch/fileadmin/DAM/env/documents/2012/EB/ECE_EB.AIR_116_E.pdf)
- UNEP 2005. Toolkit for identification and quantification of mercury releases.
- UNEP, 2006. Guide for reducing major uses and releases of mercury.
- UNEP (2013a). Global Mercury Assessment 2013: Sources, emissions, releases, and environmental transport, United Nations Environment Program, 42pp.
- UNEP (2013b). Mercury Time to Act, 44pp. [https://wedocs.unep.org/bitstream/handle/20.500.11822/27436/mercury\\_timetoact.pdf?sequence=1&isAllowed=y](https://wedocs.unep.org/bitstream/handle/20.500.11822/27436/mercury_timetoact.pdf?sequence=1&isAllowed=y)
- UNEP (2017a). Global mercury supply, trade and demand, UN Environment, 81pp. <https://www.unep.org/resources/report/global-mercury-supply-trade-and-demand>
- UNEP (2017b). Toolkit for Identification and Quantification of Mercury Releases Reference Report and Guideline for Inventory Level 2. Version 1.4. Geneva, Switzerland, UN Environment Chemicals Branch, 339 pp.
- UNEP (2019a). Global Mercury Assessment 2018. Geneva, Switzerland, UN Environment Programme, Chemicals and Health Branch, 60pp.
- UNEP (2019b). Guidance on best available techniques and best environmental practices. Minamata Convention on Mercury. Geneva, Switzerland, Secretariat of the Minamata Convention on Mercury, 193pp. <https://www.mercuryconvention.org/en/documents/guidance-best-available-techniques-and-best-environmental-practices-taking-account-any>
- UNEP (2019c). Toolkit for Identification and Quantification of Mercury Releases Reference Report and Guideline for Inventory Level 2. Version 1.5. Geneva, Switzerland, UN Environment Chemicals Branch, 354pp. <https://wedocs.unep.org/handle/20.500.11822/30684>
- USEPA (1997a). Mercury Study Report to Congress. Fate and transport of mercury in the Environment, vol. III. Washington, DC, US Environmental Protection Agency, 376pp. <https://www.epa.gov/sites/default/files/2015-09/documents/volume3.pdf>
- USEPA (1997b). Mercury Study to Congress Volume VIII An Evaluation of Mercury Control Technologies and Costs, USEPA Office of Air Quality Planning and Standards and Office of Research and Development, pp.
- USEPA Office of Air and Radiation 2021. Comments on draft report.
- Wang, C., Qin, R., Zhang, X., Mei, J., Yang, S., 2021. Safe disposal of deactivated commercial selective catalytic reduction catalyst (V2O5-MoO3/TiO2) as a low-cost and regenerable sorbent to recover gaseous elemental mercury in smelting flue gas. *Journal of Hazardous Materials* 406, 124744.
- Wang, S. X., Song, J. X., Li, G. H., Wu, Y., Zhang, L., Wan, Q., Streets, D. G., Chin, C. K., Hao, J. M., 2010. Estimating mercury emissions from a zinc smelter in relation to China's mercury control policies. *Environmental Pollution* 158, 3347-3353.
- Wang, S. X., Zhang, L., Wang, L., Wu, Q. R., Wang, F. Y., Hao, J. M., 2014. A review of atmospheric mercury emissions, pollution and control in China. *Frontiers of Environmental Science & Engineering* 8, 631-649.



- Wilson, S. J., Steenhuisen, F., Pacyna, J. M., Pacyna, E. G., 2006. Mapping the spatial distribution of global anthropogenic mercury atmospheric emission inventories. *Atmospheric Environment* 40, 4621-4632.
- World Economic Forum (2010). *Mining & Metals Scenarios to 2030*, 48pp.
- World Economic Forum (2014). *The Future Availability of Natural Resources: A New Paradigm for Global Resource Availability*, 56pp.
- World Economic Forum (2015). *Mining & Metals in a Sustainable World 2050*, World economic Forum, 43pp.
- Wu, Q., Li, G., Wang, S., Liu, K., Hao, J., 2018. Mitigation options of atmospheric Hg emissions in China. *Environmental Science & Technology*.
- Wu, Q., Wang, S., Hui, M., Wang, F., Zhang, L., Duan, L., Luo, Y., 2015. New Insight into Atmospheric Mercury Emissions from Zinc Smelters Using Mass Flow Analysis. *Environmental Science & Technology* 49, 3532-3539.
- Wu, Q., Wang, S., Li, G., Liang, S., Lin, C.-J., Wang, Y., Cai, S., Liu, K., Hao, J., 2016a. Temporal Trend and Spatial Distribution of Speciated Atmospheric Mercury Emissions in China During 1978–2014. *Environmental Science & Technology*.
- Wu, Q., Wang, S., Zhang, L., Hui, M., Wang, F., Hao, J., 2016b. Flow Analysis of the Mercury Associated with Nonferrous Ore Concentrates: Implications on Mercury Emissions and Recovery in China. *Environmental Science & Technology*, 1796-1803.
- Wu, Q. R., Wang, S. X., Zhang, L., Song, J. X., Yang, H., Meng, Y., 2012. Update of mercury emissions from China's primary zinc, lead and copper smelters, 2000-2010. *Atmos. Chem. Phys.* 12, 11153-11163.
- Wu, Y., Wang, S., Streets, D. G., Hao, J., Chan, M., Jiang, J., 2006. Trends in Anthropogenic Mercury Emissions in China from 1995 to 2003. *Environmental Science & Technology* 40, 5312-5318.
- Wu, Z., Zhang, L., Xia, T., Jia, X., Wang, S., 2020. Heavy metal pollution and human health risk assessment at mercury smelting sites in Wanshan district of Guizhou Province, China. *RSC Advances* 10, 23066-23079.
- Yang, M. (2015). *Research on atmospheric mercury emission inventory and control technology of gold production in China*, Postdoctoral work report. Beijing, Tsinghua University, pp.
- Yang, S., Li, Z., Yan, K., Zhang, X., Xu, Z., Liu, W., Liu, Z., Liu, H., 2021a. Removing and recycling mercury from scrubbing solution produced in wet nonferrous metal smelting flue gas purification process. *Journal of Environmental Sciences* 103, 59-68.
- Yang, S., Liu, C., Wang, P., Yi, H., Shen, F., Liu, H., 2021b. Co9S8 nanoparticles-embedded porous carbon: A highly efficient sorbent for mercury capture from nonferrous smelting flue gas. *Journal of Hazardous Materials* 412, 124970.
- Ye, X., Hu, D., Wang, H., Chen, L., Xie, H., Zhang, W., Deng, C., Wang, X., 2015. Atmospheric mercury emissions from China's primary nonferrous metal (Zn, Pb and Cu) smelting during 1949–2010. *Atmospheric Environment* 103, 331-338.
- Zhang, L., Cao, S., Zhu, X., Zhou, P., Zhao, Y. (2019). *Meeting Minamata: A Cost-Effective Compliance Roadmap for Mercury Pollution Control in China's Non-Ferrous Metal (Zinc, Lead and Copper) Smelters*. Prepared for the Natural Resources Defence Council, Nanjing University, 106pp.
- Zhang, L., Wang, S., Wang, L., Wu, Y., Duan, L., Wu, Q., Wang, F., Yang, M., Yang, H., Hao, J., Liu, X., 2015. Updated Emission Inventories for Speciated Atmospheric Mercury from Anthropogenic Sources in China. *Environmental Science & Technology* 49, 3185-3194.
- Zhang, L., Wang, S., Wu, Q., Meng, Y., Yang, H., Wang, F., Hao, J., 2012. Were mercury emission factors for Chinese non-ferrous metal smelters overestimated? Evidence from onsite measurements in six smelters. *Environmental Pollution* 171, 109-117.
- Zhang, L., Wang, S., Wu, Q., Wang, F., Lin, C. J., Zhang, L., Hui, M., Yang, M., Su, H., Hao, J., 2016. Mercury transformation and speciation in flue gases from anthropogenic emission sources: a critical review. *Atmos. Chem. Phys.* 16, 2417-2433.

## 9. ATTACHMENT: CASE STUDIES

### 1. Case Study – Zinc/Lead Smelter and Refinery

This case study presents general information on mercury emissions controls at an integrated zinc-lead smelter and refinery in a developed country. The facility produces refined zinc, lead, silver, gold, and other refined metals, as well as sulfur products including sulfuric acid. The facility also recovers mercury and mercury compounds (including mercury(I) chloride - calomel) as by-products.

Mercury enters the facility through various streams, primarily ore concentrates, with minor amounts from coal, coke and secondary feeds. The majority of the mercury in the zinc concentrates and other zinc feedstock is volatilized to the off gas during zinc roasting. Similarly, the majority of the mercury contained in the lead concentrates and other lead feedstock, including zinc plant residue and other reverts, is volatilized and departs to the off gas during the lead smelting process.

Initially, the process gas streams from both the zinc roaster and lead smelter are cleaned separately to remove particulate matter using dry electrostatic precipitators. The collected particulate matter is recycled back to the zinc or lead operations, as appropriate. The partially cleaned gas streams are quenched and then combined for final cleaning and treatment in the Mercury Removal Plant prior to being processed in the sulfuric acid plant.

The washing and cooling step utilises wet scrubbers to quench the process gas and further remove particulate matter. The quenched gas from the zinc and lead streams are combined and then passed through packed towers with cooling water to control the temperature of the gas. As a final gas cleaning step, the gas is passed through two sets of wet electrostatic precipitators to remove any remaining particulate and mist.

The cleaned gas is then passed through a Boliden-Norzink mercury removal tower prior to sulfuric acid production, where the gas is scrubbed with a solution of mercury(II) chloride ( $\text{HgCl}_2$ ). The trace mercury in the gas reacts with the mercury(II) chloride to form mercury(I) chloride ( $\text{Hg}_2\text{Cl}_2$ , calomel), which is insoluble and settles as a precipitate. To refresh the mercury removal tower scrubbing solution, a bleed stream containing calomel is removed and reacted with chlorine to reform mercury(II) chloride. The scrubbed gas is then processed in the acid plant for sulfuric acid production. The by-product calomel is stored or transferred off-site for recycling as appropriate.

Various internal residue and recycle streams are generated as a result of handling the mercury-containing gases and solids. These are re-introduced to the front end pyrometallurgical processes (zinc roasting and lead smelting) to maximize overall capture. In particular, the wash solution from the process gas quenching and cooling contains some of the volatilized mercury. The effluent from washing and cooling the gas stream is also weakly acidic. The wash solution is treated in an internal effluent treatment plant where metals are removed in a lime precipitation process. In addition, a small amount of mercury will deport to the zinc leaching circuit via dust collection and pressure leaching. This mercury is collected in zinc plant residues, which are dewatered and recycled to the lead smelter feed. As a result of smelting, mercury from these internal residues enters the hot process gas stream for eventual recovery, as already described.

To monitor its mercury emissions, the facility performs regular stack sampling, monthly at three stacks and quarterly on a fourth stack, aligning with regulatory requirements. Effluents are analyzed to confirm effluent treatment performance and to monitor effluent released to the environment. Product sulfuric acid is analyzed prior to shipment to confirm mercury content.

Overall, this facility achieves over 99.5% mercury capture based on inputs and recorded release in effluent and stacks. Mercury is recovered primarily as calomel but also as a minor amount of elemental mercury. The facility consistently produces sulfuric acid with mercury content well below 1.0 ppm.

DRAFT

## 2. Case Study on Mercury Controls for a Gold Ore Roasting Facility

Facility Name: Barrick Goldstrike Roaster

Facility Location: 26 miles Northeast of Carlin, NV

### Process Description – General

The western United States, particularly the basin and range province that includes portions of California, Arizona, Nevada, Utah, and Idaho includes large areas where mercury occurs naturally. In 2000, Barrick Gold implemented an oxygen roasting process to treat carbonaceous sulfide ore from its Goldstrike property in Nevada. To meet the strict requirements on air emissions, the roaster gas cleaning system was designed to operate with high reliability and to achieve very high collection efficiencies for mercury, as well as particulate matter, SO<sub>2</sub>, CO and NO<sub>x</sub>. The Outotec BN Mercury Abatement Process is well established in base metal smelters and was installed at the Goldstrike plant to reduce the mercury content of the roaster off-gas stream.

The Barrick Goldstrike Roaster processes approximately sixteen to eighteen thousand short tons of gold ore per day. The process includes crushing, grinding, roasting and leaching of the roasted ore. During the roasting process the ground ore is fed to two 2-stage oxygen roasters, operating at a temperature of about 550-750 °C. During the roasting process the ore's contents of sulfur and carbon are oxidized, producing a calcine suitable for cyanide/CIL leaching to extract the gold. Mercury is volatilized during roasting and reports to the gas system. The roasting process produces a gas stream containing heavy particulate loading, strong SO<sub>2</sub>, CO, NO<sub>x</sub> and significant quantities of mercury. The following table shows the typical contaminant levels found in the roaster off gas before treatment.

Typical levels of contaminants in roaster off-gas (dry basis)

Particulate (g/Nm <sup>3</sup> )	500-720
Mercury (mg/Nm <sup>3</sup> )	370-550
CO (g/Nm <sup>3</sup> )	0.46 (peak level 17.2)
SO <sub>2</sub> (g/Nm <sup>3</sup> )	125-290
NO <sub>x</sub> (g/Nm <sup>3</sup> )	0.58-1.72

The gases produced from the roasting process are treated through several steps, some of which are co-pollutant controls, as well as specific unit processes that are applied to minimize mercury emissions to the greatest extent possible.

### Gas Control Technologies Description

The process flow diagram is provided as reference to the function of each mercury emissions control process that is in place to treat the roaster off gas.

### Unit Process Descriptions of Roaster Off-Gas Treatment

#### *Cyclone Separation*

The off gas from the roaster is first treated by cyclones to remove particulate matter (PM) which can have mercury coincident with the PM. Less than one percent of the total ore treated is carried to the cyclone

overflow and thus continues farther into the gas stream treatment system as PM. The remainder of the ore, greater than 99%, is separated and thereby continues as the product stream.

### ***Gas Quench***

In the gas quench step, fresh water is sprayed into a large vertical pipe from the cyclone overflow. The primary purpose of the gas quench process is to cool the gases coming from the roaster; it also captures small amounts of PM including some oxidized mercury which is present in the gas. Mercury capture is measurable in the gas quench solution.

### ***Venturi Gas Scrubbing***

Further gas cleaning (both PM and oxidized mercury) is performed by a venturi style dust scrubber. The venturi scrubber functions through a pressure differential across a controlled opening (i.e., the throat). The gas and liquid become intimately mixed within the throat of the scrubber, thereby improving the extraction of the PM and other soluble or insoluble PM and oxidized mercury.

### ***Gas Condenser***

After the venturi scrubber, additional gas cooling and mercury separation is accomplished with a tube and shell indirect heat exchanger (shown in the diagram as a “condenser”); this cooling allows for a small amount of elemental mercury to be condensed and captured in the condensate collection tank.

### ***Wet Electrostatic Precipitator (WESP)***

The final removal of PM is accomplished in a wet electrostatic precipitator (WESP). The WESP provides co-benefits in that a significant quantity (up to 50%) of elemental mercury that is present is captured in the WESP.

### ***Calomel Scrubber***

Following the WESP, a calomel scrubber is used to treat the roaster off gas for mercury removal. The gas stream is contacted in a fixed bed scrubber arrangement with a solution of mercury (II) chloride ( $\text{HgCl}_2$ ) which reacts with the elemental mercury in the gas to form a stable mercury(I) chloride ( $\text{Hg}_2\text{Cl}_2$ ) compound known as calomel. The solid mercury(I) chloride, calomel ( $\text{Hg}_2\text{Cl}_2$ ), is separated and a part is shipped for environmentally sound disposal. The remaining part is chlorinated with  $\text{Cl}_2(\text{g})$  to regenerate  $\text{HgCl}_2$  to be used again in the calomel scrubber.

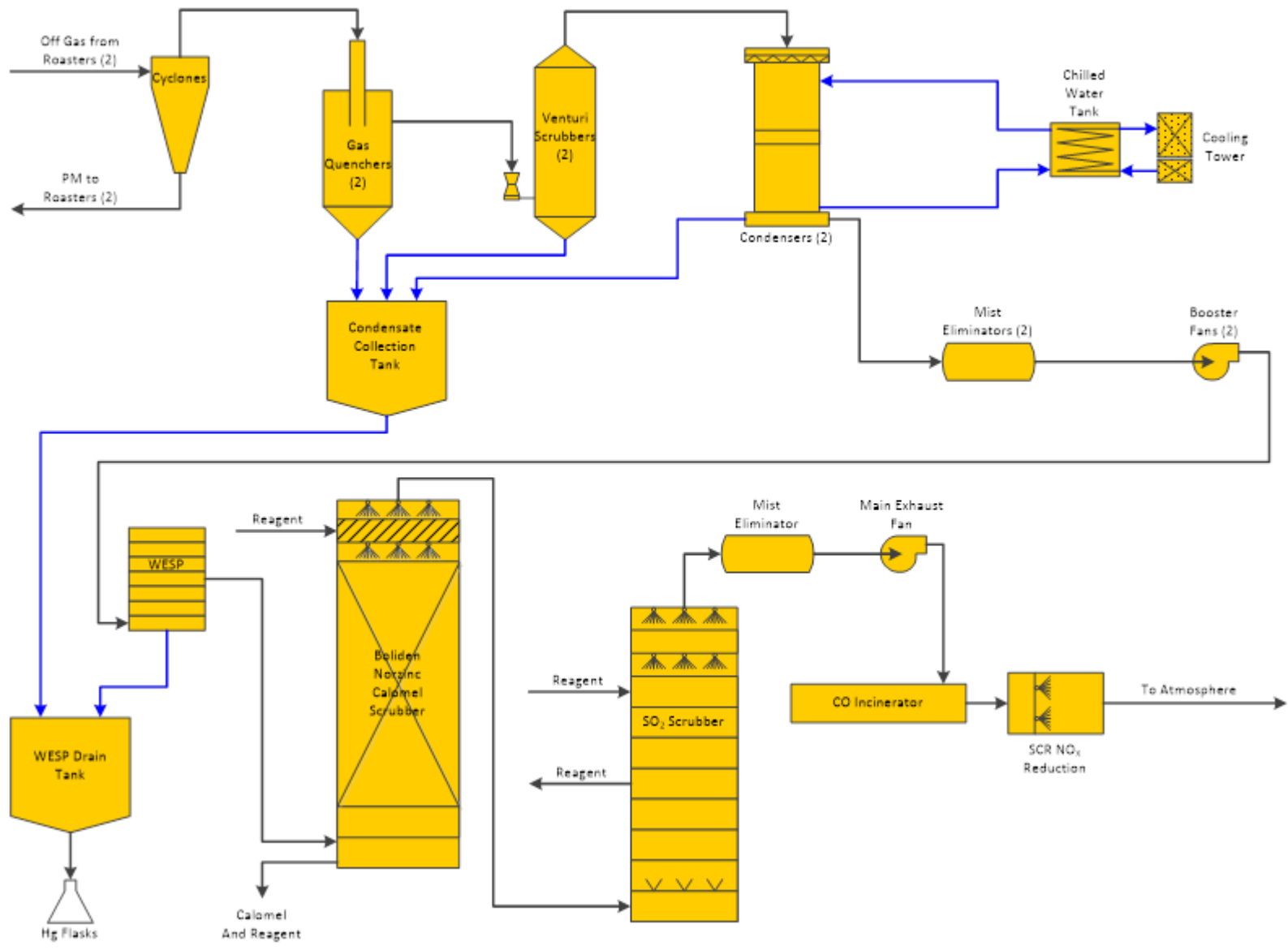

### **Overall Operating Performance**

The use of these various control technologies allows for changes in feed material characterization since removal efficiency does not rely on a single process step. The design intent and operation of this roaster and gas treatment facility has been successfully operated since it's commissioning in 2000 with control efficiencies of greater than 99% as shown in the following table. The data shown below is based on actual stack testing for mercury emissions and the actual mercury produced as both elemental and calomel from the various control and capture points described above.

#### **Roaster Mercury Emission Control Effectiveness**

<b>Year</b>	<b>Hg Emissions (kg/yr)</b>	<b>Hg Co-Product (kg/yr)</b>	<b>Control Efficiency (%)</b>
<b>2002</b>	369	*	*
<b>2003</b>	75	*	*
<b>2004</b>	237	*	*
<b>2005</b>	49	*	*
<b>2006</b>	106	85,018	99.9
<b>2007</b>	203	50,829	99.6
<b>2008</b>	92	59,239	99.8
<b>2009</b>	78	54,545	99.9
<b>2010</b>	51	53,866	99.9
<b>2011</b>	196	53,455	99.6
<b>2012</b>	60	42,708	99.9
<b>2013</b>	112	50,672	99.8

\* Data not available

### 3. Case study: mercury scrubbing during zinc smelting in ISF furnace

Facility Name: Hachinohe Smelting, ISP plant

Facility Location: 80 km East of Hirosaki, Japan

In this process, a mixed zinc–lead concentrate is sintered at a temperature of 1250°C in a sintering furnace. The mercury containing off-gas from the sintering furnace is directed to an air pollution control system to remove dust and mercury that consists of the following units:

- dry electrostatic precipitator (dry ESP),
- venturi scrubber (VS),
- first gas cooler (GC),
- first wet electrostatic precipitator (wet ESP)
- a second GC and
- a second wet ESP

Subsequently, off-gases enter the drying tower (DT). Downstream of the DT, the flue gases pass through a converting process and absorption tower (CAT), where Lurgi double conversion double absorption is used, and H<sub>2</sub>SO<sub>4</sub> is produced.

Following the CAT, a wet scrubber (WS) employing caustic soda (NaOH) is used to remove the remaining SO<sub>2</sub> in the flue gases. The gas at the outlet of the WS is emitted via a stack. The H<sub>2</sub>SO<sub>4</sub> is purified using cementation on aluminium.

Mass balance based on measurements (see table) show that the majority of mercury is removed in the control devices of the sintering furnace (90 – 95%) and can be found in sludges, containing > 1% of mercury. Crude sulfuric acid contains > 1 ppm and requires additional purification.

#### Mercury concentration in off-gases

Flue gas Samples	[ µg/Nm <sup>3</sup> ]	
	Outlet of dry ESP	2600
Outlet of 2nd wet ESP	140	260
Outlet of converting process and absorption tower (CAT)	64	45
Outlet of wet scrubber (stack)	1.7	2.2



### Mercury concentration in solids

<b>Solid Samples</b>	<b>[ppm]</b>	<b>Standard Deviation [ppm]</b>
Zinc ore	3.9	0.15
Fly ash	8.1	0.27
Sludge with high Hg	18000	3200
Aluminum residue	820	15
Sludge from total wastewater	17	-

### Mercury concentration in liquids

<b>Liquid Samples</b>	<b>[µg/L]</b>	<b>Standard Deviation [µg/L]</b>
Wastewater from WS	910	18
Wastewater from VS	0.82	0.035
Crude sulfuric acid	1.1 ppm	1.3 ppm
Sulfuric acid product	0.13 ppm	0.14 ppm

This example confirms, that in the case of low content of mercury in raw material, standard procedure of gas cleaning (dry ESP, Venturi scrubber and wet ESP) is sufficient to limit stack gas mercury emission to achieve low emission levels.

### Reference

Removal of mercury and sulfuric acid production in ISP zinc smelting, M. Takaoka, D. Hamaguchi, R. Shinmura, T. Sekiguchi, H. Tokuich, Japan, 2014.

## 4. Case study Zinc/lead/copper production at Boliden Rönnskär (Sweden)

### Description

Boliden Rönnskär is the largest production site of the Boliden company. It was established in 1930. The main products are copper, lead, zinc clinker, gold and silver; by-products include sulfuric acid.<sup>42</sup> Copper and lead concentrates originate from Boliden's own mines and from external mines. For many years it has been one of the world's largest recyclers of electronic scrap.

Smelting takes place in different types of furnaces, depending on the raw material. In 2014, Boliden Rönnskär produced 217 kt copper cathodes, processing 844 kt copper concentrates and secondary materials.<sup>43</sup>

### Technical description

#### Copper production

Boliden Rönnskär uses a Flash Furnace as well as a Fluidized Bed Roaster combined with an Electric Furnace for processing copper concentrates. Process gases from the bed roaster, smelting furnaces and converters are directed to the double contact/double absorption acid plants or a liquid SO<sub>2</sub> plant equipped with a Boliden Norzink technique, DOWA filter or selenium filters for mercury reduction.

The output of the Fluidized Bed Roaster enters into an Electric Smelting Furnace (also processing secondary material). The mattes of the Electric Smelting Furnace and the Flash Furnace enter a Converter Aisle producing blister copper.

Electronic scrap is fed to the TBRC Kaldo furnace (top-blown rotary converter) to produce crude copper containing precious metals. This "black copper" is fed to the converter.

Blister copper produced in the converter is deoxidised with ammonia in the anode furnace followed by anode casting and finally electro-refined.<sup>44</sup>

#### Lead production

Boliden Rönnskär uses a TBRC Kaldo furnace (top-blown rotary converter) for processing lead concentrates. Besides lead concentrates, the Kaldo furnace is also used for melting electronic waste to black copper. The furnace is housed in an enclosure to contain secondary emissions; ventilation gases are treated in a bag filter. Process gases from the Kaldo furnace are treated either in a liquid SO<sub>2</sub> plant (equipped with a selenium filter for mercury reduction) or a double contact/double absorption acid plants (equipped with a DOWA filter for mercury reduction).<sup>45 46</sup>

#### Zinc production

---

<sup>42</sup> Boliden Rönnskär Website, <https://www.boliden.com/operations/smelters/boliden-ronnskar/>

<sup>43</sup> Boliden Rönnskär Website, <https://www.boliden.com/operations/smelters/boliden-ronnskar/>

<sup>44</sup> Gas treatment at sulphuric acid plant, Rönnskär; presentation by M. Borell, Boliden, 2014

<sup>45</sup> Gas treatment at sulphuric acid plant, Rönnskär; presentation by M. Borell, Boliden, 2014

<sup>46</sup> EU NFM BREF, 2014 (p. 322)

Slag from the Electric Smelting Furnace enters a Fuming Furnace producing the input to the zinc clinker plant. No specific mercury reduction system is installed.<sup>47</sup>

### **Mercury control techniques**

For mercury removal, Boliden Rönnskär uses dust cleaning techniques in combination with different specific mercury reduction techniques. For dust cleaning, electrostatic precipitators, bag filters and scrubbers are used; specific mercury reduction techniques applied are Boliden Norzink, DOWA Filter and Selenium Filter and injection of lime and activated carbon in combination with bag filters.

### **Environmental performance and operational data**

Emission performance data is based on about 100 mercury measurements per year. Sampling time is between 1-14 days. Three methods are used:

- 1) Standard periodic sampling method (European Standard EN 13211)
- 2) Boliden periodic sampling method
- 3) Semtech 2000 on-line monitoring method

The Boliden method uses robust equipment, and the liquid is not as sensitive to cold weather conditions as when using EN 13211. It separates the sample into three fractions according to the mercury species and makes it possible to study the importance of different types of mercury:

- Filter: Mercury adsorbed on particulate matter
- H<sub>2</sub>SO<sub>4</sub>: Mercury ions (oxidized mercury as vapour)
- Iodized activated coal: elemental mercury

Semtech 2000 is an optical on-line measurement method (254 nm, UV). Boliden Rönnskär uses it only as an indicative measurement. It samples and measures elemental mercury. Ionic mercury (ion droplets) is not sampled (has to be converted into elemental mercury). The equipment does not sample mercury adsorbed on particulate matter.

### **Emissions from Flash Furnace (primary copper processing)**

Process gases of the flash furnace (30 000 Nm<sup>3</sup>/h) are first cleaned from dust in an electrostatic precipitator (ESP) and a scrubber. Subsequently, off-gas passes to a Boliden Norzink mercury control before entering the double contact/double absorption acid plants. Mercury content of raw gas before the Boliden Norzink control varies from 42-1008 µg/Nm<sup>3</sup> (periodic measurement). Accordingly, emission levels vary between 12-48 µg/Nm<sup>3</sup>, resulting in 71-95% mercury reduction.

### **Emissions from Fluidized Bed Roaster (primary copper processing)**

Process gases of the fluid bed roaster (80 000 Nm<sup>3</sup>/h) are first cleaned from dust in an electrostatic precipitator (ESP) and a bag filter. Bag filter dust containing As and Hg is sent to storage in a closed system.

In a mixing tower, off-gas from the fluid bed roaster, the electric smelting furnace and the converter aisle are combined. The emissions from the mixing tower are either directed to the double contact/double absorption acid plants, equipped with a DOWA filter for mercury reduction) or to the liquid SO<sub>2</sub> plant, equipped with a selenium

---

<sup>47</sup> Gas treatment at sulphuric acid plant, Rönnskär; presentation by M. Borell, Boliden, 2014

filter for mercury control (performance levels are described below in the section on TBRC Kaldo furnace for primary lead).

#### **Emissions from Electric Furnace and Converter (primary and secondary copper processing)**

Process gas of the electric furnace is first cleaned in an electrostatic precipitator before being directed to a mixing tower. Process gas of the converter is first cleaned in an electrostatic precipitator. Subsequently it passes a quencher and a cooler before being directed to the mixing tower.

In the mixing tower, off-gas from the fluid bed roaster, the electric smelting furnace and the PS converter aisle are combined in a mixing tower. The emissions from the mixing tower are either directed to the double contact/double absorption acid plants, equipped with a DOWA filter for mercury reduction) or to the liquid SO<sub>2</sub> plant, equipped with a selenium filter for mercury control (performance levels are described below in the section on TBRC Kaldo furnace for primary lead).

#### **Emissions from TBRC Kaldo furnace (primary lead smelting)**

Ventilation gases of the Kaldo furnace enclosure (44 000 Nm<sup>3</sup>/h) are cleaned in a bag filter achieving dust emission levels in off-gas < 5 mg/Nm<sup>3</sup> (continuous measurement).

Process gases of the Kaldo furnace are first cleaned from dust in a wet electrostatic precipitator (ESP) and passed to a liquid SO<sub>2</sub> plant, equipped with a selenium filter for mercury control. Mercury content of raw gas before the selenium filter (80 000 Nm<sup>3</sup>/h) varies from 42-1008 µg/Nm<sup>3</sup> (periodic measurement). Accordingly, emission levels vary between 12-48 µg/Nm<sup>3</sup>, resulting in 71-95% mercury reduction.

Process gases from TBRC Kaldo furnace can alternatively be directed to a dust cleaning with a wet ESP and the double contact/double absorption acid plants equipped with a DOWA filter for mercury control. Mercury content of raw gas before the DOWA filter (170 000 Nm<sup>3</sup>/h) varies from 10,5-50 µg/Nm<sup>3</sup>. Accordingly, emission levels in off-gas vary between 1,2-1,4 µg/Nm<sup>3</sup>, resulting in 88-97% mercury reduction.

#### **Emissions from TBRC Kaldo furnace (electronic scrap processing)**

Ventilation gases of the Kaldo furnace enclosure (44 000 Nm<sup>3</sup>/h) are cleaned in a bag filter achieving dust emission levels in off-gas < 5 mg/Nm<sup>3</sup> (continuous measurement).

Equivalent gas treatment equipment was installed in a new electronic scrap furnace (the E-scrap Kaldo plant built in 2012). Process gases pass a mercury control with activated carbon and lime injection followed by a bag filter. Oxidized mercury is adsorbed on the surface of the activated carbon and elemental mercury reacts with SO<sub>2</sub> and O<sub>2</sub> forming solid HgSO<sub>4</sub>. Mercury content before entering the bag filter varies from 37,2-1206 µg/Nm<sup>3</sup> (periodic measurement). Accordingly, emission levels vary between 2,7-32 µg/Nm<sup>3</sup>, resulting in 93-97% mercury reduction.

#### **Summary of emissions from Boliden Rönnskär (copper and lead processing)**

The following table presents performance data of each mercury control technique. For each technique, maxima and minima are provided for input and output of the control technique, as well as resulting efficiency.

Table: Overview on performance of mercury reduction techniques of Boliden Rönnskär/Sweden

Mercury control technique	Material input	Flow [Nm <sup>3</sup> ]	Load	Inlet [µg/Nm <sup>3</sup> ]	Outlet [µg/Nm <sup>3</sup> ]	Efficiency [%]
Boliden Norzink	Primary	30 000	Maximum	9879	30	99,7
			Minimum	51	13	74
DOWA Filter	Primary	170 000	Maximum	50	1,4	97
			Minimum	10,5	1,2	88
Selenium Filter	Primary	80 000	Maximum	1008	48	95
			Minimum	42	12	71
Activated carbon injection	Secondary	80 000	Maximum	1206	32	97
			Minimum	37,2	2,7	93

Source: Best available techniques (BAT) reference document for the non-ferrous metals industries European Commission, Joint Research Centre, Seville, 2014

### Cross-media effects

Dust cleaning before specific mercury controls leads to cross-media effects, as mercury from off gas is passed to filter dust and to scrubber waste water.

Filter dust containing mercury is sent to storage in a closed system.

Scrubber waste water is treated on-site. Resulting sulfide sludge containing mercury is returned as an input of the Fluidized Bed Roaster. The remaining waste water effluent is emitted to the environment with emission values of 130-200 ng/L.

The sulfuric acid produced after the Boliden Norzink and the DOWA filter has a mercury content of < 0,04 ppm. The mercury content of the liquid SO<sub>2</sub> produced after the selenium filter is 0.02 ppm.

The following picture presents mass balance data of mercury including emissions to air, water and contained in waste. Mercury in sulfuric acid is not considered.

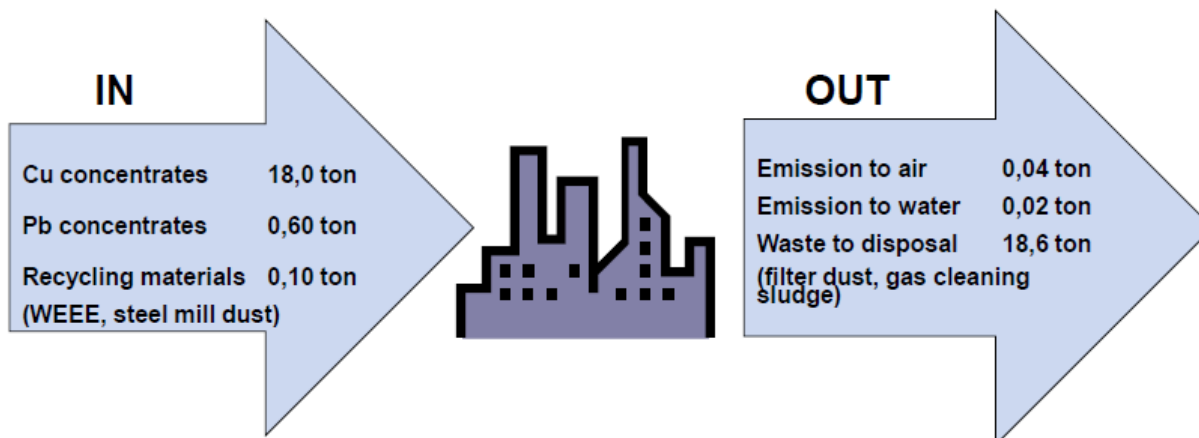

### Reference

Best available techniques (BAT) reference document for the non-ferrous metals industries European Commission, Joint Research Centre, Seville, 2014.

DRAFT

## 5. Mercury Air Emission Sources and Controls - PT. Smelting - Gresik Smelter & Refinery

### General

Location: Gresik, East Java, Indonesia

Ownership: PT. Freeport Indonesia (25%), Mitsubishi Materials Corp. (60.5%), Mitsubishi Corp. RtM (9.5%) and Jx Holdings (5%)

Commenced operation: May, 1999

Process: Mitsubishi Continuous Smelting & Converting Process

Output: 300,000 tonnes/year

The smelting process at Gresik involves:

- drying ore concentrates;
- smelting of ore concentrates to produce matte;
- converting matte to produce blister copper; and
- fire refining the blister copper in an anode furnace.

A sulfuric acid production facility is also operated on-site, capturing sulfur dioxide (SO<sub>2</sub>) and other gases from the smelting process, and producing a concentrated sulfuric acid that is sent to an adjacent fertilizer facility via pipeline. After fire refining, the 99.5 percent pure copper is cast into "anodes" and sent to an electrolytic refinery for further impurity removal. Finally, copper cathode with 99.99 percent pure copper is produced from electrolytic refining.

Figure 1 is a schematic showing general process flows. The operation has two regulated air emission stacks, one from the smelter and a second from the acid plant. The facility routinely monitors and reports on mercury concentrations in air emissions; all results to date have been below detection (non-detect).

### Drying (not a potential Hg source)

Gresik smelter utilizes a rotary dryer to dry the concentrate. Temperatures in the dryer are not high enough to vaporize any mercury in the ore concentrate, and as such are not considered a potential emission source. Particulates from the dryer are controlled using both a cyclone and complex baghouse configurations, with captured particulates being fed into the smelting furnace.

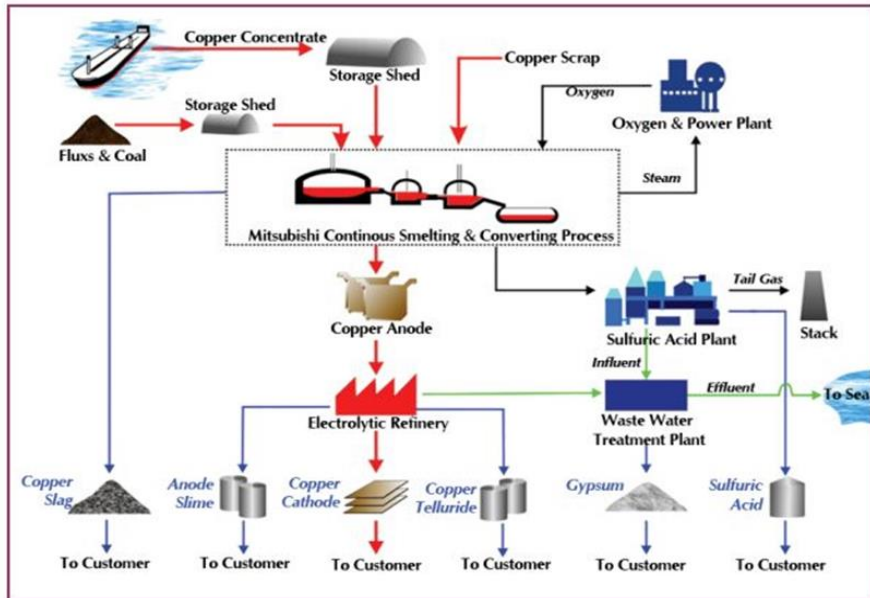

### Mitsubishi Process

In the Mitsubishi Process, feedstock materials are continuously fed to a series of enclosed furnaces. The furnaces are stationary, tightly sealed, and interconnected by enclosed launders. Small ventilation hoods placed above the furnace inlets and outlets capture all fugitive emissions.

#### 1. Smelting (a potential Hg source)

The smelting produces a copper matte by melting the hot ore concentrates with siliceous flux in a furnace (S-Furnace). The mattes produced by domestic smelters range from 35 to 65 percent copper. Smelting furnace technologies operate at temperatures well above the boiling point of mercury with operating ranges as high as 1200°C.

#### 2. Slag Separation (copper slag) at CL-furnace

Mixtures of matte and slag from smelting furnace are transferred through an enclosed launder to the electric furnace (CL-furnace) to be separated by differences in specific gravity. Matte is continuously siphoned out to a converting furnace and the slag, referred to as CL-slag (copper slag), is overflowed from the furnace for water granulation. Granulated CL-slag is one of the salable by-products from the copper smelter.

#### 3. Converting (potential Hg source)

The final step in the production of molten "blister" copper is converting. Converting eliminates remaining iron and sulfur impurities, leaving 65 to 98.5 percent pure copper (blister copper). Converting involves molten matte, limestone flux and scrap copper being charged to a furnace (C-Furnace), where oxygen enriched air is blown from the top of the molten matte.

Blister copper is continuously siphoned out to the anode furnace via an enclosed launder. The molten converting slag formed in the converting furnace (C-furnace), is then water granulated, dried, and re-cycled to the S-furnace. Converting reactions are exothermic, therefore spent anode from the electrolytic refinery is utilized as a coolant to control the bath temperature. Off gas from the C-furnace is also delivered to the Sulfuric Acid Plant through a waste heat boiler and an electrostatic precipitator for cooling and de-dusting.



#### **4. Anode Furnace (not a potential Hg source)**

Blister copper contains approximately 1.5% sulfur. This characteristic influences the electro-refining process due to the copper anode degrading to low purity and density. This blister copper is purified in the Anode Furnace in two stages, oxidation and reduction. Copper scrap of high copper grade is also treated in the Anode Furnace, then melted together with blister copper from the C-furnace.

In the oxidation stage, oxygen-enriched air is injected to oxidize the remaining sulfur to SO<sub>2</sub> gas, and in the reduction stage, the excessive oxygen is reduced using natural gas or MDF.

The molten metal (around 99.4 % Cu) is cast as copper anode using a continuous casting machine and then delivered to the electro-refining process. The off gas from the anode furnace during the oxidation stage, is sent to the Acid Plant, while off gas from reduction is returned to the concentrate dryer, and finally discharged through the stack.

The gas stream to the sulfuric acid plant passes through a range of control devices, including at the Smelter:

- Waste Heat Boiler
- Electrostatic Precipitator (ESP)

and at the Acid Plant:

- Washing tower
- Venturi Scrubber
- Gas Cooler
- Wet Electrostatic precipitator or Mist Precipitator.

These control devices remove metal impurities to prevent destruction of the catalyst in the acid plant. Any mercury volatilizing in the smelting furnace is captured and removed either in these multistage control systems or in the sulfuric acid plant.

Following treatment, the smelter stack has an air discharge that is continuously monitored for SO<sub>2</sub>, temperature and flow rate. Quarterly chemical analyses show no detectable mercury over the 13 years period of monitoring (DL = 0.008 mg/Nm<sup>3</sup>).

As the system is entirely enclosed, any mercury contained in the concentrate will be volatilized during the Mitsubishi Smelting process step, captured and directed toward the sulfuric acid plant.

#### **Sulfuric Acid Plant (potential Hg source)**

Data on sulfuric acid plant sludge show that the mercury is present in measurable concentrations. This sludge (containing mercury) is recycled back to the smelting and converter furnaces and vaporized again into the control system. This sets up an internal recycling loop for the mercury.

Acid plant off-gas passes through a scrubbing unit, and the final solution generated from gas absorbing process at the scrubbing unit is recycled to the acid production process in an absorption process, and finally discharged through the stack.

The stack is continuously monitored for SO<sub>2</sub>, temperature and flow rate. Quarterly monitoring data for the last 13 years show no detectable mercury (DL = 0.008 mg/Nm<sup>3</sup>).