



UNITED
NATIONS

EP

UNEP(DEPI)/ MED WG.417/17



UNITED NATIONS
ENVIRONMENT PROGRAMME
MEDITERRANEAN ACTION PLAN

30 July 2015
Original: English

MED POL Focal Points Meeting
Malta, 16-19 June 2015

Joint Session MED POL and REMPEC Focal Points Meetings
Malta, 17 June 2015

Report of the meeting

For environmental and economic reasons, this document is printed in a limited number. Delegates are kindly requested to bring their copies to meetings and not to request additional copies.

UNEP/MAP
Athens, 2015

Table of contents

Report of the meeting

Annex I List of participants

Annex II Agenda of the meeting

Annex III Conclusions and recommendations

Appendix 1 Recommendations of the informal online working groups

Appendix 2 Main elements of the Integrated Monitoring and Assessment Programme

Appendix 3 Guide on Fishing for Litter best practices

Appendix 4 Guidelines on best environmental practices for the management of mercury contaminated sites

Appendix 5 Guidelines for environmentally sound management of used lead batteries

Annex IV Guide for environmental sound management of PCBs

Annex V NAP update Guidelines

Report of the meeting

Introduction

1. The meeting of the MED POL Focal Points was held on 17-19 June 2015 at Corinthia Hotel, Attard, Malta, with a pre-session on marine litter on 16 June 2015. A joint session with REMPEC Focal Points was held on 17 June 2015 and was dedicated to the draft Offshore Protocol Action Plan and the main elements of the Integrated Monitoring and Assessment Programme for Ecological Objectives 5 (eutrophication), 9 (contaminants) and 10 (marine litter).
2. The main objectives of the meeting were to review the progress in the implementation of the current MED POL programme of work (PoW) for the biennium 2014 – 2015 including some of the key reports and technical guidelines produced. The meeting also reviewed and provided feedback on the pollution prevention and control component of the UNEP/MAP Mid Term Strategy (MTS) and related MED POL PoW for the 2016 – 2017 biennium.

Participation

3. The following Contracting Parties attended the meeting: Albania, Bosnia and Herzegovina, Croatia, Cyprus, Egypt, European Union, France, Greece, Israel, Italy, Lebanon, Libya, Monaco, Montenegro, Morocco, Slovenia, Spain, Tunisia and Turkey. Representative of Palestine participated as an observer. The meeting was furthermore attended by the representatives of International Atomic Energy Agency (IAEA), Basel Convention Regional Centre from Bratislava, Agreement on the Conservation of Cetaceans in the Black Sea Mediterranean Sea and Contiguous Atlantic Area (ACCOBAMS), European Environment Agency (EEA), Environment Agency Austria, Hellenic Centre for Marine Research (HCMR) and University of Piemonte/ DISIT. UNEP/ MAP and several Regional Activity Centres were attending, including Plan Blue (PB/RAC), Regional Marine Pollution Emergency Response Centre (REMPEC), Sustainable Consumption and Production centre (SCP/RAC), and Information and Communication centre (INFO/RAC). The full list of participants is included in Annex I of the present report.

Pre-session on marine litter

4. The pre-session on marine litter was conducted with the aim to enable preliminary expert discussion on the Updated MED POL Marine Litter Assessment Report and on the Guide on best practices for Fishing for Litter in the Mediterranean (documents UNEP(DEPI)/MED WG.417/13 and UNEP(DEPI)/MED WG.417/14).
5. The presentation of the Marine Litter Assessment Report (UNEP(DEPI)/MED WG.417/14) highlighted the situation in the Mediterranean, including the sources, main impacts and the most substantial reduction measures, as well as some recommendations for the implementation of Marine Litter Regional Plan including a proposal to establish a coordination mechanism with the relevant regional partner organizations under UNEP/MAP leadership. The Secretariat explained the rationale for the update of the 2010 marine litter assessment based on Article 11 of the Marine litter Regional Plan according to which an assessment report should be prepared by the Secretariat 2 years after its entry into force and based on existing information. The focal points were invited to comment on all the elements of the report including appropriateness and relevance of data sources used. The meeting acknowledged the comprehensiveness and quality of the report.

6. Presentation of the Fishing for Litter guide (UNEP(DEPI)/MED WG.417/13) was followed by several comments made by the focal points for consideration during the formal meeting session of the MED POL FP meeting.
7. The main comments and suggestions included the following: the need to add a definition of Fishing for Litter concept; recommend the passive rather the active approach to implementing the scheme; strengthen the health and safety section; and add a chapter on the key successful projects; The focal points also requested to Secretariat to supplement the guide with information on costs of implementing Fishing for Litter schemes.

Agenda item 1. Opening of the meeting

8. Mr. Habib N. El Habr, UNEP/ MAP Deputy Coordinator, opened the meeting making a reference to the 40th anniversary of MAP and MED POL and emphasising high relevance of the MED POL's work in the past as well as today. The importance of continued contracting party commitments to pollution prevention and control was also emphasised. Pointing out that the meeting agenda was comprehensive and demanding, he assessed that the work completed during the past one and a half years provided a solid ground for a productive and successful meeting. Review of the proposed Integrated Monitoring and Assessment Programme for pollution related EcAp ecological objectives was singled out as one of the most important tasks, accompanied with the analysis of the work of the online expert groups on pollution and litter cluster. A considerable number of technical guidance documents for the key NAP/ SAP-MED sectors were delivered for final review and validation from the MDPOL FP. NAP update process was another important agenda item, including discussion of steps to be undertaken until COP 19. Finally and importantly, the meeting was meant to review and provide feedback on the proposed Mid-Term Strategy (MTS) and 2016-2017 programme of work for the pollution component of UNEP/ MAP.

Agenda item 2. Election of officers

9. In accordance with Rules of procedure for meetings and conferences of the Contracting Parties, the meeting elected a chair person, three vice-chair persons and one rapporteur as follows:

Chair: Mr. Ilias Mavroeidis (Greece)

Vice-Chair: Ms. Ghada Ahmed (Egypt)

Vice-Chair: Mr. Samir Kaabi (Tunisia)

Vice-Chair: Ms. Eda Bayar (Turkey)

Rapporteur: Ms. Konstantinos Antoniadis (Cyprus)

Agenda item 3. Adoption of the Agenda and organization of work

10. The provisional agenda contained in the document UNEP(DEPI)/MED WG.417/2 was adopted as presented in Annex II to the present report. The meeting agreed to include presentation of ACCOBAMS on Ecological Objective 11 on underwater noise, as well as UNEP/ MAP briefing on the outcomes of the 6th meeting of the H2020 Review and Monitoring Subgroup and presentation on the new GEF project proposal under *Any other business* agenda item and/or as appropriate, depending on availability of time.

11. It was agreed that the meeting would be held in plenary with English and French simultaneous interpretation.

Agenda item 4. Progress achieved regarding the implementation of the Programme of Work 2014-2015 including the status of the implementation of the technical aspects of the Land Based Sources (LBS), Dumping and Hazardous Waste Protocols (HW), Regional Plans (RP) adopted in 2009, 2012 and 2013 as well as marine pollution monitoring programmes

12. The Secretariat presented UNEP(DEPI)/MED WG. 417/3 on the implementation of the PoW for the biennium 2014 – 2015, focusing on the key achievements as well as challenges faced and lessons learned. A set of technical guidelines was completed during the biennium (on a range of topics including NAP update, mercury, PCBs, lead batteries, tannery and lube oils), important assessment conducted and/ or contributed to, and various trainings and meetings held on regional as well as on the national level. Efforts were also made to mobilise additional funding to support implementation of the PoW and achieve synergies with complementary policy frameworks, in particular with H2020 where UNEP/MAP acted as a co-chair of two sub-groups of H2020. Regarding the actions on the ground, safe disposal of PCBs in three countries was highlighted as an important contribution to achieving the SAP MED and the NAPs as well as the relevant global target under the Stockholm Convention.
13. The meeting acknowledged extensive and highly relevant work and the results achieved, and expressed appreciation for the Secretariat's efforts. A specific comment was raised regarding precision of information presented in Annex III of the progress report, suggesting that some reports actually sent by countries were not recorded. The Secretariat asked the countries to review the Annex III and communicate any mistakes or omissions spotted.
14. Related to the work on strengthening quality assurance procedures for monitoring of contaminants, the representative of the International Atomic Energy Agency (IAEA) presented the results of two Proficiency Tests (PTs) organised in 2014. He noted that a significant number of laboratories did not send results for the PTs, although PT samples were sent to them in time following their nomination by the respective MED POL FPs. Furthermore, the results provided by a considerable number of participating laboratories didn't meet the quality requirements for the PT and were rated as "unacceptable". The IAEA representative also presented the lessons learned from the two Training Courses organised in 2014 in Monaco on the analysis of trace elements and organic contaminants. The courses were highly appreciated, however the analytical experience of the trainees was not at the same level and some trainees were not involved in the marine pollution monitoring programme of their respective countries.
15. The meeting called upon MED POL FPs to nominate appropriate candidates for the Training Courses and to encourage nominated laboratories to participate in the upcoming Proficiency Tests. The meeting also requested the Secretariat to send the laboratory results of the Proficiency Test to the respective MED POL FPs for information and action, as appropriate.

Agenda item 7 (b). Proposed environmental targets, assessment criteria and thresholds for the pollution and litter cluster of the Mediterranean EcAp-based ecological objectives (EO 5, 9 and 10)

16. Results of the work of informal working groups on ecological objectives 5, 9 and 10, as laid down in the UNEP(DEPI)/MED WG. 417/7, were presented by the chairs/ co-chairs of the respective groups – Ms Popi Pagou (Greece) for eutrophication, Ms Nevenka Bihari (Croatia) for contaminants and Mr Francois Galgani (France) for marine litter. The background report prepared by the groups was made available to the meeting as UNEP(DEPI)/MED WG.417/Inf.15. Recommendations of the informal groups were previously discussed at the last meeting of the EcAp Correspondence Group on Monitoring (CorrMon), which agreed with most of them, while as some recommendations were referred to the MED POL FP meeting for their further consideration.

17. The following specific observations and recommendations were made by the meeting:

The current work was commended and importance of its continuation emphasized, especially as regards further development of common assessment methods at the regional or sub-regional level.

The need to point out that TRIX was not a mandatory assessment method was stressed; the countries can continue using the methods applied up to now.

It was suggested to insert a clarification that all methods and criteria presented in the documents in relation to typology and chl-a reference and threshold values apply only to coastal areas.

It was also suggested to include the list of the non-mandatory eutrophication assessment methods proposed to be used by the countries (including the OSPAR method) in the report's recommendations.

It was requested to add an explanation to UNEP(DEPI)/MED WG.417/Inf.15 to clarify that the included chl-a reference and threshold values related to specific Spanish Mediterranean water types were not common with other EU countries and were presented as an additional information.

With regard to contaminants, different views were expressed whether monitoring of both proposed biomarkers LMS and AChE should be mandatory (in fish and/ or mussels). However the meeting did not support the recommendation on compulsory monitoring of AChE. Importance of ensuring monitoring data quality assurance and control was re-emphasized and deemed necessary. The findings and work of the online group on contaminants were supported in general terms. The meeting did not agree on the proposed change in definition of CI 12 (*Level of pollution effects of environmental contaminants on biological responses where a cause and effect can be explained*).

18. With regards to marine litter, the meeting had the following specific proposals:

- Monitoring should adapt the whole Master list including the most frequent items to produce a shorter list, more useful and practical for the field work.
- Values for the proposed baselines were agreed upon but a more precise calendar for their future adjustment was requested based on the new data to be delivered following the implementation of relevant monitoring programmes.
- A deadline for beach litter reduction of 20% by 2024 received more support than by 2030.

19. Wrapping up the discussion on the agenda item 7 (b), the meeting agreed for the presented documents to be revised in line with provided suggestions and then submitted to EcAp coordination group meeting in September 2015 for further consideration in the process of preparing for the COP 19. The final version of the recommendations of online groups, as agreed by the meeting, are presented in appendix 1 of Annex III to the present report.

Agenda items 5 and 6. Proposed monitoring programme for the pollution and litter cluster of the Mediterranean EcAp-based ecological objectives (EO 5, 9 and 10) and General review of the draft Action Plan to implement the Offshore Protocol of the Barcelona Convention

20. In a joint session with REMPEC FPs, the Secretariat presented document UNEP(DEPI)/MED WG.417/6 containing proposed indicators for ecological objectives 5 (two indicators), 9 (5 indicators) and 10 (3 indicators).
21. Regarding eutrophication indicators, the meeting pointed out that frequency of monitoring needed to be adjusted for specific areas. As for the CI 11 (concentrations of key contaminants) the meeting discussed appropriate frequency of sampling in relation to the rate of sedimentation. Use of a 4-6 year range was recommended, to be decided by individual countries. Regarding CI 12 the meeting noted that for the determination of biomarkers, fish sampling was not as convenient as mussel sampling. The agreement was that the countries could decide to use either molluscs or fish, or both; LMS was confirmed as the only mandatory biomarker. In relation to CI 13, the meeting discussed the appropriate threshold for reporting on the oil spills: 100 m³ was not deemed appropriate and a reference was made to MARPOL threshold of 50 m³. The meeting concluded that spills of 50 m³ should be reported, whereas countries could also opt to report on spillages of lower amounts. For CI 16 on the amounts of marine litter on shore, the meeting suggested that the lower limit for marine litter items should be corrected from 2.5 to 0.5 cm (in line with recommendations of the online group). Another recommendation of the meeting was to ensure compatibility of the Master list for the Mediterranean with the EU list. The target of 20% reduction by 2024 or 2030 was assessed as appropriate (CI 16); the choice between the two proposed deadlines is to be made at the MAP FPs meeting in October 2015).
22. REMPEC presented Draft Offshore Protocol Action Plan (UNEP(DEPI)/MED WG.417/5), focusing on the preparation process and providing general information on the comments received. The meeting asked REMPEC to integrate the received comments and circulate revised version of the Action Plan to the Offshore Working Group prior to submission to the MAP FPs meeting in October 2015.
23. The discussion included topics such as new measures implemented in some countries towards Protocol's ratification and implementation, willingness to cooperate on the Action Plan's implementation (in particular as regards impacts of underwater noise and accidents), the need to better address liability and compensation issues in the final version of the document, and similar.
24. Following a wrap up of the joint session with REMPEC FPs, the meeting of MED POL FPs reconvened to finalise discussion on marine litter indicators.
25. ACCOBAMS presented Strategy for underwater noise monitoring in the Mediterranean (UNEP(DEPI)/MED WG.417 Inf./22) and proposed it for discussion at the next EcAp meetings together with the main elements of the integrated monitoring programme.

26. The final version of the Main Elements of the Integrated Monitoring and Assessment Programme is presented in appendix 2 of Annex III to this report.

Agenda item 7(d). Updated Marine litter assessment report

27. Following the initial presentation of the document UNEP(DEPI)/MED WG.417/14 during the marine litter pre-session on 16 June 2015, the meeting was invited to continue the review of the draft updated Marine Litter Assessment Report focusing on recommendations and on the proposal for establishment of marine litter coordination group for the Mediterranean. The meeting welcomed the report and approved proposal for creation of a coordination group under the leadership of UNEP MAP and with participation of key experts and stakeholders (GFCM, ACCOBAMS, private sector, UNEP/MAP RACs, NGO's, IGOs, etc.). The assessment was carried out in line with Article 11 of the Regional Plan on Marine Litter.
28. The MED FPs were invited to propose amendments and corrections to the presented draft before July 10 2015 (the same applies to marine litter section of the document UNEP(DEPI)/MED WG.417/7) for finalisation by the end of July and further consideration at the next MAP FPs meeting and the COP. The structure and proposed Terms of Reference for the marine litter coordination group were also open for comments and proposals until 10 July. Revised proposal will serve as a basis for a draft decision to be submitted to the COP.
29. In a side event to the meeting, the **Adaptive Marine Policy (AMP) Toolbox** developed under PERSEUS project was presented. The toolbox is meant to serve as one-stop repository of principles, methods and resources to elaborate marine policies in a cyclical process based on best available scientific information and knowledge and stakeholders' participation. Options offered by the toolbox (primarily targeting policy makers) were illustrated on the example of marine litter.

Agenda item 7 (a). Proposed updated list of priority contaminants in the Mediterranean

30. The Secretariat presented chapter 1 of the document UNEP(DEPI)/ MED WG.417/4 on the updated list of contaminants and explained the rationale behind the conducted analysis. The LBS Protocol and SAP-MED lists of contaminants were reviewed and compared with requirements/ lists of the relevant UN Conventions, OSPAR, HELCOM, EU WFD, MSFD, REACH as well as with available research results in an attempt to compile a more pertinent and up to date list of priority contaminants in the Mediterranean for further policy actions and monitoring.
31. The meeting concluded that substances identified in almost all of the reviewed lists – referred to as the Group 1 substances in the UNEP(DEPI)/ MED WG.417/4 – merited strong attention and further actions by the CPs in the framework of the LBS Protocol implementation. For the other two groups (substances necessitating additional scientific information and those included in the WFD priority list of substances) the meeting concluded it was too early to require their inclusion in the monitoring programmes and recommended additional analyses to be carried out. The Secretariat was requested to follow relevant developments in the region and to provide periodical updates and feedback to the FPs.

Agenda item 7(c). Guide on Fishing for Litter best practices

32. Revisions to the document UNEP(DEPI)/MED WG.417/13 made in line with suggestions tabled by the meeting during the pre-session on marine litter were presented. Both the work on integration of comments and the guide itself were commended, whereas the document was assessed as thorough, practical and simple. It was agreed that an effort will be made to amend the document with information on economic background of implementing the scheme for the next meeting of MAP FPs. The Guideline was developed in line with Article 10 of the Regional Plan on Marine Litter. The final version of the Guide, as agreed by the meeting, is presented in appendix 3 of Annex III to the present report.
33. The meeting noted and expressed appreciation of the overall good progress with marine litter management in the Mediterranean. The Secretariat expressed intention to support pilot Fishing for Litter projects in some countries conditional to availability of resources.

Agenda item 7(e). Mercury decontamination best practices and guidelines

34. The SCP/ RAC representative presented the document UNEP(DEPI)/MED WG. 417/8 titled Guidelines on best environmental practices for the management of mercury contaminated sites. The meeting assessed the document was extremely useful and already used in practice. Opportunities provided to the countries to contribute to the preparation of Guidelines were also highlighted as a very positive experience.
35. Suggestions for amending the Guidelines included provision of information on how long should the monitoring of mercury at landfill sites be conducted as well as on description of procedures (packaging, safety measures, etc.) for transporting wastes contaminated with mercury to the disposal sites.
36. The meeting approved submission of the Guidelines as slightly amended and presented in appendix 4 of Annex III to the present report to the MAP FP meeting and to the COP.

Agenda item 7(f). Guide for Environmental Sound Management (ESM) of Polychlorinated Biphenyls (PCB) in the Mediterranean

37. The Secretariat presented the document Guide for Environmental Sound Management (ESM) of PCBs in the Mediterranean (UNEP(DEPI)/MED WG. 417/9). The Guide addresses the needs related to different categories of PCBs and aims to provide practical advice to competent authorities in the Mediterranean countries to comply with the Stockholm Convention commitments. The document was welcomed and endorsed by the meeting. Its submission to the COP was not deemed necessary whereas the meeting recommended publication in the MAP Technical series and invited the countries to use it. The final version of the guide is contained in Annex IV to this report

Agenda item 7(g). Guidelines for environmentally sound management of used lead batteries in the Mediterranean

38. The representative of the Basel Convention Regional Centre presented the Guidelines for environmentally sound management of used lead batteries in the Mediterranean (UNEP(DEPI)/MED WG. 417/12). The meeting expressed appreciation for the work done and for usefulness of the guidelines and urged the Secretariat to provide further support to their implementation.

39. The meeting asked the Secretariat to consider reformulation of the recommendation (included in the reviewed version of the Guidelines) on landfilling of used batteries to suggest future banning of such an option and its use only as the last resort i.e. when there are no other options for final disposal of used lead batteries.
40. The amended document (including a modified formulation on landfilling) was endorsed by the meeting and its publication in the MAP Technical series recommended, whereas the countries were encouraged to implement them. The final version of the Guidelines is presented in appendix 5 of Annex III to the present report.

Agenda items 7(h). Lube oil ESM Guidelines based on Sustainable Consumption and Production (SCP), Best Available Technology (BAT) and Best Environmental Practice (BEP)

41. The SCP/ RAC representative presented the Guide for the environmentally sound management of used lube oils in the Mediterranean (UNEP(DEPI)/MED WG.417/10).
42. The meeting expressed overall satisfaction with the existing version of the document while pointing out that an allowance should be made for positive national experiences and good practices to be reflected in the final version of the document. The countries were invited to provide relevant information/ case studies as well as comments on the draft Guide in the run up to the regional expert meeting that will be organized in a month's time for detailed review of both the Lube oil ESM guidelines and the document on best practices for a sustainable tannery sector in the Mediterranean (the latter to be discussed under the next agenda item).
43. The Secretariat also asked the countries to complete and return disseminated questionnaires on used lube oil management to allow compilation of "Country Used Oil Factsheets" as planned. These would be used to tailor further technical assistance and support based on specific situation, needs and priorities in different countries.

Agenda items 7(i). Guide towards a more sustainable tannery sector in the Mediterranean

44. The SCP/ RAC representative presented the Guide towards a more sustainable tannery sector in the Mediterranean (UNEP(DEPI)/MED WG.417/11). An additional explanation was provided that the guide in a sense represented an extension of BAT and BEP approaches to introduce Sustainable Consumption and Production tools in the recommended management of the tanneries sector. Detailed review of this document is also planned for the next month's regional expert meeting.
45. The meeting emphasized that national experiences with implementation of projects to improve environmental performance of tanneries should be included in the document. The initiative on developing the guide was welcomed and encouraged.

Agenda item 7 (j). National Action Plan (NAP) update roadmap until COP 19 and implementation of respective guidelines

46. The Secretariat presented the UNEP(DEPI)/ MED WG.417/4 – chapter 2 – on the NAP update roadmap and related Guidelines.

47. As for the proposed deadline for submission of NAPs to the Secretariat (November 2015) majority of countries requested postponement due to different reasons, including alignment with the calendar for finalisation of the EU MSFD Programmes of Measures for the EU countries, and some difficulties faced in other countries. Few countries reported they were on track with the previously agreed timeline, as included in the Roadmap.
48. The Secretariat explained that the fact COP 19 was deferred for February 2016 allowed for some flexibility and asked to receive the NAPs by December 2015 at the latest in order to enable COP's review and endorsement of the documents. To save the time and if proved necessary, the countries were asked to submit NAPs to the Secretariat prior to completion of the national approval process. However, approval of the NAPs on the national level was necessary before the COP. The Secretariat would analyse the NAPs to determine their compliance with the LBS Protocol and EcAp requirements.
49. The meeting formally approved NAP update Guidelines (as contained in the document UNEP(DEPI)/ MED WG.417/Inf.6) and contained as Annex V to this report.
50. In a side event to the meeting, NBB info system was presented and details of NBB reporting were discussed.

Agenda item 8. Mid-Term Strategy (MTS) 2016-2021 with particular focus on pollution prevention and control as well as the respective assessment and environmental governance aspects

51. The Secretariat presented UNEP/MAP Mid-term Strategy (MTS) 2016 -2012 (UNEP(DEPI)/ MED WG.417/15) and the process that led to the current version of the document – starting from the issues paper to identification of priority strategic themes and revisions/ regrouping of the strategic themes following suggestions received by the MAP FPs. The final draft of the Strategy has to be prepared by mid-August to enable timely dissemination for the next MAP FP meeting scheduled for 13 – 15 October 2015.
52. The meeting agreed to proceed with presentation of the MED POL Programme of Work for the forthcoming biennium and then open for discussion of both documents.

Agenda item 9. MED POL Programme of Work 2016-2017

53. The Secretariat presented MED POL Programme of Work 2016–2017 (UNEP(DEPI)/ MED WG.417/16). The main elements that were elaborated in the document and proposed strategic lines of action for the next biennium include support to the countries with implementations of updated NAPs, strengthening of monitoring programmes and improvements of the information system, further work on the assessment methodologies and criteria, strengthening quality assurance and control, strengthening of partnership with H2020 and further development of synergies, marine litter and others.
54. Substantial part of the discussion was dedicated to indicators proposed under the pollution prevention and control component of the MTS, including relevance and methodology for the proposed indicator on elimination of hot spots, the need to extend the proposed list to include underwater noise indicators, frequency of reporting i.e. time periods at which indicators should be set, inclusion of energy sector, and others.

55. The meeting confirmed relevance of the hot spots indicator while pointing out the need for its modification to show a share of eliminated hot spots (rather than their absolute number) and the need to allow for flexibility in hot spots assessment. A remark was made on the 6-year period being too short for elimination of hot spots. As for the inclusion of indicators on underwater noise, concern was raised by one focal point that the focus should be placed on harmonization of national monitoring programmes to produce more coherent and comparable results, including the need for capacity building; ecological objective on underwater is important, however priority should be given to other ecological objectives in areas where there are more data and where concerns are more clear.
56. The countries were invited to submit proposals on indicators that were tabled during the meeting as well as potential new ones as appropriate to the Secretariat by 26 June 2015 for further consideration and inclusion in final draft of the MTS. The overall idea in developing the MTS was to limit the number of indicators to 5 per each strategic theme.
57. In general terms, the Programme of Work 2016–2017 was evaluated as a good programming effort for the coming biennium. The meeting suggested timeline for the implementation of activities and levels of priority (low, medium or high) to be added to the PoW. It was also suggested to clarify the roles of MAP components (RACs) and to allow for possibility that there might be other RACs capable of contributing to the planned activities.
58. The Secretariat invited the FPs to provide written proposals on the PoW to be sent within the next week. An attempt will be made to accommodate for all of them in the process of finalising the documents together with other UNEP/ MAP colleagues. The FPs requested that the revised PoW will be circulated to MED POL FPs before being sent to MAP FPs.

Agenda item 10. Any other business

59. The Secretariat informed the meeting on the main conclusions of the 6th meeting of the H2020 Review and Monitoring Subgroup, namely on the:
 60. Proposal that national MED POL FPs should participate in the work of the RM Subgroup together with a representative of the national State of the Environment (SoE) reporting team; and
 61. Possible merging of the forthcoming H2020 assessment report and UNEP/ MAP SoE report and preparation of a joint assessment in 2019.
62. The Secretariat presented efforts to develop a new GEF project for the Mediterranean and the steps completed so far (i.e. current version of the concept note), and invited the countries to send inputs by mid-July to help with development of a consolidated project proposal.
63. At the end agenda item 10, the MED POL FPs were reminded that preparations for the 2015 Proficiency Tests and training courses were underway and their timely reaction was sought to ensure successful implementation of these activities.

Agenda item 11. Conclusions and recommendations

64. The participants reviewed draft conclusions and recommendations of the meeting and adopted them after proposing minor revisions. The final version of conclusions and

recommendations is presented as Annex III to the present report, with appendices 1 – 5 containing recommendations of online groups, main elements of the integrated monitoring programme, and guidelines on Fishing for Litter, management of mercury contaminated site and used lead batteries respectively.

65. Agenda item 12. Closure of the meeting

66. The participants expressed strong appreciation for a well-organized and productive meeting. In his closing remarks, the Chair thanked the participants for their contribution and declared the meeting closed at 17:00 hours on Friday, 19 June 2015.

Annex I – List of participants

REPRESENTATIVES OF CONTRACTING PARTIES / REPRESENTANTS DES PARTIES CONTRACTANTES

<p>ALBANIA / ALBANIE</p>	<p>Mr Redi Baduni Director of Environment Protection Directorate Ministry of Environment, Forestry and Water Administration Rruga “Halil Bega”, nr. 23 Tirana Albania</p> <p>Tel: +355 42 2224572 Fax: +355 42 2270627 E-mail: redi.baduni@moe.gov.al</p>
<p>BOSNIA & HERZEGOVINA / BOSNIE & HERZEGOVINE</p>	<p>Mr Nijaz Lukovac Hydro-Engineering Institute Stjepana Tomica 1 71000 Sarajevo Bosnia & Herzegovina</p> <p>Tel: +387 33 212466/7 E-mail: nijaz.lukovac@heis.ba</p>
<p>CROATIA / CROATIE</p>	<p>Ms Barbara Škevin Ivošević Head of the Department Ministry of Environmental and Nature Protection Dept. For Sea and Coastal Protection Uzarska 2/I,51 000 Rijeka</p> <p>Tel : + 385 51 213 499 E-mail: barbara.skevin-ivosevic@mzoip.hr</p> <p>Ms Nevenka Bihari Prof. Dr. SC. Senior Scientist Center for Marine Research “Ruđer Bošković” Institute G. Paliaga 5 Rovinj 5210 Croatia</p> <p>Tel: +385 52 804 715 Mobile: +385 91 764 0586 E-mail: bihari@irb.hr</p>
<p>CYPRUS / CHYPRE</p>	<p>Mr Konstantinos Antoniadis, Officer of Fisheries & Marine Research Marine Environment Division</p>

	<p>Department of Fisheries and Marine Research Ministry of Agriculture, Natural Resources and the Environment 101 Vithleem Street, 1416 Nicosia, Cyprus</p> <p>Tel: +35722807854 Fax:+35722775955 E-mail: kantoniadis@dfmr.moa.gov.cy</p>
EGYPT / ÉGYPTE	<p>Ms Ghada Ahmed Director of Solid & Hazardous Waste Department Egyptian Environmental Affairs Agency, Alexandria Branch Om Zeghio road, Km 21 Alexandria, Egypt</p> <p>Tel: +2033020691 E-mail:ghada_am@yahoo.com</p>
EUROPEAN UNION UNION EUROPEENNE	<p>Ms Lydia Martin-Roumegas Unit C.2 – Marine Environment and Water Industry BU-9 04/176 B-1049 Brussels Belgium</p> <p>Tel : +32 229 53518 E-mail : Lydia.MARTIN-ROUMEGAS@ec.europa.eu</p>
FRANCE / FRANCE	<p>Ms Lea Dalle Gerard Chargée de mission "pollutions telluriques et substances " Bureau des milieux marins, Direction de l'eau et de la biodiversité Ministère de l'écologie, du développement durable et de l'énergie Tour Séquoia 1 Place Carpeaux 92800 Puteaux</p> <p>Tel: + 33 1 40 81 33 82 E-mail: lea.gerard@developpement-durable.gouv.fr</p> <p>M Francois Galgani Responsable de projet IFREMER, Chaiman DG ENV/MSFD/GES TG Marine Litter</p>

	<p>Tel: +33 495380024 Fax: +33 638425290 E-mail: Francois.galgani@ifremer.fr</p>
GREECE / GRECE	<p>Mr Ilias Mavroeidis Senior Scientific Expert Department of International Relations and EU Affairs Hellenic Ministry for the Environment, Energy and Climate Change 15 Amaliados Street Athens 11523 Greece Tel: +30 210 6426531 E-mail: i.mavroidis@prv.ypeka.gr</p> <p>Ms Kalliopi Pagkou Research Director, Coordinator of the IRIS-SES project (DG ENV) Institute of Oceanography Hellenic Center for Marine Research 46.7 km Athinon-Souniou Ave. Mavro Lithari Anavissos 19013 Attica, Greece</p> <p>Tel: +30 22910 76409 Fax: +30 22910 76347 E-mail: popi@ath.hcmr.gr</p>
ISRAEL / ISRAEL	<p>Mr Rani Amir Director Marine and Coastal Environment Division Ministry of environment Protection Pal Yam 15a P,O Box 811 31007 Haifa Israel</p> <p>Tel : +972 48 633500 E-mail : rani@sviva.gov.il</p>
ITALY / ITALIE	<p>Mr Roberto Giangreco Divisione VI Tutela Ecosistemi Marini e Costieri Direzione Generale Protezione della Natura e del Mare Ministero dell' Ambiente, della Protezione della Natura e del Mare Via Cristoforo Colombo 44 00147 Roma Italy</p>

	<p>Tel : +39 0657228406 E-mail : Giangreco.roberto@minambiente.it</p>
LEBANON / LIBAN	<p>Ms Sabine Ghosn Environmental Specialist Department of Protection of Urban Environment Service of Urban Environment Directorate General of Environment Ministry of Environment Lazarieh Building - 7th floor (Room 7-18) P.O. Box 11-2727 Beirut Lebanon</p> <p>Tel: +961-1-976555 Ext: 519 E-mail: s.ghosn@moe.gov.lb</p>
LIBYA / LIBYE	<p>Mr Naser Nassir Bsher Madi M.Sc hydrology and water resources Environmental Engineering at EIA Dep GEF local team MED POL- UNEP/MAP FOCAL POINT Tripoli Jansor Alkeran Libya</p> <p>Tel:+218913900171 E-mail: nassirega@gmail.com</p>
MONACO / MONACO	<p>M. Philippe Antognelli Chef de Section Direction de l'Environnement 3, avenue de Fontvieille 98000 Monaco Monaco</p> <p>Tel: +377 98 98 46 80 Fax: +377 92 05 28 91 E-mail: pantognelli@gouv.mc</p>
MONTENEGRO / MONTENEGRO	<p>Mr Pavle Djuraskovic Head Department for Environmental Protection Hydrometeorological Institute Proleterska 19 81000 Podgorica Montenegro</p> <p>Tel: +382 81 655165 Fax: +382 81 655102 E-mail: pavle.djuraskovic@meteo.co.me</p>

MOROCCO / MAROC	<p>Mr Mohamed Kabriti Cadre charge du Service Eau Division du Laboratoire National des Etudes et de Surveillance de la Pollution Departement de l'Environnement Ministere de l'Energie, des Mines, de l'Eau et de l'Environnement</p> <p>Tel : +212 670148648 E-mail : mkabriti@gmail.com</p>
SLOVENIA / SLOVENIE	<p>Ms Valentina Turk National Institute of Biology Marine Biology Station SI-6310 Piran, Fornace 41 Slovenia</p> <p>Tel: +386 59 232916 E-mail: turk@mbss.org, valentina@nib.si</p>
SPAIN / ESPAGNE	<p>Ms Marta Martinez-Gil Pardo de Vera Head of Unit Division for the Protection of the Sea Ministry of Food Agriculture and Environment San Juan de la Cruz s/n 28003 Madrid Spain</p> <p>Tel : +34 915975590 E-mail : mmgil@magrama.es</p>
TUNISIA / TUNISIE	<p>Mr Samir Kaabi Chef de Département ANPE 3 rue de Kenya 1002 Tunis Tunisie</p> <p>Tel : +21671845006 E-mail : oted@anpe.nat.tn</p>
TURKEY// TURQUIE	<p>Ms Eda Bayar Assistant Expert Marine and Coastal Management Department General Directorate of Environment Management Ministry of Environment and Urbanisation Ehlibeyt Mah 1271 sok, no. 13 Balgat Ankara Turkey</p> <p>Tel: +90 312 5863278 E-mail: eda.bayar@csb.gov.tr</p>

OBSERVERS / OBSERVATEURS	
PALESTINE / PALESTINE	Mr Issam Qasem Director of Tuikarem Office Environment Quality Authority Ramallah Palestine <u>Tel:+972 92674558</u> E-mail:isammena@hotmail.com

**UNITED NATIONS PROGRAMMES, FUNDS, AGENCIES AND RELATED
ORGANIZATIONS
REPRESENTANTS DES INSTITUTIONS SPECIALISEES DES NATIONS UNIES**

<p>IAEA- INTERNATIONAL ATOMIC ENERGY AGENCY /AIEA- AGENCE INTERNATIONALE DE L'ÉNERGIE ATOMIQUE</p>	<p>Mr Michael Angelidis Section Head Section of Marine Environmental Studies Laboratory Division of IAEA Environment Laboratories Department of Nuclear Sciences and Applications International Atomic Energy Agency 4 Quai Antoine 1er 98000 Monaco Principality of Monaco</p> <p>Tel: +377 97977236 E-mail : m.angelidis@iaea.org</p>
<p>BASEL CONVENTION REGIONAL CENTRE</p>	<p>Ms Dana Lapesova Director BCRC Bratislava Karloveska 2 P.O Box 132 840 00 Bratislava Slovakia</p> <p>Tel : +421 906314033 E-mail : dana.lapesova@sazp.sk</p>

**REPRESENTATIVES OF OTHER INTERGOVERNMENTAL ORGANIZATIONS
REPRESENTANTS D'AUTRES ORGANISATIONS INTERGOUVERNEMENTALES**

<p>AGREEMENT ON THE CONSERVATION OF CETACEANS IN THE BLACK SEA, MEDITERRANEAN SEA AND CONTIGUOUS ATLANTIC AREA (ACCOBAMS) / ACCORD SUR LA CONSERVATION DES CETACES DE LA MER NOIRE, DE LA MEDITERRANEE ET DE LA ZONE ATLANTIQUE ADJACENTE</p>	<p>M Alessio Maglio Joint ACCOBAMS-ASCOBANS-CMS Noise Working Group member Cours Caffarelli 117 Caen14000 France</p> <p>Tel.: +33 2 50 01 15 52 E-mail: alessio.maglio@sinay.fr</p>
<p>EUROPEAN ENVIRONMENTAL AGENCY / AGENCE EUROPEENNE POUR L'ENVIRONNEMENT</p>	<p>Mr David Stanners Senior Adviser Head of International Cooperation Kongens Nytorv 6 1050 Copenhagen Denmark</p> <p>Tel: +45 33367101 E-mail: david.stanners@eea.europa.eu</p>
<p>ENVIRONMENT AGENCY AUSTRIA</p>	<p>Ms Sabah Nait Key Account Manager Umweltbundesamt Spittelauer Lande 5 Vienna Austria</p> <p>Tel: +431313043245 E-mail: Sabah.Nait@umweltbundesamt.at</p>

INSTITUTES / INSTITUTS

HELLENIC CENTRE FOR MARINE RESEARCH (HCMR) /	Mr Ioannis Chatzianestis Research Director in HCMR HCMR 47 Km Athens Sounion Avenue Anavyssos Greece Tel:+302291076365 Mob:+306945217646 E-mail: jhat@hMrgr
UNIVERSITÀ DEL PIEMONTE ORIENTALE - DIPARTIMENTO DI SCIENZE E INNOVAZIONE TECNOLOGICA (DISIT)	Mr Aldo Viarengo University of Piemonte Alessandria Italy Tel:+393557182939 E-mail: aldo.viarengo@unipmn.it

**SECRETARIAT TO THE BARCELONA CONVENTION
AND COMPONENTS OF THE MEDITERRANEAN ACTION PLAN
SECRETARIAT DE LA CONVENTION DE BARCELONE ET COMPOSANTES DU PLAN
D'ACTION POUR LA MEDITERRANEE**

UNEP/MAP / PNUE/PAM	<p>Mr Habib N. El Habr Deputy Coordinator Tel: +30 210 7273126 E-mail: habib.elhabr@unepmap.gr</p> <p>MsTatjana Hema MED POL Programme Officer Tel: +30 210 7273115 E-mail: tatjana.hema@unepmap.gr</p> <p>Ms Virginie Hart Mediterranean Marine and Coastal Expert Tel: +30 210 7273122 E-mail: virginie.hart@unepmap.gr</p> <p>Ms Marina Markovic MED POL Expert Tel: +30 210 7273116 E-mail: NAP.sustainability.expert@unepmap.gr</p> <p>CONSULTANTS</p> <p>Mr Panagiotis Ioakimidis 49 A ' Attika str. GR-16342 Ilioupolis Greece</p> <p>Tel : +30 210 99167106 Mobile : +306937503282 E-mail: ioakimidispan@gmail.com</p> <p>Ms Pilar Zorzo KAI Marine Services C/ Nalón, 16 28240 Hoyo de Manzanares Madrid Spain</p> <p>Tel +34 666553112 Fax +34 918565199 E-mail: pzorzo@gmail.com</p> <p>United Nations Environment Programme Mediterranean Action Plan 48 Vassileos Konstantinou 11635 Athens Greece</p>
----------------------------	----------------------------------------------------------------------------------------------------------------------------------------------------------------------------------------------------------------------------------------------------------------------------------------------------------------------------------------------------------------------------------------------------------------------------------------------------------------------------------------------------------------------------------------------------------------------------------------------------------------------------------------------------------------------------------------------------------------------------------------------------------------------------------------------------------------------------------------------------------------------------------------------------------------------------------------------------------------------------------------------------------------------------------------------------------------------------------------------------------------------------------------------------------------------------------------------------------------------------------------------------------------------------------------------------------------------------------------------------------------------------------

<p>PLAN BLEU REGIONAL ACTIVITY CENTRE (PB/RAC) / PLAN BLEU, CENTRE D'ACTIVITE REGIONAL (PB/CAR)</p>	<p>Didier Sauzade Programme écosystèmes marins / Marine Ecosystems 271 Corniche Kennedy 13007 Marseille - France</p> <p>Tel: +33484080052 Fax: +33 4 92387131 E-mail: dsauzade@planbleu.org</p>
<p>REGIONAL MARINE POLLUTION EMERGENCY RESPONSE CENTRE FOR THE MEDITERRANEAN SEA (REMPEC) / CENTRE REGIONAL MEDITERRANEEN POUR L'INTERVENTION D'URGENCE CONTRE LA POLLUTION MARINE ACCIDENTELLE (REMPEC)</p>	<p>Mr Gabino Gonzalez Head of Office Maritime House' Lascaris Wharf Valletta VLT 1921</p> <p>Tel.: +356.22.583113 Fax: +356.21.339951 E-mail: ggonzalez@rempec.org, rempec@rempec.org</p> <p>Mr Franck Lauwers Programme Officer (Prevention) 'Maritime House', Lascaris Wharf Valletta VLT 1921 Malta</p> <p>Tel.:+356 21337296/7/8 Fax: +356 21339951 E-mail: flauwers@rempec.org, rempec@rempec.org</p>
<p>REGIONAL ACTIVITY CENTRE FOR SUSTAINABLE CONSUMPTION AND PRODUCTION (SCP/RAC) CENTRE D'ACTIVITES REGIONALES POUR LA CONSOMATION ET LA PRODUCTION DURABLES (CAR/CPD)</p>	<p>Mr Federico Gallo Sallent Senior Expert C/ Angli 31st, 3rd floor - 08017 Barcelona (Catalunya)- Spain</p> <p><u>Tel:+34 935538790</u> Mob:+34675394880 E-mail: fgallo@scprac.com</p> <p>Mr Manuel Clar Messanet Associated Expert Miquel Santandreu, 27 07006 Palma de Mallorca Spain</p> <p><u>Tel:+34 871939891</u> Mob :+34 678562455 E-mail :mclar@pmecon.com</p>

	<p>Ms Ana Isabel Conde Mansilla National Manager Technological Centre for Mercury Decontamination Cerro San Teodoro s/n Almaden Spain</p> <p>Tel: +34 608 268372 E-mail: aconde@ctndm.es</p>
<p>REGIONAL ACTIVITY CENTRE FOR INFORMATION AND COMMUNICATION (INFO/RAC) / CENTRE D'ACTIVITES REGIONALES POUR L'INFORMATION ET LA COMMUNICATION (INFO-CAR)</p>	<p>Mr Marco Montuori Institute for Complex Systems c/o Physics Department University La Sapienza Pl. Aldo Moro 2 00185 Roma</p> <p>Tel: +39 06 4991 3437 Mobile: +39 347 2312731 E-mail: marco.montuori@gmail.com</p>

Annex II – Provisional Agenda

Pre-session on Marine litter (16 June 2015)

17-19 June 2015

- Agenda item 1:** Opening of the Meeting
- Agenda item 2:** Election of Officers
- Agenda item 3:** Adoption of the Agenda and Organization of Work
- Agenda item 4:** Progress achieved regarding the implementation of the Programme of work 2014-2015 including the status of the implementation of the technical aspects of the Land Based Sources, Dumping and Hazardous Waste Protocols, Regional Plans adopted in 2009, 2012 and 2013 as well as marine pollution monitoring programmes
- Agenda item 5:** Proposed monitoring programme for the pollution and litter cluster of the Mediterranean EcAp-based ecological objectives (EO 5, 9 and 10)
- Agenda item 6:** General review of the draft Action Plan to implement the Offshore Protocol of the Barcelona Convention
- Agenda item 7:** Specific issues:
- a) *Proposed updated list of priority contaminants in the Mediterranean,*
 - b) *Proposed environmental targets, assessment criteria and thresholds for the pollution and litter cluster of the Mediterranean EcAp-based ecological objectives (EO 5, 9 and 10);*
 - c) *Guide on fishing for litter best practices;*
 - d) *Updated Marine litter Assessment Report ;*
 - e) *Mercury decontamination best practices and guidelines ;*
 - f) *Guide for the Environmental Sound Management (ESM) of Polychlorinated Biphenyls (PCB) in the Mediterranean ;*
 - g) *Guidelines for environmentally sound management of used lead batteries in the Mediterranean;*
 - h) *Lube oil ESM Guidelines based on Sustainable Consumption and Production (SCP), Best Available Technology (BAT), and Best Environmental Practice (BEP);*
 - i) *Guide towards a more sustainable tannery sector in the Mediterranean;*
 - j) *National Action Plan (NAP) update roadmap until COP 19 and implementation of respective guidelines.*
- Agenda item 8:** Mid Term Strategy 2016-2021 with particular focus on pollution prevention and control as well as the respective assessment and environmental governance aspects

Agenda item 9: MED POL Programme of work 2016-2017

Agenda item 10: Any other business

Agenda item 11: Conclusions and recommendations

Agenda item 12: Closure of the Meeting

Annex III – Conclusions and Recommendations

The meeting of the MED POL Focal Points was held on 17-19 June 2015 at Corinthia Hotel, Attard, Malta, with a pre-session on marine litter which was held on 16 June 2015 and a joint session with REMPEC Focal Points on 17 June 2015. The latter was dedicated to the draft Offshore Protocol Action Plan and the main elements of the Integrated Monitoring and Assessment Programme Ecological objectives on 5 (eutrophication), 9 (contaminants) and 10 (marine litter).

The main objectives of the meeting were to review the progress in the implementation of the current MED POL programme of work (PoW) for the biennium 2014 – 2015 including some of the key reports and technical guidelines produced. Moreover, the meeting was organized with the objective to review and provide feedback on the pollution prevention and control component of the UNEP/MAP Mid Term Strategy (MTS) and related MED POL PoW for the 2016 – 2017 biennium.

The meeting agreed on the following findings, conclusions and recommendations.

Progress Report

1. While acknowledging and expressing appreciation for the work carried out on implementing the PoW 2014 – 2015, as presented in the document UNEP(DEPI)/MED WG.417/3, the Focal Points (FPs) paid particular attention to quality assurance/control and reporting of marine pollution monitoring data.
2. In this respect, the meeting expressed strong concerns about data quality issues highlighted by the IAEA representative who reported on the results Proficiency Tests (PTs) carried out with a number of participating MED POL designated laboratories. The Secretariat was requested to send the results of the PTs to the respective MED POL FPs for information and action, as appropriate.
3. As regards the future PTs and training courses that will be organised in cooperation between the IAEA and MED POL and with the view to enhance efficiency and quality of monitoring, the meeting called upon the MED POL FPs to:
 - review the list of nominated laboratories and make necessary changes in order to include only laboratories that are participating in the national marine pollution monitoring programme;
 - ensure, in collaboration with MED POL, that the national laboratories participating in the PTs submit the results accordingly;
 - nominate candidates who are actually working on the analysis of samples for the national marine pollution monitoring programmes for the training courses.
4. Moreover, the meeting called upon the FPs to take necessary action to submit to the Secretariat all available pollution monitoring data up to 2014, if they have not done it yet. It was underlined that until a new format for submitting monitoring data is prepared and agreed by the FPs, the Contracting Parties shall submit their pollution monitoring data using the existing MED POL templates without delay.
5. The meeting took note of document UNEP(DEPI)/MED WG. 417/Inf.14 on updated 10 Recommended methods for monitoring of contaminants in the marine environment prepared by IAEA for use as appropriate by the Contracting Parties.

Recommendations of the informal online working groups on eutrophication, contaminants, and marine litter

6. The Focal Points reviewed UNEP(DEPI)/MED WG. 417/7 presented by the chairs/ co-chairs of the respective groups – Ms Popi Pagou (Greece) for eutrophication, Ms Nevenka Bihari (Croatia) for contaminants and Mr Francois Galgani (France) for marine litter and commended the very good work done. The meeting encouraged the Secretariat to continue with efforts to strengthen collaboration and synergies with the process of the EU MSFD implementation, in particular as regards technical groups on marine litter and underwater noise.
7. The meeting made several suggestions and approved the proposed recommendations of the online groups as amended and presented in Annex I to these conclusions and requested the Secretariat to submit them to the EcAp coordination group meeting in September 2015 for its consideration and approval.
8. With regards to the proposed thresholds, background and environmental assessment criteria, as well as marine litter baselines contained in the agreed recommendations of Annex I, the meeting noted they would be revisited and validated through collaborative efforts of the Secretariat and the CPs as additional data from the implementation of the relevant monitoring programmes would become available.
9. The meeting took note of ACCOBAMS proposal that the Mediterranean Strategy on Underwater Noise monitoring (EO11) be discussed together with the main elements of the integrated monitoring programme in the next EcAp meetings
10. With regards to document UNEP(DEPI)/MED WG.417/Inf.15. containing background information collected and assessed by the online groups, the MED POL FPs were invited to provide feedback and inputs as appropriate by 10 July 2015 at the latest to allow the online groups to finalise them and submit to the EcAp Coordination group meeting in September 2015.

Integrated Monitoring and Assessment Programme

11. Following the presentation by the Secretariat of the document UNEP(DEPI)/MED WG.417/6, the joint session of the MED POL and REMPEC FPs approved the main elements of the Integrated Monitoring and Assessment Programme related to Ecological Objectives 5, 9, 10 as presented in Annex II to these conclusions and requested the Secretariat to submit them to the EcAP Coordination Group meeting in September 2015 for further consideration and approval.

Draft Offshore Protocol Action Plan

12. Following the presentation of the Offshore Action Plan preparation process addressing in particular the comments received from a number of Contracting Parties, the meeting asked REMPEC to integrate the received comments so far, and initiate as soon as possible, a written procedure to all Contracting Parties for their review and comments. It was further agreed that a strict deadline should be fixed to reflect the comments of the Contracting Parties in the version to be submitted to the MAP Focal Points for further review.

Marine Litter Assessment Report

13. The updated Marine Litter Assessment Report (UNEP(DEPI)/MED WG.417/14) prepared by the Secretariat in line with Article 11 of the Regional Plan on Marine Litter (MLRP) was welcomed by the meeting as an effort to collect the existing and most up to date information

in the region on marine litter and its submission to MAP FP meeting/COP 19 as the first marine litter assessment report 2 years after the entry into force of the Regional Plan.

14. The MED POL FPs were invited to provide inputs to the draft Assessment Report before July 10, 2015 for finalisation by the Secretariat end of July 2015, final consideration by beginning of August 2015 by the MEDPOL FP and subsequent submission to the next MAP FPs meeting.
15. The meeting encouraged the creation of a regional coordination group under the leadership of UNEP/MAP to facilitate and coordinate actions for the implementation of the MLRP to be composed of key stakeholders (GFCM, ACCOBAMS, private sector, UNEP/MAP RACs, NGO's, IGOs, etc.). Structure and proposed Terms of Reference for the regional marine litter coordination group are also open for comments and proposals until 10 July 2015. The revised proposal will serve as a basis for drafting a decision on ML to be submitted to the MAP FP meeting in October 2015 (addressing the Fishing for Litter Guidelines, coordination mechanism, the proposed ML baseline and environmental targets).
16. The Secretariat took note of the willingness of ACCOBAMS to continue supporting UNEP/MAP on marine litter and its involvement in the Coordination Group.

List of contaminants

17. Following the presentation of document UNEP(DEPI)/MED WG.417/4 – chapter 1 – on the updated list of contaminants, the meeting took note of the proposed categorization of contaminants in three groups as follows:
 - Group 1 – Substances identified as present in almost all the reviewed lists including the SAP MED and substances for which LBS Protocol legally binding measures have been adopted as well as the lists of relevant MEA, WFD, REACH regulation, OSPAR and HELCOM ;
 - Group 2 – Substances for which additional scientific information (sources, quantities) is needed;
 - Group 3 – Substances included in WFD priority list of substances, for which preliminary screening might be needed for the Mediterranean.
18. Following the discussion the meeting agreed on the proposed criteria for the categorization of contaminants and reconfirmed Group I as the group that should be given high attention by the CPs in the framework of the NAPs/LBS Protocol implementation while for the other groups as well as for those substances found through research studies in the Mediterranean sea, additional research were recommended as appropriate. The meeting asked the Secretariat to follow relevant developments and to provide periodical updates and feedback to the FPs.

Guidelines

19. The meeting took note of document UNEP(DEPI)/ MED WG.417/Inf.13 An updated list of priority contaminants for the Mediterranean and encouraged the FP to provide feedback and additional information by end of July 2015 at the latest with the view to finalize and publish the report in the on line MAP technical Series.
20. Appreciating the high quality of the Fishing for Litter (FIF) guidelines (UNEP(DEPI)/MED WG. 417/13) and the work done on integration of comments raised during the pre-session held on 16 June 2015, the meeting approved the Guidelines as amended and presented in Annex III

for submission to MAP FP meeting and to the COP in line with Article 10 of the Regional Plan on Marine Litter. It should be noted that the main points suggested by the meeting during the pre-session addressed the need to include a definition of the Fishing for Litter concept, better reflect a number of Mediterranean best practices and FfL projects, strengthen the chapter on health and safety and improve explanations on distinctions between active and passive approaches with regards to EIA.

21. In addition the meeting requested the Secretariat to prepare a short paper with information of the costs of implementation of the Guidelines for submission to the MAP FP meeting and the COP.
22. Following the presentation by the representative of MAYASA Almaden (Ciudad-Real) on behalf of SCP/ RAC, the meeting expressed appreciation for the high quality of the Guidelines on BEPs for the management of mercury contaminated site (UNEP(DEPI)/MED WG. 417/8) as well as for opportunities provided to the countries to contribute to their preparation. The meeting approved the Guidelines as amended and presented in Annex IV, for submission to the MAP FP and to the COP in line with Article 5 paragraph 5 of the RP on Mercury).
23. Appreciating the quality of the PCB Guide as presented in document (UNEP(DEPI)/MED WG. 417/9) the meeting endorsed their content and requested the Secretariat to publish them in the MAP Technical Series. The meeting invited the CPs to promote their implementation in line with global relevant standards and guidelines with a view to implement where appropriate relevant priority actions in the updated NAPs and SAP MED.
24. The meeting commended the Guidelines on lead batteries (UNEP(DEPI)/MED WG. 417/12). The content of the document was endorsed as amended and presented in Annex V, including a modified formulation on landfilling of used lead batteries. The document was suggested for publication in the MAP Technical Series and for further promotion and implementation by the CPs.
25. The meeting took note of the draft of Lube Oil and Tanneries Guidelines (UNEP (DEPI)/MED WG.417/ 10 and UNEP (DEPI)/MED WG.417/ 11) presented by the SCP/RAC and provided general feedback on their content. Pending the discussion at the forthcoming expert meeting, the CPs expressed satisfaction with the content and presentation of the draft guidelines as well as their willingness to provide comments in the run up to the expert meeting. The Secretariat invited the countries that have not already done so to send relevant information, complete and return relevant questionnaires to facilitate finalization of the guidelines.

NAP update

26. The meeting took note of the National Action Plans (NAPs) update Roadmap prepared by the Secretariat. Taking into consideration concerns and requests expressed by several CPs, the meeting agreed that the latest deadline for submission of updated NAPs to the Secretariat should be December 2015. In addition the meeting formally approved NAP update Guidelines as contained in the document UNEP (DEPI)/MED WG.417/ Inf.6, taking into account the need for revisiting them as appropriate in particular its technical annexes following their application.

NBB Reporting

27. Due to the importance of submitting the NBB 2013 data, the meeting called upon the Focal Points to make a special effort and submit the data by October 2015 at the latest to the newly developed NBB infosystem either through PRTR XML files and/or MED POL template for

NBB data. To this aim the meeting requested the Secretariat to develop user guidelines and organize face to face or virtual training sessions.

Programme of work and MTS

28. The meeting appreciated the work done for the preparation of the MTS as well as of the 2016-2017 programme of work and made several suggestions to further clarify the proposed indicators favorizing mainly the setting of indicators at 2-year level. It was agreed to provide comments to the Secretariat by 26 June 2015 at the latest addressing in particular the priority ranking of proposed activities in three categories (high, medium and low) as well as concrete suggestions on possible performance indicators.
29. The meeting also requested the Secretariat while finalizing the programme of work to add timelines for their implementation.
30. The Secretariat is requested to circulate the amended PoW to MED POL FP before the document is sent to the MAP focal points.

Other Business

31. Following the briefing of MAP deputy coordinator on the meeting of the Review and Monitoring (RM) Subgroup established under the H2020 held on 16 June 2015 back to back with MEDPOL FP meeting, it was agreed in principle to support the participation of national MEDPOL FP and another representative from SoE national reporting team as members of the RM subgroup with the view to enhance national coordination with regards to pollution assessment and reporting.
32. In addition due to the fact that UNEP/MAP is planning to prepare in 2019 SoE Report as per the mandate by the Contracting Parties as well as contribute together with the EEA to the preparation of a joint report on H2020 implementation, the meeting recommended to bring to the attention of the MAP FP the need for streamlining their preparation and delivering if possible one common report.
33. Following the presentation by the Secretariat of a concept note for a future GEF project in the Mediterranean, the MED POL FP were invited to provide feedback and inputs by mid-July 2015, with the view to enable the Secretariat to finalize a more consolidated project proposal and a Project Identification Form. In addition, the FPs were invited to coordinate with the national GEF focal points to ensure that national priorities are taken into account.

Side events

34. The meeting appreciated the demonstration session by the Secretariat of the NBB information system which allowed an exchange of views on ways and means to ensure a timely reporting of loads of pollutants by the Contracting Parties to the Secretariat.
35. The meeting also appreciated the presentation made by Plan Bleu with regards to marine policy toolbox developed in the framework of PERSEUS project as a useful tool to support EcAp application under UNEP/MAP Barcelona Convention and MSFD implementation.

Annex III, Appendix 1

RECOMMENDATIONS OF THE ONLINE INFORMAL WORKING GROUPS

I. INFORMAL ONLINE WORKING GROUP ON EUTROPHICATION

Proposed thresholds and methodological criteria for eutrophication assessment in Mediterranean.

Typology scheme

Typology is very important for further development of classification schemes of a certain area. The recommended water types for applying eutrophication assessment are based on hydrological parameters characterizing a certain area dynamics and circulation. The typological approach is based on the introduction of a static stability parameter (derived from temperature and salinity values in the water column). Such a parameter, on a robust numerical basis, can describe the dynamic behaviour of a coastal system. It is accepted that surface density is adopted as a proxy indicator for static stability as both temperature and salinity are relevant in the dynamic behavior of a coastal marine system. More information on typology criteria and setting is presented in document UNEP(DEPI)/MED WG 417/Inf.15.

In the Mediterranean a considerable number of eutrophication experts have built a typology scheme for the Mediterranean coastal waters during the first inter-calibration phase for the EU Water Framework Directive implementation, which is still in use after their update according to Commission Decision 2013/480/UE and represents a very simple typology approach that could be easily applied Mediterranean wide for coastal waters (sensu WFD, i.e. 1nm), since these coastal waters have been intercalibrated.. In this context the e major water types have been defined on the basis of surface density and salinity values as presented in Table 1:

Table 1 Definition of major coastal water types in the Mediterranean that have been intercalibrated (applicable for phytoplankton only) according to EU Comission Decision 2013/480/EU.

	Type I	Type IIA, IIA Adriatic	Type IIIW	Type IIIE	Type Island-W
σ_t (density)	<25	25<d<27	>27	>27	All range
salinity	<34.5	34.5<S<37.5	>37.5	>37.5	All range

The different coastal water types, in an ecological perspective, can be described as follows:

- Type I coastal sites highly influenced by freshwater inputs
- Type IIA coastal sites moderately influenced not directly affected by freshwater inputs (continent influence)
- Type IIIW continental coast, coastal sites not influenced/affected by freshwater inputs (Western Basin)

- Type III E not influenced by freshwater input (Eastern Basin)
- Type Island: coast (Western Basin)

In addition, the coastal water type III was split in two different sub basins, the Western and the Eastern Mediterranean ones, according to the different trophic conditions and is well documented in literature.

Some examples of Water Types presence finally defined for the European countries, Party to the Barcelona Convention and LBS Protocol are shown in the Table 2.

Table 2 Examples of coastal water types in some Mediterranean countries

New types		Croatia	Cyprus	France	Greece	Italy	Slovenia	Spain
	Description							
Type I	Highly influenced by freshwater input			X		X		
Type II	Moderately influenced by freshwater input	X		X		X	X	X
Type III WM	Not influenced by freshwater input	X		X		X		X
Type III EM	Not influenced by freshwater input		X		X			

Proposed recommendations

1. Contracting parties are invited to agree on the proposed criteria for typology of coastal waters as presented in Table 1.
2. Contracting parties are invited to apply the above criteria and define their coastal water types with the support from MEDPOL if needed, in the course of 2015.

2. Thresholds and reference conditions for chlorophyll-a in the different water types

Reference and threshold (Good/Moderate status) derived values (G-mean annual values based on long time series (>5 years) of monthly sampling at least) differ from type to type on a sub-regional scale and were build with different strategies. Summaries values are given in Table 3.

Table 3. Reference and threshold values of Chla in Mediterranean coastal water types (according to Commission Decision of 20 September 2013 establishing, pursuant to Directive 2000/60/EC of the European Parliament and of the Council, the values of the Member State monitoring system classifications as a result of the intercalibration exercise and repealing Decision 2008/915/EC).

Coastal waters Typology	Reference conditions of Chla ($\mu\text{g L}^{-1}$)		Boundaries of Chla ($\mu\text{g L}^{-1}$) for G/M status	
	G_mean	90% percentile	G_mean	90% percentile
Type I	1,4	3,33¹ - 3,93²	6,3	10¹ - 17,7²
Type II-FR-SP		1.90		3.60
Type II-A Adriatic	0.33	0.80	1.50	4.00
Type II-B Tyrrhenian	0.32	0.77	1.20	2.90
Type III-W Adriatic			0.64	1.70
Type III-W Tyrrhenian			0.48	1.17
Type III_W FR-SP		0.90		1.80
Type IIIE		0.10		0.40
Type Island-W		0.60		1.22

Note 1: The 90th percentile and the geometrical mean can be derived one from the other according to the following equation:

$$\text{Chl-a } 90^{\text{th}} \text{ p.} = 10^{(\text{Log}_{10}(\text{G_meanChl-a}) + 1.28 \times \text{SD})}$$

Note 2: The MEDGIG exercise phase III is in progress, therefore an update of the above table may occur, which will be considered, accordingly.

Proposed recommendations

1. The Contracting Parties are recommended to rely on the classification scheme on chl-a concentration ($\mu\text{g/l}$) in coastal waters as a parameter easily applicable by all Mediterranean countries based on the indicative thresholds and reference values presented in Table 3.
2. However, for a complete assessment of eutrophication and GES achievement, GES thresholds and reference conditions (background concentrations) are needed not only for chlorophyll-a, but such values must be set, in the near future, through dedicated workshops and exercises also for nutrients, transparency and oxygen as minimum requirements. Nutrient, transparency and oxygen thresholds and reference values may not be identical for all areas, since it is recognized that area-specific environmental conditions must define threshold values. GES could be defined on a sub-regional level, or on a sub-division of the sub-region (such as the Northern Adriatic), due to local specificities in relation to the trophic level and the morphology of the area.
3. Following the evaluation of information provided by a number of countries and other available information, it has to be noted that the Mediterranean countries are using different eutrophication non mandatory assessment methods such as TRIX, Eutrophication scale, EI, HEAT, OSPAR, etc. These tools are very important to continue to be used at sub-regional or national levels because there is a long term experience within countries which can reveal / be used for assessing eutrophication trends.
4. However, in order to increase coherency and comparability regarding eutrophication assessment methodologies it is recommended that further efforts should be made to harmonize existing tools through

¹ Applicable to Golf of Lion Type I coastal waters

² Applicable to Adriatic type I coastal waters

workshops, dialogue and comparative exercises at regional/subregional/subdivision levels in Mediterranean with a view to further develop common assessment methods.. .

II. INFORMAL ONLINE WORKING GROUP ON CONTAMINANTS

Specific Recommendations of the Contaminant Working Group

1. Indicate sampling and analytical methodology to follow and assess biological responses in the Main elements of the Draft Integrated Monitoring and Assessment Programme for Ecological Objectives 5, 9 and 10 (UNEP(DEPI)/MED WG 417/6) based where appropriate on the relevant methodologies used in OSPAR or other fora;
2. Amend the UNEP/MAP Technical Report Series No. 120 with particular reference to the sampling period (case of fish) and sampling frequency (case of sediments) based where appropriate on the relevant methodologies used in OSPAR or other fora;
3. Assess and test in the coming years the convenience of normalizing metal concentrations in samples from certain regions of the Mediterranean Sea when Aluminium, Iron and Organic content data from sediments would be available in MED POL database from possibly all Contracting parties);
4. Recommend mussel and fish LMS as mandatory biomarker and establish an effective data quality assurance and control as a crucial step to ensure reliable assessments
5. Follow the OSPAR approach of a “traffic light” system for both contaminant concentrations and biological responses, where there are two “thresholds” T_0 and T_1 to be defined (OSPAR, 2008; Davies et al., 2012);
6. Adopt BCs and BACs of contaminants (for naturally occurring substances) in sediments obtained from the analysis of pre-industrial layers of dated sediment cores established for the Mediterranean region (UNEP(DEPI)/MED WG. 365/Inf.8) where appropriate based on data availability;
7. Use for indicative purposes the existing EACs of contaminants in sediments and biota and of biological responses established by ICES/OSPAR until new ecotoxicological information is available including for Mediterranean species; (OSPAR, 2008; Davies et al., 2012);
8. Request the Contracting Parties and MED POL to further work and develop as appropriate new BCs and BACs of contaminants in sediments obtained by using data from sediments sampled at sites/areas which Mediterranean contracting parties consider being reference stations/areas to be defined based on commonly agreed criteria;
9. Request the Contracting Parties and ME POL to further work and develop new BCs and BACs of contaminants in biota (mussels and fish) obtained by using only data from organisms sampled at sites/areas which Mediterranean contracting parties consider being reference stations/areas to be defined based on commonly agreed criteria
10. Use the existing BACs and EACs of LMS, SoS, MN frequency and AChE activity biomarkers established (Davies et al., 2012); and further work to develop and discuss new BAC by using data from organisms sampled at sites/areas which the Mediterranean contracting parties consider a reference stations/areas, to be defined based on commonly agreed criteria;
11. Extend and amend the existing reporting formats used for contaminants and biological responses in MED POL database to avoid gaps of the information required and to facilitate the proper assessment of environmental criteria;
12. Request the Secretariat (MED POL) to continue supporting the Online Contaminants Working Group for long term developments of activities dedicated to chemical pollution and development of assessment.

III. INFORMAL ONLINE WORKING GROUP ON MARINE LITTER

1. Proposed baselines values (Rationale for this proposal presented in document UNEP(DEPI)/MED WG 417/Inf.15

Indicator	minimum value	maximum value	mean value	Proposed baseline
16. Beaches (items/100 m)	11	3600	920	450-1400
17. Floating litter (items/km ²)	0	195	3.9	3-5
17. Sea floor (items/km ²)	0	7700	179	130-230
17. Microplastics (items/km ²)	0	892000	115000	80000-130000
18. Sea Turtles Affected turtles (%) Ingested litter(g)	14% 0	92.5% 14	45.9% 1.37	40-60% 1-3

“It must be noted that the amount of existing information is limited to set definitive baselines that may be adjusted once the national monitoring programs could provide additional data. Moreover, Average values over large areas are difficult to harmonize, in particular for beach litter. Then, the setting or derivation of baselines should take the local conditions into account and may follow a more localized approach. Finally, additional specific baselines may be decided by CPs on specific litter categories especially when they may represent an important part of litter found or a specific interest (targeted measures, etc.).”

2. Categories of marine litter on the beaches

Regarding the categories of marine litter on the beaches, the Marine Litter Working Groups suggests that the CORMON should agree on a reduced list (desirably close to that in use in the others RSC), which would include the items more frequently found on the Mediterranean beaches, avoiding those that are found rarely. Moreover, the lists of litter categories considered in countries having monitoring programs dedicated to two RSC (e.g. Turkey, France or Spain) would need harmonization. For this, the MSFD derived MEDPOL list is now compatible with other RSC lists of beach litter categories.

With regards to the MSFD form presented in the Marine litter chapter integrated monitoring programme document UNEP(DEPI)/MED WG 417/6, it is proposed to merge some types of beach litter (e.g. different types of plastic drink bottles or different types of caps/lids and rings, etc.), split glass and ceramic items categories, consider the sanitary and medical wastes as a separate category and not to include several specific items that have not appeared in the running Mediterranean countries monitoring programmes (e.g. Spanish Monitoring Program on beach marine litter, implemented from 2013 in the Mediterranean). In addition, the online group proposes to use for surveys a minimum lower limit of particle size at 0.5 cm (upper size of microlitter); UNEP(DEPI)/MED WG 417/6.

3. Proposed Marine litter environmental targets:

EcAp Indicators	Type of Target	Minimum	Maximum	Recommendation	Remark
Beaches (EI16)	% decrease	significant	30	20% by 2024 or [2030]	Not 100% marine pollution
Floatin Litter (EI 17)	% decrease	-	-	Statistically Significant	sources are difficult to control (trans border movements)
Sea Floor Litter (EI 17)	% decrease	stable	10% in 5 years	Statistically Significant	15% in 15 years is possible
Microplastics (EI 17)	% decrease	-	-	Statistically Significant	sources are difficult to control (trans border movements)
Ingested Litter (EI 18) Number of turtles with ingested litter (%) Amount of ingested litter	% decrease in the rate of affected animals % decrease in quantity of ingested weight(g)	- -	- -	Statistically Significant Statistically Significant	Movements of litter and Animals to be considered

4. Other recommendations

SCALE	Common baselines for the various EI (16, 17, 18) must be considered at the level of the entire basin (Mediterranean) rather than at sub regional level
RESEARCH	Need to define an adapted protocol for microplastics(< 5mm) in sediments
	Research to support the development of an indicator dedicated to entanglement
BASELINES/TARGETS	Consider specific baselines and targets for litter categories that are individually targeted by reduction plans or measures by the Contracting Parties (cigarette butts, plastic bags, cotton buds, etc)
CATEGORIES	Consider the reduction of the number of items in MEDPOL monitoring protocol
	Adapt MEDPOL master list , MSFD derived, to harmonize with other RSC
MONITORING	Needs for adjustment of the monitoring guidance (more compatible definitions and wording, list of items/categories)
	Harmonization of the ECAP monitoring Guidance with the online group report and recommendations
SUPPORT	
MONITORING	Consider the relevance of ML for monitoring marine pollution (lower costs, possible harmonization, easy protocols), especially on beaches, when compared with other approaches (e.g. analysis of contaminants)
	Support evaluation/adjustments of baselines/targets on the basis of the first monitoring results
	Improve knowledge on experimental indicator EI 18, Support capacity building and monitoring experiment on sea turtles at a pilot scale

QUALITY ASSURANCE	As the Mediterranean Action Plan on ML is based on measures and monitoring efforts should be shouldered by quality control/quality assurance (training, inter-comparisons, use of reference material for microplastics, etc.) to assist survey teams.
DATA MANAGEMENT	Data base is to be organized for the collection of data
Secretariat	Continue support for the ML expert group for long term developments of activities dedicated to Marine Litter, trends analysis and analysis of data from countries (art 11 of the MLRP)
	Consider capacity building in long term, in support of the MLRP (training, inter-calibrations, etc.)

Annex III, Appendix 2

Main elements of the Integrated Monitoring and Assessment Programme

Table of contents

Note by the Secretariat.....	1
Chapter I Eutrophication chapter and related fact sheet.....	5
Chapter II Contaminant chapter and related fact sheet.....	17
Chapter III Marine Litter chapter and related fact sheet.....	41

Chapter I
Eutrophication chapter and related fact sheet

I. MONITORING AND ASSESSMENT METHODOLOGICAL GUIDANCE ON EO5: EUTROPHICATION

1. Introduction

Eutrophication is a process driven by enrichment of water by nutrients, especially compounds of nitrogen and/or phosphorus, leading to: increased growth, primary production and biomass of algae; changes in the balance of nutrients causing changes to the balance of organisms; and water quality degradation. The consequences of eutrophication are undesirable if they appreciably degrade ecosystem health and/or the sustainable provision of goods and services. These changes may occur due to natural processes. Management concern begins when they are attributed to anthropogenic sources. Additionally, although these shifts may not be harmful in themselves, the main worry concerns 'undesirable disturbance': the potential effects of increased production, and changes of the balance of organisms on ecosystem structure and function and on ecosystem goods and services.

In the Mediterranean, the UNEP/MAP MED POL Monitoring programme included from its inception the study of eutrophication as part of its seven pilot projects approved by the Contracting Parties at the Barcelona meeting in 1975 (UNEP MAP, 1990a,b). The issue of a monitoring strategy and assessment of eutrophication was first raised at the UNEP/MAP MED POL National Coordinators Meeting in 2001 (Venice, Italy) which recommended to the Secretariat to elaborate a draft programme for monitoring of eutrophication in the Mediterranean coastal waters. In spite of a series of assessments reviewing the concept and state of eutrophication, there are important gaps in the capacity to assess the intensity of this phenomenon, even more to compare or grade the various sites. Efforts have been devoted to define the concepts to assess the intensity and to extend experience beyond the initial sites in the Adriatic Sea admittedly the most eutrophic area in the entire Mediterranean Sea.

GES with regard to eutrophication is achieved when the biological community remains well-balanced and retains all necessary functions in the absence of undesirable disturbance associated with eutrophication (e.g. excessive algal blooms, low dissolved oxygen, declines in sea-grasses, kills of benthic organisms and/or fish) and/or where there are no nutrient-related impacts on sustainable use of ecosystem goods and services. The conceptual model of eutrophication is presented in Figure 1 for information purposes.

2. The choice of indicators for monitoring and assessing eutrophication

Despite the great variability born by the water layers subject to active hydrodynamic processes, monitoring the characteristics of the seawater is still the most direct way of assessing eutrophication. A number of parameters have been identified as providing most information relative to eutrophication e.g. chlorophyll, dissolved oxygen, inorganic nutrients, organic matter, suspended solids, light penetration, aquatic macro-phytes, zoo benthos, etc. They all may be determined either at the surface or at various depths. However even though these variables are routinely determined by most marine laboratories they may pose some problems to some less specialized institutions. Remote sensing may also be employed and with great success when eutrophication extends over large areas such as in the case of the northern Adriatic Sea.

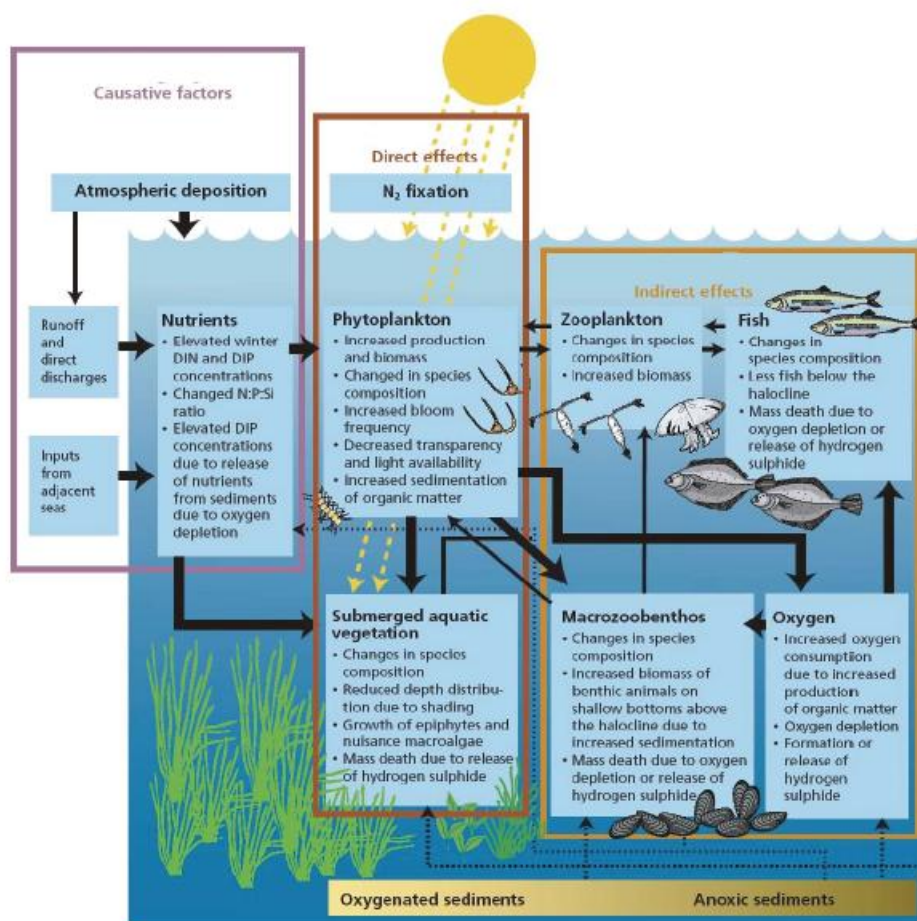

Figure 1. Conceptual model of eutrophication. The arrows indicate the interactions between different ecological compartments. A balanced marine ecosystem is characterised by: (1) a pelagic food chain (phytoplankton ► zooplankton/zoobenthos ► fish), which effectively couples production to consumption and minimises the potential for excess decomposition (2) natural species composition of plankton and benthic organisms, and (3) if appropriate, a natural distribution of submerged aquatic vegetation. Nutrient enrichment results in changes in the structure and function of marine ecosystems, as indicated with bold lines. Dashed lines indicate the release of hydrogen sulphide (H₂S) and phosphorus, under anoxic conditions at the sediment-water interface, which is positively related to oxygen depletion. In addition, nitrogen is eliminated by denitrification in anoxic sediment.

If only limited means are available, determination of those parameters that synthesize the most information should be retained. Chlorophyll determinations for example, although not very precise representations of the system, are data which provide a great deal of information. Reliable data on nutrients are extremely useful indicators of potential eutrophication. Turbidity and seawater colour (Forell scale, Wernard and van der Woerd, 2010) may also be a good measure of eutrophication, except near the mouths of rivers where inert suspended solids may be extremely abundant. Dissolved oxygen is one parameter that integrates much information on the processes involved in eutrophication, provided it is measured near the bottom or, at least, below the euphotic zone where an oxycline usually appears.

- 2.1. The choice of eutrophication indicators to be monitored under the LBS Protocol and the draft Integrated Monitoring and Assessment Programme (Common indicators 7 and 8, Concentration of key nutrients in the water column and Chlorophyll-a concentration in the water column)

Decision 21/3 of COP 18 of the Contracting parties to the Barcelona Convention (Istanbul, December 2013) provides for assessing eutrophication for the Ecosystem Approach by combining the information on nutrient levels, direct effects (specifically chlorophyll – a concentration and water transparency for the 2016 ECAP monitoring activities) and indirect effects (oxygen concentration for the 2016 ECAP monitoring activities). These elements to be monitored reflect the short term eutrophication monitoring strategy of UNEP/MAP MED POL Phase III and IV (UNEP (DEC) WG.231/14) according to which pilot monitoring programmes were implemented in different Mediterranean locations to build capacity in setting up and implementing integrated eutrophication monitoring programmes, (in which phytoplankton total abundance, abundance of major groups and bloom dominance would also be monitored on a discretionary basis). It is considered that the aim would now be focused within the ecosystem approach framework towards developing complete coherent datasets at the entire regional sea level.

In addition it is fundamental to link up to budgets of nutrient sources and loads (e.g. terrestrial, airborne) so the load can be associated with impairment and successful management measures can be developed from that relationship. Such an inventory of pollution sources and loads from land based activities (**NBB**) is prepared periodically by UNEP/MAP MED POL in the framework of the implementation of the LBS Protocol and the Strategic Action Programme (**SAP-MED**) to Address Pollution from Land Based Activities (adopted in 1997 and launched in 2000). The third cycle of the NBB reporting is currently ongoing and expected to be finalized in early 2015.

No single analytical tool is adequate to measure the degree of eutrophication of a given body of water. Instead, most experts believe the best approach is to measure many different parameters and to synthesize the results into a general model providing an overall, somewhat integrated degree of eutrophication for the water. Unless proper selection of the parameters to be measured is made, the amount of work required to assess the extent and intensity of eutrophication may be rather costly.

Measurement strategy and sampling design are therefore keys to the success in monitoring eutrophic areas. It will certainly have to adapt to the morphological characteristics of the area to be monitored, its hydrodynamics and the sources of nutrients. It should be realized that simple measuring and sampling schemes will not provide much insight into an extremely complex phenomenon. Depending on the importance of the impact of eutrophication (plankton blooms, HABs, anoxic events) the amount of effort needed to be put into a monitoring plan can be assessed.

3. Monitoring strategy

3.1. Considerations regarding eutrophication monitoring methods

Traditional methods for eutrophication monitoring in coastal waters involve in situ sampling/measurements of commonly measured parameters such as nutrients concentration, chlorophyll 'a' concentration, phytoplankton abundance and composition, transparency and dissolved oxygen concentration. Concerning available methods for in situ measurements, ships provide flexible platforms for eutrophication monitoring, while remote sensing provides opportunities for a synoptic view over regions or sub-regions. Besides traditional ship measurements, ferry-boxes and other autonomous measuring devices have been developed that allow high frequency and continuous measurements.

In situ measurements are more suitable:

- In (sub) regions/areas/sites with an increasing eutrophication problem,
- When a sub-region/area/site is close to or under GES for eutrophication
- When the status with respect to eutrophication is still unclear
- In sub-regions/areas/sites where for other reasons accurate and reliable data are needed (generally these are coastal sub-regions, in particular close to rivers).

Modelling and remote sensing should also be considered as alternatives or in addition to in situ measurements, depending on the requirements with respect to data. In general, in situ measurements always remain necessary to validate and calibrate the models and data calculated from satellite measurements.

Model generated data are more suitable:

- In (sub) sub-regions with a stable, predictable eutrophication status
- In sub-regions in GES or where the eutrophication problem is decreasing
- In offshore areas where taking in situ measurements is costly and where nutrient levels are correlated with levels in the coastal zone (extrapolation)
- In case satellite data are inaccurate or not available
- Where there is a need for an average picture of the local eutrophication status; models are very good at calculating this average picture combining hydraulic models and in situ measurements of standard sampling sites (interpolation)

As with models, remote sensing generally allows the production of data with a higher spatial and temporal resolution than in situ measurements. Thanks to the use of satellites it is possible to have synoptic measurements over large areas. This makes the satellite data particularly useful for large-scale studies and observations and/or for studies of temporal trends.

Satellite data are more suitable:

- In (sub) sub-regions/areas/sites with a stable, predictable eutrophication status
- In sub-regions/areas/sites in GES or where the eutrophication problem is decreasing
- In offshore sub-regions/areas/sites where taking in situ measurements is costly and where nutrient levels are correlated with levels in the coastal zone
- In case models are inaccurate or not available
- For comparisons of the eutrophication status over large sub-regions
- For validation and calibration of the information on spatial distribution
- In sub-regions/areas where funds are limiting
- In sub-regions/areas where for other reasons the accuracy can be lower than provided by in situ measurements (generally these are offshore areas)
- In addition to in situ measurements

However, satellite data need to be supported by ground truth data.

A good strategy appears to be a combination of remote sensing and scanning of the area known or suspected to be affected with automatic measuring instruments such as thermo-salinometer, dissolved oxygen sensors and in vivo fluorometer and/or nephelometer. Sampling for the determination of “in vitro” fluorescence and nutrient analysis may be carried out with relatively little effort if a proper pump and hose are mounted on the ship. The measurements may be done at the surface or just below it with a water intake on the hull of the vessel or at fixed or varying depths with a towed “fish” and pumping system.

Processing and evaluating the data should be carried out having a predefined model of the system under study. Models of the aquatic ecosystem may be good tools for monitoring eutrophication efficiently. Since none of the eutrophication indicators alone can provide an absolute account of the extent and /or intensity of eutrophication, numerical models in which quantitative relationships among the various characteristics are given, allow an overall assessment of the phenomenon to be made with a small number of field and/or laboratory measurements.

3.2. The frequency of eutrophication monitoring and location of sampling sites

The extent of eutrophication shows spatial variation, for instance coastal regions versus the open sea. The frequency and spatial resolution of the monitoring programme should reflect this spatial variation in eutrophication status and pressures following a risk based approach and the precautionary principle.

The first factor promoting eutrophication is nutrient enrichment. This explains why the main eutrophic areas are to be found primarily not far from the coast, mainly in areas receiving heavy nutrient loads. However, some natural symptoms of eutrophication can also be found in upwelling areas. Additionally, the risk of eutrophication is linked to the capacity of the marine environment to confine growing algae in the well-lighted surface layer. The geographical extent of potentially eutrophic waters may vary widely, depending on:

- (i) the extent of shallow areas, i.e. with depth ≤ 20 m;
- (ii) the extent of stratified river plumes, which can create a shallow surface layer separated by a halocline from the bottom layer, whatever its depth
- (iii) extended water residence times in enclosed seas leading to blooms triggered to a large degree by internal and external nutrient pools; and
- (iv) upwelling phenomena leading to autochthonous nutrient supply and high nutrient concentrations from deep water nutrient pools, which can be of natural or human origin.

Sub-regions/areas that are in sub-GES status in terms of eutrophication, or that could be considered at risk of not achieving GES generally require more intense monitoring than regions shown to be achieving GES.

Flexibility should be incorporated into the design of the monitoring programme to take account of differences in each marine sub-region/area. Furthermore in cooler regions winter is an optimal period for measuring nutrients since the data are not disturbed by (variable) uptake by algae/macrophytes. In those regions, spring/summer is an optimal period of the algal growing season and therefore for measuring effects of high nutrient availability. In warmer regions productivity continues during (a large part of) the winter period. In these regions, year round measurements of nutrients may be more appropriate.

In brief the geographical scale of monitoring for the assessment of GES for eutrophication will depend on the hydrological and morphological conditions of an area, particularly the freshwater inputs from rivers, the salinity, the general circulation, upwelling and stratification. The spatial distribution of the monitoring stations should, prior to the establishment of the eutrophication status of the marine sub-region/area, be risk-based and proportionate to the anticipated extent of eutrophication in the sub-region under consideration as well as its hydrographic characteristics aiming for the determination of spatially homogeneous areas. Consequently, each Contracting Party would be required to determine the optimum frequency per year and optimum locations for their monitoring stations. Each Contracting Party is responsible for the choice of the most representative sampling stations in order to detect a change over a selected period.

Salinity gradients can be a proxy for river discharge and salinity and nutrient concentrations are often strongly correlated. Salinity can thus be used to determine an optimal spatial distribution of sampling sites, in particular if a model is available to couple salinity and hydrodynamics to nutrient levels. Salinity and temperature are also important parameters supporting the interpretation of eutrophication indicators. Therefore, annual and seasonal temperature regime and, where relevant, spatial and temporal distribution of salinity should be measured in both GES and non-GES regions.

The current national eutrophication monitoring programme implemented so far by the Contracting Parties in the framework of the UNEP/MAP MED POL programme should be used as a sound basis for monitoring under the EcAp complemented with the additional elements based on the above mentioned considerations and each country/sub region/area specificity.

3.3 Characterization of Ecological Quality Status of coastal marine waters with regard to eutrophication

The TRIX index (Vollenweider et al., 1998) may be used for a preliminary assessment of the trophic status of coastal waters in relation to eutrophication providing that its advantages and shortcomings are taken into account (Primpas and Karydis, 2011). The adopted UNEP/MAP MED POL short term eutrophication monitoring strategy monitored parameters to support the TRIX index. This Index is widely used to synthesize key eutrophication variables into a simple numeric expression to make information comparable over a wide range of trophic situations:

$$\text{TRIX Index} = (\text{Log}_{10} [\text{ChA} \cdot \text{aD}\% \text{O} \cdot \text{DIN} \cdot \text{TP}] + k) \cdot m$$

where:

ChA = Chlorophyll a concentration as $\mu\text{g/L}$;

aD%O = Oxygen as absolute % deviation from saturation;

DIN = Dissolved Inorganic Nitrogen, N-(NO₃+NO₂+NH₄) as $\mu\text{g/L}$;

TP = Total Phosphorus as $\mu\text{g/L}$.

k=1.5

m = 10/12 = 0.833

The parameters k and m are scale coefficients necessary to fix the lower limit value of the Index and the extension of the related Trophic Scale, i.e. from 0 to 10 TRIX units. Referring to the ChA and a DO% components, these factors are direct indicators of productivity, in terms of both the amount of phytoplankton biomass produced and the dynamic of that production, respectively. In other words, the TRIX Index summarises what the coastal system does (by including the contribution of the direct indicators of productivity, as “actual productivity”) and what the coastal system could do (contribution of the nutritional factors components, as “potential productivity”). As a result of the Log transformation of the four original variables, the annual distributions of TRIX over homogeneous coastal zones are usually of normal kind, and show a fairly stable variance, with STD around 0.9. As for the interpretation of TRIX values, those exceeding 6 TRIX units are generally associated to highly productive coastal waters, where the effects of eutrophication are represented by frequent episodes of anoxia in bottom waters. Values lower than 4 TRIX units are typical of scarcely productive waters, while values lower than 2 are generally associated to the open sea.

The TRIX index used for the assessment of trophic status of coastal waters has been applied in many European seas (Adriatic, Tyrrhenian, Baltic, Black Sea, and North Sea). However, all these waters are characterized by high nutrient levels and phytoplankton biomass; an index calibration based on systems that are principally eutrophic may introduce bias to the index scaling. In the work of Primpas and Karydis, 2011, the TRIX trophic index is evaluated using three standard sets of data characterizing oligotrophy, mesotrophy, and eutrophication in the Aegean (Eastern Mediterranean) marine environment. A natural eutrophication scale based on the TRIX index that is suitable to characterize trophic conditions in oligotrophic Mediterranean water bodies is proposed. This scale was developed into a five-grade water quality classification scheme describing different levels of eutrophication.

It is recommended also that the contracting parties rely on the classification scheme on chl-a concentration ($\mu\text{g/l}$) developed by MEDGIG as an assessment method easily applicable by all Mediterranean countries based on the indicative thresholds and reference values adopted therein (see Table 2).

4. Development of assessment thresholds and identifying reference conditions for eutrophication in order to be able to monitor the achievement of GES

Three approaches may be used for GES determination:

- a. In order to assess quantitatively the achievement of GES in relation to eutrophication, a measurable assessment threshold may be set, including the definition of reference conditions. GES assessment thresholds and reference conditions (background concentrations) may not be identical for all areas, especially where the marine environment is already disturbed by human presence for many years. In these cases a decision has to be made whether to set the threshold value for GES achievement independently to the setting of the reference conditions. The approach is based on the recognition that area-specific environmental conditions must define threshold values. A threshold value could include provisions to allow for statistical fluctuations (example: No nutrients and chl-a values exceeding the 90th percentile are present in a frequency more than statistically expected for the entire time series). GES could be defined on a sub-regional level, or on a sub-division of the sub-region (such as the Northern Adriatic), due to local specificities in relation to the trophic level and the morphology of the area.
- b. A second approach to determine GES for eutrophication is to use trends for nutrients contents, and direct and indirect effects of eutrophication. When using the trend approach, a reference value representing the actual situation is needed, for comparison. In the case of nutrients and chl-a, such reference values exist due to data availability in most areas. Therefore, GES could be defined as no increasing trends in nutrient and/or chlorophyll-a concentrations over a defined period of time in the past (ex. 6 years), which are not explained by hydrological variability. For indirect effects, GES could ask for no decreasing trend in oxygen saturation beyond what would be statistically expected.
- c. GES thresholds and trends are recommended to be used in a combined way, according to data availability and agreement on GES threshold levels. In the framework of UNEP/MAP MED POL there is experience with regard to using quantitative thresholds. It is proposed that for the Mediterranean region, quantitative thresholds between “good” (GES) and “moderate” (non GES) conditions for coastal waters could be based as appropriate on the work that is being carried out in the framework of the MED GIG intercalibration process of the EU Water Framework Directive (WFD), a project closely followed by the UNEP/MAP MED POL programme.

In this context regarding the definition of subregional thresholds for chlorophyll a water typology is very important for further development of classification schemes of a certain area. Within the MEDGIG exercise the recommended water types for applying eutrophication assessment is based on hydrological parameters characterizing a certain area dynamics and circulation. The typological approach is based on the introduction of a static stability parameter (derived from temperature and salinity values in the water column): such a parameter, on a robust numerical basis, can describe the dynamic behaviour of a coastal system.

On the basis of surface density and salinity values three major water types have been defined:

Table 1 Definition of major coastal types in the Mediterranean that have been intercalibrated (applicable for phytoplankton only) according to EU Commission Decision 2013/480/EU (results of the 2nd phase of MEDGIG exercise).

	Type I	Type IIA, IIA Adriatic	Type IIIW	Type IIIE	Type Island-W
σ_t (density)	<25	25<d<27	>27	>27	All range
salinity	<34.5	34.5<S<37.5	>37.5	>37.5	All range

The different water types, in an ecological perspective, can be described as follows:

- Type I coastal sites highly influenced by freshwater inputs
- Type IIA coastal sites moderately influenced not directly affected by freshwater inputs (Continent influence)
- Type IIIW continental coast, coastal sites not influenced/affected by freshwater inputs (Western Basin)
- Type IIIE not influenced by freshwater input (Eastern Basin)
- Type Island: coast (Western Basin)

In addition, the coastal water type III was split in two different sub basins, the Western and the Eastern Mediterranean ones, according to the different trophic conditions and is well documented in literature.

As suggested by the on line expert group on eutrophication established by the Contracting parties it is recommended that with regard to nutrient concentrations, until commonly agreed thresholds have been determined, negotiated and agreed upon at a sub regional or regional level, GES may be determined on a trend monitoring basis.

With regards to chlorophyll a, the on line Mediterranean eutrophication group recommend the reference and threshold values of the MEDGIG approach to be used for assessing ewutrophication status as presented in Table 2. (results of the 2nd phase of MEDGIG exercise)

Table 2: Reference and threshold values of Chla in Mediterranean coastal water types (according to Commission Decision of 20 September 2013 establishing, pursuant to Directive 2000/60/EC of the European Parliament and of the Council, the values of the Member State monitoring system classifications as a result of the intercalibration exercise and repealing Decision 2008/915/EC) .

Coastal waters Typology	Reference conditions of Chla ($\mu\text{g L}^{-1}$)		Boundaries of Chla ($\mu\text{g L}^{-1}$) for G/M status	
	G_mean	90% percentile	G_mean	90% percentile
Type I	1.40	3.93	6.30	17.7
Type II-FR-SP		1.90		3.60
Type II-A Adriatic	0.33	0.80	1.50	4.00
Type II-B Tyrrhenian	0.32	0.77	1.20	2.90
Type III-W Adriatic			0.64	1.70
Type III-W Tyrrhenian			0.48	1.17
Type III_W FR-SP		0.90		1.80
Type IIIE		0.10		0.40
Type Island-W		0.60		1.20

Note 1: The 90th percentile and the geometrical mean can be derived one from the other according to the following equation:

$$\text{Chl-a } 90^{\text{th}} \text{ p.} = 10^{\wedge}(\text{Log}_{10}(\text{G_mean Chl-a}) + 1.28 \times \text{SD}).$$

Note 2: The MEDGIG exercise phase III is in progress, therefore an update of the above table may occur, which will be considered, accordingly.

In conclusion it is recommended to rely on the classification scheme on chl-a concentration ($\mu\text{g/l}$) in coastal waters as a parameter easily applicable by all Mediterranean countries based on the indicative thresholds and reference values presented in table 2.

However following the evaluation of information provided by a number of countries and other available information it has to be noted that the Mediterranean countries are using different eutrophication assessment methods such as TRIX, Eutrophication scale, EI, HEAT, OSPAR etc. These tools are very important to continue to be used as appropriate at sub-regional or national levels because there is a long term experience within countries which can reveal / be used for assessing eutrophication trends.

Indicators Monitoring Fact Sheets on Ecological Objective 5 : Eutrophication
ECOLOGICAL OBJECTIVE 05: Human- induced eutrophication is prevented, especially adverse effects thereof, such as losses in biodiversity, ecosystem degradation, harmful algal blooms and oxygen deficiency in bottom waters

Common Indicator Description	Description of Parameters and/or Elements, matrix	Assessment Method	Guidelines Reference Methods QA/QC	Recommendations /Additional Data needed
<p>Common Indicator 7, COP18 Indicator 5.1.1 : Concentra-tion of key nutrients in the water column With Ecological Objective 5.1 : Human introduction of nutrients in the marine environment is not conducive to eutrophication Pressure Indicator</p>	<p>Total Nitrogen (N µmol/L), Nitrate (NO₃-N µmol/L)*, Ammonium (NH₄-N µmol/L)*, Nitrite (NO₂-N µmol/L)*, Orthophosphate (P-PO₄ µmol/L), Total Phosphorus*, Silicate (SiO₂ µmol/L)</p>	<p>UNEP/MAP MED POL State and Temporal Trend Monitoring Programme For coastal stations minimum sampling 4/year, 6-12 /year re-commended For open waters sampling frequency to be determined on a sub-regional level following a risk based approach</p>	<p>Guideline : Eutrophication Monitoring Strategy of UNEP/MAP MED POL UNEP(DEC) MED WG.231/14 Reference Methods : Sampling and Analysis Techniques for the Eutrophication Monitoring Strategy of UNEP/MAP MED POL (MAP Technical Reports Series No. 163) QA/QC : UNEP/MAP MED POL Inter-calibration exercises in agreement with QUASIMEME</p>	<p>*Units supporting the TRIX index, with Mediterranean sub-regional specifics</p>
<p>Common Indicator 7, COP18 Indicator 5.1.1 : Concentra-tion of key nutrients in the water column Proposed Sub-indicator</p>	<p>Si:N, N:P, Si:P</p>	<p>Nutrient monitoring under UNEP/MAP MED POL State and Temporal Trend Monitoring Programme For coastal stations minimum</p>	<p>Guideline : Eutrophication Monitoring Strategy of UNEP/MAP MED POL UNEP(DEC)MED WG.231/14 Reference Methods :</p>	

Common Indicator Description	Description of Parameters and/or Elements, matrix	Assessment Method	Guidelines Reference Methods QA/QC	Recommendations /Additional Data needed
(COP18 Indicator 5.1.2) Nutrient ratios (silica, nitrogen and phosphorus) where appropriate		sampling 4/year, 6-12 /year recommended Simple mathematical derivation of ratios of nutrient concentrations	Sampling and Analysis Techniques for the Eutrophication Monitoring Strategy of UNEP/MAP MED POL (MAP Technical Reports Series No. 163)	
Common Indicator 8, COP 18 Indicator 5.2.1 : Chlorophyll-a concentration in the water column With Ecological Objective 5.2 : Direct effects of nutrient over-enrichment are prevented State,Impact indicator	Chlorophyll –a concentration in seawater (µg/l)*	UNEP/MAP MED POL State and Temporal Trend Monitoring Programme For coastal stations minimum sampling 4/year, 6-12 /year recommended.	Guideline : Eutrophication Monitoring Strategy of UNEP/MAP MED POL UNEP(DEC)MED WG.231/14 Reference Methods : Sampling and Analysis Techniques for the Eutrophication Monitoring Strategy of UNEP/MAP MED POL (MAP Technical Reports Series No. 163) UNEP/MAP MED POL Inter-calibration exercises in agreement with QUASIMEME	*Unit supporting the TRIX index, with Mediterranean sub-regional specifics The indicative boundaries values for chlorophyll-a determined in the framework of MED GIG for the status classes required by the EU Water Framework Directive, namely between “good” and “moderate” status could be tested by non-EU Mediterranean countries to find out if they are relevant. Remote sensing techniques would be a useful tool for estimating chlorophyll concentrations. On a regional scale the remote sensing tool could be useful to identify emerging problem areas Pilot programmes are recommended to be carried out at the sub-regional scale to test the integration of remote sensing with in situ data

Common Indicator Description	Description of Parameters and/or Elements, matrix	Assessment Method	Guidelines Reference Methods QA/QC	Recommendations /Additional Data needed
<p>Common Indicator 8, COP 18 Indicator 5.2.1 : Chlorophyll-a concentration in the water column</p> <p>With Proposed Sub-Indicator of Water Transparency where relevant</p> <p>State,Impact Indicator</p>	<p>Water transparency measured as i.e.. Secchi depth or according to ISO 7027:1999 Water Quality- Determination of Turbidity</p>	<p>UNEP/MAP MED POL State and Temporal Trend Monitoring Programme</p>	<p>Guideline : Eutrophication Monitoring Strategy of UNEP/MAP MED POL UNEP(DEC)MED WG.231/14</p> <p>Reference Methods : Sampling and Analysis Techniques for the Eutrophication Monitoring Strategy of UNEP/MAP MED POL (MAP Technical Reports Series No. 163)</p> <p>ISO standard 7027:1999 Water quality -- Determination of turbidity</p>	
<p>Common Indicator 8, COP 18 Indicator 5.2.1 : Chlorophyll-a concentration in the water column</p> <p>With Proposed Sub-Indicator 5.3.1 : Dissolved oxygen near the bottom, i.e. changes due to increased organic matter decomposition and size of the area concerned</p> <p>Pressure,Impact indicator</p>	<p>Dissolved Oxygen concentration (mg/l) and Saturation (%)*</p>	<p>UNEP/MAP MED POL State and Temporal Trend Monitoring Programme</p>	<p>Guideline : Eutrophication Monitoring Strategy of UNEP/MAP MED POL UNEP(DEC)MED WG.231/14</p> <p>Reference Methods : Sampling and Analysis Techniques for the Eutrophication Monitoring Strategy of UNEP/MAP MED POL (MAP Technical Reports Series No. 163)</p>	<p>*Unit supporting the TRIX index as absolute % deviation form saturation, with Mediterranean specifics reflected on sub-regional level</p> <p>Daily variations of Dissolved Oxygen Profiles in the critical season along with T₀ and Salinity, performed through specific buoy applications</p>

Chapter II
Contaminant chapter and related fact sheet

II. MONITORING AND ASSESSMENT METHODOLOGICAL GUIDANCE ON EO9: CONTAMINANTS

1. Introduction

In most Mediterranean countries, the monitoring of concentrations of a range of chemical contaminants in water, sediments and biota is undertaken in response to the UNEP/MAP Barcelona Convention, its Land-Based Protocol, UNEP/MAP MED POL monitoring programmes, international (e.g. WFD) or national drivers. The scope and scale of this monitoring varies, but should be considered as a base from which to introduce a greater degree of harmonisation between Contracting Parties and to ensure that contaminants and matrices of importance within assessment sub regions are covered by appropriate monitoring programmes. Biological effects monitoring is generally less widely established in both national or international programmes, and the number of countries undertaking such studies (and the intensity of the coverage) is much smaller. Therefore, it will be essential in coming years to expand and develop further the use of biological effects methods to cover properly the EO9.

GES under Ecological Objective 09 is achieved when contaminants cause no significant impact on coastal and marine ecosystems and human health. As the type and quantities of emissions have changed and environmental legislation has led to reductions in pollution for certain substances and areas, the monitoring of contaminants needs to be adapted and focused to address present and upcoming risks that might affect the achievement of GES (GES). However coverage from current national programmes is limited. Therefore, for pragmatic reasons, initial assessments of GES under Ecological Objective 9 will probably be based upon data of a relatively small number of contaminants and biological effects, reflecting the scope of current programmes and the availability of suitable agreed assessment criteria. Important development areas over the next few years will include harmonisation of monitoring targets (determinands and matrices) within assessment sub-regions, development of suites of assessment criteria, integrated chemical and biological assessment methods, and review of the scope of the monitoring programmes to ensure that those contaminants which are considered to be important within each assessment area are included in monitoring programmes. Through these, and other, actions, it will be possible to develop targeted and effective monitoring programmes tailored to meet the needs and conditions within each assessment sub-region.

A considerable amount of monitoring data from the past decades is available through the pollution monitoring and assessment component of UNEP/MAP MED POL Programme under UNEP/MAP-Barcelona Convention. These data have been used e.g. for the identification of significant marine contaminants and the development of monitoring strategies and guidance. With respect to implementing the requirements of the Ecosystem Approach Process, there are considerable benefits to be gained from taking advantage of monitoring data and information developed through the UNEP/MAP MED POL Monitoring programme. Such actions include (1) the use of existing experience in the design of monitoring programmes, (2) the use of existing guidance on analytical etc. methods to inform technical aspects of ecosystem approach monitoring, (3) the use of existing sampling station networks as a framework for ecosystem approach sampling networks, (4) the use of existing statistical assessment tools and work on assessment criteria as the basis for assessments of ecosystem approach data, (5) the use of existing data to describe the distributions of contaminants and effects in the sea, and (6) the use of existing time series as the basis of monitoring against a “no deterioration” objective. The availability of quality assured data with confirmed quality is of importance for the assessment of trends in pollutant concentrations.

Monitoring the pressure deriving from chemical contaminants over time and space is a basic requirement for a quantitative assessment of the environmental status of the seas. Baseline assessments are necessary in order to monitor trends and prevent deterioration. Monitoring plans need to be proactive, not reactive and combined with risk assessments. Monitoring instruments and assessment criteria need to be sensitive and comparable.

While all Land Based Sources and Activities (**LBS**) Protocol substances should ideally be considered, their monitoring in the marine environment might not be performed for all, due to the absence of sources or the physicochemical characteristics of the substances. The availability of source information is crucial to the selection of substances for monitoring.

In view of the adoption in COP19 of the UNEP/MAP Barcelona Convention Offshore Protocol³ Action Plan, the development and adoption of Mediterranean monitoring procedures and programmes for offshore activities, is envisaged to take place in 2016 - 2017, building, inter alia, on the Integrated Monitoring and Assessment Programme of the EcAp.

Sampling a particular environmental compartment should be based on the anticipated pathway, fate and effect of each pollutant. Each compartment of the marine environment (water, sediments, biota) provides specific information about the pollution status, trends and sources of toxic substances.

The identification of pollution sources and how their associated inputs change over time is also fundamental to assess the effectiveness of the pollution mitigation strategies and to direct the further efforts needed to achieve GES. UNEP/MAP MED POL implements a periodic inventory of pollution sources and loads from land based activities, in the framework of the LBS Protocol and the Strategic Action Programme (SAP) to Address Pollution from Land-based Activities (adopted in 1997 and launched in 2000). The pollution sources database of UNEP/MAP MED POL holds 12,500 records of pollutants loads from industrial and municipal sources reported by the countries on a 5-year period (Data reported on 2003 and 2008). Each record indicates the emission of a substance for a given activity sector and sub-sector, in an administrative region and country. The database covers about 100 different substances or groups of substances and parameters according to national legislation and country development specificities. However a restricted number of substances are common to almost all national pollutant releases.

1. Monitoring Strategy for contaminants and effects (Applicable to all contaminants related indicators, ie Common Indicators 11-15)

1.1. The risk approach and precautionary principle

According to the risk approach monitoring needs to be carried out in coastal and marine areas where chemical contaminants have been found to represent significant risks to the marine ecosystems, and the data provided by the monitoring should serve the needs posed by the Ecosystem Approach process. Monitoring should allow the necessary statistical data treatments and long-term time-trend data analysis. Early warning of upcoming issues, such as emerging contaminants, should eventually become an integral part of the future monitoring systems.

The precautionary principle requires that, in doubt, protective measures should be implemented. In particular the marine environment is vulnerable due to possible accumulation of contaminants in the specific food chains and the irreversibility of impact on its ecosystems.

1.2. Selecting locations for environmental monitoring of contaminants and biological effects

The grid of monitoring stations will depend on the purpose of the specific campaigns. Most monitoring stations will be part of the UNEP/MAP MED POL monitoring schemes. It has been recognized that the open and deep sea is much less covered by monitoring efforts than coastal areas.

³ The Protocol for the Protection of the Mediterranean Sea against Pollution from the Exploration and Exploitation of the Continental Shelf and the Seabed and its Subsoil (Offshore Protocol). The Protocol entered into force on 24 March, 2011 and according to the Offshore Action Plan Contracting Parties that have not already done so should endeavor to ratify the Protocol by 2017.

There is a need to include within monitoring programmes also areas beyond the coastal areas in a representative and efficient way, where risks warrant coverage.

A joint strategy for monitoring should include master stations, distributed spatial spread and other approaches, such as transect sampling, if applicable.

The selection of sites for the monitoring of contaminants and biological effects in the marine environment is a direct function of the assessment of risks and the monitoring scope:

- Areas of concern identified on the basis of the review of the existing information and linked to UNEP/MAP MED POL and WFD assessments.
- Areas of known past and/or present release of chemical contaminants.
- Offshore areas where risk warrants coverage (aquaculture, offshore oil and gas activity, dredging, mining, dumping at sea...).
- Sites representative in monitoring of other sea-based (shipping) and atmospheric sources.
- Reference sites: For reference values and background concentrations.
- Representative sensitive pollution sites/areas at sub regional scale.
- Deep-sea sites/areas of potential particular concern

The selected sites should allow the collection of a realistic number of samples (e.g. be suitable for sediment sampling, allow sampling a sufficient number of biota for the selected species during the duration of the programme). Modelling tools can provide information for the best placement of monitoring stations with respect to ocean currents and input pathways.

Contracting Parties should provide their proposed sampling locations and the reasons for monitoring. It is essential that the monitoring strategies are being coordinated at regional and/or sub regional level. Coordination with monitoring for other Ecological Objectives is crucial for cost-effective approaches. The organization of cruises as a joint effort from different Contracting Parties might be an effective option.

1.3 Geographic scale of monitoring and assessment

The geographic scale of monitoring for the assessment of GES for contaminants and their effects depends on the specific conditions of an area that may influence the background concentration of contaminants, including local mineralogy, inputs from rivers, hydrodynamic conditions, sediment texture, etc. A risk based approach should be used in order to follow a screening procedure to decide the areas to be assessed and monitored more frequently.

The areas where greater pollution pressure occurs could be divided into smaller areas for assessment purposes and could be monitored more frequently than remote and non-affected marine waters.

Monitoring for the assessment of GES for totally anthropogenic contaminants such as organochlorine compounds, could be carried out on a regional scale, since the background concentration for these contaminants is zero. However, local specificities in the production and use of these compounds (pesticides and industrial compounds) have created a difference between the sub-regions that has to be considered.

Furthermore, although coastal levels of pollutants are mainly influenced by local processes (river runoff, coastal hot spots), open-sea biota and sediments are mainly influenced by regional or even super-regional pathways (atmospheric transport and deposition of pollutants emitted from remote areas). The latter is also true for PAHs.

Based on the above, it could be appropriate to consider monitoring for assessing a regional GES threshold for open sea and a different one for coastal zones.

For naturally occurring contaminants such as heavy metals in addition to the previous remarks, as local mineralogy plays an important role in the definition of the GES threshold, since metal deposits are present in different Mediterranean locations, monitoring for the assessment of GES for heavy metals may need to be carried out on a subdivision of the sub-region according to local characteristics.

For contaminants biological effects and occurrence of oil spills, monitoring for the assessment of GES could be carried out on sub-regional or even regional level, provided appropriate information is available.

Also, for pathogenic microorganisms in bathing water, monitoring for the assessment of GES could be carried out on a sub-regional or even local level due to the nature of microbiological contamination (the impact is restricted to a relatively short distance from the pollution source due to the short survival time of microorganisms in seawater).

1.4 Monitoring frequency

Monitoring frequencies will be determined by the purpose of the sampling effort. They can range from shorter time scales for seasonally variable input, to large time scales for sediment core monitoring. For trend determination the timescales will depend on the ability to detect trends considering the variability in the whole analytical process and the number of replicates. It can be possible to decrease the monitoring frequency in cases where established time series show concentrations well below levels of concern, and without any upward trend over a number of years. For multiannual parameters, opportunities for joint organization between Contracting Parties and between or within Regional Seas Conventions should be considered.

3. Development of assessment criteria for the definition of threshold limit values for chemical environmental status monitoring of contaminants in order to be able to determine the achievement of GES.

Report UNEP(DEPI)MED WG.394/Inf.3 on the development of assessment criteria for hazardous substances in the Mediterranean presents a methodology to develop assessment criteria for the definition of threshold limit values for contaminants, in order to assess the achievement of GES in the Mediterranean marine environment in relation to the Ecological Objective EO9, in the framework of the gradual application of the ecosystem approach for the management of human activities in the Mediterranean, by MAP.

The report follows a relevant methodology developed by OSPAR, which proposes two threshold limits to be defined in sediments and biota: T0 to define the threshold at “pristine” sites and T1 to define the threshold between acceptable (GES) and unacceptable environmental conditions.

Using Mediterranean data from the UNEP/MAP MED POL database and applying the OSPAR methodology, the report presents an evaluation of the background concentrations (BCs) and the background assessment concentrations (BACs)⁴ of trace metals (mercury, cadmium and lead) and organic contaminants (chlorinated hydrocarbons and PAHs) in sediments and biota in the Mediterranean basin.

Regarding the definition of BACs in Mediterranean sediments, the report states that it should be noted that limited data was available and therefore more dated sediment cores from different areas are needed in order to increase the confidence of the proposed values. Additionally, in order to further test

⁴ Background assessment concentrations” (BACs) are statistical tools defined in relation to the background concentrations (BCs), which enable statistical testing of whether observed concentrations can be considered to be near background concentrations. Observed concentrations are said to be ‘near background’ if the mean concentration is statistically significantly below the corresponding BAC

if normalization is convenient for sediment particle variability, aluminum (Al) and organic carbon (OC) should be considered as mandatory parameters in the new MAP integrated monitoring programme. There are already evidences from certain regions of the NW Mediterranean where it is well demonstrated that normalization is not convenient as these environmental factors are not well correlated with contaminant concentrations (León et al. et al, 2014). It will be also necessary to further investigate sub regional differences on sedimentation rate and geochemistry of the sediments.

In order to define the relationship between BC and BAC, the report states that a statistical test is required, taking into consideration the data variability of reported data on Certified Reference Materials (sediment and biota) used by Mediterranean laboratories in proficiency tests and in inter-calibration exercises. At this stage a statistical test, as described in the text of the report, on the UNEP/MAP MED POL monitoring programme is not yet available. Alternatively the report states that OSPAR defined relationships between BC and BAC for metals in sediments, fish and shellfish to assess the BACs levels could be adopted. Thus, for sediments and shellfish $BAC = 1.5 \times BC$, for fish $BAC = 2 \times BC$. However, that report states that it is recommended to perform a statistical test to evaluate the precision of UNEP/MAP MED POL monitoring programmes (on a country basis).

Furthermore, the report states that considering the statistical evaluation of the UNEP/MAP MED POL database performed in the report, and the large variability in the concentration levels, it is essential to perform a quality control examination of the datasets in order to better assess BAC values.

As regards the definition of Mediterranean Assessment Criteria for biota using the UNEP/MAP MED POL database, the report underlines that it is biologically inappropriate to evaluate absolute BC, BAC and Environmental Assessment Criteria (EAC) metal levels in one species from the parallel levels of even a close relative species. Therefore, BCs and BACs levels were calculated / assessed in the report generally according to OSPAR procedures.

The report states that in OSPAR assessments, some EACs have not been used mainly because they are less than the OSPAR BACs. The EACs for Cd and Pb in sediment, Hg in mussels and Hg and Cd in fish are below the corresponding BACs. In addition, the BCs and BACs for trace metals in sediments are normalized to 5% aluminum whilst proposed EACs are normalised to 1% organic carbon. It has been concluded by OSPAR that EACs for PAHs or trace metals in sediment and for metals or CBs in biota cannot be used to describe the threshold (T1) between acceptable (GES) and unacceptable environmental conditions. Therefore, in cases where the EACs have not been recommended, alternative approaches to appropriate criteria for the assessment of data on contaminant concentrations in sediment and biota were applied (as shown in Table 9.1.):

- For the Transition (T0) which represents an assessment that concentrations should be at, or close to, background concentrations, BACs are used by OSPAR.
- For the Transitions (T1), the assessment criteria were the ERLs (Effects Range Low⁵) for PAHs and trace metals in sediment.
- It is a demanding task to determine real EAC levels, generally and also according to OSPAR documents. Therefore, until an appropriate approach becomes available for the assessment criteria for metals in biota, the EC maximum acceptable dietary levels

⁵ Effects range low (ERL) and effects range median (ERM) are specific chemical concentrations that are derived from compiled biological toxicity assays and synoptic sampling of marine sediment. These numerical values are sediment quality guidelines that were developed by Long and Morgan for the National Oceanic and Atmospheric Administration's (NOAA) National Status & Trends programme as informal tools in screening sediment. ERL and ERM are considered guidelines to help categorize the range of concentrations in sediment at which effects are scarcely observed or predicted (below the ERL) and the range above which effects are generally or always observed (above the ERM). These guidelines are used for screening sediments for trace metals and organic contaminants

(Commission Regulation (EC) No 1881/2006) were used by OSPAR (QSR 2010 assessment).

In addition, it has to be noted that there are experiences in the Mediterranean according to which ERL has been adopted as threshold for T1 as it was not possible to normalize for TOC in sediment due to low TOC content.

Table 3. Transition points for assessing contaminants in sediments and biota applied by OSPAR (OSPAR 2009).

Contaminant	Transition Point	Sediment	Biota
Hg, Cd, Pb	T0	BAC	BAC
Hg, Cd, Pb	T1	ERL	EC
PAHs	T0	BAC	BAC
PAHs	T1	ERL	EAC
PCBs (individual congeners)	T0	BAC	BAC
PCBs (individual congeners)	T1	EAC	EAC
Σ7CBs ICES	To	BAC	-
Σ7CBs ICES	T1	ERL	-
Lindane	To	BAC	BAC
Lindane	T1	ERL	EAC
HCB	To	BAC	BAC
HCB	T1	ERL	-
pp-DDE	T0	BAC	BAC
pp-DDE	T1	ERL	
α-HCH	T0	-	BAC
α-HCH	T1	ERL	-
Dieldrin	T0	BAC	-
Dieldrin	T1	ERL	

3.1. **Forward procedure for monitoring the achievement of GES for contaminants in the Mediterranean marine environment.**

The recommendations and information presented in the report are proposed to be followed up/utilized to establish a forward procedure for monitoring the achievement of GES for contaminants. This inter alia would imply further work in separate Contracting Party allocated expert groups, particularly for updating the current BACs and setting EACs for contaminants in biota on a sub-regional level.

Until EACs are defined for the major substances of concern, a two-fold approach could be adopted to support monitoring for the assessment of GES: i) a threshold value for GES (BAC) could be set using concentrations from relatively unpolluted areas on a sub-regional level and ii) a decreasing trend should be observed from values representing the actual level of contaminants concentrations that are above the background assess concentrations (BACs).. Thus, GES could be defined for toxic metals (Hg, Cd, Pb), chlorinated organic compounds and PAHs, for which monitoring data exist as a result of running monitoring programmes.

Temporal trend monitoring

Marine monitoring implies the repetitive observing for defined purposes, of one or more elements of the marine environment, according to prearranged spatial and temporal schedules using comparable methodologies. The temporal trend monitoring starts with the objective to detect trends in concentrations with the aim of monitoring the effectiveness of control measures taken at polluted sites. Trends in pollutant or contaminant levels, in general, are also considered as “state” indicators of pollution and are included in most of the regional monitoring programmes to provide inputs to the assessments of the state of the marine environment.

Surface sediments and biota can be used for recognizing possible temporal trends of trace metals, organochlorine compounds, PAHS, and those that are accumulated in these matrices in the marine environment and, thus, can be an important tool for the assessment of the effectiveness of control measures taken at the polluted sites and also for state assessment. However, data variability can be influenced by several factors other than contaminant inputs, namely those associated with sampling and the representativeness of the collected samples. In any case, the first requirement is the availability of data series long enough, so that long-term monitoring programmes are maintained in time.

In the 2005 review and analysis of UNEP/MAP MED POL Phase III Monitoring Activities (UNEP (DEC)/MED WG 282/3) consisting of an evaluation of the UNEP/MAP MED POL database for the trend monitoring of contaminants it was concluded that the UNEP/MAP MED POL Phase III programme objectives preliminarily set, were not sufficient to achieve the temporal trend of any selected contaminant for a selected site. The major reason for this was the various difficulties in data analysis, especially when normalization was intended for reducing the variance of the data set by taking into account the differences in morphology (e.g. sediment grain size) or composition (e.g. tissue fat content) of the samples. Both the selected trace metals and the organic contaminants will co-vary strongly with such factors⁶.

A second aspect to be considered is the time span necessary for trends assessment.

In general, the first temporal trend evaluation using sessile marine organisms can be performed with data sets of more than five years ongoing programmes. The use of sediments still require a longer time span (>10yr) for evidencing and assessing significant variations. However, after ten years of the monitoring programme, certain countries still did not have valid and continuous data covering at least five years.

The 2011 analysis of the trend monitoring activities and data for UNEP/MAP MED POL Phase III and IV (UNEP (DEPI) MED365/Inf.5) concluded that though substantially improved after the last trend data evaluation in 2009, some problems were identified mainly dealing with the lack of maintaining the declared sampling strategy. The weakest part of the programme remains the data transfer and manipulation. To overcome these problems, the report states that involved countries are encouraged to write a detailed programme manual where all issues regarding a successful programme achievement would be addressed. Such a manual would include the programme objectives and a detailed methodological approach to successfully maintain the programme over time (positioning, sampling, methods, and data elaboration, exchange and presentation).

From the trend monitoring point of view the report states that the best sampling strategy always leads with attaining the best information on the sampling variance and with that a valuable determination of the underlying trend. While it is advisable to avoid pooling whenever possible, the suggested strategy for smaller organisms, mainly molluscs that are not always sufficient for all analyses, is to use 3-5 samples with 15 pooled specimens or in any case a number of pooled specimens that guarantees the necessary amount of sample to conduct all the chemical analyses. If one sampled organism, mainly

⁶ A revised manual for sediment sampling and analysis was adopted in 2006 (UNEP (DEC) MED WG.282/Inf.5/Rev.1.)

fish, provides enough sample for all analyses the use of from 15 to 25 (preferred) samples is suggested if the underlying variances are not known. The sample should be collected in a length stratified manner: divide the size distribution in three or five classes (log scale and depending on size: MG -1 cm; MB - 2 cm.) and sample the central one; the same size class should always be sampled.

4. Monitoring Biological Effects

Biological effects monitoring is considered as an important element in programmes which aim to assess the quality of the marine environment, since such monitoring aims to demonstrate links between contaminants and ecological responses. Biological effects monitoring can thus be used with the intention to indicate the presence of substances, or combinations of substances, not previously identified as being of concern and to identify regions of decreased environmental quality.

Biomarkers include a variety of measures of specific molecular, cellular and physiological responses of key species to contaminant exposure. A response is generally indicative of either contaminant exposure or compromised physiological fitness. The challenge is to integrate individual biomarker responses into a set of tools and indices capable of detecting and monitoring the degradation in health of a particular type of sentinel organism.

The use of biomarkers is relatively new when compared to traditional chemical monitoring. Even today those biomarkers which are considered well understood often still lack historic track records and simple data management adequate for routine risk assessment and monitoring. Some results were produced in the last twenty years through individual research projects national or international programmes in marine waters (BIOMAR, BEEP, IOC-IMO UNEP funded programme of Global Investigation of Pollution of the Marine Environment). Despite the important principle underlying the biomarker concept, that is, response should lead to ecological effects, there are still few examples where biomarker measurements have been directly linked to community level responses. However, many examples revealing environmental problems, that is, acting as warning signals of potential future problems, have been demonstrated in the past decades (Demetrio et al., 2003; Martínez-Gómez et al., 2010; Fernández et al., 2011)..

Biological effects monitoring should be coordinated with the monitoring of chemical contaminants in a cost-effective manner, conducting field sampling, whenever possible, within the same time-frame.

The integrated assessment (biological effect and chemical measurements) should comprise only a limited number of stations including at least:

- Reference sites: For reference values and background concentrations
- Areas of concern identified on the basis of the review of the existing information linked to MED POL, WFD and MSFD assessments
- Representative sensitive pollution sites/areas at subregional scale

Strategy for sampling and analysis should include, whenever possible:

- Sampling and analyses of the same tissues and individual/populations than chemical monitoring
- Sampling of individuals for biological effects from the same site/area as that used for chemical analyses at a common time
- Sampling sediments at the same time and location as collecting biota (i.e. fish)

For all stations, biometrics (size/length, age), biological supporting parameters such as condition index (mussels), condition factor, gonadosomatic index, hepatosomatic index (fish) and data on temperature, salinity and oxygen dissolved of the ambient water should be also registered.

For an integrated biomarker data management, an Expert System has been developed at the University of Piemonte Orientale, Italy (**DiSAV**) in the framework of the **BEEP** (Biological Effects of Environmental Pollutants) EU programme. The function of the Expert System is to rank the level of the pollutant-induced stress syndrome by integrating the data obtained from:

- Early warning biomarkers: i.e. sensitive biomarkers of stress, or of exposure, revealing the effects of pollutants at the molecular and/or cellular level.
- Biomarkers of stress, suitable to reveal the development of the stress syndrome at the tissue/organ level: i.e. histological biomarkers, but also biochemical biomarkers such as the GST (Glutathione Transferase) test recently developed (i.e. evaluation of the GST released from the cells and present in molluscan haemolymph).
- Biomarkers of stress at the organism level: i.e. biomarkers able to show that the stress syndrome has decreased the mussel's capacity of survival and/or growth and reproduction (such as stress on stress response, scope for growth, gonad and gamete alterations, survival index).

A good interpretation of the development of the stress syndrome by the expert system depends on the possibility to utilize control samples for each assessment and biomarkers of stress able to integrate the toxic effects of pollutants over a sufficient caging period. Among these, are those biomarkers that show a trend characterized by a continuous increase or decrease in the value of the selected parameter (such as lysosomal membrane stability, lysosomal lipofuscin accumulation, lysosomal neutral lipid accumulation, micronuclei frequency) in relation to an increase in toxicity. Moreover, the expert system takes into account possible interferences among the different biomarkers. However, the representation of the assessment does not maintain all of the supporting information, and it is not easy to identify the causative determinands that may be responsible for the final result on the level of stress syndrome. In addition, different stages of the assessment cannot be readily unpacked to a previous stage to identify either contaminant or effects measurements of potential concern or sites contributing to poor regional assessments.

Besides of expert system, different indexes have being developed to assess contaminant-related biological responses by combining results from different biomarkers such as Integrated Biomarker Response (IBR) (Belaieff and Burgeot, 2002), the Health Assessment Index (HAI) (Adams et al., 1993), the Bioeffect Assessment index (Broeg at al., 2005), and the Integrative Biomarker Index (Marigómez et al., 2013). Furthermore, different models are becoming available in the Mediterranean region to elaborate various typologies of data with the 5 classes approach, and to aggregate them in a final evaluation, still based on the 5 classes discrimination (Benedetti et al., 2012).

Molluscs (mainly mussels, *Mytilus* sp.) and fish (*Mullus* sp., *Platichthys flesus* L., *Zoarces viviparus*, *Perca* sp.) from natural populations have both been widely employed as sentinel organisms in routine biomonitoring programmes, both at a national and an international level (UNEP/MAP UNEP/MAP MED POL Biomonitoring Programme; OSPAR Convention, RAMOGE, etc.), although some subregional and national research projects have also been conducted in the past years using caged mussels (RINBIO; MYTILOS, MYTIMED Project, etc). Exposure periods lasting several months are generally required to assess bioaccumulation of most persistent organic contaminants and to reveal more subtle chronic effects on organisms. Although caged mussel can be used to assess certain early biological effect responses, they cannot substitute the pollution biomonitoring programmes based on the sampling of mussels from natural populations. As the experience have demonstrated, the use of caged mussels for large-scale biomonitoring programmes involves a higher-cost monitoring strategy

than the use of mussels from natural populations because at least, two field sampling campaigns have to be organised, and recovery of the cages is not guaranteed. The use of caged mussels for effect monitoring can however be useful in short-term exploratory environmental studies, e.g. around hot spots.

While the use of fish in biological effects monitoring programmes, building on the key position of these organisms in the trophic chain and their high commercial value is well established, their usage already in the initial stage of the monitoring programme on a regional level would present some problems, including the difficulties encountered in caging experiments with fish as well as more importantly the cost of sampling, caging, transportation. However, field sampling to assess contaminants levels in fish tissues could be integrated and coordinated with sampling of other fish tissues (liver, blood, gonads, brain, etc) to implement in future the use of biological effects in fish from natural populations instead of caging fish. Their inclusion in the integrated monitoring programme thus is not foreseen in the initial phase, but could be envisioned afterwards..

Molluscs have been taken as the bioindicators of choice on the basis of their wide geographic distribution, their straightforward availability in the field and through aquaculture, and their suitability for caging experiments along coastlines. In the framework of UNEP/MAP MED POL Phase IV, it was decided to apply a 2-tier approach, using caged molluscs:

- the first tier would include a single biomarker, namely, lysosomal membrane stability, and mortality;
- the second tier would include a whole set of biomarkers including acetyl cholinesterase activity, micronuclei frequencies, lipofuscin accumulation, neutral lipid accumulation, , oxidative stress, metallothionein content, peroxisome proliferation, lysosome to cytoplasm ratio, and stress on stress.

An intercalibration exercise financed by UNEP/MAP MED POL was organised in 2010 by DiSAV with the participation of 11 Mediterranean laboratories from 8 countries (Croatia, Egypt, Greece, Italy, Slovenia, Spain, Syria and Tunisia) and 3 non-Mediterranean laboratories (Norway and UK, from the OSPAR region). The results of the intercalibration exercise showed excellent performance of all laboratories for the measurement of lysosome membrane stability and very good performance for the measurement of metallothionein content. Also a Training course on the measurement of two biomarkers (lysosome membrane stability and micronuclei frequency) was organised in Alessandria, Italy by DiSAV in 2010, with the participation of 15 scientists from 10 countries (Algeria, Croatia, Egypt, Greece, Italy, Morocco, Slovenia, Spain, Tunisia, Turkey) and with the contribution of scientists from ICES-OSPAR (UK).

Based on the work already carried out, the results of the intercalibration exercises and the publication of relevant papers by Mediterranean scientists involved in the UNEP/MAP MED POL programme on biological effects monitoring, there is a network of laboratories in the Mediterranean region with the capacity to carry out biomonitoring activities, in line with the new monitoring requirements to be defined in the framework of the Ecosystem Approach for the management of human activities in the Mediterranean.

Of the second tier biomarkers proposed, only the micronuclei frequency biomarker is able to indicate the presence of genotoxic chemicals in the environment, especially *in sites heavily polluted by polycyclic aromatic hydrocarbons, and in organisms that may also be considered as seafood*. With growing concern over the presence of genotoxins in the sea, the application of cytogenetic assays to ecologically relevant species offers the chance to perform early tests on health in relation to exposure to contaminants. Acetylcholinesterase activity is a cost effective biomarker of neurotoxic effects of pollutants, especially pesticides, applicable with instrumentation available in the Contracting Party laboratories. Its responsiveness has been demonstrated also to various other groups of chemicals present in the marine environment, including heavy metals, and hydrocarbons. Laboratory and field studies have demonstrated the applicability of anoxic/aerial survival as an early warning indicator of

contaminant-induced stress. The reduction of survival in air, or stress on stress (SoS), is a simple, low-cost, whole-organism response and can show pollutant-induced alterations in an organism's physiology that render the animal more sensitive to further environmental changes. Bivalve molluscs can survive for a long time in air, but individuals stressed by pre-exposure to pollutants show greater mortality than controls or individuals collected from a reference location. The method for determining SoS in mussels has been applied routinely to both toxicant-exposed mussels in laboratory studies and mussels collected in national monitoring programmes from polluted environments and along pollution gradients. Taking into account the number of samples to be analyzed and available facilities in the Contracting Party laboratories, the best number of further to these biomarkers to be gradually introduced into the biological effects monitoring programme could be determined.

While recognizing that contaminant-specific techniques that cannot guarantee that measuring responses within marine organisms from natural populations are caused to the exposure of single specific contaminants, the most widely used specific technique is the measurement of TBT effects (imposex) on gastropods, where a cause and effect relationship has been established. There is a possibility to use available information for TBT thresholds for GES from other regions (Davies and Vethaak, 2012) in order to propose similar effects thresholds for the Mediterranean.

In general the monitoring of contaminant-related biological effects should be coordinated with the monitoring of chemical contaminants in a cost-effective manner, conducting field sampling, whenever possible, within the same time-frame.

4.1. Assessing Biological Effects

In a similar manner to contaminant concentrations, ICES/OSPAR has proposed two/three categories to assess the biological effects observed, by using two assessment criteria: BAC and EAC (Davies et al., 2012). Assessing biomarker responses against BAC and EAC allows establishing if the responses measured are at levels that are not causing deleterious biological effects, at levels where deleterious biological effects are possible or at levels where deleterious biological effects are likely in the long-term. In the case of biomarkers of exposure, only BAC can be estimated, whereas for biomarkers of effects both BAC and EAC can be established. However, unlike contaminant concentrations in environmental matrices, biological responses cannot be assessed against guideline values without consideration of factors such as species, gender, maturation status, season and temperature.

It is expected that in the forthcoming years, the scope of experts groups would be to prepare an adapted manual establishing the BAC and when possible, the formulation of EAC for selected biomarkers in Mediterranean species.

One of the challenges in assessing the health status of organisms using assessment criteria is precisely the strategy by which to integrate the multivariate results obtained. The approach recently developed by ICES was based on an assessment of single responses by assessment criteria, then scoring them in a multi-step process to arrive at a final risk assessment (Davies and Vethaak, 2012).

5. Monitoring acute pollution events for the quantification of acute chemical spills, specifically of oil and its products, but not excluding others (Common Indicator 13 Occurrence, origin and where possible extent of acute pollution events)

The UNEP/MAP-Barcelona Convention and its Prevention and Emergency Protocol aim at the protection of the environment against oil and chemical spills with a coherent coverage and equal level of protection for the entire Mediterranean Sea.. The Regional Marine Pollution Emergency Response Centre for the Mediterranean Sea (**REMPEC**) is responsible for the prevention of, preparedness for and response to marine pollution. In this regard, the Centre's database on alerts and accidents in the

Mediterranean Sea contains data on accidents causing or likely to cause pollution of the sea by oil (since 1977) and by other harmful substances (since 1989).⁷

While there should be no overlap or double work with existing provisions, the guidance on integrated monitoring should here ensure that all aspects are being covered under the various frameworks, that monitoring information is exchanged between the networks and that potential for a cost effective integrated monitoring is used.

The operational objective contains two different criteria:

- Occurrence, origin, extent.
- Impact on biota physically affected.
- Monitoring efforts can therefore use the following methods for quantification:
- Quantification of oil and other chemical spills and their size by observation and reporting.
- Satellite radar images, plane observation and imaging approaches.
- Backtracking of oil spills to their source by hind cast modelling.
- Fingerprinting using chemical analysis (GC-MS) and comparison with possible sources.

The organizational framework under which the monitoring of oil and other chemical spills is being dealt with under the UNEP/MAP Barcelona Convention is REMPEC. Mediterranean coastal States, contracting Parties to the 2002 Prevention and Emergency Protocol to the UNEP/MAP Barcelona Convention, committed themselves (Article 9 of the Prevention and Emergency Protocol) to inform each other, either directly or through the Regional Centre (i.e. REMPEC) on:

- all accidents causing or likely to cause pollution of the sea by oil and other harmful substances
- the presence, characteristics and extent of spillages of oil or other harmful substances observed at sea which are likely to present a serious and imminent threat to the marine environment or to the coast or related interests of one or more of the Parties;
- their assessments and any pollution combating actions taken or envisaged to be taken
- the evolution of the situation.

In relation to their obligations under the abovementioned Article 9 of the Prevention and Emergency Protocol, at their Fifth Ordinary Meeting, the Contracting Parties to the UNEP/MAP Barcelona Convention adopted the Guidelines For Co-operation In Combating Marine Oil Pollution In The Mediterranean (UNEP/IG.74/5, UNEP/MAP, 1987) which recommend Parties to report to REMPEC at least all spillages or discharges of oil in excess of 100 cubic metres.⁸

Article 18 of the UNEP/MAP Barcelona Convention Protocol for the Protection of the Mediterranean Sea against Pollution Resulting from Exploration and Exploitation of the Continental Shelf and the Seabed and its Subsoil, states that in cases of emergency the Contracting Parties shall implement *mutatis mutandis* the provisions of the Emergency Protocol.

While Contracting Parties are under the obligation for the above monitoring, data submitted to REMPEC is still scarce. Thus the main aim during the Initial Phase of the Integrated Monitoring is to strengthen monitoring efforts towards this already existing obligation.

At the same time, for the further development of the Integrated Monitoring and Assessment Programme, it is recommended to analyse closer the links in between acute pollution events and their

⁸ . <http://www.rempec.org/admin/store/wyswigImg/file/News/Forthcoming%20Meetings/MEDEXPOL2013/E-%20Reference%20Documents/E-%20REMPEC%20-%20Guidelines%20for%20co-operation%20in%20combating%20marine%20poll%20in%20the%20med.pdf>

effects on biota and develop specific assessment criteria for this latter (see Martínez-Gómez et al., 2010).

6. Monitoring of contaminants in fish and other seafood used for human consumption (Common Indicator 14 Actual levels of contaminants that have been detected and number of contaminants which have exceeded maximum regulatory levels in commonly consumed seafood)

Substances to be monitored

Monitoring of contaminants in biota used for human consumption only measures contaminants in fish and other seafood for which regulatory limits have been set in national and international regulations for public health reasons⁹. The significance of an increase for specific contaminants in the marine environment through trend analysis should be regarded as an important element for inclusion in seafood monitoring. Similarly, when results from monitoring of contaminants in the marine environment indicate a very low likelihood for elevated levels in fish and seafood for human consumption, additional monitoring on these commodities is not justified.

Monitoring should at least consider the following contaminants for which regulatory levels have been laid down: Heavy metals (lead, cadmium, and mercury), polycyclic aromatic hydrocarbons, dioxins (including dioxin-like PCBs). Additionally, further contaminants of relevance should be identified.

Species

The selection of the species to be used for monitoring should consider the following criteria:

- Species more prone to biomagnify/bio-accumulate specific classes of contaminants
- Species representative of the different trophic levels or habitats
- Species representative for entire (sub) region
- Species representing consumer habits

Moreover, in order to make monitoring results more comparable between (sub) regions, it would be advisable to select a limited number of target species from the most consumed species of fish and other seafood.

Sample collection

Only unprocessed products should be sampled for this purpose. A key element will be to analyse seafood in the sea from known locations. The monitoring of contaminants in seafood is executed by the responsible authorities in charge, which often are different from the authorities implementing the EcAp and its associated monitoring. Here, cooperation with authorities and environmental institutions in charge of health monitoring is strongly encouraged. Topics for coordination are:

- Providing information on the origin of the samples: Sampling of fish and seafood at retail stage shall only be done when all necessary conditions (e.g. avoid cross contamination, traceability to (sub) region) can be guaranteed
- Exploring synergies in the monitoring of marine top predators
- Exchanging information on data, approaches and methodologies between environmental monitoring institutions and human health risk related monitoring institutions

⁹ A list of maximum levels for contaminants in foods set by the FAO/WHO Codex Alimentarius Commission can be found at ftp://ftp.fao.org/codex/Meetings/cccf/cccf7/cf07_INFe.pdf

7. Monitoring microbiological pollution (Common Indicator 15: Percentage of intestinal enterococci concentration measurements within established standards)

Taking into consideration that the Mediterranean Sea continues to attract every year an ever increasing number of international and local tourists that among their activities use the sea for recreational purposes, the issue of monitoring for potential microbiological pollution is of particular importance. Although the general situation has improved considerably in several parts of the region through the establishment of sewage treatment plants and the construction of submarine outfall structures, the matter is still of major concern in a number of areas and the quality of recreational waters needs regular monitoring.

Revised Mediterranean guidelines for bathing waters were formulated in 2007 based on the WHO guidelines for “Safe Recreational Water Environments” and on the EC Directive for “Bathing Waters”. The proposal was made in an effort to provide updated criteria and standards that can be used in the Mediterranean countries and to harmonize their legislation in order to provide homogenous data.

The values agreed for the Mediterranean region in COP 17 (Decision IG.20/9 Criteria and Standards for bathing waters quality in the framework of the implementation of Article 7 of the LBS Protocol, (UNEP/MAP, 2012) are presented in Table 4 and could be used to define GES for the indicator on pathogens in bathing waters.

By definition monitoring for the assessment of GES for bathing waters is expected to be close to the shore, but the threshold is valid on a regional level. Therefore, the category A or B values could be defined as a GES threshold for intestinal enterococci in bathing waters in the Mediterranean.

Table 4. Water quality criteria for intestinal enterococci in bathing water

Category	A	B	C	D
Limit values	<100*	101-200*	Up to 185**	>185**(1)
Water quality	Excellent quality	Good quality	Sufficient	Poor quality/ Immediate Action

* 95th percentile intestinal enterococci/100 mL (applying the formula 95th Percentile = antilog ($\mu + 1,65 \sigma$))

** 90th percentile intestinal enterococci/100 mL (90th Percentile=antilog ($\mu + 1,282 \sigma$), μ =calculated arithmetic mean of the log10 values; σ = calculated standard deviation of the log10 values.

8. Quality Assurance and Quality Control of contaminants monitoring

The accuracy and comparability of the data collected is a key requirement for the assessment and description of environmental status and for the assessment of anthropogenic influences and required measures. Quality assurance (QA) and quality control (QC) measures ensure that monitoring results of stated quality are obtained across the Mediterranean Region and at any time.

Much effort has been made by the MAP Secretariat so that the Contracting Parties would be in a position to generate accurate data on marine contaminants. UNEP/MAP MED POL will continue to collaborate with the International Atomic Energy Agency and the specific Marine Environmental Studies Laboratory (**MESL**), based in Monaco.

The MESL produces Certified Reference Materials (for trace elements and organic compounds in sediment and marine biota) and develops fit-for purpose Recommended Analytical Methods for the analysis of contaminants in marine samples. Also, in collaboration with Regional Organisations and national authorities, MESL organises Proficiency Tests and Training Courses on the analysis of contaminants of concern.

9. Reference methods and guidelines for marine pollution monitoring under UNEP/MAP MED POL

In the framework of the LBS Protocol, UNEP/MAP is assisting Mediterranean Contracting Parties in the assessment of the state of the marine environment and of its resources, of the sources and trends of pollution and the impact of pollution on human health, marine ecosystems and amenities. In order to assist the countries and to ensure that the data obtained through this assessment can be compared on a world-wide basis and thus contributing to the Global Environmental Monitoring System (**GEMS**) of UNEP, a set of reference methods and guidelines for marine pollution studies, covering technical aspects of monitoring, sample selection, preservation and analysis, have been developed and recommended to be adopted by Governments participating in the Regional Seas Programme. The methods and guidelines have been prepared in cooperation with the relevant specialised bodies of the United Nations system (WHO, FAO, IAEA, IOC) as well as other organisations and are tested by competent experts. The Methods and Guidelines are periodically revised taking into account the development of our understanding of the problem, of analytical instrumentation and the actual need of the users. The Marine Environment Laboratory of the International Atomic Energy Agency (**IAEA**) in Monaco is responsible for the technical co-ordination of the development, testing and intercalibration of Reference Methods.

The Reference Methods for the analysis of pollutants in water, sediment and biota, in the framework of the UNEP/MAP-UNEP/MAP MED POL, can be found at www.unepmap.org (Document and publications; Library Resources; Reference Methods). UNEP/MAP has recently updated selected recommended methods to be used as appropriate for monitoring of contaminants in the marine environment.

ECOLOGICAL OBJECTIVE 09: Contaminants cause no significant impact on coastal and marine ecosystems and human health

Common Indicator description	DESCRIPTION Parameters and/or Elements, matrix	Assessment Method	Monitoring Guidelines, data and existing QA/QC Sampling and Analysis Reference Methods	Recommendations /Additional work, data needed
<p>Common Indicator 11, COP18 indicator number 9.1.1: Concentrations of key harmful contaminants in the relevant matrix (biota, sediment, seawater)</p> <p>With Operational Objective of (9.1. in COP18 Decision): Concentration of priority contaminants (as listed under the UNEP/MAP Barcelona Convention and LBS Protocol) is kept within acceptable levels and does not increase</p> <p>Pressure indicator</p>	<p>Hg, Cd, Pb, PCBs, halogenated pesticides (aldrin, dieldrin, HCB, lindane, ΣDDTs), PAH.</p> <p>In sediment and representative biota (bivalves i.e <i>Mytilus galloprovincialis</i>, fish i.e. <i>Mullus barbatus</i>). PAHs in fish are not considered representative.</p> <p>Aluminum (AL) and Organic Carbon(OC) measurements in sediment for testing normalization purposes</p> <p>pH in seawater to measure</p>	<p>UNEP/MAP MED POL State and Temporal Trend Monitoring Programme</p> <p>At least annually, for biota (for mussels at the pre-spawning period and for fish at the non-spawning period) and every 4-6 years for sediments in low sedimentation areas, (annually for sediments in high sedimentation areas including estuaries and harbours), at the most stable hydrographic conditions.</p>	<p>UNEP/MAP MED POL Programme for the Assessment and Control of Pollution in the Mediterranean Region MAP Technical Reports Series No. 120</p> <p>QA/QC through UNEP/MAP MED POL/IAEA MESL</p> <p>Sampling Analysis Reference Methods are listed in the Integrated Monitoring Guidance document.</p>	<p>Further contaminants may be added following countries specificities and/or regional importance following a review and assessment of LBS Protocol Priority List of substances [such as another trace metals, TBT, PBDE, etc.]</p> <p>Specification of EAC required for trace metals in sediment and biota and PAH in sediments. Online expert group established to develop BAC and EAC as appropriate</p> <p>First estimates of background concentrations for trace metals in sediments and biota and PAHs in sediments are available from CP National Monitoring Programmes.</p> <p>Common decision needed on whether to develop methodology in order to include monitoring of oil affected seabirds (quantification, aimed at chronic oil pollution events not acute ones).</p> <p>Common decision needed on whether the indicator only covers (a) the period since the cut-off from data used for the UNEP/MAP MED POL initial assessment; (b) only the period from the start of the</p>

Common Indicator description	DESCRIPTION Parameters and/or Elements, matrix	Assessment Method	Monitoring Guidelines, data and existing QA/QC Sampling and Analysis Reference Methods	Recommendations /Additional work, data needed
	<p>acidification</p> <p>Monitoring of contaminants in seawater presents specific challenges and therefore recommended to be carried out on a country by country decision basis</p>			<p>ECAP monitoring programme; or (c) a longer time period, e.g. in view of the interest to show the overall changes in the marine environment</p>
<p>Common Indicator 12, COP18 indicator number 9.2.1: Levels of pollution effects of key contaminants where a cause and effect relationship has been established</p> <p>With Operational Objective of 9.2 Effects of released contaminants are minimized</p> <p>Impact indicator</p>	<p>Lysosomal Membrane Stability (LMS) Tier 1 mandatory biomarker on the basis of the 2-Tier approach</p> <p>Reduction of survival in air or Stress on Stress (SoS) Tier 2 optional biomarker on the basis of the 2-Tier approach.</p> <p>Acetylcholinesterase (AChE) assay as a method for assessing neurotoxic</p>	<p>UNEP/MAP MED POL State and Temporal Trend Monitoring Programme</p> <p>Sampling minimum annually Or semi-annually in pre-spawning period (case of mussels) and in non-spawning period (in case of fish)</p>	<p>MTS 120 UNEP/MAP MED POL State and Temporal Trend Monitoring Programme</p> <p>Sampling minimum annually or semi-annually in the pre-spawning period in case of mussels.</p> <p>UNEP/RAMOGGE: Manual on the Biomarkers Recommended for the UNEP/MAP MED POL Biomonitoring Programme. UNEP, Athens, 1999.</p> <p>UNEP/MAP, 2005. Fact sheets on Marine Pollution Indicators. WGUNEP(DEC) / MED/ WG.264 / Inf.14.</p> <p>Background document: stress on stress (SoS) in bivalve molluscs. <i>Concepción Martínez-Gómez and John Thain</i>. In ICES Cooperative Research Report No 315.</p>	<p>Further biomarkers may be added following countries specificities and/or regional importance recommendation list established by experts</p> <p>Ache and Micronucleus assay recommended to build the capacity of UNEP/MAP MED POL designated laboratories for a period of 3-4 years after which consideration whether adopted as mandatory components of the UNEP/MAP MED POL ECAP Monitoring Programme.</p> <p>For AChe BAC and EAC should be estimated for different geographical regions and include the differences in seawater T⁰</p> <p>Several studies have demonstrated that Micronuclei baseline frequencies depend</p>

Common Indicator description	DESCRIPTION Parameters and/or Elements, matrix	Assessment Method	Monitoring Guidelines, data and existing QA/QC Sampling and Analysis Reference Methods	Recommendations /Additional work, data needed
	<p>effects in aquatic organisms. Tier 2 optional biomarker on the basis of the 2-Tier approach.</p> <p>Micronucleus assay as a tool for assessing cytogenetic/DNA damage in marine organisms. Tier 2 optional biomarker on the basis of the 2-Tier approach. In bivalves (i.e. mussels <i>Mytilus galloprovincialis</i>)</p>		<p>Background document: Acetylcholinesterase assay as a method for assessing neurotoxic effects in aquatic organisms <i>Thierry Burgeot, Gilles Bocquené, Joelle Forget-Leray, Lúcia Guilhermino, Concepción Martínez-Gómez, and Kari Lehtonen</i>. In ICES Cooperative Research Report No 315.</p> <p>Background document: micronucleus assay as a tool for assessing cytogenetic/DNA damage in marine organisms <i>Janina Baršienė, Brett Lyons, Aleksandras Rybakovas, Concepción Martínez-Gómez, Laura Andreikenaite, Steven Brooks, and Thomas Maes</i>. In ICES Cooperative Research Report No 315.</p> <p>QA/QC through UNEP/MAP MED POL Inter-calibration exercises in agreement with University of Piemonte Orientale Italy (DiSAV)</p> <p>In ICES Cooperative</p>	<p>on water temperature.</p> <p>Common decision needed on whether to develop methodology (including deciding on sentinel species) in order to include monitoring for imposex in gastropods for the effect of TBT. Decision should be taken after a period of several years when imposex data are starting to be available for Mediterranean Region.</p>
<p>Common Indicator 13, COP18 indicator number 9.3.1 Occurrence, origin</p>	<p>All accidents causing or likely to cause pollution of the sea by oil and</p>	<p>Quantification of oil and other chemical spills and their size by observation and reporting.</p>	<p>UNEP MAP Emergency Protocol Reporting Guidelines available through REMPEC</p> <p>Report available through REMPEC (POL</p>	<p>Contracting Parties would need to improve reporting of information to REMPEC as part of their commitments under the Emergency and Prevention and Emergency</p>

Common Indicator description	DESCRIPTION Parameters and/or Elements, matrix	Assessment Method	Monitoring Guidelines, data and existing QA/QC Sampling and Analysis Reference Methods	Recommendations /Additional work, data needed
<p>(where possible, extent of significant acute pollution events (e.g. slicks from oil, oil products and hazardous substances) and their impact on biota affected by this pollution</p> <p>With Operational Objective 9.3 Acute pollution events are prevented and their impacts are minimized</p> <p>Pressure, Impact indicator</p>	<p>other harmful substances</p> <p>The presence, characteristics and extent of spillages of oil or other harmful substances observed at sea which are likely to present a serious and imminent threat to the marine environment or to the coast or related interests of one or more of the Parties;</p> <p>Their assessments and any pollution combating actions taken or envisaged to be taken</p> <p>The evolution of the situation.</p>	<p>Optional utilization of:</p> <ul style="list-style-type: none"> • Satellite radar images, plane observation and imaging approaches • Backtracking of oil spills to their source by hind cast modelling; • Fingerprinting using chemical analysis (Gas Chromatography-Mass Spectrometry) and comparison with possible sources 	<p>REP) for reporting to REMPEC spills in excess of 50m³ For lower levels reporting should be at the discretion of the countries. Sampling analysis, reference methods are available through REMPEC/IMO.</p>	<p>Protocols.</p>
<p>Common indicator 14, COP18 Indicator 9.4.1: Actual levels of</p>	<p>At least the following contaminants for which regulatory levels have been</p>	<p>Assessment of the results of monitoring executed/commissioned by the pertinent authorities responsible for health</p>	<p>Monitoring executed/commissioned by the authorities responsible for health monitoring, of contaminants in fish and other seafood used for human consumption.</p>	<p>This type of monitoring was not included under UNEP/MAP MED POL Phase IV.</p> <p>It is recommended that to connect the required monitoring data to the</p>

Common Indicator description	DESCRIPTION Parameters and/or Elements, matrix	Assessment Method	Monitoring Guidelines, data and existing QA/QC Sampling and Analysis Reference Methods	Recommendations /Additional work, data needed
<p>contaminants that have been detected and number of contaminants which have exceeded maximum regulatory levels in commonly consumed seafood</p> <p>With Operational Objective 9.4: Levels of known harmful contaminants in major types of seafood do not exceed established standards</p> <p>Pressure, Impact indicator</p>	<p>laid down: Heavy metals (Pb, Cd, Hg), PAH, dioxins including dioxin-like PCBs)</p>	<p>monitoring for cases for which monitoring of contaminants under indicator 9.1.1 (and possibly 9.2.1) show cause for concern</p> <p>.</p>		<p>UNEP/MAP MED POL Database by the Contracting Parties.</p> <p>In order to make monitoring results more comparable between sub- regions it would be advisable to select a limited number of target species from the most consumed species of fish and other seafood.</p> <p>A list of maximum levels for contaminants in foods set by the FAO/WHO Codex Alimentarius Commission can be found at: ftp://ftp.fao.org/codex/Meetings/cccf/cccf7/cf07_INFe.pdf</p>
<p>Common indicator 15, COP 18 Indicator 9.5.1: Percentage of intestinal enterococci measurements</p>	<p>Intestinal enterococci in seawater in bathing and other recreational areas</p>	<p>UNEP/MAP MED POL/WHO Bathing and Recreational Water Monitoring Programme</p> <p>Sampling fortnightly in spring and summer to autumn</p>	<p>Criteria and Standards for Bathing Waters in the Mediterranean Region. COP 17 Decision IG 20/9</p> <p>QA/QC available through UNEP/MAP MED POL/ WHO</p> <p>ISO 7899-2 based on membrane filtration technique or any other approved technique</p>	

Common Indicator description	DESCRIPTION Parameters and/or Elements, matrix	Assessment Method	Monitoring Guidelines, data and existing QA/QC Sampling and Analysis Reference Methods	Recommendations /Additional work, data needed
<p>within established standards With Operational Objective 9.5: Water quality in bathing waters and other recreational areas does not undermine human health Pressure, Impact indicaotr</p>				

Chapter III

Marine Litter chapter and related fact sheet

III. MONITORING AND ASSESSMENT METHODOLOGICAL GUIDANCE ON EO10: MARINE LITTER

1. Introduction

In the UNEP/MAP Barcelona Convention/LBS Protocol system, the monitoring of marine litter is regulated both through the Regional Plan on Marine Litter management (herein after referred to as **MLRP**), adopted by COP 18, 2013 and the COP18 EcAp Decision. The latter specified the key relevant marine litter ecological and operational objectives as well as a set of three ML state indicators.

Article 12 of the MLRP provides for a Mediterranean Marine Litter Monitoring Programme, which will be in synergy with the relevant international and regional guidelines including the relevant work carried out under the EU MSFD.

The EcAp CorGest meeting held in February 2014 adopted EcAp marine litter common indicators (common indicators 16-17) and one candidate indicator (candidate common indicator 18).

Special attention was paid to two key relevant documents on marine litter monitoring namely the UNEP Operational Guidelines for Comprehensive Beach Litter Assessment (Cheshire *et al.* 2009) and the “Guidance on Monitoring of Marine Litter in European Seas” produced between 2012 and 2013 by the European Union Task Group on Marine Litter (**TSG ML**). Both aforementioned documents were presented as information documents UNEP DEPI (MED) WG 394. Inf.4 and UNEP DEPI (MED) WG 394. Inf.5 for the EcAp Coordination Group in September 2015.

The recent overviews by UNEP (Cheshire *et al.*, 2009), and by NOAA, (Opfer *et al.* (2012)), are the most comprehensive and useful overviews for monitoring methods on the coast. The UNEP overview includes a comprehensive comparison of existing marine litter survey and monitoring methods and protocols in which beach surveys were assessed. Much of the information included in the TSG ML report for the monitoring of beach litter is taken from the UNEP Operational Guidelines for Comprehensive Beach Litter Assessment (Cheshire *et al.*, 2009) and the NOAA Marine Debris Shoreline Survey Field Guide (Opfer *et al.*, 2012).

The objective of the “Guidance on Monitoring of Marine Litter in European Seas” is to provide EU Member States with recommendations and information needed to implement harmonized monitoring programmes for marine litter. The report describes specific protocols and considerations to collect, report and assess data on marine litter, in particular beach litter, floating litter, seafloor litter, litter in biota and micro-litter.

The TSG ML monitoring guidance document was developed through a collaborative programme involving the European Commission, all EU Member States, the Accession Countries and Norway, international organisations, including all the Regional Sea Conventions and other stakeholders and Non-Governmental Organisations. The document should be regarded as presenting an informal consensus position on best practice agreed by all partners. Dealing with a topic under development through research efforts and by fast growing experience this guidance is regarded as a living document to be regularly reviewed.

All the protocols suggested by TSG-ML are aimed mainly at assessing environmental status and environmental targets. All protocols can supply quantitative data, and allow the assessment of trends. The beach litter protocol is also designed to identify sources by using a detailed list of identifiable items, while other protocols can do this to some extent through their lists of items, but also by modifying the sampling strategy (where and when to sample) to match the likely effects of specific measures.

In their analysis of the protocols, the issue of compatibility and coherence has been important. Most of the protocols proposed can be applied across the Regional Seas scale. However, some of the protocols

for litter in biota cannot be identical, for the simple reason that the proposed species do not all occur across the Regional Seas.

A complete analysis of risk should ideally include quantitative knowledge of harm. An analysis of harm will be a focus area for future work. In the event of insufficient quantitative data availability on harm, the risk-based approach is chosen to be addressed by an assessment of where the amounts of litter are likely to be highest or the type of litter which has the largest impact (e.g. microplastics). Already in the selections of protocols a degree of risk-based approach is used. For example, it is proposed to measure litter on the sea surface rather than in the whole water column, because pilot studies indicate that litter quantities are higher on the sea surface. Similarly, the protocols for monitoring on the sea floor propose to assess where litter tends to accumulate (e.g. through pilot studies or oceanographic modelling), and then to direct monitoring towards such areas. While there may be problems to generalize the results from this kind of monitoring to other areas, such strategies are in line with a risk-based approach.

As mentioned above in the document, due to lack of experience on marine litter monitoring within the UNEP/MAP MED POL programme, the Secretariat has developed the present working document drawing largely on the above mentioned UNEP Operational Guidelines for Comprehensive Beach Litter Assessment and on the Guidance on Monitoring of Marine Litter in European Seas.

2. Establishing a monitoring framework for marine litter in the Mediterranean

The COP18 EcAp Decision includes definitions of GES and targets for marine litter indicators. These indicators refer to litter washed ashore or deposited on coastlines, litter in the water column, including microplastics, and on the seafloor and litter ingested by or entangling marine organisms, especially marine mammals, seabirds and marine turtles.

Fulfilling the monitoring requirements under the Regional Plan on Marine Litter and under EcAp is a major undertaking, and resources for monitoring can be limited. Contracting Parties are, therefore, faced with the decision of what to monitor, and whether it is essential to assess litter amounts, in all of the environmental compartments mentioned above. It is then important to remember that these different compartments can indicate different pathways and sinks for marine litter, and do not necessarily substitute each other.

Our present understanding of litter in the marine environment, which is based on information for only a subset of these compartments, is not sufficient to draw conclusions about the trends and amounts of litter, in the various size categories, in the total marine environment. Biota indicators have a different, but not less important, function: they give an indication of possible harm. Furthermore, the compartments selected for monitoring should also provide information for the identification of sources, not only in terms of the nature and purpose of the items, but also their original source (which can be related to unsuitable or accidental disposal), and the pathway through which the item entered the marine environment. Again, this may vary among the different environmental compartments. At the same time, it is acknowledged that the protocols/methods such as those listed in the TSG-ML report have different degrees of maturity, i.e. to what extent they are tested in the field, and are in common use.

It is strongly recommended that Contracting Parties, which currently have plans to monitor only in a subset of environmental compartments, to start with small pilot research or development projects in other compartments. This would provide baseline data to make an informed decision about future, full-scale monitoring programmes. Without information on trends and amounts, in all the marine compartments, a risk-based approach to litter monitoring and measures is not possible.

A considerable number of citizens, communities (NGOs, civil society initiatives) and environmental protection associations and institutes across the Mediterranean are already taking part in activities to tackle marine litter. The aim would be to enable them to participate in a Mediterranean regional

attempt to address marine litter issues as envisaged through the MLRP and to empower citizen networks to help improve the evidence base needed to reach the EcAp main objectives.

2.1. **Some general considerations on spatial distribution of survey sites: site selection strategies**

The strategy used to select sites is partly a statistical/technical issue but foremost it is related to the purpose of monitoring, a decision to be taken when a monitoring strategy is defined. The site selection strategy has fundamental consequences for the monitoring analysis, as has the selection of the survey method. Monitoring programmes are not compatible or comparable if they use the same survey methods, but different site selection strategies (e.g. special site selection on the basis of litter pollution levels, or a randomised selection of sites.)

Sites can be chosen individually because they have certain characteristics and they represent what is needed for the CPs (maritime pollution, characterization of sources, etc.). This may be because they are considered to have certain environmental or societal values. For example, a beach that has a high number of visitors, because the beach is situated in a certain area, or simply because the site has heavy litter loads. Usually, the site is revisited during subsequent surveys to assess trends. The advantage of this approach is that if several sites are chosen for sharing the same characteristics, the litter load they receive is expected to be more similar than those chosen randomly and, therefore, the variation will be less than those chosen randomly. With this in mind, the ability to detect statistically significant trends will be increased. The main disadvantage of the strategy is that, as individual sites are chosen deliberately for special features, they are therefore different from other sites. Hence they may be less suitable for drawing conclusions about average litter levels etc. for a given region. It may add difficulty in interpreting statistical results for technical and philosophical reasons.

Sites may be chosen randomly from a large number of possible sites, meeting certain criteria based upon the method and the monitoring purpose. Sites may be revisited or chosen for each monitoring occasion; the important issue is how they were selected in the first place, e.g. a random selection from many possible sites. The main advantage of this strategy is that results can be extrapolated to other possible sites, i.e. we can use the results to draw conclusions about larger areas. Nevertheless, the variation among sites can be high, making it difficult and costly to find statistically significant trends.

In practice, these two strategies are rarely used in their pure form. Instead a combination is used which is sometimes referred to as, “stratified randomised sampling strategy”. Sites meeting certain criteria are (more or less) randomly chosen. The criteria may include geographic, environmental, societal and other factors. An example would be to choose sites that are close to harbours, to monitor effects of pollution from harbours, and/or sites that are situated in relatively remote areas, to monitor large-scale pollution levels without strong influence from local sources. This is compatible with a risk-based approach. Priority should be given to monitoring programmes that measure environmental status and trends, in sites where the risk of harm is greatest. The criteria for the site selection should then be based on prediction of potential harm. Prediction of potential harm could be based on practical knowledge of which environmental values are most sensitive to harm. However, the current understanding of how different species or biotopes react to litter is insufficient, and should be further researched. Another approach to harm may be based on aspects that are particularly “valuable” to society for other reasons e.g. economically, socially or environmentally. A third approach is to assume that harm is more likely to occur in areas/environments where there is a lot of litter and select sites based on screening monitoring to identify them. While this option may be practical and make sense in terms of societal needs, it is important to remember that we do not know if statistical trends from such sites are representative of other sites (probably not), but represent a “worst case” scenario.

One way to make best use of limited resources is to take advantage of other studies and programmes where litter monitoring can be integrated (what is called “opportunities to reduce costs”). An example is to combine monitoring for litter on the sea floor with scientific trawling for fish stock biomass

estimation (such as under the Mediterranean International Trawl Survey, MEDITS). In such a case, the selection of sites is designed for the original monitoring programme purpose, and representation of other areas are already defined. Where use of such a scheme is made, it is important to analyse the sampling strategy to assess if this is suitable for litter monitoring too.

For marine litter, a stratified, randomised sampling strategy where possible is advocated. Also, that the purposes of the monitoring programmes define the criteria for selecting sites. Simplification is necessary when resources are limited, and concentration of monitoring effort is the logical result.

Monitoring for trend analysis: Statistical power or how many sampling stations are needed to detect a change?

The ability of a monitoring programme to show a statistically significant trend or difference is called statistical power. Statistical power is influenced by the magnitude of the trend, the variation among replicates, and the number of replicates.

The magnitude of the trend is a characteristic of the combined effect of the environment and our (miss) handling of litter. In that sense, the magnitude of the trend is dependent on the action we take against litter. When designing a monitoring programme an important decision is related to the magnitude of change we wish to detect. It is of course easier to detect a large trend than a small trend. The smaller the magnitude we want to detect, the more comprehensive the monitoring programme needs to be. If the action plans to tackle marine litter aim at reducing litter amounts significantly, then monitoring programmes can detect real changes.

The number of replicates is something that is easy to change given sufficient resources. Replicates, in the case of litter trends, are a combination of monitoring sites and monitoring occasions. Using the same amount of sites, the ability to detect a significant trend increases with time. In monitoring programmes, which often are complex with multiple temporal and spatial layers, the actual number of replicates is less easy to define.

The variation among replicates is a characteristic of the system studied. All biological systems tend to be very variable. To a certain extent, we can influence this by having well defined monitoring protocols and quality assessments, to minimize the added variation due to handling. More important, however, is the ability to decrease variation among sites, by introducing criteria for the sampling, as described in the section on site selection strategies above. This is not cutting corners or cheating, but it is important to realize that the possibility to extrapolate to un-sampled sites decreases.

Common to all three factors influencing statistical power is that they are case specific. It is not possible to give general advice on how many replicates are adequate, except to say the more the better. Firstly, decisions about the purpose of a specific monitoring programme, and what the sites should represent have to be made. Then some estimate of variation is necessary. The data on variation should, ideally, come from a pilot study using the same sites. Otherwise data from similar programmes can be used. Only then can calculations of statistical significance be made, and thus the required number of sites for the monitoring programme be arrived at.

An important and encouraging fact is that it is of value to start a monitoring programme even if the initial resources are limited. The initial data from monitoring can nevertheless be used for subsequent trend analysis (albeit with reduced statistical power), but more importantly, the data collected can be used to refine the design of the programme, including power calculations.

Power calculations for litter monitoring, using methods suggested in this report, have been made for some protocols, e.g. the Sea-bird litter ingestion protocol applied to Fulmars.

A possible challenge in monitoring of time trends of microparticles

Microparticles in the marine environment may enter directly as such from synthetic textile fragments, plastic particles used in cosmetic, or industrial cleansers, etc.), but they can also result from the progressive fragmentation of larger pieces or items already present in the sea. If the former source is the dominant, conclusions may be drawn from fluctuation of trends. If the latter is the main source it is more problematic. Then it is possible to interpret increasing or decreasing trends as a net input of fragments or microparticles into the marine environment, when the increase may be caused by changes in the rate of breakdown of larger particles, i.e. not caused by a change in the overall amount of marine litter.

2.2. Some general considerations regarding Quality Assessment/Quality Control approaches and requirements

Since important decisions will be taken, based on the results obtained by monitoring programmes, it is important that the data generated is of acceptable quality. In order to ensure the quality and integrity of marine litter monitoring data, investment must be made in the capacity-building of national, regional and local survey coordination and management.

The use of quality control and assurance measures, such as inter-calibrations, use of reference material where appropriate, and training for operators should accompany the implementation of adopted monitoring protocols. These approaches should be developed in the context of dedicated research.

The value of the monitoring programmes results can be enhanced where a standard list of litter items is used as a basis for preparing assessment protocols. A master-list of categories of litter items has been prepared by TSG-ML. The use of appropriate field guides with examples of each litter type will assist survey team members (particularly volunteers) to be consistent in litter characterization. Such field guides should be coupled to the master list of litter items, and be made available over the web to increase consistency between survey teams working at remote locations.

The use of standard lists and definitions of items will enable the comparison of results between regions and environmental compartments. Items can be attributed to a given source e.g. fisheries, shipping etc. or a given form of harm e.g. entanglement, ingestion etc. The value of monitoring results can be increased further by identifying the main sources of marine litter pollution, and the potential level of harm that marine litter may inflict. This will enable a more target-orientated implementation of measures. Throughout the period 2013-2014, the TSG-ML will further elaborate on approaches to link detailed categories of items to the most probable source, and to other important strategic parameters which can help design and monitor measures and UNEP/MAP may also benefit from this work.

3. Monitoring of litter washed ashore and/or deposited on coastlines (Common indicator 16, Trends in the amount of litter washed ashore and/or deposited on coastlines, ie Beach Litter)

3.1. Introduction to Beach Litter

The recent overviews by UNEP, in Cheshire et al. (2009), and by NOAA, in Opfer et al. (2012), are the most comprehensive and useful overviews for monitoring methods on the coast. The UNEP overview includes a comprehensive comparison of existing marine litter survey and monitoring methods and protocols in which beach surveys were assessed (Cheshire et al., 2009).

Much of the information included in the Final Report of TSG ML is taken from the UNEP Operational Guidelines for Comprehensive Beach Litter Assessment (Cheshire et al., 2009) and the NOAA Marine Debris Shoreline Survey Field Guide (Opfer et al., 2012).

When designing marine litter surveys it is necessary to differentiate between standing-stock surveys, where the total load of litter is assessed during a one-off count, and the assessment of accumulation and loading rates during regularly repeated surveys of the same stretch of beach with initial and subsequent removal of litter.

Both types of survey provide information on the amount and types of litter, however, only the accumulation surveys provide information on the rate of deposition of litter and trends in litter pollution. As the ECAP requires an assessment of trends in marine litter recorded on coastlines only methods for the assessment of accumulation would be recommended.

The type of survey selected depends on the objectives of the assessment and on the magnitude of the pollution on the coastline. A single survey method has been recommended by TSG-ML with different spatial parameters for light to moderately polluted coastline and for heavily polluted coastlines

3.2. Requirements of a harmonised protocol

The comparison of beach litter data between assessment programmes is the primary aim of a harmonised protocol. Comparison is difficult if different methods, different spatial and temporal scales, different size scales of litter items and different lists or categorisation of litter items recorded on beaches are used within the Regional Seas

The type of survey selected depends on the objectives of the assessment and on the magnitude of the pollution on the coastline. A single survey method is recommended by the TSG-ML, with different spatial parameters for light to moderately polluted coastline and for heavily polluted coastlines.

Amounts of litter on the shore can be relatively easily assessed during surveys carried out by non-scientists using unsophisticated equipment. Coastal surveys are thus a cost effective way of obtaining large amounts of information. The litter deposited on the coastline can vary greatly between sites and seasons, affected by hydrographical and geomorphological characteristics of the area (e.g. prevailing winds and currents, exposure of the beach to the sea) but also depending on the use of the coast (e.g. larger amounts can be deposited during the tourist season or during special events). Therefore, coastal surveys should focus on fixed sites, which fulfil the requirements of the protocol, and the timing of the survey (i.e. season) should take into account the potential sources of litter to the site (e.g. flooding in rainy seasons may increase the amounts). Sites can be placed far from known sources, in order to better reflect reference values for background litter pollution levels, or close to potential sources. By using temporal trends for assessments, both of the survey strategies give important information for managers.

3.2.1 Amounts, composition, distribution and sources of Beach Litter

Amounts of litter on the shore can be relatively easily assessed during surveys carried out by non-scientists using unsophisticated equipment. Coastal surveys are thus a cost effective way of obtaining large amounts of information. The litter deposited on the coastline can vary greatly between sites and seasons, affected by hydrographical and geomorphological characteristics of the area (e.g. prevailing winds and currents, exposure of the beach to the sea) but also depending on the use of the coast (e.g. larger amounts can be deposited during the tourist season or during special events). Therefore, coastal surveys should focus on fixed sites, which fulfil the requirements of the monitoring protocol, and the timing of the survey (i.e. season) should take into account the potential sources of litter to the site (e.g. flooding in rainy seasons may increase the amounts). Sites can be placed far from known sources, in order to better reflect reference values for background litter pollution levels, or close to potential sources. By using temporal trends for assessments, both of the survey strategies give important information for managers.

Trends in amounts of litter

The variation in the amount of litter present on a given beach between surveys and the variation between beaches, even in the same region, can be extremely large. This makes the identification of trends difficult, especially taking into account seasonal variations. Moreover, as litter accumulates on beaches, surveys should be carried out at regular intervals in time so that the accumulation periods are approximately of the same length.

Composition of litter

The assessment of composition of litter is one of the great strengths of coastal assessments. A detailed assessment of litter composition provides information on potential harm to the environment and in some cases on the source of the litter found. The assessment of composition must follow commonly agreed categories in order to provide results which are comparable over larger regions.

Spatial distribution

Amount and composition of marine litter varies over geographical scales and reflects hydrographical (e.g. currents, wave exposure, wind directions) and geomorphological (e.g. steepness of a shore, amounts of inlets islands) characteristics of the coast. Hydrographical characteristics determine the amount of litter accumulating in waters adjacent to the coast, whereas geomorphological characteristics determine how much of this litter becomes washed ashore.

Sources of marine litter

The source of litter found on the coast can be clearly identified for some litter items. These are mostly items which originate from fisheries, or debris flushed down sewerage systems. Even with these items some caution is needed e.g. a fish box may originate from a fishing vessel or from a fishing port.

A comprehensive master list of items and categories has been developed within the TSG-ML. The sources for some items need to be designated at a regional level, because initial assessments of litter on coastlines show that sources for a given item can be different between regions.

The master list will enable at least a rough estimate of the sources of litter found on coastlines, but it should be evaluated in survey sites against known local sources. If detailed information is required it will, be necessary to carry out detailed research into the sources involved e.g. to identify between litter deposited directly on the beach by tourists and litter arriving on the beach from adjacent waters. In addition drift analysis of litter in adjacent waters could provide valuable information on its geographical origin.

3.2.2 Strategy for monitoring beach litter

Selection of survey sites

Ideally the selected sites should represent litter abundance and composition for a given region. Not any given coastal site may be appropriate, as they may be limited in terms of accessibility, suitability to sampling (sand or rocks/boulders) and beach cleaning activities. If possible the criteria below should be used:

- A minimum length of 100m;
- Clear access to the sea (not blocked by breakwaters or jetties) such that marine litter is not screened by anthropogenic structures;
- Accessible to survey teams year round, although some consideration needs to be;
- Ideally the site should not be subject to any other litter collection activities, although it is recognized that in many parts of Europe large scale maintenance cleaning is carried out periodically; in such cases the timing of non-survey related beach cleaning must be known such that litter flux rates (the amount of litter accumulation per unit time) can be determined.

- Survey activities should be conducted so as not to impact on any endangered or protected species such as sea turtles, sea birds or shore birds, marine mammals or sensitive beach vegetation; in many cases this would exclude national parks but this may vary depending on local management arrangements.

Within the above constraints, the location of sampling sites within each zone should be stratified such that samples are obtained from beaches subject to different litter exposures, including:

- Urban coasts may better reflect the contribution of land-based inputs;
- Rural coasts may better reflect background values for litter pollution levels
- Coasts close to major rivers, if downstream from the prevailing drift, may better reflect the contribution of riverine input to coastal litter pollution.

Number of sites

At present there is no agreed statistical method for recommending a minimum number of sites that may be representative for a certain length of coast. This depends greatly on the purpose of the monitoring, on the geomorphology of the coast and how many sites that meet the criteria described above are available. The representativeness of survey sites should be assessed in pilot studies, where initially a large numbers of beaches are surveyed. Subsequently, selection of representative beaches from these sites should be made on the basis of a statistical analysis.

Frequency and timing of surveys

At least two surveys per year in spring and autumn are recommended and ideally 4 surveys in spring, summer, autumn and winter. However, because of the large seasonal variation in amounts of litter washed ashore, initially a higher frequency of surveys may be necessary in order to identify significant seasonal patterns, which can then be considered when treating raw data for long-term trend analyses.

Preferably, the surveys for all participating beaches in a given region should be carried out within the shortest timeframe possible within a survey period. Coordinators within these regions should try and coordinate the survey dates between beaches. Furthermore a given beach should be surveyed on roughly the same day each year if possible.

It should be kept in mind that circumstances may lead to inaccessible and unsafe situations for surveyors: heavy winds, slippery rocks and hazards such as rain, snow or ice, etc. The safety of the surveyors must always come first. Dangerous or suspicious looking items, such as ammunition, chemicals and medicine should not be removed. Inform the police or authorities responsible. If working on remote beaches it is recommended to work with a minimum of two people.

Documentation and characterisation of sites

It is very important to document and characterise the survey sites. As surveys should be repeated on exactly the same site the coordinates of the site should be documented.

Sampling unit

Once a beach is chosen sampling units can be identified. A sampling unit is a fixed section of beach covering the whole area between the water edges (where possible and safe) or from the strandline to the back of the beach.

- At least 1 section of 100m on the same beach, optimum 2 sections, are recommended for monitoring purposes on lightly to moderately littered beaches
- At least 2 sections of 100 m for heavily littered beaches (exceptionally 50m section with a normalisation factor of up to 100m to ensure coherence)

Permanent reference points must be used to ensure that exactly the same site will be monitored for all surveys. The start and end points of each sampling unit can be identified by different methods. For example numbered beach poles could be installed at the site or easily identifiable landmarks could be used. Coordinates obtained by GPS are useful for identifying the reference beaches especially where easily identifiable landmarks are lacking.

Units (quantification) of litter

Counts of items are recommended as the standard unit of litter to be assessed on the **coastline**.

Collection and identification of litter items

All items found on the sampling unit should be entered on survey forms. On the survey forms, each item is given a unique identification number. Data should ideally be entered on the survey form while picking up the litter. Collecting the litter first and identifying it later may alter numbers as collected litter tends to get more entangled or broken.

Unknown litter or items that are not on the survey form should be noted in an appropriate "other item box". A short description of the item should then be included on the survey form. If possible, digital photos should be taken of unknown items so that they can be identified later and, if necessary, be added to the survey form.

A master list of litter categories and items is included in the TSG-ML Final Report. This master list includes a list of categories and items to be recorded during beach litter surveys. A reduced list for the Mediterranean, MSFD and OSPAR compatible (see annex), that includes the most frequent items found in Mediterranean beaches may be considered and more useful and practical for the field work. This will also enable a coordinated and harmonized monitoring when operated by NGOs.

It has been strongly recommended to produce regional photo guides including pictures of all litter items on the regional survey protocol. This will assist in the correct identification and allocation of recorded items.

Size limits and classes of items to be surveyed

There are no upper size limits to litter recorded on beaches.

The lower limit of detection, when walking a beach, is probably somewhere around 0.5 cm (plastic pellets), however, it is doubtful that such small items can be monitored effectively using the standard protocol for Marine Litter and in a repeatable fashion during beach surveys.

A lower limit of 0.5 cm in the longest dimension is recommended for litter items monitored during beach surveys. This would ensure the inclusion of caps & lids and cigarette butts in any counts.

Removal and disposal of litter

Removal of litter should be carried out at the same time as monitoring the litter. Coupling removal with monitoring ensures better accuracy of reporting and enables comparison of litter accumulation over time; It also has the added advantage of leaving a clean beach. It is important to note that only the 100m ref section(s) need to be monitored and cleaned. Further areas of a beach can be cleaned without monitoring if surveyors/volunteers wish to do so.

The litter collected should be disposed of properly. Regional or national regulations and arrangements should be followed. If these do not exist local municipalities should be informed.

Larger items that cannot be removed (safely) by the surveyors should be marked, with for example paint spray (for marking trees) so they will not be counted again at the next survey.

Many municipalities will have their own cleaning programme, sometimes regularly, sometimes seasonal or incident related. Arrangements should be made with the local municipalities so that they either exclude the reference beach from their cleaning scheme or they provide their cleaning schedule so surveying can be carried out a few days before the municipality will clean the beach.

Preferably a set time should be established for each beach between the date when the beach was last cleaned and the date when the survey is carried out. It is advisable to contact the municipality before starting a survey to obtain the latest information on beach cleaning activities. Sometimes an incident, for example a storm, will alter their cleaning programme.

3.3. Quality Assessment /Quality Control for beach litter

Based on the UNEP Guidelines (Cheshire et al., 2009), any long-term marine litter assessment programme will require a specific and focussed effort to recruit and train field staff and volunteers. Consistent, high quality training is essential to ensure data quality and needs to explicitly include the development of operational (field based) skills. Staff education programmes should incorporate specific information on the results and outcomes from the work so that staff and volunteers can understand the context of the litter assessment programme.

Quality assurance and quality control should be primarily targeted at education of the field teams to ensure that litter collection and characterization is consistent across surveys. Investment in communication and the training of the country/regional and local survey coordinators and managers is thus critical to survey integrity.

The quality assurance protocol of Ocean Conservancy's National Marine Debris Monitoring Program (USA) required a percentage of all locations to be independently re-surveyed immediately following the scheduled assessment of litter (Sheavly, 2007). The collected litter from the follow-up survey could then be added to that of the main collection and could be used to provide an estimate of the error level associated with the survey.

3.4. Conclusion

In order to enable temporal and spatial comparisons within and across regions, standard litter survey methods should, where possible, be applied at all levels (local to regional) and the assessment of its composition follows agreed categories of items.

4. Monitoring of litter at sea (Common Indicator 17 Trends in the amount of litter in the water column including microplastics and on the seafloor, so-called Floating Litter)

Note: Because of the low occurrence of litter in midwater, it is recommended that the indicator focus on surface and seafloor litter

4.1. Introduction to floating litter

There exists early documentation of the occurrence of man-made objects, mainly plastic, floating at sea (Venrick 1972, Morris, 1980). While significant actions in waste management and disposal have been taken, floating litter is still a concern. It poses a direct threat to fish, marine mammals, reptiles and birds. Harm can occur through ingestion of whole items or pieces or by feeding on larger litter items. Entanglement can occur by floating bags, nets and other fishing gear. It can be assumed that marine macro litter is a precursor of marine micro litter.

4.2. Scope and key questions to be addressed

Monitoring of litter at open sea and on long transects, is not currently addressed as this requires different approaches, in particular regarding the observation conditions provided by the ships used for the surveys and regarding the possibility to monitor smaller items.

The fraction of litter under discussion, includes floating items in the water column close to the surface, as caused e.g. by the temporary mixing of floating particles under the water surface due to wave action. Litter in the deeper water column is currently not recommended for routine monitoring and should be subject of research efforts.

4.3. Existing approaches for visual ship-based observation of floating litter

HELMPEA (Hellenic Mediterranean Protection Association) uses a fleet of ocean going member vessels on a voluntary basis to obtain monitoring data through a reporting sheet. The EcoOcéan Institut is performing monitoring of floating litter in parallel with monitoring of marine mammals in the north-western Mediterranean Sea. UNEP guidance considers both sampling of an area through a dedicated observation pattern and transect sampling for monitoring of surface floating litter (UNEP, 2009).

4.3.1. Discussion of observation protocol elements

The observation of floating marine litter from ships is subject to numerous variables in the observation conditions. They can be divided into operational parameters, related to the ship properties and observation location.

The processing of the collected information, starting from the documentation on board, its compilation, elaboration and further use should be part of a protocol in order to derive comparable final results. The format should allow a compilation across different observing institutes and areas or regions. This would allow a plotting of floating litter distribution over time and thus finally allow the coupling with oceanographic current models.

4.4. Strategy for monitoring of floating litter

4.4.1 Source attribution of floating marine litter

Due to the observation methodology, the source attribution for floating litter is challenging. The type of marine litter objects can only be noted during very short visual observation. Therefore, in difference to beach litter, it is likely that only rough litter categories can be determined.

The spatial distribution of floating marine litter instead gives, in combination about currents, and river information indications about the physical source, i.e. the litter input zone and its pathway, which is very valuable information about source strength and may help to design appropriate measures and check their efficiency.

The monitoring of floating litter is very likely to be an iterative process during which in an initial phase hot spots and pathways are determined, while in an evolving monitoring programme selected transects help with the quantification of trends.

4.4.2. Spatial distribution of monitoring

The monitoring of floating marine litter by human observers is a methodology indicated for short transects in selected areas. In a region with little or no information about floating marine litter abundance it might be advisable to start by surveys in different areas in order to understand the variability of litter distribution. The selected areas should include expected low density areas (e.g. open sea) as well as expected high density areas (e.g. close to ports). This will help to obtain maximum/minimum conditions and train the observers. Other selected areas (e.g. in estuaries), in the

vicinity of cities, in local areas of touristic or commercial traffic, incoming currents from neighbouring areas or outgoing currents should be considered.

Based on the experience obtained in this initial phase, a routing programme including areas of interest should then be established.

4.4.3. Timing of floating marine litter monitoring

The observation of floating marine litter is much depending on the observation conditions, in particular on the sea state and wind speed. The organization of monitoring must be flexible enough to take this into account and to re-schedule observations in order to meet appropriate conditions. Ideally the observation should be performed after a minimum duration of calm sea, so that there is no bias by litter objects which have been mixed into the water column by recent storms or heavy sea.

The initial, investigative monitoring should be performed with a higher frequency in order to understand the variability of litter quantities in time. Even burst sampling, *i.e.* high sampling frequency over short period, might be appropriate in order to understand the variability of floating marine litter occurrence.

For trend monitoring the timing will depend on the assumed sources of the litter, this can be *e.g.* monitoring an estuary after a rain period in the river basin, monitoring a touristic area after a holiday period.

The timing of the surveys will also depend on the schedule of the observation platforms. Regular patrols of coast guard ships, ferry tracks or touristic trips may offer frequent opportunities which thus also allow the use during the needed calm weather conditions.

4.5. Visual monitoring of floating litter

The reporting of monitoring results requires the grouping into categories of material, type and size of litter object. The approach for categories of floating litter is linked with the development of a “master list” with the categories for other environmental compartments such as the “master list” prepared by the TSG-ML. This allows cross comparisons.

The categories of items for floating litter should be, as far as practical, consistent with the categories selected for beach litter, seafloor litter and others. There are limitations to this, but in principal the derived data should allow a comparison across different environmental compartments, in particular between beach and surface floating litter. Therefore the list of item categories that should be adopted for floating litter corresponds to the Master List of items. For the practical use during the monitoring the list has to be arranged by object occurrence frequency so that the data acquisition can be done in the required short time. Tablet computer applications for facilitating the data documentation are under development.

As floating litter items will be observed but not collected, the size is the only indicative parameter of the amount of plastic material that it contains. The size of an object is defined here as its largest dimension, width or length, as visible during the observation.

The lower size limit for the observations is determined by the observation conditions. These should be harmonized so that a lower limit of 2.5 cm can be achieved. That size appears to be reasonable for observation from “ships-of-opportunity” and is in line with the size for beach litter surveys. This denotes that observations not achieving this minimum size limit cannot be recommended.

For reporting purposes size range classes must be introduced as visual observation will not permit the correct measuring of object sizes. Only the estimation of size classes is feasible.

The size determination/reporting scheme should enclose the following classes:

- 2.5 – 5 cm
- 5 - 10 cm
- 10 – 20 cm
- 20 – 30 cm
- 30 – 50 cm

While also wider size range classes (*e.g.* 2.5–10cm, 10–30cm, 30–50 cm) could be utilized, it will be important that a common approach is used, as the data will be combined in common data bases. The test phase of implementing a monitoring protocol should allow the determination of overall accepted and final size range classes. The upper size limit will have to be determined by statistical calculations regarding the density of the object occurrence in comparison to transect width, length and frequency. In coherence with the beach litter surveys an upper limit of 50 cm is here provisionally proposed. It has to be evaluated in experiments and from initial data sets if items larger than 50 cm should be reported, as their relevance in the statistical evaluation of data from short and narrow coastal transects might be questionable.

4.6. Visual monitoring of floating litter

A harmonized approach for the quantification of floating marine litter by ship-based observers has been developed by the TSG-ML. It has the scope to harmonize the monitoring of floating marine litter:

- In the size range from 2.5 to 50 cm,
- Observation width needs to be determined according to observation set-up,
- It is planned for use from ships of opportunity,
- It is based on transect sampling,
- It should cover short transects, and
- Also record necessary metadata.

4.6.1. Observation

The observation from ships-of-opportunity should ensure the detection of litter items at 2.5 cm size. The observation transect width will therefore depend on the elevation above the sea, the ship speed and the observation conditions. Typically a transect width of 10 m can be expected, but a verification should be made and the width of the observation corridor chosen in a way that all items in that transect and within the target size range, can be seen. Table 10.1 below provides a preliminary indication of the observation corridor width, with varying observation elevation and speed of vessel (kn = knot = nautical mile/h). The parameters need to be verified prior to data acquisition.

The ideal location for observation will often be in the bow area of the ships. If that area is not accessible, the observation point should be selected so that the target size range can be observed, eventually reducing the observation corridor, as ship induced waves might interfere with the observations. An inclinometer can be used to measure distances at sea (Doyle, 2007).

Table 5: Width of “observation corridor” based on observation height and ship speed (to be reviewed)

Observation elevation above sea	Ship speed 2 knots = 3.7 km/h	6 knots = 11.1 km/h	10 knots = 18.5 km/h
1 m	6m	4m	3m
3m	8m	6m	4m
6m	10m	8m	6m
10m	15m	10m	5m

The protocol will have to go through an experimental implementation phase during which it is applied in different sea regions by different institutions, its practicality is tested and feedback for definition of observation parameters is provided.

The observation, quantification and identification of floating litter items must be made by a dedicated observer who does not have other duties contemporaneously. Observation for small items and surveying intensively the sea surface leads to fatigue and consequently to observation errors. The transect lengths should therefore be selected in a way that observation times are not too long. Times of 1 h for one observer could be reasonable, corresponding to a length of a few kilometres.

4.6.2. Reporting of monitoring results

A harmonized reporting of monitoring results is crucial for the comparison of data. The data output from the application of the protocol, when using a computer interface, is a list of geo-referenced objects according to a list of categories. The use of a portable computer device for documenting marine floating litter has clear advantage over paper documents. A specific application, based on the TSG -ML protocol for the monitoring of floating macro litter will be developed by JRC and field tested within the PERSEUS project.

It is not uncommon that floating litter items appear grouped, either because they have been released together or because they accumulate on oceanographic fronts. The reporting system should acknowledge this and foresee a way to report such groups. The occurrence of such accumulation areas needs to be considered when evaluating the data.

For floating marine litter the unit of reporting will be: items/km². The data will be available for the different categories and size classes. They can then be aggregated at different levels for providing overview data.

Along with the litter occurrence data, a series of metadata should be recorded, including geo-referencing (coordinates) and wind speed (m/s). This accompanying data shall allow the evaluation of the data in the correct context.

4.6.3. Quality assessment/Quality control

The widespread acquisition of monitoring data will need some kind of inter-comparison or calibration in order to ensure comparability of data between different areas and over time, for trend assessments. Approaches for this should be developed and implemented. This can be hands (eyes)-on training courses with comparisons of observations. Such events should be organized at Regional level with further implementation at national scale.

A methodology for calibrating observation quality by artificial targets may be devised through research efforts.

4.6.4. Equipment

The equipment used for the monitoring of floating litter is very limited. Besides the transportation platform some instruments may facilitate the work:

- A system for visually marking the observation area,
- GPS for determination of ship speed and geographical coordinates,
- A tablet PC (with GPS) for documenting the results (including a dedicated application/program),
- A system for training and calibrating size classification.

4.6.5. Implementation of the TSG-ML Protocol

The finalization and wide acceptance of the protocol proposed by TSG –ML will require an experimental testing period during which observation parameters and reporting approaches are being studied on a wide range of ships and conditions, covering different regional seas. This can be achieved through the ECAP implementation process and through dedicated activities in research projects, such as PERSEUS. Resulting data can be used for adjusting the protocol. Once the protocol parameters, such as standardized size ranges, categories and observation conditions are confirmed, a final version can be prepared. The final protocol should be widely disseminated and accompanied by activities for its implementation. Training courses and workshops can contribute to the harmonized acquisition of comparable datasets.

4.7. Other methodologies

Open sea surveys

While the proposed protocol is aiming at coastal surveys, there are also approaches for monitoring of litter from large, seagoing vessels. While covering large areas, these surveys face considerably different observation conditions and therefore different observation protocols.

Aerial surveys

The opportunistic use of aerial surveys (e.g. for marine mammal observation/monitoring) has been considered. The minimum size of observed objects is at ca. 30 cm, therefore this approach might be adequate to the size fraction above 30 cm considered by the TSG-ML.

Net tow surveys for macro litter

Physical sampling of floating macro litter requires large net openings operated at the sea surface. Given the density of larger macro litter items occurrence this would require significant dedicated ship time and specific equipment. This method is applicable for floating micro litter. There should be methodological research on how to cover the size range between 5 mm and 2.5 cm, which is very relevant to ingestion by marine biota.

Riverine litter monitoring

While not envisaged in the current litter monitoring framework, the TSG –ML protocol is equally well applicable for the monitoring of floating litter on rivers as an indication of a potential source of loads of litter to the marine environment, by observation from bridges or similar platforms.

New methodologies

Closely related to the monitoring by human visual observation is the monitoring through image acquisition by digital camera systems and their subsequent analysis by image recognition techniques. Such is the Sealittercamera, which is being developed by the EC JRC, a system being temporarily deployed on Costa Crociere cruise ships in the Western Mediterranean Sea (Hanke, 2011, publication in preparation).

4.8. Conclusions

Key messages to the ECAP implementation process:

- The monitoring of floating marine litter in selected coastal transects is recommended
- Monitoring Marine Litter suspended in the middle water column is not recommended
- Monitored size categories should include a range covering relevant small items
- Monitoring of floating litter should follow a specific protocol agreed on a Regional scale within the ECAP/UNEP/MAP MED POL monitoring implementation process

5. Seafloor Litter (Common Indicator 17, Trends in the amount of litter in the water column including microplastics and on the seafloor)

5.1. Introduction to seafloor litter

The most common approaches to evaluate sea-floor litter distributions use opportunistic sampling. This type of sampling is usually coupled with regular fisheries surveys (marine reserve, offshore platforms, etc.) and programmes on biodiversity, since methods for determining seafloor litter distributions (e.g. trawling, diving, video) are similar to those used for benthic and biodiversity assessments. The use of submersibles or Remotely Operated Vehicles (ROVs) is a possible approach for deep sea areas although this requires expensive equipment. Monitoring programmes for demersal fish stocks, undertaken as part of the Mediterranean International Bottom Trawl Surveys (MEDITS), operate at large regional scale and provide data using a harmonized protocol, which may provide a consistent support for monitoring litter at Regional scale on a regular basis and within the ECAP requirements.

5.2. Scope and key questions to be addressed

For shallow waters, the monitoring of litter on the seafloor may not be considered for all coastal areas because of limited resources. In these areas the strategy is to be determined by each contracting Party at national level, depending on the priority areas to be monitored. Opportunistic approaches may be used to minimize costs. Valuable information can be obtained from on-going monitoring of benthic species in protected areas, during pipeline camera surveys, cleaning of harbours and through diving activities. Additional monitoring might have to be put in place to cover all areas creating a consistent monitoring network. The sampling strategy should enable the generation of good detail of data, in order to assess most likely sources, the evaluation of trends and the possibility of evaluating the effectiveness of measures. The TSG-ML proposes simple protocols based on existing trawling surveys and two alternative protocols based on diving and video imagery which fit with the ECAP requirements and support harmonisation at Regional level, if applied trans-nationally.

Trawling (otter or beam trawl) is an efficient method for large scale evaluation and monitoring of seafloor litter. The monitoring strategy for sea-floor can efficiently be based on on-going monitoring already developed at Regional level. It must be noted, however, that the geomorphology may impact

the accumulation of litter in the seafloor and some sampling restrictions in rocky areas (incompatible with trawling) may lead to underestimation of the quantities present. Designing and developing an adequate monitoring programme will have to take account of these limits. Existing fisheries stock assessment programmes are covering most Regional Seas.

Only some countries will have to consider deep sea areas in terms of monitoring of sea-floor litter. The strategy is to be determined by each Contracting Party at national level, depending on affected areas but previous results indicate that priority should be given to coastal canyons. Protocols based on video imagery are the only approaches to monitor deep sea areas. These protocols are based on the use of (ROVs)/submersibles. As litter accumulates and degrades slowly in deep sea waters, a multiyear evaluation will be sufficient.

5.3 Monitoring the shallow sea-floor (<20m)

The most commonly used method to estimate marine litter density in shallow coastal areas is to conduct underwater visual surveys with SCUBA/snorkelling. These surveys are best based on line transect surveys of litter on the sea-floor, which is derived from UNEP (Cheshire, 2009). The protocol is actually in use for evaluation of benthic fauna. It requires SCUBA equipment and trained observers. Only litter items above 2.5 cm are considered, between 0 and 20 m (to 40 meters with skilled divers).

5.3.1. Technical requirements

Frequency

The minimum sampling frequency for any site should be annually. Ideally it is recommended that locations are surveyed every three months (allowing an interpretation in terms of seasonal changes).

Transects

Surveys are conducted through 2 line transects for each site. Unbiased design-based inference requires allocating the transects randomly in the study area or on a grid of systematically spaced lines randomly superimposed. However, with a model-based approach like density surface modelling (DSM), it is not required that the line transects are located according to a formal and restrictive survey sampling scheme, although good spatial coverage of the study area is desirable. Line transect are defined with a nylon line, marked every 5 meters with resistant paints, that is deployed using a diving reel while SCUBA diving.

Individual litter within 4 m of the line (half of the width – W_t - of the line transects) are recorded. For each observed litter item, when possible, the corresponding line segment of occurrence and its perpendicular distance from the line (y_i - for the estimation of detection probability, measured with the use of a 2 m plastic rod), and litter size category (w_i) are recorded. The nature of the bottom/habitat is also recorded. The length of the line transects vary between 20 and 200 m, depending on the depth, the depth gradient, the turbidity, the habitat complexity and the litter density (Katsavenakis, 2009). Results are expressed in litter density (items/m² or items/ 100 m²).

Detectability

In distance sampling surveys, detectability is used to correct abundance estimations (Katsavenakis, 2009). The standard software for modelling detectability and estimating density/abundance, based on distance sampling surveys, is DISTANCE (Thomas et al., 2006).

5.3.2. Use of volunteers in shallow waters surveys

Recreational and professional scuba divers can provide valuable information on litter they see underwater and they are uniquely positioned to support benthic litter monitoring efforts. They can access, have the skills and the equipment needed to collect, record, and share information about litter they encounter underwater. Many dive clubs and dive shops organize underwater clean-ups, often in partnerships with NGOs or local governments. Many of these events, when managed, can be a valuable source of information and possibly be a part of a regular survey, monitoring or even assessment efforts while using volunteers.

For some Contracting Parties use of volunteer divers might be a good opportunity for shallow-water litter monitoring but standardization and conformity with common methodologies and tools such as those propose by TSG-ML should be achieved. Fixed sites, common frequency and sampling methodology can be easily established by each Contracting Party and training, material distribution etc. can be achieved relatively easily when partner NGOs or research institutions are involved.

5.4 Monitoring the Sea-floor (20-800m)

From all the methods assessed, trawling (otter trawl) has been shown to be the most suitable for large scale evaluation and monitoring (Goldberg, 1995, Galgani et al., 1995, 1996, 2000). Nevertheless there are some restrictions in rocky areas and in soft sediments, as the method may be restricted and/or underestimate the quantities present. This approach is however reliable, reproducible, allowing statistical processing and comparison of sites. As recommended by UNEP (Cheshire, 2009), sites should be selected to ensure that they (i) Comprise areas with uniform substrate (ideally sand/silt bottom); (ii) consider areas generating/accumulating litter, (iii) avoid areas of risk (presence of munitions), sensitive or protected areas; (iv) do not impact on any endangered or protected species. Sampling units should be stratified relative to sources (urban, rural, close to riverine inputs) and impacted offshore areas (major currents, shipping lanes, fisheries areas, etc.).

General strategies to investigate seabed litter are similar to methodology for benthic ecology and place more emphasis on the abundance and nature of items (e.g. bags, bottles, pieces of plastics) rather than their mass. The occurrence of international bottom trawls surveys such as MEDITS (Mediterranean/Black Sea) provide useful and valuable means for monitoring marine litter. These are using common gears depending on region (MEDITS net in the Mediterranean) and provide some harmonized and common conditions of sampling (20 mm mesh, 30-60 min tows, large sampling surface covered) and hydrographical and environmental information (surface & bottom temperature, surface & bottom salinity, surface & bottom current direction & speed, wind direction & speed, swell direction and height). More than 20 sampling units are sampled within each region as recommended by UNEP (Cheshire, 2009).

Therefore, the TSG-ML strongly recommends using these on-going and continuous programmes to collect data on marine litter in the sea-floor. This will enable to compare data from one country to another and to evaluate transnational transportation.

5.5 Technical Requirements

The protocol of the TSG-ML for sampling and trawling margins (20-800m) has been standardized for each region:

Mediterranean and Black Seas

For the Mediterranean Region, the protocol is derived from the MEDITS protocol (see the protocol manual, Bertran et al., 2007). The hauls are positioned following a depth stratified sampling scheme with random drawing of the positions within each stratum. The number of positions in each stratum is proportional to the surface of these strata and the hauls are made in the same position from year to year. The following depths (10 – 50; 50 – 100; 100 – 200; 200 – 500; 500 - 800 m) are fixed in all

areas as strata limits. The total number of hauls for the Mediterranean Sea is 1385; covering the shelves and slopes from 11 countries in the Mediterranean.

The haul duration is fixed at 30 minutes on depths less than 200m and at 60 minutes at depths over 200m (defined as the moment when the vertical net opening and door spread are stable), using the same GOC 73 trawl with 20 mm mesh nets (Bertran et al, 2007) and sampling between May and July, at 3 knots between 20 and 800 m depth.

Detecting trends

Consistency of results is based on sampling strategy and monitoring efforts. Long term monitoring of litter on the sea floor has been performed in Spain and France. In some cases such as the margins of gulf of Lion (France), trends studies (70 Stations, depth 40-800m,) indicated a statistically significant decrease [Abundance (10⁻⁴) = 0.038 x (Year) + 1.062 (R² =0.36)] enabling the measurement of 15% decrease in 15 years.

However, Power Analysis of IBTS related sampling by Cefas indicates that detection of a 10% change over 5 or 10 years is unlikely without massive sample sizes. However, 50% changes over 5 or 10 years look to be readily detectable with current designs based on fish stock surveys such as IBTS.

Data recording and Management

Templates for data recording have been integrated in MEDITS Manuals . Data on litter should be collected on these templates using items categories such as those listed for Sea-floor prepared by TSG-ML. Other elements from the haul operations should be also recorded – See MEDITS for the Mediterranean/Black Sea.

Data on litter should be reported as items/ha or items/km² before further processing and reporting.

5.6 Litter categories for Sea-floor

As marine litter degradation is affected by light, oxygen and wave action, the persistence of marine litter on the sea floor and deep sea floor is increased with notable outcomes on the nature of litter found. Another important factor influencing the composition of benthic litter is related to the type of activity. Typically, the analysis of sources indicated the importance and differences between ship based litter, as in the Southern North Sea, and land based litter such as in the Mediterranean. The definition of categories will have to take this in account when defining a protocol. Although marine litter is strongly affected by transportation, fishing has been shown as a main source of litter in some fishing or aquaculture grounds. Similarly specific types of marine litter were also found in areas affected by tourism, around beaches, as in the Mediterranean Sea. This may affect the strategy for monitoring selected areas, such as shallow waters.

A standardized litter classification system has been defined for monitoring the sea floor by TSG-ML. The categories were defined in accordance with types of litter found at regional level, enabling common main categories for all regions. The main categories have a hierarchical system including sub categories. It considers 4 main categories of material for the Mediterranean (wood, paper/cardboard, other, unspecified). There are various subcategories for a more detailed description of litter items. Other specific categories may be added by Contracting Parties and additional description of the item may provide added-value, as long as the main categories and sub-categories are maintained. Furthermore, the weight, picture and note of potential attached organisms may further complement the classification of items.

Other parameters

Site information and trawling sampling characteristics such as date, position, type of trawl, speed, distance, sampled area, depth, hydrographical and meteorological conditions should be recorded

Data-sheets should be filled out for each trawl and compiled by survey. If multiple counts (transects/observers) are run at any given site then a new sheet should be used for each trawl shot. After each survey data must be aggregated for analysis and reporting.

5.7. Complementary sea-floor monitoring – Video camera

Large-scale evaluations of marine litter in the deep sea-floor are scarce because of available resources to collect data. Special equipment is necessary including ROVs and/or submersibles that may be very expensive to operate, especially in deep sea areas.

Towed video camera for shallow waters (Lundqvist, 2013) or ROVs for deeper areas are simpler and generally cheaper and must be recommended for litter surveys. There are some available protocols where litter is counted on routes and expressed as item/km, especially when using submersibles/ROVs at variable depths above the deep sea floor (Galgani et al., 1996) however technology enables the evaluation of densities through video-imagery using a standardized approach especially for shallow waters.

5.8. Quality Assessment /Quality Control for sea-floor litter

Several Contracting Parties from UNEP/MAP MED POL have indicated they will use their fish stock surveys for benthic litter monitoring. This is considered to be an adequate approach although quantities of litter might be underestimated, given restrictions in some areas. The adoption of a common protocol will lead to a significant level of standardization among the Contracting Parties countries that apply this type of sampling strategy.

Data on litter in shallow sea-floor are collected through protocols already validated for benthic species.

Until now, no quality assurance programme has been considered for litter monitoring on the sea-floor. For MEDITS, sampling data are collected in the DATRAS database and participate in data quality checking for hydrographical and environmental conditions. This process may also support quality insurance for data on litter. Currently, there are on-going discussions on how to organize and harmonize a specific system to collect, validate and organize data through a common platform, enabling the review and validation of data. MEDITS has included litter data to be analysed within a specific sub-group.

5.9. Conclusions

Considering opportunities to couple monitoring efforts may be the best approach to monitor litter on the sea-floor.

There may be other opportunities to couple marine litter surveys with other regular surveys (monitoring in marine reserves, offshore platforms, etc.) or programmes on biodiversity.

6. Litter ingested by or entangling marine organisms, especially mammals, marine birds and turtles (Litter in Biota, Candidate Common Indicator 18, Trends in the amount of litter ingested by or entangling marine organisms focusing on selected mammals, marine birds and marine turtles)

Note: Due to the availability of protocols and the state of knowledge, it is recommended that the indicator focus on the sea turtle *Caretta caretta*

6.1. Scope and key questions to be addressed

In the North Sea, an indicator is available, which expresses the impact of marine litter (OSPAR EcoQO). It measures ingested litter in Northern Fulmar and it is used to assess temporal trends, regional differences and compliance with a set target for acceptable ecological quality in the North Sea area (Van Franeker et al., 2011). A combined protocol is proposed by TSG-ML which can be used for seabirds in general, e.g. to be applied in regular monitoring for shearwaters in parts of the Mediterranean.

However alternative tools are needed for the Mediterranean Sea. On the basis of available information and expertise, a monitoring protocol for marine litter in sea turtles with focus on relevant parameters for application in the Mediterranean is proposed by TSG-ML. The approach taken for the development of the protocols for ingestion consists of the application of the same categorization of marine litter for all ingestion studies of vertebrates. The applied standard categories follow the existing fulmar methodology, in which a number of plastic categories is counted, and weighted as a unit.

Additionally further knowledge is being compiled on the occurrence of entanglement events in marine organisms. Based upon these findings a harmonized protocol for the assessment of the use of plastic litter as nesting material and associated entanglement mortality in birds breeding colonies including shearwater is proposed by the TSG-ML for immediate application.

Entanglement in beached animals, entanglement in live animals (others than in relation to seabird nests), ingestion of litter by marine mammals, ingestion of litter by marine invertebrates and research on food chain transfer are reflected in the final report of the TSG-ML. However only ingestion of and entanglement in marine litter by marine mammals are considered by the TSG-ML for further development whereas the other aspects are crucial issues for research but not suitable to be recommended for wide monitoring application at this stage.

6.2. Seabirds

The methodology of the tool proposed by the TSG-ML follows the OSPAR Ecological Quality Objective (EcoQO) methods for monitoring litter particles in stomachs of northern fulmars (*Fulmarus glacialis*). The stomach contents of birds beached or otherwise found dead are used to measure trends and regional differences in marine litter. Background information and the technical requirements are described in detail in documents related to the fulmar EcoQO methodology. A pilot study evaluating methods and potential sources of bias was conducted by Van Franeker & Meijboom (2002). Bird dissection procedures including characters for age, sex, cause of death etc. have been specified in Van Franeker (2004). Further OSPAR EcoQO details were given in OSPAR (2008, 2010a, b) and in Van Franeker et al., (2011a, 2011b).

Related marine compartments:

Seabirds like fulmars or shearwaters are feeding on the surface of the sea. Therefore the water column and especially the water surface is the marine compartment addressed when quantifying litter in the stomachs of fulmars.

6.2.1. Technical requirements

Bird corpses are stored frozen until analysis. Standardized dissection methods for Fulmar corpses have been published in a dedicated manual (Van Franeker, 2004) and are internationally calibrated during annual workshops. Stomach content analyses and methods for data processing and presentation of results were described in full detail in Van Franeker & Meijboom (2002) and updated in later reports. The methodology has been published in peer reviewed scientific literature (van Franeker et al., 2011a, b). For convenience, some of the methodological information is repeated here in a condensed form.

At dissections, a full series of data is recorded to determine sex, age, breeding status, likely cause of death, origin, and other issues. Age, the only variable found to influence litter quantities in stomach contents, is largely determined on the basis of development of sexual organs (size and shape) and presence of Bursa of Fabricius (a gland-like organ positioned near the end of the gut which is involved in immunity systems of young birds; it is well developed in chicks, but disappears within the first year of life or shortly after). Further details are provided in Van Franeker 2004.

After dissection, stomachs of birds are opened for analysis. Stomachs of Fulmars have two 'units': initially food is stored and starts to digest in a large glandular stomach (the proventriculus) after which it passes into a small muscular stomach (the gizzard) where harder prey remains can be processed through mechanical grinding. For the purpose of most cost-effective monitoring, the contents of proventriculus and gizzard are combined, but optional separate recordings should be considered where possible.

Stomach contents are carefully rinsed in a sieve with a 1mm mesh and then transferred to a petri dish for sorting under a binocular microscope. The 1 mm mesh is used because smaller meshes become easily clogged with mucus from the stomach wall and with food-remains. Analyses using smaller meshes were found to be extremely time consuming and particles smaller than 1 mm seemed rare in the stomachs, contributing little to plastic mass.

If oil or chemical types of pollutants are present, these may be sub-sampled and weighed before rinsing the remainder of stomach content. If sticky substances hamper further processing of the litter objects, hot water and detergents are used to rinse the material clean as needed for further sorting and counting under a binocular microscope.

Litter Categories – source related information

In the Fulmar EcoCO, stomach contents are sorted into categories, and this categorisation is followed for marine biota monitoring ingestion in seabirds, marine turtles and fish.

The fulmar categorisation of stomach contents is based on the general 'morphs' of plastics (sheet-like, filament, foamed, fragment, other) or other general rubbish or litter characteristics. This is because in most cases, particles cannot be unambiguously linked to particular objects. But where such is possible, under notes in datasheets, the items should be described and assigned a litter category number using as master list, such as the "Master List" developed by the TSG ML group.

For each litter category/subcategory an assessment is made of:

- 1) incidence (percentage of investigated stomachs containing litter);
- 2) abundance by number (average number of items per individual), and
- 3) abundance by mass (weight in grams, accurate to 4th decimal)

Because of potential variations in annual data, it is recommended to describe 'current levels' as the average for all data from the most recent 5-year period, in which the average is the 'population average' which includes individuals that were found to have zero litter in the stomach.

As indicated, EcoQO data presentation for Northern Fulmars is for the combined contents of glandular (proventriculus) and muscular (gizzard) stomachs. Results of age groups are combined except for chicks or fledglings which should be dealt with separately. Potential bias from age structure in samples should be checked regularly.

Size range

In the fulmar monitoring scheme, stomach contents are rinsed over a sieve with mesh 1 mm prior to further categorisation, counting and weighing. The size range of plastics monitored is thus ≥ 1 mm. Unpublished data on particle size details in stomachs of fulmars show that a smaller mesh size would not be of use because smaller items have passed into the gut.

Spatial coverage

Dead birds are collected from beaches or from accidental mortalities such as long-line victims; fledgling road kills etc. (for methodology see Van Franeker, 2004).

Survey frequency

Continuous sampling is required. A sample size of 40 birds or more is recommended for a reliable annual average for a particular area. However, also years of low sample size can be used in the analysis of trends as these are based on individual birds and not on annual averages. For reliable conclusions on change or stability in ingested litter quantities, data over periods of 4 to 8 years (depending on the category of litter) is needed.

Maturity of the tool

The method is mature and in use.

Regional applicability of the tool

The tool is applicable to the regions where fulmars occur; for similar seabird species such as any of the family of the tubenoses, the methodology can follow this approach. This could for example be applied to shearwater species occurring in the Mediterranean Sea.

6.2.2. Quality Assessment /Quality Control

The methodology referred to in this tool is based on an agreed OSPAR methodology which has been developed over a number of years with ICES and OSPAR and which has received full quality assurance by publication in peer reviewed scientific literature (Van Franeker et al., 2011a). The EcoQO methodology has been fully tested and implemented on Northern Fulmars *Fulmarus glacialis*, including those from Canadian Arctic and northern Pacific areas. All methodological details can be applied to other tubenosed seabirds (Procellariiformes) with no or very minor modifications. Trial studies are being conducted using shearwaters from the more southern parts of the north Atlantic and Mediterranean. In other seabird families, methods may have to be adapted as stomach morphology, foraging ecology, and regurgitation of indigestible stomach contents differ and can affect methodological approaches.

Trend assessment

In the Fulmar EcoQO, statistical significance of trends in ingested litter, i.e. plastics, is based on linear regression of ln-transformed data for the mass of litter (of a chosen category) in individual stomachs against their year of collection. 'Recent' trends are defined as derived from all data over the most recent 10-year period. The Fulmar EcoQO focuses on trend analyses for industrial plastics, user plastics, and their combined total.

6.3. Sea turtles

The stomach contents of stranded Loggerhead sea turtles *Caretta caretta* (Linnaeus, 1758) are used to measure trends and regional differences in marine litter. A recent pilot study evaluating methods and potential sources of bias was conducted during 2012 by ISPRA, CNR-IAMC Oristano, Stazione Zoologica Napoli; University of Siena, University of Padova, ArpaToscana.

Related marine compartments

Caretta caretta feeds in the water column and at the seafloor. Therefore these two marine compartments are addressed when quantifying litter in the stomachs of stranded Loggerhead sea turtles.

6.3.1. Technical requirements

The Loggerhead sea turtle *Caretta caretta* is a protected species (CITES Appendix I), therefore only authorized people can handle them.

Upon finding the animal, its discovery should be reported to the main authorities and the operation of coordinated with the local authorities (depending on national law). Based on initial observations and if possible still at the place of discovery, some data should be recorded on an “Identification Data” Sheet. The animal should be transported to an authorized service centre for necropsy. In case the body is too decomposed, the integrity of the digestive tract should be assessed before disposal at the licensed contractor. If the necropsy cannot be carried out immediately after recovery, the carcass should be frozen at -16 ° C, in the rehabilitation facility.

Before the necropsy operation, morphometric measurements should be collected and recorded on an appropriate Data Sheet. External examination of the animal should be conducted, including inspecting the oral cavity for possible presence of foreign material. The methodology suggested in the TSG ML report could be followed to carry out a dissection of the animal to expose the gastrointestinal system (GI).

The following sampling procedure of GI contents can be applied to any section of the GI: the section of the GI should be placed in a graduated beaker of adequate size, pre-weighed on electronic balance (accuracy of ± 1 g). The section of GI should be open and the contents emptied into the beaker with the help of a spatula, followed by the record of the net weight and volume of the content. The section of the GI should be observed and any ulcers or any lesions caused by hard plastic items should be recorded.

The contents should be inspected for the presence of any tar, oil, or particularly fragile material that must be removed and treated separately. The liquid portion, mucus and the digested unidentifiable matter should be removed, by washing the contents with freshwater through a filter mesh 1 mm, followed by a rinse of all the material collected by the filter 1mm in 70% alcohol and finally again in freshwater. The retained content should be enclosed in plastic bags or pots, labelled and frozen, not forgetting the sample code and corresponding section of the GI. Finally, the contents can then be sent for analysis.

NOTE: If the contents are stored in liquid fixative, note of the compound and the percentage of dilution should be noted and communicated to the staff in charge of further analysis.

For the analysis of the contents of the GI, the organic component should be separated from any other items or material (marine litter). The fraction of marine litter should be analysed and categorised with the help of a stereo-microscope, following the approach used in the protocol for ingestion in birds (Van Franeker et al., 2005; 2011b; Matiddi et al., 2011) and using a Standard Data-Sheet.

The fraction of marine litter should be dried at room temperature and the organic fraction at 30°C. Both fractions should be weighted, including the different categories of items identified within the marine litter fraction. The volume of the litter found should also be measured, through the variation of water level in a graduated beaker, when the items are immersed without air. If possible, different categories of “food” should also be identified. Otherwise, the dry contents should be kept in labelled bags and sent to an expert taxonomist.

An optional methodology for application for sampling litter excreted by live sea-turtles (faecal pellet analysis) in case of finding a specimen alive is recommended by the TSG-ML.

Extraction of data

Following the protocol for seabirds, abundance by mass (weight in grams, accurate to 3th decimal) is the main information useful for the monitoring programme.

Data entry is carried out using a Standard Form.

Litter Categories - source related information

For turtle analyses, stomach contents are sorted into the same categories as for birds. Following the method for seabirds, abundance by mass (weight in grams, accurate to 3th decimal) is the main information useful for the monitoring programme. Other information such as the colour of items, volume of litter, different type of litter, different incidence of litter in oesophagus, intestine and stomach, incidence and abundance by number per litter category, are useful for research and impact analysis.

Size range

≥1 mm (stomach contents are rinsed over 1 mm mesh sieve)

Spatial coverage

Dead sea turtles are collected from beaches or at sea from accidental mortalities such as victims of long-line fishing (by catch) or of boat collisions.

Survey frequency

Continuous sampling is required. Minimum sample population size for year and period of sampling must be established for reliable conclusions on change or stability in ingested litter quantities.

Maturity of the tool

The tool is not considered mature at this stage. Specific monitoring programmes are required.

Regional applicability of the tool

The tool is applicable to the Mediterranean Sea region.

6.3.2. Quality assurance/quality control

There is a lack of quality assurance/quality control (QA/QC) due to lack of long-term monitoring programmes. More publications in peer reviewed scientific literature are required.

Trend assessment

Specific long-term monitoring programmes are required.

Target definitions

Specific long monitoring programmes are required.

6.4. Considerations on further options for monitoring impacts of marine litter on biota

6.4.1. Entanglement rates among beached animals

Direct harm or death is more easily observed and thus more frequently reported for entanglement than for ingestion of litter. This applies to all sorts of organisms, marine mammals, birds, turtles, fishes, crustaceans etc.

It is, however, difficult from simply looking at the outside appearance of an animal to identify whether a particular individual has died because of entanglement in litter rather than from other causes, mainly entanglement in active fishery gear (by-catch). Nevertheless it is possible to differentiate between

animals that have died quickly due to entanglement and sudden death in active fishing gear and those suffering a long drawn out death after entanglement in pieces of nets, string or other litter items, because entangled birds, which have been entangled for a time before death are emaciated.

Proportions of sea birds found dead with actual remains of litter attached as evidence for the cause of mortality are extremely low. The possible use of entangled beached birds as an indication of mortality due to litter will be further investigated by the TSG-ML.

In marine mammals, numbers of beached animals and especially cetaceans are often high and many have body marks suggesting entanglement, although remains of ropes or nets on the corpses are mostly rare. Given that in a number of places well working stranding networks are already in place, dead marine mammals should, whenever possible, become subject to pathologic investigations which need to include an assessment for the cause of disease and death and the relevance of marine litter in this connection.

This issue will be further investigated and the development of a dedicated monitoring protocol for the entanglement of marine mammals in marine litter will be considered in the next report of the TSG ML.

6.4.2. Ingestion of litter by marine mammals and entanglement.

Ingestion of litter by a wide range of whales and dolphins is known. Although known rates of incidences of ingested litter are generally low to justify a standard ECAP monitoring recommendation at this point, it can also be argued that the number of pathologically studied animals is low as well. Dead marine mammals should, whenever possible, become subject to pathologic investigations which need to include an assessment for the cause of disease and death and the relevance of ingested marine macro- and microlitter in this connection.

The development of a monitoring protocol for the ingestion of marine litter in the different size categories by marine mammals will therefore be considered in the next report of the TSG ML. Opportunistic monitoring of marine mammals is envisaged under the population demographic characteristics component of the EcAp biodiversity common indicators.

7. **Microlitter (with special reference to microplastics)**

7.1. **Introduction to microlitter**

In effect microparticles consist of similar materials to other types of litter; they are merely pieces of litter at the very small end of the size spectrum. Microparticles of a range of common material types including glass, metal, plastic and paper litter are undoubtedly present in the environment. The focus is on microplastics, implying that they are considered to be the most significant component of the microlitter in the environment. This statement is partly based on the frequency of reports of microplastics (Hidalgo-Ruz et al. 2012, but relative proportions of material types will be influenced by the physical conditions of the habitat sampled, for example metal and glass microlitter is not likely to be found at the sea surface.

When first described the term microplastic was used to refer to truly microscopic particles in the region of 20 µm diameter (Thompson et al. 2004. The definition has since been broadened to include all particles < 5 mm (Arthur et al. 2009. Microplastics are widely dispersed in the environment and are present in the water column, on beaches and on the seabed.

Under EcAp, it is considered that in order to achieve GES that the quantities of microplastics in the environment should not result in harm. When defining methodological criteria it is essential to recognise that our understanding of the potential impacts of microplastic on organisms and the

environment (i.e. the ‘harm’ that they might pose from the perspective of EcAp) is still not fully understood.

An upper size bound of 5mm has been widely (but not exclusively) adopted and for the purpose of EcAp it is suggested that the upper bound to be taken to as items <5mm in their largest dimension as recommended by the TSG-ML. Current definitions do not explicitly state a lower size limit and lower size limits have seldom been reported for microplastic concentrations in the environment. The lower size limit is perhaps assumed to be the mesh size of the net or sieve through which the sample passed during the sampling, sample preparation or extraction. The size limits of microplastic particles that can be reported are also dependent on the method of detection, in many cases microscope-aided visual inspection. When identifying microparticles there are also size limits imposed by the analytical techniques employed (e.g. minimum sample intake requirements for detection and analysis). Hence an important part of establishing standard methods and protocols within EcAp will first be to define the appropriate size range, and this aspect is considered in the report of the TSG-ML.

After an initial period of discovery, microplastics research now finds itself at a stage of development where there is a lack of quality assurance/quality control (QA/QC) instruments available: e.g. no organisations yet offer proficiency training or testing, there have been no inter-laboratory studies, no certified reference materials are available, no standardized sampling and analysis protocols have been published, no accreditation certificates have been issued and some procedures in use have not yet been validated. Approaches for QA/QC will therefore be very useful for evaluating sources of variability and error and increasing confidence in the data collected.

Microplastics comprise a very heterogeneous assemblage of pieces that vary in size, shape, colour, specific density, polymer type, and other characteristics. For meaningful comparisons and to answer the specific questions and to test hypotheses through monitoring, it is important to define methodological criteria to quantify such metrics as for e.g. the abundance, distribution and composition of microplastics and to ensure sampling effort is sufficient to detect the effects of interest. Protocols to monitor microplastic in sediments, sea surface, and biota have been prepared by the TSG-ML. At present our understanding of the sources, distribution and fate of microplastics in the environment are very limited, as is our understanding of any associated effects on wildlife. As a consequence it is not possible to present fully validated standard operating procedures. Instead the TSG-ML presents recommendations for monitoring supported by a discussion of considerations and limitations according to the knowledge base at the time of writing. It considers monitoring design, sampling, analysis, reporting. The aim of the TSG-ML text is to maximise consistency and comparability of future data collection by recommending approaches.

7.2. General Sampling Methods

Sampling of microplastics in different main marine environments (sea surface, water column, sediment and biota) has been approached using a variety of methods: samples can be selective, bulk, or pre-treated to reduce their volume (Hidalgo-Ruz et al., 2012).

Most studies use a combination of these steps after which a purification step is required to sort the micro litter from natural particulates. Visual characterisation is the most commonly used method for the identification of microplastics (using type, shape, degradation stage, and colour as criteria). Chemical and physical characteristics (e.g., specific density) can also be used. However, the most reliable method is to identify the chemical composition of microplastics by infrared spectroscopy (Hidalgo-Ruz et al., 2012). This approach requires equipment that may be considered relatively costly compared to sampling of large items of debris.

In all four compartments (sea surface, water column, sediment and biota) the TSG-ML recommends quantifying microplastics in the size range 20µm to 5mm. Since the lower size limit is perhaps

assumed to be the mesh size of the net or sieve through which the sample passed during the sampling, sample preparation or extraction, for sampling purposes this could in the majority of cases taken to be 330 μm . Microplastics should be categorised according to their physical characteristics including size, shape and colour. Categories used to describe microplastics appearance are available in the TSG M-L report. To achieve the greatest efficiency regarding sampling frequency it is recommended that microparticles be sampled alongside other routine sampling programmes. Sampling of the sea surface could be incorporated into routine monitoring programmes.

Sampling seawater for microplastics

Seawater samples have mostly taken by nets, the main advantage being that large volumes of water can be sampled quickly, retaining the material of interest. Most studies from surface waters have used Neuston nets and from the water column, zooplankton nets. Another instrument, that is deployed on a global scale and that has also been used for microplastic sampling is the continuous plankton recorder (CPR). The most relevant characteristics of the sampling nets are mesh size and the opening area of the net. Mesh sizes used for microplastic sampling range from 0.053 to 3 mm, with a majority of the studies (rather than individuals samples collected) ranging from 0.30 to 0.39 mm. The net aperture for rectangular openings of neuston nets (sea surface) ranged from 0.03 to 2.0 m^2 . For circular-bongo nets (water column) the net aperture ranged from 0.79 to 1.58 m^2 . The length of the net for sea surface samples has varied from 1.0 to 8.5 m, with most nets being 3.0 to 4.5 m long. Techniques using apparatus to collect seawater and pass it through a filter on-board ship are being developed where the ship water inlet is used, collecting seawater from the side at specified depths, mostly ranging between 4m and 1m depth. The seawater is passed through sieves or nets in closed containers after which these can be removed and analysed for microplastics.

A key consideration in collecting seawater samples is the cost of ship time. Hence the advantage to sample during existing cruises or from existing monitoring programmes such as the Continuous Plankton Recorder. Manta and bongo nets have been used at the sea surface. With nets it is important to deploy the trawl out of the wake zone as turbulence inside the wake zone does not allow for a representative sample to be collected. A spinnaker boom or 'A' frame may be used to deploy the trawl away from the side of the vessel. A close eye on the net while trawling would need to be kept to observe its performance and adjust speed and cable length if necessary. Sampling at the peak of plankton blooms should be avoided as this may clog the net.

Since most plastics are buoyant they are likely to accumulate at the sea surface. Surface sampling techniques can be used close inshore, but are restricted to calmer weather conditions, whereas CPR and other sub surface approaches can be used in rougher weather. High speed Manta trawls can be deployed in a range of sea states, but CPR is the least sensitive to sea state and samples at an average depth of around 6m. Manta trawls can be used to sample large volumes of surface water, but are relatively insensitive to smaller size fractions (< 1mm) which can be difficult to separate or sort from the large surface area of the net. CPR has a very much smaller aperture (around 1.6 cm^2) and hence samples smaller quantities of water per km but can be deployed for much longer periods (distances) than the Manta trawl without clogging. With the CPR the entire filter is sealed automatically and then transferred to the laboratory for examination under the microscope. Preliminary data indicate CPR and Manta nets collect similar quantities of debris per unit volume of water sampled; however because of the larger aperture of nets such as Manta the quantity of debris collected per distance towed is substantially greater than CPR. During trawls it is important to maintain a steady linear course at a constant speed. A hi-speed manta trawl can be deployed up to 8 knots, building up the speed slowly towards maximum speed. Higher speeds reduce the ability to sieve seawater, creating a bow wake in front of the trawl. For surface samples, results are most often expressed as items/ meter square, because the vertical movements of neuston and manta nets do not enable estimations of net opening.

At present it is not appropriate to recommend one approach over all others. Each approach has advantages and disadvantages and may be preferable according to local availability / sampling

opportunities, the characteristics of the area to be sampled. The recommendation of the TSG-ML is to obtain samples from sea water and to ensure the following details are recorded to accompany each sample: type of net, aperture, mesh size (preferably 333 μm mesh, 6m length for greatest inter-comparability among sampling programmes). It is not possible to specify standard haul duration as at some times of year, for example during a plankton bloom, nets may readily become clogged with natural material rendering them inefficient – a duration of 30 min is suggested and the duration of the trawl and the estimated water volume must be recorded. Samples from nets should be stored in glass jars taking care to rinse material as thoroughly as possible from the sides of the net using filtered sea water. Microparticles are recorded as the total quantity of such captured by the net during the period it is deployed.

The TSG-ML report provides detailed information on Laboratory analyses of microplastics samples collected in the field and detailed protocol for sampling surface waters.

ECOLOGICAL OBJECTIVE 10: Marine and coastal litter do not adversely affect the coastal and marine environment

Common Indicator description	DESCRIPTION Parameters and/or Elements, matrix	Assessment Method	Guidelines Reference Methods QA/QC	Recommendations /Additional Data needed
<p>Common indicator 16, COP 18 Indicator 10.1.1.:</p> <p>Trends in the amount of litter washed ashore and/or deposited on coastlines, including analysis of its composition, spatial distribution and, where possible, source.</p>	<p>Counts of litter items minimum lower limit 0.5 cm in the longest dimension on at least 1 section of coastline of 100m on lightly to moderately littered beaches (optimum 2 sections) and 2 sections of 100m on heavily littered beaches (exceptionally 50m section with a normalization factor of up to 100m to ensure coherence),</p>	<p>UNEP/MAP MED POL Trend Monitoring Programme</p> <p>At least 2 surveys per year in spring and autumn (Ideally 4 surveys per year in spring, summer, autumn and winter)</p>	<p>As Guideline, with reference methods: UNEP DEPI (MED) WG 394. Inf.5</p> <p>QA according to recommended Quality Assurance Protocols (i.e. Ocean Conservancy National Marine Debris Monitoring Programme (Sheavly, 2007, see text of ECAP monitoring guidelines)</p>	

<p>With Operational Objective10.1.:</p> <p>The impacts related to properties and quantities of marine litter in the marine and coastal environment are minimized</p> <p>Pressure, Impact indicator</p>				
--------------------------------------------------------------------------------------------------------------------------------------------------------------------------------------------------------------------------------------------------------	--	--	--	--

<p>Common indicator 17, COP 18 Indicator 10.1.2: Trends in amounts of litter at sea, including micro-plastics* and on the seafloor With Operational Objective of 10.1: The impacts related to properties and quantities of marine litter in the marine and coastal</p>	<p>Litter in the water column: Items of floating litter, 2.5 to 50cm, per km² Litter on the seafloor shallow coastal waters(0-20m): visually surveyed litter items size above 2.5cm Litter on the seafloor 20-800m: items/ha or items/km² of litter collected in bottom trawl surveys</p>	<p>For floating litter visual ship-based monitoring of floating litter 2.5cm to 50cm as items/km² For litter on the seafloor shallow coastal waters (0-20m): minimum annual, maximum quarterly underwater visual surveys with SCUBA/snorkelling based on line transect surveys in use for evaluation of benthic fauna For seafloor 20-800m collection of litter data through on-going and continuous bottom</p>	<p>For Guideline and reference methods: UNEP DEPI (MED) WG 394. Inf.5 For floating litter: approaches for inter-comparison and calibration are to be developed at regional level and implemented For shallow seafloor: Data on litter in shallow sea-floor are collected through protocols already validated for benthic species. For Litter on the seafloor 20-800m, the adoption of a</p>	<p>It is recommended to focus on surface and sea floor litter *For microplastics at the surface, samples taken by zooplankton nets (333µm mesh, 6m length, sampling for 30 minutes) or by Continuous Plankton Recorder (CPR). Minimum size 330 µm Collection of data on microplastics is costly and it will be critical to identify monitoring approaches (and associated metadata such as QA/QC) that directly support the</p>
--------------------------------------------------------------------------------------------------------------------------------------------------------------------------------------------------------------------------------------------------------------------------------------------------------------------------------------------------------------------------------	-----------------------------------------------------------------------------------------------------------------------------------------------------------------------------------------------------------------------------------------------------------------------------------------------------------------------------------------------------	----------------------------------------------------------------------------------------------------------------------------------------------------------------------------------------------------------------------------------------------------------------------------------------------------------------------------------------------------------------------------------------------------------------------------------------------	---------------------------------------------------------------------------------------------------------------------------------------------------------------------------------------------------------------------------------------------------------------------------------------------------------------------------------------------------------------------------------------------------------------------------------	---------------------------------------------------------------------------------------------------------------------------------------------------------------------------------------------------------------------------------------------------------------------------------------------------------------------------------------------------------------------------------------------------------------------------------------------------

<p>environment are minimized</p> <p>Pressure, Impact</p>		<p>trawl fish stock survey programmes (such as MEDITS)</p>	<p>common fish stock survey benthic- trawl protocol will lead to a significant level of standardization among the countries that apply it as their benthic litter sampling strategy.</p>	<p>aims of the indicator.</p> <p>Because of the relative infancy of microplastics research it is essential that existing proposed approaches would need to be re-evaluated and refined as new information emerges.</p>
<p>Candidate Indicator 18,</p> <p>COP18 Indicator 10.2.1.:</p> <p>Trends in the amount of litter ingested by or entangling marine</p>	<p>Quantities of ingested litter (minimum size 1mm), by mass (weight in grams) from stomach contents of seabirds (any of the family of the tubenoses - Procellariiformes i.e. shearwater species)</p> <p>Quantities of ingested litter (minimum size 1mm) by mass (weight in grams) in the stomach contents of stranded Loggerhead sea turtles (<i>Caretta caretta</i>)</p>	<p>Continuous sampling of dead birds collected from beaches or accidental mortalities such as long line victims, fledgling road-kills etc., to obtain a sample size of 40 birds or more for a reliable annual</p>	<p>For Guidelines and reference methods:</p> <p>UNEP DEPI (MED) WG 394. Inf.5</p> <p>For seabirds the methodology is based on OSPAR methodology which has received full</p>	<p>For seabirds, the tool works only locally</p> <p>For sea turtles the tool require a validation (long term data, QA/QC).</p> <p>Specific</p>

<p>organisms, especially mammals, marine birds and turtles</p> <p>With Operational Objective:</p> <p>10.2. Impacts of litter on marine life are controlled to the maximum extent practicable</p> <p>Impact</p>		<p>average for a particular area or lower sample sizes for the analysis of trends based on individual birds</p> <p>Continuous sampling of dead sea turtles collected from beaches or at sea from accidental mortalities such as victims of long-line fishing (by-catch) or of boat collisions.</p>	<p>quality assurance by publication in peer reviewed scientific literature.</p> <p>For sea turtles there is a lack of QA/QC due to the lack of long-term monitoring programmes</p>	<p>monitoring programmes are required to commence as pilots, to establish minimum sample population size for year and period of sampling, for reliable conclusions on change or stability in ingested litter quantities.</p> <p>This issue of entanglement requires further investigation for the development of a dedicated monitoring protocol for the entanglement of marine organisms in marine litter</p>
-----------------------------------------------------------------------------------------------------------------------------------------------------------------------------------------------------------------------	--	----------------------------------------------------------------------------------------------------------------------------------------------------------------------------------------------------------------------------------------------------------------------------------------------------	------------------------------------------------------------------------------------------------------------------------------------------------------------------------------------	----------------------------------------------------------------------------------------------------------------------------------------------------------------------------------------------------------------------------------------------------------------------------------------------------------------------------------------------------------------------------------------------------------------

ANNEX: MEDPOL Form for 100 m beach monitoring

ID	PLASTIC/POLYSTYRENE	N° units
G1	4/6-pack yokes, six-pack rings	
G3	Shopping bags incl. pieces	
G4	Small plastic bags, e.g. freezer bags incl. pieces	
G5	Plastic bag collective role; what remains from rip-off plastic bags	
G7/G8	Drink bottles	
G9	Cleaner bottles & containers	
G10	Food containers incl. fast food containers	
G11	Beach use related cosmetic bottles and containers, e.g. Sunblocks	
G13	Other bottles & containers	
G14	Engine oil bottles & containers <50 cm	
G15	Engine oil bottles & containers >50 cm	
G16	Jerry cans (square plastic containers with handle)	
G17	Injection gun containers (including nozzles)	
G18	Crates and containers / baskets	
G19	Car parts	
G21/24	Plastic caps and lids (including rings from bottle caps/lids)	

G26	Cigarette lighters	
G28	Pens and pen lids	
G29	Combs/hair brushes/sunglasses	
G30/31	Crisps packets/sweets wrappers/ Lolly sticks	
G32	Toys and party poppers	
G33	Cups and cup lids	
G34/35	Cutlery and trays/Straws and stirrers	
G36	Fertiliser/animal feed bags	
G37	Mesh vegetable bags	
G40	Gloves (washing up)	
G41	Gloves (industrial/professional rubber gloves)	
G42	Crab/lobster pots and tops	
G43	Tags (fishing and industry)	
G44	Octopus pots	
G45	Mussels nets, Oyster nets including plastic stoppers	
G46	Oyster trays (round from oyster cultures)	
G47	Plastic sheeting from mussel culture (Tahitians)	
G49	Rope (diameter more than 1cm)	
G50	String and cord (diameter less than 1 cm)	
G53	Nets and pieces of net < 50 cm	
G54	Nets and pieces of net > 50 cm	

G56	Tangled nets/cord	
G57/58	Fish boxes - plastic or polystyrene	
G59	Fishing line/monofilament (angling)	
G60	Light sticks (tubes with fluid) incl. Packaging	
G62/63	Floats for fishing nets/ Buoys	
G65	Buckets	
G66	Strapping bands	
G67	Sheets, industrial packaging, plastic sheeting	
G68	Fibre glass/fragments	
G69	Hard hats/Helmets	
G70	Shotgun cartridges	
G71	Shoes/sandals	
G73	Foam sponge	
G75	Plastic/polystyrene pieces 0 - 2.5 cm	
G76	Plastic/polystyrene pieces 2.5 cm - 50 cm	
G77	Plastic/polystyrene pieces > 50 cm	
G91	Biomass holder from sewage treatment plants	
G124	Other plastic/polystyrene items (identifiable) including fragments	

Please specify the items
 included in G124

ID	RUBBER	N° units
G125	Balloons and balloon sticks	
G127	Rubber boots	
G128	Tyres and belts	
G134	Other rubber pieces	

Please specify the items
 included in G134

ID	CLOTH	N° units
G137	Clothing / rags (clothing, hats, towels)	
G138	Shoes and sandals (e.g. Leather, cloth)	
G141	Carpet & Furnishing	
G140	Sacking (hessian)	
G145	Other textiles (incl. rags)	

Please specify the items included in G145

ID	PAPER / CARDBOARD	N° units
G147	Paper bags	
G148	Cardboard (boxes & fragments)	
G150	Cartons/Tetrapack Milk	
G151	Cartons/Tetrapack (others)	
G152	Cigarette packets	
G27	Cigarette butts and filters	
G153	Cups, food trays, food wrappers, drink containers	
G154	Newspapers & magazines	
G158	Other paper items,including fragments	

Please specify the items included in G158

ID	PROCESSED / WORKED WOOD	N° units
G159	Corks	

G160/161	Pallets / Processed timber	
G162	Crates	
G163	Crab/lobster pots	
G164	Fish boxes	
G165	Ice-cream sticks, chip forks, chopsticks, toothpicks	
G166	Paint brushes	
G171	Other wood < 50 cm	
Please specify the items included in G171		
G172	Other wood > 50 cm	
Please specify the items included in G172		

ID	METAL	N° units
G174	Aerosol/Spray cans industry	
G175	Cans (beverage)	
G176	Cans (food)	
G177	Foil wrappers, aluminium foil	
G178	Bottle caps, lids & pull tabs	

G179	Disposable BBQ's	
G180	Appliances (refrigerators, washers, etc.)	
G182	Fishing related (weights, sinkers, lures, hooks)	
G184	Lobster/crab pots	
G186	Industrial scrap	
G187	Drums, e.g. oil	
G190	Paint tins	
G191	Wire, wire mesh, barbed wire	
G198	Other metal pieces < 50 cm	
Please specify the items included in G198		
G199	Other metal pieces > 50 cm	
Please specify the items included in G199		

ID	GLASS	N° units
G200	Bottles incl. pieces	
G202	Light bulbs	
G208	Glass fragments >2.5cm	
G210a	Other glass items	

Please specify the items included in G210a

ID	CERAMICS	N° units
G204	Construction material (brick, cement, pipes)	
G207	Octopus pots	
G208	Ceramic fragments >2.5cm	
G210b	Other ceramics items	

Please specify the items included in G210b

ID	SANITARY WASTE	N° units
G95	Cotton bud sticks	
G96	Sanitary towels/panty liners/backing strips	
G97	Toilet fresheners	
G98	Diapers/nappies	
G133	Condoms (incl. packaging)	
G144	Tampons and tampon applicators	
	Other sanitary waste	

Please specify the other sanitary items

ID	MEDICAL WASTE	N° units
G99	Syringes/needles	
G100	Medical/Pharmaceuticals containers/tubes	
G211	Other medical items (swabs, bandaging, adhesive plaster etc.)	

Please specify the items included in G211

ID	FAECES	N° units
G101	Dog faeces bag	

ID	PARAFFIN/WAX PIECES	N° units
G213	Paraffin/Wax	

Presence of industrial pellets?	YES	<input type="checkbox"/>
	NO	<input type="checkbox"/>

Presence of oil tars?	YES <input type="checkbox"/>
	NO <input type="checkbox"/>

ADDITIONAL COMMENTS

Annex III, Appendix 3

Guide on Fishing for Litter Best Practices

TABLE OF CONTENTS

Background	2
1. Introduction	3
2. Objective	4
3. Implementing a Fishing for Litter practice step by step	5
3.1. Selection of fishing harbours and vessels	5
3.2. Marine litter collection	6
3.3. Marine litter reception	6
3.4. Marine litter management	6
3.5. Additional steps	7
3.5.1. Appointment of a coordinator	7
3.5.2. Public relations campaign and other incentives	7
3.5.3. Monitoring of the collected litter	9
3.5.4. Monitoring and evaluation of the Fishing for Litter practice	9
4. Health and safety implications	9
5. Environmental impact assessment including transboundary impacts	10
6. References	10
Annex 1. Monitoring forms	12
Annex 2. Summary of the FfL projects	17
Annex 3. Elements for the health and safety risk assessment	20

Background

Marine litter has been acknowledged at global level as an emerging threat with significant implications for the marine and coastal environment. Its impacts are environmental, economic, health and safety and cultural, and are rooted in our prevailing production and consumption patterns. The problem originates mainly from land-based activities as well as from sea-based activities. The limited governmental financial resources, the poor stakeholders understanding of their co-responsibility in generating and solving the problem, and the weak enforcement of laws and regulations are among the main factors that the problem of marine litter has not been addressed effectively.

Marine litter has been an issue of concern in the Mediterranean since the 1970s. The LBS Protocol of the Barcelona Convention recognised the importance of dealing with the problem of marine litter. The amended LBS Protocol, 1996 and entered into force in 2008 provides for litter as any persistent manufactured or processed solid material which is discarded, disposed, or abandoned in the marine and coastal environment.

The Mediterranean was designated a Special Area for the purposes of Annex V (Prevention of pollution by garbage from ships) of the MARPOL 73/78 Convention.

In December 2013 COP 18 of the Barcelona Convention adopted the Regional Plan on Marine Litter Management in the Mediterranean (hereinafter MLRP) that represents among others a set of legally binding measures to prevent and reduce marine litter generation and improve its management with the view to achieve the ECAP GES and targets on marine litter also adopted by COP 18. Thus, the Mediterranean Sea is the first regional sea to have a plan in dealing with the issue of marine litter. In the MLRP the following marine litter definition is provided: “Marine litter, regardless of the size, means any persistent, manufactured or processed solid material discarded, disposed of or abandoned in the marine and coastal environment”.

Fishing for Litter (hereinafter FfL) is referring to the removal of marine litter from the sea by the fishermen.

The MLRP provides for FfL as one of the most important measures that has the potential to reduce the amounts of marine litter at sea by involving one of the key stakeholders sectors, the fishing industry. Apart from removing litter from the sea, mainly from the seafloor, these practices substantially contribute to raising awareness on the problem within the sector and the need for better waste management.

In 2011 the Honolulu Strategy, developed in the course of and after the 5th International Marine Debris Conference, organised by UNEP and the US National Oceanic and Atmospheric Administration (NOAA) Marine Debris Programme, stated FfL in its strategies C4 and C5.

FfL initiative has demonstrated on a limited scale that the objectives and aims of the scheme can gain the support of the fishing industry, harbour authorities and local authorities. Furthermore, it can contribute to changing practices and culture within the fishing sector, provide a mechanism to remove marine litter from the sea, and raise awareness among the fishing industry, other sectors and the general public.

FfL initiative integrates several benefits: environmental, social, economic and scientific.

The MLRP has two provisions addressing FfL: explore and implement to the extent possible by the year 2017 the FfL environmentally sound practices (Art. 9.6) and the need to consider EIA and environmental impacts of implementing FfL drawing the attention that the best environmental

practices and techniques should be used for this purpose due to the fact that such interventions may also have a very negative impact on marine environment and ecosystems (Art. 10.e).

In the Convention on Biological Diversity Expert Workshop to Prepare Practical Guidance on Preventing and Mitigating the Significant Adverse Impacts of Marine Debris on Marine and Coastal Biodiversity and Habitats held in Baltimore, USA in December 2014, “Encourage fishing for litter initiatives” is included on the list of suggestions made for marine debris mitigation and management (predominantly plastic) of the Draft Background Document¹⁰. This document also provides an update to the review of the impacts of marine litter undertaken by the Scientific and Technical Advisory Panel of the GEF in collaboration with the Secretariat of the Convention on Biological Diversity, and jointly published as CBD Technical Series 67 in 2012.

FfL activities have been widely applied mainly in NE Atlantic Ocean, and specifically in the North Sea; FfL actions in the Baltic Sea and in the Mediterranean Sea have been undertaken more recently while no such actions have been initiated yet in the Black Sea. At global level, one project is under development in the United States with energy recovery from the fishing gear removed.

In the Mediterranean, five projects are currently being implemented: Ecological bags on board (Spanish East Coast), *Ecopuertos* (Andalusian Coast, Spain), DeFishGear (Adriatic Sea), Port of San Remo (Ligurian Coast, Italy) and Port of Rovinj (Northern Adriatic Sea, Croatia). A summary of these projects are presented in Annex 2.

Despite FfL is mainly considered at local scale, marine litter is a transboundary problem and therefore a coordinated, harmonised and coherent approach is the best way to tackle it.

At all levels, cooperation in FfL practices should be based on the exchange of relevant information and on addressing significant transboundary marine litter issues. Agreements should be made so that any vessel involved in the FfL practice can land non-operational waste at participating harbours in Mediterranean countries and other neighbouring countries.

Cooperation between Regional Seas Conventions will be more effective if the work undertaken within these conventions following their regulatory framework takes the same approach.

In this context, in accordance with UNEP/MAP Programme of work on pollution assessment and control thematic priority and the objectives of the project on ecosystem approach funded by the EC the following “Guide on best practices for Fishing for Litter in the Mediterranean” are developed to be commonly agreed at the Mediterranean level and implemented accordingly.

1. Introduction

There are two types of FfL practices: active and passive. Active practices are specifically performed to remove marine litter and fishermen involved are paid; passive practices are carried out by fishermen during their normal fishing activities without financial compensation.

Regarding to active ones the following practices can be considered:

1. Marine litter removal practices during specific fishing trips to remove litter from hotspots (marine litter accumulation) or from protected areas with financial compensation of the fishermen involved.
2. Retrieval of derelict (abandoned, lost or otherwise discarded) fishing gear at sea where individual fishermen are contracted to retrieve nets.

¹⁰ Background Document (Draft) on the Preparation of Practical Guidance on Preventing and Mitigating the Significant Adverse Impacts of Marine Debris on Marine and Coastal Biodiversity (Document UNEP/CBD/MCB/EM/2014/3/INF/2).

In both cases, expertise is needed to undertake marine litter removal actions. This removal involves fishermen and qualified divers locating and removing marine litter and derelict fishing gear (hereinafter DFG). They use various technologies to locate litter, such as side-scan sonar for sea-bed surveys, map locations on the basis of interviews with fisherman, or in the case of DFG information systems that track lost gear, and remove the litter from the marine environment using specialist equipment.

The removal of marine litter requires specific skill sets and experience from the fishermen –especially when bulky or heavy items and nets are retrieved. It is recommended to work with active fishermen that have good knowledge of techniques and the targeted areas (i.e. of the level of activity of the various fisheries in these areas, now and in the past).

Divers might be used to support retrieval operations, depending on the depth and the topography of the seafloor. Working with divers can help to minimise the impact of marine litter and DFG removal on the marine environment and to increase its efficiency and effectiveness. Marine litter and DFG retrieval requires a thorough understanding of the safety and environmental issues of working with marine litter and DFG. Only qualified divers with appropriate experience and training should attempt marine litter and DFG retrieval.

In this sense, and for marine litter removal practices in protected areas, operations using specific fishing gear and divers should be licensed. Therefore relevant permits should be requested to the competent authority (managing body of the protected area). In these cases, due to the sensitivity of these areas environmental impact assessment of the removal practice should be developed.

There are many environmental benefits of retrieval actions of marine litter, these benefits increase when developing in sensitive areas where protection and conservation of marine biodiversity are priority but the precautionary principle should be applied.

Last, regarding to passive FfL practices, marine litter removal initiatives undertaken by fishermen during their normal fishing activity can be considered. Fishing vessels are given free bags to collect any marine litter they catch in their nets during fishing operations and are provided with free disposal facilities in harbour. Operational or galley waste generated on board, and hence the responsibility of the vessel, continues to go through the established harbour waste management system.

All types of marine litter are targeted depending on the gear type used. Most amounts are from seafloor litter collected with bottom-contacting gear. Full bags are deposited on the quayside where the participating harbours monitor the waste before moving the bag to a dedicated skip for disposal. Normally, litter is weighed and, where possible, composition recorded, providing data that may be useful in subsequent policy development and management. Participation of fishermen is voluntary and without financial compensation but they should be motivated with indirect benefits to achieve their engagement.

This practise reduces the volume of debris washing up on our beaches and also reduces the amount of time fishermen spend untangling their nets. Therefore FfL is one of the most innovative and successful concepts to tackle marine litter at sea based on cooperation with fisheries associations.

This last type of practices, i.e. passive FfL practices, will be those considered in this guide and therefore their aspects related will be described accordingly.

2. Objective

The objective of this guide is two-fold: to provide technical guidance on the mechanism to remove litter from the sea in an environmentally friendly manner ensuring negative impacts on marine environment and ecosystems are avoided, and to provide guidance on the process of involving the

stakeholders responsible for the implementation and coordination of FfL practices. As stated above, the FfL practices considered within this guide are the passive FfL ones.

These practices are expected to be implemented in local areas at small-medium scale due to the specific characteristics of the Mediterranean trawling fishing fleet. FfL practices are described in areas where fishermen are able and allowed to fish.

3. Implementing a Fishing for Litter practice step by step

The steps of a FfL practice are presented in the following scheme (blue colour) and are elaborated in the chapters that follow. Where possible to implement, additional steps are also provided (orange colour).

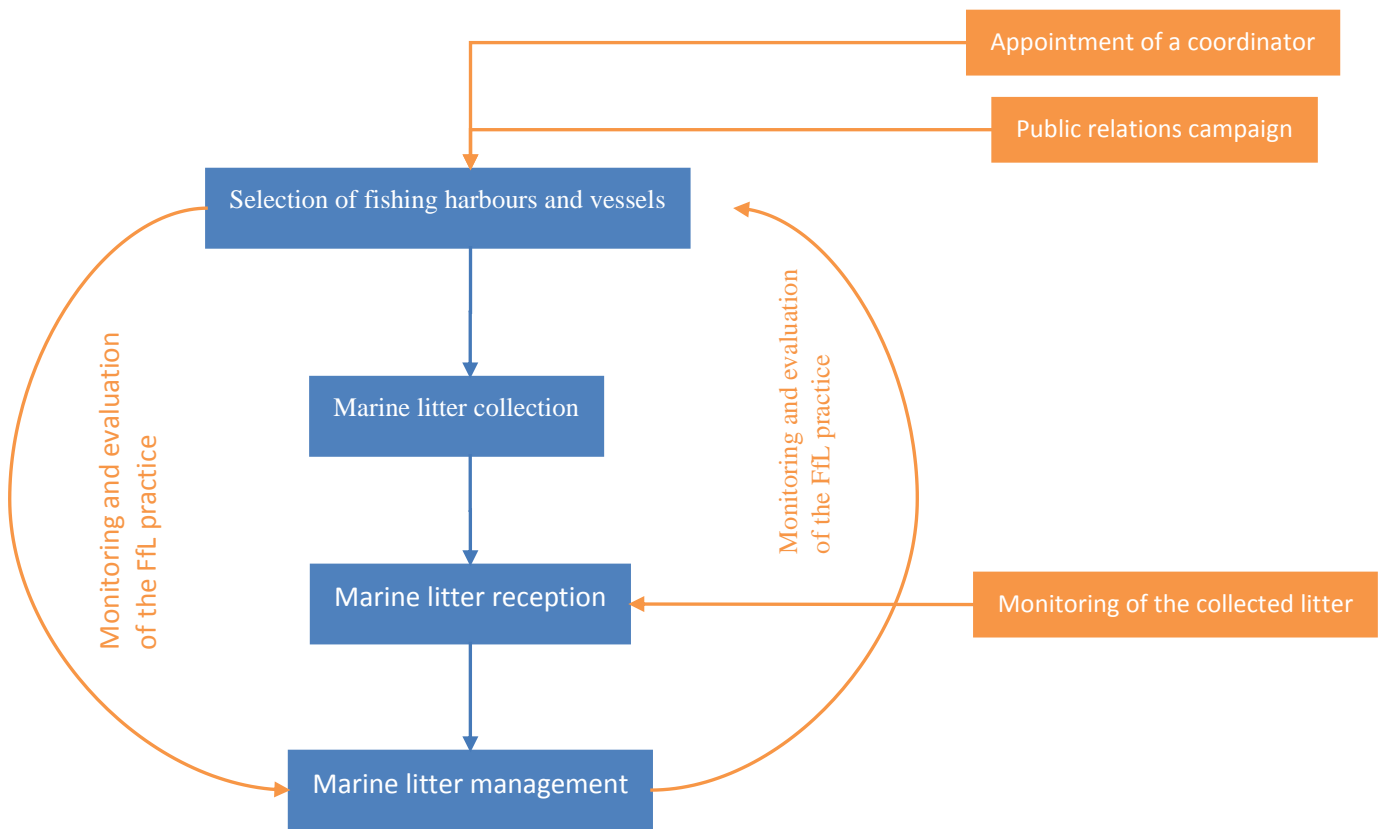

3.1. Selection of fishing harbours and vessels

For the selection of fishing harbours and vessels that will participate in the FfL practice it is recommended to contact with fishermen's associations (both national and local) to explore the possibilities of collaboration. It is also recommended to contact with ports and harbours authorities because the point to collect waste will be located in the harbour area and other harbour facilities could be used for the purposes of the FfL practice. To complete the establishment of contacts with relevant stakeholders it is recommended to contact with waste management authorities and companies for the involvement of these sectors into the FfL practice.

3.2. Marine litter collection

For marine litter collection, bags solid enough will be needed. The size of bags used will depend on the vessel size to ensure enough free space on board during fishing activities. Typical bags, called big bags, used for FfL practices measure L90 x W90 x H90 cm and have a weight capacity of 200 kilogrammes, and a volume of 100 litres. The bags are usually made of polypropylene, for greater strength, and can be reused several times.

The following guidelines to collect marine litter should be followed by the fishermen to ensure the smooth running of the FfL practice:

- Marine litter should only be collected in the bags.
- Only marine litter caught in your nets should be collected in the bags. Ordinary galley and operational waste should still be disposed of through existing procedures.
- Garbage including plastics, domestic wastes, cooking oil, operational wastes and fishing gear should never be thrown overboard in the Mediterranean.
- Objects of natural origin (e.g., submerged and drifting shrubs, trees, their branches, etc.) which could be entrapped by fishing gear can be subsequently discharged back to the sea.
- Drums of fluids, chemicals or oil and hazardous items such as batteries are considered special waste under waste regulations and should be dealt with through the harbours existing special waste procedures.
- No items of marine litter should be brought onto or retained on board the vessel if the master, in his opinion, considers that doing so would have an adverse effect on the stability and seaworthiness of the vessel.
- Number of bags and approximate weight of marine litter collected in every fishing trip should be recorded.

3.3. Marine litter reception

The bags of marine litter should be unloaded and placed safely on the quayside in order to no marine litter losses occur and no marine litter may return to the sea. The bags will then be taken to the existing waste reception facilities in the harbour. Permanent and large containers that are emptied on regular basis and made available at the shortest possible distance from fishing boats will facilitate handling of both wastes and bags. Either fishermen will take the bags to reception facilities themselves or staff from the harbour authority or waste management company will take the bags to the reception facilities.

To ensure the smooth running of the FfL practice appropriate waste reception facilities in the harbour should be available. Marine litter will be disposed in closed containers with lids, large enough to receive the amounts and sizes of items removed.

Who takes the bags to the waste reception facilities will depend on what is agreed with the harbour authority during the FfL practice and the normal arrangements for handling waste from vessels in the port. It is recommended that the arrangements for handling marine litter are the same as the normal arrangements for handling the fishing vessels' own waste.

3.4. Marine litter management

Once ashore, marine litter removed has to be properly managed in order to not return to the sea. In this sense, in addition to appropriate waste reception facilities, appropriate waste treatment facilities should be available.

Waste management should ensure that waste is segregated and recycled conveniently prioritising the recovery (both material and energetic) from the deposit. Thus, ideally the management system should apply the following waste hierarchy as a priority order: recycling, energy recovery and disposal.

If the final destination of the waste is landfilling, waste disposal will take place in a controlled facility.

As indicated above, the management system of marine litter collected could be integrated in the harbour existing waste management system, could establish an independent management system based on collecting it by an authorised waste manager that ensures its subsequent separation and recovery or could consist of a combined system of the two previous options. Agreements between waste management authorities and private sector could be made to put into the market segregated materials.

3.5. Additional steps

When possible, depending on available resources for the FfL practice the following steps could be implemented.

3.5.1. Appointment of a coordinator

FfL practice coordinator at national or regional level might be appointed. The coordinator might be in charge of these tasks:

- Searching for resources
- Involving fishing harbours and vessels: contact with fishermen's associations, ports and harbours authorities, waste management authorities and companies
- Developing of the public relations campaign
- Reporting monitoring data

From the experiences, the FfL practice coordinator could belong to a scientific or academic institution, NGO or a local authority as appropriate.

3.5.2. Public relations campaign and other incentives

A public relations campaign might be developed with the aims to encourage fishing industry to participate in the FfL practice and to inform general public about the FfL practice. The success of this kind of practices is the high engagement and involvement of fishermen and a good public perception could strengthen the fishermen support to the FfL practice.

Specific objectives of the campaign are outlined below:

- Raise awareness of the FfL practice within the fishing industry
- Highlight the role of the funding bodies
- Demonstrate good practice within the fishing industry to the general public
- Change attitudes and behaviour within the fishing industry
- Influence policy makers

The main aspects public relations campaign should cover are summarised below.

3.5.2.1. Key messages of the campaign

Three are the key messages that the campaign needs to disseminate during the FfL practice:

- Marine litter is a problem that can be solved if everyone takes responsibility for their actions.
- Marine litter damages fishermen's livelihood (decrease of catches because fish can get caught in litter, time span spent cleaning nets) as well as the environment and it is in everyone's interest to solve the problem.
- Marine litter is a resource¹¹, not a waste.

¹¹ The increasing scarcity of resources and rising commodity prices is encouraging producers to find new ways to recover used products and to turn waste into a resource. Many end-of-life products, including plastics and

3.5.2.2. *Practical objectives of the campaign*

Practical objectives of the campaign are listed below:

- Develop corporate image for the FfL practice (logo, colours, etc.)
- Develop A4 information leaflet on the FfL practice aimed at fishermen¹²
- Develop identification flags of the FfL practice for participating vessels
- Develop specific equipment for participating fishermen
- Develop display material for exhibitions
- Official launch of the FfL practice
- Develop Fishing for Litter content on a website
- Press launch of first new harbour in the FfL practice
- Coverage of the FfL practice on a rural affairs television programme
- Press launch for final harbour in the FfL practice
- Publication of the report on the analysis of the monitoring programme

3.5.2.3. *Media contacts*

Local agencies should have extensive contacts with the Trade Media and National Press. These should be utilised throughout the FfL practice to gain the maximum amount of coverage.

3.5.2.4. *Crisis management*

The risk of bad publicity from a FfL practice is very low however there are some situations that could impact adversely on the press coverage. For example, if a participating vessel is caught disposing of marine litter at sea. In such a situation the FfL practice coordinator should immediately release a press release condemning the action and reaffirming their commitment to eradication of such behaviour. It should also state their intention to enter into a dialogue with the vessel and master to ensure there was not a repeat incident. However as a last result if there was no cooperation the vessel in question should be removed from the FfL practice.

Another possible scenario is that one of the vessels involved in the scheme is caught fishing illegally. In this situation the coordinator would not comment unless directly approached by the press and then only to state that they are only involved in waste management issues and fisheries management is outside their remit.

3.5.2.5. *Other incentives to promote fishermen engagement*

The following incentives may be taken into account to promote fishermen engagement in the FfL practice:

- increasing self-esteem by agreements with food banks to donate a part of the catches
- giving them visibility in communication media and to the Authorities
- encouraging them to constitute companies for fish commercialisation and subproducts elaboration, providing them with contacts with commerce
- studying engineering solutions to save fuel (such as hybrid engines)

packaging are increasingly being seen as sources of valuable secondary materials which are lost forever if disposed of.

¹² Threats and impacts of marine litter should be highlighted on the leaflets developed.

3.5.3. Monitoring of the collected litter

The monitoring might be implemented to ensure adequate collection, sorting, recycling and/or environmentally sound disposal of the fished litter.

For monitoring marine litter brought ashore as part of the FfL practice a marine litter collected form might be filled in. With regards to seafloor litter, this form is based on the Master List of main categories of Litter Items as agreed in the UNEP/MAP Integrated Monitoring and Assessment Programme. The number of items will be recorded according to the categories defined (Plastic/Polystyrene, Rubber, Cloth/Textile, etc.) as well as the total weight of marine litter caught (see Table 1 in Annex 1).

However, this Master List may be adjusted and shortened for the purpose of the implementation of the Guide on FfL based on the most frequent items found in the course of implementation.

The tasks of recording composition and weight of waste brought ashore might be developed daily on the quayside by qualified personnel and monthly data might be reported to the FfL practice coordinator accordingly. The staff responsible for the characterisation of marine litter (composition and weight) should ensure that no items are lost during this process. Composition is recorded in order to identify sources of marine litter and the weight to ensure the final waste management.

Annually, monthly tons and composition of marine litter collected in each of participating harbours as well data related to harbour details (number of participating vessels, main vessel type) might be reported to the National Competent Authority for the protection of the marine environment (see Tables 2 and 3 in Annex 1).

3.5.4. Monitoring and evaluation of the Fishing for Litter practice

Data collected (number of vessels and harbours participating, amounts and composition of litter collected, etc.) might be periodically reviewed by the competent authority to evaluate the success of FfL initiatives, and might look at such factors as costs, benefits and governance. It may also enable to locate accumulation areas and support an optimised strategy to further focus on hot spots

Regular FfL practice monitoring and evaluation might help to assess the impacts of the practice and to identify lessons that can be used to improve future initiatives. It might also help to prove to any organisations providing funding or other support that the practice is on track to achieve what it plans to achieve.

4. Health and safety implications

The experience of FfL projects in the North Sea developing since 2000 indicates that there have been no instances of accidents or injuries directly related to the collection, storage or transfer to shore of marine litter collected as part of these projects.

The UK Maritime and Coastguard Agency (MCA) undertook a Feasibility Study for the Conduct of a Pilot Project for Offshore Marine Debris Analysis, Project 496 (Day) that identified some of health and safety implications. The study suggested that the health and safety aspects of implementing these types of initiatives would be the same as normal fishing activities (operations) and therefore there would likely not be any additional implications.

The stability and seaworthiness of the vessel may be affected by the items of marine litter brought onto or retained on board. Thus, no object of marine litter will be collected if there is suspicion of hazard, adverse effect or risk jeopardizing the stability of the vessel. The master and crew of the vessel have the responsibility for effective operational risk assessment. It is recommended to consider elements provided in Annex 3 for health and safety risk assessment.

Fishermen should maintain litter on board in a manner that should avoid any possible fish cross pollution from marine litter.

5. Environmental impact assessment including transboundary impacts

FfL passive practices are carried alongside normal fishing operations therefore there are no, in principle, potential adverse effects on the marine environment. However, the MLRP highlights the need to consider EIA and environmental impacts of implementing FfL and draws the attention that the best environmental practices and techniques should be used for this purpose due to the fact that such interventions may also have a very negative impact on marine environment and ecosystems in particular regarding the FfL active practices.

The main potential environmental impacts of FfL practices may be related to the harm to the seafloor and the associated benthic communities, In addition, pollution with marine litter will happen in case of exceed the capacity of the harbour waste reception and storage facilities together with human health and safety risks. Best practices established in this guide could be considered as mitigation measures of potential negative impacts of FfL practices on marine environment.

[An environmental impact assessment for active FfL practices should be considered taking into account the aspects listed below:

1. Characteristics of the FfL practice: (a) the size and design of the whole FfL practice; (b) cumulative effects with other existing and/or approved FfL practices; (c) the use of natural resources, in particular land, soil, water and biodiversity; (d) the production of waste; (e) pollution and nuisances; (f) the risk of major accidents and/or disasters which are relevant to the FfL practice concerned, including those caused by climate change, in accordance with scientific knowledge; (g) the risks to human health.
2. Location of the FfL practice: environmental sensitivity of geographical areas affected by the FfL practice with particular regard to marine protected areas.
3. The transboundary nature of the potential impacts.]

6. References

GERMAN FEDERAL ENVIRONMENT AGENCY (UBA) AND EUROPEAN COMMISSION DG ENVIRONMENT (2013). *International Conference on Prevention and Management of Marine Litter in European Seas* (Berlin, 10-12 April 2013): <http://www.marine-litter-conference-berlin.info/index.php>.

KIMO (2010). *Economic impacts of marine litter*. Available from http://www.noordzeeloket.nl/images/Economic%20impacts%20of%20marine%20litter_1290.pdf [accessed April 2015].

KIMO (2013). *Fishing for litter projects in the North Sea*. <http://www.kimointernational.org/FishingforLitter.aspx>.

MARELITT Project (2015). *Toolkit for derelict fishing gear projects*.

MARELITT Project (2015). *Toolkit for marine litter retention projects*.

MARITIME AND COASTGUARD AGENCY GREAT BRITAIN (2004). *Research Project No. 496: Feasibility Study for Conduct of a Pilot Project for Offshore Marine Debris Analysis: Notice to Environmental Regulators, Ports and Harbours, Fishing Industry, Non-Governmental Organisations, Government Departments (Dft and Defra) and Local Authorities (Marine information note)*.

MARLISCO Project: Marine Litter in European Seas - Social Awareness and Co-Responsibility (2015). *The MARLISCO Guide for Reducing Marine Litter: Get Inspired and Become Innovative Through Best Practices*.

OSPAR (2009). *Marine litter in the North-East Atlantic Region: Assessment and priorities for response*. London, United Kingdom, 127 pp.

OSPAR COMMISSION (2007). *Guidelines on How to develop a Fishing-for-litter Project*. OSPAR Agreement 2007-10.

OSPAR COMMISSION (2010). *OSPAR Recommendation 2010/19 on the reduction of marine litter through the implementation of fishing for litter initiatives and its annex*.

SECRETARIAT OF THE CONVENTION ON BIOLOGICAL DIVERSITY AND THE SCIENTIFIC AND TECHNICAL ADVISORY PANEL—GEF (2012). *Impacts of Marine Debris on Biodiversity: Current Status and Potential Solutions*, Montreal, Technical Series No. 67, 61 pages.

UNEP/CMS (2014). *Report I: Migratory Species, Marine Debris and its Management*. Available from:

http://www.cms.int/sites/default/files/document/COP11_Inf_27_Report_I_Marine_Debris_Management_Eonly.pdf [accessed April 2015].

UNEP/FAO (2009). *Abandoned, lost or otherwise discarded fishing gear*. UNEP Regional Seas Reports and Studies, No. 185; FAO Fisheries and Aquaculture Technical Paper, No. 523. Rome. 115 p.

Annex 1¹³. Monitoring forms**Table 1.** Marine litter collected form.

Harbour	
Vessel	
Date	
Number of bags	
Total weight (Kg)	
Observations	

ID	PLASTIC/POLYSTYRENE	Total No.
G2	Bags	
G6	Bottles	
G10	Food containers incl. fast food containers	
G18	Crates and containers / baskets	
G20	Plastic caps and lids	
G27	Cigarette butts and filters	
G39	Gloves	
G48	Synthetic rope	
G51	Fishing net	
G55	Fishing line (entangled)	
G59	Fishing line/monofilament (angling)	
G61	Other fishing related	
G66	Strapping bands	
G67	Sheets, industrial packaging, plastic sheeting	
G93	Cable ties	
G124	Other plastic/polystyrene items (identifiable)	
ID	RUBBER	Total No.
G125	Balloons and balloon sticks	
G127	Rubber boots	
G128	Tyres and belts	
G132	Bobbins (fishing)	
G134	Other rubber pieces	
ID	CLOTH/TEXTILE	Total No.
G136	Shoes	

¹³ This Annex is prepared for indicative purposes. Its final version will be based on the agreed list under the Integrated Monitoring and Assessment Programme of UNEP/MAP.

G137	Clothing / rags (clothing, hats, towels)	
G141	Carpet & Furnishing	
G142	Rope, string and nets	
G145	Other textiles (incl. rags)	
ID	PAPER/CARDBOARD	Total No.
G146	Paper/Cardboard	
G148	Cardboard (boxes & fragments)	
G158	Other paper items	
ID	PROCESSED/WORKED WOOD	Total No.
G160	Pallets	
G170	Wood (processed)	
G173	Other (specify)	
ID	METAL	Total No.
G175	Cans (beverage)	
G176	Cans (food)	
G180	Appliances (refrigerators, washers, etc.)	
G182	Fishing related (weights, sinkers, lures, hooks)	
G185	Middle size containers	
G187	Drums, e.g. oil	
G193	Car parts / batteries	
G194	Cables	
G196	Large metallic objects	
G197	Other (metal)	
ID	GLASS/CERAMICS	Total No.
G200	Bottles incl. pieces	
G201	Jars incl. pieces	
G208	Glass or ceramic fragments >2.5cm	
G209	Large glass objects (specify)	
G210	Other glass items	
ID	SANITARY WASTE	Total No.
G95	Cotton bud sticks	
G96	Sanitary towels/panty liners/backing strips	
G98	Diapers/nappies	
G133	Condoms (incl. packaging)	
ID	MEDICAL WASTE	Total No.
G99	Syringes/needles	
TOTAL		

Annex 2. Summary of the FfL projects

PRACTICE / PROJECT	IMPLEMENTING ORGANISATION	SCOPE	PERIOD	LITTER REMOVED	ACTIVITIES UNDERTAKEN	ADDED VALUE
Ecological bags on board	Villajoyosa fishermen's association	Alicante Coast (E Spain)	2012-	Seabed and floating	<ul style="list-style-type: none"> • 1 harbour, 38 boats (30 trawls, 8 trammels) • Until 30th September 2014: 41701 items of seabed litter collected and 17603 kg of fish donated • On average 5 vessels participating each month (trawling fishing vessels) 	<ul style="list-style-type: none"> • Fishermen initiative • Integrated waste management system • Fishing discards of the participating fleet provide food to charity canteens through Granada Food Bank Foundation • The project finalised at the beginning of December 2014 but the continuity of this initiative is assured thanks to funding from the port of Motril
Ecopuertos	RELEC Chair (University of Cadiz, Spain)	Andalusian Coast (port of Motril, Granada)	August 2013-December 2014	Seabed		
DeFishGear	Lead partner: National Institute of Chemistry (Slovenia) Project countries: Slovenia, Italy, Greece, Croatia, Bosnia and Herzegovina, Montenegro and Albania Lead partner: OLPA	Adriatic Sea	Beginning of 2014-ongoing	Seabed and fishing gears		
		Ligurian Coast	2015-	Seabed		

Port of San Remo	(The Ligurian Observatory on Fishery and Environment)	(Port of San Remo, Italy)			are involved	project are: improve the marine environment and in particular the environmental status of the sea bottom by reducing marine litter; promote behavioural change among stakeholders and raise awareness on marine litter issues; provide evidence on marine litter hot-spots in Liguria
	Partners: Liguria region; ARPA Liguria; Municipality of San Remo; fishery cooperatives (LegaPesca, Federcopesca, AGCI Pesca), port authority of San Remo; FLAG (Fisheries Local Action Group) 'Il mare delle alpi'; waste management companies (AIMERI SpA); Accordo Pelagos and RAMOGE; tourism industry (Consorzio Mediterraneo; Costa Crociere Foundation); ARPA Toscana; University of Genova; Institut Ruđer Bošković					
Port of Rovinj	Lead partner: Center for Marine Research of the Ruđer Bošković Institute	Northern Adriatic Sea, Istrian Coast	2015-	Seabed	<ul style="list-style-type: none"> 20-25 vessels are involved in the first stage of the project 	<ul style="list-style-type: none"> The objectives of the project are: Remove marine litter and contribute to the implementation of the Marine Strategy Framework Directive in Croatia and to
	Partners: fishermen of Rovinj; Port authority of Rovinj; Komunalni	(Port of Rovinj, Croatia)				

servis d.o.o (municipal
waste management
company); NGO
Zelena Istra (Green
Istria); Chamber of
Commerce of Istria;
Municipality of Rovinj

achieving good
environmental status;
Collect data on
marine litter in the
Northern Adriatic
Sea; Raise awareness
on the problem of
marine litter

Annex 3. Elements for the health and safety risk assessment

Hazards The fish quay (slippery surfaces, mooring ropes, blocks and bollards)

Hazard no:	
1	Working on fishing boat (MOD, collision, fire and flood)
2	Working with fishing gear on dock (ropes, wires, trawls and winch gear)
3	Ladders on quayside (ladders on vessel)
4	Landing debris (using landing derricks)
6	Handling debris (cutting hands on sharp objects)
7	Emptying skips (injury if craned from pontoon)

Persons affected Crew and Project Staff

Hazard no:	Hazard severity	Likelihood of occurrence	Risk factor
1	High / mod risk	Low likelihood	Severe
2	High / mod risk	Low likelihood	Severe
3	Low risk	Low likelihood	Medium
4	Low risk	Low likelihood	Medium
5	Moderate risk	Low likelihood	Minor
6	Moderate / low risk	Likely	Medium
7	Low risk	Unlikely	Medium

Likelihood / Consequence	Severe	Major	Medium	Minor
High likelihood	Very high risk	High risk	Moderate risk	Moderate risk
Likely	High risk	Moderate risk	Moderate / low risk	Low risk
Low likelihood	High / mod risk	Mod / low risk	Low risk	Negligible Risk
Unlikely	Moderate/low risk	Low risk	Negligible Risk	Negligible Risk

To assess the risk arising from the hazard:

1. Select the expression for likelihood which most applies to the hazard
2. Select the expression for degree of harm which most applies to the hazard
3. Cross reference using the above table to determine the level of risk

<i>Existing Control Measures</i>		<i>Re-assessed</i>
Hazard	Control Measures	Risk Factor
1	Vessel survey, trainee staff, good safety equipment	Medium
2	Vessel survey, trainee staff, good safety equipment	Medium
3	Survey the quay	Minor
4	Vessel survey, staff familiar with equipment	Minor
5	Survey the quay	Minor
6	Issue of safety equipment (gloves, boots, hard hat)	Minor
7	Staff to be familiar with craning procedures	Minor

Annex III, Appendix 4

Guidelines on Best Environmental Practices for the environmental sound management of mercury contaminated sites

Note by the Secretariat

These Guidelines have been commissioned by the Programme for the Assessment and Control of Marine and Coastal Pollution in the Mediterranean Region (MEDPOL) and the Regional Activity Center for Sustainable Consumption and Production (SCP/RAC) of the Mediterranean Action Plan (UNEP/MAP) to the Spanish National Technological Center for Mercury Decontamination (CTNDM), which counts with a vast technological experience in mercury management and offers scientific and technological support to eliminate the hazards related to the presence of mercury in products, emissions and wastes.

The Guidelines have been prepared by Manuel Ramos, Javier Carrasco, Ana Conde and Engracia Delacasa, from the CTNDM and from Minas de Almadén (MAYASA), with collaborations of Marc Pujols and Gracia Ballesteros from ACUAMED; Antoni Malet and Antonio Caprino from SOLVAY IBÉRICA, and Josep Maria Chimenos from the University of Barcelona.

The Directorate General for Risk Prevention (Service of Technological Risk, Management of Contaminated Sites) of the French Ministry of Ecology, Sustainable Development and Housing, the Institute for Environmental Protection and Research (ISPRA) of the Italian Ministry for the Environment and the Protection of Land and Sea, and the Waste Agency of Catalonia have contributed with comments and suggestions.

The coordination and technical supervision was ensured by SCP/RAC.

The Guidelines were discussed at the MED POL Focal Points Meeting in March 2014 and have been updated to accommodate the comments received by the Focal Points.

Table of contents

1.	Introduction	4
2.	International Legislation	6
3.	Identification of mercury-contaminated sites	9
4	Identification of environmental impacts	13
5	Environmental characterization of mercury-contaminated sites	14
6	Sample preparation and analytical procedures	22
7.	Risk assessment	25
8.	Remediation of mercury-contaminated sites	29
	ANNEX : CASE STUDIES	47
	1.Reconditioning of the “Cercos de san Teodoro” slag heap. Minas de Almadén (Ciudad Real, Spain).	48
	2. Decontamination of the Flix dam in the Ebro river(Tarragona, Spain)	55
	3. Environmentally safe decommission of a mercury cell	67
	4.Stabilization of soils contaminated with heavy metals using low-grade magnesium oxide.....	76

1. Introduction

In general, a *contaminated site* is a place where there is an accumulation of toxic substances or residues which may affect the soil, groundwater, sediments and, in the case of mercury, even air to levels that pose a risk to the environment or human health or be above the safe limits recommended for a specific use.

Metallic mercury is a liquid at room temperature, the only metal with this property and also evaporates at room temperature. Mercury is one of the most problematic toxic substances that may be found at contaminated sites: the special physical and chemical characteristics of mercury make a challenge the management of mercury contaminated sites, especially when it comes to remediate large industrial sites and mercury mining sites. Due to its properties, once mercury has entered the environment, it remains there adopting different physical and chemical forms reaching all of the environmental compartments to a greater or lesser extent: air, soil, water, sediments and even the buildings used for the activity.

Inorganic mercury can be transformed by bacteria into methylmercury in sediments and soils, at a rate depending of the physic-chemical characteristics of the soil. Methylmercury (CH_3Hg^+) is a highly toxic bioavailable form of organic mercury and cumulative throughout the food chain. Consumption of fish and shellfish poisoned by direct dumping of methylmercury in the wastewater from a chemical factory in the Minamata bay (Japan) during decades was the cause of one of the worst episodes of chemical pollution recorded in the past century.

The three major forms (speciation) that can be found in the environment are:

- Metallic mercury (Hg^0), in liquid and gas equilibrium depending of the temperature.
- Inorganic mercury (Hg^{2+} , HgO , HgCl_2 , $\text{HgCl}\dots$)¹⁴
- Organic mercury ($\text{CH}_3\text{Hg-CH}_3$, $\text{CH}_3\text{Hg-NH}_2$, $\text{CH}_3\text{Hg-SH}\dots$)

Various activities have led historically to mercury-contaminated sites, generally as a result of lack of environmental regulations, use of pollutant technologies and poorly waste management practices. These activities mainly include: mercury mining and quarrying¹⁵; the chlor-alkali industry; coal-fired power-plants; cement industry; production of pig iron, steel and non-ferrous metals; the waste sector; the production of chemical substances, chemical fertilizers, pharmaceutical products and catalysers; batteries and fluorescent lights.

Currently the most important source of emission of mercury in the Mediterranean region are the coal-fired power plants¹⁶.

¹⁴ Mercury can easily change its chemical state in the environment because of the low $\text{Hg}^{2+}/\text{Hg}^0$ standard potential, thus causing drastic changes in its mobility and toxicity.

¹⁵ The most common ore form of Hg is cinnabar (HgS). It has been exploited in the Mediterranean region mainly in Spain and also in Algeria, Slovenia, Turkey and Italy.

¹⁶ "Diagnosis of Mercury in the Mediterranean Countries". CP/RAC, 2010.

Remediation of a contaminated site is a corrective measure to mitigate or eliminate the pollution. The first step towards achieving this is to thoroughly examine the origin, extent, type and amount of existing contamination. Once these parameters have been defined, the next step is to determine how and to what extent the environment and human health is or may be affected. Finally, and only after having investigated the aforementioned aspects, corrective measures should be proposed and adopted to remediate safely the environmental damage and limit or eliminate the risk of the contamination to any environmental vector and to the human health.

2. International Legislation

2.1 Minamata Convention on Mercury ¹⁷

The Minamata Convention on Mercury provides for control and reductions across a range of products, processes and industries where mercury is used, released or emitted.

With regard to contaminated sites, the global Convention on mercury shall adopt guidance on managing contaminated sites, but does not pose an obligation on remediation of contaminated sites.

The parties are encouraged to cooperate in the formulation of strategies and the execution of activities to identify, measure, classify depending on priorities, manage and, as appropriate, remediate contaminated sites.

2.2. Convention for the Protection of the Marine Environment and the Coastal Region of the Mediterranean (Barcelona Convention)

2.2.1 **Common Measures**, adopted in the 5th Conference of the Parties (1987) of the Barcelona Convention.

- The maximum concentration of mercury in effluent before dilution in the Mediterranean Sea is 50 µg/l.
- New outlets for mercury-containing effluents in the Mediterranean Sea should be designed and constructed to prevent an increase of mercury concentration in the biota and sediments to above 50% of the background level in a 5 km radius from the discharge point.

2.2.2 **Regional Plan on the reduction of inputs of Mercury** (2012).

In the framework of the implementation of article 15 of the Protocol of Land Based Sources of pollution, the Mediterranean Action Plan (MAP) of the Barcelona Convention adopted in 2012 a legally binding text in order to reduce Mercury pollution, by which the Parties should establish limits of emission (ELVs) to different industrial sectors, among other measures.

An inventory of contaminated sites - including mercury mines and chloralkali facilities which use or have used in the past mercury cells-, has to be forwarded to the Secretariat of the Barcelona Convention. The countries have also to **identify and envisage appropriate measures for these sites.**

¹⁷ Open for signature in 2013 and enters into force in 2018

2.3. European Union Legislation

2.3.1 Surface water and Groundwater

- 2.3.1.1 **Council Directive 98/83/CE** of 3 November 1998, on the quality of water intended for human consumption. Sets a limit for Mercury of 1 microgram per litre.
- 2.3.1.2 **Directive 2006/118/EC** of 12 December 2006, on the protection of groundwater against pollution and deterioration.
- Indicates criteria for assessing good chemical status of groundwater.
 - Set the threshold values of the analytical parameters.
 - Mercury is included in the minimum list of pollutants or groups of pollutants and indicators of pollution that member states should establish.

2.3.2 Soils

- 2.3.2.1 **Council Directive 86/278/EEC** of 12 June 1986 on the protection of the environment, and in particular of the soil when sewage sludge is used in agriculture.
- 2.3.2.2 **Council Directive 91/156/EEC** of 18 March 1991 establishes the obligation to draw up inventories of contaminated sites.
- 2.3.2.3 The thematic strategy for soil protection, *Communication COM[2006]231-final*, includes concepts like:
- the establishment of a legal framework to protect and use the soil sustainably;
 - the integration of protection policies;
 - the identification of risk areas
 - the inventory of contaminated land and facilities
 - the restoration of degraded soils.
- 2.3.2.4 The implementation of the Strategy and ongoing activities since 2006 were presented in document **COM (2012) 46 final**.
- 2.3.2.5 **Directive 2010/75/EU** on Industrial Emissions (IPPC). The industrial activities dealing with hazardous substances will have to establish through a baseline report the state of soil and groundwater before the start of activities and after the cessation of the activities.
- 2.3.2.6 **Directive 99/31 on landfill of waste**. The operator shall be responsible for the maintenance, monitoring and control in the after-care phase for as long as may be required by the competent authority, taking into account the time during which the landfill could present hazards. In some countries this period is not inferior to 30 years.

2.3.3 All media

2.3.3.1 **Regulation EC no.166/2006**, concerning the establishment of an European pollutant release and transfer Register (E-PRTR), setting as compulsory to inform on emissions to air, water and soil above given limits.

2.3.4 Health and safety at work

2.3.4.1 **Commission Directive 2009/161/EU** establishing a list of indicative occupational exposure limit values.

2.3.5 Transport of hazardous waste

2.3.5.1 **European Agreement** concerning the international carriage of dangerous goods by road (ADR)

2.3.5.2 **Regulation EC 1013/2006** on shipments of waste, specifies the procedures for controlling waste shipments to improve environmental protection.

2.3.5.3 **Directive 2008/98** on waste (Framework Directive), includes the conditions for transportation of waste, including minimum standards of transporters.

3. Identification of mercury-contaminated sites

The first step is to produce a census of current and former industrial sites that hosted industrial activities likely to have used - intentionally or unintentionally - mercury in the process or be emitted or dumped into the environment (see list of activities in the introduction). To this list, sites can be added for which analyses and diagnoses revealed the presence of significant mercury anomalies in the soil, air, water, sediments. To detect these anomalies, it is necessary to compare the results found on the site with those of natural or anthropogenic geological background.

The realization of studies on the site to characterize the pollution in its breadth and scope is a critical phase to define the actions to undertake cleanup activities later.

To characterize the pollution it should be established:

- What are the forms of mercury present (metallic mercury, methyl mercury ...);
- The amount of mercury;
- What are the environmental compartments impacted;
- What is the extent of the contaminated area;
- The behavior of mercury in environmental compartments;
- What are the consequences of the pollution, both in and out of the site.

Several tools can be implemented on the site:

- Historical studies, literature and recollection of memories from workers may reconstitute industrial and environmental practices in the site to target potentially polluted areas and type of pollutants potentially present.
- The hydro-geological studies will show the soil characteristics (granulometry, composition of soil and rock, fragmentation areas..) and underground hydrological networks (flow direction of the water, connection between groundwater tables, depth, variation in levels of the groundwater table..). This helps to identify potential transfer and the possible pollution extent.

Information gathering will also seek to identify issues to protect in the site and if the pollution exits the site: local population, uses of the environment (orchards, fishing, water consumption, swimming areas, walking areas ...), media exposure, and the protection of natural resources.

The program of investigations conducted on the site defines environmental compartments and study samples to be taken in order to ultimately develop the conceptual site layout. The latter can map the relationships between the sources of pollution, the various transfer media and issues to protect.

The environmental compartments to be studied are water (surface, groundwater); biota (fish, plants,..); soil, soil gas and sediments and air.

The sampling and analyzes have to be performed according to the protocols and standards. In the case of mercury pollution, it is convenient to associate each sampling with a collection of field

observations and measurements of parameters to be able to assign bias indices to the results. These observations or parameters taken into consideration may be:

- In the air: temperature and internal pressure, temperature and pressure of the outside air.
- In the soil: environment in the area of sampling (sub-slab, bare soil, grassy floor, soil with nearby trees...), soil type (natural, backfills, lithology, homogeneity/ heterogeneity, granulometry, moisture, etc.) soil temperature, ambient air temperature, pH, Eh, dissolved oxygen, organic content (TOC), iron, sulfates, major element and/or traces characterizing the geochemical background, chlorinated solvents (HVOOC, chlorinated monocyclic aromatic compounds, total hydrocarbons, etc.), types of bacteria present in the soil (anaerobic, aerobic ...)
- In the soil gas: temperature and pressure of the soil, temperature and air pressure outside.
- In the water: pH, Eh, dissolved oxygen, electron acceptors (nitrates, nitrites sulfates, iron and manganese), content of chlorides, COD.
- In sediments: pH, Eh, sulfides / sulfates, Total Organic Carbon (TOC), granulometry.

If there are droplets of mercury in soil or sediments, the results may be biased depending if the droplet is taken or not in the sample, especially if the weight of the sample is very small. Sampling sizes should be carefully considered in this case to minimize this risk. A good safety measure to validate the results is to include also sampling and measurements of soil gas.

During analysis of mercury in the sample, it is necessary to perform mercury speciation, which will let to have a precise evaluation of the toxicity, lability and the associated risks. The speciation will distinguish the different forms of mercury present: total mercury, dissolved elemental mercury, dissolved reactive mercury, gaseous mercury Hg^0 , particulate and colloidal mercury.

Taking into account that metallic mercury is the most present form (99%) in the air and soil gas, the speciation in the samples should preferably be carried out in water - groundwater and surface water -, soil and sediments.

Sampling is described in more detail in chapter 5.

3.1 Stage I: Preliminary report on the situation

The preliminary report should contain a theoretical model of the mercury-contaminated site that draws on all of the previously known information. Data on the following aspects will be gathered during this stage:

- ✓ The location, surface area, and details of the physiographic region of the site.
- ✓ Historical records of the site and the surrounding area (climatology, etc.).
- ✓ Past, current and future uses of the place.

- ✓ Analytical data from previous studies.
- ✓ A survey of the site and the nearby area.

One important tool that helps to identify, quantify and characterize the contamination is a list of the activities and processes that have taken place on the site associated with mercury use and the estimated amount of mercury-containing wastes.

Once these factors have been identified, stage II should be carried out. This stage involves the drafting of a more detailed additional report to assess the degree of mercury contamination.

3.2 Stage II: Additional report

This report will contain the information required to draw conclusions and determine **whether or not** a more in-depth analysis is needed.

It is advisable to carry out a preliminary site inspection to meet three specific objectives: **a) describe the site, b) examine the type of contamination produced** by the mercury and **c) define the mechanisms of mercury mobility and the points of exposure.**

If detailed studies of the site are required, the environmental characterization stage will be carried out (Chapter 5).

The three specific objectives are discussed in more detail below.

3.2.1 Description of the site

This should include generalities on the location of the site, climatology, hydrology, hydrogeology, the demography of the area (size and distance from the nearest population), and potential environmental affection.

The report should include at least the following data:

- **Location.** A complete description of the location of the site and access to it. Geographic information on the site. Potential movement of the material deposited there, the production processes carried out, the source of mercury waste, amounts of waste, etc.
- **Form and structure of any facilities.** Geometric characteristics, the building system and sequence, an estimation of the volume of material, the boundaries of the site and the uses of the immediately adjacent area.
- **Climatology.** A complete description of the climate using all available data, the average seasonal temperature, the annual rainfall and its distribution, the maximum precipitation, the predominant wind direction and seasonal wind patterns.

- **Geology of the area**, to discover the geological formations and the rocks found at the site, along with their characteristics.
- **Edaphology and land uses**. A complete description of the kinds of soil at the site, along with the soil characteristics and the land uses: industrial, agricultural, livestock farming, forestry, crop types, etc.
- **Surface drainage network**. A description of the fluvial flow throughout the year, permanent or seasonal rivers.
- **Socioeconomic aspects**. The demography and economy of the area.

3.2.2 Type of contamination

Unless chemical analyses have been carried out, it is difficult to accurately determine which contaminants are present at a site. However, during a site visit, it is possible to define with sufficient clarity the type of mercury contamination that has taken place. To achieve this, it is essential to find out about the activities and processes carried out in the area of interest, through interviews with the local authorities and with the population of the surrounding area. Information that is gathered in this way must always be summarized and filtered, particularly if the polluting activity was halted a long time ago.

The site should be defined in as much detail as possible in relation to the geometric and physical characteristic of the structure or structures that could potentially produce the contamination.

3.2.3 Identify the mechanisms of mercury mobility and points of exposure

A description of the site and of the type of contamination will enable us to predict the mechanisms of mercury mobility and the environmental compartments that are affected, where applicable. A good selection of points of exposure is extremely important, as environmental sampling should be comprehensive.

During the first site visit, the specialist in charge of the study should also define the areas in which there is no evidence of contamination. These areas will be used to take reference samples, which will serve to *establish the natural or background level of mercury in the study area*.

A preliminary precautionary decision can be made to limit access and uses of the potentially contaminated area if knowledge of points of exposure gained in this first visit leads to the conclusion that there may be an exposure risk for people or animals. The relevant local authority must be informed of this decision. The advisability of the measure can be reviewed later when the results of the analyses are available.

4 Identification of environmental impacts

National environmental safety and protection criteria should be used as a reference to identify environmental impacts at the contaminated site.

If no specific regulations exist, the principle of prudence should be considered in the study of the mercury-contaminated site. In this case, applicable published data, recommendations and international guidelines should be used as a reference. The conclusions obtained in this way and the decision of the relevant authority/ies will enable future actions to be evaluated.

As mercury is mobile, environmental impacts should be assessed in the various environmental compartments to determine the following risks.

Hydrological risk:

- Alterations in natural surface drainage and contamination of river beds due to runoff and leachate from the contaminated site.
- Changes in the courses of streams adjacent to the site due to the accumulation or piling up of material in the beds, which may cut off the natural flow or be washed away in a flood and pollute the downstream.

Atmospheric risks:

- Resuspension or reemission of particles of dust from the mercury-contaminated site that are carried by the winds.
- Regasification and release of mercury present in piled up or contaminated materials, due to seasonal changes in temperature.

Changes in soils:

- Occupancy by accumulation of materials.
- Nearby soil affection by dispersion of materials from the contaminated site, the deposition of dust or the runoff of rainwater.

Impact on vegetation and wildlife:

- Affection of plant species from the area and movement of wildlife to adjacent habitats.

Morphology and landscape:

- Visual impact on the main basins in the natural landscape due to the effect of piling up of material, lack of vegetation or colour changes.

5 Environmental characterization of mercury-contaminated sites

The selection of the environmental compartments that should be sampled will depend on the characteristics of the contaminated site or location: each site is different, so criteria that apply to one might not be applicable to another. In some places, surface water and sediment should be sampled; in others soil sampling may be sufficient; and in yet others emissions should be measured and soil, surface water and groundwater should be sampled.

Sampling and analyses are essential elements in the assessment of mercury-contaminated sites: it will determine the extent of soil contamination with environmental damage, and the precise boundaries of contaminated areas.

When mercury contamination is detected at a site, it should also be sought in the surrounding area. Sampling should be carried out both 'inside' and 'outside' the site, to assess the possibility that the contamination affects adjacent surroundings.

In all cases, it is essential to obtain a reference sample to determine the background levels of mercury. If the site is in a mining area, a great deal of caution must be taken in defining the **reference level**. The mineral deposits could extend beyond the limits of the mine, due to the continuation of the geological formation that contains the deposit. Thus, high metal content results could be obtained that are not strictly due to the mining activity. In these cases, special attention should be paid to soils and aquifers.

Sampling

The tasks of sampling, analysis and monitoring should be carried out by qualified professionals, in accordance with a well-thought-out plan, using widely accepted methods. The same methods should be used throughout the programme.

It should be stressed the importance that sampling has on a decontamination project. Sampling errors or deviation from the standard operating procedures could produce data detrimental to the programme, which is why the samples must be representative and must conform to the desired levels of reliability. Samples should be preserved and stored in the shortest time possible after collection. The time elapsed between the taking of samples and their preparation for analysis should be the minimum, and is recommended to maintain the samples refrigerated until delivered to the Laboratory.

In addition, rigorous quality assurance and control measures should be applied.

Sampling may be selective, systematic and random, including all matrices (soil, sediment, water):

- Selective sampling

The sample collection points are determined by the experience of the sampler, and usually include factors such as the visibility of the area of a chemical spill, changes in soil color,

areas of previous physical disturbance or areas with no vegetation or dead vegetation. In environmental studies, selective sampling is often the basis of an exploratory investigation.

- **Systematic sampling**
It is useful at sites with chemical spills or aerial deposition of pollutants, this method is useful to document probable concentration gradients and is often used in monitoring programs. The points of sampling can form various patterns in the soil: zigzag, diagonal, grid, sinuous, etc. Subsamples should also be taken at each vertex where the direction of the pattern changes.
- **Random Sampling**
Allows every possible combination of sample units to be selected and the number of possible combinations is limited only by the size of the sample.

Analyses

In order to obtain significant, acceptable results, the analytical laboratory should have the required infrastructure and proven experience with the matrix and type of mercury to be analyzed. One excellent way to verify the validity of results is the participation in an inter-laboratory comparison programme.

In addition, procedures such as homogenization and acceptance criteria for handling and preparing samples in the laboratory should be established. Chapter 6 deals with sample preparation and analytical considerations. For further considerations about the pretreatment of the samples, consult the standard NEN-EN-16179: 2012 “**Sludge, treated biowaste and soil: Guidance for sample pretreatment**”

The methods to analyse the various matrices of mercury may assess the total mercury content or the speciation of mercury. Some have been defined by the International Organization for Standardization (ISO) and the European Committee for Standardization (CEN). Other national methods have been drawn up, such as those of the United States (EPA) or Japan.

The following criteria must be met to obtain high quality results:

- a) Specification of the analytical technique.
- b) Presentation of reports, according to the established quality procedure
- c) Maintenance of the analytical equipment.
- d) Validation of all of the methods used (including the laboratory’s own methods).
- e) Training of laboratory staff.

In addition, procedures such as homogenization and acceptance criteria for handling and preparing samples in the laboratory should be established.

5.1 Characterization of surface water and groundwater

Analysis of water samples is usually carried out in the lab rather than in the field. However some field testing is possible. Use of Teflon bottles washed with HCl acid is recommended as a good means of preventing cross contamination. Ensure the acid used is mercury-free, as acids can serve as a source of various contaminants, including Hg.

Speciation in water is an important topic for the understanding of mercury behavior in the environment and for the treatability of water contaminated with mercury. Various forms of Hg arising from various means of treatment of the water sample have to be distinguished (e.g. filtration of sample and treatment with BrCl yields information on $Hg_D = Hg^0 + Hg_R + Hg_C$; however acid digestion followed by analysis yields information on $Hg_T = Hg_P + Hg_D$):

- Hg_T = total
- Hg_P = particulate
- Hg_D = dissolved Hg
- Hg_R = reactive
- Hg^0 = gaseous
- Hg_C = colloidal / residual

Analysis of water samples for methyl-Hg may be accomplished with the use of isotopic tracers and GC-ICP-MS analysis.

5.1.1 Surface water

The mercury content of surface water at the contaminated site and in the surrounding area should be studied, as water may act as a pathway for the dispersal of contamination by leaching from the site.

To determine the impact of the contaminated site on surface water, an analysis will be carried out upstream of the supposed mercury point source and downstream of all the possible points of exposure. This analysis should focus on points at which the water is used for human consumption, recreation, cleaning clothes, etc.

Unfiltered samples are generally used to analyse surface water. In addition, mercury sampling must be carried out in *all of the seasons*, that is, in periods of rain and drought, heat and cold.

Whenever a body of surface water is analysed, information should be gathered on the **sediments**. For this purpose, simple and surface samples (0-5 cm) should be taken at places upstream and downstream of the pollution point source.

In areas where contamination is found in water, it is important to know if the aquatic fauna is fished for food, in order to assess the possibility of fishing restrictions.

Once the drainage network has been defined in the additional report, a sampling campaign should be designed for liquids and solids (sediments). The aim is to assess:

- 1- the water quality in the area surrounding the site;
- 2- the sediment quality in stream beds in the area;
- 3- whether sediments are affected by contaminated material or by the contaminant itself carried by the water.

The following tasks should be carried out to design the sampling campaign:

- Inventory of surface water points.
- Field survey of all the types of water points.
- Selection of sampling points and the period (or periods) most suitable for carrying out the sampling, depending on the climate.
- Establishment of background mercury levels in the area. Sampling points should be selected upstream of the study area, to assess the levels of mercury present before the water reaches the polluted area.

Mercury levels in surface water that are above the limits established for water for human consumption (1 µg/l) should generally be sufficient to merit an in-depth analysis of the source. Such levels could be proof of contamination or due to natural enrichment.

5.1.2 Groundwater

Aquifers are one of the media that are most vulnerable to contamination in hazardous sites. Therefore, they should be monitored not only by means of man-made wells, but also through samples collected from springs and other natural underground water sources.

Hydrogeological studies should be carried out in the study area, and should include some of the following activities:

- a) The design of a preliminary scheme for hydrogeological conditions in the area, including the creation of an inventory of water points (water catchment points and springs in the area).
- b) Field survey of all the water points. The following data should be gathered: construction characteristics, extraction capacity, piezometric level and physicochemical characteristics of the water.
- c) Selection of sampling points and the period or periods that are most suitable for carrying out the sampling, depending on the climate.

When required by the size and complexity of the situation, additional information may need to be gathered through the following activities:

- d) Test drilling around the site through structures and formations of hydrogeological or hydrochemical interest. This will reveal changes in the piezometric level and enable the detection of vertical gradients.
- e) Hydraulic characterization tests in areas not investigated by the test drilling, to determine the permeability of the main structures in the area through the different rocks.
- f) Hydrochemical sampling along the test drill holes by clogging stretches to reveal the chemical characteristics of the underground flow at different depths of water upstream and downstream of the pollution point source.

Due to the natural variability in aquifers, they *should be analysed at least three times a year*, depending on the local climate.

The following parameters should be measured in the water:

- Parameters measured in situ:
 - Temperature
 - Conductivity (salinity)
 - pH (acidity)
 - Dissolved oxygen
 - Eh (redox potential)
- Concentrations of metals:
 - Mercury
 - Arsenic
 - Barium
 - Chromium
 - Iron
 - Nickel

In addition to these analytical determinations, other tests can be carried out according to the type of production process that generated the mercury deposit, and the expected composition of the pollution point source.

Likewise, other measures can be implemented to determine the presence of anions such as sulphates, nitrates, nitrites, carbonates and ammonium.

Mercury levels in aquifers can only be compared with reference values (for example, those of the US-EPA) when the *analysed samples have not been filtered*. The analysis should also include samples from domestic taps, as the concentration of contaminant in taps could be different from the values found in a well or spring.

In all cases, mercury levels above the reference levels for human consumption (1 µg/l) should be analysed to determine their source.

5.2 Soils and sediments

Before the soil sampling campaign is designed, a site survey should be carried out to take into account various factors, including:

- Geomorphology of the site.
- Topographical and geological characteristics, land uses, identification of escarpments, slopes, steeply sloping hillsides, instability, etc.
- Accessibility of the site and sampling areas.
- Identification of areas of natural ground and areas formed by backfill due to the movement of deposited materials. This point is of particular interest in the sampling of urban areas, where it is important to determine whether soil has been removed or mixed up by urban development works.
- Historical site uses (industrial process, tanks, pipelines, waste storage, landfill areas...)

On the basis of this information and data from the additional report, guidelines will be established for the sampling campaign. Contamination is mainly dispersed by wind, through resuspension and sedimentation of fine materials (generally the distribution is marked by the directions of the main winds in the area), and by surface water.

Taking into account the distribution of the winds and the surface water that runs through the site, a rhombus-shaped sampling grid should be established with sides measuring 50 by 50 metres. The grid should be symmetrical about the direction of the prevailing winds direction, as it is considered a priori that these winds will have the maximum concentration of suspended particles in the gradient of contamination. In addition to the aforementioned grid, a series of regularly spaced points should be sampled in a concentric pattern around the boundary of the contaminated site to compare and assess the impact of non-prevailing winds on the movement of solid particles.

Surface soil sampling will be carried out by removing a thin layer of earth and then taking the sample with a clean spatula. The deep soil sample will be taken at the same point as the surface sample using appropriate sampling equipment (auger).

In particular for soil/sediment, the sampler cylinder should be used, since this allows a sample unaltered in which it can be seen the profile and the depth of contamination.

The hydrogeological test drill holes can be used for sampling, which should be preferably of continuous recovery of core.

Each sample can weigh approximately one kilogram, to ensure the representativity of the sample, of which a homogenized portion of around 100 ml will be taken later on in the Lab for analysis. The rest of the sample will be kept referenced and stored for further tests, if necessary. For sediment sample, the weight could be less according to the analyses to carry out.

In the case of mining activities, the soil samples should be taken at three levels: simple surface (0-5 cm), at a depth of 0.5 m, and from rock samples obtained in test drill holes, if applicable. The aim of sampling at the first two levels is to discover potential variance between surface and deep soils due to mercury enrichment caused by migration from soil and concentration in the contact surface with the bedrock. The in-depth network sampling can be done at half of the points and alternating them.

5.3 Characterization of air and food

5.3.1 Air

Mercury levels in ambient air should be considered because of the high dispersion and ease of evaporation of this metal. As mentioned above, sampling points should take into account industrial activities within and outside the site, as well as meteorological conditions.

There may be many sources of mercury in ambient air. However, high levels naturally indicate that there is mercury in the area. The measurement of mercury concentration in air is a rapid way to confirm the presence of the metal. This is because contaminants are commonly dispersed in air, but do not remain in it. As a result, levels drop once the source of contamination has been removed or reduced.

In its *Air Quality Guidelines for Europe*, the World Health Organization (WHO) established a guideline value of 1000 nanogram/m³ (1 microgram/m³) as an annual average for mercury in ambient air.

The United States Environmental Protection Agency (EPA) selected a reference concentration of mercury of 300 ng/m³ for exposure in residential areas.

European Directive 2009/161/EU establishes maximum occupational exposure (8 hours per day) at 20,000 ng/m³.

Modelling can be carried out to identify the most likely pollution point sources (samples of ambient air should always be taken). Air samples can be collected in 24-hour periods according to a schedule that takes into account the meteorological conditions throughout the year.

A detailed record should be kept of the meteorological conditions and all the activities that were being carried out in the area at the time of each sampling.

5.3.2 Food

The mercury content should be determined in plant and animal samples of the food produced in the area and other food that is frequently consumed by the population. Food generated by fishing and hunting should be included, as well as those from agricultural sources.

When sediments are contaminated, sampling should include species that are bottom feeders in rivers, streams and lakes. It is not as important to include fish that feeds in the water column.

According to the principle of precaution, the intake levels described in World Health Organization (WHO) recommendations should not be surpassed. In 2008, WHO published a guidance document http://www.who.int/ipcs/assessment/public_health/mercury/en/ to provide information on the potential impact of mercury exposure and to help, as much as possible, to identify at-risk populations.

In the guidance document, WHO indicates that two groups are particularly vulnerable to the effects of mercury. Fetuses are particularly sensitive to the effects of mercury. Intrauterine exposure to methyl mercury due to maternal consumption of fish (especially Tuna, Swordfish, Shark..) or seafood may damage a baby's brain and nervous system. The main consequence of methyl mercury is potential disorders of neurological development. As a result, exposure to this substance during the fetal stage may affect a child's cognitive ability, memory, concentration ability, language, fine motor skills and spatial and visual skills. Therefore, particular attention should be paid to pregnant women, breastfeeding women and women of childbearing age.

The second group is that of people who are systematically exposed (chronic exposure) to high levels of mercury. This group includes people with fish as staple food (subsistence fishing) or those individuals occupationally exposed.

As the population's eating habits could mean that their mercury intake approaches the limits, it is advisable to restrict access to affected foods and even to regulate the use of the land and/or the types of crops that can be grown in the affected area, to ensure that the health of the surrounding population is protected.

6 Sample preparation and analytical procedures

A well-contrasted methodology is described in the following section, taking into account that other different techniques may be used depending on each specific case, the expertise of its analysts and the technical means available.

A. SAMPLE PREPARATION

a) Soils saturated with water and Sediments

Two alternative procedures are described, the drying of the sample at room temperature and the lyophilization.

a.1 Drying at controlled room temperature (max. 20-22 ° C)

- 1- If the sample is saturated with water, it should be filtered to separate the liquid phase. If the original sample is dry enough, then proceed directly with the homogenization phase (point 3). In any case, the humidity content of a sub-sample shall be determined in parallel in a kiln or in a thermobalance (see footnote⁶).
- 2- The solid part is put over absorbent paper at controlled room temperature (not above 20-22 ° C), and it is weighed periodically until the weight becomes constant.
- 3- Homogenize the sample.
- 4- If no prior information about the approximate concentration of mercury is available, an option could be to run an ESCHKA¹⁸ analysis for guidance on the most suitable technique to determine the Hg content of the sample.
- 5- Perform the analysis depending on the expected concentration, with the guidance given later on in point B. For this, except when using the technique of pyrolysis, it will be necessary a prior dissolution of the sample. The most common procedure is the aqua regia attack, but there are other alternative methods depending on the characteristics of the sample
 - ISO 11466.3 (aqua regia)
 - EPA 3050B (HNO₃-H₂O₂-HCl).
 - MICROWAVE ASSISTED ACID DIGESTION EPA 3015, 3051, SW 846
- 6- Give the result referring to dry matter, with the moisture correction formula (see note¹⁹)

¹⁸ The method ESCHKA is based on the mercury amalgamation process on a gold plate. The soil sample is introduced in a porcelain crucible and covered first with a layer of iron powder and later with a layer of zinc oxide. Then, the porcelain crucible is covered with a gold plate. After that, the crucible is subjected to a calcination process and it leads to the formation of gaseous mercury which is fixed to the gold plate. The difference on the weight of the gold plate let us to determine the mercury contained in the soil sample. The measured range of mercury can be from around 0.2% to more than 30%.

¹⁹ Moisture correction : The resulting concentration of mercury in the original sample, expressed on dry sample will be:

a.2 Lyophilization

Lyophilization (freeze drying) is a method that minimizes the loss of volatile components, such as mercury, in the drying process of samples with humidity, being also very convenient for organic tissues (fish, shellfish, algae, etc). The result is a sample with a very low moisture content that can be directly analyzed. Lyophilization is especially suitable for small amounts of sample.



Laboratory device for lyophilisation

b) Dry soil sample

- 1 - Dissolution of the sample, usually in aqua regia, except when using a pyrolysis technique.
- 2 - Make the corresponding analyses.
- 3 - Reference the results on a subsample dried at 105 ° C, as described above.

c) Determination of Hg in liquid samples

For the analysis of mercury in liquid samples, the measurement is made directly (prior to vacuum filtering with filter size of 0.20 microns) depending on the expected range of mercury (see point B).

$$R = \frac{L}{1000} \cdot \frac{b \cdot F}{M} \cdot \frac{100}{100 - H}$$

- R: concentration of mercury on dry solid sample mg/kg (ppm)
L: mercury concentration in the solution analyzed (micrograms/liter)
b: final digestion volume in milliliters.
F: dilution factor of the digestion, if any
M: weight of original solid sample digested, in grams.
H: value of loss at 105 °C, in % of original sample.

B. MOST COMMON ANALYTICAL PROCEDURES

1. For solid samples with mercury concentrations above 300 ppm, the exact concentration of mercury can be determined directly following the ESCHKA method (see footnote⁵)
2. For solid samples with a mercury concentration between 20 and 300 ppm, the exact concentration of mercury can be directly determined by pyrolysis of the sample (ie the RP-91C attachment from LUMEX company is intended for decomposition of a sample and the reducing of mercury from the bound state into an atomic state using the pyrolysis technique) and subsequent analysis by atomic absorption spectrophotometer.
3. For samples with a mercury concentration between 0.05 to 20 ppm, the exact concentration can be determined by ICP-AES (Inductively Coupled Plasma-Atomic Emission Spectrometry), also referred to as Inductively Coupled Plasma Optical Emission Spectrometry (ICP -OES), performing a pre-digestion of the sample in an acid mixture.
4. Alternatively, for more than 1 ppm of Hg, the technique of cold vapor system (CVAAS) with subsequent measurement by atomic absorption spectrophotometry (based on ISO 12846:2012), which is the most extended in the Laboratories, or its equivalents FIAS and FIMS can be used. Problems that may arise are that organo-mercury compounds will not respond to the cold vapor atomic absorption technique and possible interferences may appear with chlorides, iodides, sulfides, copper and VOCs. It is recommended first to eliminate organic bonds with aqua regia in solid samples and with digestion with nitric acid in liquid samples followed by an oxidization of all mercury to its bivalent state with permanganate or dichromate, and finally reduce as usual with borohydride or stannous chloride. A safe option would be the use of the method of standard additions to confirm the results, or to change the technique if the problems persist.
5. Solid samples with a concentration of less than 0.05 ppm mercury - although it can also be used for higher concentrations- can be analyzed directly without dissolution from the original solid sample by thermal decomposition (i.e. the RP-91C attachment from LUMEX company is intended for decomposition of a sample and reducing the mercury from bound state into an atomic state using the pyrolysis technique), then amalgamation with atomic absorption spectroscopy (ie the equipment AMA-254). The method is based on norm EPA 7473 SW 846.

In any case, when the pyrolytic process is used and mercury is suspected to be bound in silicates or other matrices that may not thermally decompose, validation of direct analysis of the solid should be confirmed with total acid digestion with an appropriate method (such as method EPA 3052), followed by analysis with AMA-254 or other equivalent mercury analytical techniques.

7. Risk assessment

The Environmental Risk Assessment (ERA) will help to answer the following questions:

- Does the site represent a real or potential risk to the human population and/or to the biota?
- What is the magnitude of the risk?
- Should the site be restored to reduce the risk?
- If the site is not restored, could the risk increase and/or spread?

ERA is a process that assigns magnitudes and probabilities to the adverse effects of contamination. Consequently, it is an instrument that can help to define whether or not environmental measures should be implemented at a contaminated site. Risk assessment can establish the urgency to act: the greater the risk of the contamination affecting living beings, the greater is the need to implement restoration programmes.

Risk assessment can be used to define remediation objectives for a site, which may be to reach (a) the maximum acceptable limits established by current legislation or relevant authorities or (b) specific limits set for the site on the basis of the assessment.

ERA constitutes a tool for deciding whether to carry out corrective actions at the contaminated site and for setting the final remediation objective, thus selecting the best clean-up strategies. The ideal objective is to restore the site and its uses with concentrations to the levels found in the environment prior to contamination through techniques described in point 7.1. However, this may be economically unfeasible and other options should be considered, as it is mentioned in that point.

The establishment of a **target clean-up level on the basis of a risk assessment** means that the contamination will be reduced to its maximum accepted level, which may be not necessarily zero (speciation, lability and biodisponibility of mercury are parameters that can be taken into account). Thus, at the end point, the residual concentration of the contaminant will not constitute a risk to the human population and biota.

Risk assessment can be carried out in four clearly defined stages with specific objectives:

1. Identification and characterization of what is at risk. All analyses of these characteristics should help to assess the risk to human health and to ecosystems.
2. Analysis of the hazard level and toxicity. The aim of this stage is to identify elements or compounds that may be critical; to characterize the kind of effects they may have; and to evaluate dose-effect relationships, in order to predict the response to the contaminant for a wide range of doses. This analysis is based on contaminant data and characteristics, referring to its environmental and toxicological behavior.
3. Analysis of exposure. The aim is to estimate the rate of contact with the identified contaminants. The analysis is based on a description of exposure scenarios, as well as characterization of the nature and extent of the contamination.

4. Analysis of risks. The results of the previous stages are combined to objectively estimate the likelihood of adverse effects on the protected elements under the specific conditions of the site.

Other contaminants besides mercury may have an impact. Therefore, if there is evidence that other contaminants are present at the site, the responsible of the process must take the decision to include them in the study and assessment.

7.1 Characterization of toxicological effects

This section of the risk assessment evaluates and describes the effects of the significant contaminant (mercury) on the receptors identified through the different exposure routes.

Contamination receptors that are frequently at risk in mercury-contaminated sites are:

7.1.1 Humans

In humans and some animals, the potential effects and symptoms of mercury intoxication vary according to the chemical form of mercury, the exposure route (inhalation or ingestion) and the exposure dose, including the exposure time and the concentration of the mercury.

For all the inhabitants of an area where a mercury-contaminated site is located, the main potential exposure routes are as follows:

- Breathing (absorption by inhalation) of mercury and/or dust.
- Eating (absorption by ingestion). It is considered that mercury ingested in food is mainly in the form of methylmercury (an organic compound of mercury).
- Dermal contact.

7.1.2 Terrestrial animals

In general, the symptoms of intoxication reported in animals for cases of mercury poisoning are not specific and depend on the exposure route, as in humans.

7.1.3 Aquatic biota

Many factors influence the potential toxicity of mercury in aquatic biota. These include the form of mercury, the developmental stage of affected organisms, and the chemistry of the water.

Changes in temperature, salinity and the hardness of the water also alter the toxicity of mercury to the biota.

It is widely accepted that the most toxic form of mercury is **methylmercury**. Reducing conditions (i.e. low-oxygen concentration) are needed for methylation to occur. It is well known that bacterial action promotes methylation, which is the main process responsible for the transformation of inorganic mercury to an organic formulation able to enter throughout the food chain.

In aquatic systems, fish are the main receptors of mercury through ingestion, as they are exposed to mercury both in water and through the ingestion of plants and macroinvertebrates.

Fish and macroinvertebrates like shellfish can also absorb mercury through the gills.

Macroinvertebrates may also be exposed to mercury in sediments, as are species of fish that feed on material deposited on top of the sediments. Due to their position at the top of the food chain in aquatic systems, it is assumed that fish have the highest concentration of mercury of all kinds of aquatic biota.

7.1.4 Plants

Plants are generally not sensitive to inorganic forms of mercury (i.e. elemental mercury and ionic mercury), probably due to the high level of absorption of the metal by soil particles. This largely prevents the absorption of mercury and toxicity in plants, which normally do not concentrate heavy metals²⁰, but show greater access to organic forms of mercury, such as methylmercury, than to inorganic forms.

7.2 Evaluation of exposure

By this stage, we know the exposure routes, the receptors, the concentrations and the toxicity.

The evaluation of exposure consists in combining the results of the risk assessments for humans and ecosystems with dispersion studies to assess the degree of mobility of contaminants and to analyse concentrations in the different media that are affected.

The exposure sources that should be considered at a mercury-contaminated site are the media analysed in the environmental characterization, i.e: particles in suspension (PS), gas emissions, surface water, groundwater, soil and sediments.

7.3 Risk characterization

Risk characterization is the final stage in the risk assessment. During this stage, the probability of the occurrence of adverse effects due to mercury exposure is evaluated, and the bases are established for future actions.

²⁰ Preventive Measures against Environmental Mercury Pollution and its Health Effects. Japan Public Health Association, 2002.

In addition, data and conclusions from the stages in which the toxicological characteristics and the effects of the significant contaminant were reviewed are analysed together, along with the evaluation of exposure. All of these data are combined with the reasoning behind the proposed conceptual model.

For human health, the contaminant dose received by an individual (calculated on the basis of the characterization of the exposure scenario) is compared with the toxicological reference values set for this substance and population strata.

The following results should be obtained:

- a. Conclusions on the actual risk of contamination at the site for human and ecosystem receptors, as well as the risk of dispersion (future risk).
- b. Estimation of the level of uncertainty in the risk analysis, in order to accurately evaluate the conclusions of the characterization.

This stage can be carried out with the help of validated software to simplify the calculations, taking into account that its suitability should be justified for the specific characteristics and conditions of the site. Otherwise another method of calculation should be used. If software is used, screenshots of the process should be provided to confirm the values that were entered and the conclusions obtained.

Different approaches have been developed for the risk characterization stage, each one with its dedicated commercial software available, like:

- Risk-based corrective action (RBCA)
- Probabilistic risk assessment (PRA)
- Biotechnology-based direct toxicity assessment

8. Remediation of mercury-contaminated sites

Remediation measures for mercury-contaminated sites depend on various factors associated mainly with the location itself and with the potential impact on the environment and human health.

One or more remediation technologies can be considered, taking into account the results of the site study, the target clean-up levels, the capacity of the available remediation technologies, and the intended future use of the site.

The main factors that influence the selection of an initial set of treatment technologies are:

- a) Receptors (surface water and / or groundwater, soil, air, biota, human..).
- b) The (potential) mobility of mercury in the hydrological system.
- c) The possibility of leaching of mercury from soil or sediments.
- d) The pollution point source.
- e) Mercury concentrations in human, animal and plant receptors, which indicate exposure levels.
- f) The chemical states of mercury at the contaminated site.
- g) Bioavailability to the aquatic biota, invertebrates and edible plants.
- h) The amount of mercury released during the operations.
- i) The possibility of mercury methylation.
- j) Background mercury contamination, regional atmospheric deposition of mercury that is not associated with local sources.
- k) The local/national clean-up regulations for water, soils/sediments and air.
- l) In the case of mining operations, it is important to know precisely the geological formations that led to mercury extraction in order to not to include them as polluted soil due to the mining activities.

Once these factors have been evaluated, a more comprehensive analysis of the appropriate remediation techniques can begin.

Depending on the gravity, magnitude, degree and type of contamination by mercury and other pollutants and on the receptors, the recovery plan is likely to involve various remediation techniques or measures to reduce or contain the amount or toxicity of the contamination as effectively and efficiently as possible.

Below, some of the treatment options for mercury-contaminated media are described. These techniques can be used – alone or in combination - in the remediation of a contaminated site. In general, the aim of the techniques listed below is to recover the area by removing the mercury.

As mention in point 3.2.3, there is the possibility to restrict use of the contaminated area and limit access to it, at least until work can be started on recovery of the site.

Alternatively, a site can be contained by making it impermeable using natural materials such as clays or geosynthetic materials such as high density polythene sheets to prevent the evaporation and leaching of mercury.

In addition, waste can be transported for safe storage in landfills engineered for this purpose.

Another option is to propose different treatments for each area or product in a mercury-contaminated area.

8.1 Treatment of mercury-contaminated effluents and soils²¹

Numerous techniques can be used to treat mercury-contaminated effluents. Some processes are merely physical (sedimentation), others are physicochemical (coagulation-flocculation, adsorption, etc.), yet others are chemical (oxidation-reduction, precipitation, etc.). The appropriate choice depends on various factors, mainly the speciation of the element and the presence of other agents.

Point 8.1.1 treats specifically groundwater and surface water remediation

a) Precipitation

Precipitation of mercury in the form of insoluble salts is one of the most common practices in effluent treatment.

The main precipitant is sulphide. Mercury sulphide is one of the most insoluble salts and is the form in which most of the mercury on the earth's crust is found (cinnabar).

The optimum pH for the reaction is 7. The precipitate that is formed is then subjected to a sedimentation process, which can be assisted by the addition of flocculants. Mercury concentration values after sulphide precipitation are between 10 and 100 µg/litre.

This process has some disadvantages, such as the formation of high volumes of sludge that require subsequent treatment, and the formation of soluble species due to an excess of sulphide. Therefore, it is not the most suitable treatment for mercury-contaminated effluents.

b) Adsorption

Treatments involving adsorption produce lower mercury concentration levels than those obtained by precipitation. As the concentration of the adsorbent increases, the levels of remaining mercury decrease. Other factors that affect this process are pH and mercury speciation.

²¹ (Source EPA 1997)

The most commonly used adsorbent is activated carbon. This is generally in the form of granular activated carbon, in which the carbon has a relatively large particle size and can be used to fill columns.

c) Ion exchange

This is one of the main treatments for mercury-containing effluents. A wide range of resins can capture the different species of mercury. The technology is primarily designed to bind ionic mercury. It is not highly effective for organomercury compounds or elemental mercury.

The process is carried out in columns or tanks filled with the corresponding resin and equipped with systems for intake and outlet of the effluent, as well as clean water for rinsing, and regenerating solution.

Ion exchange systems have several advantages: they operate as needed, they are relatively insensitive to variability in effluent, they can produce zero concentration values, and a wide range of resins is available. The disadvantages include sudden exhaustion of the capacity, which means that the process must be monitored continuously, generation of a saline water effluent containing mercury, which must be treated, and potential problems when the process is used with water that contains a high level of total dissolved solids.

d) Oxidation – reduction

In some cases, oxidation and reduction processes are used to change the oxidation state of the mercury and thus promote its dissolution or decantation.

Oxidation is used in effluents that contain metallic mercury or organometallic compounds to transform them into the ionic form or to dissolve them as mercury halide. The process can take place in batch or plug flow reactors. Mercury salts separate from the matrix of waste materials and are then sent for further treatment, for example acid extraction or precipitation.

The most common oxidants are: sodium hypochlorite, ozone, hydrogen peroxide, chlorine dioxide and chlorine gas.

Reduction is used as a method for removing mercury in solution in the form of metallic mercury and then to sediment, filter or centrifuge it, for example. The most common reducing agents are: aluminum, iron, zinc, hydrazine, stannous chloride and sodium borohydride.

The decontamination rate is high in reduction processes when the mercury concentration is relatively high (up to 2 g/l). However, the efficacy of the process drops when the levels of mercury are low. In this case, further treatment is required.

e) Others

Other methods for treating mercury-contaminated effluents have given good results like membrane separation processes (such as ultrafiltration and reverse osmosis).

Others, some in the experimental stage, are biological treatments (microorganisms that can absorb mercury or reduce it), liquid emulsion membrane extraction and solar photocatalysis with titanium dioxide.

8.1.1 Technology for groundwater and surface water remediation (*Biester, 2013*)

In many cases, contaminant removal may not be possible and hydraulic containment may be necessary to protect the surrounding environment. In these cases, the most currently applied technology for groundwater and surface water remediation is Pump & Treat (P&T). Basically, P&T systems involve the installation of extraction wells below the water table within or slightly down-gradient from the zone of contamination. As the mass of contamination remains in the subsurface, P&T systems must operate in perpetuity to prevent off-site migration. As extracted water must be treated at the surface, well placement and pumping rate should be chosen to ensure capture of contaminated groundwater and limit recovery of clean water. Monitoring wells have to be installed around the contaminant plume to assess containment and evaluate hydrogeochemical conditions.

For high concentrations of mercury, the treatment technologies are similar to mercury recovery processes of industrial liquid effluents as described before (mercuric brine of chlor-alkali waste water, etc.). The treatment from bulk contaminated water enabling to reach concentrations below the remediation goals encompasses several treatment steps which may include for example: sulphuration, chemical reduction (hydrazine), co-precipitation and adsorption, ion exchange. These technologies are efficient for high concentrations (over 1 mg/L) and low flow rate (less than 10 m³/hour). It is often applied in batch processor. It has to be considered that this low flow rate treatment may reduce the ability of the pumping to capture the contamination plume.

For low concentrations (< 10 µg Hg/l), the most advisable treatment technique is groundwater filtration with sulphur-activated granular carbon (see table below).

Most frequently applied filtration technologies to remove mercury from water (HPC AG Freiburg, 2011):

	Modified activated granular carbon	Sulphur impregnated granular activated carbon	Ion exchange resins (e.g. Ambolite)
Source of information	Supplier	Supplier	Supplier
Principle	Sorption	Ion exchange and sulphuric sorption	Ion exchange on thiol group (-SH)
Efficiency (µg Hg/l)	<1	<1	<1

Adsorption capacity (g Hg/Kg filtration media)	4 (3-5)	8 (5-10)	50
Costs (€ / Kg filtration media)	3,6	4,5	40
Specific cost (€ / g Hg)	0,9 (0,7-1,2)	0,56 (0,45-0,9)	0,8

The table above shows the low filtration capacity and adsorption capacity of GAC (Granular Activated Carbon). Furthermore, the sorption kinetic on GAC is low, thus reducing the flow rate for an efficient filtration and Hg removal from water. It has also to be considered that mercury is often associated with other organic and/or inorganic compounds in complex water matrix (high or low pH, high salinity) causing competitive sorption and drastic reduction of the efficiency of traditional GAC filtration.

Low kinetic and adsorption capacity associated with high specific cost cause high capital and O&M (Operation & Maintenance) costs for traditional remedy using ion exchange technologies and GAC.

In any case, mercuric wastes such as mud, filters, saturated granular carbon are produced which have to be managed like a mercury waste.

8.2 Treatment of mercury-contaminated solid waste ²²

Mercury-contaminated solid waste treatments have been classified into four categories:

- a) Thermal treatments (retorting or roasting, among others)
- b) Solidification/Stabilization (including amalgamation)
 - a) Washing/Acid extraction
 - b) Vitrification

- a. **Thermal treatments** Thermal desorption and retorting are two common methods for full-scale thermal treatment of mercury-contaminated waste and for the treatment of soils and sediments.

These treatments volatilize the mercury by low-pressure heat transfer, followed by condensation on a cold surface.

Elemental mercury that is collected in this way can be reused in processes or stored. Off-gases should be treated to avoid emissions of mercury or other components.

a.1 Retorting/roasting (Source: ITRC 1998)

²² Source: *Treatment technologies for Mercury in Soil, Waste and Water, EPA 2007*

Pre-treated waste is sent to a desorber or retort where it is heated at low pressure to volatilize the mercury. Heating may be direct through contact with combustion gases or indirect through a metal wall (e.g. electrical heating).

When desorbers are in operation, the waste inside them is agitated continuously. The movement increases heat and mass transfer, leading to higher evaporation rates. In contrast, waste in retort and roasting equipment is static.

The most common desorbers are directly heated rotary kilns and indirectly heated screw systems.

Direct heating systems require high volumes of combustion gases when a large volume of waste is treated. Consequently, complex control systems are required, and gas emissions must be treated. In these cases, the investment and operating costs could be much higher than in an indirectly heated system, in which combustion gas is not mixed with the hazardous waste.

a.2 Gas treatment

Gases from the retort system are filtered through fabric filters to remove particulate matter. Subsequently, the gas is cooled in a condenser to transform gaseous mercury into a liquid. The gas is then treated in control systems comprised of activated carbon filters and catalytic oxidants to capture any leakage of mercury vapor and organic volatile matter.

b. Solidification/Stabilization

Solidification and stabilization are physicochemical processes that tend to reduce the mobility of mercury to a certain extent by physically enclosing it (solidification) or forming chemical bonds with it (stabilization). Amalgamation, that is, the formation of a solid or semi-solid alloy of mercury with other metals, is a form of solidification.

There are two main solidification processes:

- Macroencapsulation: the encasing material is poured over and around the waste mass.
- Microencapsulation: the waste is mixed with the encasing material before solidification occurs.

b.1 Stabilization by Sulphur

This process consists of converting liquid mercury into mercury sulphide (HgS); a form that is the most insoluble and common in nature.

There are two crystalline forms of mercury sulphide: alpha HgS and beta HgS, both of which are practically insoluble and have a very similar solubility in water.

If waste contains elemental mercury, Hg is mixed with S at room temperature and agitated rapidly.

The energy produced by mixing is sufficient to cause the activation. Alternatively, a reaction can be carried out between Hg vapour and S inside a mixer with an inert atmosphere, to prevent the formation of HgO.

Oxidation of mercury to HgO should be avoided, as this species is more soluble than the sulphur. Therefore, it is advisable to work in an inert atmosphere and to add antioxidants (Na₂S).

b.2 Sulphur–polymer stabilization

This is a modification of the sulphur process. It consists in stabilizing the mercury through a reaction with sulphur, followed by solidification/microencapsulation in a polymer matrix.

It is carried out in two steps:

1. Stabilization: Reaction between elemental mercury and sulphur polymer cement (SPC, a mix of 95% sulphur and 5% polycyclopentadiene).
2. Solidification (and microencapsulation): Heating to 135°C.

There are several advantages to this process: the product that is obtained is monolithic and has a low specific surface area. Hence it is less volatile and leaching is less likely.

b.3 Amalgamation

This process consists in the formation of a mercury alloy with other metals (amalgam). As the concentration of metal increases, the amalgam becomes more solid. The metals that are most frequently used are: copper, selenium, nickel, zinc and tin.

To accelerate the process, finely divided metals are added to the mercury.

b.4 Other stabilizing agents – solidifying agents

Other substances that are used as a medium in these processes are: cement, calcium polysulfide, chemically bonded ceramic phosphate, phosphates, platinum and polyester resins, among others.

Of the various matrices used in solidification processes, we can distinguish between those that require previous stabilization and those that do not. The distinction is based on the strength of the material, to ensure that mercury is not released.

c. Washing /Extraction

Soil washing and acid extraction are used for ex situ treatment of mercury-contaminated soil and sediments.

Soil washing is a water-based process that uses a combination of physical particle size separation and aqueous-based chemical separation to reduce contaminant concentrations in soil. This process is based on the concept that most contaminants tend to bind to the finer soil particles (clay and silt) rather than the larger particles (sand and gravel). Physical methods can be used to separate the relatively clean larger particles from the finer particles because the finer particles are attached to larger particles through physical processes (compaction and adhesion). This process thus concentrates the contamination bound to the finer particles for further treatment.

Commonly used methods for treating the wastewater include ion exchange and solvent extraction. Acid extraction uses an extracting chemical such as hydrochloric acid or sulfuric acid to extract contaminants from a solid matrix by dissolving them in the acid. The solid and liquid phases are then separated using hydrocyclones, and the solids are transferred to a rinse system, where they are rinsed with water to remove entrained acid and contaminants.

The precipitated solids may require additional treatment or may be disposed in a landfill, and the acid extraction fluid and rinse waters are then treated to remove the heavy metals.

The principal advantage of soil washing /acid extraction is that hazardous contaminants are separated from soils and sediments, thereby reducing the volume of hazardous waste to be treated / disposed. The performance and viability of soil washing depends on factors like soil type, composition, particle size distribution, homogeneity and Total Organic Carbon present. Also, complex, heterogeneous contaminant compositions can make it difficult to formulate a simple washing solution, requiring use of multiple, sequential washing processes to remove contaminants

d. Vitrification

Vitrification uses electrical current to heat, melt and vitrify the treatment material in place, thus incorporating them into the vitrified end product, which is chemically durable and leach resistant. Electric current is passed through soil by an array of electrodes inserted vertically into the surface of the contaminated zone.

The temperature of the contaminated soil can reach between 1,600 and 2,000 °C. A single melt can treat a region up to 1,000 tons.

Vitrification is used to treat wastes up to a depth of 6 meters. Large contaminated areas are treated in multiple blocks that fuse together to form one large treated zone.

The gases produced must be collected and sent to a treatment unit. Dioxins and furans may also form when excess chlorides are present and enter the off-gas treatment system.

Mercury may be difficult to treat because of its high volatility and low solubility in glass (less than 0.1 percent), but may be effectively treated at low concentrations.

Chlorides in excess of 0.5 weight percent will typically fume off and enter the off-gas. If chlorides are excessively concentrated, salts of alkali, alkaline earth, and heavy metals may accumulate in the solid residues collected by off-gas treatment. Separation of the chloride salts from the residue may be necessary, therefore, if the residue is returned to the process for treatment.

The following table presents a summary of the pros and cons of the most usual strategies and treatments:

Technology	Principle	Key advantages	Key disadvantages	Targeted mercury	Status
<p><u>Source removal with excavation</u></p>	<p>Excavation of the polluted materials on the whole contaminated area or specifically on the hot spots where the mercury masses are concentrated</p>	<p>Provide total remedy, radical with no residual concentrations to manage if the whole area is excavated</p>	<p>Could be expensive due to health and safety constraints for workers and surrounding. Risk of remobilization of labile elemental mercury.</p> <p>Geotechnical limitation due to groundwater level and/or existing infra-structures</p> <p>Transport of the polluted soil to the landfill</p> <p>Necessity of an engineered landfill suitable for Hg wastes</p> <p>If only hot spots are removed, management with other technologies of residual non excavated soils.</p>	<p>Total labile mercury</p>	<p>Reliable technology but with difficulties inherent to the occurrence of mercury</p>
<p><u>In situ containment with vertical barriers and capping</u></p>	<p>Isolation of existing contaminated areas in the subsurface from the surrounding uncontaminated environment</p>	<ul style="list-style-type: none"> -Relatively simple and rapid to implement -Uses standard construction equipment -Can be more economical than excavation and removal of waste, and thermal treatment -Can be applied to large areas or volume of waste -Avoids use of monocell space and risks associated with removal and transport -Provides a total remedy that addresses all mercury present in the targeted area -Provides a relatively passive system that doesn't rely an active management 	<p>Mercury remains on site and there is no reduction of toxicity and masses; this represents a potential risk should containment fail / degrades</p> <p>Geotechnical limitations due to existing infra-structures</p> <p>Vertical barrier limited to depth less than 20 m due to increasing capital costs.</p> <p>Vapour treatment by gas-drainage-capping</p>	<p>Total labile mercury</p>	<p>A variety of barrier materials are easily available</p>

Technology	Principle	Key advantages	Key disadvantages	Targeted mercury	Status
<u>Soil-washing with preprocessing (mechanical separation)</u>	Ex situ technique where soils and polluted materials are washed, generally with water and/or oxidative acid solutions. Wash water and wash solutions can be treated and recycled	<p>Possible reuse of treated material on site for filling.</p> <p>Reduction of waste to be treated /landfilled</p>	<p>-Source removal required</p> <p>-Pre-processing with physical separation, sorting, grinding of the material may be required</p> <p>-Technical difficulty increases depending of the type of soils and contaminants</p> <p>-Technology only viable for important volumes to treat due to costs.</p>	Hg ⁰ and inorganic mercury	Soil washing units have efficiently treated soils and mercury wastes in different countries.
<u>On-site immobilisation: stabilization & solidification, amalgamation with on-site or off-site disposal</u>	Chemical reaction (stabilization) and physically encapsulation (solidification) to reduce the hazard potential of a contaminated material by converting the contaminant into less soluble, less volatile, less mobile, and/or less toxic forms . On-site or off-site disposal in special engineered landfill licensed to receive mercury wastes.	<p>-Lower waste classification by reaching the acceptance criteria for leaching;</p> <p>-Reducing the risk during transportation</p> <p>-Enable containment in special engineered landfill (monocell).</p>	<p>-Required excavation</p> <p>-Required site-specific testing at laboratory and pilot scale prior to full-scale application</p> <p>-possible passivation of elemental mercury during mixing and inefficiency of the treatment when Hg⁰ droplets occurs (high elemental mercury content)</p> <p>-Increase of the bulk waste volume</p> <p>-the long term stability of stabilized media is uncertain or has not been assessed with some reagents</p> <p>--Carbon fingerprint when transportation of the waste off site</p> <p>-Elevated cost for large volume of waste (800 to 1000 € per tonne)</p> <p>-Long term monitoring required</p>	Total labile mercury, especially Hg ⁰	

Technology	Principle	Key advantages	Key disadvantages	Targeted mercury	Status
<p><u>In situ thermal desorption (ISTD)</u></p>	<p>In situ heating of contaminated soils causing direct volatilization – removal of volatilized products through soil vapor extraction.</p>	<ul style="list-style-type: none"> -No excavation required -Selective extraction of labile mercury (which is the environmental issue) -Short duration of operation 	<ul style="list-style-type: none"> - Could be expensive and technically difficult to conduct -Requires dense combined borehole networks for both soil vapor extraction + heating -mercury captured in the vapor treatment system must be managed, -Fugitive emissions of mercury vapor must be controlled, -Secondary treatment of wastewater streams from condensed water would be complex -Large energy consumption 	<p>Hg⁰ and inorganic mercury</p>	<p>ISTD has been demonstrated commercially at full scale for high boiling point organic compounds remediation.</p>
<p><u>Ex situ Thermal Desorption (ESTD)</u></p>	<p>Ex situ thermal desorption is a continuous process normally conducted in rotary kilns (or equivalent)</p>	<ul style="list-style-type: none"> -Recovery of mercury and separation from material that could be reused for filling on site -High abatement efficiency 	<ul style="list-style-type: none"> -excavation and temporary storage required -re-treatment would be required -Large energy consumption -Fugitive emissions of mercury vapor must be controlled -mercury captured in the vapor treatment system must be managed -Secondary treatment of wastewater streams from condensed water would be complex 	<p>Hg⁰ and inorganic mercury</p>	<p>ESTD has been demonstrated commercially at full scale for mercury remediation only for low concentration (< 10 mg Hg/kg).</p>

Technology	Principle	Key advantages	Key disadvantages	Targeted mercury	Status
<p><u>Batch retorting</u></p>	<p>Ex situ process where contaminated soils are heated in a controlled manner – volatilizing contaminants (e.g. mercury) which is then recovered from off-gases.</p>	<ul style="list-style-type: none"> -Thermal desorption under controlled conditions -Recovery of mercury and separation from material that could be reused for filling on site -High abatement efficiency 	<ul style="list-style-type: none"> -excavation and temporary storage required -limited to treatment capacities of the order of one to five tons per day -expensive, high energy requirements, require vapor treatment, and significant handling effort and long treatment times (1 to ten years based on the capacity of 5 tons per day) 	<p>Hg⁰ and inorganic mercury</p>	<p>It has been demonstrated commercially at full scale for small volume of highly polluted materials</p>
<p><u>In situ Vitrification (ISV)</u></p>	<p>High temperature process that immobilizes contaminants by incorporating them into a vitrified matrix which is durable and leach resistant</p>	<ul style="list-style-type: none"> -High abatement efficiency, -No excavation required 	<ul style="list-style-type: none"> -Operation and maintenance would likely be technically difficult and expensive -Required site-specific testing at pilot scale prior to full-scale application -Required dense combined borehole networks for both soil vapor extraction + heating - Mercury captured in the vapor treatment system must be managed Fugitive emissions of mercury vapor must be controlled -Secondary treatment of wastewater streams from condensed water would be complex -Large energy consumption -the long term stability of in situ immobilized media is uncertain or has not been assessed (metastability of glassy material) 	<p>All forms and combination of mercury</p>	<p>One application reported at full scale with ex-site treatment in the USA for mercury wastes.</p>

8.3 Safety measures. Prevention of occupational risks during clean-up work

Remediation tasks may lead to mercury exposure and all the risks that this entails, in addition to all the usual risks associated with the activity itself. To avoid risks, it is essential to know the mercury levels that workers are exposed to.

Environmental monitoring of the concentration of a toxin in air is the main instrument in the prevention of health-related occupational risks in general, and in relation to mercury in particular. There are two forms of environmental monitoring. **The first** involves sampling the air in a work area. **The second** focuses on staff and involves sampling the level of exposure of workers during their working day, as staff normally moves from one place to another during the day.

Another control for each exposed worker individually is the biological monitoring. This occupational health procedure measures a potential toxin, in this case mercury, its metabolites or an unwanted chemical effect in a biological sample, in order to assess individual exposure.

These measurements are known as biological exposure indicators or biomarkers. Biological monitoring measures the amount of the agent that has been absorbed, regardless of the pathway. It takes into account the elimination pathways, the toxicokinetics and the toxicodynamics of the corresponding substance. As a preventative measure, biological monitoring should be carried out regularly and repeatedly, but should not be confused with procedures for diagnosing occupational illness.

The daily environmental exposure limit values for mercury and for divalent inorganic compounds of mercury, including mercury oxide and mercury chloride (measured in mercury), is 0.02 mg/m^3 , measured or calculated for a reference period of 8 h. These values are in accordance with Commission Directive 2009/161/EU establishing a third list of indicative occupational exposure limit values.

There are several procedures for the environmental determination of mercury. Both active and passive systems can be used. The choice of system will depend on the type of evaluation that is required, the instrumental conditions and the available techniques, as well as on the form of the contaminant. Devices for taking direct readings can be used to measure a specific concentration.

The most common method involves trapping mercury as a vapor. This is usually achieved through the use of adsorbent tubes (hopcalite, manganese bioxide and activated carbon, among others) or passive monitors (for example, gold and silver plates) that amalgamate the mercury. When mercury is trapped in adsorbent tubes, the amount is usually determined using atomic absorption spectrophotometry. If passive monitors have been used, variations in electrical conductivity are generally measured. If the mercury is in the form of particulate matter (powder), it is trapped in filters and analysed by Atomic Absorption spectrophotometry. Electrochemical techniques, such as polarography and stripping potentiometry, can also be used for the analytical determination.

Biological indicators can be established for elemental mercury and inorganic compounds. These are appropriate parameters in biological media from a worker (urine and blood), and can be measured at a specific time.

The biological limit value for total inorganic mercury in urine can be set at 35 µg/g of creatine before the working day, i.e. after 16 hours without exposure. The limit value for total inorganic mercury in blood can be set at 15 µg/l at the end of the working week, that is, after 4 or 5 consecutive days of exposure at work. These values correspond with the Occupational Exposure Limits for Chemical Agents in Spain (National Institute of Safety and Hygiene at Work, 2012).

Preventative measures can reduce workers' levels of exposure. These include ventilation systems that increase air renewal in working spaces. Clean air is brought into the work area and contaminated air is extracted to treat it in activated carbon filters. In addition, protective clothing can be worn, such as mouth and nose masks with Hg P3 filters, in accordance with European Respiratory Protection Standards (EN 141: 2000).

8.4 Environmental monitoring required during remediation work

Environmental remediation projects for mercury-contaminated sites should include an Environmental Monitoring Plan (EMP) in addition to the remediation activities themselves.

The aim of the EMP is to determine and assess the environmental impact or damage to the area around the contaminated site to be remediated, in all stages of the remediation work. Thus, the EMP will describe appropriate measures for mitigating or avoiding negative environmental effects of the remediation activity. Measures will apply to the design and location of the remediation activity, the remediation procedures, purification, and general mechanisms for protecting the environment.

The EMP for remediation activities at a mercury-contaminated site will define monitoring and measurement activities. Measurements will be divided into two groups:

1. Those made during implementation of the remediation work.
2. Those made after the remediation work or monitoring activities.

In these two groups, there will be a particular focus on:

- Surface water and groundwater quality.
- Particle and gas emissions that affect the quality of life of inhabitants of the area.

In addition, remediation activities will be monitored by means of topographic control and a photographic record. Meteorological data will also be gathered.

The EMP will establish the method for monitoring remediation actions: the kind of reports that are required, the content of the reports, their frequency, and when they will be issued in the framework of the remediation project.

Quality control of the remediation work and of the significant environmental aspects that were identified for the project (in the design, implementation and maintenance stages) will be carried out according to the guidelines established in the Environmental Monitoring Plan.

An example of the main aspects to include in an EMP for a remediation project at a mercury-contaminated site is showed at the end of the chapter.

8.5 Monitoring and control of the expected results and of implemented activities

Once the option of remediation has been selected, a monitoring plan should be designed, implemented and run. This plan will determine the times and places at which monitoring will be carried out to assess the progress of the remediation actions and confirm that the targets have been met and that the site is not a risk to human health or the environment.

The design and implementation of a monitoring plan (MP) is highly specific to the type of remediation carried out and the contaminated site. Monitoring should be accompanied by assessment of the indicators, to verify whether or not progress has been made in the various activities that form part of the system or project under evaluation.

The aim of the basic control and monitoring indicators should be to verify that:

- Processes within the contaminated site that has been remediated are carried out according to plan.
- The environmental protection systems work exactly as proposed in the remediation project.
- There is compliance with the conditions of authorized use of the contaminated site.

At least the following indicators should be evaluated during the period established by the relevant authority:

1. Meteorological data. It is essential to establish the meteorological data that will be collected from the site:

- Volume of precipitation (daily and monthly values)
- Minimum and maximum temperature (monthly average)
- Direction and strength of the prevailing wind
- Evaporation (daily and monthly values)
- Atmospheric humidity (monthly average)

2. Emission data:

- Monitoring of surface water at representative points. The monitoring of surface water **should be carried out at two or more points**, including water upstream of the site and water downstream of the site.

Samples will be taken in different seasons, preferably every six months. The parameters will vary according to the characteristics of the site to be remediated. In the case of mercury contamination, the parameters should include the concentration of mercury and of other heavy metals, anions, pH, conductivity, etc.

- Monitoring of groundwater. This will be carried out at one point, or more, situated upstream from the site's inlet, according to the groundwater flow direction, and at two points downstream from the site's outlet.

The number of monitoring points could be increased on the basis of a hydrogeological survey of the area.

The sampling frequency will be specific to each location and will be determined on the basis of the knowledge and assessment of the groundwater flow rate. The recommended parameters include pH, conductivity, heavy metals and anions.

- Monitoring of mercury vapor emissions and particulates with mercury content. A monitoring network should be established both within and outside the site to be remediated, to determine the environmental levels of mercury, and thus check the effectiveness of the remediation actions.

3. Soil sampling survey

The duration of the MP and the sampling and data collection frequency generally depends on the environmental authority.

The following table shows some of the main parameters to include in a MP for a remediation project at a mercury-contaminated site, during implementation of the remediation activities and once the project is finished.

MONITORING PLAN			
MONITORED MEDIUM	MONITORING FREQUENCY	LOCATION	MONITORING PARAMETERS
Surface water	Monthly, first two years	Water upstream of the immediate surroundings of the site to be remediated	Temperature pH Conductivity Dissolved oxygen Redox potential (Eh) Nitrites COD Ammonia Mercury
		Water downstream of the immediate surroundings of the site to be remediated	
	Six-monthly, remaining years	Water upstream of the area near the site to be remediated	Temperature pH Conductivity Heavy metals: mercury.
		Water downstream of the area near the site to be remediated	Temperature pH Conductivity Heavy metals: mercury
	Annual	Water upstream of an area further from the site to be remediated	Temperature pH Conductivity Mercury
		Water downstream of an area further from the site to be remediated	
Groundwater	Monthly, first 2 years	Drilling around the site to be remediated	Mercury
	Six-monthly, remaining years	Drilling around the site to be remediated	Mercury
	Annual	Wells and springs around the site to be remediated	pH, conductivity, HCO ₃ ⁻ , SO ₄ ²⁻ , Cl ⁻ , Ca ²⁺ , Mg ²⁺ , Na ⁺ , NO ₃ ⁻ , NO ₂ ⁻ , NH ₄ ⁺ , Mercury
Monitoring of meteorological data	Monthly	Site and surroundings	Direction, speed and frequency of prevailing wind
Monitoring of the mercury level in air	Monthly, first 2 years Quarterly remaining years	Site and surroundings	Level of mercury in the air
Monitoring of the mercury level in suspended matter	Monthly, first 2 years Quarterly remaining years	Site and surroundings	Level of mercury in particles in suspension

APPENDIX 1 : CASE STUDIES

1. Reconditioning of the Almadén mines.
2. Decontamination of the Flix dam in the Ebro River.
3. Environmentally safe decommission of a mercury cell chlor-alkali plant
4. Stabilization of soils contaminated with heavy metals using low-grade magnesium oxide

LEGAL DISCLAIMER: These case studies are a non-exhaustive compilation of recent projects undertaken for mercury decontamination, and provided only for informative purposes, without implying necessarily neither a certification nor an approval by UNEP/MAP of all the procedures employed in each of the sites and of the levels of contamination that may remain in them.

CASE STUDY 1: RECONDITIONING OF THE “CERCO DE SAN TEODORO” SLAG HEAP. MINAS DE ALMADÉN (CIUDAD REAL, SPAIN).

Background

Minas de Almadén y Arrayanes, S.A. (MAYASA) is a public company belonging to Sociedad Estatal de Participaciones Industriales (SEPI), which manages the mercury mines in Almadén (Ciudad Real).

Mining began in Almadén over 2,000 years ago, with production accounting for a third of historical world production.

The Almadén mining and metallurgy complex is found in the areas known as “Cerro de San Teodoro”, near the urban area and the road to Córdoba. The site includes historic mines and those in operation until July 2003.

Minas de Almadén undertook in 2005 the most important environmental project in its history: the reconditioning of the “Cerro de San Teodoro” slag heap.



CERCO SAN TEODORO SLAG HEAP. MAY 2005. Photo by Paisajes Españoles

For centuries the “Cerro de San Teodoro” slag heap has been the dump site for both sterile tailings from mining operations and slag from metallurgy processes, reaching 3.5 million tonnes and covering an area of 10 hectares.

ACTION

In deciding which rehabilitation model to follow, a number of studies were made of the slag heap and the surrounding area. A summary of these studies concluded that the **materials dumped on the slag heap are hazardous due to their mercury content** and that the permeability of the underlying substrate is low, with no discernible lithological changes or fractures that may constitute preferential drainage paths.

Bearing these considerations in mind it was decided to undertake ***reconditioning of the slag heap with in-situ encapsulation to guarantee waterproofing of the upper part of the heap, preventing refilling and therefore minimizing the effects on groundwater and surface water, as well as reducing dispersion of the material dumped on the heap that may affect the surrounding soils.***

The reconditioning of the Cerco de San Teodoro slag heap was undertaken from 2005 to 2008 and cost close to 9 million euros.

In addition to the aforementioned environmental tasks, the reconditioning of the Cerco de San Teodoro slag heap has turned the mining and metallurgy complex into a social and cultural space open to the public: the Almadén Mining Park (www.parqueminerodealmaden.es).

METHODOLOGY USED

The slag heap lies within the easternmost part of the urban area and is a topographic high compared to the surrounding relief; the foot is well defined, limited to the south by the Córdoba road, to the west by other property, and to the north by the path to the Virgen del Castillo.

The materials are piled in a slag heap outside the Cerco de San Teodoro that extends south-east and north-west, surrounding the mining site, and in a second heap inside the Cerco in the south-westernmost area.

The studies characterizing the slag heap and surrounding area yielded the following data:

COMPONENT MATERIALS

- Old metallurgy waste
- Current metallurgy waste
- Mining waste
- Other

ENVIRONMENTAL EFFECTS

- Hydrological risk
- Atmospheric risk
- Land use
- Effects on plant and animal life, geophysical processes–morphology and landscape-, and infiltration

The following action plan was drawn up to meet the established objectives:

A) slag heap conformation

The aim of this stage was the remodeling of the slag heap to improve stability and integrate it into the surrounding area. To do so, material was moved from one part of the heap to another to reduce the slope of the sides, enabling the subsequent laying of a geosynthetic pack to seal the heap.



REMODELLING OF THE CERCO DE SAN TEODORO SLAG HEAP MARCH 2006. Photo by Paisajes Españoles

B) sealing of the slag heap

The aim was to stop water entering the heap, and thus prevent the formation of leachates, the dispersion of materials through physical and thermal insulation and prevent mercury evaporation over the entire surface of the heap. A geosynthetic pack made up of 5 layers was installed.

The seal package comprises: a geotextile layer, a bentonite blanket layer, a layer of high-density polyethylene, another of drainage geocomposite, and finally a layer of reinforcement geogrid, or geocells, depending on the steepness of the sides after remodeling.



CERCO DE SAN TEODORO SLAG HEAP MARCH 2007

The geosynthetics have different functions:

- GEOTEXTILE: The geotextile layer prevents piercing.
- BENTONITE BLANKET: This waterproofs the surface, reducing leachate formation and gas migration.
- HIGH-DENSITY POLYETHYLENE: The main component of the geosynthetic pack, as it guarantees that sealed area is totally impermeable.
- DRAINAGE GEOCOMPOSITE: This conveys water, separating and filtering the soil on which the geocomposite is laid.
- FLEXIBLE REINFORCEMENT GEOGIRD 80 kN/m: Installing this layer improves the stability of the earth on the surface of most the slopes on the heap.
- GEOCELLS: Drainage geocells are made of strips of high-density polyethylene, laid to stabilise the earth on the steepest slope.

The diagrams below show the distribution of the geosynthetic pack, according to slope.

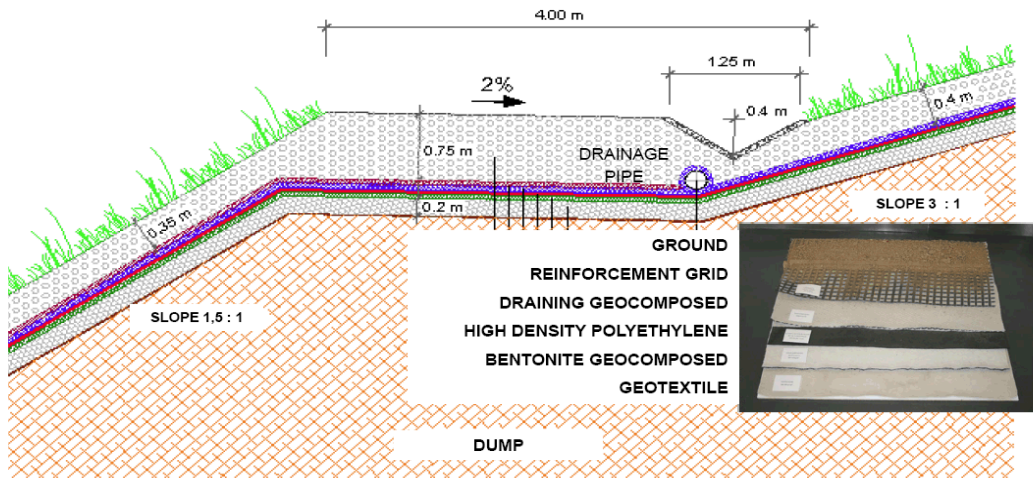

SEALING SURFACE SCHEME
LOW INCLINATION SLOPE

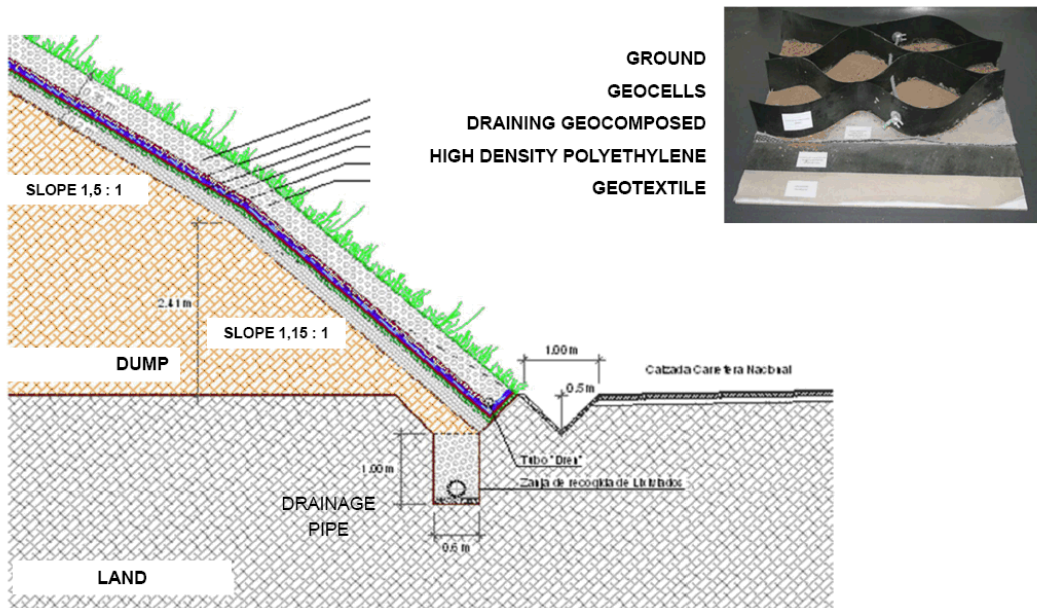

SEALING SURFACE SCHEME
HIGH INCLINATION SLOPE

C) installation of a water collection, circulation and discharge system

This stage of the remediation aims to prevent erosion that may affect the stability of the slag heap. A water collection, circulation and discharge system was installed, through the construction of ditches, drainpipes and perimeter channels that collect runoff and prevent future erosion, which would affect the stability of the slopes.

D) restoration of plant cover

This action aims to recover plant life on the restored surface and integrate the slag heap into its surroundings. To do this, 50 cm of earth was added to the whole surface, a total of 180,000 m³, followed by the mechanical hydroseeding of a 16-ha area to aid the regeneration of plant cover.



CERCO SAN TEODORO SLAG HEAP JANUARY 2008. Photo by Paisajes Españoles

EVALUATION OF RESULTS AND CONCLUSIONS

Since the reconditioning work was completed in 2008, the most obvious results observed have been:

- Integration of the slag heap into the landscape.
- Elimination of waste dispersal in the immediate area.
- Acceptable levels of mercury evaporation into the atmosphere.
- Leachate formation is almost zero, with no addition to nearby streams or groundwater.

Quality control during the course of the works, along with the significant environmental aspects identified for the project, was undertaken according to the Environmental Monitoring Plan (EMP) designed for the reconditioning project.

Currently, the post-completion monitoring established in the EMP continues. To date, the most reliable result observed is the drop in mercury levels in the air, as can be seen in the figures below from the study of air emissions undertaken during and after the reconditioning works.



RESTORATION OF THE WASTE HEAP IN THE SAN TEODORO ENCLOSURE

The first results:

Emission to the atmosphere

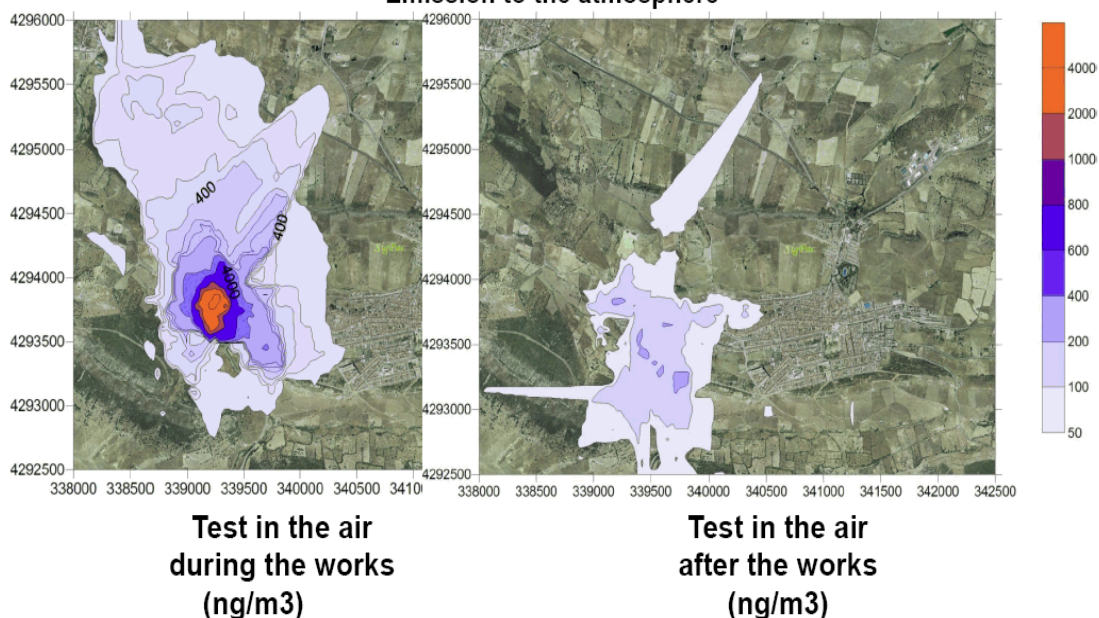

Source: Dr Pablo Higuera (UCLM)

In regard to water quality, although in some surface waters a notable improvement was observed, some more time is needed before more significant results are obtained.

The development of the analytical data on these waters can be followed on the website of the “Centro Tecnológico Nacional para la Descontaminación de Mercurio (CTNDM): <http://www.ctndm.es/proyectos/1-in.php> where the data obtained is dumped monthly under the reconditioning Environmental Monitoring Plan, which includes the gathering of monthly samples at a number of points in surface and groundwater around the slag heap.

CASE STUDY 2: DECONTAMINATION OF THE FLIX DAM IN THE EBRO RIVER (Tarragona, Spain)

Authors: Marc Pujols, Project Manager, and Gracia Ballesteros, Deputy Director of Engineering and Construction. **ACUAMED.**

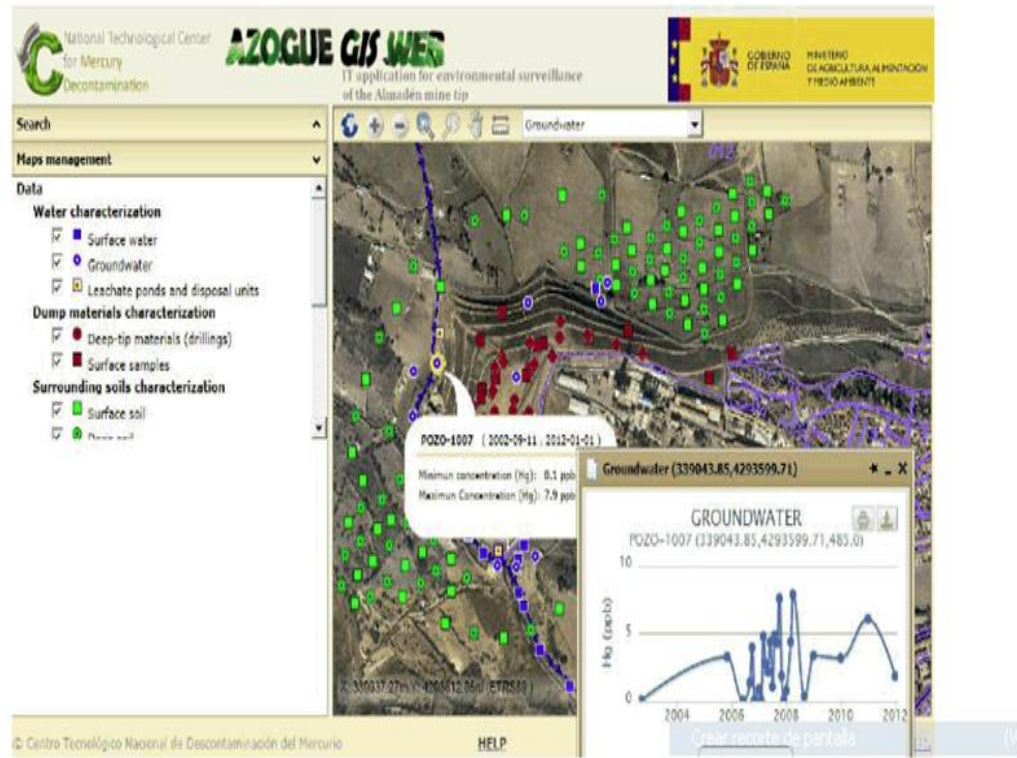

Software application for the environmental monitoring of the Almadén mine slag heap

<http://www.ctndm.es/proyectos/1-in.php>

SUMMARY

The Flix dam, located in the lower stretch of the Ebro, retains in its basin some six hundred thousands cubic meters of sludge mainly dumped by a chemical plant located on the right bank. This sludge was the residual product of the plant's operations, and is composed of both chemicals and inert components. There are three main groups of contaminants: organochlorines (with persistent organic pollutants such as DDT and PCBs), heavy metals (mainly mercury) and radionuclides.

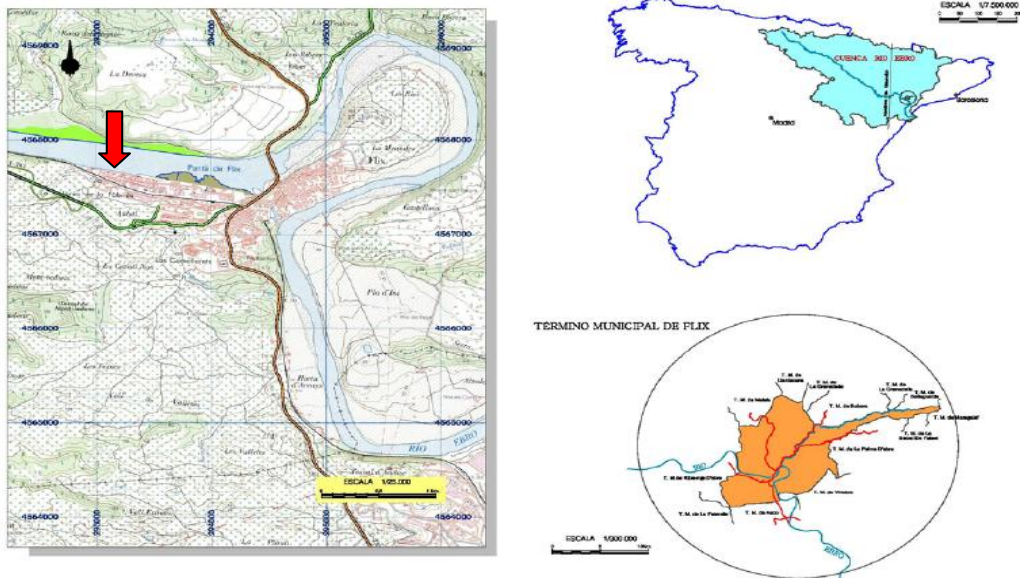

Location of the polluted site in the riverside of the Ebro

The concentration of the contaminants in the mud is relatively high, and they can be potentially mobilized; in fact, such transmission has actually occurred—as shown in the register of specific episodes in which the limits of tolerance of aggressive components contained in the ecosystem have been exceeded.

In light of this situation, the Spanish Ministry of Environment decided to start a process of designing, analysing, developing, comparing and finally choosing the means by which to correct and prevent, or mitigate, the transmission of these toxic elements into the environment.

As a result, the state company Aguas de las Cuencas Mediterraneas, S. A. (ACUAMED) was entrusted with the project of the elimination of the chemical pollution of the reservoir at Flix.

BACKGROUND

The accumulation of historical dumping can lead to situations that make the ecosystems vulnerable due to natural phenomena - floods, winds or sudden temperature changes. Just such a scenario is the situation in the Flix reservoir.

The production of chemical products on the banks of the river began in the late nineteenth century, and since then, the kind of substances produced have been large and varied, in accordance with technological advances and demand.

The initial processes were based on chlorine and caustic soda, obtained from the raw material of common salt, through an electrolytic process using mercury. More recently, apatite has been introduced in huge amounts as raw material in order to produce di-calcium phosphate. This apatite naturally contains a percentage of radionuclides, which, during the production process, are physically dumped. In addition to this, also to be considered is the fact that some of the contaminants found in the mud also come from the natural drag occurring upstream of the factory.

In addition, the River Ebro's morphology has substantially changed over the past century. Every time that a dam is built on the river, the immediate consequence is that the pool produced in the water increases sedimentation, and therefore reservoirs have a propensity for clogging. The Flix reservoir is no exception. The erosive force and natural drag of the River Ebro as it passed through this area was reduced following construction of the dam. Until then, most of what was dumped from the factory had been washed away downstream, but after construction of the dam, the vast majority of the dumped materials remained in the reservoir basin.

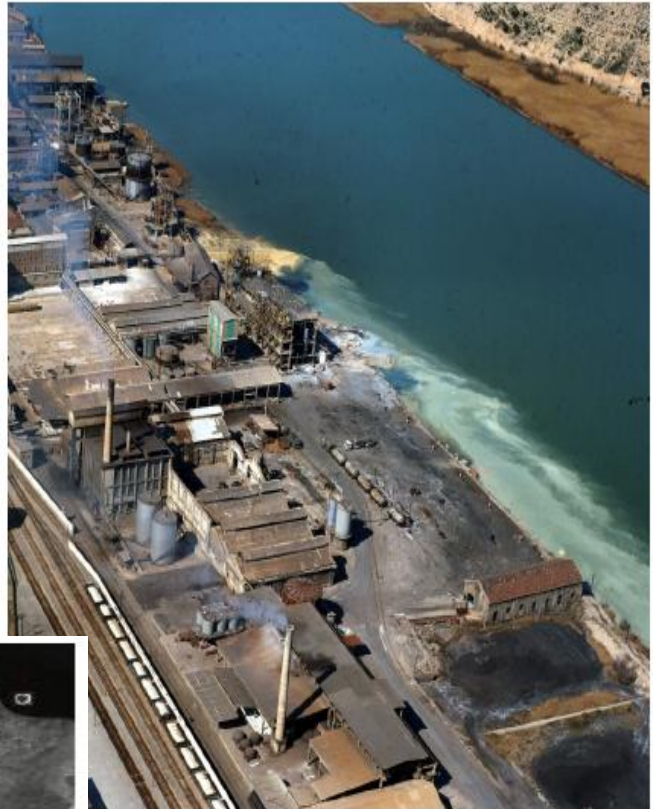

Aerial view, 1970

In light of all of this preliminary data, a search for solutions has been undertaken, in order to avoid either continuous or periodic risk of contamination.

WASTE GENERATING PROCESSES

The materials that make up the bank of the reservoir beside the factory mostly come from factory activity. The processes that produced or caused the majority of the materials deposited or that have settled in the bank are:

- a) **Combustion of coal.**
- b) **Dissolution of salt.**
- c) **Trichloroethylene.**



Aerial view, 1985

- d) **Perchloroethylene and carbon tetrachloride.**
- e) **Dicalcium phosphate.**

POTENTIALLY POLLUTING PROCESSES

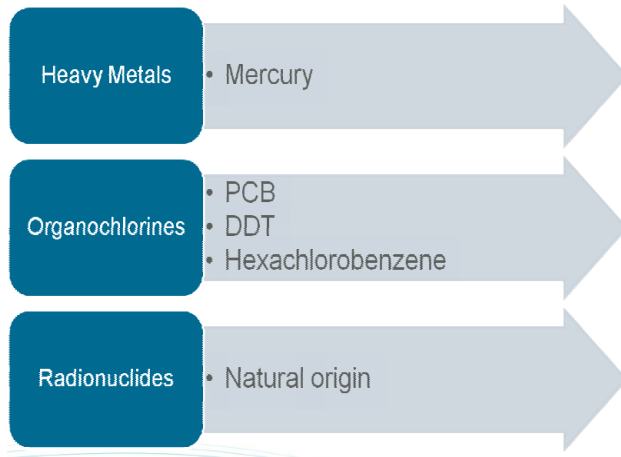

As previously mentioned, the contaminants belong to three main groups: heavy metals (mainly mercury), organochlorines and radionuclides (from the mineral used in the phosphate process).

Given the variety of processes carried out at the factory, in addition to those already mentioned, there may be others arising from chlorination processes, like DDT (1945-1975), PCBs (1959-1987), Hexachlorobenzene, and diverse reaction by-products.

SOLUTIONS CONSIDERED

Studies carried out have established that possible solutions can be classified into two groups depending on whether the waste is finally kept in the reservoir (in-situ solutions) or, conversely, collected and placed at another point (ex-situ solutions).

The key elements that define the optimal solution within each group are:

- In-situ solution: the creation of a working area, making up of waste, waste treatment and protection from river erosion.
- Ex-situ solution: creating a working site, removal of waste, treatment, transport to a dumping area and the dumping area itself.

ADOPTED RESOLUTION

The Monitoring Commission formed by various government bodies, including the Hydrographic Confederation of the Ebro, the Spanish Ministry of the Environment, the Government of Catalonia, the Flix municipality, the Spanish National Research Council, the Consortium for the Protection of the Ebro Delta (CEPIDE) and the project promoter (ACUAMED), after studying all the responses received from more than 80 organizations consulted to study the alternatives, including that of 'no action', decided that the ex-situ solution was the most environmentally safe alternative, since it actually

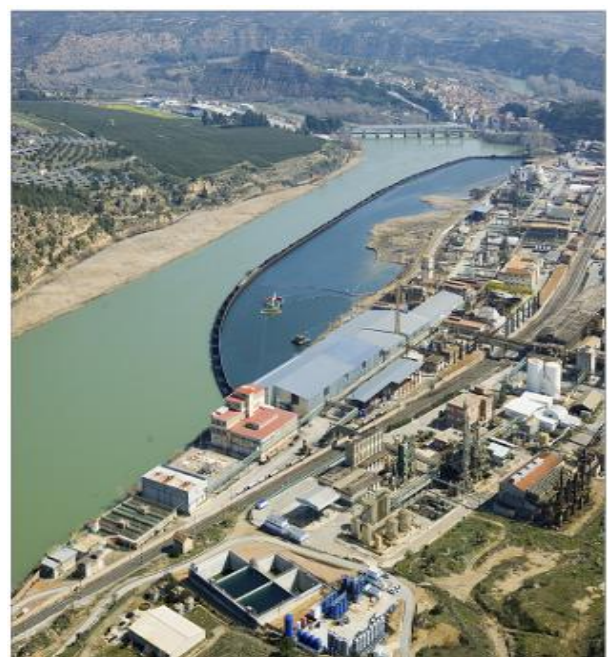

View of the site with the on-going decontamination works (2012)

reduced the level of pollutants and provided more guarantees.²³

When designing and planning activities, a series of corrective measures to minimize the impact on wildlife were considered, because a nature reserve was located upstream nearby, with flooded grasslands and wildlife as diverse as the golden eagle, imperial heron and the otter.

PRELIMINARY WORKS

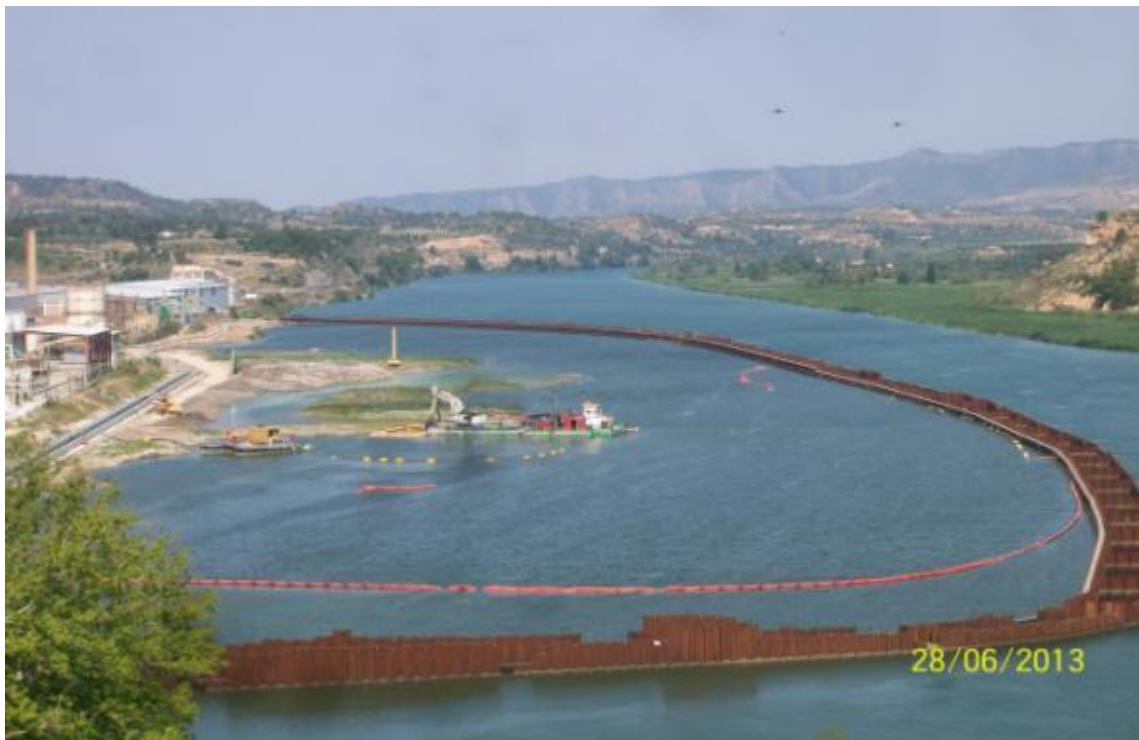

Dredging activities inside the sheet piling

- Construction of a **double wall of sheet piling 1300 m in length**, enclosing a working area on the right bank of the reservoir to isolate the contaminated river sludge, which must be executed prior to manipulation of the significantly contaminated mud. The main aim is to create a protected area (still water), independent from the Ebro's flowing water, so that during the performance (during the works inside the reservoir) the river can flow through a channel at the left bank of the reservoir. Should an incident occur during the process, the working area will remain confined and pollution won't be sent downstream.

²³ BOE (Spanish Official Gazette), RESOLUTION of 25 October 2006, of the General Secretariat for Pollution Prevention and Climate Change, formulating an environmental impact statement on the assessment of the project Removal of Chemical Pollution from Flix Reservoir (Tarragona).

- Construction of a **secant pile retaining wall 1100 m in length** on the shoreline of the right bank of the reservoir, to avoid the risk of landslip of the bank due to the removal of the waste, while preventing subsurface flow from the factory into the river.
- Construction of an **interceptor sewer for the existing waste drains** at the factory.
- Construction, within the factory compound, of **various industrial buildings to house the treatment facility for the extracted material and water**, as well as the collection centres.
- Construction of **seven wells for the supply of water to the towns situated downstream**. Its use is exclusively reserved in case of emergency.
- **Adequacy and waterproofing of a Class II landfill** (type of landfill engineered for wastes that are neither toxic nor inert) in el “Racó de la Pubilla” (at a distance of 6 kilometers away from the river), following demanding criteria above and beyond that required by current legislation.



Conditioning works in the “Racó de la Pubilla” Landfill



DEPOLLUTION WORKS

One of the wells constructed for drinking water supply to downstream towns in case of emergency

After building the site, the removal of waste can proceed. The removal of the submerged fraction of mud will be done using suction ecological dredges, which will work surrounded by floating plastic curtains. This will minimize the disturbance of contaminants and will create a depression in the dredge area, where the water will be easily kept. This is complemented by the provision of a small pump that can operate when the dredger stops. To prevent the disturbance of contaminants, the dredging should be necessarily low.

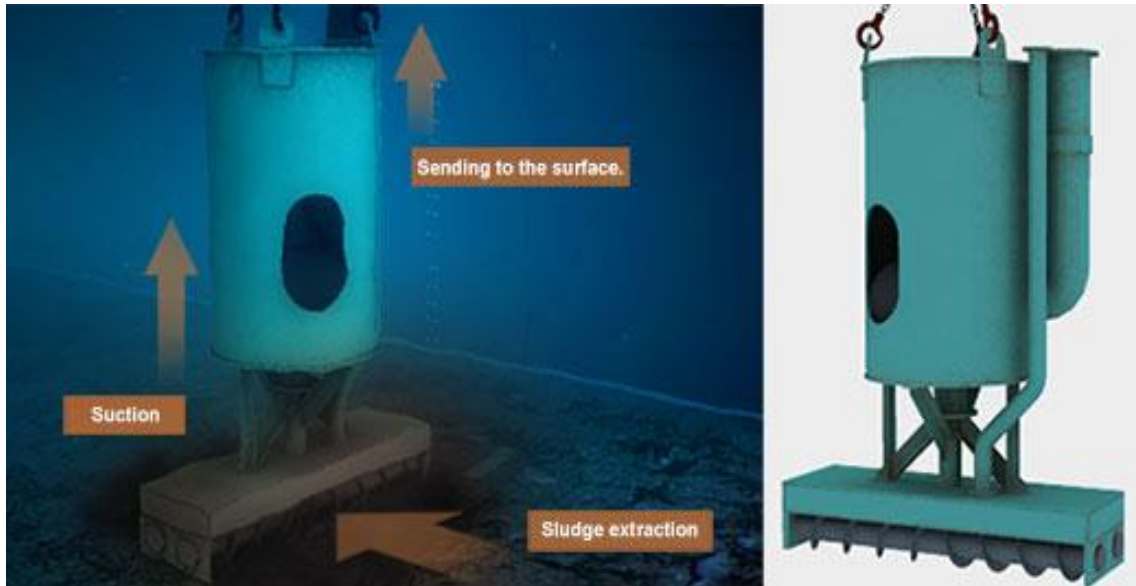

Once removed, the material must be subjected to a treatment, the aim of which is to achieve waste conditions that enable it to be admitted for final containment in the dumping area provided.

The treatment consists of:

- **Soil size classification**, using sieves and hydrocyclones, followed by the **drying** of all the extracted material, with settling tanks and press filters.
- The solid fraction will be classified depending on its contaminant concentrations, sending clean fractions directly to the filling area, and dealing specifically with those fractions that would be rejected at the dumping area. After studying all the possibilities, the chosen treatments (alternative or sequentially) are:
 - **Thermal desorption** (vs. organic compounds): The material is introduced into the desorption oven at less than 350°C to avoid evaporating the mercury. The gases coming from the desorption oven pass to a thermal oxidation oven where they are heated again, this time to 1100°C. After this, the temperature is cooled quickly to less than 200°C to prevent the formation of dioxins. The resulting gas from the thermal oxidation oven passes through a fabric filter to collect the particles in suspension.

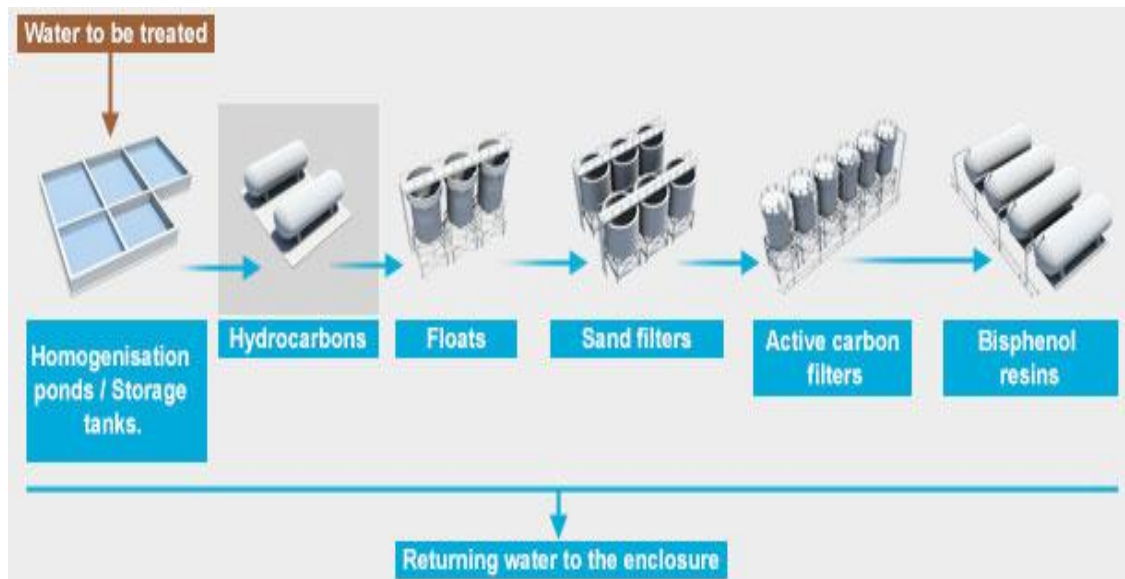

Oxidation: I

- the principal contaminants from the dehydrated sludge are volatile compounds in moderate concentrations, it is oxidized in the mixing tank by the addition of reagent and water. After mixing, the material passes to the reaction tanks. Two hours later, the result is an inert compound that is insoluble in water and ready to be taken to the landfill site.
 - **Stabilization** (vs. heavy metals): If the dredged sludge has high concentrations of mercury and other heavy metals, it is processed in the stabilization plant. Passing through some hoppers, the sludge is inertized with cement and specific additives to stabilize the mercury and prevent its presence in the possible leaching of the sludge.
- **Water** is sent to a **treatment plant** (WWTP), the capacity of which is around one hundred litres per second.

The diagram below highlights the crucial importance of the contamination controls at the end of each process, before approving the continuation in the chain of decontamination. Strict security guidelines are also followed during the handling of materials, to prevent any impact on people or the environment.

After the treatment, the material will be transported by trucks to the “Racó de la Pubilla” class II landfill (type of landfill designed for residues that are neither toxics nor inerts.)

DISMANTLING WORKS

The works are due to be finished by the end of 2015, and it will imply the following actions:

- Closure of the landfill site.
- Dismantling of the sheet pile wall.
- Dismantling of the surface water inceptors and repositioning of the landfill to the reservoir for the rainwater drains.
- Removal of the mobile and mechanical elements from the treatment plant.
- Dismantling of the plant building and fixed elements contained within.

- Reinforcement via coarse rubble slope against the pile wall along the full extension of where the extraction of material has taken place next to the secant pile protection wall.

SECURITY MEASURES

As already pointed out, the security measures include the floating plastic curtains and the double wall of sheet piling, as well as an intensive daily quality control of the water, upstream and downstream, both outside and inside the enclosure area.

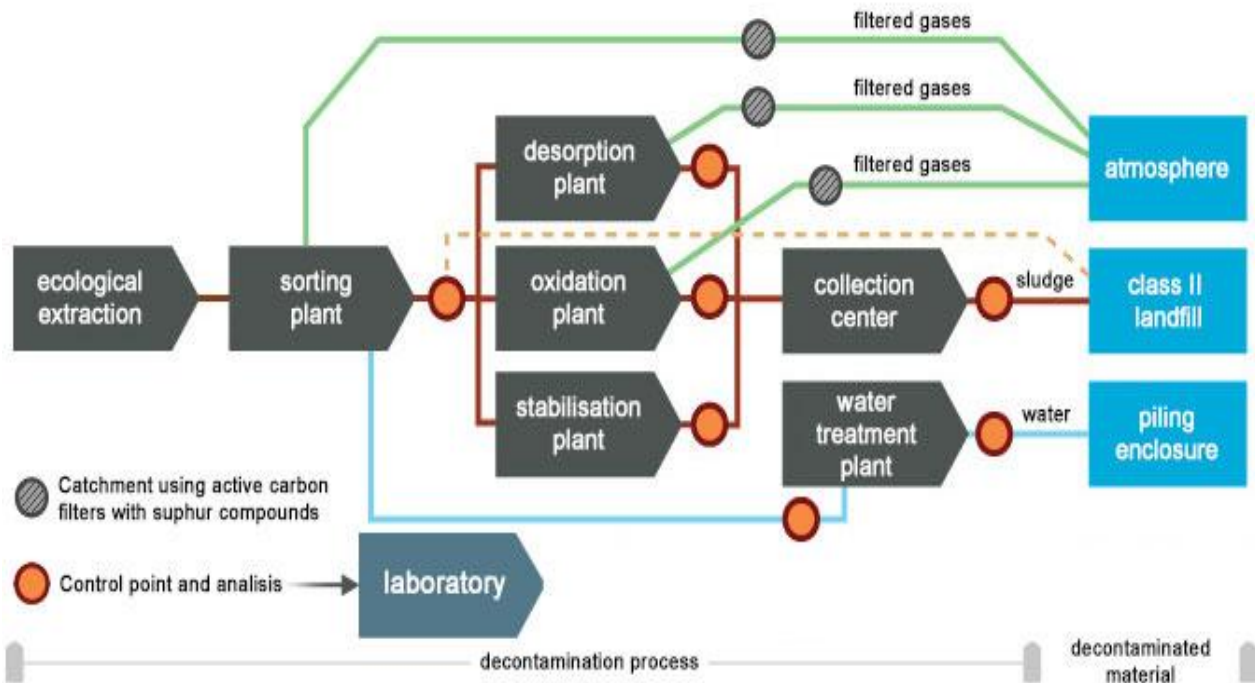

Daily water quality control points

These tests, as well as the analysis of the dredged material, are carried out in the 'on site' laboratory, which includes the following equipment:

- Gas chromatography coupled with mass spectroscopy.
- Ion chromatography with conductivity detection.
- Atomic fluorescence.
- Visible and ultraviolet molecular absorption spectrophotometry.
- Plasma induced spectroscopy emission.
- Selective electrode system.
- Alpha radiation meters with zinc sulphur detectors.
- Beta radiation meter using a detector proportional to the gas flow.
- Gamma radiation meters using sodium iodide and germanium detector.



"On site" Laboratory

INFORMATION TO THE PUBLIC

A website has been devoted to inform the public with the details and news of the project.



www.decontaminationflix.com/

COST OF THE PROJECT

The total cost estimated is around 192 M€, of which 70% is co-financed by European Union funding, with the following breakdown of major items:

Treatment plant	50 M€
Conditioning of dumping area	38 M€
Sheet pile wall	21 M€
Pile wall	15 M€
Dredging	12 M€
Other	56 M€
Total	192 M€

CASE STUDY 3: ENVIRONMENTALLY SAFE DECOMMISSIONING OF A MERCURY CELL (CHLOR-ALKALI PLANT)

Author: Antonio Caprino. Electrolysis Production Manager. SOLVAY IBERICA, MARTORELL.

The decommissioning of a mercury-cell (chlor-alkali plant) is potentially one of the processes most likely to involve major release of mercury into the environment. It involves a series of steps that require thorough and carefully planning. The amount and composition of the waste generated may vary greatly, from protective equipment of workers like gloves to slag, production equipment, containers, rubble....

Below are the steps to be followed in the decommissioning of a mercury-cell, with special emphasis on the precautions to be taken to ensure human health and safety and to prevent environmental contamination, based on Euro Chlor documentation on decommissioning and on Solvay's experience in this field.

1. Introduction

In the 20th century, mercury electrolysis was commonly used in chlorine production worldwide; however, the use of mercury and the advent of new technologies mean that this technique is now largely obsolete. Indeed, no electrolysis plant using this technique has been built since the 1960s.

Given the challenge facing the sector in regard to the change in technology, Euro Chlor (an organisation that groups together most European chlorine manufacturers) undertook voluntarily to cease mercury-based chlorine production in Europe by 2020. In the Mediterranean Region no mercury-based plants shall remain in operation by 2020²⁴.

At global level a similar process is being followed: in 2002 there were 92 mercury-based plants, while by 2011 only 53 remained. UNEP reached an agreement in 2013 (Minamata Convention on Mercury), under which mercury-cell chlor-alkali plants will cease to operate between 2025 and 2035 in those countries that ratify the Convention.

Given this situation, it seems appropriate to compile a document of good practices to be followed during the decommissioning of such plants.

²⁴ Legal requirement of the Regional Plan of the Barcelona Convention for the reduction of inputs of Mercury. UNEP MAP, 2012.

2. The case of Solvay

Solvay is a world leading producer of chlorine with 13 plants producing over 2 Mt of chlorine a year. Four of these plants still use mercury cell technology. Between 2006 and 2011 there were 3 conversions made from Hg to membrane cells:

2006 in Rosignano, Italy

2007 in Bussi, Italy

2009 in Santo André, Brazil

Two changeovers will be completed in 2013: Lillo (Belgium), and Tavaux (France).

Based on these experiences, an explanation is given of how the decommissioning of a mercury cell plant is managed during the technology change process. The reference documents will be cited, along with the team in charge of the process and a breakdown of the operations to be carried out at local level, all based on the latest cases at Rosignano and Santo André. Finally, the main lessons learned from these processes are summarised in a list of good practices to be considered.

2.1 Managing the decommissioning process

2.1.1 Reference documents

- Euro Chlor Env Prot 3, *Guidelines for Decommissioning of Mercury Chlor-Alkali Plants*.
- Euro Chlor Env Prot 19, *Guidelines for the preparation for permanent storage of metallic mercury above ground or in underground mines*.
- Local documents such as: SHD (Syndicat des Halogènes et Dérivés) France - '**Protocol for decommissioning of a mercury cathode electrolysis unit**' ,
- Company's own documents (Internal procedures, Schedules, action plans...)

2.1.2 Organisation

In order to undertake the required decommissioning processes it was decided to put together a team to define how these processes should be managed at the various Group plants.

The team was made up of process experts and SHE (Safety, Health and Environment) experts who defined the process and its scope, and created a technical database on the mercury-contaminated equipment and the recommended treatment.

The team also included experts in procurement to ensure good economic management during the investment period.

2.1.3 Phases of the operating process

2.1.3.1 Phase 1: preparation and planning

An estimate must be made of the contaminated waste to be treated, including the anticipated amount and concentration of mercury.

Likewise, it must be decided which equipment is to continue to operate during the decommissioning process to prevent workers from being exposed to mercury and contamination of the environment. This is normally gas scrubbing and wastewater treatment installations.

Based on experience, the amount of contaminated material to be treated varies between 1000 and 6000 t per plant (excluding buildings), a non-comprehensive list is given below by way of example:

- Carbon steel and other metals such as copper and aluminum
- Mercury
- Graphite and activated carbon
- Polyester reinforced and non-reinforced PVC, polyester resins, other plastics
- Coverings, e.g. ebonite, neoprene and butyl
- Joints made from diverse materials
- Sand and clay
- Electrical equipment
- Concrete, brick, rubble
- others

This list is used to define the treatment of each type of waste or whether it is to be sent to landfill. The treatment of each waste type is decided according to the description in the database prepared by the central team and the stipulations of each country's legislation.

One important point to be borne in mind is that, at the beginning of the process, suitable metal containers must be made available to store the metallic mercury from the electrolyzers temporarily.

Next, a call for bids can be made amongst contractors and a detailed plan of the process drawn up. This plan should include informing the authorities that all aspects of waste have been considered, including treatment, environmental control during the decommissioning process and all those concerning the protection of the personnel involved.

Finally, the number of workers required must be defined, both on the pay roll and freelancers, protective equipment, biomonitoring and environmental control.

2.1.3.2 Phase 2: Operations

This in turn is divided into three stages.

Stage one, called 'Basic Health and Safety Provisions' comprises the following operations:

- Emptying installations containing metallic Hg and process fluids.
- Thorough cleaning and confinement of the various contaminated cells, and, if necessary, covering them with water, to prevent emissions of Hg into the atmosphere.
- Dismantling of uncontaminated equipment (e.g. anodes, cell panels, etc.).

Such work must be undertaken by qualified personnel, usually the same involved when the plant was in operation.

In **stage two** the mercury-contaminated equipment is dismantled and undergoes appropriate treatment according to the establish plan. Only the equipment that must remain operable for reasons of SHE is not dismantled. This work can be undertaken by contractors if there is not enough permanent staff.

Finally, in **stage three**, the remaining equipment is dismantled (e.g. control gear, treatment units, etc.). This work is mostly done by contractors.

3. Case study photos

Below are some case study photos that illustrate the steps described.





Cell confinement (connected to the air treatment unit)

Working area for safe handling of contaminated equipment connected to the Hg effluent treatment unit, regularly washed down with water



Floor of cell room regularly washed down



First stage of operations



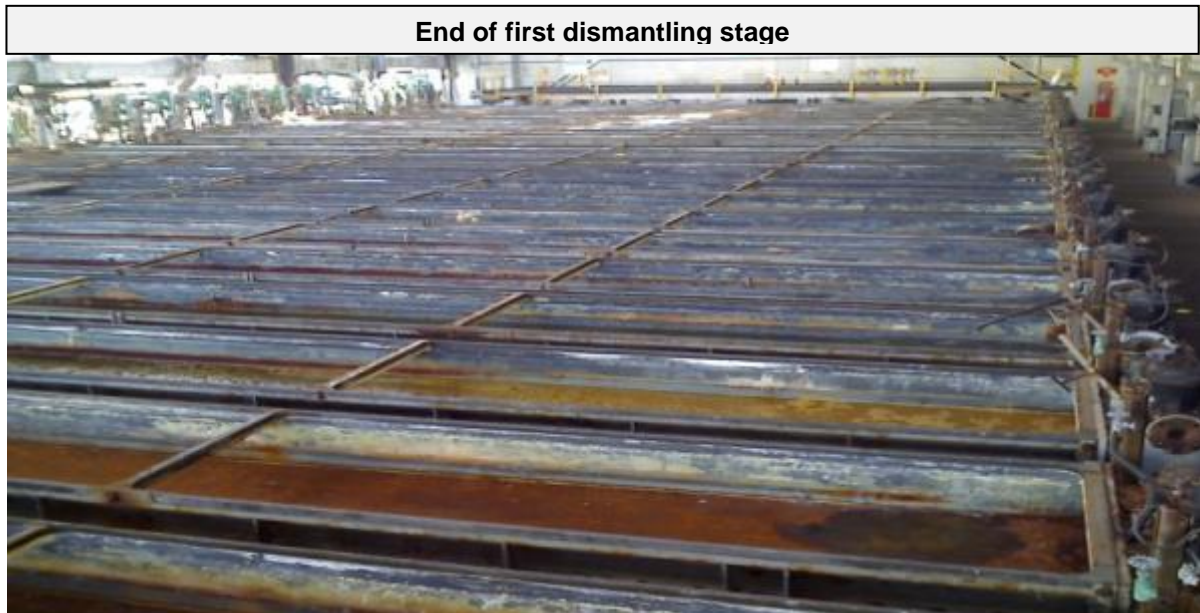

4. Good practices learned

The decommissioning of a mercury-cell chlor-alkali plant must be managed as a specific project:

1. By a full-time team, enthusiastic and committed to the project, able to come up with innovative solutions that improve on current procedures. Personnel must be qualified and experienced, particularly those in charge of emptying circuits and dismantling contaminated cells in stage one.
2. The project must be carefully planned following available documentation and according to the specificities of each plant.
3. A number of things must be defined in the initial phase:
 - a. How to shut down the cell room (all at once or in sections)
 - b. Which cells should remain operative for SHE reasons.
 - c. Listing contaminated cells and waste types with the corresponding treatment, which will serve when informing the authorities and drawing up requests for bids from contractors.
4. The protection of workers and the environment is a crucial aspect. Prior to the start of the work, the protective equipment to be used, the cells which are to remain operative to ensure minimum exposure, monitoring of the environment and water and biomonitoring must all be determined.
5. Finally, to ensure the success of the process, it is essential to implement progress indicators for the control and monitoring of the project.

5- Safe treatment of waste from the decommissioning of a chlor-alkali plant

The table below shows some recommended forms of treatment for waste containing mercury in the chlor-alkali industry, according to the BAT reference document.²⁵

Type of waste	Characteristic	Typical amounts (g/t Cl ₂)	Hg content before treatment (g/kg)	Treatment	Final Hg mercury (mg/kg)
Brine sludge	Inorganic waste	Up to 20 000, depending on the quality of the salt	<0.150	Landfill following stabilisation	
Sludge from effluent treatment	Activated carbon	50-400	10-50	Distillation/landfill following stabilisation	Hg recovered / <10 in waste
Carbon sludge from caustic filtration	Activated carbon	20-50	150-500	Distillation/landfill following stabilisation	Hg recovered / 20-200 in waste
Gas emission filters	Activated carbon	10-20	100-200	Chemical treatment Landfill following stabilisation	Hg recovered / 20-200 in waste
Sludge from storage tanks, sinks, etc.		May contain large quantities	High Hg content in general	Distillation	Hg recovered
Rubber coating	Variable		Variable	Acid bath, cryogenic and/or washing Incineration	300
Metal-coated materials	Surface contamination		In general, <0.1%	Heat, cutting and washing or cryogenic	
Steel and iron parts from building		Variable amounts	Inhomogeneous In general, <0.1%	Acid bath/sold as waste	<5-10
Concrete and other construction waste		Variable amounts	Inhomogeneous/ In general, <0.1%	Landfill as hazardous waste or other waste according to content	>10 /<10

²⁵ European Commission (2001): Integrated Pollution Prevention and Control (IPPC) - *Reference Document on Best Available Techniques in the Chlor-Alkali Manufacturing industry.*

The table below shows the typical waste materials generated following the decommissioning of a chlor-alkali plant and their possible treatments for mercury recovery ²⁶

<u>Typical material contamination</u>			<u>Possible treatment</u>			
Material	Typical percentage of Hg w/w	Physical state	Physical/mechanical treatment	Washing with water	Chemical washing	Retorting
Sludge from storage tanks and sinks	10 - 30	Wet solid				
Sludge from sedimentation tanks, drains, etc.	2 - 80	Wet solid				
Sulphurised or iodised charcoal from hydrogen purification	10 – 20	Dry solid				
Carbon from soda filters	Over 40	Wet solid				
Graphite from decomposers	2	Porous solid				
Rubber/packaging	Variable	Variable				
Brick/concrete	0.01 – 0.1	Dry solid				
Hg cell components (anodes, side walls, pipes...)	Variable	IC				
Steel (cells, decomposers, scrap metal, H ₂ condensers, pumps, pipes...)	0.001 – 1	SSC				
Plastic equipment	<0.1	SSC				
Copper conductors	0.04	SSC				(For flexible sheets)
Cell seal (concrete layers)	0.01					
Asphalt	1 - 20	IC				
Concrete and subsoil	Variable	IC				
Wood	Variable					
Floor	Variable	IC				
Thermal insulation	0.03		No treatment prior to dumping			
Retort waste	< 0.1 – 0.1	Porous dry solid				
Wooden floors	0.05 – 0.08	IC				

IC: Inhomogeneous contamination / SSC: Solid with surface contamination

²⁶ *Decommissioning of Mercury Chlor-Alkali Plants*. 5th Edition. September 2009, Euro Chlor

CASE STUDY 4: STABILIZATION OF SOILS CONTAMINATED WITH HEAVY METALS USING LOW-GRADE MAGNESIUM OXIDE

Author: José María Chimenos. University of Barcelona (UB)

The stabilization treatment with a pH-buffering chemical is an option to consider when the best alternative considered is to remove a contaminated soil with heavy metals from its emplacement, without a process of decontamination, and move it to a suitable landfill or safety cell.

This process of chemical stabilization minimizes heavy metals solubility. Lime or a mix of cement and lime are the usual buffering agent for many kinds of waste, but with the high pH values obtained with lime - a strong alkali - , the leachate water collected in the landfill may contain high concentrations of heavy metals, due to the redissolving of the previously formed metal hydroxides.

The most common heavy metal hydroxides reach their minimum solubility at a pH between 8 and 10. In the chemical stabilization of soils polluted with heavy metals it should be used an alkaline product with solubility equilibrium at that pH interval, and with a competitive price compared to lime.

Magnesium hydroxide, $Mg(OH)_2$, can be the most appropriate candidate, as it has minimum environmental impact, low solubility and pH equilibrium on contact with water close to 9.5. However, natural magnesium hydroxide (Brucite) is scarcely reactive, and the hydroxide on the market costs ten times the price of calcium oxide or hydroxide. More affordable is the low-grade magnesium oxide (MgO), which can be used as a stabilizing agent and is obtained from the calcination of the mineral Magnesite.

If mercury is present in the soil, it has to be carefully considered the possibility of formation of methylmercury, or its complexation with organic matter, such as humic acid. In this case, the stabilizing agent wouldn't be effective.

Here below is a description of some cases of stabilization of soils contaminated with heavy metals using low-grade MgO.

- 1- In 1998, Inabonos S.A. (a Roullier Group company) undertook the cleaning and decontamination of a 74,408m² plot in a former emplacement in Lodosa (Navarra, Spain), by moving contaminated soil to a safety cell, with the objective to build a new housing development. The process causing the contamination was the production of sulphuric acid from pyrite –iron sulfide-, a mineral with a high content of heavy metals. The waste generated in the process contained iron oxides and heavy metals such as lead, zinc, arsenic, copper, mercury, cobalt, cadmium, chrome, nickel, tin, selenium, tellurium, and antimony and could be found up to a depth of 2.5 meters. Mercury concentration reached a peak of 1.7 g/Kg in the first half meter of depth.

120,000 m³ of contaminated soil were extracted from the site, transported to a safety cell and stabilised. Stabilization was a gradual process, alternating layers of earth, approximately 0.5 m thick, with layers of hydrate - obtained from the calcination of natural magnesite and produced and marketed by the company Magnesitas Navarras S.A.-.This layer acted as a filter bed for the percolates from upper layers. The percentage of stabilizer added was about 5-6% by weight of the contaminated soil dumped in the safety cell. After dumping and stabilization, the safety cell was

closed. Thus, leachates collected in the troughs of the safety cell could be discharged into natural watercourses without undergoing prior treatment, except those effluents with a high sulphate content.

- 2- On a coastal city nearby Barcelona, the ex situ stabilization of 12.5 hectares containing ashes from pyrite roasting along with pyrite mineral with high sulphur concentration of a former inorganic fertiliser factory was undertaken using 10% low-grade magnesium oxide. The final objective of this treatment was to move the stabilized soil to a Class II controlled landfill.
- 3- On a Spanish coastal city, a pre-pilot study was undertaken of in-situ stabilization with magnesium oxide of soil contaminated by the uncontrolled dumping of a former fertiliser factory. The area treated covered 200 m² and was 2 m deep. The stabilizing agents were added by injection and the contaminated soil homogenized using a rotovator. The results obtained show that the leachates from the samples stabilized with low-grade magnesium oxide enable a pH of between 9.5 and 10.5 , which is the optimal interval to minimise the solubility of heavy metals.

Annex III, Appendix 5

Guidelines for environmentally sound management of used lead batteries

Note by the Secretariat:

These draft guidelines were prepared and delivered in the framework of the MedPartnership project and MAP PoW 2014-2015, with the technical support of the Basel Convention Regional Centre in Bratislava in 2014.

The present Guidelines was reviewed and agreed by the Regional Meeting of experts nominated by the Contracting Parties held from 18-19 March 2014, Bratislava, Slovak Republic, which agreed to their submission to the MED POL Focal Point meeting.

Table of contents

1.	Definitions	4
2.	Description of a lead battery	4
3.	Environmental and health aspects	6
4.	Sources of waste lead batteries, estimation of amounts of produced used lead batteries	7
5.	Overview of available standards, technical specification and guidelines on the storage and treatment of batteries and accumulators	10
5.1.	European Union Legislative Framework	10
5.2.	Best Available Techniques Reference Documents of the European Commission	11
5.3.	Basel Convention on the Control of Transboundary Movements of Hazardous Wastes and Their Disposal	14
5.4.	Guidelines on best available techniques and provisional guidance on best environmental practices of the Stockholm Convention	14
	General information on emissions from secondary lead smelters	14
	Emissions of PCDD/PCDF to air during the smelting process	15
6.	Collection, transport and storage of used lead batteries.....	15
6.1.	General occupational health and safety recommendations for workers during the waste management and treatment of used lead batteries	16
6.2.	Collection and sorting of used lead batteries	17
6.3.	Transport of used lead batteries	20
6.4.	Storage of used lead batteries.....	23
7.	Treatment of used lead batteries	27
8.	Recovery of used lead batteries.....	29
9.	Disposal of used lead batteries	41
9.1.	Landfills for hazardous wastes	42
9.2.	The underground long-term storage for hazardous wastes.....	46
9.3.	Accepting waste for disposal	46
10.	Transboundary movement of used lead batteries	47
10.1.	General requirements for “transport” / ADR	48
10.2.	Special care for batteries and accumulators with a liquid electrolyte	51
11.	Potential Sources of Environmental Contamination.....	51
11.1.	Battery Breaking Process	51
11.2.	Lead Reduction Process	52
11.3.	Lead Refining Process	53
11.4.	Bad examples of potential contamination of the environment	54
12.	Economic aspects of environmentally sound management of used lead batteries.....	55
13.	Conclusions and recommendations	56
14.	Literature.....	58

1 Definitions

Battery - any device that stores energy for later use; common use of the word, “battery”, however, is limited to an electrochemical device that converts chemical energy into electricity, by use of a galvanic cell.

Galvanic cell - a device consisting of two electrodes (an anode and a cathode) and an electrolyte solution; batteries may consist of one or more galvanic cells.

Lead battery - the electrical accumulator in which the active material of the positive plates is made up of lead compounds and that of the negative plates is essentially lead, the electrolyte being a dilute sulphuric acid solution.

Used lead battery - the battery which is no longer capable to be recharged or cannot retain its charge properly, its lifetime reaches its end and it becomes a waste.

Management of used lead batteries - the overall process of collection, transport, recovery and or disposal of used lead batteries, including the supervision of such operations

Separate collection - the gathering of used lead batteries, including the preliminary sorting and preliminary storage of used lead batteries for the purposes of transport to a treatment facility

Storage - placing of used lead batteries in the room of waste management or treatment facilities in sites with impermeable surfaces and suitable weatherproof covering or in suitable containers

Treatment of used lead batteries - means recovery or disposal operations with used lead batteries, including preparation prior to recovery or disposal

Recovery - means any operation the principal result of which used lead batteries serving a useful purpose by replacing other materials which would otherwise have been used to fulfil a particular function, or waste being prepared to fulfil that function, in the plant or in the wider economy

Recycling - means any recovery operation by which used lead batteries materials are reprocessed into products, materials or substances whether for the original or other purposes

Fractions of used lead batteries – material parts and pieces produced from treatment of used lead batteries and relevant by-products of used lead batteries

Disposal - means any operation which is not recovery even where the operation has as a secondary consequence the reclamation of substances or energy

2 Description of a lead battery

A battery mainly consists of electrodes (two plates, made from lead) placed in an electrolyte solution (sulphuric acid). The metal in the anode oxidises releasing negatively charged electrons and positively charged metal ions. The electrons travel from the anode to the cathode. The electrons combine with the material in the cathode through reduction and release a negatively charged metal – oxide ion. When the anode is fully oxidised or the cathode is fully reduced, the chemical reaction will stop and the battery is considered to be discharged. The schematic description of a lead battery is shown in Figure 1.

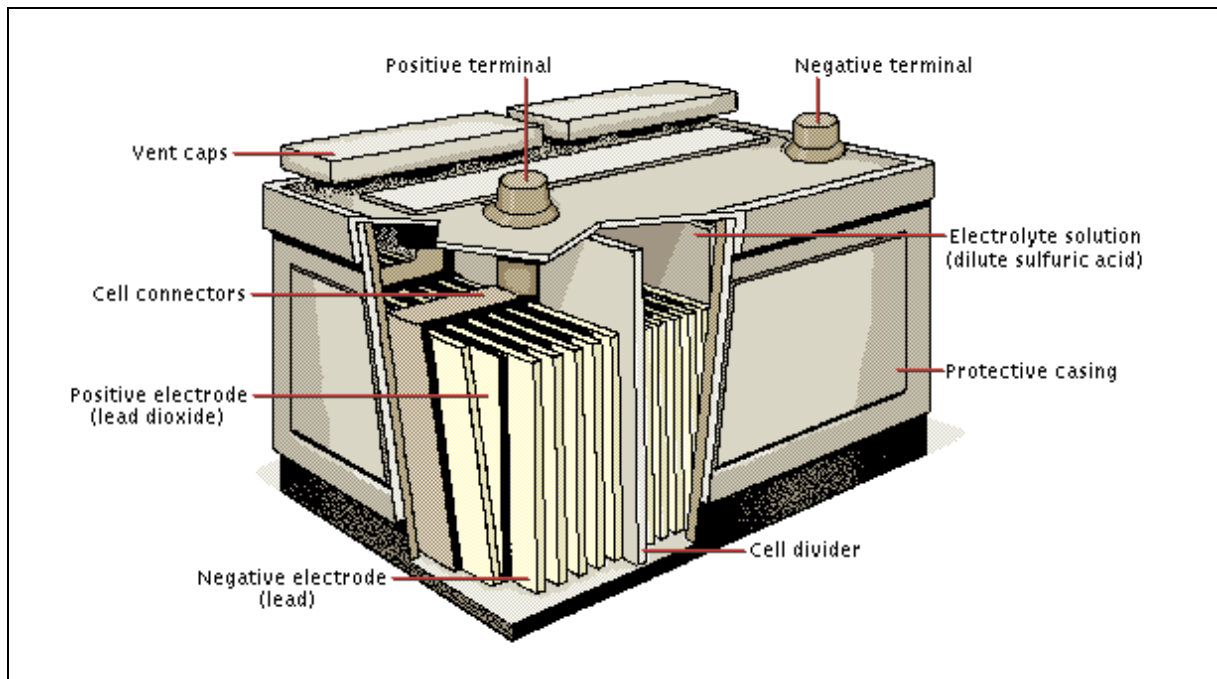

Fig. 1: Schemes of a lead battery and pictures with its labelling (Author: Neil McNiven)

Positive and negative terminals: made of lead, and where the external electricity consumer devices are connected;

Plugs: one for each battery element, where distilled/deionised water can be replaced whenever needed and also to provide an escape route for gases formed in the cells;

Connectors: made of lead, that makes electrical contact between plates of same polarity and also makes electrical contact between separated elements;

Cap and box: originally made of ebonite, but now more commonly made from either polypropylene or co-polymer;

Sulphuric acid solution: the electrolyte of the battery;

Element separators: usually a part of the box and made of the same material provide chemical and electrical isolation between the electrical elements. They are connected in a serial layout in order to increase the final voltage of the battery;

Plate separators: made of PVC or other porous materials, avoid physical contact between two contiguous plates but, at the same time, allowing free movement of ions in the electrolyte solution;

Negative plates: constituted by a metallic lead grid covered by a lead dioxide (PbO₂) paste;

Positive plates: constituted by metallic lead plates;

Battery element: a series of negative and positive plates placed consecutively and isolated between each other with plate separators. Plates of same polarity are electrically connected.

The battery plates are constituted by metallic lead structures, known as grids, covered by a lead dioxide paste, in the case of the negative plates, or by a porous metallic lead paste, in the case of the positive plates. The lead used in both the plates may also contain several other chemical elements such as antimony, arsenic, bismuth, cadmium, copper, calcium, silver, tin and sometimes other elements. The plates manufacture process also uses expander materials, such as barium sulphate, lampblack and lignin added in order to prevent the plate retraction during use. Once prepared, the plates are dried, cured and shaped ready to be assembled into the battery elements.

Automotive battery manufactures produce a full range of starter batteries for all types of vehicles using petrol and diesel engines. The characteristic of lead acid batteries are large weight, relatively short shelf life without recharge, and a good ability to deliver high currents. Lead batteries are very adapted for uses requiring (occasional) high current draw, and where charging is regular (i.e. automotive). The lead battery has high energy storage capacity and low cost.

3 Environmental and health aspects

Used batteries pose a threat to our environment and should be managed properly. The toxic materials present in the battery can cause harm to the environment and to human beings also. This is the reason why waste battery recycling should be done properly. The incorrect management of waste lead batteries cause danger to waters, soil and air, as well as to human health.

Batteries are safe, but precaution applies when touching damaged cells and when handling lead acid systems that have access to lead and sulphuric acid. Lead batteries are labelled as hazardous material.

Lead is a toxic metal that can enter the body by inhalation of lead dust or ingestion when touching the mouth with lead-contaminated hands. If leaked onto the ground, the acid and lead particulates contaminate the soil and become airborne when dry.

Exposure to lead causes a variety of health effects, and affects children in particular. Lead is a metal with no known biological benefit to humans. Too much lead can damage various systems of the body including the nervous and reproductive systems and the kidneys, and it can cause high blood pressure and anaemia.

There is no known safe blood lead concentration. But it is known that, as lead exposure increases, the range and severity of symptoms and effects also increases [3].

The sulphuric acid in a lead acid battery is highly corrosive and is potentially more harmful than acids used in other battery systems. Eye contact can cause permanent blindness; swallowing damages internal organs that can lead to death.

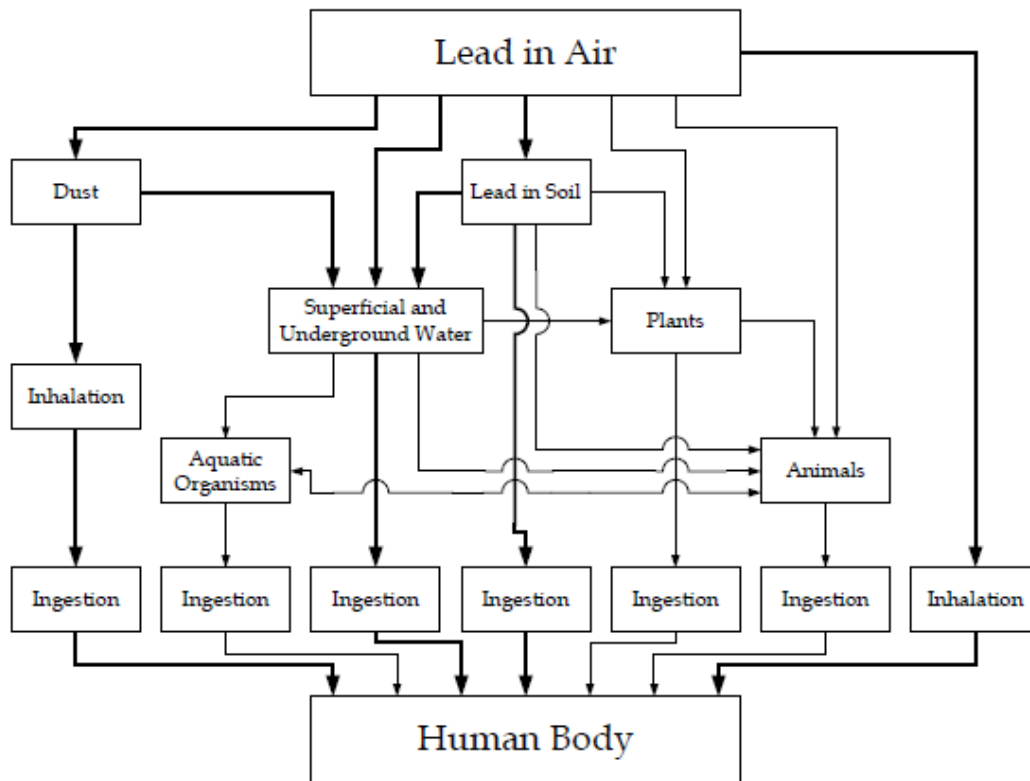

Fig. 2: Major pathways of human lead intake [1]

There are many facilities which have implemented scrap battery recycling as part of their pollution prevention efforts. The facility that makes the decision to implement used battery recycling will help to protect the environment and insure the compliance with environmental laws. There are many benefits of the lead battery scrap processing.

- Used battery recycling keeps all the hazardous metals in one place;
- The metals obtained in discharged car battery processing are reused in manufacturing process to build more batteries;
- The plastic (PP) from outer case of battery is also recycled for further use;
- Lead waste battery processing follows good environmental policy;
- The battery scrap recycling saves natural resources.

The major use of lead in the world is in the form of lead acid batteries. Lead acid storage batteries are an essential component of the automotive industry for which there are currently no electro-chemical, economic or environmentally acceptable alternatives. So this makes the used battery recycling more important. Lead recycling saves money, lead and most importantly, the environment.

4 Sources of waste lead batteries, estimation of amounts of produced used lead batteries

Lead batteries are used in vehicles of all types. As the amount of vehicles is gradually increasing all around the world, the amount of used batteries is also growing (in Figure 3, 4 and 5 the examples of the European market for automotive batteries are shown).

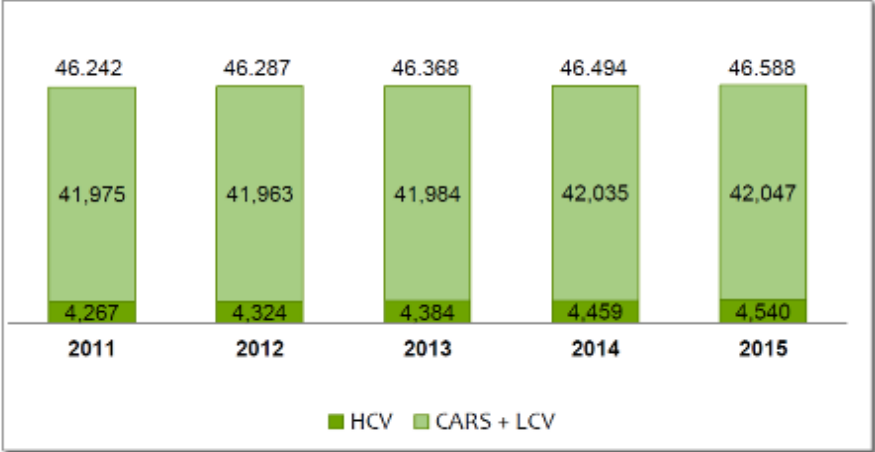

Fig. 3: Vehicle Production Europe and the outlook 2011-2015 (in k units) for CARS, HCV - Heavy Commercial Vehicles and LCV - Light Commercial Vehicles, Automotive Battery Committee, 2012

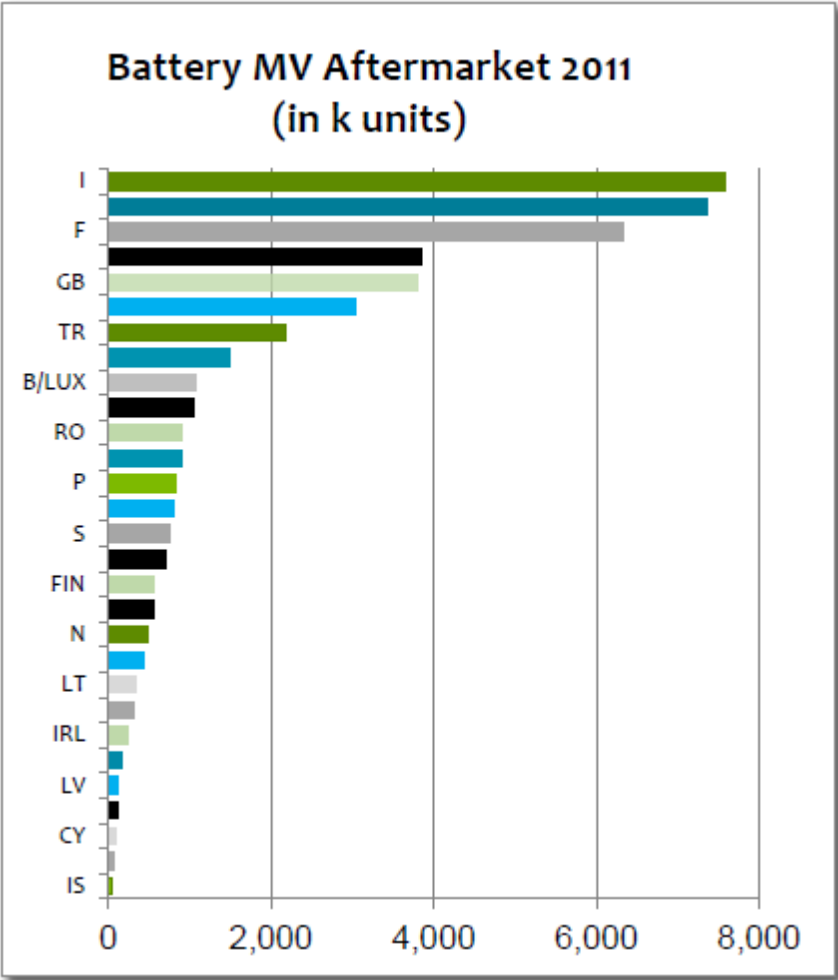

Fig. 4: Aftermarket battery volume for EU (2011 – 2015, in k Units). [5]

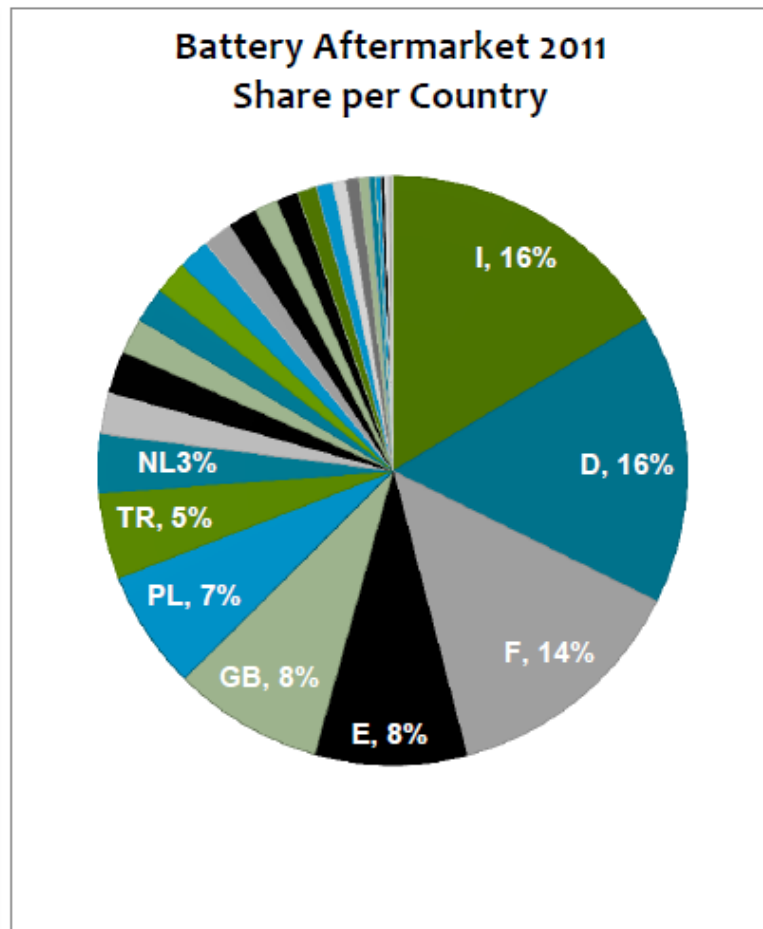

Fig. 5: Aftermarket battery per country in 2011. [5]

Another example is the consumption of lead acid batteries in Australia provided by the Australian Battery Recycling (ABRI) Initiative from 2010 [6]. In total, about 9.2 million lead acid batteries are purchased and 7.8 million reach the end of their useful life in Australia every year. By weight, lead acid batteries make up 91 %, or over 120,000 tonnes of the batteries disposed of in Australia. Australian households purchase more than 7.6 million or 86,000 tonnes of lead acid batteries each year, and dispose of more than 6.4 million or 92,000 tonnes of them. Lead acid batteries are most commonly used in cars, according to both the Pollinate and the ABRI research (see Table 1). Car batteries make up 63 % of all lead acid batteries used in Australia.

Table 1: Lead acid battery use in Australian households reported by Australian Battery Recycling Initiative in 2010 based on the survey. [6]

%	Q1 Items owned	Q2 Most recent change
Car	87	80
Home alarm systems	23	12
Motorcycle	8	3
Boat	8	2
Solar panel	19	2
Electric scooter	1	1
None of these	11	-
n	1000	893

Q1: Which of the following items do you have?

Q2: Which of the following items had their battery changed MOST recently?

Base: Total sample Australians aged 14 – 64 (September 2011, n = 1000)

The source of used lead batteries in the country are mostly professional car services, construction companies using internal car maintenance, agricultural farms using internal car maintenance and some other industrial companies. In countries with lower living standard also individuals change car batteries by themselves and households represent an important source of used lead batteries. In European countries the amount of produced used lead batteries per inhabitant and year is approximately 1.2 – 1.5 kg.

A typical composition of lead – acid battery scrap is given in Table 2 [7].

Table 2: Composition of typical lead – acid automotive battery scrap [7]

Component	Wt - %
Lead (alloy) component (grid, poles...)	25 - 30
Electrolyte paste (fine particles of lead oxide and lead sulphate)	35 - 45
Sulphuric acid (10 – 20% H ₂ SO ₄)	10 - 15
Polypropylene	4 - 8
Other plastics (PVC, PE, etc.)	2 - 7
Ebonite	1 - 3
Other materials (glass, etc.)	< 0.5

5 Overview of available standards, technical specification and guidelines on the storage and treatment of batteries and accumulators

5.1. European Union Legislative Framework

The European Commission's "Questions and answers on the Batteries Directive" [8] provide an introduction to the requirements which must be met by EU waste battery treatment systems and to the requirements which must be met during export of waste batteries:

Does the EU Batteries Directive (2006/66/EC) [9] lay down any requirements for treatment of waste batteries?

In addition to levels of recycling efficiency, the Directive specifies how waste batteries are to be treated. The minimum requirement is that fluids and acids must be removed. The Directive also describes the conditions under which waste batteries must be treated and stored (Article 12(2) and Annex III, Part A).

What requirements must be met if batteries are exported for recycling?

When waste batteries are exported outside the European Union, Member States must require sound evidence that the recycling takes place under conditions equivalent to those set out in the EU Batteries Directive, including recycling efficiencies.

Article 12(2) and Annex III, Part A of the EU Batteries Directive (2006/66/EC) [9] set following requirements on waste battery treatment:

Exclusively best available techniques are to be used.

□□The minimum requirements set to be met include:

1. *Treatment shall, as a minimum, include removal of all fluids and acids.*
2. *Treatment and any storage, including temporary storage, at treatment facilities shall take place in sites with impermeable surfaces and suitable weatherproof covering or in suitable containers.*

□□Recycling processes shall achieve the following minimum recycling efficiencies:

- a) *recycling of 65 % by average weight of lead-acid batteries and accumulators, including recycling of the lead content to the highest degree that is technically feasible while avoiding excessive costs;*
- b) *recycling of 75 % by average weight of nickel-cadmium batteries and accumulators, including recycling of the cadmium content to the highest degree that is technically feasible while avoiding excessive costs; and*
- c) *recycling of 50 % by average weight of other waste batteries and accumulators.*

In Article 13 of the EU Batteries Directive (2006/66/EC) [9] it is recommended

- that Member States shall encourage the development of new recycling and treatment technologies and
- that Member States shall encourage treatment facilities to introduce certified environmental management schemes (e.g. EMAS or ISO 14000).

No further details on how to treat waste batteries and accumulators are provided by EU legislation [9].

5.2. Best Available Techniques Reference Documents of the European Commission

In order to specify what the Best Available Techniques for the respective sectors and industrial processes are a number of Reference Documents on Best Available Techniques (BREFs) were prepared on the request of the European Commission. A dedicated BREF on waste battery treatment does not exist. However, following BREFs contain some specifications which are relevant for waste battery treatment:

- A) Reference Document on Best Available Techniques on Emissions from Storage [10] (for a summary of this BREF see Table 3).
- B) Reference Document on Best Available Techniques in the Non Ferrous Metals Industries, [11], [7] (for a summary of this BREF see Table 4).
- C) Best Available Techniques (BAT) Reference Document for Iron and Steel Production , [12] (for a summary of this BREF see Table 5).
- D) Reference Document on Best Available Techniques for the Waste Treatment Industries [13] (for a summary of this BREF see Table 6).

Table 3: Summary of the BREF on Emissions from Storage [10]

The BREF on Emissions from Storage addresses the storage and the transfer/handling of liquids, liquefied gases and solids, regardless of the sector or industry. It addresses emissions to air, soil and water. However, most attention is given to emissions to air. Energy and noise are also addressed but to a lesser extent.

Following storage methods for solids are addressed in particular:

- Heaps
- Sacks and bulk bags
- Silos and bunkers
- Packaged dangerous solids
- Containers and the storage of containers.

For the transfer and handling of solids, techniques such as mobile unloading devices, grabs, dump pits, fill pipes, thrower belts, conveyors and feeders are described. In each case the emission sources are identified.

Table 4: Summary of the BREF on Best Available Techniques in the Non Ferrous Metals Industries , [7], [11]

The BREF on best available techniques in the Non Ferrous Metals Industries covers the techniques for the production of both primary and secondary non-ferrous metals. The production of 42 non-ferrous metals and the production of ferro alloys are addressed. Ten groups of metals with similar production methods are dealt with in the document:

- Copper and its alloys, Tin and Beryllium
- Aluminium and its alloys
- Zinc, Lead, Cadmium, Antimony and Bismuth etc
- Precious metals
- Mercury
- Refractory metals, e.g. Chromium, Tungsten, Vanadium, Tantalum, Niobium, Rhenium, Molybdenum
- Ferro alloys, e.g. IronChromium, IronSilicon, IronManganese, SiliconManganese, IronTitanium, IronMolybdenum, IronVanadium, IronBoron
- Alkali and alkaline earth metals, Sodium, Potassium, Lithium, Strontium, Calcium, Magnesium and Titanium
- Nickel and Cobalt
- Carbon and graphite electrodes. The production of carbon and graphite anodes is included because of the production of anodes at some aluminium smelters as an integral part of the production process.

Table 5: Summary of the Best Available Techniques (BAT) Reference Document for Iron and Steel Production [12]

The BREF on Best Available Techniques for Iron and Steel Production covers the processes involved in the production of iron and steel in integrated works as well as the production of steel in electric arc furnace steelworks. The main operations covered are:

- Loading, unloading and handling of bulk raw materials
- Blending and mixing of raw materials
- Coke production
- Sintering and palletisation of iron ore
- Production of molten iron by a blast furnace route, including slag processing
- Production and refining of steel using the basic oxygen process, including upstream ladle de-sulphurisation, downstream ladle metallurgy and slag processing
- Production of steel by electric arc furnaces, including downstream ladle metallurgy and slag processing
- Continuous casting.

Other downstream metal processing activities can be found in other BREF documents (e.g. see BREF on Ferrous Metals Processing Industry [12] or BREF on Smitheries and Foundries Industry [14])

Table 6: Summary of the BREF for the Waste Treatment Industries [13]

The BREF for the Waste Treatment Industries covers the installations of a number of waste (hazardous and non-hazardous) treatment processes, and deals with:

- Common waste treatment processes such as temporary waste storage, blending and homogenisation, repackaging, waste reception, sampling, checking and analysis, waste transfer and handling installations, and waste transfer stations
- Biological waste treatment processes such as aerobic/anaerobic treatment processes and mechanical and biological treatment processes
- Physico-chemical waste treatment processes of such as neutralisation, chromic acid and cyanide treatment, dewatering, filtration, harbour reception facilities, oil/water separation, precipitation, separation of Mercury from waste, settlement, solidification and stabilisation, and UV and ozone treatment
- Treatment processes to recover waste material for secondary use such as the re-concentration of acids and bases, the recovery of metals from liquid and solid photographic waste, the regeneration of organic solvents and spent ion exchange resins, and the re-refining of waste oils
- Treatment processes to produce mainly solid and liquid fuels from hazardous and non-hazardous waste.

The Best Available Techniques from the BREF for the Waste Treatment Industries [13] are of special importance for meeting the requirements set out in Annex III Part A of the EU Batteries Directive [9]. Some examples on relevant topics from this BREF are:

- Requirements for the treatment of waste containing mercury;
- Requirements to be considered during crushing, shredding and sieving operations;
- Best Available Techniques to prevent or control emissions;
- Best Available Techniques to prevent soil contamination;
- Best Available Techniques for storage and handling;
- Best Available Techniques on the management of the residues generated by the waste treatment process.

5.3. Basel Convention on the Control of Transboundary Movements of Hazardous Wastes and Their Disposal

Basel Convention on the Control of Transboundary Movements of the Hazardous Wastes and Their Disposal regulates conditions for transboundary shipment of hazardous wastes to protect environment of the developing countries from the negative effects of inappropriate waste disposal. The Secretariat of the Basel Convention has published several guidelines, one of them dealing with management of waste lead – acid batteries [1]. The guideline in detail describes applied technologies of waste lead batteries treatment and recycling together with environmental and health aspects.

5.4. Guidelines on best available techniques and provisional guidance on best environmental practices of the Stockholm Convention

The **Guidelines on best available techniques and guidance on best environmental practices** is the harmonized framework and guidance initiated by UNEP Chemicals which provide the necessary guidance called for in paragraph c) of the Article 5 of the Stockholm Convention. The use of best available techniques and the promotion of the application of best environmental practices shall be promoted in some cases and required to minimize releases of POPs from unintentional production [24].

Thermal process of used lead batteries in the metallurgical industry i.e. secondary lead smelting involves the production of lead and lead alloys, primarily from scrap automobile batteries, and also from other used lead sources (pipe, solder, drosses, lead sheathing). Production lead processes include lead batteries scrap treatment, smelting and refining. Incomplete combustion; high levels of oils, plastics and other organic materials in feed; and temperatures between 250°C and 500°C may all give rise to chemicals listed in Annex C of the Stockholm Convention. Polychlorinated dibenzo-p-dioxins (PCDD) and polychlorinated dibenzofurans (PCDF) performance levels associated with best available techniques for secondary lead smelters are <0.1 ng I-TEQ/Nm³ (at operating oxygen concentrations). Best available techniques include the use of plastic-free and oil-free feed material, high furnace temperatures above 850°C, effective gas collection, afterburners and rapid quench, activated carbon adsorption, and dedusting fabric filters.

General information on emissions from secondary lead smelters

Air emissions from secondary lead smelting can escape as stack or fugitive emissions, depending on the facility age or technology. Main contaminants are sulphur dioxide (SO₂), other sulphur compounds and acid mists, nitrogen oxides (NO_x), metals (especially lead) and their compounds, dusts and traces of PCDD and PCDF. SO₂ is collected and processed into sulphuric acid in acid plants. Fugitive SO₂ emissions can be controlled by good extraction and sealing of furnaces. NO_x can be reduced using

low-NO_x or oxy-fuel burners. Particulate matter is collected using high-efficiency dust removal methods such as fabric filters and returned to the process.

Emissions of PCDD/PCDF to air during the smelting process

The most problematic PCDD/PCDF are formed during base metals smelting through reaction of products of incomplete combustion, unburnt organic contaminants and chlorine compounds, usually by de novo synthesis in the cooling zone at temperatures between 250°C and 450°C.

PCDD/PCDF or their precursors may be present in some raw materials and there is a possibility of de novo synthesis in furnaces or abatement systems. PCDD/PCDF are easily adsorbed onto solid matter and may be collected by all environmental media as dust, scrubber solids and filter dust. The presence of oils and other organic materials on scrap or other sources of carbon (partially burnt fuels and reductants, such as coke), can produce fine carbon particles which react with inorganic chlorides or organically bound chlorine in the temperature range of 250°C to 500°C to produce PCDD/PCDF.

Although PCDD/PCDF are destroyed at high temperature (above 850°C) in the presence of oxygen, the process of de novo synthesis is still possible as the gases are cooled through the 'reformation window' [24].

Full description of primary and secondary measures on PCDD/PCDF minimization is given in the chapter "Thermal processes in the metallurgical industry not mentioned in Annex C, part II" of the "Guidelines on BATs and Provisional Guidance on BEPs" of the Stockholm Convention.

6 Collection, transport and storage of used lead batteries

The used lead batteries are an important source of environmental hazard and it is necessary to operate the effective system of management of used lead batteries. The result of the system is the environmentally safe handling and disposal of lead wastes as well as the production of valuable secondary raw materials.

The life cycle of lead batteries consists of these steps:

1. Production
2. Consumption
3. Collection and sorting
4. Transport
5. Storage
6. Treatment (dismantling)
7. Recovery (recycling)
8. Disposal

The scheme of life cycle of lead batteries is shown in Figure 6.

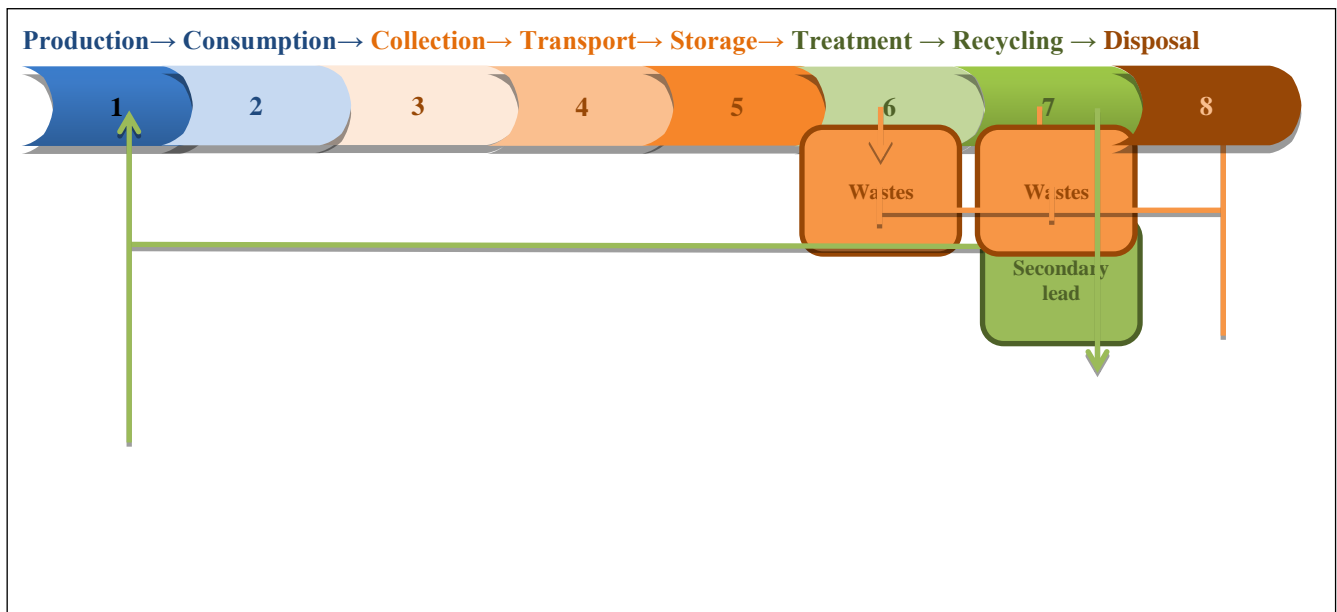

Fig. 6: Scheme of the life cycle of lead batteries

The used lead batteries system consists of the steps 3 to 8. All these activities must be under the strict control of authorities including the permit system for waste management activities.

There are listed the most comprehensive ways of treatment and requirements identified by an investigation of many potential sources:

General treatment of lead accumulators

- Collected waste batteries and accumulators shall be stored in weatherproof conditions in leak proof containers that are acid-resistant.
- Lead accumulators shall be treated separately from all other batteries and accumulators.
- At any rate, the treatment of lead accumulators shall demonstrably recover lead and plastics of adequate purity so that they can be recycled and thus, shall ensure their re-introduction in the production cycle.
- The treatment shall include measures to prevent diffusive lead emissions.
- Free sulphuric acid shall be recovered.

6.1. General occupational health and safety recommendations for workers during the waste management and treatment of used lead batteries

The actions and certain recommended measures in connection with occupational health and safety should be taken to improve waste management and treatment of used lead batteries of each treatment plant, and to achieve good environmental control practices.

From the health point of view, the proposed preventive measures are activities that should be observed in the occupational environment in order to prevent the workers exposed to lead from suffering adverse effects of lead contamination.

First aid treatment that is necessary part of each facility in case of contact with sulphur acid calls for flushing the skin for 10 to 15 minutes with large amounts of water to cool the affected tissues and to

prevent secondary damage. Immediately remove contaminated clothing, thoroughly wash the underlying skin and call for the doctor.

The most important proposed measures are to [1]:

- (a) consider every material containing lead as a possible source of environmental and human contamination;
- (b) keep the work environment in compliance with the national regulations for industrial safety;
- (c) segregate the work and eating areas i.e. prohibit eating and smoking inside the working areas;
- (d) prohibit children and pregnant women from working in lead recycling facilities;
- (e) undertake the development of educational and informative programs;
- (f) ensure the use of personal protection equipment in working places containing at least:
 - effectively protective cloth;
 - hard hats and safety footwear;
 - daily clean-up of the used cloths;
 - check and clean respirators daily;
 - protective masks which may vary in accordance of the average lead concentration in air;
- (g) control the lead concentrations in the working environment;
- (h) demand periodic medical checks of lead exposed workers;
- (i) enforce showering at the end of work.

6.2. Collection and sorting of used lead batteries

As used batteries are a valuable source of lead it is important to provide separate collection under controlled conditions to get the material for recovery as clean as possible. The second reason for controlled collection is environmental protection to prevent unprofessional dismantling with release of electrolyte to waters or soil.

The aim of separate collection is to get the used lead batteries from waste producers to authorised treatment facilities to prevent environmental and health hazards.

The outcome of the project [2] proposed the extended producer responsibility where the producers (importers) are obliged to provide (prepare, organise and finance) the system of waste collection, treatment and disposal. The producers will provide one or several systems of separate collection of waste batteries in order to meet collection limits given by legislation.

There are several systems of separate collection of used lead batteries. The simplest system is collection at sources, in vehicle services where the important amounts of used lead batteries are arisen.

The services have special containers for used lead batteries. It is prohibited to open or dismantle waste batteries. The container should be double-bottomed and marked with notice containing information on the waste type, hazardous properties and first-aid instructions. The batteries should be placed into the container bottom down to prevent spilling of the electrolyte.



Fig. 7: Container for separate collection of used lead batteries in vehicle service



Fig. 8: Container for separate collection of used lead batteries in gas station in Slovakia

The other separate collection system is the collection in gas stations. Gas station is equipped with double-bottom container where the used lead batteries are placed (bottom down). Take-back system in

specialised shops can be also introduced; the seller (distributor) of new lead batteries could be obliged to take back waste battery when the customer is buying a new one. It is required that the system is legally set in the country which decides the environmentally sound management of used lead batteries.

The next system is mobile collection organised by producers in cooperation with municipalities. The vehicle responsible for shipment of hazardous wastes having all permits and marking collects used lead batteries in municipalities in given term and given place. This system enables to collect used batteries from households and small facilities as farms or small services. The used lead batteries can be also collected in collection points operated by municipalities in special containers.



Fig. 9: Collection point operated by municipality Košice (Slovakia)

All collection systems are organised and financed by producers (importers). It is expected that collection is realised on the basis of agreements between operators of collection places (gas stations, services, municipalities) and producers (importers). It is acceptable to realise the separate collection on the basis of the agreement between operator of collection place and authorised treatment facility. It is necessary to control that all collected waste batteries will get to the authorised treatment facility or exported in accordance with the Basel Convention.

Based on the different treatment requirements and treatment options for the different battery types, a classification of batteries and accumulators according to different battery chemistry types, like the one shown in Table 7, is recommended. Batteries and accumulators should be sorted and prepared for separate treatment according to these battery chemistry types.

Due to the different characteristics of batteries containing **liquids** and **other** batteries, a differentiation between batteries containing liquids and batteries which are free of liquids is proposed (see also different recommendations for storage – chapter 6.4).

A mixture of liquid and non-liquid containing waste batteries should be regarded as batteries containing liquids.

Table 7: Recommended sorting fractions of batteries and accumulators

Sorting fraction - Battery type according to battery chemistry	Remarks
Pb-acid accumulators - liquid	including sealed lead acid accumulators with non-fixed electrolyte (using a catalyst to re-combine hydrogen and oxygen)
Pb accumulators – others	in sealed accumulators (sealed lead accumulators - SLA) the electrolyte is fixed by adding silica gel or by using a fibreglass mat (absorbent glass mat accumulator - AGM)

This classification according to battery chemistries is used to give information on specific storage requirements (see chapter 6.4) and on specific treatment requirements.

**Fig. 10: Bad examples of used lead batteries collection [25]**

6.3. Transport of used lead batteries

Used lead-acid batteries must be considered as hazardous wastes when transport is needed. Again, the main problem associated with battery transport is the electrolyte, which may leak from used batteries, requiring control measures in order to minimize the risk of spillage and define the specific actions to be taken in event of an accident:

(a) used batteries must be transported inside containers: no matter which mode of transport is being used, i.e. boat, train, etc., used lead-acid batteries must be transported inside sealed containers due to the risk of leakage, which may be high even if the batteries are appropriately transported in upright position. The transport may displace the batteries from their original positions, including eventual box breakages or turning them upside down, which will certainly leak the electrolyte content, thus making it necessary to provide a shock resistant and acid resistant sealed container;

(b) containers must be well packed to the transport vehicle: containers should not be allowed to move while being transported. Therefore, they must be bound, shrink wrapped or stacked properly to avoid this problem;

(c) the transport vehicle should be identified with symbols: the vehicle, whether it is a ship a truck or a van must be correctly identified, following international conventions, symbols and colours, identifying the fact that corrosive and hazardous products are being transported;

(d) specific equipment: a minimum set of equipment necessary to combat any simple spillage or leakage problems should be provided and the transport team trained on how to use it;

(e) drivers and auxiliaries should be trained: people dealing with hazardous wastes should always be trained in emergency procedures, including fire, spilling, etc. and how to contact emergency response teams. Besides this, they should be aware of the specific kind of hazardous material is being transported and how to deal with it;

(f) personal protection equipment: PPE should be provided for the transport team and they should be trained in the use of the equipment, in case of any accident;

(g) transport schedule and map: if possible, hazardous waste transport should always choose routes that minimize the risk of possible accidents or other specific problems. This is made possible if they follow a certain predefined path and restrict themselves to a known schedule [1].

Every transport should be controlled by state authorities (Regional Districts) by the means of permits.

It is recommended the permit should contain the following minimum information:

- Name and identification of sender receiver (address, ID number, statutory or other responsible person)
- Name and identification of receiver (address, ID number, statutory or other responsible person, method of next waste management – storage, treatment, recycling, disposal)
- Name and identification of transporter (address, ID number, statutory or other responsible person)
- Amounts of transported waste
- Identification of the transported waste (waste code or other identification including indication of hazardous characteristic)
- The duration of the permit

It is strongly recommended to authorise the transporters (companies providing transport of hazardous wastes) by the Ministry of Environmental Affairs.

The transport must be realised only in vehicles that meet safety requirements. The vehicle must be labelled.



Fig. 11: Labelling of hazardous cargos according to ADR

The vehicle must be furnished with first-aid set, set for elimination of accident consequences and the driver must be instructed on techniques in the case of accident.



Fig. 12: Packaging of used lead batteries ready to transport – good example

Source: <http://www.blacksmithinstitute.org/blog/?tag=ulab>



Fig. 13: Improved packaging – steps need to be done to reach good example

Source: ABRI, [26]

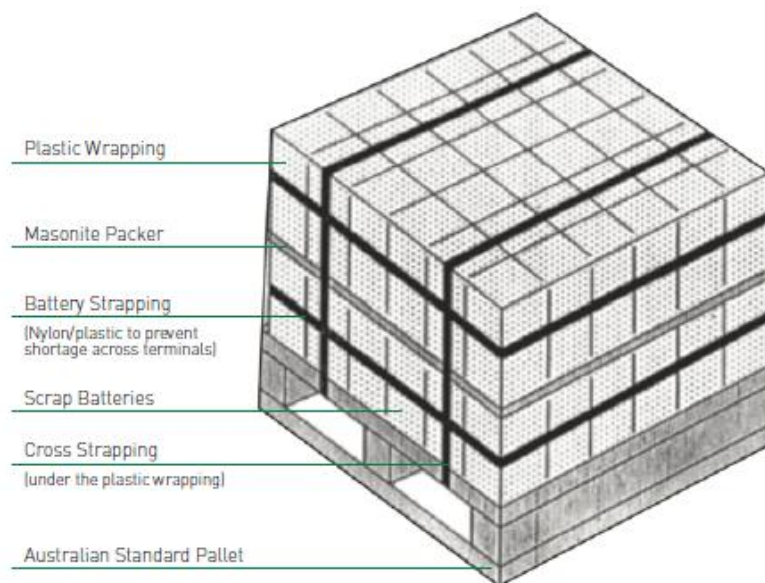

Fig. 14: Good examples of used lead batteries transport

Source: Responsible recycling of used lead acid batteries, How to manage the environmental, financial and reputational risks, Australian Battery Recycling Initiative, ABRI [26]

6.4. Storage of used lead batteries

Storage, including temporary storage, of waste batteries at treatment facilities shall take place in sites with impermeable surfaces and suitable weatherproof covering or in suitable containers. Table 8 shows recommendations on breaking down these requirements to a more detailed specification [15]. These specifications are valid for storage at treatment facilities including sorting facilities and storage facilities.

Storage buildings [10]

Storage buildings are used for storing all kinds of substances, from drums with flammable liquids, cylinders with pressurised gas, to packaged products such as chemicals and pesticides or chemical wastes awaiting disposal. They can be a standalone building or be part of another building.

Good design and construction of storage buildings containing dangerous materials focuses on events such as fire, explosion and releases of dangerous substances, in particular to prevent or control them as much as possible. Also good management practices and operational procedures are important.

Mostly, but not always, storage buildings are constructed from non-combustible materials. The degree of fire-resistance offered by the building itself determines the minimum distance to other buildings and to the boundaries of the danger zone. With a sufficient degree of fire resistance the storage building can be part of another establishment.

The storage space can be separated into different compartments for storing different types of hazardous material each by partition walls or by leaving a storage-free zone empty between the compartments. Some warehouses have an inbuilt store within the main warehouse. This interior store can be used to store particularly hazardous materials, such as highly flammable liquids or gases as well as peroxides.

The floors of the building are usually made of non-combustible material, are liquid-tight and are resistant to the stored substances.

The roof of the building is resistant to wind-blown fires, with the roof structure being of a fire resistant construction to prevent fire entering the store. The degree of fire-resistance depends on different factors such as, how close the store is to the border of the site or other buildings and the type of substances stored.

A storage building is normally equipped with adequate ventilation to prevent the formation of an explosive gas mixture from leakages and to extract any harmful or unpleasant fumes.

The use of electrical equipment can generate sparks that might ignite a fire in the storage building. Therefore, it is important to use explosion-protected electrical equipment. However, proper earthing of the steel structure also may be sufficient.

If a fire breaks out in a storage facility, part of the stored substances may be released.

The storage facility should be constructed in such a way that the released substance cannot cause any harm. In particular provisions are to be taken to prevent polluted extinguishant from entering the soil, the sewage systems or surface water.



Fig. 15: Improved Storage Facility in Central America and the Caribbean [25].

Outside storage (storage yards) [10]

In principle, measures and provisions for storing dangerous (packaged) materials outside do not differ from those for storage inside a building. The amount and type of substances stored determines the minimum distances from boundaries and buildings to be observed. To protect the storage from direct sunlight and rain, the storage area may be covered by a roof.

The provisions for collecting of spilled substances and possibly released extinguishant are the same as those applied in storage buildings as described above. When the storage is not covered with a roof, provisions for the cleaning of possibly polluted rainwater and its controlled discharge should be in place.

The level of fire prevention and fire-fighting measures depend on many factors, such as the flammability of the stored substances, the flammability of the packaging and the quantity of material stored.

Table 8: Proposal for the specification of the possible treatment requirement: “Impermeable surfaces and suitable weatherproof covering” [15]

Proposed Specifications for Waste Battery Storage	Applying to batteries:	
	containing liquids	other
Surfaces in operational areas should be resistant to chemicals and fire	yes	yes
Storage of waste batteries at treatment and recycling facilities should take place in a proper building or a covered place with the following minimum recommended requirements: - Impermeable and acid and/or alkali resistant floor depending on the electrolyte used - Efficient water collection system which directs spilled liquids towards the effluent or electrolyte treatment plant	yes	no
Storage in a proper building or under cover should also be applied to any container that is pending, sampling or emptying.	yes	yes
Storage may be carried out without cover if the stored waste batteries and containers are not affected by ambient conditions (such as sunlight, temperature, water)	yes	yes
Covered areas should have adequate provision for ventilation.	yes	yes
Containers holding substances that are known to be sensitive to heat, light and water, and thus may stay under cover and protected from heat and direct sunlight, are to be available in sufficient quantities and should have free access to appropriate storage areas.	yes	yes
For storing quantities of more than 2,500 litres or kilograms of dangerous substances a storage building and/or an outdoor storage area covered with a roof should be used according to the BREF on Emissions from Storage [10]	yes	yes
For storing quantities of less than 2,500 litres or kilograms of dangerous substances, at least a storage cell should be used according to the BREF on Emissions from Storage [10]	yes	yes
Batteries with alkaline and acidic electrolyte shall be stored separately	yes	no

The limit of 2,500 kilograms introduced in Table 8 as the recommended threshold for requiring a dedicated storage building should be applied to collection facilities like stores, car repair centres etc. where batteries and accumulators are taken back from final users. In these facilities batteries and accumulators are stored until a pick-up service transports them to treatment facilities.

Used lead batteries can be stored only in special storehouses designated for storage of hazardous wastes. The place for storage must be covered and the floor must be made from acid-resistance materials. It is forbidden to store used lead batteries near heating sources or fire because the danger of

explosion is present. It is also forbidden to smoke or use open fire in the storehouse. The storehouse must be equipped with air exhaustion system. The storehouse must be connected to sewage system or retention tank.

The used batteries must be placed to double-bottom containers or the storehouse must be constructed as the catch tank or the containers must be placed into the catch tank to prevent the leakage of the electrolyte.

The storehouse as well as the containers with waste batteries must be marked with notice containing information on waste type, hazardous properties and first-aid instructions. The first-aid set must be placed in the storehouse (close to the door easily available).

The mobile storehouse can be used but the temperature of the ambient air must be measured because the temperature over 40°C can cause the danger of spontaneous explosion.



Fig. 16: Mobile storehouse of hazardous wastes

It is recommended to regulate the requirements for storage of hazardous waste by legislation and to submit special permits for storage of hazardous waste by authorities (Regional Districts).

The intention is that this small scale storage for portable batteries and accumulators does not need a permit for the storage of hazardous wastes, as long as the batteries are not stored longer than one year (interim storage).

The interim / small scale storage for portable batteries and accumulators has to fulfil technical requirements such as:

- suitable containers are to be used (see Table 9),
- all storage areas have impermeable surfaces (see Table 8),
- the storage building and/or the outdoor storage area are covered with a roof (see Table 8),
- the storage building or area is inaccessible for unauthorised person.

In addition

- an interim storage for portable batteries and accumulators must be limited to the storage of this type of batteries;
- it shall also be limited by a maximum storage quantity and/or a maximum storage time of the average turnover of batteries. Proposed limits are:
 - a maximum storage quantity of 7,5 t (amount for a full ‘medium-size’ truck),
 - a maximum storage time of 1 year;
- this interim / small scale storage facility should fall under the same inspection requirements as the regular storage facilities which need permits.

Table 9 shows recommendations on which requirements should be fulfilled in order to make a container suitable for waste battery storage [15].

Table 9: Proposal for the specification of the minimum treatment requirement: “suitable containers” [15]

Proposed Specification for a Suitable Waste Battery Storage Container	Applying to batteries:	
	containing liquids	other
Storage must take place in leak proof containers that are acid and/or alkali resistant depending on the electrolyte used.	yes	no
Use UN standardized containers	yes	yes
Containers must be clearly labelled as regards the nature of the waste and the relevant danger symbols	yes	yes
If appropriate, the use of re-usable packaging (drums, containers, IBCs5, pallets, etc.) should be maximised.	yes	yes

7 Treatment of used lead batteries

The treatment of used lead batteries is sometimes called wet technology, as the liquid electrolyte is present.

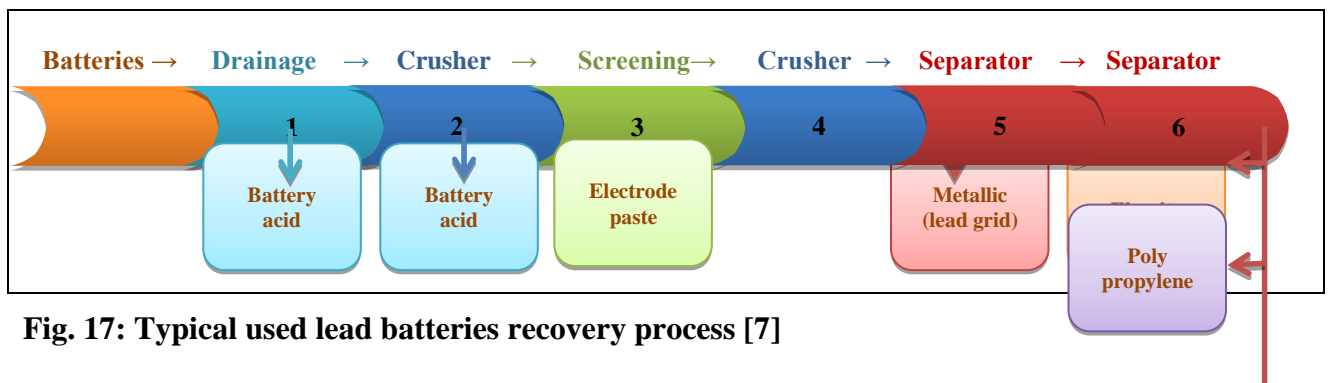

Fig. 17: Typical used lead batteries recovery process [7]

The Technical Guidelines [1] describes following treatment steps and two methods in order to isolate the metallic lead from this mixture that may be applied:

- battery breaking – including a description of processes and potential sources of environmental contamination,
- lead reduction including a description of pyrometallurgical (also known as fusion-reduction method) and hydrometallurgical methods (also known as electrolytic method) and potential sources of environmental contamination,
- lead refining - especially describing pyrometallurgical refining and potential sources of environmental contamination.

The battery scrap obtained from the breaking process is a mixture of several substances: metallic lead, lead oxide (PbO), lead sulphate (PbSO₄) and other metals such as calcium (Ca), copper (Cu), antimony (Sb), arsenic (As), tin (Sn) and sometimes silver (Ag) [1].

As pollutants which potentially are emitted from the treatment processes e.g. electrolyte, dust, sulphur dioxide (SO₂) are described and some measures for pollution prevention are mentioned.

Relevant requirements for lead-acid accumulators derived from the Technical Guidelines [1] are included in Chapter 10.2 - Special care on batteries and accumulators with liquid electrolyte and Chapter 6.2 - Treatment requirements with regard to the battery chemistry.

Requirements for removal of fluids

According to the EU Batteries Directive (2006/66/EC) Article 12(2) and Annex III, Part A [9], waste battery treatment shall, as a minimum, include removal of all fluids and acids.

Table 10 specifies specifications for removal of fluids and acids as recommended in [15] in order to limit the environmental impact of these processes.

Table 10: Proposal for the specification of the minimum treatment requirement: “Removal of all fluids and acids, their collection and treatment” [15]

Proposed Specification for the Removal of Fluids and Acids from Waste Batteries	Applying to batteries:	
	containing liquids	other
Batteries should be drained and prepared for recycling by adequately trained workers wearing personal protection.	yes	-
In operational areas a ground cover has to be utilised that may retain any leakage and direct it to a collecting container from where it can be removed.	yes	-
The capacity to retain leakage must at least be equal to the amount of liquid stored	yes	-
Surfaces of operational areas, drainage systems and other subsurface structures should be maintained, including applying measures to prevent or quickly clear away leaks and spillages.	yes	-

Electrolyte should be directed to appropriate treatment (recycling/recovery or appropriate waste treatment)	yes	-
Recycling/recovery of electrolyte should be done if appropriate; direct discharge of neutralised and/or untreated electrolyte should be avoided.	yes	-
When applying a neutralisation process customary measurement methods have to be used.	yes	-
Neutralised waste water from the neutralisation process has to be stored separately	yes	-
A final inspection of the neutralised waste water from the neutralisation process has to be performed	yes	-

In specific cases the removal of fluids is not feasible, e.g. if the electrolyte is solidified (lead acid gel accumulators). In such cases the recycling process must be optimised individually with the aim to minimise emissions and hazards to human health as well as to achieve high recycling efficiency.

During the treatment processes the environmental hazard must be taken into account. The collecting vessel must be acid-resistant, usually having special pavestone bottom and walls covered by resistant foil and stainless steel. The space around collecting vessel is monitored for leakage.

The main environmental issues of the lead industry are air and water pollution and the generation of hazardous wastes. The facilities generally have their own wastewater treatment facilities and wastewater recycling is usually practised. Many wastes are reused but the major item is leach residue that has a high environmental impact. Some local aspects, like noise, are relevant to the industry. Due to the hazardous nature of some solid and liquid waste streams, there is also a significant risk for soil contamination.

As it is not purpose of the guidelines to describe into the detail some technical specifications but the waste management it is recommended to follow guidelines [14, 24].

8 Recovery of used lead batteries

The recovery of secondary lead consists of smelting, refining and doping.

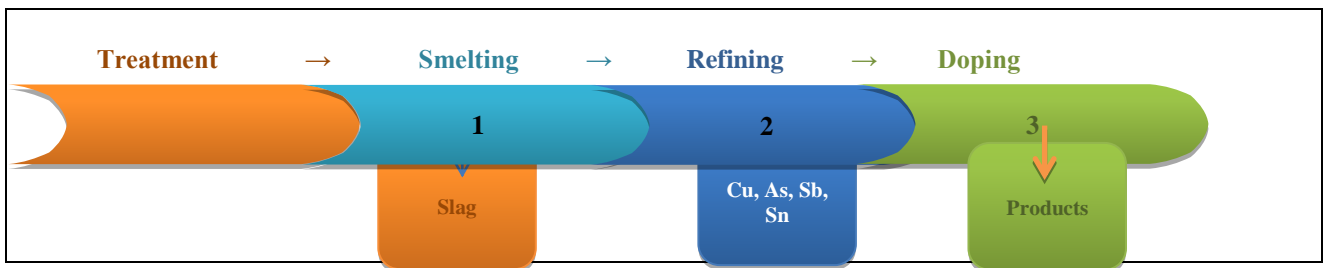

Fig. 18: Typical used lead batteries recovery process [10]



Fig. 19: Secondary lead installation of the company Mach Trade (Slovakia)



Fig. 20: Costa Rica – Pb Metals SA [25].

Recovery of lead from products of wet technology is operated in metallurgy part of the technology. There are two main types of process for the recovery of lead from automotive batteries:

- a. Batteries are drained of acid and fed whole into a blast or shaft furnace (Varta process). Whole batteries and fluxes are fed into a blast furnace via a seal and oxygen enriched air is used in the blast. Antimonial lead bullion is produced, along with silica based slag and a lead/iron matte that can be recovered in a primary lead smelter. Organic components in the furnace off-gases are

oxidised in an after- burner and the gases are then cooled and filtered in a fabric filter. The filter dust is de-chlorinated and returned to the furnace.

- b. Batteries are drained of acid broken and separated into various fractions using automated proprietary equipment (MA and CX processes). Both the MA and CX (Engitec) processes use hammer type mills to crush the whole batteries. The crushed material then passes through a series of screens, wet classifiers and filters to obtain separate fractions containing metallic components, lead oxide sulphate paste, polypropylene, non-recyclable plastics and rubber and dilute sulphuric acid. Some processes use a second milling stage before the plastic fraction is finally treated. Polypropylene is recycled as far as possible. The sulphuric acid drained from the batteries is neutralised unless there is a local use for it and the sodium sulphate produced can be re-crystallised and sold. These are strongly market dependent options.

As it is not purpose of the guidelines to describe into the detail technical specifications of the lead recovery metallurgical processes but the waste management it is recommended, however, for more details to follow chapter 5.2 Best Available Techniques Reference Documents of the European Commission where BREFs contain many specifications which are relevant for waste battery treatment. Nevertheless, several alternatives are used to deal with the sulphur contained in the battery materials from the environmental point of view.

- Prior to smelting, the lead sulphate paste may be de-sulphurised by reaction with sodium carbonate or sodium hydroxide (in the CX and related processes).
- Lead sulphate can be separated and sent to an installation capable of treating the sulphur content in the gases for example one of the direct smelting primary lead processes.
- The sulphur may be fixed in the slag or as a Fe/Pb matte.

Paste de-sulphurisation prior to smelting can reduce the quantity of slag produced and, depending on the smelting method used, the amount of sulphur dioxide released to the air.

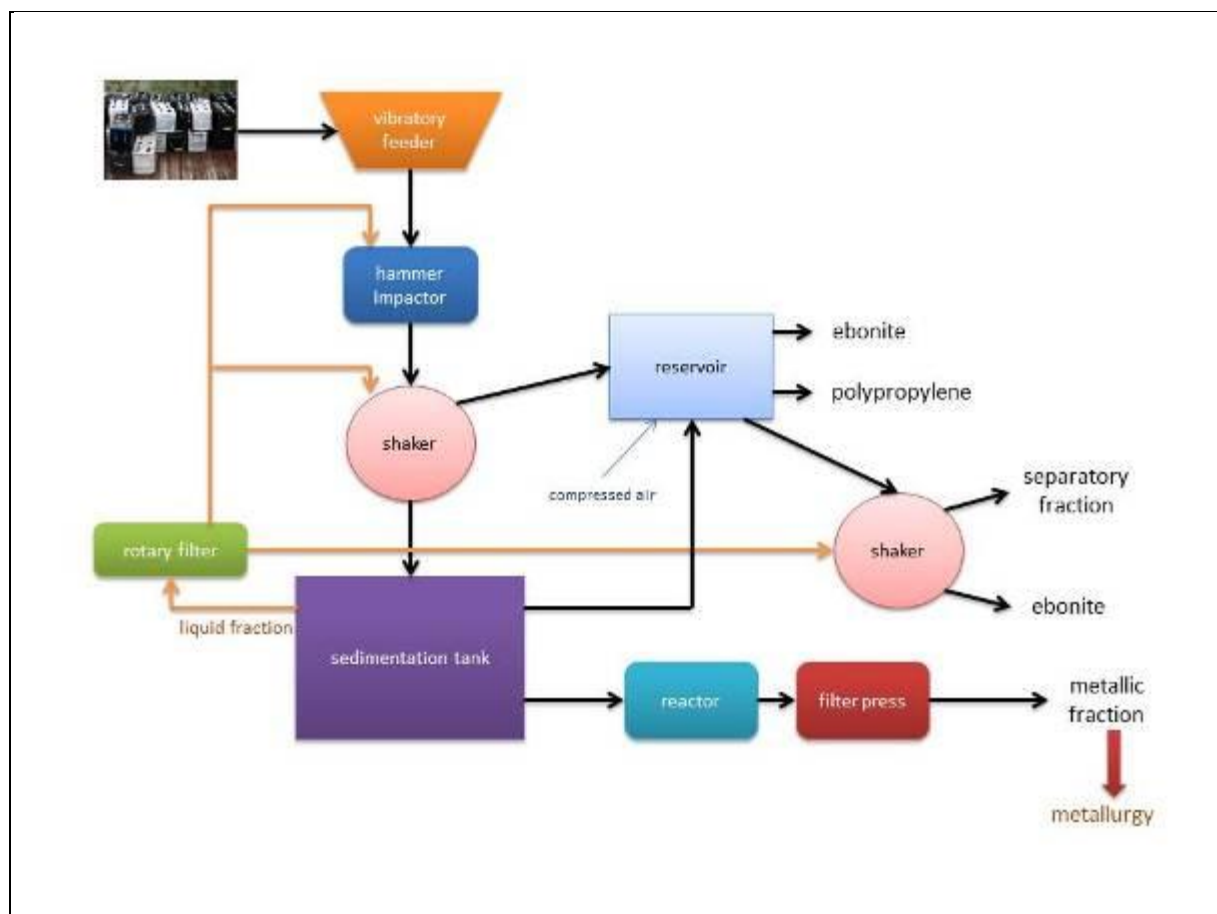

Fig. 21: Example of scheme of the wet treatment technology (Engitec) [16]

The lead and lead paste are transported to the smelting reactor that can be:

- rotary furnace,
- reverberatory furnace and blast or electric furnace,
- rotary kiln,
- ISA Smelt furnace,
- electric furnace.

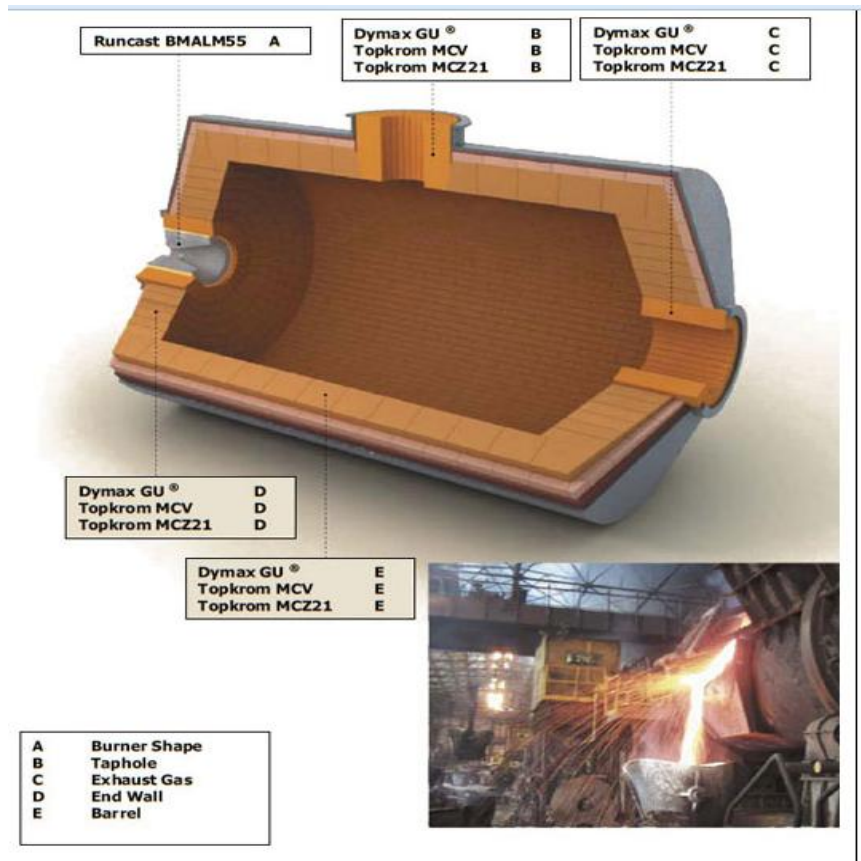

Fig. 22: Example of lead rotary furnace [27]

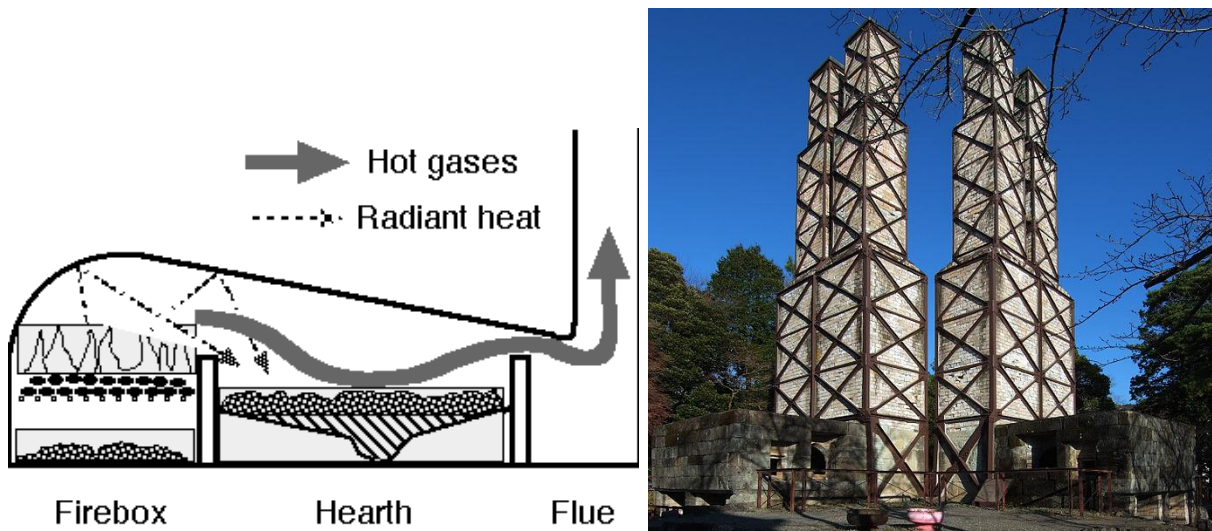

Fig. 23: Example of reverberatory furnace [28]



Fig. 24: Examples of blast furnace [29]

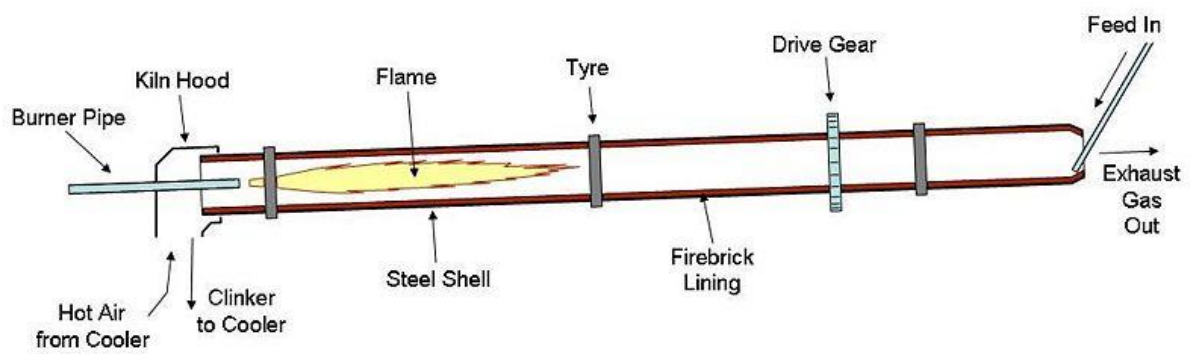

Fig. 25: Example of rotary kiln [30]



Fig. 26: Example of ISA Smelt furnace [31]

Rotary and reverberatory furnaces can be either gas or oil fired. Oxygen enrichment is used in several installations. Smelting is usually carried out in batches, slag and metal are tapped out separately and batches of slag are treated to recover more lead and produce a slag that is stable. The bulk of the sulphur in the charge is fixed in the slag, which is a sodium-iron-sulphur compound with small amounts of lead and other metals.

In the ISA Smelt process de-sulphurised paste and reductant are continuously fed into the furnace and lead bullion is tapped periodically. When the process vessel contains the maximum volume of slag, reductant and fluxes are added to produce high antimony bullion and a discard slag. The slag may also be reduced in a separate furnace.

The electric resistance furnace is used for complex secondary materials and uses an open slag bath covered by coke. Raw materials are fed onto the top of the bath where they react to produce metal and slag, which are tapped periodically. The waste gas contains CO and is burnt and flue dust is collected. The furnace is fed with input materials that are lead metal and lead pasta, resp. dust outlet, slag formers, reductant and calcinated soda. After feeding the input opening is closed and the furnace is heated. After the smelting the content of furnace is poured out to pre-heated mould. The slag remains in the top part of the mould and the lead is pin down to ingot mould [10, 11, 16].



Fig. 27: Furnace of Industrias Meteoro S.A. - Dominican Republic [25].

The following tables give input and output balances for some lead plants in Europe as an example [11].

Table 11: Example of input and output data for a battery recovery plant without de-sulphurisation

Input			Output		
<i>Melting materials</i>	<i>t/t Pb</i>	2.12	<i>Products</i>		
Battery scrap	%	63	Lead and lead alloys	t/t Pb	1
<i>Other melting materials</i>	%	21	Battery paste	t/t Pb	0.5
Bullion, scrap lead	%	16	Polypropylene	t/t Pb	0.07

<i>Reagents</i>	t/t Pb	0.14	<i>Residues</i>		
Steel borings	%	46	Residual plastics	t/t Pb	0.10
Petrol coke	%	32	Slag	t/t Pb	0.23
Soda	%	22	<i>Others</i>		
<i>Others</i>			Exhaust gases	Nm ³ /t Pb	70 000
Electric energy	MWh/t Pb	0.26			
Natural gas	MWh/t Pb	1.19			
PP chips (external)	t/t Pb	0.04			

Table 12: Example of input and output data for a battery recovery plant with de-sulphurisation

Input			Output		
<i>Melting materials</i>	t/t Pb	1.41	<i>Products</i>		
Battery scrap	%	79.0	Lead and lead alloys	t/t Pb	1
<i>Other melting materials</i>	%	3.8	Sodium sulphate	t/t Pb	0.096
Bullion, scrap lead	%	16.6	Polypropylene	t/t Pb	0.051
Flue dust incinerator	%	0.6	<i>Residues</i>		
<i>Reagents</i>	t/t Pb	0.307	Residual plastics	t/t Pb	0.108
NaOH	%	49.8	Metallurgical slag	t/t Pb	0.18
Steel borings	%	9.4	<i>Others</i>		
Petrol coke	%	17.6	Exhaust gases	Nm ³ /t Pb	37 000
Soda	%	23.1			
<i>Others</i>					
Electric energy	MWh/t Pb	0.20			
Natural gas	MWh/t Pb	0.73			
Steam	MWh/t Pb	0.84			

After the recovery of lead from battery scrap the refining of crude lead is operated. Lead bullion may contain varying amounts of copper, silver, bismuth, antimony, arsenic and tin. Lead recovered from secondary sources may contain similar impurities, but generally antimony and calcium dominate.

There are two methods of refining crude lead:

- electrolytic (hydrometallurgical method) refining, which refining uses anodes of de-copperised lead bullion and starter cathodes of pure lead,
- pyrometallurgical (also known as fusion-reduction method) refining that consists of a series of kettles, which are indirectly heated by oil or gas.

Hydrometallurgical Methods

The objective of the hydrometallurgical methods, or electrolytic methods, is to electrically and selectively reduce all lead compounds to metallic lead, such as in the PLACID technology.

The chemical concept behind the electrolytic process is the conversion of all lead compounds into a single chemical species, lead in oxidation state +II (Pb²⁺ or plumbous lead) in this case, which is then electrolytically reduced to produce metallic lead. The electrolysis deposits lead as dendrites or sponge, which are subsequently shaken off and collected on a conveyor belt and pressed to form platelets of

pure lead (99.99%), which can then be conveyed to a melting kettle for casting into ingots. The whole extraction process can be run continuously 24 h/d, without interruption.

Although it may be sometimes costly when considered as an isolated plant, this process provides good results when linked to a low temperature smelting plant since, with the appropriate separation of raw materials, it is a technological solution to overcome the lead refining processes [1].

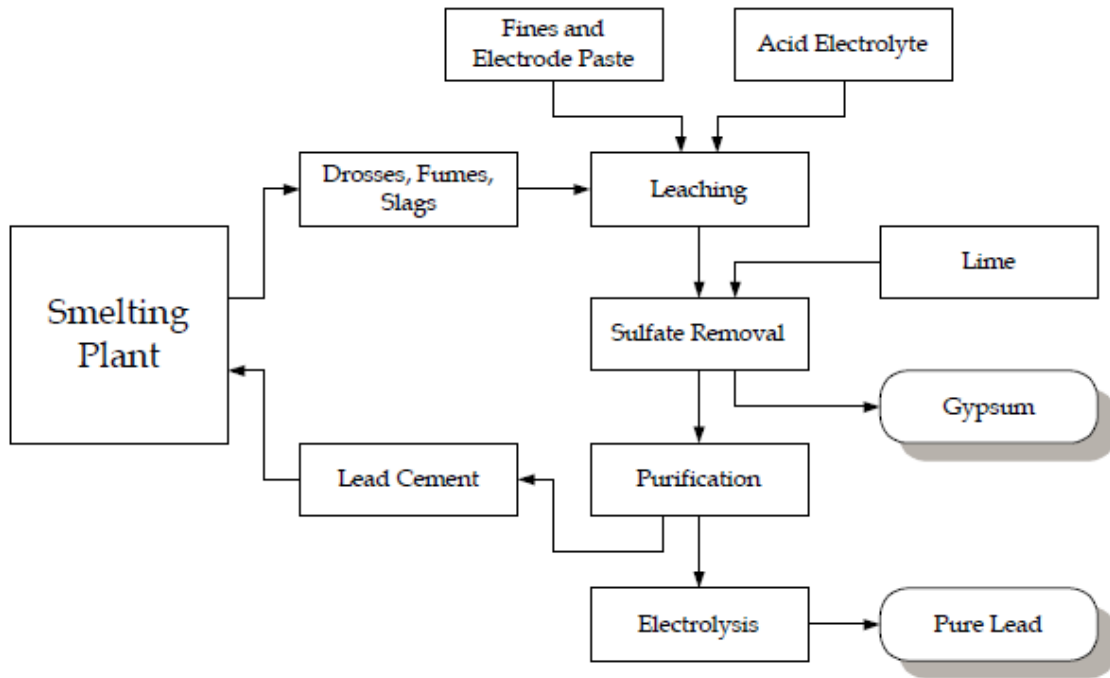

Fig. 28: Diagram of an electrolytic lead process [1]

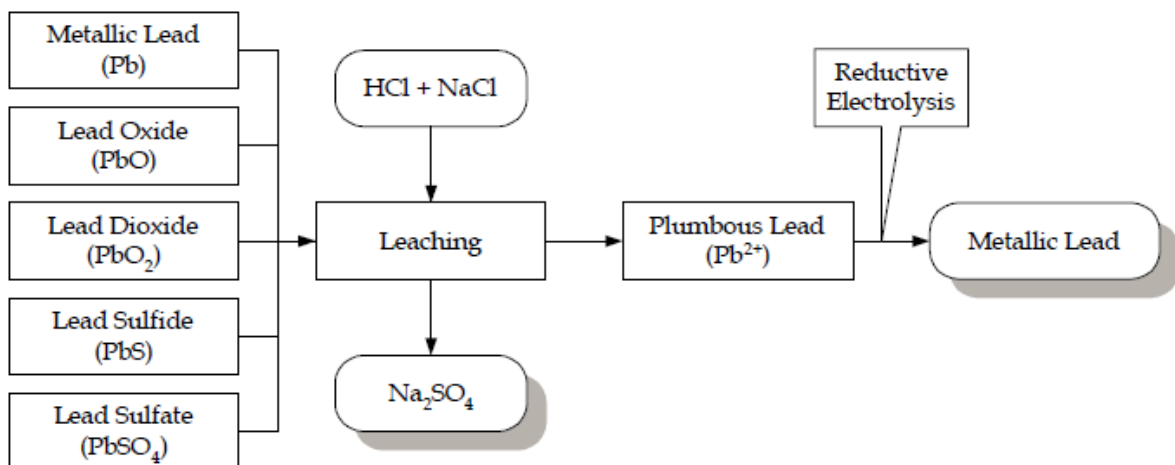

Fig. 29: Electrochemical process in hydrometallurgical lead production [1]

Pyrometallurgical Methods

The objective of the pyrometallurgical methods (fusion-reduction) is to chemically reduce all metallic compounds to their metallic or reduced forms by means of heating and providing adequate fluxing and reducing substances.

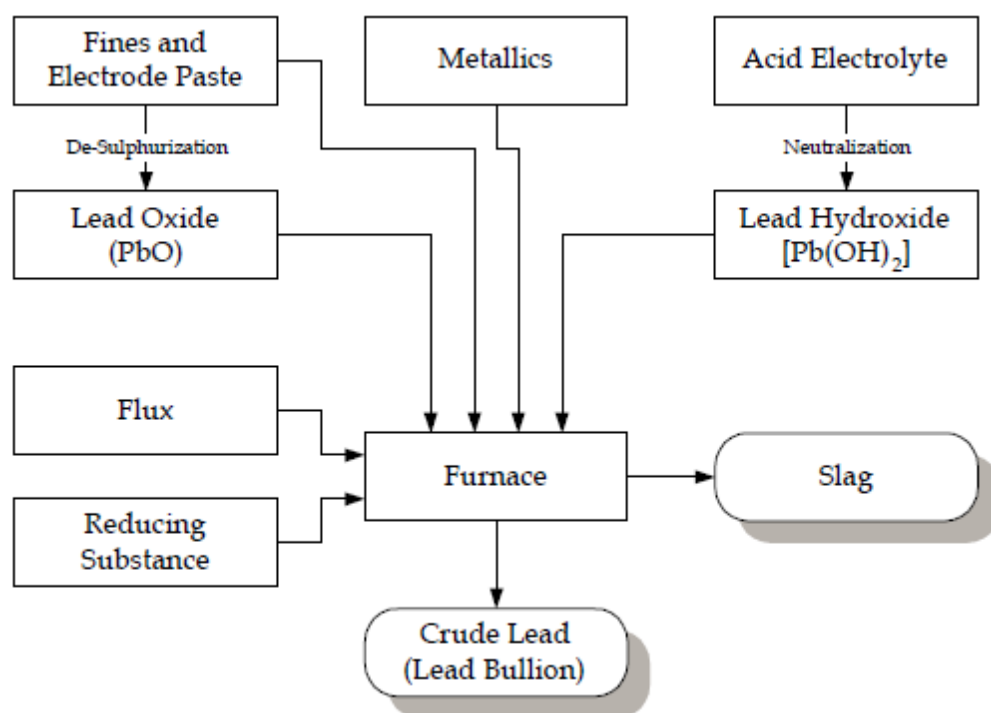

Fig. 30: Diagram of a lead smelting pyrometallurgical process [1]

Prior to smelting, some methods may be employed to de-sulphurise the lead sulphate paste by reacting it with a mixture of sodium carbonate (Na_2CO_3) and sodium hydroxide (NaOH), such as in the CX and related processes, converting the lead sulphate (PbSO_4) to lead oxide (PbO). Sometimes the de-sulphurizing agent may also be iron oxide (Fe_2O_3) and limestone (CaCO_3). This procedure reduces the amount of slag formation and also, depending on the smelting method, the amount of sulphur dioxide (SO_2) released into the air. However, other methods simply add controlled amounts of lead sulphate as well as de-sulphurizing agent directly into the furnace.

The acid electrolyte must also be treated before its lead content may be sent to the smelting furnace. This is carried out by neutralization of the electrolyte solution with sodium hydroxide, which precipitates the present lead as lead hydroxide [Pb(OH)_2]. This compound is then removed by decantation or filtration and directed to the furnace. The remaining solution, sodium sulphate diluted in water (Na_2SO_4), may be further purified and the salt isolated in high purity grades (up to food grade quality).

The metallic fraction and the lead compounds derived from the de-sulphurization and neutralization processes are then added to the furnace and smelted with fluxing and reducing agents. The necessary heat is provided by several sources depending on the specific method oil, gas, coke, electricity, etc. The fluxing agents, which melt at a temperature below the lead compounds melting temperature, are added not only to reduce the lead smelting temperature, but also to provide a liquid solvent, which traps several unwanted compounds during the smelting and reducing processes. As the flux starts to be contaminated with all sort of impurities from the smelting process the formation of slag also starts. The physical and chemical properties of this slag, which are important characteristics to be considered in a later treatment, are entirely dependent on the chemical composition of the flux that is used.

Reducing agents, on the other hand, are added with the purpose of reducing the lead oxide (PbO) and hydroxide [Pb(OH)_2] to metallic lead. It is usually a carbon based compound such as coke, coal fines or other natural carbon source.

After the process had been properly balanced, the melted metallic lead starts to accumulate in the bottom of the vessel. However, as mentioned earlier, it is sometimes heavily contaminated with other metals of economic value. Therefore, this lead bullion must undergo a refining process before pure lead can be recovered from it [1].

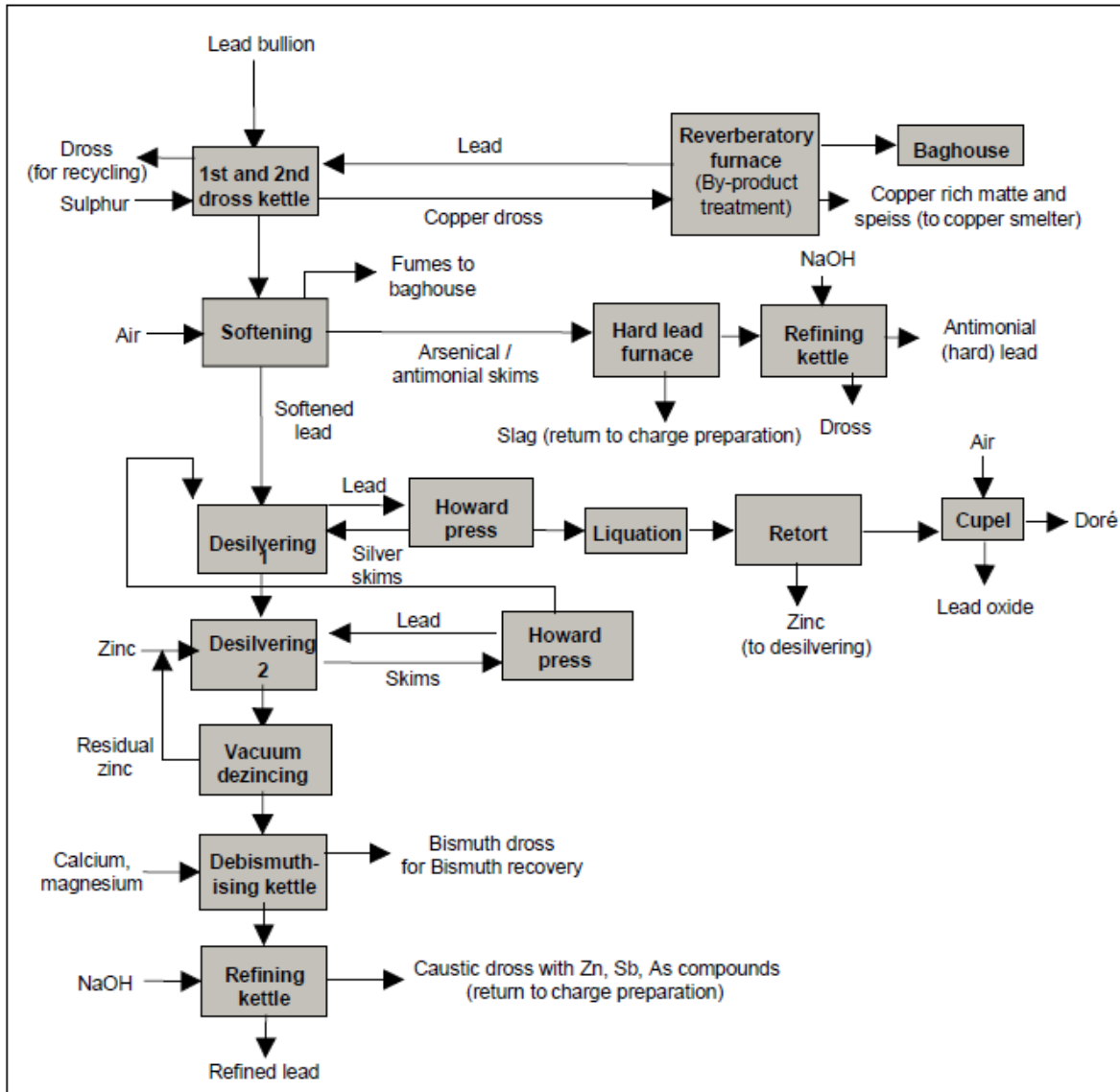

Fig. 31: Diagram of more detailed lead refining process [11]



Fig. 32: Lead bars as the final product

The process of lead scrap recovery produces emissions to air and waste waters. The main emissions to air are [7]:

- sulphur dioxide SO₂, other sulphur compounds and acid mists;
- oxides of nitrogen NO_x and other nitrogen compounds;
- metals and their compounds;
- dust;
- VOC's and PCDD/F [11, 14]:

Table 13: Example of mass release of metals from battery scrap recovery in some plants in Europe [7]

Process	Production (tons)	Dust (g/t _{product})	Zn (g/t _{product})	Pb (g/t _{product})	Cd (g/t _{metals})	As (g/t _{metals})
Battery – Whole (shaft)						
-process	49 000	10 - 25	0.1	2.5	<0.1	<0.15
-refinery	53 000	0.49	NA	0.024	NA	NA
-secondary*		<2 mg/Nm ³	NA	<0.01 mg/Nm ³	NA	NA
Battery – de-sulphurised paste						
-process	43 000	1 - 3	NA	0.1 - 1	0.01	0.18
-refinery	52 000	4	NA	0.5	0.02	0.24
-secondary*		6	NA	0.3	NA	0.02
Battery – Whole (short rotary)						
-process	10 000	15 - 35	NA	<0.5	NA	<0.3

*Secondary hood dedusting

Table 14: Example of national emission limits for standard conditions (dry gas) for secondary lead technology (Slovak Republic)

Pollution source	Emission limit (mg/m ³)		
	Solid pollutants	SO _x	NO _x
Transport and handling	50		
Furnace aggregates	20	350	400
Smelting and casting	10	350	400

The battery breaking and washing stages produce an effluent which is acidic and contains lead and other metals in suspension and solution. This effluent is neutralised and the water is recycled in the process. If possible, the acid is used elsewhere. A portion is usually bled from the system to control dissolved salts. Cooling water can also arise from cooling the crushing process [7].

These processes also produce contaminated surface water and consequently this water is also treated and reused. It is common practice to discharge a bleed of this sealed water circuit after further treatment and analysis. Road and surface contamination is minimised by the frequent wet cleaning of roads, hard standing areas, lorry and by cleaning up spillages.

The quality and quantity of waste water depends on the process used, the composition of the raw materials used in the process and the practices used by the operators. The reuse of process water and rainwater is common.

Cooling water from the granulation of slag or the cooling pond is usually recirculated in a closed circuit system.

Typical components in waste water from some processes are given in Table 15 [7].

Table 15: Example of typical waste water analysis [7]

Process	Effluent (m ³ /yr)	Flow (m ³ /h)	Main components (mg/l)					COD
			Pb	Cd	As	Zn	Ni	
Mechanical battery separation (CX)+ Rotary Furnace *	190 000	<0.2						
Mechanical battery separation (MA) + rotary furnace *	124 000		0.02	0.07	<0.0005	0.27	0.09	
Whole battery *	150 000	40	0.4	0.01	<0.001	0.01	<0.05	96
Shaft furnace *	17 000		<0.2	<0.1		<0.3		
CX + rotary furnace + Pb refinery *	105 000	2.1	0.13	0.01	0.01		0.03	

*Secondary furnaces; COD (Chemical Oxygen Demand)

9 Disposal of used lead batteries

The main objective of the environmental policy in the field of used lead batteries is to maximise the separate collection, reuse lead as valuable recoverable resource and to minimise disposal of used batteries as mixed municipal waste.

According to Article 14 of the EU Batteries Directive (2006/66/EC) [9] the European Member States shall prohibit the disposal in landfills or by incineration of waste industrial and automotive batteries and accumulators. However, residues of any batteries and accumulators that have undergone both treatment and recycling may be disposed of in landfills or by incineration.

From the above, it becomes clear that waste management such as landfilling and incineration cannot be considered as an environmentally sound management of used lead batteries, not only for economic reasons but also for health and environmental reasons.

However, there are cases in which the disposal is necessary, especially when no treatment and recycling facilities exist or the fractions got from dismantling of used batteries are not suitable for consequent recovery in the country which is not the European Member States.

"It is recommended to ban the disposal of used lead batteries or fractions of their dismantling. When no viable end market is available it should be permitted only in landfills or underground long-term storages that are designed and operated for disposal of hazardous wastes. Such landfills of underground storages must be authorised by national competent authorities.

It is recommended to ban the incineration of used lead batteries.

9.1. Landfills for hazardous wastes

Some wastes - unrecoverable wastes produced during the lead recycling process will not be recycled any further or reused and, therefore, will need a sound destination for disposal. It must be stressed that usually such wastes have lead contents as high as 2-5% and must be treated as hazardous wastes, even if the lead is not leachable, and thus requires a destination in a regulated hazardous waste landfill site. Stabilized slag from refining steps is the major hazardous waste formation from the whole process and the sodium slag arising from the utilization of sodium carbonate does not have any use due to its physical and chemical properties, and, therefore, it is being directed to hazardous waste landfills. There are other pollution sources produced during the treatment such as effluents and electrolytes that may be treated by sodium carbonate (Na_2CO_3) or calcium carbonate (CaCO_3), thus producing sodium sulfate (Na_2SO_4) or gypsum (CaSO_4) which, after removing lead sludges by filtration, can be further purified and sold to the cement industry or the building trade.

Thus, despite some cost increases in recycling, calcium slags have found some use as a raw material in cement production which has been employed in road building, bricks, etc., with promising results [1]. In such cases of production of hazardous waste the location of the landfill for hazardous wastes must be taken into account:

- a) secure distance from the boundary of the future landfill site to residential and recreation areas, waterways, water bodies and water sources,
- b) geological, hydrological, hydrogeological and mechanical-geological conditions in the vicinity,
- c) the protection of nature, landscape and cultural heritage in the vicinity,
- d) the acceptable burden on the territory,
- e) possible extreme meteorological effects and their impacts,
- f) conclusions from the environmental impact assessment study.



Fig. 33: Landfill foundation

The landfill site shall have:

- a) an information board,
- b) an approach road to the landfill and paved carriageways at the landfill site,
- c) a fence and lockable gates,
- d) a weighing-machine,
- e) operating premises containing all the necessary equipment,
- f) fire extinguisher,
- g) a sealing system,
- h) a drainage system with a leachate collection tank,
- i) a drainage system for landfill gas and an installation for its use or disposal, except for landfills for wastes where landfill gas is not likely to originate,
- j) a groundwater monitoring system,
- k) a landfill gas monitoring system, except for landfills for wastes where landfill gas is not likely to originate,
- l) a drainage system for surface water,
- m) an installation for cleaning vehicles,
- n) other installations necessary for operation of the landfill.

Any landfill must have a fence in order to prevent free access to the landfill. The gates must be locked outside operating hours. The system of control and access to the landfill must contain measures to prevent dumping of wastes at the landfill without a consent of the landfill operator. On landfills where an artificial sealing barrier is used, the geological substratum of the landfill, considering the morphology of the landfill, must be sufficiently stable to prevent settlement that may cause damage to the artificial bottom sailing.

During the operation of a landfill measures shall be taken to minimise effects of the landfill on the environment caused by emissions of odours and dust, wind-blown material, noise and traffic, birds, vermin and insects, formation of aerosols or fires.

The landfill must be equipped and operated in such a way that dirt from it, caused mainly by the vehicles/means of transport, is not dispersed onto public roads and the surrounding land.

At the landfill site waste shall be deposited in layers 0.3 to 0.5 m thick, which are then compacted; the working layer after compacting shall be no more than 2.0 m thick. Waste shall be compacted no later than the day following its dumping unless provided otherwise. The first layer of waste shall be deposited at the bottom of the landfill in such a way as not to damage the sealing and drainage systems of the landfill; the first layer of deposited waste may only be compacted if it is 2 m thick; the first layer may not contain waste which could damage the base of the landfill. There shall be a suitable peripheral drainage system of suitable dimensions for the drainage of surface water from the vicinity of the landfill.

Appropriate measures shall be taken at any landfill in order to control leachate and manage the leachate regime providing in particular for control of water from precipitations entering into the landfill body, prevention of surface water and groundwater from entering into the landfill waste, drainage and collection of leachate, the treatment of leachate collected from the landfill in order to comply with discharge values into the sewerage system or recipient or transport of the leachate to a suitable sewage treatment plant.

The emplacement of waste on the landfill site shall take place in such a way as to ensure stability of the waste deposited and associated structures of the landfill and the necessary construction equipment, particularly in respect of avoidance of slippages.

Landfill gas shall be collected from all landfills receiving biodegradable waste. The collected landfill gas must be treated and used to produce energy; if the landfill gas collected cannot be used to produce energy, it must be flared. The collection, treatment and use of landfill gas shall be carried on in a manner which minimises or does not have any negative effects on the environment and human health.

The operator of the landfill must provide the monitoring of:

- a) meteorological data (precipitation, temperature, wind, evaporation, humidity),
- b) emission data (amount and composition of leakage, emissions of gases),
- c) measurement of quality of underground water (pH, TOC, phenols, heavy metals, fluorides, hydrocarbons, etc.),
- d) topography of the landfill.

For monitoring groundwater quality in the vicinity of a landfill site, a sufficient number of measuring points must be constructed; there must be at least three, one in the groundwater inflow region and two in the outflow region. The original values of groundwater quality must be ascertained before commencement of landfill operations.



Fig. 34: Artificial geological barrier for landfill



Fig. 35: Artificial barrier using HDPE foil for landfill



Fig. 36: Foundation of landfill

9.2. The underground long-term storage for hazardous wastes

Hazardous wastes including used lead batteries can be stored in long-term underground storages as closed salt- or potash-mines in appropriate containers.

The very strict controls on the accepted types of waste are undertaken at the mine in drums or bulk containers. After verification the used lead batteries, if accepted by the mine, are loaded into transit capsules for transport underground.

Drums are then offloaded and stacked in their allocated safe storage areas to a maximum height determined by their contents. The location of each waste consignment is recorded for future reference. Once each disposal zone has been filled, walls (known as stoppings) are erected between the rock salt pillars to create physical barriers between storage zones. The operation of long-term storage must be held in that way that no harm for underground water or ambient air is ensured.

Usually underground mines undertake extensive research, establish detailed design and operational procedures and produce thorough qualitative and quantitative short and long-term risk assessments, all supported by complementary evidence.

Thanks to the geological and hydro-geological features that so effectively isolate the underground beds of rock salt from the biosphere, even in the worst case scenario the facility is likely to have “little or no adverse consequence” on the environment.

9.3. Accepting waste for disposal

Waste may only be accepted at a landfill or a long-term storage if the waste holder presents to the operator of the landfill or a long-term storage with each delivery of waste document on quantity and type of waste delivered, a consignment note and identification notes for hazardous wastes, details about the characteristics and composition of waste in the form of report on analytical control of wastes.



Fig. 37: Balancing of container at the acceptance of the waste for disposal

At the time of delivery of the verification of whether the required waste documentation is complete and correct, verification of the data, and other conditions agreed for waste acceptance, control of quantity of waste delivered, visual inspection of waste delivery in order to verify declared information concerning origin, characteristics and composition of waste, ensuring controlled random sampling of waste and tests and analyses of waste in order to verify given information about origin, characteristics and composition of waste and recording accepted waste must be done. The operator of the landfill or a long-term storage shall confirm the acceptance of the waste to the waste holder, indicating the date and time of its acceptance.

10 Transboundary movement of used lead batteries

The transboundary movement of used lead batteries is subject of the Basel Convention on the Control of Transboundary Movements of Hazardous Wastes and Their Disposal. The import and export are a matter of notification of state authorities of both exporting and importing parties according to the article 6 of the Convention.

Such notification shall contain the declarations and information specified in Annex V A, written in a language acceptable to the State of import. Every shipment must be accompanied by the documentation containing information defined in Annex V B of the Convention.

The used lead batteries are classified as “A1160 Waste lead-acid batteries, whole or crushed” with Y-code “Y31 Lead; lead compounds” and H-codes “H1 Explosives”, “H8 Corrosives” and “H11 Toxic”. Entry A1160 refers to “waste lead-acid batteries, whole or crushed”, while entry A1170 refers to “unsorted waste batteries excluding mixtures of only list B batteries and waste batteries not specified on list B containing Annex I constituents to an extent to render them hazardous”.

The mirror entry B1090 refers to “waste batteries conforming to a specification, excluding those made with lead, cadmium or mercury”. However, it can be assumed that all marketed battery systems contain at least one Annex I constituent, namely the electrolyte (which is either an acid Y34, alkali Y35, or a solvent Y42). Regardless of this classification, waste batteries are to be classified as hazardous waste in accordance with Article 1,1,b of the Convention anyhow. Therefore every transboundary transport of waste batteries is to be notified.

If the country of import is the EU Member State it is necessary to follow requirements of Regulation on shipment of waste [18]. The used lead batteries are defined as “A1160 Waste lead-acid batteries, whole or crushed” and only import for recovery is allowed, the import for disposal is allowed only the Community and its Member States, have concluded bilateral or multilateral agreements or arrangements with the country of export or in cases on exceptional grounds during situation of crisis, peacemaking, peacekeeping or war according to the Article 41 of the Regulation. The procedural requirements are described in Article 44 of the Regulation with the requirement of prior written notification in accordance with Article 4 of the Regulation and the conditions for shipment of the waste are given by Article 44 (4) of the Regulation.

To allow the Competent Authority a full evaluation of the foreign waste treatment or recycling process the notifier of the transboundary transport should at least provide the Competent Authority with the following (technical) information:

- Chemical composition of the wastes (data from literature, no chemical analysis required in the case of batteries).
- A technical description of the waste treatment / recycling process including a mass flow scheme.

- Information of the recovery (R-operation) or disposal (D-operation) of the output of the treatment / recovery process.
- Relevant information on the license (date of expire, licensed wastes).
- Information on emissions (reference to BAT, mandatory or plant specific emission limits, current measurements of the emission to air and/or water, type of applied emission abatement technique).
- Existence of a quality assurance system or an environmental performance assessment.

The Competent Authority shall scrutinize these documents and consent in the transboundary movement only if the environmentally sound treatment appears to be secured.

If the waste lead batteries are shipped into countries that signed international convention ADR [19] or RID [20] the requirements of the convention must be met.

For the transport of batteries and accumulators the European Agreement concerning the International Carriage of Dangerous Goods by Road (ADR) [19] has to be considered. This is an agreement that prescribes requirements for the transboundary transport of dangerous goods by road vehicles. The ADR specifies detailed requirements for the transport of the different battery types e.g. batteries, wet, filled with acids.

10.1. General requirements for “transport” / ADR

Requirements regarding the transport of lead-acid batteries from the Technical Guideline for the Environmentally Sound Management of Waste lead-acid Batteries [1] were summarised [4] as follows:

- Used batteries must be transported inside shock resistant and acid resistant sealed containers.
- In order to prevent move of containers during transport they must be well packed to the transport vehicle (i.e. they must be bound, shrink wrapped or stacked properly).
- The transport vehicle should be identified with symbols (transport of corrosive and hazardous products).
- The container shall be labelled with UN-Number 2794 BATTERIES, wet, filled with acid, electric storage, Class 8.
- A minimum set of specific equipment to combat spillage or leakage during transport must be available in the transport vehicle.
- Drivers and auxiliaries should be trained.
- Effective personal protection equipment is to be provided and available in the transport vehicle.
- Transport schedule and route is to be selected in a way that reduces the risk of possible accidents.

In principle the provisions of the ADR are applicable to the transport of waste batteries. However, according to Vol. II, clause 598 of the ADR ‘used storage batteries’ are not subject to requirements of ADR when:

- their cases are undamaged;
- they are secured in such a way that they cannot leak, slip, fall or be damaged, e.g. by stacking at pallets;
- there are no dangerous traces of alkalis or acids on the outside of the articles;
- they are protected against short circuiting.



Fig. 38: Examples of good packaging before transport, ABRI [26].



Black plastic wrap is not acceptable.

Fig. 39: Examples of bad packaging before transport, ABRI [26].

(Black plastic impedes inspection by the transport driver and facility staff, who will make a judgment on compliance with environmental and dangerous goods regulations, and this standard, based on observation. For example, any liquid on or leaking from the consignment could be deemed as leaking battery acid (electrolyte). Clear plastic wrap is the best option.) [26].

Polystyrene slip sheets are not acceptable

(Slip sheets must be used between the layers to minimise the potential for short circuit and post penetration. Heavy duty cardboard slip sheets are preferable to Masonite or chipboard because they are recyclable, and small spills can be absorbed and are visible. Polystyrene slip sheets are not to be used as they are difficult and costly to recycle (suppliers may incur an environmental disposal levy to cover the costs of disposing of any polystyrene received).) [26].



Fig. 40: Examples of bad packaging before transport, ABRI [26].

(There must be at least two vertical straps tying the load to the pallet)
(Batteries need to be wrapped as well as strapped)



Fig. 41: Examples of bad packaging before transport, ABRI [26].

(Broken pallets are unacceptable)
(The pallet load needs horizontal as well as vertical strapping)



Fig. 42: Bad and unacceptable examples of transport conditions

10.2. Special care for batteries and accumulators with a liquid electrolyte

Batteries and accumulators with free liquid electrolyte may cause specific damage during storage and transport. They shall be kept separately based on the nature of their electrolyte (acidic, alkaline or organic) and stored in tight, leak proof and stable containers. It is recommended to use UN-tested and correctly labelled containers even for intermediate storage to avoid extensive manipulation/repackaging when the batteries are shipped.

Lead acid batteries are listed under UN-Number 2794/Class 8, alkaline batteries under UN-Number 2795/Class 8.

Accumulators with an organic electrolyte until recently have not been in common use and therefore are not mentioned in the ADR.

Sealed batteries/accumulators (e.g. consumer batteries type AA, AAA, C, D) are normally not regarded as batteries with liquid electrolyte. However, sealed lead acid batteries should be regarded as accumulator with liquid electrolyte since the acid may leak out quite easily due to mechanical damage. It is therefore recommended to collect, store and transport seal lead acid batteries in the same way as normal lead acid batteries.

11 Potential Sources of Environmental Contamination

11.1. Battery Breaking Process

Each step of handling with used lead batteries is possible sources of contamination that may occur in the recovery processes. It is described shortly and should be understood as the predictable list of common contamination sources and where to look when searching for them. Specific sources of contamination will have to be determined in the light of the process employed.

The common sources of environmental impacts in the battery breaking process are then:

(a) spilling batteries - acid electrolyte and lead dust contamination source: battery spillage may be a very common source of environmental contamination as well as human health injuries since the electrolyte is not only a strongly corrosive solution but also a good carrier of soluble lead and lead particulates. Therefore, if this solution spills in an unprotected area, it may contaminate the soil or injure workers. Besides, after spilling on unprotected soil, the soil itself becomes a source of lead dust once the solution evaporates and the lead becomes incorporated into soil particles which may blow by wind or raised by vehicle transit;

(b) manual battery breaking – source of human health injury and environmental damage through heavy spillage and lead contaminated dust formation: manual breaking usually relies on primitive tools, poorly protected workers and no environmental protection whatsoever. The situation is even worst in the case of sealed batteries, which are not easily drained, increasing dramatically the risk of heavy spillage and damage to human health. Therefore, it should be avoided at all costs;

(c) mechanical battery breaking – source of lead particulate: the process of breaking batteries through crushing on hammer mills may spread lead particulate. However, the fact that the mill is sealed and uses copious quantities of water the formation of such particulates is prevented;

(d) hydraulic separations – contaminated water leakage: the hydraulic separations, both metallic from organic and heavy organics from light organics, are usually preformed inside sealed machines and

with a closed water system. However, if any water leakage occurs, it will be heavily contaminated by lead compounds;

(e) plastic and ebonite chips – contaminated wastes: ebonite scraps removed from the breaking process may pose a problem, since they are usually contaminated by levels as high as 5% (w/w) of lead. Therefore, it is important that the final traces of lead are removed by a second wash, preferably in an alkaline solution, followed by another rinse prior to further treatment or disposal [1].

11.2. Lead Reduction Process

The common sources of environmental impacts in the pyrometallurgical lead reduction process are:

(a) lead compounds derived from the breaking process – lead and lead compounds in dust and water: the separated and fine materials from the breaking process are usually wet, since the main processes of separation are based on water techniques. However, if they are not incorporated in a fully automated process, they will have to be transported from the breaking facility to the reduction facility and some muddy and/or watery material may spill and fall from the transport system. After drying, these materials become a powder and may contaminate the factory and its surroundings as fine lead dusts;

(b) drosses – lead contaminated materials: drosses are formed while the fusion process takes place. Its function is to remove materials that are not easily incorporated or wanted in the crude lead. However, these drosses still contain lead that can be recovered and are recycled in the fusion process. In order to accomplish these task, the drosses must be removed and transported to the furnace charging bay, but since they are usually a dusty material and occasionally powdery (copper dross), they may be a source of lead contamination while being transported;

(c) filters – lead contaminated dusts: furnaces need filters in order to capture lead dusts formed in the fusion process. After being used, they are usually recycled in the same smelting process since they may contain as much as 65% of lead. However, the care and maintenance of these filters may be an important source of contaminating dust, which could pose a risk to the human health and the environment. Besides, over-used filters no longer capture lead dusts as originally intended and the dust emissions from the fusion oven becomes an important source of contamination. Finally, one must also realize that the furnace inlet is itself a source of lead dust to the environment, since it can be an open system. The high temperature fume that leaves the furnace inlet and tapping area, for example, have a high lead content, and will be readily absorbed by the human body;

(d) sulphur dioxide (SO₂) emissions – the percentage of sulphur from a given amount of lead scrap load that leaves the reduction system as sulphur dioxide (SO₂) is highly dependent not only on the furnace conditions, but also in the kind of skim material being formed. As a general trend, this number may fall between 0% and 10% and it is significantly reduced if the flux used is a mixture of iron and sodium based compounds producing sodium skims and pyrites. Ebonite also has 6-10% of sulphur that may contribute to the SO₂ emission if it is added to the furnace charge;

(e) organic material combustion – tar formation: a well structured and controlled refinery does not need to worry about tar formation, since its reduction process consumes all organic materials. On the other hand, the less controlled the reduction process is, the greater are the tar emissions, especially in artisan foundries. If the reduction furnace has filters, the emission of tars is an even greater problem since they are very pyrogenic and may produce fires in the filtration plant, thus increasing the risk of an accident and the possibility of a rogue emission. The introduction of afterburners to complete the combustion of gases from the furnace is the usual solution to this problem, but a complete restructuring of the process, removal of organics for example, may present better perspectives;

(f) chlorine (Cl_2) and chlorine compounds emission: an initial separation of the materials allowed to enter the reduction process reduces the chlorine emission considerably. Cl_2 is source for PCDD/PCDF formation during lead smelting thermal process (see chapter 5.4). However, increasing amounts of PVC in the furnace increases the chances of chlorine emissions. The major part of it is absorbed by the basic skims of calcium or sodium, however some of the chlorine is chemically converted into lead chloride which is volatile under furnace conditions but captured by dust filters as the temperature decreases;

(g) slag production: this is the majority of the waste production during the reduction process. As an average picture, around 300-350kg of slag is produced for each ton of metallic lead, depending on specific factors of the process and the kind of residue being formed (calcium or sodium skims), and around 5% (w/w) of this slag is composed of lead compounds. Therefore, special consideration must be given to the leachate that may be produced if an unstable water soluble slag comes into contact with water or moist air. A purpose built under cover storage bay to store this material must be planned well in advance in order to avoid human health and environmental problems [1].

11.3. Lead Refining Process

The refining process can be a polluting process if some control measures are not taken. Some sources of environmental impacts in the lead refining process are:

(a) over heated lead – lead fumes: sometimes the lead from the reduction process is introduced directly into the refining kettle, which may be as hot as $1,000^\circ\text{C}$. Therefore, it is not uncommon that the lead refining process produces large amounts of lead vapour. Ideally lead should be tapped from the furnace directly into a lead bath or allowed to cool prior to pouring;

(b) sulphur dioxide (SO_2) emissions: the copper removal by addition of elementary sulphur may produce large quantities of sulphur dioxide (SO_2), since sulphur oxidizes readily in the presence of oxygen at the oven temperatures. The use of iron pyrites eliminates this problem;

(c) skim production and removal – metal contaminations: the skim production and removal from the refining kettle while refining unwanted metals from the crude lead may pose threats to the human health and environment due to the physical characteristics of the skims. Sometimes they are in the form of a very fine and dry dust with a high percentage of lead and other metals, it is important to provide adequate covered or sealed transport, storage and a sound destination to this potentially hazardous by-product;

(d) chlorine (Cl_2) tin (Sn) removal and recovery – chlorine gas release: If the tin is removed by chlorine gas for later recovery, then this is a very delicate procedure. The intake of gas is planned in order avoid chlorine release, i.e. the gas reacts with the tin before reaching the surface of molten lead. However, an uncontrolled addition of chlorine may release the poisonous gas to the environment. Besides, the storage and handling of chlorine is itself a delicate operation due to its corrosiveness and toxicity;

(e) oxygen (O_2) enriched air tin (Sn) removal – lead fume: while the air is being passed inside the molten metal, the nitrogen (N_2) present in the air does not react. The consequence of this is that the gas bubbles violently in the surface of the metals releasing dusts and metallic fume [1].

11.4. Bad examples of potential contamination of the environment



Fig. 43: Examples of bad used lead batteries management

Source: http://www.worstpolluted.org/projects_reports/display/78



Fig. 44: Examples of bad used lead batteries management

Source: <http://www.blacksmithinstitute.org/blog/?tag=ulab>



Fig. 45: Examples of bad used lead batteries management

Source: <http://www.blacksmithinstitute.org/blog/?tag=ulab>



Fig. 46: Examples of bad used lead batteries management

Source: ABRI, [26]

12 Economic aspects of environmentally sound management of used lead batteries

The project [2] proposes the application of extended producer responsibility as a system for financing the environmentally sound management of used lead batteries according to the model of EU stated in the Battery Directive [9]. The extended producer responsibility is based on the responsibility of producers / importers of batteries to establish and operate a system of separate collection, treatment and recovery of used batteries, which means also to finance the whole system. The producers can fulfil their obligations individually or collectively through a collective scheme.

Producers must cooperate with producers (holders) of used batteries, as services and maintenance facilities as well as with municipalities to provide for separate collection of used batteries in order to fulfil legal limits of collection, given usually as a percentage of amount put on the market. The industrial association or governmental authority (ministry, agency...) collects data on amount of batteries put on the market during the years by every producer / importer. Every producer / importer can calculate his market share that is a base for calculation of the collection share.

The producer / importer is also obliged to fulfil recycling and recovery limits. He must cooperate also with the facilities dealing with the treatment and recovery of used lead batteries in the country or abroad. If the price of the treatment of used batteries is minus the producer / importer must pay also the costs connected with treatment.

If the producer / importer fulfils his obligation individually he has to finance the separate collection of the amount of used batteries that is equivalent to his collection share. If the producer / importer joins the collective scheme then he pays to the system money equal to the amount of batteries that he put on the market and rate. The rate reflects real costs of separate collection, treatment and recovery of used batteries, as well as the costs of the information campaigns and the operation of the collective scheme itself.

However, obtaining secondary lead from used lead batteries is economically attractive, cutting about 25 % from the energy bill compared with mining primary lead. In addition, batteries are a ubiquitous product with a predictable lifetime, and the large market for recycled lead creates economies of scale. As a result, battery manufacturers rely heavily on secondary lead, most of it sourced from recycled batteries. Some of the lead recycled from batteries in the informal sector, however, does not re-enter the manufacturing sector but is used instead for other purposes, such as sinkers for fishing lines.

The costs of used lead batteries treatment and recovery vary according to the market situation. It is impossible to make estimation of the costs because prices in Europe are different from the prices in other regions.

The simplified scheme of waste, finance and information streams in used lead batteries EPR system is given in Figure 47.

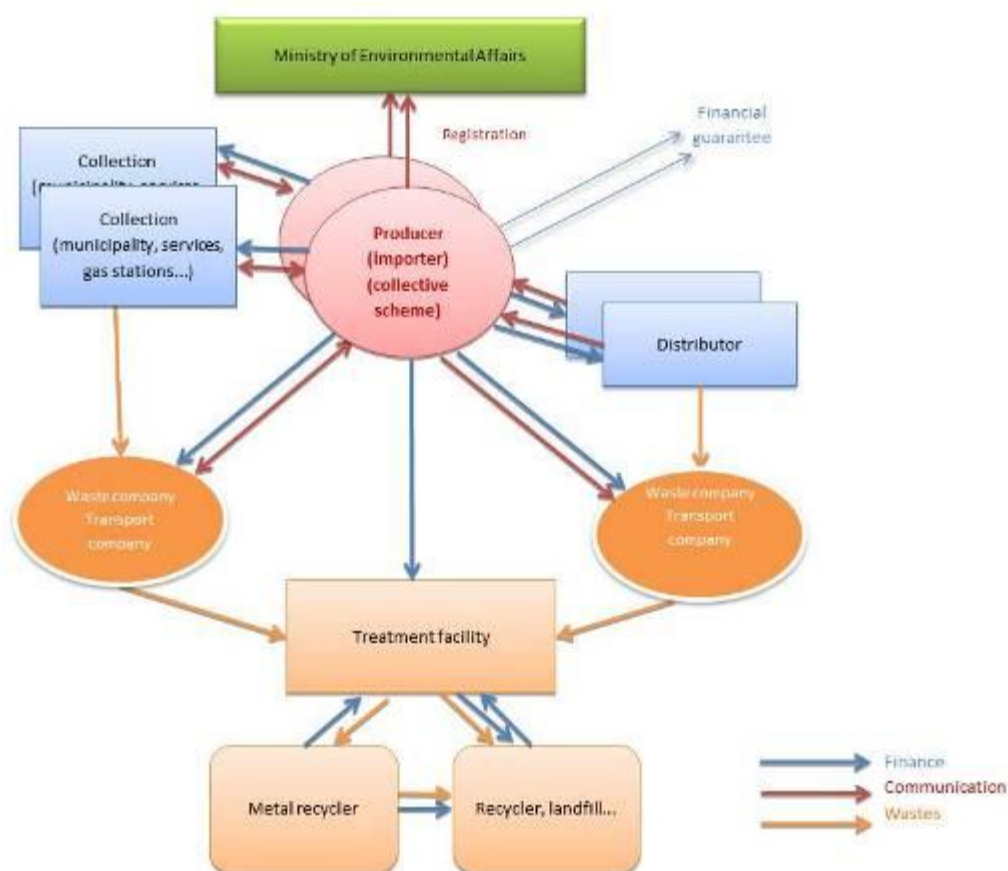

Fig. 47: Scheme of waste, finance and information streams in used lead batteries EPR system

Last but not least, it must be understood that the lead environmentally sound management process is deeply embedded in social and economic aspects that dictate several problems as well as several solutions not covered and which could not possibly be covered in this guideline. Therefore, a specific contextual map should be generated, encompassing local politics, economical aspects, social aspects, local and international market aspects, etc., and the lead recycling plant inserted into this context. No solutions or orientations given here should be taken for granted but, instead, analyzed under the lights of this contextual map and its possibilities.

13 Conclusions and recommendations

As the lead batteries are at once an important source of secondary lead and environmental danger it is necessary to operate efficient system for environmentally sound management of used lead batteries in the countries. The very effective model for used batteries is implemented in European Union based on extended producer responsibility. This model generalise sufficient financial sources that can cover all costs of separate collection, treatment and recycling of used lead batteries. This is the main assumption for building an effective system.

The first and the most important step of used lead batteries management is separate collection. It is obvious that throwing away the used lead batteries together with mixed household waste is wasting material resources and could lead to the potential burden of the environment and public health. It is

recommended to collect used batteries in places of their production, i.e. in services and maintenance operations. Effective system is mobile collection when mostly batteries from households and very small operations are collected. There are also other collection systems available for used batteries collection. The efficiency of secondary lead production is depended on the sorting and treatment of used lead batteries. It is recommended to operate treatment in the same facility and technology as recycling by metallurgical technologies but it is not the necessary condition. The treatment means dismantling of used lead batteries in order to get metals and other components. It is recommended to respect European standards for used lead batteries treatment given by BREF documents, mainly given by BREF on Non-Ferrous Metals [7]. European standards also cover the best available techniques for lead recycling.

Some wastes arisen during the processes of treatment and recycling cannot be recovered and they must be landfilled on special landfills for hazardous wastes. The technical and environmental conditions for landfilling of hazardous wastes are also introduced.

The necessary part of all steps of waste management is transport. As lead batteries (new or used) are hazardous and introduce danger especially for waters (surface or underground) special conditions for transport must be followed.

The system of environmental sound management of used lead batteries can be successfully implemented only when four conditions is met:

1. legislative rules are effective and applicable,
2. all or at least most of producers /importers of lead batteries are participating in the system,
3. facilities for lead recycling are available in appropriate distance (best of all in the country or in a not-very-far distance in neighbouring countries),
4. effective state control and supervision to prevent human health and environmental hazard together with good law enforcement.

14 Literature

- [1] Secretariat of the Basel Convention: Technical Guidelines for the Environmentally Sound Management of Waste Lead-acid Batteries. Basel Convention Series/SBC No. 2003/9, 2003, <http://archive.basel.int/pub/techguid/tech-wasteacid.pdf>
- [2] Secretariat of the Basel Convention: Environmentally Sound Management of Lead Batteries in Syrian Arab Republic: Proposals for policy reforms. Basel Convention, October 2011
- [3] <http://www.who.int>
- [4] http://batteryuniversity.com/learn/article/health_concerns
- [5] www.eurobat.org
- [6] Planet Ark Research Report: Lead acid battery use, disposal & recycling in Australia. Data provided by Australian Battery Recycling Initiative in 2010. Australia. (<http://recyclingweek.planetark.org/documents/doc-687-lab-report-2011-11-09-final.pdf>)
- [7] European Commission – European Integrated Pollution Prevention and Control Bureau: Draft Reference Document on Best Available Techniques for the Non-Ferrous Metals Industries. Draft3 February 2013. <http://eippcb.jrc.ec.europa.eu/reference/>
- [8] European Commission: Questions and answers on the batteries Directive. Commission Services Document - not legally binding, last updated in March 2011. Brussels. <http://ec.europa.eu/environment/waste/batteries/pdf/qa.pdf>
- [9] Directive 2006/66/EC of the European Parliament and of the Council of 6 September 2006 on batteries and accumulators and waste batteries and accumulators and repealing Directive 91/157/EEC
- [10] European Commission – European Integrated Pollution Prevention and Control Bureau: Reference Document on Best Available Techniques on Emissions from Storage. July 2006. <http://eippcb.jrc.ec.europa.eu/reference/>
- [11] European Commission – European Integrated Pollution Prevention and Control Bureau: Reference Document on Best Available Techniques in the Non Ferrous Metals Industries. December 2001. <http://eippcb.jrc.ec.europa.eu/reference/>
- [12] European Commission – European Integrated Pollution Prevention and Control Bureau: Best Available Techniques (BAT) Reference Document for Iron and Steel Production. Industrial Emissions Directive 2010/75/EU (Integrated Pollution Prevention and Control), adopted March 2012. <http://eippcb.jrc.ec.europa.eu/reference/>
- [13] European Commission – European Integrated Pollution Prevention and Control Bureau (2006b): Reference Document on Best Available Techniques for the Waste Treatment Industries. August 2006. <http://eippcb.jrc.ec.europa.eu/reference/>
- [14] European Commission – European Integrated Pollution Prevention and Control Bureau: Reference Document on Best Available Techniques in Smitheries and Foundries Industry. May 2005. <http://eippcb.jrc.ec.europa.eu/reference/>

- [15] ESWI - Expert Team to Support Waste Implementation: Study on the calculation of recycling efficiencies and implementation of export article (Art. 15) of the Batteries Directive 2006/66/EC. Study on behalf of the European Commission, Brussels, Final Report, May 2009
- [16] Slovák Ľ.: The present forms and methods of processing of portable batteries in the Slovak Republic. Havlík T., Demeter P. (editors): Recycling of Used Portable batteries and accumulators, Sklené Teplice 2009
- [17] www.geomat.sk
- [18] Regulation (EC) No 1013/2006 of the European Parliament and the Council of 14 June 2006 on shipment of waste
- [19] UNECE – United Nations Economic Commission for Europe: ADR - European Agreement concerning the International Carriage of Dangerous Goods by Road. Geneva, Switzerland.
<http://www.unece.org/fileadmin/DAM/trans/danger/publi/adr/adr2011/English/VolumeII.pdf>
- [20] Convention concerning International Carriage by Rail (COTIF) of 9 May 1980, as amended by the Vilnius Protocol of 3 June 1999
- [21] European Commission (2012): Batteries. Brussels.
<http://ec.europa.eu/environment/waste/batteries/index.htm>. accessed June 2012
- [22] UNECE – United Nations Economic Commission for Europe (2001): UN Recommendations on the Transport of Dangerous Goods - Model Regulations. Geneva, Switzerland.
http://www.unece.org/trans/danger/publi/unrec/12_e.html
- [23] <http://www.lead-battery-recycling.com/Used-battery-recycling.html>
- [24] Secretariat of the Stockholm Convention on Persistent Organic Pollutants: Guidelines on best available techniques and provisional guidance on best environmental practices relevant to Article 5 and Annex C of the Stockholm Convention on Persistent Organic Pollutants, in the metallurgical industry . Stockholm Convention, May 2007, Geneva, Switzerland.
<http://chm.pops.int/Implementation/BATBEP/Guidelines>
- [25] Brian Wilson - ILMC, Implementing Regional ULAB Recycling Strategies for Central America, Venezuela, Colombia and the Caribbean, Impacts and Consequences, San Salvador, El Salvador, May 2013, <http://www.itu.int/en/ITU-T/climatechange/201303/Pages/default.aspx>
- [26] Packaging standard for used lead acid batteries (ULAB), ABRI, Australian Battery Recycling,
<http://www.batteryrecycling.org.au/home>
- [27] <http://www.indsolint.com/index.php?id=nonferrous>
- [28] http://en.wikipedia.org/wiki/Reverberatory_furnace
- [29] http://en.wikipedia.org/wiki/Blast_furnace
- [30] http://en.wikipedia.org/wiki/Rotary_kiln

[http://en.wikipedia.org/wiki/ISASMELT#The ISASMELT.E2.84.A2 Furnace](http://en.wikipedia.org/wiki/ISASMELT#The_ISASMELT.E2.84.A2_Furnace)

Annex IV

Guide for environmental sound management of PCBs in the Mediterranean

Table of contents

Note by the Secretariat

1.	Introduction	9
1.1	Polychlorinated Biphenyls (PCBs)	9
1.2	Basel Convention	9
1.3	Stockholm Convention	10
1.3.1	PCBs Elimination Network (PEN)	11
1.3.2	Handling of PCBs Regulated in the Stockholm Convention	11
1.4	Rotterdam Convention (PIC Convention)	11
1.5	UNEP/MAP-Barcelona Convention and its Protocols	12
2.	Data collection, Identification, Sampling and Monitoring	13
2.1	Data collection and Inventory	13
2.2	PCB Applications	15
2.2	Periodic Examinations and Maintenance of PCB Containing Devices	16
2.2.1	Sampling of Transformers, Capacitors and Construction Materials	16
2.2.2	General Sampling Procedures	18
2.2.3	Sampling of Transformers	19
2.2.4	Sampling of Phased Out and Drained Transformers	20
2.2.6	Sampling of Concrete and Brick Walls	23
2.2.7	Sampling of Soil	25
2.3	Screening Test Kits and Laboratory Analysis	26
2.3.1	Analysis by Gas Chromatography (GC)	29
2.3.2	Analysis Proceedings	30
2.4	Database	31
2.5	Labelling of Checked Equipment	32
2.6	Site Monitoring	33
2.6.1	Land Register of Areas and Storage Facilities with Possible PCB Contamination or contaminated equipment	34
2.6.2	Risk Assessment	34
2.6.3	Analysis	34
2.6.4	Extent of Contamination	35
3.	PCB Management of Closed Applications	36
3.1	PCB Management Plan	36
3.1.1	Designation of a PCB Responsible	36
3.1.2	Training and Instruction of Staff	36
3.1.3	Inventory	36
3.1.4	Database on Locations with PCB Equipment, Waste or Contamination	36
3.1.5	Maintenance Plan	36
3.1.6	PCB Spill Prevention, Control and Countermeasure Plan (SPCC Plan)	36
3.1.7	Disposal and Site Decontamination Plan	37
3.2	Spill Prevention, Control and Countermeasure Plan (SPCC Plan)	37
3.2.1	Prevention	37
3.2.2	Spill Prevention Tools	37
3.2.3	Countermeasure	38
3.3	Priorities for Disposal and Site Decontamination	38
4.1	Maintenance of In-Service PCB Equipment	38
4.2	Best Working Practices	40
4.3	Inspection of PCB Containing Transformers	40
4.3.1	Visual Checks	40
4.3.2	Leaks of Transformers	41
4.3.3	Oil Level of Transformers	42
4.3.4	Temperature Gauge	42

4.3.5 Pressure-Vacuum Gauge	42
4.3.6 Corrosion on Tank and Radiator Fins	42
4.3.7 Performance Tests	42
4.4 Evaluation of PCB Containing Capacitors	42
4.5 Substitute Fluids.....	43
5. Safety	45
5.1 Safety and Personal Protective Equipment	45
6. Emergency Actions and Clean Up	48
6.1 Emergency Actions for Cold Incidents	48
6.2 Emergency Actions for Hot Incidents	49
6.2.1 Incident Caused by an Internal Failure.....	49
6.2.2 Fires	50
6.3 First Aid in Case of Contact with PCB	51
6.4 Clean Up after Incidents.....	51
6.4.1 Assessment of an Incident	51
6.4.2 Decontamination Methods	52
6.4.3 Protection of Workers and the Environment	53
6.4.4 Disposal	53
6.5 Check of Clean Up (Monitoring)	53
6.5.1 Tolerable Remaining Contamination after a Clean-up	53
7. Phase Out.....	54
7.1 Phase Out of Transformers	54
7.2 Phase Out of Capacitors	55
7.2.1 Preparation	55
7.2.2 Dismantling	56
7.2.3 Phase Out of Other Equipment	56
8. Packing	57
8.1 Packing According to ADR	57
8.2 Summary of Possible Containers for PCB Transports	58
8.2.1 Labelling of the Packaging	62
8.2.2 Labelling for Storage or Transport	62
8.3 Handling of Packed Waste	64
9. Temporary Storage	65
9.1 Temporary Storage - On Site	65
9.2 Central Storage Platform	66
9.3 Authorization and Control	71
10.1 International Regulations for the Transport of Hazardous Goods	72
10.2.2 Documentation	73
10.3 National Transports	74
10.4 Transboundary Movement of Hazardous Waste	74
10.5 Loading and Safety Check before Transport Takes Place	75
10.5.1 Loading on a Truck for Local Transports	75
10.5.2 Loading of Containers for International Transport	75
10.6 Waste Transportation by Air	77
11. Pre-treatment, Treatment and Disposal	78
11.1 Technologies and Methods in General	78
12. Annexes	81
12. 1 In-Depth Information on the Internet: Conventions and Guidance Documents	81
12.3 PCB Pre-Treatment Technologies (Extract only)	84
12.4 PCB Non-Combustion Technologies	84
12.5 PCB Combustion Technologies.....	87
12.6 PCB Emerging Technologies	87

12.7 PCB Treatment and PCB Disposal Companies	87
12.8 Emergency Response Plan for Cold Incidents	88
12.10 Best Working Practices	90
12.11 PCB Instructions for Workers	91
12.12 First Aid in Case of Contact with PCBs	92
12.13 Guidelines for the Inspection of Sites and the Sampling of Transformers and Capacitors (two persons)	92
12.14 Draft Inventory Questionnaires	93
12.14.1 Preliminary Inventory Form used in the Regional Pilot Project	96
12.15 Example of a Possible Register	98
12.16 PCB Equipment Monthly Maintenance Plan	99
12.17 PCB Interim Storage Facility Monthly Inspection Report	100
12.19 Dangerous Good Declaration and Container Packing Certificate	102
12.20 Application Form for Membership in the PEN	103

Abbreviations and Definition of Terms

AC	Alternating Current
ADR	European agreement on the international road transport for hazardous goods
Askarel	Trade name of PCB cooling fluid (USA, Monsanto)
BAT	Best Available Technique
BC	Basel Convention on the trans-boundary movement of hazardous wastes and their disposal
BCD	<u>Base catalysed decomposition</u>
BEP	Best Environmental Practice
BRS	Basel, Rotterdam, Stockholm Convention (Secretariat)
CaO	Calcium oxide
Capacitor	Equipment or unit to supply lagging kilovars for power factor correction of an electric system; some capacitors were manufactured with PCB as cooling fluid
Capacitor Bank (General)	Practically there are three different ways of power factor (PF) correction: Capacitors for "individual" PF-correction; the capacitor is directly connected to the terminals of an equipment (motors, welding machine etc.) producing the "lagging kilovars"
Capacitor Bank (LV)	Capacitors for "group" PF- correction; the capacitor(s) is (are) connected to the LV-busbar of a transformer station, which feeds a number of consumers with individual motors, welding machines etc.
Capacitor Bank (MV)	Capacitors for "central" PF-correction; Large capacitor installation connected to the Middle- or High Voltage busbars of a substation where many individual electrical appliances (motors etc.) of various size operate at different times and periods.
CHD	<u>Catalytic hydrodechlorination</u>
Closed Systems	Capacitors and transformers, where the PCB itself is in completely closed containers; PCBs rarely emit from closed systems (in good condition)
Congener	Depending on the number and position of the chlorine atoms in the Biphenyl molecule, 209 isomers and homologue Chlorine Biphenyls are theoretically possible. A single compound from this group is called PCB congener.
Container 20'	Internationally used expression for Transport or Storage Containers with the Standard size of 2 x 2 x6 meters (40' Container – 2 x 2 x 12 meters)
Container Box	There are various types of 20' and 40' Containers available, the most common is the Box Container with a front door, from an open top Container the roof can be removed for loading and off-loading activities (e.g. ideal for transformers)
Cooling Fluid	Dielectric fluid
COP	Conference of the Parties
DC	Direct Current
DDT	Dichlorodiphenyltrichloroethane
DE	Destruction efficiency
DRE	Destruction and removal efficiency
e.g.	Exempli gratia / for example
ESM	Environmentally Sound Management
ETI	Environmental Technology International Ltd. / Switzerland
EU	European Union
FAO	Food and Agriculture Organization of the United Nations
GC	Gas chromatography; Procedure for the determination of evaporating substances

GEF	The Global Environment Facility (GEF) is an international financial entity with 177 countries as members
GHS	Globally harmonized system of classification and labelling of chemicals
GPCR	<u>Gas-phase chemical reduction</u>
GTO	Gate turn-off thyristor
HV	High voltage
IATA DGR	IATA regulations on the transport of dangerous goods / transport by air
IBC	Intermediate Bulk Container
ID (number)	Identification (number)
IGBT	Insulated-gate bipolar transistor
IMDG	International maritime dangerous goods code / transport by sea
ISO	International Organization for Standardization
kV	Kilovolts
kVA	Kilovolt ampere
kVAR	Kilovolt ampere reactive
kW	Kilowatt
LBS	Land based sources and activities Protocol
LV	Low voltage (230/400 V)
MAP MEDPOL	Programme for the Assessment and Control of Marine Pollution in the Mediterranean
µg	Microgram
mg/kg	Milligram per kilogram
MS	Mass spectrometry
MV	Medium voltage (Normally in the range between 11 and 66kV)
MVA	Megavolt ampere
ng	Nanogram (1000 ng = 1 µg)
NGO	Non-governmental organization
Open Systems	Applications where PCB is consumed during its use or not disposed of properly after its use or after the use of the products that contain PCB; Open systems emit PCB directly in the environment (e.g. softeners in PVC, neoprene and other rubbers containing chloride)
PBB	Polybrominated Biphenyls
PCB	Polychlorinated Biphenyls
PCDD	Dibenzo-p-dioxins or dioxin; Highly toxic by-product of PCB
PCDF	Dibenzofurans or furan; Highly toxic by-product of PCB
PCT	Polychlorinated Triphenyls
PE	Polyethylene
PE-HD	High-density polyethylene
PE-LD	Low-density polyethylene
PEN	PCB Elimination Network of UNEP Chemicals
Persistent	Very slightly degradable in the environment
PIC	Prior Informed Consent

POP	Persistent Organic Pollutants
PPE	Personal Protective Equipment
ppb	Parts per billion
ppm	Parts per million (mg/kg)
Primary source	A product to which PCB was added voluntarily to influence the product's characteristics (e.g. cooling fluids for transformers like Sovol, Sovtol, Askarel, Pyralene, Clophen, etc.); Such products emit PCB continuously
RC	Rotterdam Convention on the Prior Informed Consent Procedure (PIC) for certain hazardous chemicals and pesticides in international trade
RID	Regulation for the international transport of hazardous goods / transport by rail
SAP-MED	Strategic Action Programme to address pollution from land-based activities in the Mediterranean Region
SBC	Secretariat of Basel Convention
SC	Stockholm Convention Persistent Organic Pollutants (POPs)
SCWO	<u>Supercritical water oxidation</u>
Secondary source	A product that originally was free of PCB, but later contaminated by PCB emitting from primary sources (e.g. by emission from primary sources or use of contaminated pumps, hoses, etc.) Such products also emit PCB
SNV	Swiss Association for Standardization
SPCC	Spill Prevention, Control and Countermeasure
TDI	Tolerable daily intake
TEQ	Toxic equivalency factor
Transformer	Equipment used to increase or reduce voltage; PCB containing transformers are usually installed in sites or buildings where electricity is distributed.
TTCB	Tri-tetrachlorobenzenes
UN-approved	Equipment that fulfils the specific United Nations testing procedures
UNDP	United Nations Development Programme
UNEP	United Nations Environment Programme
UNIDO	United Nations Industrial Development Organization
UNITAR	United Nations Institute for Training and Research
US EPA	United States Environmental Protection Agency
WHO	World Health Organisation

Note by the Secretariat

This Guide has been prepared in the framework of the MedPartnership project and MAP Programme of work 2014-2015. The purpose of this Guide is to provide technical guidance on different aspects of PCB life cycle environmental sound management (ESM) including inventory and monitoring until their final phasing out and disposal.

The Guide was reviewed and agreed at a Regional Expert meeting organized by the MEDPOL Programme, with experts nominated by the Contracting Parties, which was held from 7-9 April 2015 in Istanbul, Turkey.

The present document is proposed to be reviewed and approved as appropriate by the MED POL focal point meeting to serve as a technical guidance to enhance the application of ESM of PCB at company level and in conformity with the relevant national legislation.

1. Introduction

1.1 Polychlorinated Biphenyls (PCBs)

Persistent Organic Pollutants (POPs) have been identified by the international community for immediate international action by means of the Stockholm Convention. The pesticide DDT, highly toxic Dioxins and Furans (unintentionally formed by-products as a result of incomplete combustion or chemical reactions) as well as PCBs count among the POPs.

PCBs have serious health and environmental effects, which can include carcinogenicity, reproductive impairment, immune system changes, and effects on wildlife causing a loss of biological diversity (Carpenter 2006, Hotchkiss et al. 2008, Wirgin et al. 2011). PCBs bio-accumulate in the fatty tissue of humans and other living organisms. The chemical is transported over long distances to regions where it has never been used or produced before. This process of evaporation, movement with the air streams, condensation and deposition on the ground is known as the “grasshopper effect”.

PCB production started in 1929. PCBs were manufactured by a number of companies in many industrialised countries, and maximum production was reached in the late 1960s. After 1983 production was stopped in most countries, except for some Eastern European countries and Russia, where manufacture ceased between 1987 and 1993.

PCBs were mostly used in closed applications for example as cooling and isolating agents in transformers and capacitors, in heat transfer systems and hydraulic systems, in particular in mining equipment. PCBs mixtures were, however, also widely used in open and partially open applications, for example in caulks/sealants, paints, anti-corrosion coatings, surface coatings, cables and cable sheaths, small capacitors, etc.

From the technical point of view, the characteristics of PCBs were quite advantageous, thus they found a wide range of applications as mentioned above.

The Stockholm Convention on Persistent Organic Pollutants (POPs) counts PCBs among the substances targeted for worldwide elimination. The existing PCBs and all equipment contaminated with PCBs have to be eliminated in an environmentally sound manner without producing hazards for humans or the environment by 2028. PCB treatment or disposal technology must comply with the highest safety and environmental standards and must be capable of reducing the PCB contamination level of those pieces of equipment suitable for re-classification below the legally permitted level of 50 ppm as well as assure that the PCB level remains below that limit.

Other global and regional conventions regulate the management of dangerous chemicals and hazardous wastes addressing PCB such as the Basel Convention, as well as the Rotterdam Convention. In addition the Barcelona Convention for the Protection of the Marine Environment and the Coastal Region of the Mediterranean and its related Protocols (Land-based Sources and Activities Protocol, and the Hazardous Waste Protocol) also addresses the PCB phase out and disposal.

1.2 Basel Convention

In 1989, the Basel Convention was adopted to improve monitoring of the transboundary movements of hazardous wastes.

The Basel Convention has the following key objectives:

- To reduce transboundary movements of hazardous wastes to a minimum consistent with their environmentally sound management
- To dispose of hazardous wastes as closely as possible to their source of generation
- To minimize the generation of hazardous wastes in terms of quantity and hazardousness

- Prohibition of an export of hazardous waste to developing countries that do not have suitable disposal technologies

The Basel Convention has set up a very strict operational control system based on the prior written notification procedure. The procedure for the notification of transboundary movements of hazardous wastes or other wastes can take place only upon prior written notification to the competent authorities of states of export, import and transit (if appropriate) and upon consent from these authorities permitting the transboundary movement of waste. Any transboundary movement of hazardous wastes or other wastes carried out in contravention of notification system is considered illegal traffic.

1.3 Stockholm Convention

This Convention regulates the prohibition of - so far - 23 toxic chemicals called the POPs (Persistent Organic Pollutants).

The text of the Stockholm Convention on Persistent Organic Pollutants was adopted on 22 May 2001 and entered into force on 17 May 2004; 90 days after the 50th member country had ratified it.

The initial twelve POPs are Aldrin, Chlordane, DDT, Dieldrin, Endrin, Heptachlor, Hexachloro-benzene, Mirex, Toxaphene, Polychlorinated Biphenyls (PCBs) as well as Dioxins and Furans (unintentionally formed by-products as a result of incomplete combustion or chemical reactions).

At its fourth meeting held from 4 to 8 May 2009, the Conference of the Parties (COP) adopted amendments to Annexes A (elimination), B (restriction) and C (unintentional production) of the Stockholm Convention to list nine additional chemicals as persistent organic pollutants: Chlordecone, Hexabromobiphenyl, Lindane, Alpha Hexachlorocyclohexane and Beta Hexachlorocyclohexane, Tetrabromodiphenyl ether and Pentabromodiphenyl ether, Hexabromodiphenyl ether and Heptabromodiphenyl ether, Perfluorooctane Sulfonic Acid, its salts and Perfluorooctane Sulfonyl Fluoride, Pentachlorobenzene. These amendments entered into force on 26 August 2010.

During the fifth meeting of the Conference of the Parties in April 2011, the Parties agreed to list Endosulfan in Annex A to the Convention, with specific exemptions. One year later, Endosulfan became the 22nd POP.

Finally, at its sixth meeting held from 28 April to 10 May 2013, the Conference of the Parties adopted an amendment to Annex A to list Hexabromocyclododecane with specific exemptions (decision SC-6/13). On 26 November 2014, one year after notification, the amendment listing HBCD in Annex A to the Stockholm Convention entered into force for most parties.

The contracted parties to the Stockholm Convention must take the following measures:

- Production, use, import, and export of the 23 most dangerous POPs shall be eliminated or restricted. For DDT a special regulation has been stipulated, as this product is used in developing countries to fight malaria
- When constructing new plants/installations measures shall be taken to minimize a possible production of POPs
- Stockpiles and wastes that are contaminated with POPs shall be recorded in an inventory and disposed of in an environmentally sound manner
- The use of devices containing PCB is still permitted until 2025, under the condition that certain safety precautions and conditions are fulfilled
- By the year 2028, however, all PCB equipment shall be disposed of in an environmentally sound manner

1.3.1 PCBs Elimination Network (PEN)

The PCBs Elimination Network (PEN) was launched at the simultaneous extraordinary meetings of the Conferences of the Parties to the Basel, Rotterdam and Stockholm Conventions in **Bali on 22 February 2010**. The PEN has been established as an arrangement for information exchange on the promotion of the cost-effective completion of the environmentally sound management (ESM) of liquids and equipment containing or contaminated with PCBs. The PEN is designed as an equal partnership for stakeholders from different sectors with an interest in the ESM of PCBs to interact within a voluntary framework to undertake the following:

- Promote ESM of PCBs and its equipment
- Foster cooperation
- Promote technical assistance and technology-transfer
- Provide and facilitate information exchange
- Raise awareness
- Encourage development and adoption of environmentally sound techniques and practices to eliminate PCBs
- Establish linkages between stakeholders

The PEN is an arrangement built on the platform of the clearinghouse mechanism, providing support to developing country Parties and Parties with economies in transition to reach the goals of the Stockholm Convention in relation to PCBs. The PEN shall implement its work on information exchange being mindful of the obligations of the Basel Convention on the transboundary movement of hazardous waste and its disposal and of the Rotterdam Convention on the prior informed consent procedure for certain hazardous chemicals and pesticides in international trade. The application form for becoming a member of the PCBs Elimination Network (PEN) is attached in Annex 12.200.

1.3.2 Handling of PCBs Regulated in the Stockholm Convention

It is forbidden:

- To produce, import and trade PCBs
- To re-use and process PCB waste
- To re-fill PCB equipment

Legal and physical entities that possess PCBs, used PCBs and PCB equipment are obliged to report the quantity, origin, nature and content of PCBs, used PCBs and PCB containing/contaminated equipment to the responsible government agency/body for the professional activities in the field of environment not later than one year after the Convention enters into force. Entities are obliged to properly label the equipment. Legal and physical entities handling PCBs, used PCBs and PCB equipment are obliged to keep records in accordance with the convention.

1.4 Rotterdam Convention (PIC Convention)

Toxic pesticides and other hazardous chemicals kill or seriously sicken thousands of people every year. They also poison the natural environment and damage many wild animal species. Governments started to address this problem in the 1980s by establishing a voluntary Prior Informed Consent procedure. PIC required exporters trading in a list of hazardous substances to obtain the prior informed consent of importers before proceeding with the trade.

In 1998, governments decided to strengthen the procedure by adopting the Rotterdam Convention, which makes PIC legally binding. The Convention establishes a first line of defence by giving importing countries the tools and information they need to identify potential hazards and exclude chemicals they

cannot manage safely. If a country agrees to import chemicals, the Convention promotes their safe use through labelling standards, technical assistance, and other forms of support. It also ensures that exporters comply with the requirements. The Rotterdam Convention entered into force on 24 February 2004. The contracting parties take measures to:

- Establish an official notification procedure i.e. to inform the importing country that an export of a chemical figuring on the PIC list will take place before the first shipment
- Inform the importing country that an export of a chemical that is banned or severely restricted for use within its territory will take place before the first shipment
- Inform other countries of each national ban or severe restriction of a chemical

1.5 UNEP/MAP-Barcelona Convention and its Protocols

The UNEP/MAP-Barcelona Convention for the Protection of the Marine Environment and the Coastal Region of the Mediterranean was adopted in 1995 thus amending the Barcelona Convention on the protection of the Mediterranean sea against pollution adopted in 1976 by the Mediterranean coastal states and European Union. The Barcelona Convention operates in the framework of the Mediterranean Action Plan adopted and amended respectively in 1975 and 1995. The Secretariat is provided by UNEP through the UNEP/MAP Coordinating Unit located in Athens, Greece.

The Barcelona Convention is associated by seven important protocols out of which two address different aspects of POPs management namely the Land based sources and activities Protocol, 1996 (LBS Protocol) and the Protocol on the trans-boundary movement of hazardous waste in the Mediterranean, 1996.

The LBS Protocol provides for the contracting parties to take legally binding measures to phase out a number of substances including PCB and their stocks in synergy with the work and commitments taken under the Stockholm Convention.

UNEP/MAP- Barcelona Convention is supporting the Contracting Parties to implement the SAP-MED (Strategic Action Programme to address pollution from land-based activities in the Mediterranean Region) and associated National Action Plans adopted in accordance with Land Based Sources and Activities Protocol of the Barcelona Convention which provide for a number of regional targets by 2025 related to hazardous waste and POPs ESM including phasing out and disposal.

The Strategic Partnership for the Mediterranean Sea Large Marine Ecosystem (MedPartnership) is a collective effort of leading environmental institutions and organizations together with countries sharing the Mediterranean Sea to address the main environmental challenges that Mediterranean marine and coastal ecosystems face. The project is led by UNEP/MAP and is financially supported by the Global Environment Facility (GEF) and other donors, including the European Commission and all participating countries. Within the framework of the project, UNEP/MAP, through its MEDPOL programme, aims to support countries in the implementation of the SAP-MED. The project is supporting the EMS disposal of up to 870 tons PCB as well as undertaking important capacity building activities in four Mediterranean countries, including the preparation of EMS Guidelines for PCB.

The proposed Guide on PCB ESM is prepared with the technical support of Urs K. Wagner (ETI Umwelttechnik AG, Chur/Switzerland).

2. Data collection, Identification, Sampling and Monitoring

2.1 Data collection and Inventory

The inventory is the initial stage in the management of PCB contaminated equipment and it should be generated in the most ecological way. Implementing the following general activities will support a reliable PCB data collection:

- Assessment of the national PCB situation
- Legal assessment of national regulations
- Identification of possible stakeholders
- Awareness raising workshops for possible stakeholders, capacity building
- Preliminary inventory
- Public information
- Adaptation of national regulations
- Information of the identified stakeholders
- Detailed inventory (physical inspection, sampling, analysis, database)
- Infrastructure (handling, transport, interim storage, disposal)

The aim of the inventory is to identify, quantify and keep records of the equipment and the materials prone to containing or being contaminated with PCBs. These bits of information are indispensable when preparing a plan for PCB management, which should encompass the entire cycle of these products, as follows:

- Usage
- Management
- Storage
- Decontamination
- Elimination

Table 16: Potential holders of PCB

Electric Utilities	Maintenance Companies
Industrial Facilities	Hospitals
Railroad Systems	Research Laboratories
Mining Industry	Manufacturing Plants
Army Installations	Waste Water Discharge Facilities
Residential or Commercial Buildings	Car Service Stations
Holiday Resorts / Hotels	Small/Medium sized Co.
School Buildings	Airports
Cold Storage Depots	Wood Processing Co.
Suppliers	Disposal & Recycling Companies

The sites with possibly PCB containing equipment shall be inspected by field teams or engineers of the authorised body in the field of environmental protection. During the inspection the particulars given in the questionnaires shall be checked and further data regarding the particular type of PCB equipment or PCB waste collected and recorded, for example *kVA rating, brand name, fluid quantity, type of fluid, location of the device, serial number, PCB concentration, year of manufacture, and weight*. During the visit, the site shall also be checked for visual contamination. An inventory is always a chance for preventive maintenance.

The following data need to be collected and recorded when compiling the PCB inventory:

In-service transformers

- | | |
|--------------------------------------|-----------------------------------------------------|
| ➤ kVA rating | ➤ PCB concentration (not for refilled transformers) |
| ➤ Brand name | ➤ Year of manufacture |
| ➤ Fluid quantity | ➤ Weight of the transformer |
| ➤ Type of fluid (brand of the fluid) | ➤ Status/owner |
| ➤ Location of transformer producer | |
| ➤ Number | |

Out of service transformer

- | | |
|----------------------------------------|-----------------------------------------------------|
| ➤ kVA rating (transformer capacity) | ➤ PCB concentration (not for refilled transformers) |
| ➤ Brand name | ➤ Year of manufacture |
| ➤ Fluid quantity | ➤ Weight of the transformer |
| ➤ Location of the transformer producer | ➤ Status/owner |
| ➤ Number | |

In-service capacitors

- | | |
|--------------------------------------|---------------------------|
| ➤ kVAR rating | ➤ Year of manufacture |
| ➤ Brand name | ➤ Weight of the capacitor |
| ➤ Location of the capacitor producer | ➤ Status/owner |
| ➤ Number | |

Out of service capacitors

- | | |
|--------------------------------------|---------------------------|
| ➤ kVAR rating | ➤ Number |
| ➤ Brand name | ➤ Year of manufacture |
| ➤ Location of the capacitor producer | ➤ Weight of the capacitor |
| ➤ Status/owner | |

Bulk storage tanks, drums and containers

- | | |
|------------|---------------------|
| ➤ Type | ➤ Fluid quantity |
| ➤ Location | ➤ PCB concentration |
| ➤ Weight | ➤ Status/owner |

In order to facilitate the inspection, country-tailored inventory forms shall be developed which include all data necessary for the determination of the parameters needed for the evaluation of the risk associated with the PCB equipment and waste.

Also, ID numbers shall be determined for each piece of potentially contaminated equipment and waste. Each owner of potentially PCB contained equipment should affix the ID number to it and fill in the inventory form. If conclusion about PCB presence cannot be made based on the available data, then equipment has to be sampled. The data entry for status can include codes for leaking, stable, packed etc., which can be found at the transformer nameplate.

Not only the PCB content of transformers in use has to be checked, but also the contamination of devices out of use or in reserve. Rigorous examinations must include spare oils and other equipment that could contain PCBs (capacitors, voltage regulators²⁷, circuit breakers, heat exchangers, oil cisterns, pipe systems, etc.). Only equipment exceeding the capacity of one litre must be declared. All transformers have to be sampled even if they are of recent date of manufacture because a later unintended contamination of the transformer could have occurred (see also chapter 2.4). If a device cannot be sampled for technical reasons (e.g. capacitor), it has to be regarded as containing PCB until the sampling performed at the time of the phase out proves the opposite.

²⁷ Voltage regulators are devices similar to transformers and have an iron core and windings used to boost up the voltage in long overhead power lines (the American -English name for a voltage regulator is booster). A rectifier is a device to change Alternating Current (AC) to Direct Current (DC). In use are semiconductors as Thyristors, GTO's IGBT's to "rectify" the AC. These electronic devices do not contain PCB.

2.2 PCB Applications

Closed, partially open and open applications of PCBs are presented in the tables below.

Table 17: Closed Applications of PCBs

Insulation and/or cooling fluid in transformers
Dielectric fluid in capacitors
Hydraulic fluid in lifting equipment, trucks and high pressure pumps (mining industry especially)

Table 18: Partially Open Applications of PCBs

Vacuum pumps
Switches
Voltage regulators
Liquid filled electrical cables
Liquid filled circuit breakers
Heat transfer fluids
Hydraulic fluids

Table 19: Open Applications of PCBs

Caulks/sealants (buildings)
Paints and plaster
Anti-corrosion coatings (indoors and outdoors)
Surface coatings (e.g. floors)
Cables and cable sheaths
Sealed double glazing windows
Lubricating fluid in oils and grease; cutting oils
PCBs as flame retardant and impregnating agent (e.g. indoor wood sealing for panels and floor finishers)
Adhesives
Carbonless copy paper
Inks
etc.

The Chemical lifecycle of POPs and specifically PCB shall always be considered.

Chart 1: Chemical lifecycle of PCBs

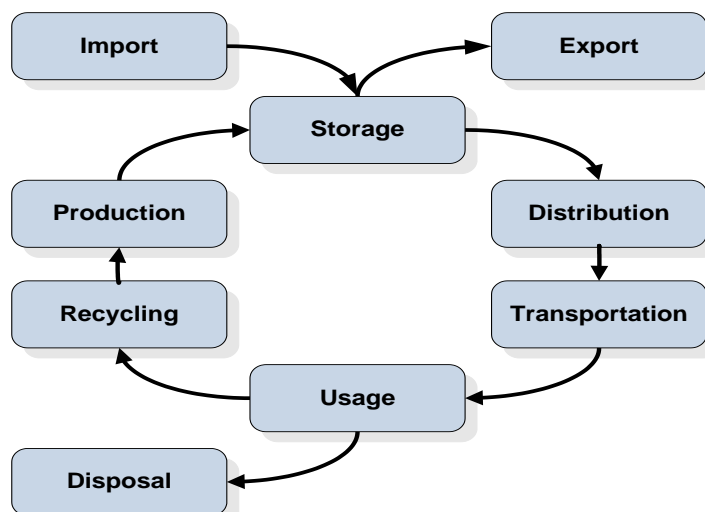

2.2 Periodic Examinations and Maintenance of PCB Containing Devices

Devices containing PCB are subject to regular periodic checks. These examinations mainly consist of checking the parameters from a technological and production aspect (e.g. technical characteristics, electric permeability of insulating materials, losses).

Due to possibility of contamination of the environment, additional inspections are needed with devices identified as PCB-containing. These inspections are mainly from the aspect of leakage of contaminating insulating oils. Thus, the following inspections should be added to the warrant for regular inspections (if not already envisaged from another aspect):

- Inspection of all sealing elements of the device
(the check consists of a visual inspection if some element leaks)
- Inspection whether any of the elements containing insulating oil is oxidized (corroded)
(this check is performed visually, because devices containing insulating oil are painted regularly due to easier dissipation of heat)
- Inspection for deformations of the housing of the device (hermetically sealed capacitors often “puffed up”)

If any of the above damages are confirmed, then a proposed intervention procedure follows:

- The bolts are re-tightened. If this does not stop the leakage, then a part of the insulating oil is drained “under the level of the edger” and the sealer is switched.
- The oxidized surface is cleaned from the oxide with a steel brush and sanding paper to reach metal shine. Afterwards, the spot is degreased with solvents, and the metal is checked for punctures and leakage with absorbing paper (filter paper or common paper handkerchief will also do the job). Even if there is no leakage, the spot is impregnated with means for neutralizing the iron oxide (“Antirost” or similar) and at the end are painted with basic and covering paint as the other part of the transformer. If even smallest leakage is noticed, the element (i.e. the radiator) must be demounted and welded, replaced if possible or the transformer should be taken to an industrial reparation. If the element is a condenser, it is discarded and replaced with a new one.
- The capacitor is discarded and replaced with a new one.

ADVICE: ALL THESE INTERVENTIONS ARE TO BE PERFORMED BY SKILLED AND AUTHORISED SERVICE ONLY.

2.2.1 Sampling of Transformers, Capacitors and Construction Materials

It is advisable to prepare a sampling box that contains basic equipment for sampling activities. This ensures access to essential equipment immediately when required.

Picture 1: Inside view with possible equipment I



Picture 2: Consider also electric safety precautions

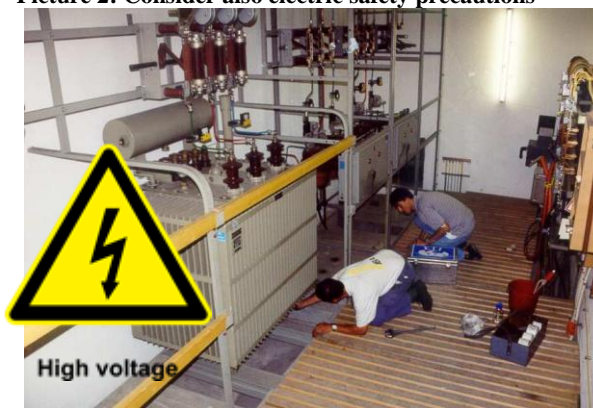

Normally glass bottles are used for liquid samples and glass or plastic containers for solids. However if a high PCB content is expected (e.g. in case of pure PCB) glass bottles must always be chosen, because PCB can diffuse through plastic containers.

Sampling containers must be absolutely clean. Whenever sampling containers are transported over long distances, demands on the glass quality (unbreakable) obviously increase.

When preparing the sampling box, the intended minimum number of samples has to be considered. This depends on the kind of PCB analysis and possible further analyses (e.g. oil quality in case of negative PCB result).

Table 20: Minimum sample quantities and sampling containers

Method	Matrix	Quantity	Container
Clor-N-Oil	Oil	10 ml	➤ 20 ml glass vial (white lid)
Clor-N-Soil	Solids (e.g. soil, concrete dust, etc.)	10 g	➤ 60 ml glass vial (white lid) ➤ 250 ml PE-HD container (plastic, white with blue lid)
L 2000 DX	Oil	10 ml	➤ 20 ml glass vial (white lid) ➤ 30 ml glass bottle Hexavis (brown with black lid)
L 2000 DX	Solids (e.g. soil, concrete dust, etc.)	Minimum 10 g, if possible more	➤ 60 ml glass vial (white lid) ➤ 250 ml PE-HD container (plastic, white with blue lid)
GC (lab)	Oil	20 ml	➤ 20 ml to ½ litre bottles
GC (lab)	Solids (e.g. soil, concrete dust, etc.)	10 g	➤ 60 ml glass vial (white lid) ➤ 250 ml PE-HD container (plastic, white with blue lid)

Please consider that the above-mentioned quantities are minimum figures. It is advisable to always take more sampling material e.g. to fill a 250 ml PE-HD container with soil. For drill samples minimum quantities are acceptable because of the often difficult sampling procedures.

To determine the quality of a transformer's cooling fluid at the same time, sample at least 500 ml of the oil. It should be filled in a 500 ml glass bottle (with blue lid). There are various manufacturers of quality glass bottles as e.g. Schott, Duran or Simax.

Picture 3: Glass vial



Picture 4: 30 ml Glass bottle Hexavis



Picture 5: 500ml Glass bottle Duran



Picture 6: 60 ml Glass Vial

Picture 7: 250 ml PE-HD Cont.

Picture 8: 750 ml PE-HD Cont.



2.2.2 General Sampling Procedures

The main source of error is the sampling process itself. Therefore the following points must be particularly considered:

Risk of Cross Contamination

Contamination is easily spread from one sample to another. When using one-way material (e.g. Kleenex, pipettes, metal scoops, etc.) it must be ensured that a new product is used for every new sample. If this is not possible, the used equipment must always be cleaned before another sample is taken. If possible, solvents (e.g. technical acetone) should be used for cleaning purposes.

Confusion of Samples

In order to prevent a confusion of samples, it is crucial to clearly mark the sample containers immediately after the sample has been taken. The identical data must also be recorded in a sampling report. A label must be affixed to the sampling containers.

Picture 9: Taking all records of sampled electr. devices



Picture 10: Labelling BEFORE Sampling



Sampling Reports:

The sampling report must be filled in immediately. If it is completed at a later stage, important information could be lost or forgotten.

Sampling forms must be used to record the data required for evaluation and interpretation, for quality assurance and to ensure comparability with other assessment observation.

As opposed to laboratory procedures, no standard procedure for the performance of sampling can be given, since both the circumstances and the potential problems encountered are manifold. The ISO (ISO 2002c) recommends that quality assurance be performed according to the principles of the ISO 9000 standard (SNV 1999). An adequate standard of quality demands the application of quality assurance methods. Quality assurance involves strategies for the reduction of errors in sampling and sample treatment from the planning to the operational stage, by making the procedural steps readily

comprehensible and retraceable (ISO 9000). Quality assurance also obliges those performing the sampling activities to uphold the necessary standards during their task and on all sites.

2.2.3 Sampling of Transformers

In order to prevent skin from getting into contact with PCBs, one-way protective gloves must be worn. Eyes must be protected against possible oil splashes by wearing goggles.

The sample can be taken by using the drain tap, which usually is at the bottom of the transformer. If a transformer has been disconnected from power for over 72 hours the sample should generally be taken from the bottom, as PCB sinks to the lower level because of its higher density. Sometimes the gasket gets damaged when the drain tap is opened. It is therefore advisable to always have a spare gasket ready.

Alternatively, transformers can be sampled via the oil filling cap by using a hand pump (consider: a new hand pump must be used for each transformer). Oil samples from the expansion receptacle cannot always be regarded as representative, because the oil does not circulate and thus it is not really mixed.

Often, transformers are sampled when they are in use. Appropriate protective measures and safety regulations by responsible Electricians must be known and considered at any time!

If only the PCB content of the oil is analysed, 20 ml glass vials can be used provided analysis is performed on site. If the analysis is performed elsewhere and the samples have to be transported over long distances, 30 ml glass bottles should be used as sample containers because they are more robust. If a holder of a transformer also wants to have the quality of the oil tested, a 500 ml glass bottle should be used.

If a PCB inventory demands an analysis of the cooling fluid, the owner has the possibility to test the oil quality at the same time. This is dependent on the age and condition of the equipment. Such a preventive maintenance allows an assessment of the technical condition of the transformer and thus helps prevent possible damages/failures resulting from e.g. acidity or increased dampness.

Oil quality analyses must only be run after negative PCB result; otherwise the laboratory equipment will be contaminated with PCB.

The following steps must be followed when sampling a transformer:

- Place a drip tray under the drain tap,
- Label the sample bottle with the same serial number as on the inventory form,
- Drain off the required oil into the glass vial - quantity depending on screening/analysis
- Carefully retighten the seal.
- Then affix a label on the transformer with the same serial number as on the inventory form and the glass vial. The label usually contains the Identification number and Date of sampling

Step-by-step Sampling of a Transformer





Sample the oil (30-50ml for PCB screening, 1l if also oil quality is tested)



Affix sampling label on transformer (after cleaning the surface)



Record sample in sampling report, affix sampling label to report

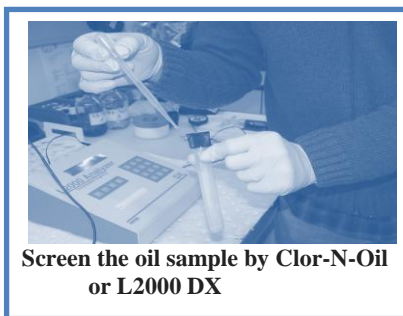

Screen the oil sample by Clor-N-Oil or L2000 DX



If the **oil quality** shall also be tested, the following steps have to be considered:

- Sampling via drain tap: Drain off 1 to 2 litres of oil first in order to clean the drain from particles which might have accumulated in that area,
- Amount of oil required: 0.5 to 1 litres,
- Leave the oil for 24 hours, in order to allow particles and water to settle,
- Take sample from the upper third of the oil for the analysis using a pipette, and
- Return the drained 1 to 2 litres of oil back into the transformer (only if the oil filling cap is out of reach of the high voltage, otherwise shut off the transformer before refilling the drained oil)

All wastes must be disposed of in an environmentally sound manner – the disposal method always depends on the analysis result.

Remark: Sampling is also an opportunity to collect useful information for the database.

2.2.4 Sampling of Phased Out and Drained Transformers

Often transformers have already been phased out, temporarily stored and drained at the time a PCB inventory is compiled. In such cases, it needs to be decided on site, how the sampling shall be performed.

Even if a device has been drained, there should still be some oil present in the passive part of the transformer due to the leaching in the days and weeks after the draining. Depending on the size of the transformer, the leaching from the solid parts of the device (wood, insulation paper, etc.) can leave a few litres of oil at the bottom of the transformer. However, usually there is not enough oil to sample it via the drain tap, as the oil layer is deeper than the valve.

In such cases, the device needs to be sampled through an opening in the top. Stiff tubes (e.g. glass or PE) can be used to take a sample of the oil at the bottom of the transformer.

The PCB results obtained from drained transformers could be higher than the original contamination in the transformer. This is due to the leaching effect from the core and windings into only a limited volume of oil.

If there is no oil at all left in the device, solid materials from the active part of the transformer could be sampled and analyzed (wood or insulation paper). However, such analysis can only be performed in a laboratory by gas chromatography.

Due to practical reasons it might be advisable to label such drained transformers as PCB-contaminated and note it accordingly in the physical site inspection report (respectively inventory form) and leave it for future investigations.

Picture 11: Sampling of oil drums



Picture 12: Affix labels while sampling and later final one



2.2.5 Sampling of Capacitors

Power capacitors are built into hermetically closed containers and there is no direct access to the cooling liquid.

In many cases, the manufacturer provided information about the type of dielectric liquid, either with identification on the nameplate or with a separate tag confirming that the contents are harmful for the environment. Such capacitors do not need further investigation. They definitely contain PCBs and must be treated accordingly.

Picture 13: Identification of Capacitor Fluid



Picture 14: Tag Information on Capacitor

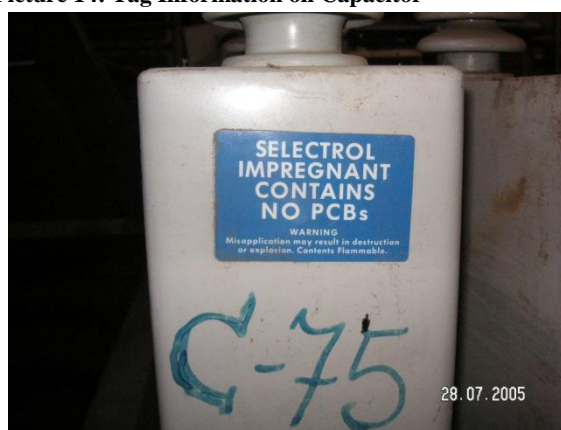

If a designation is missing and relevant information from the manufacturer is not available, the only way to test the dielectric liquid is to drill a hole in the casing on the top or cut the isolator and retrieve an oil sample. This can be done by (e.g.) using a pipette (using only once).

After having opened the capacitor, it is damaged and unusable and thus must be stored in appropriate containers (e.g. in an UN-approved steel drum).

Thus only phased out capacitors can undergo this procedure. Capacitors still in service and manufactured before 1993, with missing information about the dielectric liquid have to be labelled as PCB suspected equipment (see chapter 2.5).

If there is a series of the same capacitors, it is usually sufficient to sample only two devices out of the series. Preferably a mixed sample originating from the two capacitors with the lowest serial numbers should be analysed. Caution should be taken if the analysis reveals PCB, even if it is only a slight contamination. Such contamination could have been caused during the production e.g. when using the same pumps for mineral oil and PCB oil. In such cases, all capacitors of one series must be analytically tested.

Personal Protective Equipment (PPE)

The PPE for these activities consist of protective gloves and goggles. Respiratory protection is not necessary when taking single samples. If several samplings are taken within short intervals light respiratory protection is recommended.

Sampling of Small Sized Capacitors

Usually capacitors of a smaller size do not contain PCB as a floating liquid in the casing, but rather as an impregnating agent of the insulation layers in the capacitor. It is therefore not possible to drill a hole in the casing and take an oil sample with a pipette.

Prepare the working place with an oil carpet and a tray (metal if available). The personal protective equipment comprises gloves, safety goggles and in case of poor ventilation a respiratory mask. Firstly, a circle has to be cut around the top end of the capacitor casing near the contacts using a small iron saw. Once the top has been lifted, it is usually possible to pull out the active part (caps don't have windings as such). With a tool remove about 1 cm³ of the insulation and conductor layers and place them in a 60 ml glass vial. The samples can then be prepared in the laboratory and analysed by gas chromatography. All tools and materials that came in contact with the capacitors have to be cleaned e.g. with acetone, or be disposed of as hazardous waste.





Picture 15: Small sized capacitors



Picture 16: Sampling of small sized capacitors



Step-by-step identification of PCB Capacitors

<p>Step 1 – Year of Manufacture:</p>	<p>Check nameplate for year of manufacture. If the capacitor was manufactured in or after 19**²⁸ → “PCB free”</p> <p>There is no SC or global regulatory policy on a deadline. The decision is based from where electrical devices were imported and experience data. Therefore it may vary from country to country, in many Countries the deadline is set on 1993</p> <p><i>** Final Year and/or additional text to be provided by the countries.</i></p>	
<p>Step 2 – Declaration:</p>	<p>Check nameplate for declaration “PCB” or “PCB trade name”, e.g. <i>Aroclor, Askarel, Clophen, Delor, Elaol, Fenclor, No Flamol Phenoclor, Pyralene, Pyranol, Sovol, etc.</i> → “PCB containing”</p>	
<p>Step 3 – Capacitor Lists:</p>	<p>Compare nameplate/serial number with capacitor lists. Many devices can be identified or categorised according to information in capacitor lists. → “PCB free or PCB suspect”</p>	
<p>Step 4 – Sampling/Analysis:</p>	<p>If capacitor cannot be identified according to Steps 1-3 above, it must be sampled and analysed according to the procedure with transformers. Alternatively, the capacitor can be regarded as PCB containing. Please see the appropriate Factsheets.</p>	

2.2.6 Sampling of Concrete and Brick Walls

A cordless drill can be used for taking samples. Drills (bits) with a diameter of 20 mm to 22 mm should be used to drill holes in the PCB suspected areas. The collected concrete dust from the drilling activity forms the sample for the analysis.

Safety Precautions

The drilling procedure produces dust that must be regarded as contaminated. Consequently the safety precautions during the sampling must be followed strictly and it is essential to wear:

- Leather and/or Nitrile gloves,
- Safety goggles,
- Respiratory mask with a filter for organic vapours and dusts,
- Ear protection while drilling.

²⁸ It is recommended to choose the year of manufacturing of the capacitors in line with national legislation. In case a reference year is missing in national legislation, it is recommended to use 1993 as reference year.

If samples are taken from a brick wall, cross contamination must be avoided by taking steps such as covering the floor with plastic liner or industrial carpet. These materials have also to be disposed of as hazardous waste.

Defining the Extent of the Contaminated Area

When confronted with a spill the first step is a visual inspection of the site. In most cases, the oily parts can be distinguished visually. The extent of the contamination should be investigated and the source of spill traced.

These first impressions must be verified by a few well-chosen samples. The first sample will be taken from the estimated centre, to determine whether the spill contains PCB. If the first sample indicates that PCB is present, the next samples will be taken in order to delineate the contaminated area. Not only is the size of the contamination on the surface important, but also it is essential to know the depth of penetration into the material. The limit for a sample to be considered as contaminated is 50 mg/kg (ppm), thus all samples below 50 mg/kg (ppm) can be regarded as PCB free.

In order to save costs, a strategy should be prepared to delineate the contaminated area with a small number of samples. This can be done in many ways. The appropriate strategy will be determined by the specific situation. A chosen strategy can be adapted or optimized by considering the results of an on-site analysis of the samples. An example of a visible contamination is shown in Picture 17 and Picture 18. If a rather large area can be assumed as being PCB-free, there is a way to reduce the expenditures for sampling by collecting mixed samples to verify this. Instead of taking a number of «single» samples and analysing them separately, one sample with an equal mixture from several sampling spots can be analysed in one go. If the result turns out to be well below the limit of 50 mg/kg, it can be assumed that all spots are PCB free. If the result shows a contamination around 50 mg/kg or more, the source of the contamination has to be located by further single samples.

Picture 17: Proposal strategy - horizontally

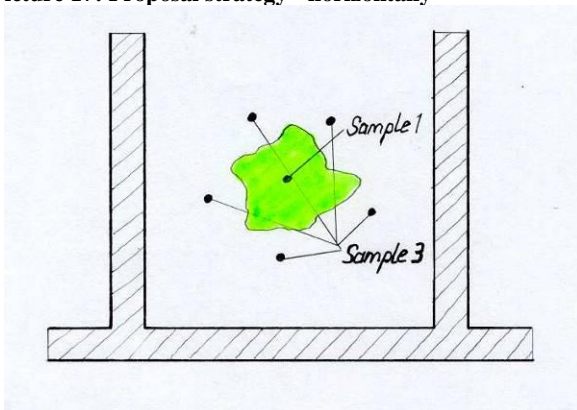

Picture 18: Proposal strategy - vertically

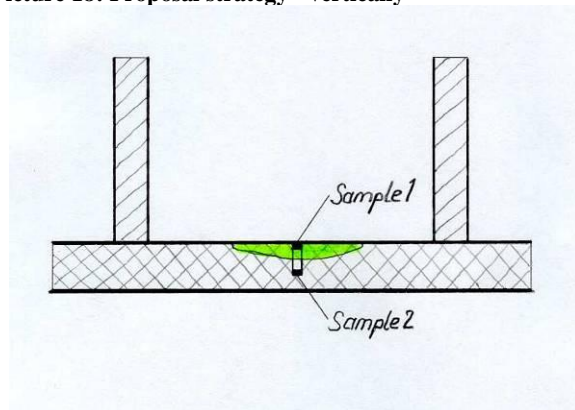

If the extent of the contamination is not visible a site specific strategy for the problem has to be applied. The area, where a contamination cannot be excluded, could be subdivided into a grid with equal parts with collection of a (mixed) sample in each field.

Sampling

After preparing a sampling strategy and considering the safety precautions mentioned above, the drilling can be executed. The sampling report must be filled in correctly and the sample containers marked accordingly.

Before drilling, the auger has to be cleaned e.g. with acetone, in order to prevent any contamination from former drillings.

For field analysis purposes, 10 grams of concrete or brick dust are needed, though it is advisable to take more so that the results can be double checked or verified by gas chromatography. Consider that it has to be assumed that the contamination varies with the depth of the drilled hole.

Therefore it is advisable to drill no deeper than 1.5 cm within one sample. If the necessary amount of dust cannot be obtained from this hole it is recommended to drill another one right next to it, instead of drilling deeper.

The drill dust can be collected by using a poly spoon (Picture 19) and put into the sample container. After the sampling any remaining dust has to be collected with a brush and a weighing dish and disposed of as hazardous waste. Materials that came in contact with the soil/dust have to be cleaned with acetone or disposed of as hazardous waste.

Picture 19: Sampling of concrete



Picture 20: Cleaning of leftover dust



Sampling a brick wall requires the assistance of another person who collects the drilling dust with an appropriate dish.

Sampling in Depths

Depending on the chosen strategy to define the extent of the contamination, the limits of the contamination in depth have to be verified by taking samples.

Below an explanation of the proceedings for a sampling in depths is given for an assumed depth of contaminant penetration of 10 cm:

Firstly: the area is covered with an oil pad (approx. 30 x 30 cm, with a hole in the middle of around the size of the drill bit). Secondly: a hole with a depth of 10 cm is drilled, the dust collected and the hole cleaned. Then the oil pad is removed and disposed of as hazardous waste including the dust. The spot is then covered with a new oil pad as previously described and sticky tape is placed over the hole to facilitate the dust collecting. The drilling is continued to the required depth for the sample. The collected dust should not get in contact with the contaminated surface, otherwise or the sample will be a mixture and indicate wrong results. Finally the oil pad is removed and disposed of as hazardous waste.

2.2.7 Sampling of Soil

During the sampling it is recommended to wear:

- Disposable gloves (Nitrile or Vinyl).

If a site is heavily contaminated, the wearing of the following is recommended:

- Respiratory mask with a filter for organic vapours and dusts,
- Tyvek overall and boots.

The defining of the extent of the contaminated area works along the same principles as with the sampling of concrete and brick walls (see previous chapter). With regard to soil samples, the choice of where to take the sample has an influence on the results obtained.

Suspected contaminated areas are sites where either transformers containing PCB, contaminated transformers and/or capacitors containing PCB are or were installed or stored. In some cases oil-stains resulting from leakage or improper storage are even visible. The soil or gravel in such areas needs special attention.

If there are no visible stains in the mentioned areas, mixed samples must be taken directly from the surface. A strategy to delineate the contaminated area should be prepared (see also sampling of concrete or walls). The samples from the surface are taken with a clean poly spoon. After the exercise the spoon must be cleaned with solvents (acetone) to prevent any possible cross contamination.

Picture 21: Sampling on surface



Picture 22: Sampling in depth (Excavation slot)



The sampling report²⁹ has to be filled in correctly and the sample container has to be marked accordingly. Glass vials or PE-HD plastic containers should be used.

Big stones are not appropriate for an analysis as the extraction solution to extract the PCBs for the analysis does not deeply penetrate stone. Material with small sized gravel or sand should be preferred.

Cross contamination must be avoided in any case. After use the scoop and all other items, which were in direct contact with the soil, have to be cleaned with acetone or disposed of as hazardous waste.

Sampling of soil and groundwater is to be carried out according to protocols, whose detailed description is beyond the scope of this guide.

2.3 Screening Test Kits and Laboratory Analysis

PCB analysis can be divided into two categories: *Specific and non-specific methods*.

Specific methods include gas chromatography (GC) and mass spectrometry (MS) which analyse for particular PCB molecules.

Non-specific methods identify classes of compounds such as chlorinated hydrocarbons, to which PCBs belong. These non-specific methods include PCB field screening tests like CLOR-N-OIL and CLOR-N-SOIL test kits as well as the L2000 DX field Analyzer.

In general, PCB specific methods are more accurate than non-specific methods but they are more expensive, take longer to run, qualified staff is needed, and they cannot be used on site.

Two non-specific tests are below described that are however **ABSOLUTELY NOT** recommended to be used due to uncertainties in results and high potential of polluting water and air!

²⁹ The sampling report format could be used on the base of the PCB Inventory Form according to the "Regulation on criteria and conditions for handling, storage and disposal of PCBs"

Density Tests

The easiest way to verify whether or not oil contains heavy concentrations of PCBs is a simple density test: □ Use a 10 ml glass vial □ pour some water into the vial □ add some dielectric liquid. If the oil layer is at the bottom of the vial the density of the oil is > 1 . In such a case there is no doubt that the PCB concentration is rather high. If the oil layer remains on top of the water layer; it can be assumed that it is a mineral oil with a density of < 1 .

Picture 23: Density Test with oil in water on a scrap yard



Picture 24: The same method in an oil laboratory



However, a density test only remains an emergency method in order to identify a pure PCB source. It cannot be recommended as a reliable tool for inventory purposes, as contaminated oil cannot be detected. Furthermore, there is a high risk of water/sewage contamination by hydrocarbons due to non-environmental conform disposal.

Beilstein Method

A piece of copper oxide fastened to a platinum wire is moistened with the oil to be tested and held in the outer zone of a Bunsen flame. As soon as the carbon has burned away, the presence of chlorine is indicated by the greenish or greenish-blue colour of the flame. This colour is produced by volatilizing copper chloride and its intensity and duration depends on the amount of chlorine present.

This test may only be performed in a laboratory by chemists in appropriate lab-chapels and/or ventilated rooms. There is a risk that highly toxic dioxins are unintentionally formed and released.



Generally, both the Density test and the Beilstein method may only be used as an emergency method, or in case of severe lack of resources and under certain circumstances.

Chlorine Detection Test Kits

There are a variety of different brands of chlorine detection test kits available:

- Immunoassay technology ENVIROGARD by Millipore;
- CLOR-N-OIL and CLOR-N-SOIL by Dexsil. The Dexsil test generally distinguishes between the PCB test kits for oil (e.g. CLOR-N-OIL) and for soils (e.g. CLOR-N-SOIL).

Picture 25: CLOR-N-OIL



Picture 26: CLOR-N-OIL 50 ppm

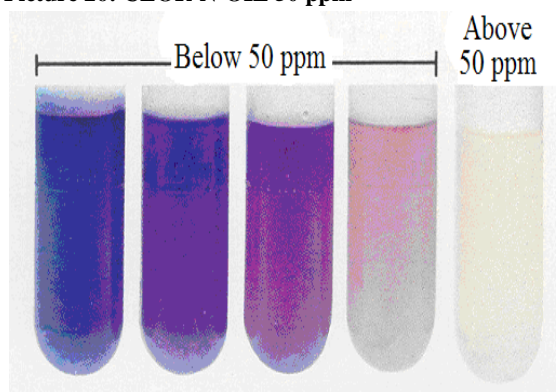

Both Dexasil tests rely on the same principle: The chlorine atoms are chemically stripped away from the PCBs, the total chlorine concentration is determined and indicated by a colorimetric reaction. Three different test levels are available: **20 ppm**, **50 ppm** and **500 ppm**. Each kit is used in the same way. The end point for each has been adjusted so that it changes color at the required level. The kit is a «GO / NO GO» type of test where the result is either positive or negative.

More information and links regarding test kits and their applications can be found in Annex12.1.

Instrumental Detection of the Chlorine Concentration

Instrumental detections of the chlorine concentration are methods that use instruments or analyzers to determine the chlorine concentration in the samples.

The L2000DX relies on the same basic chemistry as the CLOR-N-OIL test kits, however instead of a colorimetric reaction; the L2000DX uses an ion specific electrode to quantify the contamination in the sample. Sample analysis is available for transformer oils, soils, water and surface wipes. The usable measurement range for oils and soils is 2 to 2'000 ppm, 20 ppb to 2'000 ppm for water and 2 to 2'000 ug/100 cm² for wipe samples.

The L2000DX Analyzer is pre-programmed with conversion factors for all major Aroclors and most chlorinated pesticides and solvents. The built-in methods include corrections for extraction efficiencies, dilution factors and blank contributions.

Picture 27: L2000 PCB / Chloride Analyzer



Picture 28: L2000 in use







The L2000DX can be used in the field or laboratory by non-technical personnel. An oil sample requires about five minutes to run while water, soil and surface tests take about ten minutes each. This eliminates the need to wait days or even weeks for laboratory results. Crews working at a site can take immediate action to secure equipment, isolate a site, or remove contaminated soil.

Instrument calibration is required at the beginning of each day (takes about 2 minutes). After calibrating, a reagent blank is tested to ensure the analysis is being run properly and to provide a baseline for accurate low-level results.

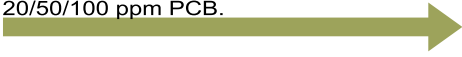
Blank subtraction can be incorporated into the method and is automatically updated upon calibration. The preparation steps involve extracting the chlorinated organics from the soil, water or wipe material, (not required for PCB in transformer oil), and reacting the sample with a sodium reagent to transform the chlorinated organics into chloride. The resulting chloride is quantified by the L2000DX Analyzer. Several samples can be prepared concurrently, than analyzed in less than a minute per sample. One operator can complete about 65 oil tests, or 45 soil or surface wipe tests in an eight hour day.

Table 21: Advantages and disadvantages of field screening tests

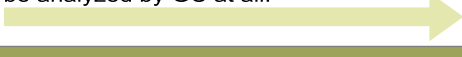
Field Screening Tests	
Advantages	Disadvantages
<p><u>Time:</u> Within minutes one has proof whether the sample contains > or < than 20/50/100 ppm PCB.</p> 	<p>Can provide false-positive results (but never false-negative)</p> 
<p><u>Easy to use:</u> The tests follow a simple procedure anyone can perform in the field or lab.</p> 	
<p><u>Inexpensive:</u> A PCB determination by test kits is less expensive than analysis in the laboratory.</p> 	
<p><u>Economical:</u> Many samples need not to be analyzed by GC at all.</p> 	

Regarding waste generated during the sampling and screening activities it is generally advised to consider all waste as PCB contaminated. Therefore, UN-approved packaging (Steel- or PE drums, Big Bags, Containers etc.) for both, liquid and solid waste must be available. Also all used reagents, test kits etc. shall be collected and disposed of as industrial waste.

Picture 29: L2000 use Practicing



Picture 30: Use of Clor-N-Soil on Site



2.3.1 Analysis by Gas Chromatography (GC)

Gas chromatography separates the components of a mixture and allows an electron capture detector to detect any compounds containing chlorine, including PCBs.

Due to their unique retention time, PCBs can usually be singled out from other chlorinated compounds using this technique. If closely related chlorinated compounds are present in the sample, then a mass spectrometry detector can «fingerprint» the PCBs and confirm their identity.

A common question is whether such analyses should be focused on mixtures of PCBs (e.g., Aroclor mixes) or on individual congeners. Congener-specific analyses have important advantages over analyses of mixtures: generally, congener analyses offer lower detection limits and greater information content. In addition, compositions of weathered, degraded, and metabolized PCB mixtures can be measured and interpreted more easily.

Also, it is easier to detect interferences caused by other chemicals, and quantification of individual congeners is more accurate. However, co-elution of analytes is a problem in a PCB congener analysis, so a strong quality assurance program and reliable reference materials are needed by the analyst.

Table 22: Advantages and disadvantages of gas chromatography

Gas Chromatography	
Advantages	Disadvantages
Exact results	Relatively high costs
Identification of PCB type possible	Long waiting time for result

Analyses shall be carried out by accredited and registered laboratories. Laboratories carrying out PCB analyses shall incorporate quality assurance and quality control programs.

2.3.2 Analysis Proceedings

To save analysis costs and time it is advisable to use screening tests whenever applicable. Nevertheless, it has to be considered that these methods test for the presence of chlorine in the sample being examined. As a result other chlorinated compounds, which can be part of the sample, could cause false positive results because the analysis method assumes all chlorinated compounds are PCBs. False negative results are not possible as if there is no chlorine present, PCBs cannot be present either.

Thus if a screening test shows a negative result (PCB below 50 ppm) it must be true, so there is no need of verification by another method.

If a test kit or the L2000 DX analyzer shows positive screening result (PCB > 50 ppm) verification by gas chromatography is always necessary.

In this case the sample for gas chromatography analysis is to be kept and forwarded to the appropriate laboratory. If results of a GC analysis show a significantly lower result than the screening tests there is no reason to be alarmed.

The tests are standardized for Aroclor 1242 with chlorine content of 42 %. Analyses with higher chlorinated PCB samples (e.g. Aroclor 1260 with chlorine content of 60 %) consequently show a higher result than the true PCB content. Thus the screening tests are always on the safe side.

Although false positive results obtained by the screening tests can cause unnecessary secondary testing, non-specific methods can be very economical when used on samples such as transformer oil, in which few sources of chlorine other than PCB exist. Used crankcase and cutting oils however always contain

some chlorinated paraffin and almost every non-specific test produces false positive results. More expensive laboratory analysis is advised when testing for PCBs in these chlorine-containing oils.

2.4 Database

The information on PCB containing equipment and its owners, which is compiled in the course of the national inventory, has to be recorded in a database:

An Access or similar database is an ideal tool to estimate the overall amount of PCB. This information is essential regarding possible project proposals e.g. for an installation of a decontamination or elimination plant in the country. The database enables the environmental authorities to control the PCB equipment in regard to the deadlines for the elimination. As the addresses of all owners of PCB containing equipment are recorded, the database can also be used if the environmental authorities have to send mailings to the owners.

Picture 31: Example of input mask of database

The screenshot shows a software interface for entering transformer data. The form is titled 'Transformer data' and includes the following fields and sections:

- Identification:** Enter item to edit (ID or name) [03060], Name [TS 110/6], Subgroup to Station (ID or name) [03060], Name [TS 110/6], Belongs to Branch (ID or name) [11], Name [RADOVIS].
- Classification:** Change item ID [03060], Class of equipment [TRANSFORME], Surrounding code [2], OPEN AREA.
- Technical Data:** New item Name [TS 110/6], Type [TOR 36-16000/110/6], Manufacturer [ELTA], Country of origin [POLAND], Serial number [15646], Voltage ratio [1], Rating (kVA) [10000], Number of units [1], Weight of oil (kg) [14000.00], Total weight including oil [49500.00], Weight of transportation (kg) [0.00], Width (mm) [6700.00], Length (mm) [3500.00], Height (mm) [4600.00].
- Operational Status:** Status of operation [1 - In use, 0 - Not in use], Status of activity [1 - Active, 0 - Retired], Condition [1 - Good, 0 - Bad], Leakage [1 - Yes, leaks, 0 - No], Label [1 - Yes, exists, 0 - No].
- Inventory:** Inventory date [26.11.2008], time [dd mm yyyy].
- Administrative:** DeadLine, Remarks, Company [BUJCM], Location [BUCHARLONIK].
- Gas chrom.:** Has PCB [1 - Yes, 0 - No], PCB [1 - Yes, 0 - No], Parts per million [0.00], Test [1 - Above, 0 - Below].
- Analysis:** Analyzed by [MINISTRY OF ENVIRONMENT], Has PCB by name plate [1 - Yes, 0 - No, X - No data].
- Removal/Refill:** Removed by [1 - Yes, 0 - No, X - No date], Date, Original oil type, Has PCB after refill [1 - Yes, 0 - No, X - No date], Refilled by [PRISTA], Refilled oil type, Refilled by [PADE KONCAR], Date refill [01.07.2008].

The database's input mask should match with the inventory form. All information from the form should be recorded in the database. The extent of the information to be declared by the stakeholders in the inventory form should include at least: general data about ownership, equipment details as dimensions, ratings, location: indoor / outdoor etc. and also information that could be essential regarding future elimination (as leakages status of PCB-screening etc.). Furthermore, data related to PCB contaminated hotspots, including sites and groundwater, should be included.

Even photographs of the equipment and eventual leakages are to be incorporated in the National PCB Database. Therefore the database software in use should cover functions to enable storage of digital pictures.

Depending on the criteria for the deadlines of elimination (see also chapter 3.3) the following information should be considered:

- Is the equipment in use or out of use?
- Is the concentration of PCB <500mg/kg or >500mg/kg
- Is the technical condition of the equipment good or bad? and
- Is the equipment located near places of higher risk (e.g. hospitals, medical centres, food industries, water and sanitation services, highly frequented buildings etc.)?

Ideally the above criteria are linked to a search or output function in the database, which enables the user to control and monitor each piece of equipment that has to be eliminated by a certain deadline.

Each party of the Stockholm Convention is obliged to provide a report to the Conference of the Parties (COP) every five years on the progress in eliminating PCB. Therefore a function of the database should cover the recording and print out of all eliminated equipment in a given period.

A PCB database should not only be considered as a way to store all gathered information, but also as a tool which will be continually updated, assessed and adapted, until the last device containing PCB is eliminated (2028).

2.5 Labelling of Checked Equipment

When compiling the inventory, the inspected equipment shall be marked with labels as a precautionary measure. According to the result of the analysis of a sample or to the examination of the manufacturer's plate on a capacitor, a label as specified below will be affixed to the equipment.

This shall guarantee that the equipment can be separated easily and correctly for the disposal at the time of the dismantling activities. In addition, in case of an incident it ensures that the hazards of the situation can be assessed immediately at first glance from the color of the label.

Picture 32: Label for PCB free equipment

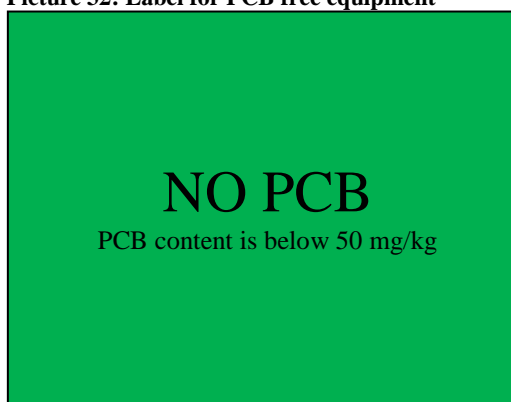

The equipment has been checked. Either the analysis of a sample has shown a PCB content of < 50 ppm or it has been possible to definitely determine that the equipment does not contain PCB e.g. by manufacturer's plate, nameplate, etc. (only possible with capacitors).

Picture 33: Label for PCB containing equipment

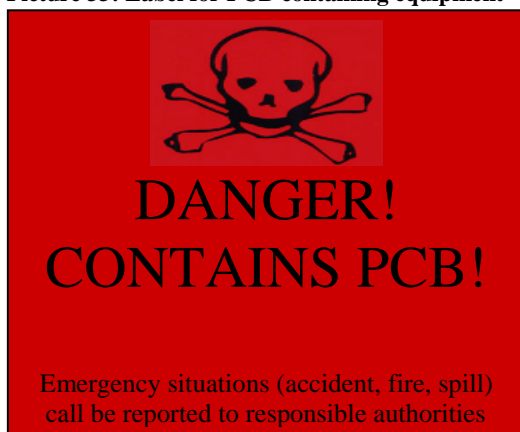

The red label is affixed to equipment where a PCB concentration of > 50 ppm has been analytically proven or if the equipment could clearly be identified as PCB containing by means of manufacturer's information e.g. name of cooling fluid. (possible with transformers and capacitors).

Picture 34: Label for PCB suspected equipment

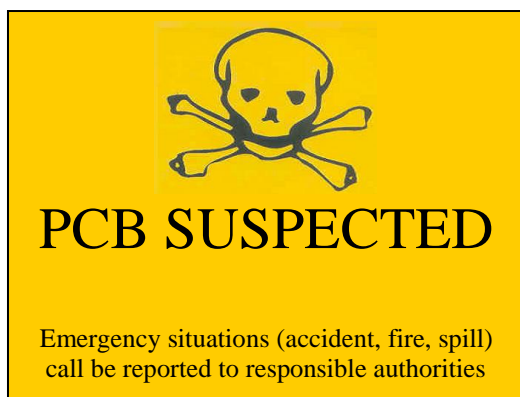

The equipment has been recorded but not yet tested for PCBs e.g. if a sampling is only possible after a phase out. Such labelled equipment remains PCB suspected, a sample must be analyzed after dismantling respectively before disposal.

It is recommended that the contracting Parties use the proposed labels, presented in pictures 32 to 34 for the purpose of easy recognition while in service, for maintenance and phased out equipment. For the export purposes countries must use additionally the labels as referred to in chapter 8.2.2 in line with the Basel Convention requirements.

Picture 35: Example labelled transformers



Picture 36: Example labelled capacitors



Picture 37: Label for decontaminated PCB equipment

Decontaminated PCB Equipment	
The liquid containing PCBs was replaced:	
- with (name of replacement liquid)
- on (date)
- by (contractor)
Weight percentages of PCBs in the liquid in the equipment:	
- old liquid
- replacement liquid

Obviously, the concentration of PCB will increase after some time because of remaining PCBs in the active parts of the equipment (transformer). Therefore, a reliable measurement of the concentration is only valid after a given time after the decontamination.

The owner of decontaminated transformer should retest the oil in the transformer not before six months after treatment, and again after 2-3 months of operating time before a transformer can be reclassified.

Labels will be made by the owners of the equipment in accordance with the provisions (regarding size and material of the labels) stipulated in the Inventory Regulations.

2.6 Site Monitoring

The aim of a site monitoring is to identify all materials that could have been contaminated by equipment containing PCB during their life as a result of leaks, inexpert working practices, spills, inexpert storage or incidents. Places to investigate include concrete floors or gravel under former PCB containing equipment, concrete floor in workshops or storage sites, soil in the area of former incidents or dumping places, etc.

Site monitoring covering the entire area of a company can be regarded as the last step after the disposal or decontamination of all equipment containing PCB in that company. Nevertheless, it is also recommended

to perform site monitoring on a smaller scale after the disposal or decontamination of a single piece of equipment. In this case the monitoring would only cover the area of the concerned device.

2.6.1 Land Register of Areas and Storage Facilities with Possible PCB Contamination or contaminated equipment

In a POPs contaminated areas database all spots are summarized that potentially could be contaminated by PCBs. It includes all locations where PCB or equipment containing PCB has been in use, repaired or stored.

It must also be investigated, in what locations and circumstances PCB had been used in the past. Company archives about material flow or documents about former equipment can be a useful source of information. It is further worthwhile to interview employees of the company who are or were in charge of the acquisition or maintenance of potentially PCB containing equipment.

Interviews should cover the types of purchased equipment, practices of maintenance, possible refills, stored drums with PCB for topping-ups, places of storage and workshops, incidents, etc.

The information obtained must be checked visually to substantiate the suspicion of PCB. The places which have to be visited are:

- Current and former sites of potentially PCB containing equipment (check ground under the equipment for leaks especially),
- Current and former workshops,
- Current and former storage sites for potentially PCB containing equipment or spare insulation fluid,
Sites of incidents (spills, internal failures, etc.), and Dumping sites.

All buildings where the PCB contaminated equipment is stored the following label should be affixed on building doors as indicated above.

2.6.2 Risk Assessment

To optimize the further proceedings it is advised to assess the associated risks of the sites that are listed in the POPs contaminated areas database. The questions to be considered are:

- Is the suspected PCB contamination secured or is it currently still spreading?
- Is the contamination endangering drinking water (ground water)?
- Is the location highly frequented by workers or passers-by (residential area)?
- Quantification: What is the size of the potential contamination or quantity of the endangered goods? and
- Storage: Are the suspected PCB containing goods stored appropriately (in drums or trays, sheltered, locked and separated from other goods) or inexpertly (no trays, in the open air)?

Sites that present an increased risk for humans or the environment have to be imposed with a higher priority for immediate action.

2.6.3 Analysis

In the next step a suspicion concerning possible PCB contamination has to be proved or disproved by taking and analysing specific samples. It is important to note that even if a visible spill does not contain PCB it is very likely that it does contain hydrocarbons, which are also a risk for the environment and have to be treated.

2.6.4 Extent of Contamination

When a site has been confirmed as being PCB contaminated, the extent of the contamination has to be delineated by taking further specific samples. In addition, the surrounding conditions of the site in terms of accessibility for machinery, availability of water and power, etc., need to be clarified. On the basis of the information obtained a decontamination of the site can be prepared. The following flow chart provides an overview of the procedures for a site monitoring.

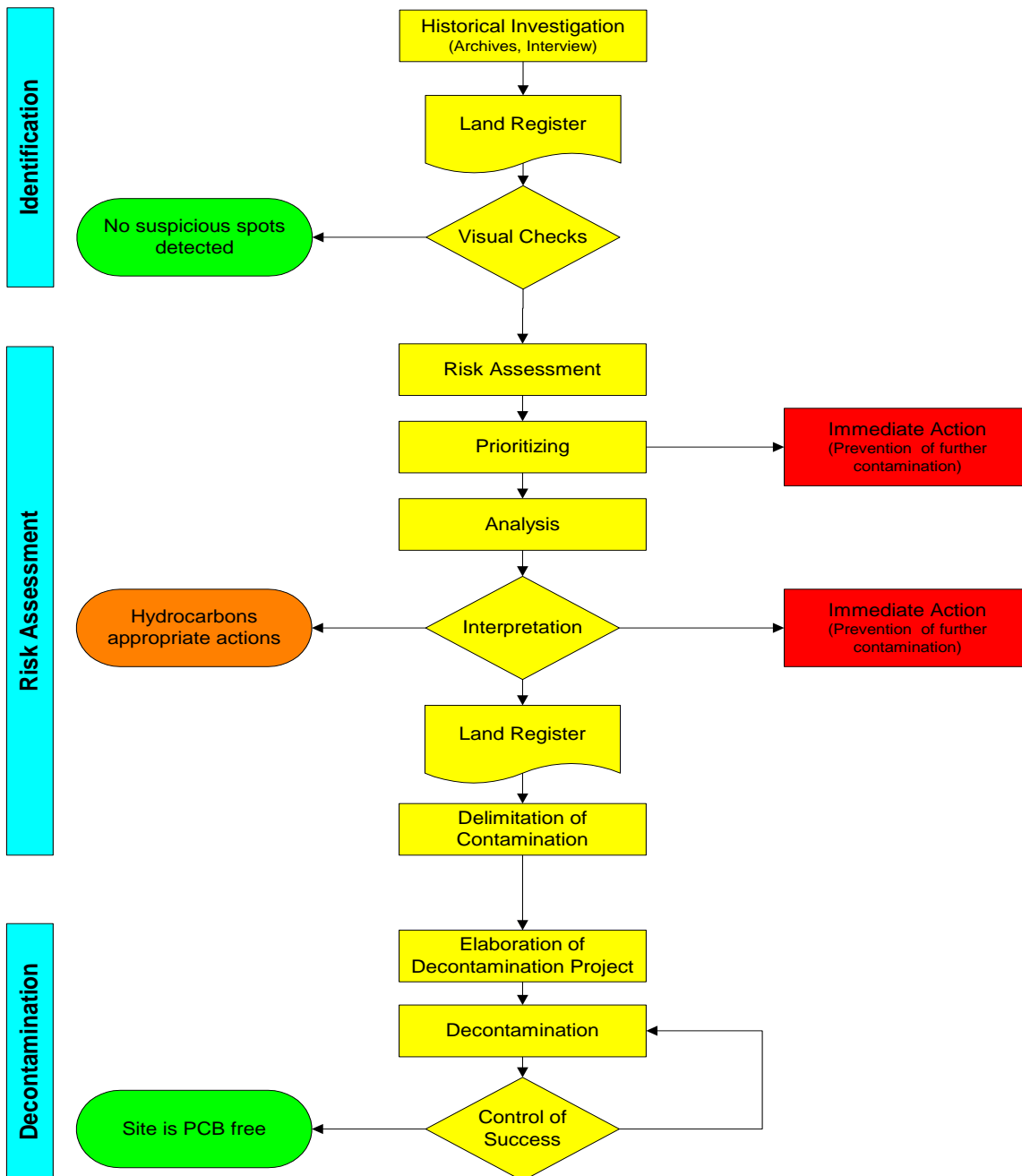

Chart 2: Site monitoring – procedures

3. PCB Management of Closed Applications

3.1 PCB Management Plan

Due to the noxious properties of PCBs every owner of equipment containing PCB should prepare a PCB management plan. It must cover the whole life cycle of these products (use, handling, storage and disposal) taking into consideration the dates as per PCB regulation. The management plan should be based on the polluter pays principle and should be in line with national law, regulations and priorities. Usage, handling and storage of PCB equipment should be considered as significant aspect by organization's Environmental Management Systems and should also be considered as hazard during the occupation health and safety risk assessment. A PCB management plan includes the following components.

3.1.1 Designation of a PCB Responsible

Every company has to assign to one or several people, depending on the size of the company, the responsibilities of implementing the procedures described below. In case of a PCB incident the PCB Representative will lead the emergency procedures.

3.1.2 Training and Instruction of Staff

Staff members must be instructed periodically about the risks for humans and the environment posed by these products and the safety measures as described in chapter 5. Precautions in order to prevent contamination of PCB free transformers (e. g. by refilling with untested oil) and the measures to take in case of an incident should be revised from time to time.

3.1.3 Inventory

All equipment in and out of use that may contain PCBs has to be identified and checked (also see chapter 2.1 Inventory). All tested devices must be correctly labeled as described in chapter 2.5.

3.1.4 Database on Locations with PCB Equipment, Waste or Contamination

As described in chapter 2.5 the inventoried devices, liquids, solids, soils and wastes shall be recorded in an appropriate database. This shall enable to categorize and visualize the data, and for example show all locations with PCB transformers on a map. For larger companies and authorities such a clearly arranged plan or map can serve as a useful working tool when planning the future elimination of equipment, and help make quick decisions in case of an incident.

3.1.5 Maintenance Plan

The maintenance of PCB containing equipment as described in chapter 4. must be performed regularly. In order to control its frequency, a maintenance register has to be kept that includes all PCB equipment of the company and in which every performed maintenance activity is noted.

An example of a "PCB Equipment Monthly Maintenance Plan" follows in Annex 12.16.

3.1.6 PCB Spill Prevention, Control and Countermeasure Plan (SPCC Plan)

A SPCC plan has to be prepared to prevent spills into the environment, and to act accordingly to a situation if it should occur. More information about SPCC plan is given in chapter 3.2.

3.1.7 Disposal and Site Decontamination Plan

Equipment containing PCB and wastes must be decontaminated or disposed of solely by companies that have a special permit for treatment of such kind of materials and waste obtained by the authorized body in the field of environmental protection, or other foreign companies which provide such services and approved by the Government of their countries.

As decontamination or disposal of equipment containing PCB usually implies a great expense for a company, it is advisable to formulate a disposal plan, which defines dates of decontamination or disposal and replacement for every unit of equipment. In addition, financial planning for the disposal costs as well as for new equipment can be included in the plan.

PCB contaminated sites and soils should be decontaminated in order to avoid volatilisation and diffuse re-circulation of PCBs from contaminated water, soil and sewage sludge. Soils for example can be bio-remediated with the use of bacteria, which break down the chlorinated (and other) hydrocarbons, it can be also incinerated or extracted by means of venting (passage of air to remove vapours) or by solvent washing. The choice of technique is based on the previous analytical assessment, the extent and concentration of contamination, the matrix and the type of area (e.g. industrial, agricultural etc.). It shall also be taken into consideration that PCBs are a mixture, which may undergo biological degradation only to a certain extent. Highly chlorinated PCBs often remain intact (persistent).

3.2 Spill Prevention, Control and Countermeasure Plan (SPCC Plan)

The SPCC plan has to be elaborated to eliminate or minimize the potential environmental risk of a PCB spill, which could for example result from substation operations. The PCB Representative in the company will be in charge of the correct implementation of the following components:

3.2.1 Prevention

All doors to rooms where equipment containing PCB or wastes are located or stored must be clearly marked on the outside with a label. The use or storage of PCB transformers is prohibited in any location where human food or animal feed products could be exposed to PCBs released from the transformers. The storing of inflammable materials next to equipment containing PCB or waste is forbidden. Best working practices as described in chapter 4.2 have to be followed.

3.2.2 Spill Prevention Tools

Under each transformer a retention system has to be installed to prevent the dissemination of PCB into the environment in case of a leak. The best solution is a steel tray, however concrete or brick walls around the transformer are also acceptable as long as the basin is tight and its retention volume is greater than the volume of the fluid in the transformer. In case of concrete basins they obviously should contain an oil resistant paint (e.g. appropriate kind of Epoxy). Spare equipment or equipment out of use and other PCB wastes must be stored in steel drums or steel trays as described in chapters **Error! Reference source not found.**7 and 8.

Picture 38: Labelling of a transformer room door



Picture 39: Retention system made from steel



The floors of workshops for activities like draining and dismantling of transformers has to be tight and fairly easy to decontaminate (e.g. Epoxy coating). The thresholds have to be elevated and all other openings close to the floor have to be sealed to prevent the dissemination of PCB into the environment in case of a spill.

3.2.3 Countermeasure

Emergency response plans as described in Annexes 12.8 and 12.9 have to be affixed near equipment containing PCB in an easily visible spot. In order to be able to react immediately in case of an incident it is recommended to keep appropriate materials and tools for immediate actions in an easily accessible place (protective gloves, drip tray, repair material, absorbents to seal leaks, etc.). Such storage depots can be recorded in the PCB register to allow immediate access in case of emergency.

3.3 Priorities for Disposal and Site Decontamination

According to the risk that PCB containing equipment or contaminated sites and soil pose to humans or the environment there are different priority levels. These shall be stipulated in the national PCB regulation:

- (1) PCBs that are stored as spare oil, as waste or as electrical devices out of service have to be disposed of no longer than three years after their declaration to the Competent National Authority in the frame of the national inventory,**
- (2) PCB containing electrical devices**
 - of PCB concentrations higher than 0.05 mass percentages (500 mg/kg)
 - in a bad technical condition
 - situated near places of a higher risk for the people (hospitals, medical centres, commercial centres, schools and universities, food industries, water and sanitation services, highly frequented buildings) have to be decontaminated or disposed of with priority,
- (3) All other electrical equipment with a PCB concentration between 0.005 and 0.05 mass percentage (50 and 500 mg/kg) can remain in service until the end of their useful life, but no longer than the year 2025, and**
- (4) PCB polluted soil and/or sites with direct impact to the environment or potential health risks, such as but not restricted to e.g. PCB contaminated agricultural land or sites close to food processing areas.**

Particular importance should be given to get better insight in unknown sources, equipment or hotspots.

4. Maintenance of Equipment Containing PCB

The maintenance of a device should be performed according to the procedures issued by the manufacturer and by the corresponding national standards. In the following, a general view of the key elements of the maintenance of PCB containing transformers and capacitors is presented.

4.1 Maintenance of In-Service PCB Equipment

In-service equipment containing PCBs may need to be maintained according to the manufacturer's instructions for proper functioning or to clean up or prevent releases of PCBs. It is not within the scope of this document to discuss routine maintenance of equipment. The maintenance issues that are of importance for PCB Management are:

1. Transfer of liquid PCBs during maintenance
2. Replacement of leaking seals and repair of cracks and holes
3. Clean-up of minor leaks or spills during maintenance activities

All work on PCB containing equipment should be carried out in accordance with the site specific health and safety plan and applicable government regulations. Staff should be trained in the maintenance of the equipment and in the correct methods to handle hazardous materials.

If a piece of equipment containing liquid PCBs needs to have internal components “topped-up” or recharged, serviced or repaired (and is the type of equipment that is normally opened for servicing) serious consideration should be given to replacing the equipment or decontaminating it (removing the PCBs) and re-filling it with a non-PCB fluid. The Basel and Stockholm Conventions recommend phase-out of this equipment (under specific timelines) rather than continued use. Replacement fluids for electrical transformers include silicones, aliphatic hydrocarbons, poly- α -olefins, chlorinated benzenes and esters (Environment Canada, 1988).

If servicing of equipment is unavoidable, all work should be done with the objective of minimizing releases to the environment and minimizing the amount of contaminated material created through the servicing work. Recommended practice for this purpose includes:

- Plan the servicing in accordance with the manufacturer’s recommendations, applicable regulations and codes and with the advice of experienced professional service persons.
- Turn the equipment off and disconnect it from the power source. De-pressurize the equipment if necessary. Allow the equipment and PCB liquid to cool to ambient temperature. Servicing equipment at ambient temperatures above 25°C should be avoided if possible due to the increased volatility of the PCBs at higher temperatures (i.e. more PCB vapours will be released at higher temperatures).
- Inspect the equipment before beginning service for leaks, holes, rust, low fluid level, high or low pressure (above or below specifications), high temperature (above specifications), malfunctions and gaseous emissions.
- Inspect the opening valves, latches, lids, etc. for blockages, breakage or malfunction.
- Re-consider and re-plan the servicing plan if any leaks, holes, malfunctions etc. are found.
- Ensure that spill containment measures are in good shape and adequate to contain the PCB liquid if spilled. It may be advisable to place plastic sheeting or absorbent mats under the equipment before opening it if the surface of the containment area is not coated with a smooth surface material (paint, urethane, epoxy, etc.).
- Additional ventilation may be required to keep the atmospheric PCB level below the recommended levels and to provide adequate oxygen for workers.
- Remove the liquid PCB either by removing the drain plug or by pumping with a peristaltic pump and Teflon or silicon tubing. Store the PCB liquid temporarily in one or more steel containers (drums) with tight-fitting lids or bungs. Leave a space of 8-10 cm at the top of the container for heat expansion and to avoid spillage when opening the container. Pumps, tubing and drums should be dedicated to the transfer of PCB liquids (not used for any other purpose).
- Inspect the inside of the equipment for damage, rust and cracks. Complete servicing and repairs.
- Replace any worn or broken seals.
- After completing the servicing replace the drain plug if applicable, replace the PCB liquid by pumping, add make-up fluid if necessary, and re-seal the equipment.
- Clean up any spills with cloths or paper towels. Triple rinsing contaminated surfaces with a solvent such as kerosene is usually necessary to remove all of the residual PCBs.
- All tools used for the servicing should be dedicated for PCB use.
- All absorbents, disposable protective clothing, plastic sheeting and removed components should be treated as PCB waste.

4.2 Best Working Practices

When performing light repair or maintenance work on PCB containing equipment, the following safety precautions for the protection of the employees and the environment have to be taken:

- Direct contact of the skin with PCB contaminated materials must be avoided by wearing gloves and safety goggles. According to the type of work to be performed, protective clothing and a respiratory mask must also be put at the workers' disposal (see also chapter 5.1. Personal Protective Equipment),
- The working area must be adequately ventilated,
- Spills must be prevented in every case by using drip trays or adequate plastic tarps,
- Every contact of PCBs with a flame or any other heat source over 300 °C and use of a grinder must absolutely be avoided (risk of highly toxic Dioxins and Furans),
- All used tools and other working materials that got in contact with PCBs must be disposed of as PCB contaminated waste in an environmentally sound manner or otherwise have to be decontaminated with an appropriate solvent (technical acetone). The only possible materials to be decontaminated are steel, glass, and ceramics. All other materials, such as rugs, PPE, etc. must be disposed of as hazardous wastes; tools and certain equipment (e.g. pumps and hoses) may be re-used but only for operations with PCB-containing equipment and must therefore be clearly marked/labeled as PCB-contaminated,
- Operations which involve draining, rewinding of coil, etc. may only be performed by companies approved for such tasks by the competent country authorities.
- The role of universities, NGOs and related stakeholders in promoting the dissemination of PCB management's best practices shall be strengthened.

In Annex 12.11 a proposal of a flyer can be found. It is recommended to print and distribute this flyer to owners of equipment containing PCB, so they can affix it to walls near the equipment or in workshops.

Picture 40: Transformer maintenance area



Picture 41: Active transformer part in Albanian workshop



4.3 Inspection of PCB Containing Transformers

4.3.1 Visual Checks

The simplest and the cheapest test of a transformer in service or in storage is the visual check. PCB Transformers shall be visually inspected quarterly by the equipment owner, who is also responsible for maintaining records of inspections.

The following areas shall be examined:

- Oil stains near the equipment
- Oil stains or weep marks on the equipment (welding seams, gaskets, valves, etc.)
- Gross physical damage
- Tightness of drip tray

Table 23: Routine inspections for transformers

Inspection	What to look for (and corrective action)
Condition of gauges	➤ Cracked faceplates or damaged gauges (install a Plexiglas sheet over gauges for protection).
Reading of gauges	<ul style="list-style-type: none"> ➤ Change in readings since last inspection. ➤ Readings within the safe or acceptable range (if they are not, consider the addition of make-up fluid).
Corrosion on tank and radiator fins	➤ Condition of fins. They are manufactured of thin steel to obtain maximum cooling and will rust through more quickly than the rest of the transformer, especially in a caustic environment (clean to bare metal and paint if rusted).
Paint finish of tank and radiator fins	➤ Weathering paint (repaint as often as necessary).
Leakage of PCB from: <ul style="list-style-type: none"> ➤ tank ➤ radiator fins ➤ top cover (if gasketed) ➤ manhole cover ➤ top or bottom drain spout ➤ high and low voltage bushings 	<ul style="list-style-type: none"> ➤ Wet slickness and gummy residue. ➤ Deteriorating gaskets or seals. <p>(Important – if there has been leakage, take steps to clean it up promptly and reported to the appropriate provincial authority. All materials used for cleaning up the PCB leakage must be safely stored as PCB-contaminated waste.)</p>
Pressure-relief valve	➤ Improperly seated valve due to displaced gaskets.
High and low voltage bushings	➤ Cracking or chipping. (Replace cracked or chipped bushings.)
Colour of PCB	<ul style="list-style-type: none"> ➤ Colour changes. ➤ Take a small sample. If the color is changing from clear to a blue, green, red or black, the PCB is becoming contaminated (consider a laboratory test to check its quality).

4.3.2 Leaks of Transformers

When a leak or spills have been detected on or near a transformer, it is necessary to look into the cause of the leak to prepare remedial action. Most common are leaks at seals and gaskets. Various possibilities for effective reparations are apt and help avoid affecting the main body of the transformer in any way. However, only experienced electrical specialists who are aware of the dangers of PCBs shall perform such work.

A more serious situation occurs when the leakage or seepage is due to damage in the metallic structure of the transformer. Such leaks can be caused by mechanical and accidental damage to the transformer casing. In such cases, it is recommended to seal the leak temporarily with a sealing paste and place a drip tray underneath the leak for safety reasons. As this is only a temporary solution, a proper repair has to be carried out soon as possible.

A leak can also be caused by a slow degradation of the cooling fluid, which increases its corrosiveness. If corrosion is already advanced and causing leaks, then the transformer must immediately be sealed with a sealing paste, phased out as soon as possible and replaced by a new device.

4.3.3 Oil Level of Transformers

Most transformers have a direct or indirect device allowing the cooling fluid level to be controlled. Before topping up a decreased cooling fluid level, it is vital to check the PCB content of the transformer as well as the additional cooling fluid to avoid a possible contamination.

4.3.4 Temperature Gauge

The temperature gauge indicates the temperature of the dielectric fluid within the transformer. Excessive temperatures point towards an overheating of the transformer, possibly due to loss of dielectric fluid. Action should be taken immediately to detect the cause of the overheating, as the rate of the deterioration of insulating materials in the transformer can rise rapidly above the normal operating temperature.

4.3.5 Pressure-Vacuum Gauge

The pressure-vacuum gauge measures the pressure changes in the space between the dielectric liquid and the tank lid. Unusually high pressure indicates that short circuits and arcing may have occurred. In this case, a performance test has to be performed as soon as possible. An unusually low pressure reading indicates a low level of the dielectric fluid. Action should be taken immediately to identify the cause of the dielectric fluid loss.

4.3.6 Corrosion on Tank and Radiator Fins

The condition of the tank and the radiator fins has to be checked regularly, as they are prone to show corrosion. If corrosion occurs, the affected area has to be cleaned to the metal and painted.

4.3.7 Performance Tests

Transformers must be periodically checked to detect any changes which may be the first signs of degradation in the performance of the transformer, and therefore of possible risks arising. Among others, the following characteristics have to be checked:

- Functioning of all protection devices
- Electrical performance of the transformer
- Oil quality (physical and chemical tests)

4.4 Evaluation of PCB Containing Capacitors

Visual checks are easy and they can be carried out frequently if the conditions in the substation require so.

Visual checks allow detecting the following damages on capacitors:

- Leaks in the container
- Swelling out or deformation of the container
- Oxidation of the container
- Dirty bushings

In the first two cases, the capacitors must be phased out immediately and disposed of in an environmentally sound manner.

The swelling of the container is a clear indication of a soon short circuit in the capacitor!

Picture 42: Inflated capacitor



Visual checks must be complemented by technical examinations, which require qualified staff. Depending on the condition of the equipment, the frequency of the examinations is determined (at least once a year).

4.5 Substitute Fluids

PCB oils in transformers have often been replaced by common mineral oils like «Shell Diala B». However, other substitute fluids have also been used. The table below lists substitutes fluids for new transformers, together with their advantages and disadvantages.

Table 24: Substitute fluids

Substitute Fluid	Advantages	Disadvantages
Silicones	<ul style="list-style-type: none"> ➤ low pour point ➤ high fire point ➤ low rate of heat release upon combustion ➤ fairly low viscosities over the entire range of operating temperatures 	<ul style="list-style-type: none"> ➤ not compatible with some gasket materials, such as silicone rubbers and certain insulation materials. ➤ specific gravity of fluid is such that water will sink to bottom of transformer while ice crystals are buoyant and float to top. Melted ice crystals could migrate through fluid and reduce its dielectric strength ➤ cost is relatively high ➤ PCBs are soluble in silicones only up to 8 %
Aliphatic hydrocarbons (e.g., RTemp, produced by extensive refinement of crude oil and blending of anti-oxidants, stabilizers and other additives)	<ul style="list-style-type: none"> ➤ low degree of in-service degradation ➤ compatibility with all materials of construction normally used in electrical equipment ➤ fluid is compatible with all other dielectric fluids ➤ specific gravity is below that of both water and ice ➤ fluid is not a serious environmental hazard (same effects as other mineral oils), is biodegradable and can be disposed easily ➤ cost I lowest of all PCB substitutes and raw materials are plentiful 	<ul style="list-style-type: none"> ➤ high viscosity at lower temperatures ➤ high rate of heat release during combustion ➤ blended additives (proprietary to the supplier) are required to depress pour point and improve thermal and oxidative stabilities ➤ gassing tendency under electrical stress is equal to or higher than for conventional (naphthenic) transformer oils which are in turn higher than all other PCB substitute fluids
Poly-a-olefins (synthetic hydrocarbons)	<ul style="list-style-type: none"> ➤ compatibility with all materials used for transformer construction and all other hydrocarbon fluids ➤ lower pour point and slightly better low temperature viscosity than natural aliphatic hydrocarbons ➤ specific gravity below that of water 	<ul style="list-style-type: none"> ➤ relatively high rate of heat release during combustion ➤ relatively high cost



	<p>and ice</p> <ul style="list-style-type: none"> ➤ no gassing under electrical stress 	
<p>Chlorinated benzenes (Tri-tetrachlorobenzenes are components of PCB but can also be use alone)</p>	<ul style="list-style-type: none"> ➤ physical properties similar to properties of PCB ➤ transformers designed for PCBs are generally suitable for TTCBs 	<ul style="list-style-type: none"> ➤ not suitable for use at very low ambient temperatures because of high pour point ➤ exhibit some toxicity and not easily biodegradable
<p>Esters (blend of pentaerithritol and fatty acids)</p>	<ul style="list-style-type: none"> ➤ high dielectric strength ➤ low flammability ➤ low pour point ➤ no toxic substances generated during arcing conditions ➤ compatible with most materials used in transformers 	<ul style="list-style-type: none"> ➤ no significant disadvantages except higher cost than RTemp fluid

5. Safety

5.1 Safety and Personal Protective Equipment

People handling PCBs or people that can be potentially exposed to PCBs have to use adequate protective equipment. The level of protection and the choice of protective equipment depend highly on the tasks carried out.

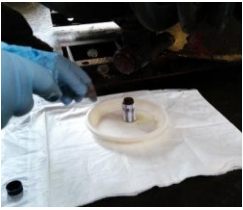
Table 25: Description of personal protection equipment (PPE)

Task	Personal Protective Equipment
Sampling of liquids or soil 	<ul style="list-style-type: none"> ➤ Gloves (Vinyl or Nitrile, no Latex) ➤ Light respiratory mask (Filter A2P2; for organic vapors and particles, voluntary)
Sampling of a capacitor	<ul style="list-style-type: none"> ➤ Gloves (Vinyl or Nitrile, no Latex) ➤ Safety goggles, only while opening or drilling ➤ Light respiratory mask (Filter A2P2; for organic vapors and particles)
Sampling of concrete or brick wall (e.g. by drilling)	<ul style="list-style-type: none"> ➤ Leather gloves ➤ Safety goggles while drilling ➤ Light respiratory mask (Filter A2P2; for organic vapors and particles) ➤ Ear protection (while drilling)
Dismantling of capacitors (no leakage) 	<ul style="list-style-type: none"> ➤ Working overall ➤ Helmet (according to companies' safety rules) ➤ Steel capped (rubber) boots ➤ Leather gloves ➤ Light respiratory mask only in case of leakage (Filter A2P2; for organic vapors and particles)
Dismantling of capacitors (with leakage) 	<ul style="list-style-type: none"> ➤ Protective suit (Tyvek) ➤ Steel capped (rubber) boots ➤ Neoprene gloves ➤ Light respiratory mask (Filter A2P2; for organic vapors and particles)
Clean-up activities (choice of PPE according to type of contamination and extent of work)	<ul style="list-style-type: none"> ➤ Protective suit (Tyvek) ➤ Steel capped rubber boots ➤ Safety gloves (heavy duty) ➤ Respiratory mask (light or full face, Filter A2P2; for organic vapors and particles) ➤ Helmet (if necessary) ➤ Ear protection (if necessary)

The most important parts of Personal Protective Equipment (PPE) for handling PCB-containing materials are shown below:

Picture 43: Protection overall, one way, oil-resistant



Picture 44: Safety gloves, Neoprene



Picture 45: Breath protection masks, light, FFP2 or 3



Picture 46: Breath protection masks, medium, A2/P3



Table 26: Filter classification

Letter	Definition
A	High-boiling (>65 °C) organic compounds
P	Particles; classified as P1, P2, and P3 according to removal efficiency
ABEK, ABEK-P3, ABEK-HgP3	Combination filters against multiple hazards

Table 27: Particle filters

Class	Filter Penetration Limit
FFP2	Filters at least 94% of airborne particles
FFP3	Filters at least 99% of airborne particles

The appropriate choice of masks and filters respectively PPE in general shall be based on a risk evaluation, as other hazardous substances could be present depending on site, area and tasks to be performed.

Picture 47: Safety gloves, Nitrile, EN 388, oil resistant



Picture 48: Safety goggles



One-way gloves for the sampling of liquids should be made of Nitrile or Vinyl. Latex or Butyl rubber gloves should not be used as PCBs might penetrate through them!

Protection of the Environment

When handling PCBs, all necessary safety precautions need to be taken in order to prevent a contamination of the environment.

When taking samples of PCB suspected equipment or PCB suspected material, it must be worked tidily without losing or spreading sample material. Use oil absorbing carpet as foundation if needed.

All working material must be cleaned either with acetone or disposed of as hazardous waste, including PPE. Only metal and glass can be cleaned entirely, synthetic material and plastic, wood, etc. cannot be cleaned and have to be disposed of as hazardous waste.

When confronted with leaking equipment or equipment in bad technical condition during the inventory, it must be ensured that the leak can be stopped or that the entrainment of the contamination can be prevented.

In areas with spills: The contaminated area shall be marked and fenced off if possible. Clothing and footwear shall be changed when entering or leaving the contaminated area in a designated place (compartment). If possible, the leak shall be located and sealed e.g. with a sealing paste. Furthermore, the leaking device shall be placed in a steel basin or drip tray when out of service otherwise absorbent pads shall be placed around and replacement foreseen as soon as possible.

In case of leakage due to damaged equipment, uncontrolled spillage must be prevented by the appropriate positioning of a drip tray, as a first measure. Small leaks should be sealed, and suitable safety equipment must be used while carrying out this work. It is therefore advisable to always keep suitable material (drip tray, rubber gloves, sealing material) in the vicinity of such equipment.

Visibly contaminated soil or concrete should be removed as quickly as possible in order to avoid further contamination. Surfaces of objects (vehicles, sidewalks, buildings, etc.) should be cleaned by using oil absorbent materials and by wiping the surface with solvents. After the cleaning, the surfaces must be analytically tested to check the cleaning success. The used cleaning materials should be placed in drums for disposal.

6. Emergency Actions and Clean Up

Emergencies involving PCBs can occur with equipment in service, in storage, during transport or at a disposal facility. These emergencies may take the form of:

- A leak or spill of PCB liquid
- The failure of a piece of in-service equipment
- The accidental breach of a container of PCBs
- Fires

All companies operating storage facilities or transporting PCBs should develop and implement a fire and emergency action plan. Such a plan should be developed in conjunction with the local fire department.

All personnel working with PCBs should become familiar with the contents of the emergency plan. It is recommended that employees be trained in the use of the plan, preferably through emergency drills. As well, employees should be trained in the use of personal protection equipment, spill control kits, and fire extinguishers. They should also be made aware for the hazards of PCBs.

In case of incidents, accidents or spills the company shall notify all competent authorities in line with national regulation and environmental permit standards.

6.1 Emergency Actions for Cold Incidents

The seeping of PCB from a device in the environment is described as a «cold incident». Cold incidents can be caused by unintended mechanical damage to the transformer's cooling fins or by corroded transformer walls. Spills can, however, also occur during draining activities or the handling of stored oil.

The following measures must be taken:

Measures in case of «cold incidents»

- If a lot of PCB has leaked from the equipment and if there is a risk of the PCB contaminating the environment, the chemical brigade must be called immediately. If there are doubts whether or not the oil does contain PCB, then the oil should be regarded as containing PCB until the contrary has been proven.
- Inform the doctor in charge and equip the chemical response team with appropriate personal protective equipment according to chapter 5.1.
- Switch off the power supply to the concerned device and check grounding.
- Limit the spreading of the seeping oil by sealing the leak and using absorbing materials (sand, sawdust or cement) or by pumping in appropriate containers. If possible, a drip tray can be placed under the leak.
- Prevent the contamination of watercourses by PCB. Drains as well as channels and pipes that lead to open waters must be sealed. Furthermore, it must be ensured that no water can flow into the contaminated area (e.g. sprinkler systems). Consider: A pollution of watercourses or puddles does not necessarily have to be visible. PCB is heavier than water and thus there is no oil film on the water.
- Fence off and mark the contaminated area. A tent with different compartments must be set up to control the access of people and the movement of material into or out of the contaminated zone, in order to prevent clean areas from being contaminated. The personal protective equipment is put on/taken off in the tent every time when entering/leaving the contaminated zone.
- Within the contaminated zone, attention must be paid to the soles of the shoes. They must be clean; otherwise the floor could be contaminated with PCB by the soles.
- The contaminated floor or concrete should be removed as quickly as possible to prevent a further cross contamination.

- If the incident has happened inside a building: Evacuate people from all concerned rooms/buildings, switch off ventilation, close doors, and windows.
- Inform the competent authorities. All details about the incident have to be reported so that the population can be warned, if necessary (e.g. contamination of drinking water)

An Emergency Response Plan for cold incidents is given as a checklist for separate distribution in Annex 12.8. This checklist shall be regarded as a basic list and adapted to current actualities including contact addresses of competent authorities.

6.2 Emergency Actions for Hot Incidents

Incidents involving PCB equipment can also be caused by short circuits or a fire in the vicinity of the equipment. In case of a «hot incident», the temperature in the device exceeds the boiling point of PCB (approx. 300 °C).

If this happens locally even for a short time only (e.g. short circuit), PCB vapors can be released, and they can contain highly toxic Furans (PCDFs). If PCB gets in contact with oxygen (fire), not only Furans, but also Dioxins (PCDDs) can be formed.

6.2.1 Incident Caused by an Internal Failure

An electrical short circuit (arc) constitutes the greatest danger. In a capacitor, it gives rise to temperatures of several thousand degrees Celsius within fractions of a second.

Failures of this kind primarily occur in capacitors. The heat causes excess pressure in the equipment, resulting in the bursting of the capacitor. A black, viscous mass leaks out. This is PCB containing carbon black. Due to the increased temperatures gaseous PCB is formed, which is contaminated by Furans. These vapors can deposit viscous oil films on fittings, floors and walls, even at a distance from the place where the incident happened.

In addition to the measures mentioned in the previous chapter, the following points must be considered:

- Personal protective equipment must absolutely include respiratory protection.
- Lock the building immediately and stop air circulation by closing/sealing ventilation slits, if possible.
- Evacuate people from all rooms at risk.

Picture 49: Hot incident



Picture 50: Burst capacitor



Picture 50 above shows the former position of a burst capacitor within a capacitor battery. The oil squirted out and contaminated the wall behind the capacitors.

6.2.2 Fires

Fires of transformers or capacitors have been very rare. The causes of incidents usually were fires in the vicinity of the PCB containing equipment.

During a fire, there is danger of a decomposition of PCB caused by the heat and the effect of oxygen. Hydro-chlorinated gas is formed and the decomposition process can also result in highly toxic Furans (PCDF) and Dioxins (PCDD).

Picture 51: Fire near a substation

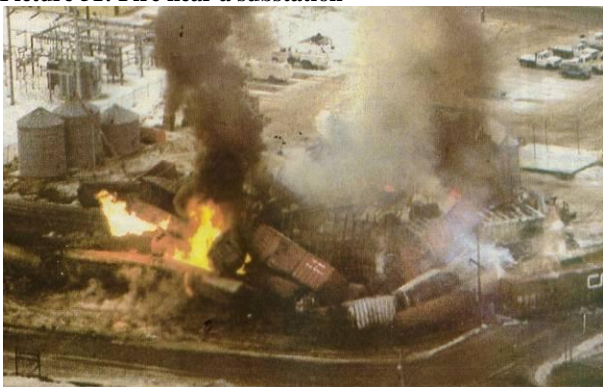

Picture 52: Remains of transformers in a scrap yard



The order of the measures to be taken in case of a fire is given below:

- Call the fire brigade immediately and carefully describe the situation so that the appropriate equipment can be chosen for the fire-fighting operations. If there are doubts whether or not the devices do contain PCB, then they should be regarded as containing PCB until the contrary has been proven. Calling the fire brigade immediately can highly reduce the effects of an incident.
- Inform the doctor in charge and equip the chemical response team with appropriate personal protective equipment. The protective equipment proposed in chapter 5.1 is not sufficient for areas where Dioxins and Furans have been released (and hardly kept handy everywhere). Consequently, the chemical response team should only approach the danger zone if absolutely necessary.
- Switch off power supply.
- Hermetically seal the rooms or the entire building. Switch off ventilation systems.
- Evacuate people from all concerned buildings, and on a larger scale in the direction of the wind.
- Inform the competent authorities: All details about the incident have to be reported so that the population can be warned or evacuated, if necessary.
- Fence off the contaminated zone and strictly control access. Only people wearing appropriate personal protective equipment are allowed to enter the zone. When fencing off, the direction of the wind must be considered.

An Emergency Response Plan for hot incidents as a checklist for separate distribution can be found in Annex 12.9.

Instructions for the fire brigade should include:

- To use CO₂ to extinguish the fire
- If water is used at all, then only to cool down the environment
- If water is used, it must not flow into the sewage system or open waters (pump!)
- To ensure that all skin is covered to prevent exposure to smoke containing PCBs
- Clothes and protective clothing that has come into contact with PCB or decomposition products (soot) must be regarded as being toxic and disposed of appropriately
- All firemen should shower thoroughly to remove any soot that may have contacted uncovered skin
- If a fireman develops a skin rash after a fire, he should go for a medical check-up

6.3 First Aid in Case of Contact with PCB

The following table summarizes the immediate actions that have to be taken after an exposure to PCB. Additionally, a doctor should be seen in any case.

Table 28: First aid measures

First Aid Measurements		
Kind of Exposure	First Action	Second Action
Liquid PCB on the skin	Use water and soap to wash thoroughly	See doctor if rash develops
Liquid PCB in the eyes	Rinse eyes with lukewarm jets of water for 15 minutes, always keeping eyes wide open*	See doctor
Liquid PCB in the mouth and in the stomach	Rinse mouth with water, do not drink anything else	Write down details about swallowed liquid, take victim to hospital emergency or doctor immediately
Highly concentrated vapors of PCB	Take affected people outside in the open air	If discomfort does not clear up, take victim to doctor

* An on-site eye wash station should be provided where PCBs are handled frequently

6.4 Clean Up after Incidents

6.4.1 Assessment of an Incident

In case of an incident, the operator/owner of the equipment must try to obtain the following information immediately, to enable a first assessment of the situation:

- Do the concerned devices really contain PCB?
- Is the PCB concentration known (e.g. from earlier analyses)?
- What is the assumed extent of the PCB or PCDF/PCDD contamination?
- Are there any visible billows of smoke, soot deposits?
- Weather conditions: Direction of the wind, wind force, rain, snow?
- Is the sewage system or the groundwater affected?
- Access roads used for possible fire-fighting operations (cross contamination)?
- When and where exactly did the incident happen (order of events)?
- If the incident happened in a closed room, it shall be reported if ventilation was in use and when it was switched off, respectively. Additionally, the names of all the people that came in contact with PCB or smoke shall be listed (for medical care, if necessary).

The assessment of the incident, which is done by experts, highly depends on the quality of the obtained information/responses to the above questions. Based on the received information, the experts take samples that are analyzed to determine the extent of the contamination. Cleaning activities should only be started with after the availability of the results, except for immediate actions, e.g. to control oil spills (to prevent a further contamination of soil, concrete and air). Incidents should immediately be reported to the competent authority in the field of Environmental Protection and Emergency Situations.

6.4.2 Decontamination Methods

The decontamination technique depends on the extent of the contamination; the pollutant(s), the concentration, and the contaminated material itself (concrete, soil, ceramic, plastic, etc.).

Table 29: Decontamination methods

First Aid Measurements	
	<p>l: low concentration, dry, non-sticky soot, no visible oil film</p> <p>h: high concentration, visible oil film, spills, puddles, sticky soot</p>
Material	Technique
Soil	<p>Remove until material is below the limit of 50 mg/kg</p> <p>Remove until material is below the limit of 50 mg/kg</p>
Uncoated concrete floors	<p>Use industrial vacuum cleaners with appropriate filters and wet wipe the floor</p> <p>Repeated solvent scrub process followed by an absorbing clean up, until material is below the limit of 50 mg/kg</p>
Walls, brick walls	<p>Use water to clean, or remove plaster</p> <p>See concrete floors</p>
Ceilings	<p>Use industrial vacuum cleaners with appropriate filters to clean and wet wipe the ceilings</p> <p>See concrete floors</p>
Untreated metal, window panes	<p>Use solvents to clean carefully</p> <p>See above</p>
Coated metal surfaces	<p>Use solvents to clean</p> <p>Completely remove coating</p>
Plastic parts (insulating material, etc.)	<p>Use solvents to clean</p> <p>Remove, replace</p>
Fittings	<p>Dismantle completely and use solvents to clean</p> <p>Clean or remove, depending on concentration and quantity</p>

The choice of the appropriate solvents or cleaning agents shall be made from case to case. It is recommended to use technical acetone to clean soot, dust, and similar materials. Spills are best cleaned by means of a biodegradable cleaning agent.

Visibly contaminated soil or concrete shall be removed in order to avoid further contamination. Surfaces of objects (vehicles, sidewalks, buildings, etc.) should be cleaned first by using oil absorbent materials and then by either a solvent scrub process or rather by using a biodegradable cleaning detergent. After the cleaning, the surfaces should be analytically tested to check the cleaning success. The decontamination process has to be repeated, until the remaining contamination is lower than the applicable limit value (50 mg/kg). If this procedure does not lead to a success, the structure has to be removed.

Spills into waters could pose a difficult clean-up problem and require special consideration. Since pure PCBs are denser than water, they will settle to the bottom and dredging of contaminated sediment will be necessary.

6.4.3 Protection of Workers and the Environment

In certain serious cases, the contaminated area should be sealed off by a protective tent around the zone. Such a tent must be air- and dust-tight, protect against the weather and control access by a system of compartments. The contaminated zone must only be entered through this system and personnel must wear personal protective equipment (PPE) when entering. The purpose of the sealing off is to prevent a cross contamination in the environment. A controlled exhaust system installed at the tent collects and filters (by an activated carbon filter) contaminated dust and particles that are formed during the clean-up activities.

6.4.4 Disposal

The appropriate disposal of the wastes is a very important part of clean-up activities after a PCB incident. Unfortunately, this aspect is often underestimated during the planning phase. Not only contaminated soil or removed contaminated building material, but also associated wastes like vacuum cleaner bags, solvents, personal protective equipment, cleaning material, sealing-off material, etc. must be disposed of in an environmentally sound manner. Please find more details about disposal in chapter 11.

6.5 Check of Clean Up (Monitoring)

The supervision of clean-up activities by an independent expert and/or representatives of the responsible authority is a key element of success and should be regarded as useful assistance. Representative sampling during and at the end of the clean-up activities shall prove that the remaining contamination does not exceed the tolerable and agreed values.

6.5.1 Tolerable Remaining Contamination after a Clean-up

The guide values for tolerable remaining contamination shall be decided in cooperation with the competent environmental authorities in case by case decisions. Furthermore, the control of the contamination after the clean-up shall be regulated. It can make sense to determine the limit values from case to case, depending on the project.

The following values can be regarded as a guidance based on limit values in various European Countries. Of course, the specific limit values of a country depend on its national laws and regulations.

Table 30: Proposed general guide values

Description	Substance	Guide value	Unit
Surfaces (for example cleaned/decontaminated metal surfaces)	PCB	100	µg/m²
Solids (for example concrete, building materials, etc.)	PCB	50	mg/kg
Indoor Air Rooms with a stay of eight hours per day (Intervention value)	PCB	> 6'000	ng/m³
Indoor Air Rooms with permanent stay (Intervention value)	PCB	> 2'000	ng/m³
Indoor Air Value to be achieved after a PCB clean-up	PCB	300	ng/m³

7. Phase Out

7.1 Phase Out of Transformers

The practical phasing out of transformers starts with the disconnecting procedure, which has to follow the local safety, rules for work on electrical equipment as well as (if available) the instructions of the manufacturer. Before any activity on the transformer can start it must be ensured that it has been switched off on the high- as well as the low voltage side, that the in- and out-coming lines are short circuited, safely and visibly earthed at the working place and that the operating panel of the circuit breaker and the low voltage power switchers are marked with a clear visible sign «do not switch works ahead». Furthermore, it must be ensured that access to the transformer is possible without any remaining risk.

The working area should be fenced off to avoid unauthorized access. A fire extinguisher must be positioned in a suitable place on site, ready to use in case of a fire hazard.

First of all inspect the transformer accurately on damage and leakage, then to avoid any further cross contamination it is, in case of leakages, essential to seal the leaking spots e.g. with SEDIMIT. Furthermore, remove all visible pollution on the metal parts e.g. with acetone to enable safe handling of the transformer afterwards.

Secondly it is, to avoid any risk of loss of PCB containing cooling fluid during dismantling and transport, advisable to drain the transformer on its location beforehand according to a well prepared work schedule and provision of all necessary equipment as PCB pumps, drums, personal protective equipment and tools. This procedure has also the advantage that it reduces the total weight of the transformer during transport considerably.

Before draining the oil, precautions for a spill have to be taken by covering the ground with one or two layers of extra strong plastic tarp and drip trays under the crucial parts like the oil pump, hose joints, etc. It is also advisable to have absorbents like sand, cement, or sawdust ready.

Due to the viscosity of the (pure) PCB cooling fluid, it might be difficult to open the drain tap. This has to be considered in advance to find the best possible solution. In case it is not possible to open the tap, drain the transformer via the oil filling cap or by removal of an insulator.

Picture 53: Draining of a PCB transformer

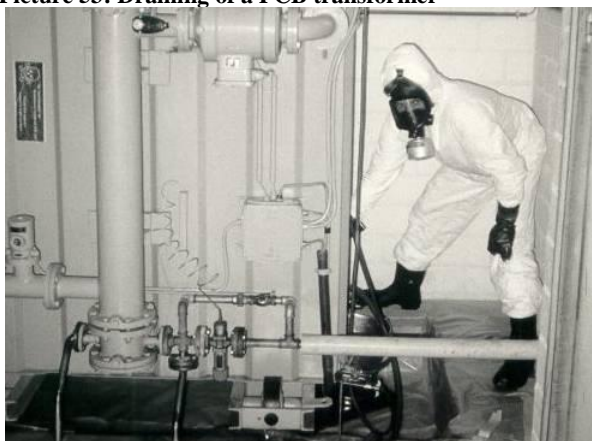

Picture 54: Phase out of an intact PCB transformer



Before the transformer is entirely drained off, it should be positioned at an angle to pump off as much cooling fluid as possible. It must be considered that there will remain some kilos of oil in the transformer after the draining off, which will be sweat out from the windings in time. The drain tap must be closed after the draining activities and, if possible, the transformer should be filled with an absorbent or some sawdust to bind the remaining PCB oil.

After removal of the device from its enclosure, investigate the area visually and decontaminate the floor, trench covers, walls and cables if necessary before installation of a new transformer.

If a transformer is free from damage and has no leakage and a clean surface, and the drainage is not performed on site, then the removal can be done in normal working overalls. Filling the same drum with PCB contaminated oil from different transformers is allowed if their PCB content is known and of a similar concentration. If no information about the PCB content of the oil is available, the oil must be considered as PCB contaminated and the drums with the unidentified oil have to be marked as PCB contaminated.

All persons assigned to handle PCB equipment should be thoroughly instructed in the proposed procedures, particularly with respect to safety precautions, the use of safety equipment and the applicability of national regulations.

Wherever possible, PCB liquids should be transferred by pumping to minimize splashing and spillage. Centrifugal-type pumps, having all wetted surfaces made of stainless steel should be used. The shaft seal should be an external carbon ring type to eliminate exposure of the packing material to the deteriorating effects of PCBs. Valves should be brass or stainless-steel lined. Hoses should be flexible metal or lined with tetrafluorethylene or silicone polymers, and drip trays should be placed under all pumps, valves and hose couplings.

7.2 Phase Out of Capacitors

7.2.1 Preparation

The phase out of capacitors starts with the disconnecting procedure, which has to follow the applicable safety, rules for work on electrical equipment as well as manufacturer's instructions.

Before working on a capacitor or capacitor bank, the following operations must be carried out:

- Ensure that the circuit breaker or power switch and eventual line isolators for the affected capacitor are open and marked with a sign «do not switch works ahead»
- Short-circuit the incoming lines for the capacitor at the earliest 10 minutes after switch off.
- For high voltage capacitor banks connect earthing rods for each rack to the ground circuit by means of braids.
- Most capacitors are equipped with discharge resistors. Nevertheless, the terminals of the capacitor cases have to be shortened before any work is carried out on them, because the discharging circuits may be damaged.

The working area has to be fenced off by red/white plastic bands to avoid unauthorized access. A fire extinguisher has to be positioned, ready to use in case of a fire hazard.

Before the dismantling, it has to be checked if capacitors are leaking or if they are damaged. Leaks have to be sealed. Contaminated surfaces have then to be cleaned with e.g. rags and acetone solvent. Puddles of PCB containing dielectric have to be sucked up by pumps or soaked up by adsorbents. All arising waste has to be collected and disposed of as hazardous waste.



Picture 55: Dismantling of capacitor battery



Picture 56: Inventoried and labelled capacitor

If spills are situated in areas where workers have to enter during the dismantling activities, these areas must be covered with oil absorbent carpet to prevent an entrainment of the contamination by the sole of the rubber boots.

Before packing any UN-approved drum with waste, the drums must be checked (damage, leaks, UN approval).

7.2.2 Dismantling

While dismantling the capacitors, the bushings must be regarded as the «weakest» parts of the capacitors. Especially for heavy capacitors, it is not allowed to hold on to the bushings while carrying them, as they might loosen or break off and cause a spill of PCB-containing fluid. The capacitors must be safely packed into UN-approved steel drums on site.

Picture 57: Bad example of packing and storage

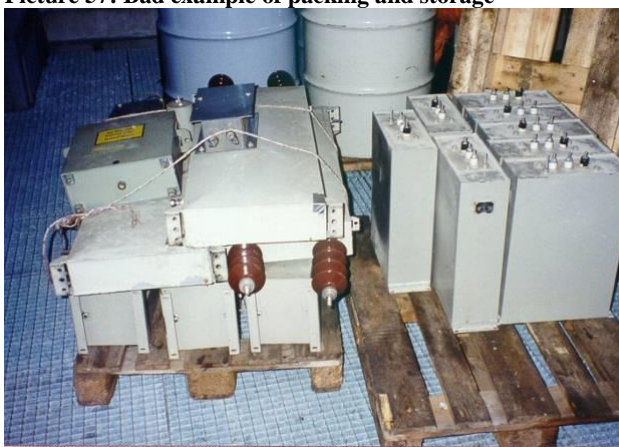

Picture 58: Packing of leaking caps into UN drums



If capacitors have to be stored temporarily, they have to be placed standing upright (bushings up). It is recommended to place them into steel trays or, if not available, on oil absorbing carpets to prevent any spills.

7.2.3 Phase Out of Other Equipment

Other electrical devices like circuit breakers mostly contain small quantities of oil. After the phasing out of such equipment containing oil, it has to be checked e.g. with a suitable test kit if the cooling fluid is PCB contaminated. If the test kit shows a contamination of > 50 mg/kg the equipment must be considered as PCB contaminated and disposed as hazardous waste.

8. Packing

If there are no specific or sufficient national regulations referring to packaging, storage or transport of PCB, the international regulations shall apply.

Transport and packing of dangerous goods are regulated by various international regulations. There is a separate regulation for each means of transport (road, rail, sea) as you may see in chapter 10.1. The packing instructions are very similar to each other. The specifications of the different packaging types for PCB containing material according to the ADR (European Agreement concerning the International Carriage of Dangerous Goods by Road) are mentioned below:

8.1 Packing According to ADR

Due to the easy handling, open head steel drums are usually used for solids and tight head steel drums for liquids, respectively.

Table 31: Packaging types

Packaging Type	Purpose	Packaging Type Code
Tight head steel drum	Liquids	1A1*
Open head steel drum	Solids	1A2*

* Explanation of packaging type codes:

- The codes 1A1 and 1A2 describe the packaging type:
- The first figure specifies the kind of packaging (1 = drum)
- The letter describes the material (A= steel)
- The second figure characterizes the opening (1=tight head drum, 2=open head drum)

The maximum volume authorized by the ADR is 450 litres. However, drums with a volume of 220 litres are easier and safer to handle and therefore usually chosen. In addition, a volume of 220 litres is also permitted for a transport by sea (IMDG limit for liquid PCB: 250 litres).

Picture 59: Open head drum



Picture 60: In print UN approval



Packaging must conform to the construction and testing instructions stipulated in the ADR regulations. Strength and tightness are tested. UN approved steel drums have an imprint to prove a successful testing.

For the transport of PCB containing capacitors, the code can read as follows:

UN 1A2 Y 400 03 CH2025, meaning:

Table 32: Code for UN approved drums

UN	Symbol of the United Nations or the letters UN
1A2	Code for packaging type
Y	Two-part code: Letters of packaging group
400	For solids: Maximum gross weight in kg (example)
03	The last two figures of the year of manufacture (example)
CH2025	Manufacturer's code (example)

In case of liquid PCB, drums must never be completely filled. Approx. 50 mm or 10 % of the volume should be left empty for a possible extension of PCB in case of higher temperatures. Pumps should be used to fill the drums; pouring the liquid from one drum into another is no viable option. As disposal prices and techniques depend on the kind of waste, liquid and solid wastes should always be separated.

The European Agreement concerning the International Carriage of Dangerous Goods by Road (ADR) was done at Geneva on 30 September 1957 under the auspices of the United Nations Economic Commission for Europe, and it entered into force on 29 January 1968. The Agreement itself was amended by the Protocol amending article 14 (3) done at New York on 21 August 1975, which entered into force on 19 April 1985.

The Agreement itself is short and simple. The key article is the second, which says that apart from some excessively dangerous goods, other dangerous goods may be transported internationally in road vehicles subject to compliance with:

- the conditions laid down in Annex A for the goods in question, in particular as regards their packaging and labelling; and
- the conditions laid down in Annex B, in particular as regards the construction, equipment and operation of the vehicle transporting the goods in question.

Annexes A and B have been regularly amended and updated since the entry into force of ADR. The last amendments entered into force on 1 January 2007, and consequently, a revised consolidated version was published as document ECE/TRANS/185, Vol. I and II ("ADR 2007").

Annex A: General provisions and provisions concerning dangerous articles and substances

Part 1: General provisions

Part 2: Classification

Part 3: Dangerous goods list, special provisions and exemptions related to dangerous goods packed in limited quantities

Part 4: Packing and tank provisions

Part 5: Consignment procedures

Part 6: Requirements for the construction and testing of packaging, intermediate bulk containers (IBCs), large packaging and tanks

Part 7: Provisions concerning the conditions of carriage, loading, unloading and handling

Annex B: Provisions concerning transport equipment and transport operations

Part 8: Requirements for vehicle crews, equipment, operation and documentation

Part 9: Requirements concerning the construction and approval of vehicles

8.2 Summary of Possible Containers for PCB Transports

Apart from the commonly used steel drums, also other packaging types can be used, as long as they are UN approved and comply with the instructions of the ADR for the transport of the goods.

UN approved drums or containers should only be procured from an authorized manufacturer (ask for UN Certificate).

Table 33: Summary packaging

Packaging		
Waste Type	Containers	Dimensions
PCB liquids	UN approved steel drums for liquids 1A1 Large packaging IBC, 31A., 31B, 31N Tank Containers	60 to 220 liters 500 to 1250 liters Various sizes
PCB capacitors	UN approved steel drums for solids 1A2	Usually 220 liters
PCB transformers (only when drained!)	Steel trays 20' Box Containers with tip tray	Height over 800 mm Various
PCB solids, (metals, soil, debris)	UN approved steel drums for solids 1A2	Usually 220 liters
Damaged packaging (e.g.220 liters steel drums)	Recovery drums Various types	Recovery drums Various types 307 liter und 427 liter

There are many different types of UN-approved packaging available. The choice of the appropriate packaging depends on type of waste, quantity, mode of handling/transportation but also foreseen method of disposal/treatment. For contaminated soil it might be advisable to use UN-approved Big Bags.

Picture 61: UN approved steel drums



Picture 62: Different types of alternative PE packaging



As described, UN approved steel drums have an imprint to prove a successful testing. Where an imprint is not possible, the containers must have an UN approval plate stating conformity to UN regulations.

Picture 63: Example of UN approval plate



Special bulk containers can be used for the storage or transport of PCB containing or contaminated solids as long as they conform to UN standards. A respective UN approval plate must be affixed to such bulk containers.

Picture 64: UN approved ICB solids



Picture 65: UN approved IBC liquids



Picture 66: 20' tank container liquids



Due to safety and handling reasons, however, PCB wastes should ideally be packed into UN approved steel drums. For example, capacitors shall be packed into UN approved drums (1A2). In the drum, they must always be stored standing upright. Any moving of the waste inside the drum has to be avoided, i.e. by using absorbents, wood, rugs, etc.

Picture 67: Phase out and cleaning of PCB capacitor



Picture 68: PCB capacitors in steel drum



Special attention is needed during dismantling and packing of leaking PCB containing capacitors. The main aim shall be to avoid cross contamination. Therefore immediately after phase out of the capacitors, the devices need to be placed in a drip tray. The surface should be cleaned and if necessary a leakage stop device can be used. When packing capacitors an appropriate part of the area shall be covered with e.g. chemical absorbing industrial carpet, an oil absorbent sheet or other suitable materials, in order to protect it from cross contamination or incidents during the packing procedure.

The lid should be removed from an empty drum and the drum carefully checked for damages as also new drums could be punctured due to careless handling. Ideally, PE-LD drum inlets are first placed in the drums. Then a thin layer of oil absorbent (e.g. absorbent material) should be placed in the drum. The PCB containing capacitors can then be carefully placed in the drum. As many capacitors as space allows may be placed in a drum. Ideally, appropriate material like Styrofoam should be placed between and around the single devices so that movement during transport will not be possible. Of course, all this depends on the size of the electrical devices and is mainly for low and medium voltage capacitors. If the height of the capacitors exceeds the drum, it might be necessary to carefully break off the bushings. Such activities shall only be allowed after the capacitors have been put into drums. Capacitors already placed in drums (upright position), but showing leaking isolators, do not pose a risk. Additionally, a layer of sawdust should be placed in each drum, in order to absorb any liquids if necessary.

According to today's regulations, unpackaged transformers and capacitors may be carried in cargo transport units fitted with a leak proof steel tray, having a volume of at least 125 % of the remaining PCB liquid in the transformer and a height of at least 800 mm, and containing sufficient inert absorbent material to absorb at least 1.1 times the volume of any free liquid.

Picture 69: Preparation: transportation of PCB transformer



Picture 70: Covering the bottom with absorbent material



Adequate provisions shall be taken to seal the transformers and capacitors to prevent leakage during normal conditions of carriage.

Due to their size, transformers cannot normally be packed in boxes or even drums. Therefore, they have to be prepared and loaded on trucks in such a way, that no contamination of the surrounding materials is possible. Precautions have to be taken to prevent leakage and secure the devices.

Picture 71: Loading of transformers



Picture 72: Stowing of transformers



Due to safety reasons, UN approved drums or alternatively UN approved boxes, should be used, whenever possible.

Picture 73: Example of alternative metal boxes



Picture 74: Further alternative metal boxes



Damaged or leaking drums as well as drums that do not conform with the regulations must be stored and transported in recovery drums. Appropriate measures must be taken to prevent movements of the inner drum.

If the recovery drum carries liquid PCB, a sufficient quantity of absorbing material should be added to immediately absorb possible liquid coming out of the inner drum.

Picture 75: Recovery drum I



Picture 76: Recovery drum II



Picture 77: Plastic recovery drum



8.2.1 Labelling of the Packaging

The labels identify the dangers posed by the packed goods and is destined to attract the attention of the person handling the goods to take the necessary precautions during storage or transport.

The «Orange Book» defines the identification of a hazardous material or article. These assigned identification numbers are also generally referred to as «UN numbers».

Table 34: UN numbers for PCB

UN 2315	Polychlorinated biphenyls, liquid
UN 3151	Polyhalogenated biphenyls, liquid or Polyhalogenated terphenyls liquid
UN 3152	Polyhalogenated biphenyls, solid or Polyhalogenated terphenyls solid
UN 3432	Polychlorinated biphenyls, solid

8.2.2 Labelling for Storage or Transport

If waste is transported by road (ADR), each packaging must be marked clearly and durably with the UN number of the contained goods, the letters “UN” coming first. A label of class 9 “Miscellaneous dangerous substances and articles” must be affixed to each packaging (see Picture 78 and Picture 79). In case of recovery drums, the designation «OVERPACK» must be added.

Remark: The class 9 pictogram is included in the UN Model Regulations but has not been incorporated into the GHS because of the nature of the hazards. In the GHS system the nature of hazards has been defined in such a way that various class 9 materials are included in other more specific classes. Nevertheless, the transport labels are still the same as in the Dangerous Goods transport regulations. GHS only concerns the packaging of materials and concerning waste there are some exemptions, in other words, less stringent definitions concerning the exact composition of materials. Consequently, class 9 is used when transporting PCBs.

Picture 78: Labeling Acc. to ADR for liquid PCB

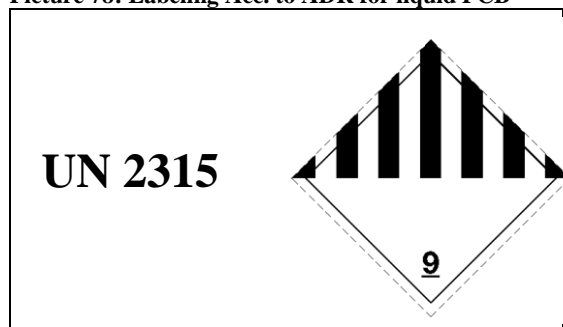

Picture 79: Labeling Acc. to ADR for solid PCB

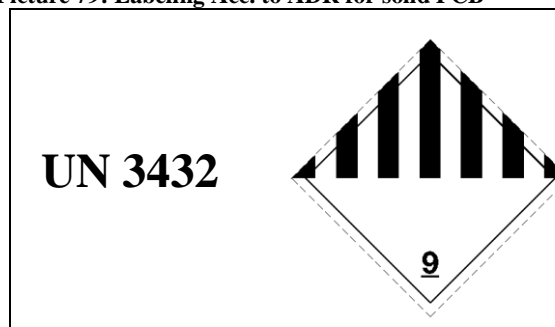

The UN number for PCB capacitors is UN 2315.

The identification of containers for a transport by **sea** is different. The IMDG (International Maritime Dangerous Goods Code) applies for such shipments.

In addition to the UN number, the proper shipping name (PCB) must be mentioned and some indication about the condition of the contents (LIQUID or SOLID) must be made. The class 9 label as well as a marine pollutant label must be affixed on the containers. Since 2009 a new marine pollutant label shows a dead tree and dead fish.

Picture 80: Labelling of liquid PCB according to IMDG

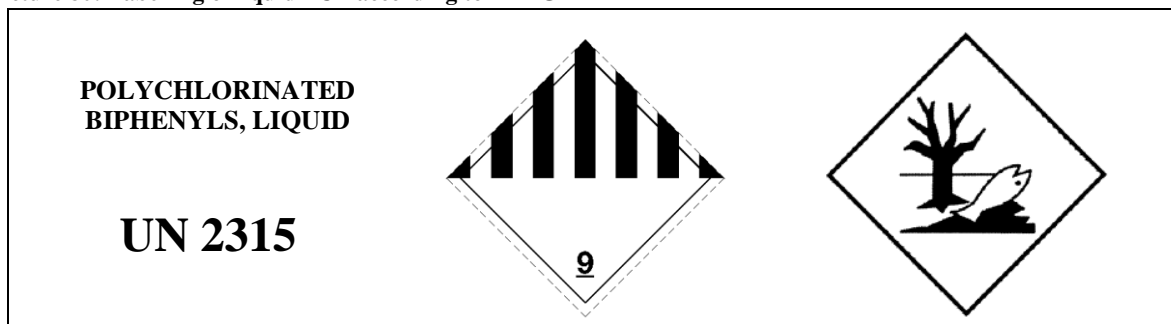

Picture 81: Labelling of solid PCB according to IMDG

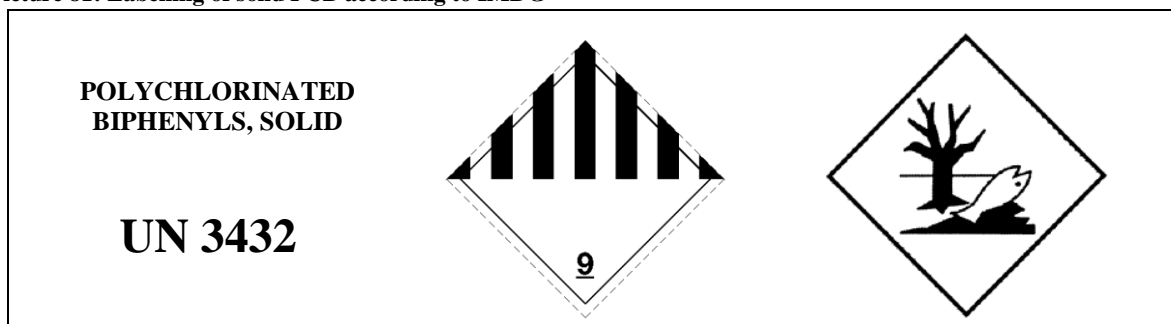

The weatherproof drum/container labels should at least contain the following data:

- UN number
- UN classification
- "HAZARDOUS WASTES"
- Waste identification code
- Waste designation
- Tracking form number

Additionally it is advisable to add the following:

- Origin of the wastes
- Weight of the drum
- Drum tracking number

Examples of labels to be used for PCB waste declaration:

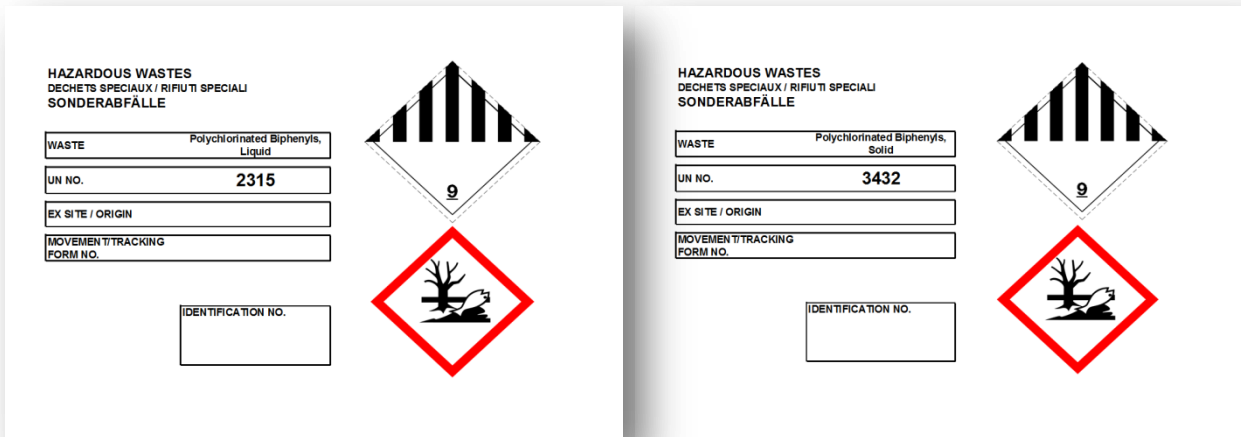

8.3 Handling of Packed Waste

It is essential to weigh the packed drums. If possible a mobile scale can be used on site. This allows a reliable planning of the transport of the waste. The following information shall be additionally written clearly on the lid of the drum:

- Contents
- Name of the location, where the packed goods originate from
- Date
- Weight and signature

Picture 82: Safety Drum lift



Picture 83: Marking the drums



The drums with open lid must be secured by «splints». Full drums should preferably be carried by a safety drum lift, forklift or crane. If using a crane, there are special drum clamps available for safe handling. Only checked and clean drums shall leave for disposal respectively to the temporary storage area.

Packaging depends on type of waste, waste quantity, mode of transport and method of treatment or disposal. Further details are mentioned in chapter 8.2.

9. Temporary Storage

9.1 Temporary Storage - On Site

PCB containing wastes should generally not be stored on sites that are not specifically designed for interim storage of hazardous wastes. Usually, there is no appropriate infrastructure to guarantee a safe storage. Uncontrolled and inexpert interim storages as shown in the pictures below endanger people and the environment, and result in unnecessary additional costs.

Picture 84: Bad example I (open air storage)



Picture 85: Bad example II (no tip trays)



PCB containing devices should be packed safely and in compliance with the applicable laws (see chapter 8.1.) as soon as they have been phased out, even if their disposal takes place at a later stage. Irrespective of the quality of the temporary storage, the final and environmental sound disposal of the waste must be scheduled and coordinated so that **storage will not exceed twelve months**. Generally, electrical equipment should only be phased out and stored, once an appropriate method of disposal has been chosen.

When setting up a temporary storage for PCB wastes it is important to choose an appropriate storage area. Locations close to rivers, groundwater, residential or farming areas, and ecological reserves or for example food processing industries CANNOT be considered suitable. If possible, the interim storage should be specifically designed for PCB containing equipment and wastes.

Table 35: Minimum requirements for temporary storage on site

Packing

- Capacitors must always stand upright. The insulators are the weakest parts. Never lift a capacitor by holding the insulators, they can easily break off.
- Capacitors must be stored on steel drip trays and leaking devices should be sealed. It is advisable to add absorbents to the steel trays.
- It is possible to put capacitors and contaminated solids into containers that are not UN approved. However, such containers must be checked for damage and leaks before use and cannot be utilized for transports. After use, the containers must be regarded as contaminated and also be disposed of as hazardous waste!

Building

- The floor of a temporary storage must be solid and tight. The storage must be walled and protected against the weather on all sides.
- All entrances to the storage must be marked with an appropriate warning, and access for unauthorized people must be forbidden.
- The area must be fenced and controlled.
- Display emergency procedures and best working practices (see Annexes 12.8 and 12.9).
- The building should have some openings for permanent ventilation (ventilation systems with filters).
- Increased risks of fires must be excluded (no wooden shed, no storage of inflammable goods in the same building or in the neighbourhood). A smoke and fire alarm system should be installed.
- Fire extinguishers (powder) and absorbents (e.g. sawdust) must be available and easy accessible.
- The building should be separated in different areas (reception, handling, separate storage of different waste categories, equipment, etc.)
- No food storage or food processing companies in the neighbourhood.

All goods/wastes must be clearly marked giving information about the kind of waste, the date of packing, the weight, the origin and further important data. An up to date storage list must be accessible at any time.

Temporary storage CANNOT be accepted as long-term solution.

Picture 86: Example 1 of a sound storage platform

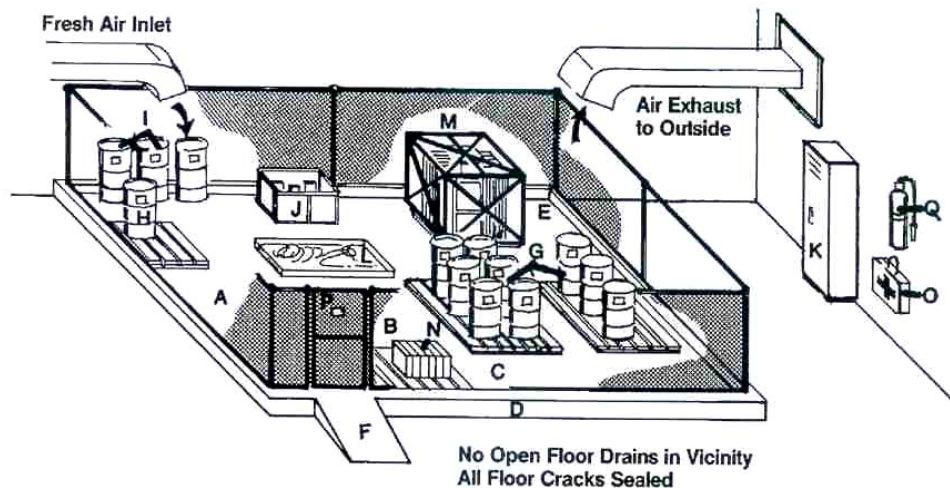

[Source: unknown]

Legend

- | | |
|----------------------------------------------------------------------------------------------|------------------------------------------------------------------|
| A - security fence | H - recovery drum |
| B - padlocked door | I - spare drum |
| C - concrete floor (no drains) | J - clean-up materials, stored in bin |
| - all cracks and expansion joints between slabs sealed with compound | K - locker for PPE worn when working with PCBs |
| - floor painted with epoxy paint to prevent PCBs to penetrate in concrete | L - pumps and hoses for use with PCBs laid in a drip tray |
| D - concrete curb around perimeter of storage area; inside of curb painted with epoxy | M - scrapped transformer in protective crate |
| E - sealing compound (grouting) at corner of curb to prevent leakage under curb | N - delivered capacitors on pallets for packing |
| F - ramp over concrete curb, into storage area | O - first-aid kit |
| G - drums containing PCB-wastes | P - PCB label on door |
| - stored on pallets for mobility | Q - powder or foam-type fire extinguisher |

9.2 Central Storage Platform

A central storage platform shall provide the necessary storage room, where PCB devices and associated waste can be collected and stored until their final disposal. Such a platform could also be used as a «buffer zone» by regional or national authorities, or by waste treatment / disposal plants to guarantee a constant running of their plants.

PCB equipment and PCB wastes shall be stored according to their category or priority. Appropriate areas shall be defined for each type/category of PCB waste. Ideally, already existing storage facilities, for example the facilities of PCB equipment holders could be upgraded to meet safe and professional standards.

Available Site

The available site must be carefully monitored and reported in respect of existing groundwater and its level, existing soil contaminations as well as permeability of underground. The most suitable location shall be defined under consideration of the following criteria.

- The storage building shall be located and maintained in conditions that will minimize volatilization, including cool temperatures, reflective roofs and sidings, shaded location, etc.
- The surrounding land should be sloped to provide drainage away from the site
- The area must be fenced and controlled
- All entrances to the storage platform must be marked with appropriate warnings

- An access control system shall be installed to ensure access of authorized staff only

Human and Environmental Hazards

PCB belongs to the group of POPs banned by the Stockholm Convention. Therefore all relevant precautions must be provided to avoid human and environmental hazards. The entire interim storage facility must meet BAT and BEP requirements.

Technical Hazards

The whole area used by the interim storage facility must be protected against spillage of contaminated oil and of chemicals.

Area Preparation

- Wherever necessary, the ground must be sealed with adequate material, considering PCB but also associated solvents and chemicals when handling and treating PCB containing electrical equipment and oil. The sealed area must be dewatered with special sewers, capable for retaining any oils and other insoluble organics.
- Due to the possibility of fire hazards efficient fire protection and firefighting equipment must be provided. In combination with the firefighting equipment an appropriate collecting volume for effluent water must be provided.

Logistics

- The existing transport infrastructure to and from the area (road and railways) shall be used for the proposed storage facilities.
- The building shall be accessible by forklifts and trucks.
- There should be enough space for any truck or crane movement in front of the building. This central receiving area where PCB equipment and wastes are loaded and unloaded from transport vehicles should have a PCB impervious floor and containment system to properly control any spills during loading or unloading.

Handling of Incoming Goods

- Each incoming waste delivery shall be examined and checked as follows:
 - Internal information and weighing
 - Check of accompanying tracking forms/sheets, sampling and visual check of wastes
 - If necessary, screening of waste sample
 - Labelling and storage at defined storage area, according to waste category
- Only equipment accompanied by duly signed tracking forms/sheets shall be accepted and stored in the interim storage. Tracking of the waste generator must be ensured at any time.
- Transformers for dismantling or revision, delivered by rail or road transport must be kept in a covered and spillage protected area until they are tested for contamination with PCB. After testing they shall be stored inside the storage building in separate compartments for contaminated and not contaminated units. If ever possible, the transformers shall be stored on racks mounted on drain trays. But if stored on racks or not, all units must be placed in such drain trays.
- Handling equipment like overhead cranes and forklifts for all kind of transformers shall be provided.
- Every container with transformer oil, which is present in the intermediate storage facility must be tested, labelled and stored in compartments according to their contamination.

Capacity

- There shall be an intermediate storage in a suitable size for the needs of the area/region. It is recommended to store as a maximum 25 transformers in sizes of 200 to 1'500 kVA as well as boxes and drums with some 150 to 200 tons of PCB waste.
- These maximum capacity restrictions shall assist in keeping the intermediate storage platforms real temporary and no long-term solution storages.

- Capacitors and wastes which cannot be treated shall be shipped to a licensed disposal facility within Europe on a periodical basis.
- PCB wastes shall be packed in accordance with the instructions stipulated in the ADR, RID and in some cases also according to IATA.

Foundation

- The storage building must contain a foundation suitable for mounting metal sheet walls and roof as well as piles designed to support overhead cranes for the handling of the delivered transformers.
- All structures above ground level must be coated and sealed like the floor.

Floor

- The floor profile must be shaped in a way that no spillage from transformer handling or effluent from firefighting may flow outside the facility into the unprotected area.
- All floors inside the storage building must be industrial type floors (e.g. steel or concrete) and sealed with a PCB resistant sealant such as two-component epoxy paint.
- It is recommended that the sealant coating is inspected periodically to check its integrity.
- The building shall be set on asphalt or concrete.
- The floor inside the building shall be concrete; coated with a durable epoxy polymer to prevent PCBs to penetrate in concrete.
- The floor must be solid and tight, all cracks and expansion joints between slabs must be sealed.
- Floor drains shall be reduced to a minimum and must be connected with an internal sump.

Curbs

- The storage area for transformers within the intermediate storage shall contain 6 inch high curbs that provide a containment volume equal to at least twice the internal volume of the largest PCB item.
- Concrete curb around perimeter of storage area; inside of curb painted with epoxy. Sealing compound (grouting) at corner of curb to prevent leakage under curb.
- The storage building may not have any openings, expansion joints or drains that would permit liquids to flow from the curbed area.
- A ramp over the surrounding concrete curb shall be provided to allow access with forklifts into the storage and handling area.

Walls, Doors and Windows

- The walls of the storage building may consist of a light metal sheet construction. Doors and windows have to be foreseen according to the requirements of the user, logistics and treatment process.
- Doors must open to the outside. Minimum width for any door is 80 cm.
- Windows must be planned and built in such a way that they face each other.

Roofing

- In order to prevent the atmosphere in the storage building from extended temperatures (vapour pressure of PCB!) the roof shall be reflective.
- The roofs of the building shall be sloped so as to provide drainage away from the site.

Layout of the building

The building shall be separated in different areas:

- Reception area
- Handling area
- Treatment area
- Separate storage areas or rooms for each type of PCB waste:

- PCB containing transformers
 - PCB containing capacitors
 - Drums with PCB oil
 - PCB solid wastes
- Equipment area
 - Office
 - Sanitary installations

There must be a fairly big working area, where e.g. transformers can be drained or waste handled and packed. The floor of this area should be preferably covered by steel (like a drip tray) and absolutely tight, optionally, a special, PCB resistant epoxy coating could be applied.

PCB wastes should be packed as to ensure that the potential for leakage or spills is kept to a minimum (e.g. in UN approved drums). The containers should be clearly labelled and marked with the date of entry to the storage. Drums or other portable containers of PCB and PCB equipment should be placed on pallets.

Sufficient space should be left between stored containers and equipment to permit inspection and allow the safe movement of vehicles such as forklifts. Drums or other containers of PCB liquids should be separated from each other by pallets and not stacked more than two containers high.

Ventilation

- A ventilation of the entire storage facility must be installed to avoid elevated concentrations in the atmosphere of PCB and other POPs which might be present. Generally the exhausted air must be cleaned by activated carbon filters. If necessary, the ventilation must be supported by an induced draft fan.
- A fresh air inlet shall be installed in accordance to induced draft fan specification. If there is no specific legislative requirement a guideline will be a twofold to sixfold air volume exchange during normal operation with the possibility to increase to tenfold or twelvefold in case of high gas concentration alarm.

Fire alarm / Fire protection

- Due to the extreme environmental and health hazards in case of a fire in the storage building, it is very important that a smoke- and fire alarm system covering the entire facility will be installed.
- The detection-, alarm- and fighting system must meet all relevant national and community regulations as well as international BAT and BEP standards.
- The building shall have a fire suppression system; preferably a non-water system. If the fire suppressant is water then the floor of the storage room shall be curbed and the floor drainage system must not lead to the sewer or storm-sewer or directly to surface water but should have its own collection system such as a sump.
- Fire extinguishers (powder) and absorbents (e.g. sawdust) must be available and easily accessible.
- A lightning protection system covering the whole interim storage facility must be installed.

Electrical Installations

- All the electrical installations must be installed at least 1.5 meters above ground level to assure a certain protection against explosion risks.
- The quantity and design of electrical connectors shall be defined in cooperation with the operator of the waste preparation units.

Installations for control of water run-offs

- The sumps within the protected area shall contain a level alarm high and high+.
- Water run-offs and canals must be leak-proof and easily accessible for cleaning purposes.

Pipelines

- Any pipeline to be installed in the interim storage facility must be over ground.

Emergency equipment

- All the necessary emergency equipment for a safe shut down of the plant and all necessary equipment for a safe and controlled evacuation of the storage facility in case of fire must be available and easily accessible.

Emergency response plan

- Emergency procedures and best working practices shall be displayed.

Health and safety plan

- A health and safety plan shall be displayed.

Spill prevention, control and countermeasure plan (SPCC)

- The site should be subjected to monthly inspections for leaks, degradation of container materials, floors, drains, draining systems, personal protection equipment, integrity of fire alarms and fire suppression systems, vandalism, security fences and general status of the site.

Database of Interim Storage Platform

- A complete database of the PCB wastes and other equipment and chemicals in the storage site shall be created and kept up to date as waste is added or disposed of. The records should include:
 - An inventory of each item of PCB waste and the quantity of PCB therein
 - The date and source of PCB waste transferred to storage and the date and destination of waste leaving storage
 - A description of the PCB waste including the quantity and concentration of PCBs, nameplate description where available
 - Identification number for the PCB waste
 - Name of carrier of PCB waste
 - Name of recipient of PCB waste
 - Date and quantity of PCBs spilled as a result of a leak or accident and clean-up procedures adopted
 - Dates and details of inspections by the competent authorities and the owner
 - The responsible fire brigades and environmental authorities shall be informed about the amount of PCB wastes in stock periodically (e.g. every 2 weeks), by providing them with a copy of the latest stock list/records.

Personnel working at the facility should be made clearly aware of and understand current PCB waste management procedures including the use of personal protection equipment and clean-up techniques.

The above inputs shall be taken as general advice and recommendation. However it is important to review them at the time of construction or upgrading of an existing storage facility together with the competent local and governmental authorities as regulations and guidance may change.

Picture 87: Example 2 of a sound storage platform

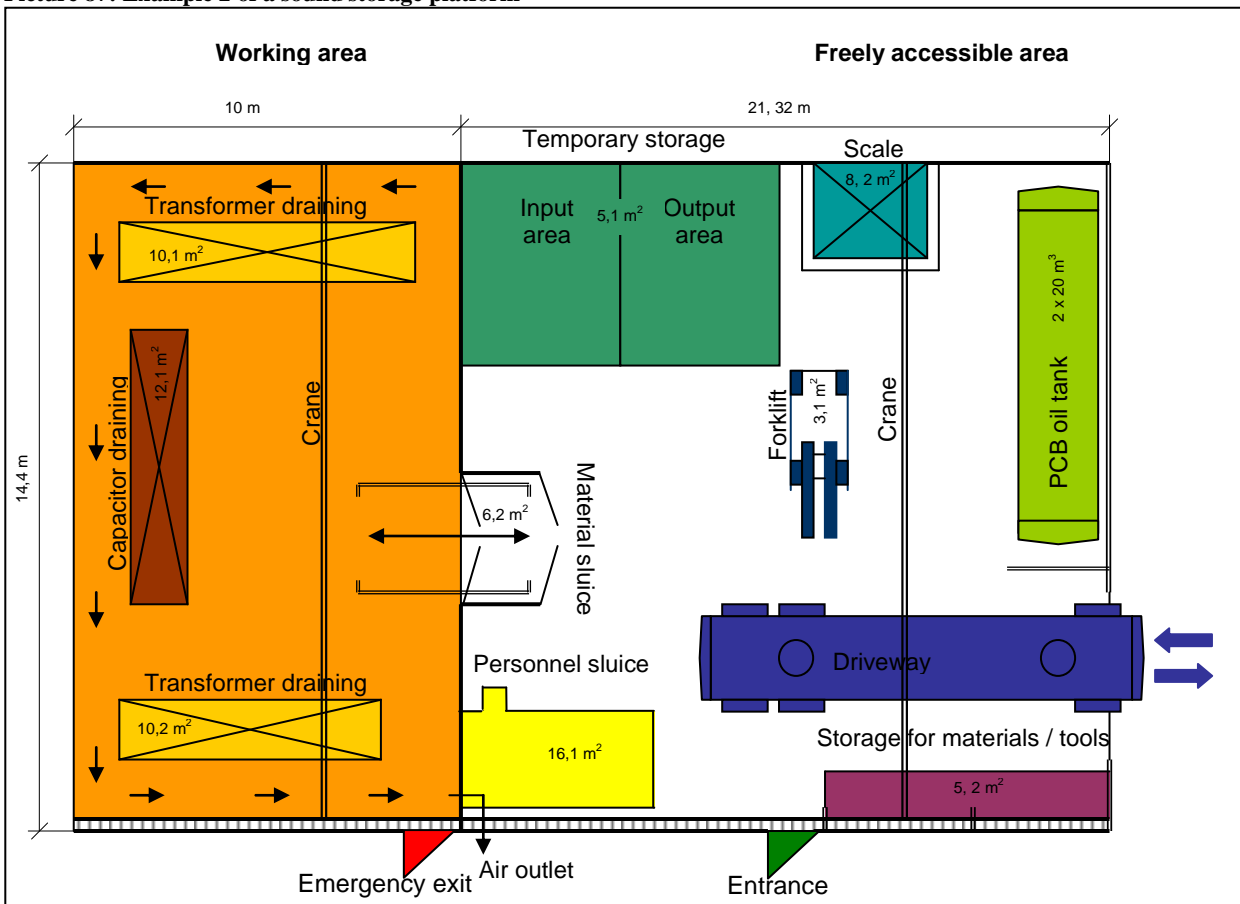

If there is neither a storage platform as previously described nor another possible interim storage building, a kind of mobile interim storage could be installed for short-term use. Depending on the quantity of the arising waste, 20' or 40' Box Containers with integrated drip trays as safety precaution could be an option.

Picture 88: Typical 20' Box Container with trip tray



Picture 89: Short term storage in containers

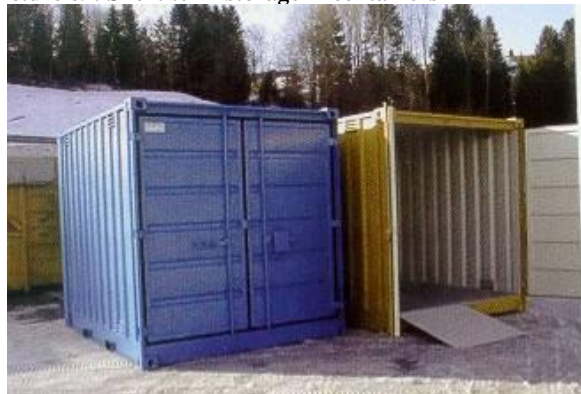

It should be considered that usual Box Containers do not contain a steel ground but only wood and therefore need to be adopted.

9.3 Authorization and Control

The establishment of an interim storage facility or a central storage area is only possible after submission of an Environmental Impact Assessment study and is subject to authorization of the competent authorities.

It is further recommended that an extension of temporary storage beyond the period of 12 months shall also be subject to authorization by the competent authorities.

10. Transport

10.1 International Regulations for the Transport of Hazardous Goods

Depending on the means of transport for hazardous goods, the following regulations are applicable:

- ADR (European Agreement concerning the International Carriage of Dangerous Goods by Road)
- IMDG (International Maritime Dangerous Goods code/transport by sea)
- RID (Regulation for the international transport of hazardous goods on railways)
- IATA DGR (IATA regulations on the transport of hazardous goods/air transport)
- United Nations Recommendations on the Transport of Dangerous Goods Model Regulations (Orange Book)

Picture 90: ADR



Picture 91: IMDG



It should be noted that various regulations (ADR/IMDG/RID/IATA-DGR) are substantially similar to one another. The only difference is that special packaging, labels or quantity limits are specified for the different means of transport, depending on the type of hazardous goods.

ADR

Obligations of Main Actors

Basically, the ADR distinguishes between three main actors, whose obligations are described as follows:

Exporter

- To check if the goods to be transported are classified and approved for shipment.
- To supply all necessary transport documents.
- To only use UN approved packaging that are correctly marked and labeled.

Carrier

- To make sure that all necessary documents are carried along in the vehicle.
- To check if the freight is in good condition, i.e. no visible damages like leaks or cracks.
- To make sure that the vehicle is not overloaded.
- To make sure that the placards and labels are affixed.
- To make sure that the equipment as stipulated in the written instructions for the driver are carried along in the vehicle.
- Not to transport the freight if it does not comply with the regulations.

Importer

- Not to delay the acceptance of the goods without compelling reason, and to check after the unloading if the ADR instructions concerning the import are fulfilled.
- To clean and decontaminate vehicles and containers.
- To make sure that any labels, marks and signs are no longer visible on the completely unloaded, cleaned and decontaminated container.

10.2.2 Documentation

The following documents must accompany every shipment in accordance with the ADR:

Movement document

The following data of every single good/waste must be mentioned on the movement document:

- UN number, with the letters «UN» in front of the number
- If the goods are wastes, the word «WASTE» must be written in front of the UN number
- The official designation (Polychlorinated Biphenyl) plus the technical term (PCB)
- UN class (9)
- Packaging group
- Packaging type and number of packaging
- Total quantity of each dangerous good with different UN number
- Name and address of exporter
- Name and address of importer

Container packing certificates

If dangerous goods are transported in box containers by sea, a container packing certificate must be enclosed to the movement document. Basically, the container packing certificate confirms that the goods have been packed and loaded according to paragraph 5.4.2 of the IMDG Code. The container packing certificate can be integrated in the movement document. An example is shown in Annex 12.19.

Written instructions

To be able to take actions immediately in case of an accident or an incident, the driver must be provided with transport emergency cards for each transported dangerous good briefly informing about the following:

- Designation, class and UN number
- Possible dangers that can be posed by the goods
- Necessary additional equipment
- Measures to be taken

Not only ADR regulations but also Basel Convention procedures and documents must be considered for international transports of hazardous wastes. The two regulations sometimes overlap and it is e.g. sufficient to use the Basel Convention Movement Document (see Annex 12.18.) to accompany the transport.

10.3 National Transports

National transports of PCBs and PCB wastes have to be in accordance with the national hazardous goods regulations and laws.

If necessary, national legislation to regulate criteria for the transport of hazardous wastes, such as insurance, registration and license and safety aspects, shall be developed.

Also during national transport a movement document shall accompany the wastes at any time.

Picture 92: Example of possible nation tracking form

Tracking Form	No. AA 123 123 123
<p>Consignor (name, address)</p>	<p>Contact person: Telephone: Date:</p>
<p>Waste (designation / chemical composition of waste)</p>	<p>Waste identification code: UN number: Quantity: (kg / litres) Packaging: (Type / number)</p>
<p>Consignee (name, address)</p>	<p>Contact person: Telephone: Quantity: (kg / litres) Method of disposal: Date:</p>
<p>Carrier (name, address)</p>	<p>Contact person: Telephone: Means of transport: Date:</p>

10.4 Transboundary Movement of Hazardous Waste

When exporting PCB wastes to other countries, the procedures stipulated by the Basel Convention (see chapter 1.2) have to be followed. One important condition under the Basel Convention is that a transboundary movement of hazardous wastes or other wastes can take place only upon prior written notification to the competent authorities of the States of export, import and transit, and upon consent from these authorities permitting the transboundary movement of waste.

Furthermore each shipment of hazardous waste or other waste shall be accompanied by a movement document from the point at which a transboundary movement begins to the point of disposal (see Annex 12.8).

Please contact the competent national authority for specific information:

10.5 Loading and Safety Check before Transport Takes Place

The type of packaging and transport depends on the chosen method of disposal and may vary. It should be considered that beside the national and international packaging regulations also the disposal facility might have special specifications.

No person shall handle, offer for transport or transport PCBs or devices containing PCBs, including waste, unless he is trained to do so, or is performing those activities under the direct supervision of a trained person.

10.5.1 Loading on a Truck for Local Transports

All hazardous wastes ready for transport have to be packed and labelled according to the ADR (see chapter 8.).

10.5.2 Loading of Containers for International Transport

Due to safety reasons, it must be considered that PCB containing waste should be loaded at one go. Therefore, the loading of containers is performed shortly before their transport.

The containers have to undergo an examination by an accredited Customs Office. Before the containers are loaded, it is first necessary to check their condition again. Dust and dirt on the loading surface have to be removed.

Each single drum has to be checked for safety and possible damages. The drums have to be handled carefully. The code, content, number and weight of every loaded drum have to be recorded in a Container Loading List.

For the weighing activities a calibrated mobile scale has to be used. Only units that are given free from inspection and weighing may be loaded.

There are various types of Containers which can be used for the transport of hazardous wastes:

Picture 93: Different types of containers

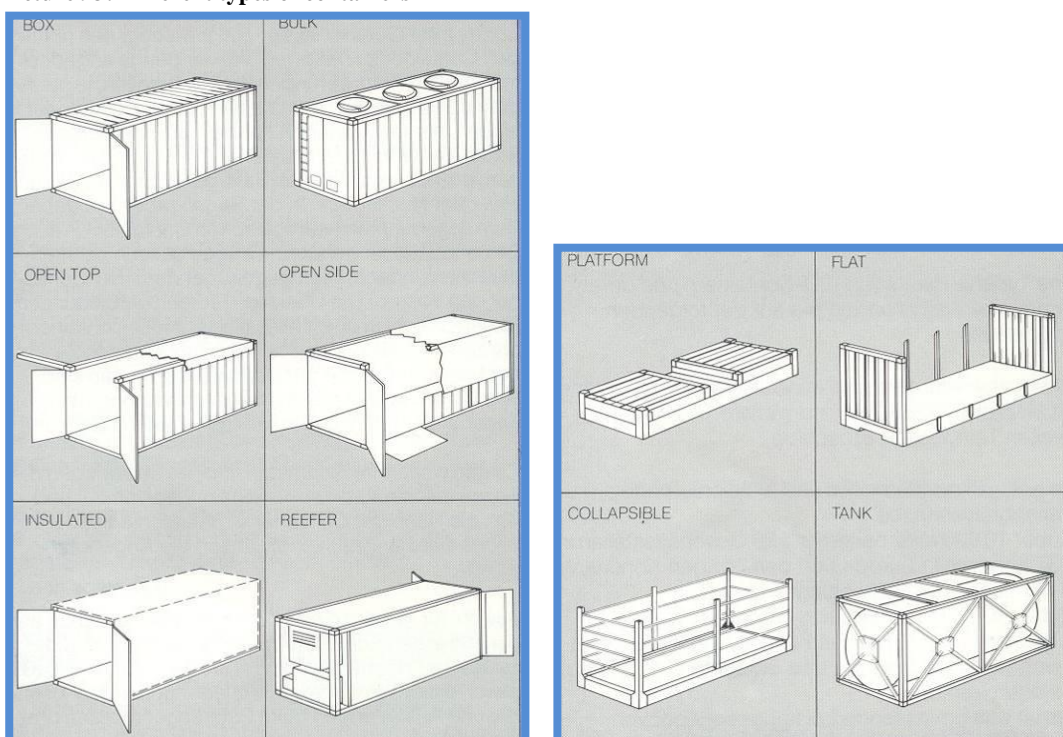

When wastes are transported over long distances, it is particularly important to ensure that the load cannot shift. The load can be ideally secured by optimal utilisation of space and by safety measures like tightening belts, antislip wooden boards and air bags. It is also necessary to ensure that the weight of the individual packaging in trucks or containers is evenly distributed.

Furthermore, the total gross loading weights, which vary from country to country, must be considered.

Picture 94: Movements of containers e. g. on ships to be considered

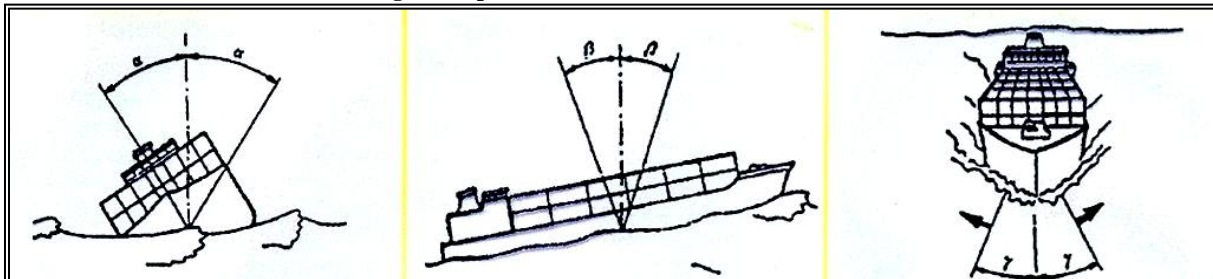

If 20' Box Containers will be used for transportation, there is space for 36 UN approved drums in one layer. The containers shall be loaded with two layers of drums, therefore a total of 72 drums may be loaded into one container. The next picture illustrates how the drums are loaded in the container with a floor between the layers, made of plywood planks.

Picture 95: Top View of loaded 20' box container

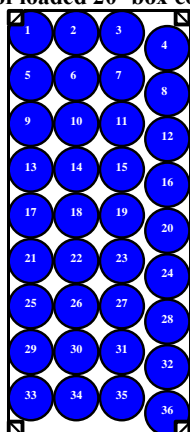

Picture 96: Side view of loaded 20' box container

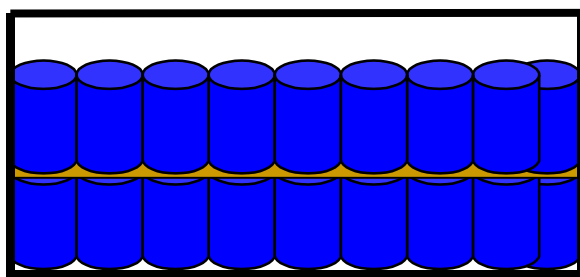

1st layer: 36 drums
 2nd layer: 36 drums
 Total: 72 drums per Container

Picture 97: Loading of container



Picture 98: Lifting of containers to truck

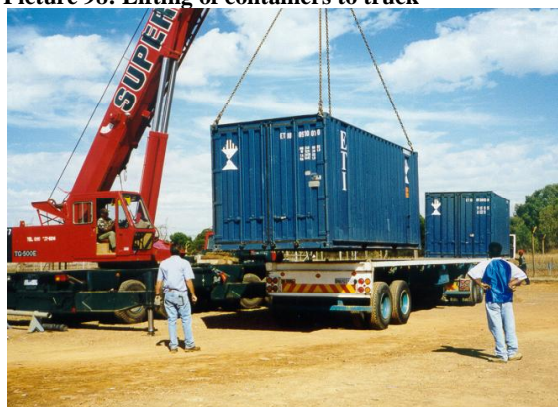

When transporting (drained) transformers, the devices must be tightened by using sufficiently strong belts fixed to the lifting eyes. The loading is easier if open top containers are used. However, such containers must be covered by a tarpaulin to protect against the rain.

Picture 99: Open top container

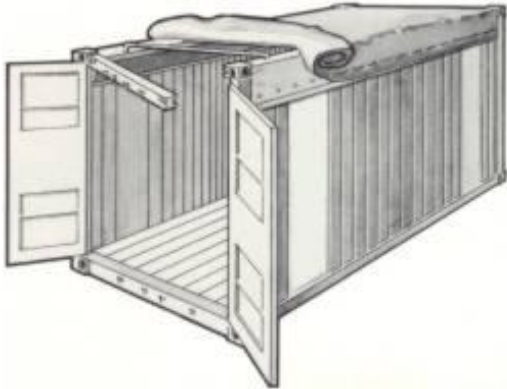

Picture 100: Loading of transformers



There are also special containers for the safe transport of PCB containing transformers that have not been drained (see picture above). Such units, however, are rather expensive.

10.6 Waste Transportation by Air

Air transports of UN no. 2315 and 3432 are basically possible. However, IATA regulations do generally refer to substances in their original, pure form only, and NOT to wastes.

It is therefore not appropriate and not recommended to transport Hazardous Waste wastes by air.

In the frame of a GEF financed disposal project in Eastern Europe, PCB wastes were however transported by airplane to their final destination in Western Europe. The usual proceeding according to the Basel Convention was undertaken.

Picture 101: PCB waste ready to be transported by air



If this option is seriously considered by a country, detailed investigation with all competent authorities incl. IATA, have to be made.

Furthermore, specific packing instructions have to be followed. The staff in charge of packing, loading and shipping must have attended a special training, and they must have official permission to perform this task (specific approval).

11. Pre-treatment, Treatment and Disposal

To select the most appropriate technology several rateable and non-rateable criteria have to be considered. Among “non-rateable”, or relative criteria, are included public acceptability, risk and environmental impacts, which depend on the specific geographic site location. The rateable criteria may include the applicability of the method (in accordance with its development status), BAT and BEP, already approved technologies, overall cost, resources, minimum achievable concentration, clean-up time required, reliability, maintenance, post treatment cost and ability to use soil after treatment. Furthermore, an Environmental Impact Assessment study shall be carried out to evaluate a technology.

An important requirement of a professional PCBs disposal technology is the destruction efficiency greater than 99.99%. Destruction efficiency (DE) is defined as the total mass of a chemical into a process, minus the mass of the chemical in all products, by-products and environmental releases, divided by the input mass (to give a percentage). This may differ significantly from the other common measure, destruction and removal efficiency (DRE) which only takes into account stack emissions; with no regard for other releases and residues. A process must be able to handle upsets, such as power supply failure, without danger to personnel or equipment. Handling and loading of POPs into the process must always be safe, straightforward and controlled. Equipment and controls must be simple and robust, and will preferably make use of local resources. The operating procedure must be extremely basic and virtually fail-safe. Loading and unloading, start up and shut down must all be straightforward.

The difference between technologies that only separate and/or concentrate a pollutant (e.g. solvent extractions, thermal desorption) and those which destroy the contaminant (e.g. incineration, dechlorination or biodegradation) must be considered. Those technologies that only immobilize contaminants (e.g. landfill systems, stabilization and vitrification) should also be clearly differentiated.

11.1 Technologies and Methods in General

The technologies listed below and presented more in detail in Annexes 12-3 and 12.6 cover a wide range of degree of treatment and recovery of transformer components, a factor which must be taken into account in comparing technologies. Decontamination is never completely applied to all components, and this means that a residue remains which must be incinerated. In the best case this will be just the porous parts (wood and paper) unless the solvent technique is applied for long process times, and a product finally obtained which may be sent for land filling if the residual PCB levels are legally acceptable. In other words, the total cost of treatment, including the cost of final disposal of residues, must be taken into consideration.

Table 36: Overview Pre-treatment and Non-Combustion Technologies

Autoclaving
Alkali metal reduction (e.g. dechlorination/dehalogenation processes)
Ball milling
Base catalysed decomposition
Catalytic hydrodechlorination
Gase-phase chemical reduction
Plasma Arc
Potassium tert-butoxide method
Pyrolysis / waste-to-gas conversion technology
Supercritical water oxidation
Vitrification
Bio-degradation

Table 37: Overview Combustion Technologies

High-temperature incineration
Co-incineration in cement kilns

„POPs Technology Specification and Data Sheets” providing detailed information on various decontamination/disposal methods are currently being prepared by the Basel Convention Secretariat.

Two sets of factsheets will describe technologies recommended for the destruction or irreversible transformation of waste consisting of, containing or contaminated with POPs. These factsheets will mainly focus on the following destruction technologies:

- Autoclaving
- Alkali metal reduction
- Base catalysed decomposition
- Co-incineration in cement kilns
- Supercritical Water Oxidation
- Thermal Desorption
- Waste-to gas conversion
- Hazardous waste incineration
- Plasma arc

The latest factsheets shall be published on the website of the BRS Secretariat before the COP 2015. At the moment the provisional data sheets can be downloaded at: <http://www.iropa.info/resources/library/>. For further details on the current status of the factsheets the BRS Secretariat in Geneva can be contacted: brs@brsmeas.org.

Incineration, is the most widely available and used technology for PCB destruction and remains a final solution. Because of the cost-factor of incineration and its non-availability in many countries, alternative technologies are widely used. Some of those technologies have the advantage not only of lower cost, but also of being able to treat economically much lower volumes of waste material.

Co-processing technologies, if not prohibited by national legislation, shall be implemented according to Basel Convention Technical Guidelines on the environmentally sound co-processing of hazardous wastes in cement kilns as well as the relevant national legislation and regulations

Although oil decontamination can be achieved with technologies allowing complete destruction of PCBs, the carcass of transformers and capacitors can present problems because of the presence of a small amount of porous, organic materials which are costly to treat to obtain complete decontamination.

The techniques and the procedures for the decontamination should be appropriately validated and documented, such that it is possible to predict the reduction, elimination and/or decomposition of specific undesired compounds and elements down to the concentration limit required, without potential hazards or unreasonable risk.

The decontamination activities should utilise Best Available Techniques (BAT) and Best Environmental Practices (BEP) to ensure that, throughout the residual life of equipment and insulating liquids, the quality of dielectric performances and the good functional state of the equipment is maintained. Such techniques should also ensure:

- The best operational conditions for decontamination to prevent direct and indirect damage. Prior to performing the operations, an appropriate safety plan should be prepared which evaluates risk and the appropriate corrective actions in the event of problems, failures, fires, uncontrolled spills or emissions into the environment;
- The dielectric quality and the physical and functional features of the insulating liquids in accordance with the relevant Standards and guides;
- The achievement of the objectives set by the decontamination operations, to be checked by measurement of the concentration of PCBs at the end of the decontamination and after a period of at least 3 months from the re-commissioning of the equipment, under service conditions. Transport of PCBs and equipment containing PCBs to companies performing decontamination in locations other than the site of installation of the equipment, should comply with all applicable transport and waste regulations, including the use of identification forms for waste and the waste input/output register. For trans-boundary movements, the Basel Convention applies.

Whatever technology is chosen, it has to be performed by a company which is approved for this task by the competent authorities, and the same if the PCB waste is exported, approved by the competent authority in the country concerned.

In December 2004, the United Nations Environment Programme published an updated version of the inventory of worldwide PCB Destruction Capacity. The UNEP also conducted a survey on currently available non-incineration PCB destruction technologies in 2000. Both documents can be downloaded:

http://www.chem.unep.ch/pops/pcb_activities/pcb_dest/PCB_Dest_Cap_SHORT.pdf;

<http://www.chem.unep.ch/Publications/pdf/SurvCurrAvNIncPCBDestrTech.pdf>

Picture 102: Worldwide PCB destruction capacity 2004

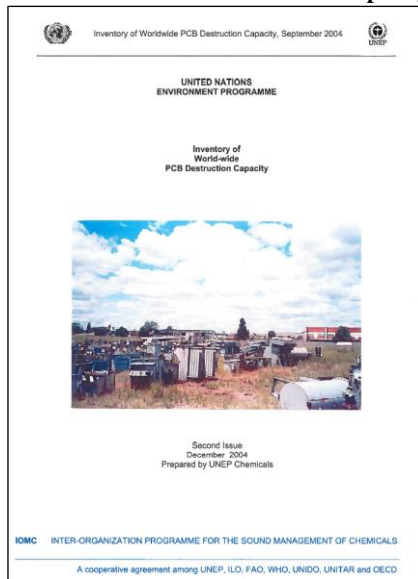

Picture 103: Non-incineration PCB technologies 2000

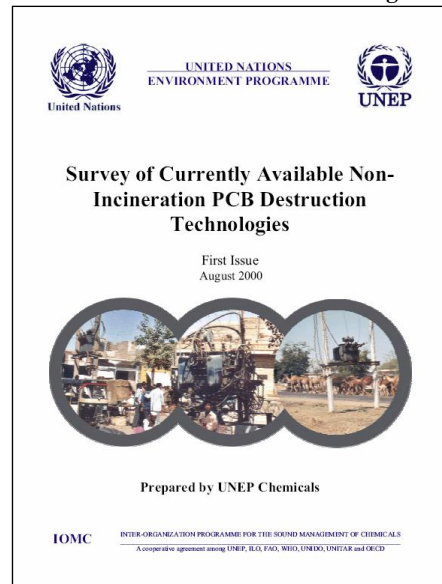

Further UNEP guidance documents as well as training manuals are available from:

http://www.chem.unep.ch/Pops/pcb_activities/default.htm;

<http://www.basel.int/meetings/sbc/workdoc/techdocs.html>

Picture 104: UNEP training manual for Hazardous Waste Project Managers from October 2002



12. Annexes

12.1 In-Depth Information on the Internet: Conventions and Guidance Documents

- Basel Convention
www.basel.int
- Stockholm Convention
www.pops.int
- PEN PCB Elimination Network
www.pops.int/pen/
- Guidance documents on PCBs
<http://chm.pops.int/Implementation/PCBs/DocumentsPublications/tabid/665/Default.aspx>
- Rotterdam Convention
www.pic.int
- UNEP Chemicals, many useful reports can be viewed and downloaded via this website
www.chem.unep.ch
- GPA Global Programme of Action for the Protection of the Marine Environment from Land-based Activities, a lot of useful information
www.gpa.unep.org
Identification of PCB containing capacitors, manual for electricians, very detailed list, Australia, 1997
<http://www.scew.gov.au/sites/www.scew.gov.au/files/resources/378b7018-8f2a-8174-3928-2056b44bf9b0/files/anzecc-gl-identification-pcb-containing-capacitors-information-booklet-electricians-and-electrical.pdf>
Guidelines for the Identification of PCBs and Materials Containing PCBs, UNEP 1999
<http://www.pops.int/documents/guidance/nipsfinal/pcb1d1.pdf>
- GEF - Global Environment Facility
www.gefweb.org
- UNITAR - United Nations Institute for Training & Research
www.unitar.org
- UNIDO – United Nations Industrial Development Organization
www.unido.org
- Recommendations on the Transport of Dangerous Goods – Model Regulations
http://www.unece.org/trans/danger/publi/unrec/rev16/16files_e.html
- International Chemical Safety Cards
<http://www.cdc.gov/niosh/ipcs/icstart.html#language>
- Minamata Convention
<http://www.mercuryconvention.org/>
- SAICM – Strategic Approach to International Chemicals Management
<http://www.saicm.org/>
- REACH – Registration, Evaluation, Authorisation and Restriction of Chemicals
http://ec.europa.eu/enterprise/sectors/chemicals/reach/index_en.htm

Please note that many documents and publications are under revision. Therefore please check the actualities in the World Wide Web periodically.

Guidance documents for identification, management and destruction of PCB

- Destruction and decontamination technologies for PCBs and other POPs wastes under the Basel Convention. A training manual for hazardous waste project managers Secretariat of the Basel Convention
<http://archive.basel.int/meetings/sbc/workdoc/TM-A.pdf>
<http://archive.basel.int/meetings/sbc/workdoc/TM-B.pdf>
- Guidelines for the identification of PCBs and materials containing PCBs
UNEP Chemicals
<http://www.chem.unep.ch/Publications/pdf/GuidIdPCB.pdf>
- Inventory of World-wide PCB Destruction Capacity
UNEP Chemicals
http://www.chem.unep.ch/pops/pcb_activities/pcb_dest/PCB_Dest_Cap_SHORT.pdf
- PCB Transformers and Capacitors - From Management to Reclassification and Disposal

UNEP Chemicals
<http://www.chem.unep.ch/Publications/pdf/PCBtranscap.pdf>
- Provisional POPs Technology Specification and Data Sheets
Secretariat of the Basel Convention
<http://www.ihpa.info/library/2009/08/02/pops-technology-specification-and-data-sheets/>
- Selection of Persistent Organic Pollutant Disposal Technology for the Global Environment Facility
A STAP advisory document
<http://www.thegef.org/gef/pubs/STAP/selection-persistent-organic-pollutant-disposal-technology-gef>
- Survey of Currently Available Non-Incineration PCB Destruction Technologies
UNEP Chemicals
<http://www.chem.unep.ch/Publications/pdf/SurvCurrAvNIncPCBDestrTech.pdf>
- Updated general technical guidelines for the environmentally sound management of wastes consisting of, containing or contaminated with persistent organic pollutants (POPs)
Basel Convention
http://chm.pops.int/Portals/0/flash/pops wastetrainingtool/eng/All_technical_guidelines_on_POPs_4.pdf
- Updated technical guidelines for the environmentally sound management of wastes consisting of, containing or contaminated with polychlorinated biphenyls (PCBs), polychlorinated terphenyls (PCTs) or polybrominated biphenyls (PBBs)
Basel Convention
<http://archive.basel.int/pub/techguid/tg-PCBs.pdf>
- Draft guidelines on best available techniques and provisional guidance on best environmental practices relevant to Article 5 and Annex C Stockholm Convention
http://www.pops.int/documents/guidance/batbep/batbepguide_en.pdf

12.2 Detection Kits and Other Instruments

Clor-N-Oil (oil samples) and Clor-N-Soil (soil samples)

This kit can test transformer oil for PCB presence. This test uses a colour charge to indicate the presence of chlorine and therefore the likely presence of PCBs. This detection kit can be obtained from the Dexsil Corporation. For more information the manufacturer may be reached at:

Dexsil Corporation	Phone: +1 203 288 3509
One Hamden Park Drive	Fax: +1 203 248 6523
Hamden, Connecticut 06517	E-mail: info@dexsil.com
USA	Internet: www.dexsil.com

L2000 PCB/Chloride Analyser (oil, soil, water and surface wipe samples)

This kit is designed to be used in the field to test for PCBs in soil, transformer oil, water, and on surfaces. The test first react the sample with a reagent that strips all chlorine from the organic molecule. Then a chloride specific electrode determines PCB concentration in the reacted sample. For more information the manufacturer may be reached at:

Dexsil Corporation	Phone: +1 203 288 3509
One Hamden Park Drive	Fax: +1 203 248 6523
Hamden, Connecticut 06517	E-mail: info@dexsil.com
USA	Internet: www.dexsil.com

DR/800 Series Colorimeters (water samples)

This is a small colorimeter that can check for PCBs (chloride) in water. It is designed for field use. For more information the manufacturer may be reached at:

Hach Company	Phone: +1 970 669 3050
P.O. Box 389	Fax: +1 970 669 2932
Loveland, Colorado 80539-0389	E-mail: csays@hach.com
USA	Internet: www.hach.com

DR/4000 UV-VIS Spectrophotometer (water samples)

This kit can perform water quality analysis. This spectrophotometer allows for both manual and sipper testing. It comes pre-programmed with 130 Hach methods of analysis but it can be programmed to perform other water quality analyses as well. For more information the manufacturer may be reached at:

Hach Company	Phone: +1 970 669 3050
P.O. Box 389	Fax: +1 970 669 2932
Loveland, Colorado 80539-0389	E-mail: csays@hach.com
USA	Internet: www.hach.com

12.3 PCB Pre-Treatment Technologies (*Extract only*)

Transformers are drained in a first step. The liquids will be disposed of separately. The “empty” transformer still contains approx. 3 to 10 % liquid. 10 % is related to Askarel because of the higher density. Additionally, the content of wood, paper etc. is responsible for the remaining liquid. Separate treatment is necessary for transformers. “Pure” PCB transformers cannot be cleaned economically for re-use. The same applies to all other devices that contain “pure” PCB.

Thus transformers need specific treatment. In case of Askarel transformers, solvent extraction is a possibility. Some companies put the core into an autoclave and extract PCB by solvent and vacuum. Empty carcasses are cleaned the same way. Alternatively, the transformer itself can be used as autoclave, and solvent is circulated through the empty transformer. In both cases the solvent is re-distilled, and the PCBs are exported to be incinerated. Various studies have shown that only solvent can remove Askarel from non-porous materials. The use of unchlorinated solvents would be more ecological, their low flashpoint, however, increases the inflammability risk. Therefore, chlorinated solvents like Perchloroethylene are used. Special attention must be paid to the potentially occurring emissions.

After these cleaning processes transformer coils are carefully disassembled. Porous parts still do contain PCB in the interior parts, and are packed into suitable packaging for final disposal at licensed facilities. Even after that pre-treatment by solvent, PCBs are still present the winding and between the core sheets. Therefore, core sheets and winding require additional cleaning processes in specific washing machineries using again solvent. After that procedure random samples must be taken in order to check the success of the process. If all metal parts are PCB-free they can be sold as secondary raw material.

12.4 PCB Non-Combustion Technologies

Dechlorination in general: Chemical dechlorination is based on reactions with either an organically bound alkali metal or an alkali metal oxide or hydroxide. Dechlorination processes are well developed for the treatment of liquid PCBs and PCB contaminated oil. The chlorine content is converted to inorganic salts which can be removed from the organic fraction by filtration. Reactions take place under inert atmosphere. Some companies provide mobile treatment plants, which can be used on an operating transformer in the field. There are several types of this technology available. Two suppliers of dechlorination technologies, and their processes are briefly described below:

Continuous Dehalogenation Process (CDP)

The CDP Process®, developed and patented by Sea Marconi, is a process capable of detoxifying and dehalogenating the PCBs present both in the oil and the inner parts of the transformer **on-site**, in continuous mode and closed circuit, with circulation of warm oil, with an efficiency of 99.9 %, in accordance with European Directive 59/96. The Decontamination Mobile Units (D5MU) used for the process designed and developed by Sea Marconi implement innovative technologies and unique environmental protection systems, to ensure safe working conditions. The D5MU are modular, thus they can operate in all logistic scenarios and thanks to specially developed ad-hoc protocols, they can also operate on energized and under load transformers.

SDMI Oil Dechlorination Process

The process developed by SD Myers (<http://sdmyers.com/pcb-dechlorination.html>) is very specific in the scheduled wastes it is able to treat, as it is designed to treat PCB contaminated transformer oils with concentrations below 10'000 mg/kg without the need to remove the transformer or take the transformer out of service. Concentrations below 2 ppm are achievable. It involves circulating the transformer fluid through a filtration system until the residual PCB concentrations are below those required. The continued circulation of the fluid through the transformer largely flushes the PCBs from the transformer windings and other internal components. The treated oil is then suitable for continued use. Leaching from the porous parts of the transformer such as wood and paper insulation can occur and the transformer may require another treatment after some time.

A general overview of non-combustion technologies is given in the next paragraphs:

Alkali metal reduction: Alkali metal reduction involves the treatment of wastes with dispersed alkali metal. Alkali metals react with chlorine in halogenated waste to produce salts and non-halogenated waste. Typically, the process operates at atmospheric pressure and temperatures between 60°C and 180°C. Treatment can take place either in situ (e.g. PCB-contaminated transformers) or ex situ in a reaction vessel.

There are several variations of this process. Although potassium and potassium-sodium alloy have been used, metallic sodium is the most commonly used reducing agent. *[Technical Guideline, Basel Convention]*. Sodium- and ammonium reduction technologies are capable for any kind of contamination of PCB, but not economical at higher level. The maximum economical level of PCB varies between 2'000 to 5'000 mg/kg PCB. The technologies have been widely used in Canada, USA and Europe for treatment of PCB-contaminated transformer oil. One of the advantages is that the oil after further treatment can be reused. There are several providers of the technology around the globe. The ammonium technology is comparable to sodium technology but rather seldom and not easy to handle.

Ball milling: This is an interesting new technology where a ball mill is used with excess CaO resulting in decomposition of chlorinated compounds. Reports show high destruction efficiencies for individual chemicals. However, the method is still in development stage and there is a lack of independent emission statistics. The operating costs may be high due to the amount of CaO and electricity needed in the process.

Base catalysed decomposition (BCD): The BCD process involves treatment of wastes in the presence of a reagent mixture consisting of hydrogen-donor oil, alkali metal hydroxide and a proprietary catalyst. When the mixture is heated to above 300°C, the reagent produces highly reactive atomic hydrogen. The atomic hydrogen reacts with the waste to remove constituents that confer the toxicity to compounds. *[Technical Guideline, Basel Convention]*.

The BCD process is limited to a certain PCB content, which however is above 10'000 ppm. BCD has been used at two commercial operations within Australia, with one still operating. Most recent experiences have been gained at one of the largest Dioxin sites in the world, the Spolana Site in Czech Republic, where tens of thousands of tons of contaminated soils and several thousands of tons of 50 % chlorine pesticides, etc. have been treated. Thanks to these experiences in Spolana, BCD units have been improved in such a way that up to 1000 t/y of high chlorine content PCBs or pesticides (50%) can now be treated in a single line.

Catalytic hydrodechlorination (CHD): CHD involves the treatment of wastes with hydrogen gas and palladium on carbon (Pd/C) catalyst dispersed in paraffin oil. Hydrogen reacts with chlorine in halogenated waste to produce hydrogen chloride (HCl) and non-halogenated waste. In the case of PCBs, biphenyl is the main product. The process operates at atmospheric pressure and temperatures between 180°C and 260°C. *[Technical Guideline, Basel Convention]*

In Japan the CHD technology is implemented by JESCO (Japan Environmental Safety Corporation) which is a special company wholly owned by the government, established in 2004. JESCO's mission is to construct and operate five regional facilities to treat PCBs wastes in Japan, and one of them is the CHD Osaka PCB Waste Treatment Facility. The Japanese plant can treat up to 100% PCBs and is also combined with units to clean PCB transformers: Solvent Cleansing Method and the Vacuum Heating Separation Method. An interesting option is the CHD technology implemented by Hydrodec, which has treatment facilities in Young, NSW, Australia, and Canton, Ohio, USA. They transform used oil into a high quality naphthenic based transformer oil or base oil called SUPERFINE™. The plant in Ohio, can treat low level PCB-contaminated transformer oil up to 49 ppm, (EPA permit for up to 2,000 ppm pending approval) (<http://www.hydrodec.com/product-and-services/north-america/used-oil-collection-and-treatment>).

In 2011, the company started a joint-venture with Kobelco Eco-Solutions. It is planned to set up the first plant in Japan during the second half of 2012.

Gas-phase chemical reduction (GPCR): The GPCR process involves the thermochemical reduction of organic compounds. At temperatures greater than 850°C and at low pressures, hydrogen reacts with

chlorinated organic compounds to yield primarily methane and hydrogen chloride. [Technical Guideline, Basel Convention]. All PCBs from Western Australia were treated by GPCR in the 2000s. No commercial facility is in operation today, the methodology is rather expensive.

Plasma Arc: The Plascon™ process uses a plasma arc with temperatures in excess of 3,000° C to pyrolyse wastes. Together with argon, wastes are injected directly into the plasma arc. The high temperature causes compounds to dissociate into their elemental ions and atoms. Recombination occurs in a cooler area of the reaction chamber, followed by a quench, resulting in the formation of simple molecules. [Technical Guideline, Basel Convention]. This technology can destroy up to the highest level of PCB with an efficiency of 99.99999 %. The plasma arc technology is used regionally on a commercial basis but is rather low in capacity. Due to the extreme high temperature the disposal costs are very high. Installations are small with standard units (each unit 150kW) and can be used as mobile or as fixed plants. A PLASCON® plant can destroy pure PCBs at a rate of 35 to 40 kg/h (<http://www.plascon.com.au/destruction-of-pcbs.html>). In January 2011 there were 10 commercial plants operating with licenses from the Victorian and Queensland EPAs in Australia, the UK EPA, the US EPA, the Mexican EPA, and the Japanese Ministry of the Environment. 4 commercial 150 kW “in-flight” plasma arc units are operating in Australia. 2 units were installed at Nufarm Ltd (Pesticides producer).

Potassium tert-butoxide method: PCBs in insulating oils are dechlorinated by reaction with potassium tert-butoxide (t-BuOK). It reacts with chlorine in PCBs to produce salt and non-chlorinated waste. Typically, the process operates at atmospheric pressure and temperatures between 200°- 240°C. [Technical Guideline, Basel Convention]. (up to now only implemented in Japan).

Pyrolysis / waste-to-gas conversion technology: The process is a gasification pre-treatment and treatment technology for the recovery of hydrocarbon-containing waste operating at high temperatures (1300°C–2000°C) and high pressure (about 25 bar) using steam and pure oxygen in a reducing atmosphere. All hydrocarbon molecules in the waste are irreversibly cleft into small gaseous molecules such as hydrogen (H₂) and carbon monoxide (CO), methane (CH₄) and carbon dioxide (CO₂). Short-chain hydrocarbons such as ethane (C₂H₆), propane (C₃H₈) and butane (C₄H₁₀) and other compounds are produced in small amounts (< 1 vol. %). PCBs contained in the waste are effectively destroyed. The resulting raw gas is subsequently converted in a multistage process to pure synthesis gas for the production of highest-grade methanol. [Technical Guideline, Basel Convention] There was only one plant in the world using this technology, Schwarze Pumpe, Germany, which, however, was already closed some years ago.

Supercritical water oxidation: SCWO and subcritical water oxidation treat wastes in an enclosed system using an oxidant (such as oxygen, hydrogen peroxide, nitrite, nitrate, etc.) in water at temperatures and pressures above the critical point of water (374°C and 218 atmospheres) and below subcritical conditions (370°C and 262 atmospheres). Under these conditions, organic materials become highly soluble in water and are oxidized to produce carbon dioxide, water and inorganic acids or salts. [Technical Guideline, Basel Convention]. At present the largest SCWO plant (10 000 t/y) in the world is under construction in the US for the destruction of Chemical Warfare agents (ACWA programme).

Vitrification (Geomelt): This technology has been widely applied for remediation of PCBs in soil. The process works by establishing a melt between pairs of electrodes inserted into the soil-bound waste materials. This treatment of PCB containing equipment and oil can only be recommended under certain specific conditions.

Bio-degradation: The bio-degradation is very limited in the contamination level and can be excluded for treatment of PCB-containing equipment and oil. From experience we know, however, that Bio-degradation can be considered for treatment of low-contaminated soils.

12.5 PCB Combustion Technologies

High-temperature incineration is the most common technology for destruction of waste with high PCB content in Europe and North America. Modern incinerators have an efficiency of at least 99.99999 % for highest levels of PCB. In order to reach this destruction efficiency the incinerators operates at temperatures higher than 1,100 °C, with a residence time greater than 2 seconds, under conditions that assure appropriate mixing. The disposal costs are in general lower for waste with high content PCB than for the other disposal methods. In some countries public resistance against hazardous waste incineration has led to the development of different non-incineration technologies although the disposal costs may be higher for these technologies. The formation of dioxins and furans by the incineration has been one of the main concerns. If high temperature incineration is used the incinerator should meet a limit value for emission of dioxins and furans of <0.1 ng I-TEQ/Nm³ at 11% O₂. Most incinerators are large stationary facilities but in some countries e.g. Canada also small mobile incinerators are operating on a commercial basis. Their capacities are low compared to the stationary ones.

High temperature incineration is the main solution in Europe for “pure” PCB. Various incinerators guarantee extreme low emissions. The incinerators can accept all types of PCB waste that can either be pumped (liquids) or packed into drums. PCBs in drums are fed into the incinerator kiln by elevator. Liquids are usually pumped from storage tank through injectors into the kiln. Transformers have to be dismantled prior to disposal, due to their size.

Co-incineration in cement kilns: The co-incineration of PCB containing liquids is usually limited to the range of 50 to 1,000 ppm PCB in the oil. Higher levels of chlorine would have negative impact to the quality of cement. As rule of thumb, chlorine should usually be limited to 300 to 500 g/t cement clinker for a kiln without by-pass and 400 to 750 g/t for a kiln with by-pass, but the chlorine tolerance must be known in each instance. It is important that the process owner knows the chlorine tolerance of the process in question. Additionally, the co-incineration requires proper flue gas cleaning systems.

A number of tests of PCB destruction have demonstrated that the PCB can be satisfactory destructed in the kilns, but large scale use of cement kilns for destruction of PCBs has not been reported from developing countries. If cement kilns are used to incinerate wastes, the standards of the applicable regulations have to be met. One can refer to the regulation 94/67/EG of the European Council on the incineration of toxic wastes.

12.6 PCB Emerging Technologies

There are a number of emerging technologies, which are not presented in the frame of this handbook. There is a GEF supported “review of emerging, innovative technologies for the destruction and decontamination of POPs and the identification of promising technologies for the use in developing countries” available in the internet:

http://www.chem.unep.ch/pops/pcb_activities/PCB_proceeding/Presentations/PCB%20Global%20McDowall.pdf
and

http://www.chem.unep.ch/Pops/pcb_activities/default.htm#Guidance

12.7 PCB Treatment and PCB Disposal Companies

Enterprises from all around the world are listed under the following link:

http://www.chem.unep.ch/pops/pcb_activities/questionnaire/default.htm

Please note that some websites might be archived in March 2015. Please check periodically the WWW about new publications and downloads.

12.8 Emergency Response Plan for Cold Incidents

The following table shows the measures to be taken in case of PCB incidents. For each nature of spill the order of the actions to be taken is indicated by the numbers.







Emergency Response for Cold PCB Incidents				
	Nature of spill			
	Leakage into containment system	Spill on concrete and asphalt	Spill on soil	Spill into water
Notify plant personnel, chemical response and competent authorities	1	1	1	1
Inform responsible doctor and put on adequate Personal Protective Equipment (avoid personal contamination!)	2	2	2	2
Prevent people and/or vehicles from entering the contaminated areas	3	3	3	3
If applicable: Disconnect the concerned equipment from power Check earthing	4	4		
Plug or dike all drains to sewers and ditches, use absorbents (sand, cement)		5	4	
Stop source: Seal leak by using appropriate materials, place drip-tray under leak	5	6	5	4
Spill confinement: Build dikes to contain PCB in small area		7	6	
Cover with plastic to minimize runoff from rain		8	7	
Dam area if possible, and close off to vessels in navigable water				5
Confine contaminated area, Erect tent with compartments	6	9	8	
Use pump to transfer PCBs into drums, Soak up PCB with absorbents	7	10	9	6
Use dredges to collect the contaminated soil / sediment			10	7
Repeated solvent scrub process followed by a sorbent clean-up	8	11		
Take core sample to determine remaining contamination		12 (2,5 cm depth)	11 (60 cm depth)	
Break off contaminated concrete		13		
Pack wastes according to ADR and dispose as hazardous waste	9	14	12	8
Monitor wells and other bodies of water in the vicinity for PCB contamination			13	

12.9 Emergency Response Plan for Hot Incidents

The following table shows the measures to be taken in case of PCB incidents. For each nature of spill the order of the actions to be taken is indicated by the numbers.

Emergency Response for Hot PCB Incidents			
	Nature of Incident		
	Internal failure No bursting of equipment	Internal failure of capacitor Bursting of equipment with spill	Fire in vicinity of equipment
		Beware of highly toxic furans!	Beware of highly toxic furans and dioxins!
Notify fire brigades			1
Notify plant personnel, chemical response and competent authorities		1	2
Inform responsible doctor and put on adequate Personal Protective Equipment (respiration mask!)		2	3
Prevent people from entering the contaminated areas		3	4
Disconnect the concerned equipment from power	1	4	5
Phase out equipment	2		
Evacuate and close the building, cut out air circulation by plugging vents		5	6
Stop source: Seal leak with appropriate materials, place drip-tray under leak		6	
Confine contaminated area		7	7
If not protected by a heavy protective overall keep clear from danger zone, Let the specialists extinguish the fire			8
Erect tent with compartments		8	9
Repeated solvent scrub process followed by a sorbent clean-up		9	10
Take core sample to determine penetration		10 (2,5 cm deep)	11 (60 cm deep)
Take wipe samples for dioxin			12
Break off contaminated concrete		11	13
Use dredges to collect the contaminated soil / sediment		12	14
Pack wastes according to ADR and dispose as hazardous waste	3	13	15

12.10 Best Working Practices

Best Working Practices	
When performing light repair or maintenance work with PCB-containing equipment, the following safety precautions for the protection of the employees and the environment have to be followed:	
	Direct contact of PCB-contaminated materials with the skin and eyes has to be absolutely avoided by wearing gloves and safety goggles. According to the type of the work performed, protection clothing and a respiratory mask has also to be put to the workers disposal.
	
	The working area has to be adequately ventilated.
	Spills have to be prevented in every case by use of drip trays or adequate plastic tarps.
	Every contact of PCBs with a flame or any other heat source over 300°C has to be absolutely avoided (risk of highly toxic dioxines and furanes).
	All used tools and other working materials, which got in contact with PCBs, have to be disposed of as PCB-containing waste in a environmentally sound manner or otherwise have to be decontaminated. The only suitable materials to be decontaminated with an appropriate solvent (technical acetone) are steel, glass and ceramics.
	Operations which involve decanting, rewinding of coil, etc. must only be performed by companies approved for this task by the competent authorities.

12.11 PCB Instructions for Workers

The below instruction card shall be regarded as an adequate example of PCB instructions for workers and emergency cases. However, the information and pictograms may change.

Instruction No. 03/2010 | Company:

Acc. §14 Ordinance on Hazardous Substances

Building site/Work:

Printdate:



Polychlorierte Biphenyle
PCB are suspected of causing cancer!



Hazards for human health and the environment

Breathing in, swallowing or absorption through the skin may result in health damage. May cause irritation (respiratory tract, eyes, skin, organs of digestion). Temporary complaints (dizziness, fatigue, nausea, loss of appetite) are possible. Can cause acne, digestive disorders, liver damage, blood picture changes, mood disorders. Carcinogenic effect is suspected. PCB can affect reproductive fertility. PCB can be injurious to the unborn child. Reichert sich im Körper an! Beim Erhitzen oder Verbrennen können sehr giftige Dioxine und Furane entstehen.

Hazardous to water - avoid ingress into the ground, water and sewage!

Protective measures and behaviour rules

Ensure a fresh air supply when working! In the event of vapours, work only with exhaust ventilation! Nicht mit Feuer, offenen Flammen oder heißen Metallteilen in Berührung bringen! Do not leave vessels open! Avoid splashes! Do not mix with other products or chemicals! Avoid contact with eyes, skin and clothing! Preventive skin protection necessary. Thoroughly clean hands and face after completing work and before every work break! Use skin care agent! Store street clothing separately from work clothing! Change clothing after completing work! Change soiled clothing!

Observe restrictions on activity!

Eye protection: Full protection goggles!

Hand protection: Gloves made of: fluororubber.

It is advisable to wear cotton gloves underneath protective gloves.

Breathing protection: The use of A2-P3 (braun-weiß) is recommended.

In pits, shafts and silos, only use ambient air-independent breathing apparatus!

Skin protection: Use grease-free skin protection ointment for all uncovered parts of the body:

Body protection: (Disposable) chemical protective suit and plastic boots. Bei Bedarf partikeldichte Schutzkleidung!



Behaviour in danger situations

Collect and dispose of with absorbent non-combustible material (e.g. kieselguhr, sand)! Evacuate the workplace if large quantities should leak! Remove only after applying persönlicher Schutzausrüstung! Product is not combustible. In the event of a fire in the environment, cool the receptacle with sprayed water! Hazardous vapours are produced in the event of fire! Only fight larger fires using self-contained breathing equipment and suitable protective equipment!

Responsible physician or clinic:

Accident phone:

First Aid

During all First Aid assistance: protect yourself and immediately inform a doctor.

After eye contact: Rinse for 10 minutes with water or with eye-wash solution.

After skin contact: Take off soiled clothing immediately. Clean with abundant amounts of water and soap. No thinners!

After breathing in: Fresh air. Keep airways clear: remove false teeth, vomit etc.. If breathing or heartbeat stops: immediately apply artificial respiration and heart massage.

After swallowing: Do not cause vomiting. If conscious, see that plenty of water is drunk a little at a time. No domestic agents.

First Aid specialist:



Proper disposal

Do not pour into the sewage or a refuse bin!

Product residues:

For disposal, collect in:

12.12 First Aid in Case of Contact with PCBs

Table 38: First Aid Measures

Kind of Exposure	Measure
➤ Liquid PCB on the skin	➤ Use water and soap to wash thoroughly
➤ Liquid PCB in the eyes	➤ Rinse eyes with lukewarm jets of water for 15 minutes, always keeping eyes wide open
➤ Liquid PCB in the mouth and in the stomach	➤ Rinse mouth with water, do not drink anything else, see doctor immediately
➤ Highly concentrated vapors of PCB	➤ Take affected people outside in the open air

12.13 Guidelines for the Inspection of Sites and the Sampling of Transformers and Capacitors (two persons)

The Field Teams for the identification of PCB equipment comprise of three members. The inspector as official authority will monitor the process of sampling and ensure the quality of the inventory process.

Field Team Member 1		Field Team Member 2
Unlock the door/gate to the room with capacitors	1	
Locate capacitors, read the producer's plate	2	Fill in the inventory form for the capacitor and in the upper right space copy the number from the label
Read each line of the producer's plate	3	Fill in the necessary data from the producer's plate, line by line
Measure the capacitors' dimensions	4	Write down the dimensions of the capacitors
Prepare the label for capacitors and affix it on a clean and accessible place on the capacitor (example: 10404)	5	
Take picture of the capacitor	7	
Check if there is any leakage or damage on the capacitor	8	Note down in the inventory form where the leakage or damage has been detected on the capacitor
Lock the room with capacitors	9	
Unlock the door/gate to the room with transformers	10	
Locate transformers, read the producer's plate	11	Fill in the inventory form for the transformer and in the upper right space copy the number from the label
Read each line of the producer's plate	12	Fill in the necessary data from the producer's plate, line by line
Take sample of transformer oil	13	
Affix sampling label on transformer, sampling vial, and write it on the inventory form	14	Check if there is any leakage or damage on the transformer
	15	Take picture of the transformer (if there are any leakages, damages, corrosion)
Dispose the sampling materials (pipettes, adsorbent pads, gloves) in plastic bags that will later be stored in barrels and containers for that purpose.	16	Note down in the inventory form where the leakage or damage has been detected on the transformer
Lock the room with transformers	17	

12.14 Draft Inventory Questionnaires

There are a number of inventory questionnaire proposals, amongst them also the initial UNEP proposal from 2002, see e.g. on this site:

<http://www.google.ch/url?sa=t&rct=j&q=&esrc=s&source=web&cd=1&ved=0CB4QFjAA&url=http%3A%2F%2Fwww.pops.int%2Fdocuments%2Fguidance%2FPCBinvtm.doc&ei=bnb1VMaJFYvnUr6xgtAK&usg=AFQjCNE8mfNujwIGZxuyEuZbNIe2lg99g&sig2=yuimZwcO4WVxE39Y7ZLejQ>

It is recommended that countries design their own country-tailored questionnaires, based on the UNEP recommendation respectively the BRSMEAS Guidelines and respective experiences.

Below and until page 99, there are some draft forms based on the initial UNEP Questionnaire which have been used in many countries as a basis for the PCB Assessment.

Often these forms have been used at the same time as sampling reports.

Form A:

Information about the company, site and equipment which contains / is contaminated with PCB

No	Information about the company, site and equipment which contains / is contaminated with PCB	
1	Name:	
2	Address:	
3	Address of site:	
4	Phone :	
	Fax:	
	E-mail:	
5	Name/Position of contact person:	
6	Type of company / industry type/ production at specific site:	
7	Public or private company?	
8	Location:	Industrial zone
		Urban area
		Rural area
9	Number of personnel:	>50
		10-50
		<10
10	Total number of pieces of equipment at site:	Transformers
		Capacitors
		Others

Form B:

Information related to the potentially PCB containing equipment

Oil-filled Equipment Inventory Form
(to be filled for each piece of equipment)

Oil-filled Equipment Inventory Form			
1	Name of the equipment		
2	Individual Identification Number (IIN) of the equipment		
3	Type and trademark of the equipment		
4	Serial number		
5	Manufacturer and country of origin		
6	Location of equipment		
7	Maximum permissible power capacity		
8	Year of production		
9	Physical parameters:	Total weight (kg)	
		Volume/weight of oil (liters or kg)	
		Equipment (dry weight, kg)	
		Dimensions of equipment (length, width, height, m)	
10	Oil trademark		
11	Does the oil contain PCB?		
12	How did you identify the oil as PCB-containing or PCB-free?		
13	Operational status	In service	
		Stand-by	
		Decommissioned	
14	Condition of the equipment	Any leakages detected?	
		Is the floor under equipment (concrete, soil) contaminated?	
		Any external evidence of the equipment damage (corrosion, cracks etc.)?	
		Storage situation (e.g. open air, in a workshop etc.).	

15	Service, maintenance and care; current repair of the equipment.	What company provides equipment maintenance services?	
		Type of oil used for retrofilling?	
		Fluid replaced? If yes, when was the last replacement done?	
		What company replaced the fluid?	
		What was the trademark of replacement insulation fluid or oil? (Name in original language)	
Name, position of person in charge and executor, signature, date			
16	Person in charge:	_____	_____
		Signature	Date
17	Executor:	_____	_____
		Signature	Date

Form C:**Information on wastes liable to contain PCB**

C Information on wastes liable to contain PCB			
1	Nature of the wastes (e.g., transformer oil in drums or reservoirs)		
2	Estimated quantity		
3	Are containers leak-proof?		
4	Is the place of storage clearly marked to show the presence of PCB?		
5	Have soil or buildings been contaminated by leaking PCB? (indicate magnitude of problem if possible, e.g. tonnes or cubic metres of contaminated soil)		
6	Brief history of any previous remediation efforts, e.g., removal of PCB-containing equipment and waste PCB for disposal (when, by whom, where to, etc.)		
7	Other relevant information (e.g., results of any sampling and analysis already undertaken)		
8	Fill in:	Name and surname	Signature
		_____	_____
		Signature	Date

12.14.1 Preliminary Inventory Form used in the Regional Pilot Project

Preliminary Inventory form of PCBs

General Data			
1	Inventory record No.		
2	Date		
3	Inspector name		
4	Name of establishment		
5	Address, phone, mail, fax		
6	Name of managing head		
7	Position GPS		
8	Land use classification	<ul style="list-style-type: none"> • Urban • Industrial • Rural 	
9	Industry Classification		
	Code		
	Description	<ul style="list-style-type: none"> • Manufacturing • Service • Transport • Commercial • Utilities • Other(<i>please specify</i>) 	
10	Potential Receptors	<ul style="list-style-type: none"> • School • Hospital • Commercial Buildings • Storage of Flammable Material • Other (<i>please specify</i>) 	km
	<i>Indicate distance (in kilometers) for each applicable receptor.</i>		km
			km
			km
			km
Analysis			
11	Sampling No.		
12	Date of sampling		
13	Density test*	Positive Negative No test	
14	Chlorine test	< 50 ppm > 50 ppm No test	
15	Chlorine concentration ppm		
16	PCB concentration ppm		
17	Name of laboratory		
18	Laboratory recognition/ accreditation number		

*only in case of emergency

**.: if applicable

Preliminary Identification of PCBs

Technical Data			
19	Serial number		
20	Type of equipment/ appliance/ packing	• Transformer	
		• Capacitor	
		• Circuit breaker	
		• Drum containing liquid	
		• Drum containing solid	
		• Contaminated soil associated to the equipment	
21	Operational Status of equipment	• Others, please specify	
		• In use	
		• Out of use	
		• Stand by	
		• In storage area	
		• Ready for decommissioning	
22	Manufacturer name list no**		
23	Dielectric name list no**		
24	Power [KVA] (KVAR) **		
25	Year of manufacture **		
26	Year of installation on site **		
27	Total weight **		
28	Weight of dielectric oil **		
29	Filling level **	• Full	
		• Half	
		• Empty	
		• No leaking	
30	Leaking of appliance	• Top	
		• Middle	
		• Bottom	
		• No corrosion	
31	Corrosion on the appliance	• Top	
		• Middle	
		• Bottom	
		• No corrosion	
32	Retrofilling**	Yes, indicate when	
		No	
33	Any nearby flammable material?	If Yes give the chemical or technical name	Estimate distance from PCB appliance
		No	km
			km

Please stick here the label of the sample.

*only in case of emergency

** : if applicable

12.15. Example of a Possible Register

Ord. No	Type of equipment	Trade-mark	IIN	Manufacturer	Year of production	PCB tested	Total Weight kg	Oil Weight kg	Location	Operation status	Condition	Maintenance and servicing data	Maintenance organization (contact info)
1	Transformer	TM	TC-301	Kentau Transformer Plant	1995	PCB-Free (L2000 Screening)	2500	800	Workshop No 1	In service	Satisfactory	Regular topping up	Iskra Ltd., Kokshetau, Abay str. 2
2	Transformer	TH	TH - 121	Chirchick Transformer plant	1967	PCB-contaminated 486 mg/kg by L2000 & GC Verification	4530	1800	Transformer substation ТПС-010	Phased out	There are oil leaks	Maintenance by Iskra Ltd/	Iskra Ltd., Kokshetau, Abay str. 2
3	Transformer	TON 394/22	ТНП - 222	Poland	1976	PCB-containing pure PCB (nametag)	2800	1200	Transformer substation	In service	Satisfactory	Regular topping up and gasket replacement in 2004 .	Iskra Ltd., Kokshetau, Abay str. 2
4	Capacitor	KCK2-1,05-125-2V	KC - 089	Ust-Kamenogorsk capacitor plant	1985	no testing yet	58	15	Capacitor substation	In backup	Burnt	No maintenance	Iskra Ltd., Kokshetau, Abay str. 2

12.16 PCB Equipment Monthly Maintenance Plan

Place: _____

Date: _____

No.	Item for inspection	Compliant		Observation	Corrective action
		Yes	No		
PCB Transformers					
1.	Inventory number				
2.	Condition of gauges				
3.	Reading of gauges				
4.	Corrosion on tanks and radiator fins				
5.	Paint finish of tank and radiator fins				
6.	PCB leakage from: <ul style="list-style-type: none"> • tank • radiator fins • top cover • manhole cover • top or bottom drain spout • high and low voltage bushings 				
7.	Pressure relief valve				
8.	Drain valve				
9.	High and low voltage bushings				
10.	Color of PCB oil				
11.	Electrical and chemical tests to indicate the physical and electrical properties (dielectric test, power factor test, acidity test, interfacial test) (to be tested yearly)				
12.	Driers (silica gel) state				
13.	Abnormal vibration and noise				
PCB Capacitors					
14.	Inventory number				
15.	Corrosion on casing				
16.	Physical damage				
17.	Leakage of PCB oil				
18.	Melted fuses				
19.	Temperature of capacitor casing				
20.	Bulging				
21.	Bursting				
22.	Repairing and servicing operations, if any				
23.	Was PCB equipment repaired on or off-site (if off-site, state the servicing and transport company)				

Completed By: _____

Contact Phone: _____

12.17 PCB Interim Storage Facility Monthly Inspection Report

Overview: The competent authority is required to inspect the institutions' PCB storage site on a monthly basis. This inspection is completed by a qualified individual, recorded below, and forwarded to the environmental authorities.

Place: _____ **Date:** _____

No.	Question	Yes	No
1	Signage is posted on the exterior of the PCB storage areas and storage areas are secure and only accessible to authorized personnel.		
2	PCB equipment and drums of PCB material are stored in a manner that makes them accessible for inspection and that protects them from catching fire or being released.		
3	PCB storage site is in good condition, including:		
	• Floors		
	• Curbing		
	• Sides		
	• Drains (if present)		
	• Weatherproof roofs		
4	Indoor PCB storage sites are equipped with, where practical, an appropriate fire suppression system and alarm system to adequately address the quantities of PCBs stored on site.		
5	Has the fire extinguisher been inspected within the last month? Is it in working condition?		
6	Where PCB equipment that is not in a container (other than drained PCB equipment) and contains PCB liquids, is stored on a floor of steel, concrete or any other similar durable material that is capable of absorbing any PCB liquid. The concrete floor and sides are sealed with an impervious, durable, PCB-resistant coating.		
7	PCB equipment not stored in containers and contains PCB liquids is stored on a floor of steel, concrete or any other similar durable material, is dyked to contain:		
	a) for one piece of equipment or container, 125% of the volume of the PCB liquid present; or b) for more than one piece of equipment or container, the greater of twice the volume of the PCB liquid in the largest piece or 25 per cent of the volume of all the PCB liquid stored.		
8	PCB storage site floor drains, sumps or other openings in the floor are:		
	a) closed and sealed to prevent the release of liquids, or		
	b) connected to a closed drainage system suitable for PCB collection that terminates at a location where any spilled liquids are contained and recovered and where the spilled liquids, and c) will not create a fire hazard or a risk to public health or safety.		
9	Stacked containers of PCB material, other than drums, are used only if the containers are designed for stacking, and are stacked not more than two containers high.		
10	Where drums containing PCB material are stacked, separate the drums from each other by pallets and, in the case of drums of PCB liquid, stack the drums not more than two drums high.		

Completed By: _____ **Contact Phone:** _____

Please retain a copy for your records and forward the original to:

12.18 Transboundary Movement and Notification Documents for Hazardous Waste

For the transboundary movement of Hazardous Waste the Proceedings according to the Basel Convention have to be followed and the appropriate forms prepared (see also chapter 1.2).

The Conference of the Parties to the Basel Convention at its eighth meeting (December 2006) adopted revised versions of the forms for the notification and movement documents, including the instructions for completing these forms. These forms can be accessed from the links below:

<http://www.basel.int/Portals/4/Basel%20Convention/docs/techmatters/forms-notif-mov/vCOP8.pdf>

There are other forms available such as e.g.

<http://www.pccdaman.info/pdf/Hw%20Forms/HW%20Form%20-%208.pdf>

Many forms are under revision at the time and will be published soon on the appropriate websites. Please check the actualities in the WWW periodically.

12.19 Dangerous Good Declaration and Container Packing Certificate

DANGEROUS GOODS DECLARATION AND CONTAINER PACKING CERTIFICATE

This form meets the requirements of SOLAS 74, Chapter VII, Regulation 4; Marpol 73/78 Annex III, Regulation 4 and Chapter 5.4 (Documentation), Vol. 1 of IMDG Code.

1 Shipper (Name and Address)		2 Page 1 of ___ pages									
		3 B/L Number:									
4 Consignee (Name and Address)		5 Shipper's Reference Number:									
		6 Carrier:									
SHIPPER'S DECLARATION: I hereby declare that the contents of this consignment are fully and accurately described below by the proper shipping name, and are classified, packaged, marked and labelled/placarded and are in all respects in proper condition for transport according to the applicable international and national government regulations.											
7 Port of Loading	8 Vessel/Voyage	9 1 st Relay Port	10 1 st Relay Vessel/Voyage								
11 2 nd Relay Port	13 2 nd Relay Vessel/Voyage	14 Port of Discharge	15 Port of Destination								
16 Dangerous Goods Details											
Proper Shipping Name	IMO Class	Sub Risk	UN No.	PG	FP	MP Y/N	Gross Wt. (kg)	Net Wt. (kg)	Cube (m ³)	Package No. & Type	
										Inner	Outer
17 Container No.		18 Container Size & Type			19 Seal No.						
20 Container Tare Wt. (kg)		21 Total Wt. (kg) (Including Container Wt.)				22 24 hrs Emergency Contact Tel No.					
23 Additional Handling Information						CONTAINER PACKING CERTIFICATE: I hereby declare that the goods described above have been packed/loaded into the container identified above in accordance with provision 5.4.2.1 of IMDG Code.					
						24 Name of Company					
<p>* DANGEROUS GOODS: You must specify: proper shipping name, hazard class, UN Number, Packaging Group, Marine Pollutant (where assigned) and observe the mandatory requirements under applicable national and international governmental regulations. For the purposes of the IMDG Code see Provision 5.4.1.4 and DOT-E - CFR 172.203(a)</p>						25 Name/State of Declarant					
						26 Place and Date					
						27 Signature of Declarant					

12.20. Application Form for Membership in the PEN

**APPLICATION FORM FOR MEMBERSHIP TO THE
PCB ELIMINATION NETWORK (PEN)**

1. Personal information

 I wish to register as an: Institution Individual person

Institution			
First name		Title (<i>Mr., Ms., Mrs., Dr.</i>)	
Family name			
Job title			
Mailing address		Postal code	
City		Country	
Telephone	<i>(please include international code)</i>	Mobile	<i>(please include international code)</i>
Fax		E-mail	

2. Additional information

Please specify to which category of stakeholders you belong (please choose only one category):

- Government (ministries, agencies, environmental inspectorates, etc.)
 PCB disposal service industry (entities offering maintenance, treatment or destruction of PCB)
 PCB owner or holder (private or state enterprises holding contaminated equipment or oils)
 Regional centre for the Stockholm or Basel Convention for capacity building and the transfer of technology
 Inter-governmental organization
 Non-governmental organization
 Research institution or academia
 Other: _____

In the field below, please briefly describe your involvement with PCB.

I am interested in the following topics of the thematic group (multiple checks possible):

- Inventory of PCB
 Maintenance, Handling, and Interim Storage of Equipment Containing PCB
 Disposal of PCB and Remediation of Contaminated Sites
 Open Applications of PCB
 Other: _____

3. Declaration

I hereby declare that I will make determined effort towards achieving environmentally sound management of PCB. I accept that all information provided can be shared publicly.

Date: _____

Signature: _____

Please e-mail or mail the completed form to:
 Secretariat of the PEN, Chemicals Branch, DTIE, UNEP
 11-13 Chemin des Anémones, CH-1219 Châtelaine (GE), Switzerland
 E-mail: pen@pops.int or heideldore.fiedler@unep.org

Annex V

Guidelines for updating National Action Plans for the implementation of the LBS Protocol and its Regional Plans in the framework of SAP MED to achieve Good Environmental Status for pollution related ECAP ecological objectives



**UNITED
NATIONS**

EP

UNEP(DEPI)/MED WG.404/7
Annex IV



**UNITED NATIONS
ENVIRONMENT PROGRAMME
MEDITERRANEAN ACTION PLAN**

19 January 2015
Original: English

Guidelines for updating National Action Plans for the implementation of the LBS Protocol and its Regional Plans in the framework of SAP MED to achieve Good Environmental Status for pollution related ECAP ecological objectives

For environmental and economic reasons, this document is printed in a limited number. Delegates are kindly requested to bring their copies to meetings and not to request additional copies.

Table of contents

1.	BACKGROUND	5
1.1	THE STRATEGIC ACTION PROGRAMME TO COMBAT POLLUTION FROM LAND- BASED SOURCES	5
1.2	THE NATIONAL ACTION PLANS	5
1.3	THE 2004 GUIDELINES FOR PREPARATION OF NATIONAL ACTION PLANS	5
1.4	RATIONALE FOR UPDATING THE NAP GUIDELINES	6
2.	THE NAP UPDATING PROCESS	8
3.	INSTITUTIONAL SET-UP OF THE NAP UPDATING PROCESS	10
3.1	INSTITUTIONAL ARRANGEMENTS	10
3.2	WORK METHODOLOGY	10
3.3	INVOLVED STAKEHOLDERS; INTER-LINKAGES TO AND SYNERGY WITH OTHER RELEVANT POLICY FRAMEWORKS AND PROCESSES	11
3.4	TIMELINE FOR COMPLETION	11
3.5	APPROVAL AND ENDORSEMENT	11
4.	METHODOLOGY FOR THE NAP UPDATING PROCESS	13
4.1	ASSESSING THE NAP MIDTERM IMPLEMENTATION BENCHMARK	14
4.2	DEFINING QUANTIFIABLE OBJECTIVES, AND AS APPROPRIATE, OPERATIONAL TARGETS	17
4.3	IDENTIFYING GAPS/ISSUES	17
4.4	PRIORITIZING ISSUES AND IDENTIFYING POTENTIAL MEASURES	18
4.5	SELECTING THE PROGRAMME OF MEASURES FOR POLLUTION PREVENTION AND CONTROL	19
4.6	DEVELOPING THE NAP IMPLEMENTATION FOLLOW-UP AND REPORTING PLAN	20
4.7	DRAFTING THE NAP	21
5.	OTHER TECHNICAL ASPECTS OF THE NAP UPDATING PROCESS TO BE FURTHER DEVELOPED IN CONSULTATION WITH THE CONTRACTING PARTIES	22

APPENDIX A. REQUIREMENTS OF THE ECOSYSTEM APPROACH TARGETS AND REGIONAL PLANS IN THE
FRAMEWORK OF SAP-MED

APPENDIX B. GUIDELINES ON NATIONAL BUDGET OF POLLUTANTS (NBB)

APPENDIX C. UPDATED CRITERIA AND METHODOLOGY TO ASSESS HOTSPOTS AND SENSITIVE AREAS IN
THE MEDITERRANEAN

APPENDIX D. ISSUES/IMPACTS MATRIX FOR SCORING ISSUES ASSOCIATED WITH IMPACTS ON HUMAN
HEALTH AND MARINE ENVIRONMENT

APPENDIX E. LIST OF INDICATORS TO ASSESS THE LBS, DUMPING, HAZARDOUS WASTE PROTOCOLS,
NAP AND REGIONAL PLANS IMPLEMENTATION

APPENDIX F. INFORMATION FOR DEVELOPING AND DRAFTING THE NAP

APPENDIX G. GUIDANCE ON COST-EFFECIVENESS AND COST-BENEFIT ANALYSIS

APPENDIX H. REFERENCE INFORMATION ON TECHNICAL GUIDELINES PRODUCED BY UNEP/MAP FOR
SELECTING MANAGEMENT OPTIONS FOR POLLUTION PREVENTION AND CONTROL

Abbreviations

ACCOBAMS	Agreement on the Conservation of Cetaceans in the Black Sea Mediterranean Sea and Contiguous Atlantic Area
BAT	Best Available Techniques
BEP	Best Environmental Practices
BOD ₅	Biochemical Oxygen Demand
COP	Conference of the Parties
DDT	Dichlorodiphenyltrichloroethane
ECAP	Ecosystem Approach
EEA	European Environment Agency
E-PRTR	The European Pollutant Release and Transfer Register
EU MSFD	European Union Marine Strategy Framework Directive
FAO	Food and Agriculture Organization
GEF	Global Environment Facility
GES	Good Environmental Status
GFCM	General Fisheries Commission for the Mediterranean
GPA	Global Programme of Action
H2020	Horizon 2020 initiative
ICZM Protocol	Protocol on Integrated Coastal Zone Management in the Mediterranean
LBS Protocol	Protocol for the Protection of the Mediterranean Sea against Pollution from Land-Based Sources and Activities
MAP	Mediterranean Action Plan
MEHSIP	Mediterranean Partnership Programme
MEAs	Multilateral Environmental Agreements
NAPs	National Actions Plans
NBB	National (Baseline) Budget of Pollutants
NGO	Non-Governmental Organization
NIPs	National Implementation Plans
NSC	National Steering Committee
PoM	Programme of Measures
POPs	Persistent Organic Pollutants
RACs	Regional Activity Centres
SAICM	Strategic Approach to International Chemicals Management
SAP BIO	Strategic Action Plan for the Conservation of Biological Diversity in the Mediterranean
SAP MED	Strategic Action Programme to combat pollution from land-based sources
SCP	Sustainable Consumption and Production
SEIS	Shared Environmental Information System
TC	Technical Committee
TDA	Transboundary diagnostic analysis
TPB	Toxic, Persistent and Liable to Bioaccumulate
UfM	Union for the Mediterranean
WWTP	Wastewater treatment plant

Note by the Secretariat

The formulation, for the first time in 2004-2005, of National Actions Plans for protection of the Mediterranean Sea from land-based sources marked a significant step by the Contracting Parties towards the implementation of the LBS Protocol and the Barcelona Convention and the respective Strategic Action Programme to combat pollution from land-based sources (SAP-MED).

The process for preparation of the NAPs was supported by a set of guidelines, presented as part of a regional training workshop organized in Izmit, Turkey in 2004. These documents addressed several aspects including preparation of national baseline budget of pollutants; introduction of institutional arrangements for preparation of the NAPs; promotion of public participation and development of economic instruments.

Further to COP 18 Decisions in Istanbul, Turkey in 2013, and as a follow-up to Decision IG 18/X adopted by COP 16 in Almeria, Spain in 2008, the Contracting Parties were requested to initiate the process of updating their NAPs with the view to achieve good environmental status through implementation of the LBS Protocol and Regional Plans.

In order to ensure, to the extent possible, coherence and harmonization of structures and contents of the updated NAPs, and in view of supporting the sound identification of priorities and realistic selection of national measures, and where appropriate national targets, it is recommended to put in place processes and approaches to guide all Countries in a harmonized manner. In this context, there is a need to revisit the NAP guidelines that were discussed and approved in Izmit, Turkey in 2004, and to update them taking into account new developments in particular the adoption of GES and ecological objectives 5, 9 and 10 targets related to pollution and marine litter as well as the 10 regional plans adopted in the framework of Article 15 of the LBS Protocol. The updated guidelines can be also used as an opportunity to use up-to-date principles as well as tools of policy analysis and prioritization.

The “Guidelines for Updating National Action Plans for the Implementation of the LBS Protocol and its Regional Plans in the Framework of the SAP-MED to Achieve Good Environmental Status for Pollution-Related ECAP Ecological Objectives” represents a further substantive development of the 2004-Izmit Guidelines. It attempts to reflect and capture the new spirit and dimensions stemming from the important momentum that MAP and the Region are experiencing through stronger regional governance and intensified efforts by several actors towards pollution prevention and control of the Mediterranean Sea. Specifically, the new Guidelines consider:

- i) The findings of the midterm evaluation of NAP/SAP- MED implementation (2005-2012), and lessons learned, which demonstrate great successes as well as serious gaps towards achieving 2010 and 2025 SAP-MED/NAP and H2020 initiative to “de-pollute the Mediterranean by 2020”.
- ii) Additional commitments of binding and non-binding measures taken by the Parties at global, regional and national levels such as the 10 LBS Protocol regional plans adopted in 2009, 2012 and 2013 by COP 16, 17 and 18, ECAP targets, new Mercury Convention, UNEP/GPA, H2020, EU-MSFD, SAICAM, New POPs under the Stockholm Convention, UNEP/MAP Barcelona Offshore Action Plan and SAP BIO update.
- iii) Several ongoing policy preparation processes at national level addressing pollution prevention and control such as NIPs (Stockholm Convention), SCP Action Plans, ICZM national plans (ICZM Protocol) and enhanced national coordination for hazardous wastes and chemicals recently promoted by UNEP, as well as the process related to preparation of programmes of measures under EU directives with a particular focus on MSFD and the Water Framework Directive.
- iv) The specificities of each Contracting Party to be captured in individually-tailored NAPs that meet the needs of the Party; building on existing relevant work and assessments and not in isolation of existing social, economic and environmental policies and actions. This is in particular valid for a considerable number of Contracting Parties that reached an advanced phase of formulating

programmes of measures covering all 11 ECAP ecological objectives vis-à-vis the three ecological objectives targeted by the NAPs.

The updated NAPs will constitute a powerful national marine pollution control and prevention policy tool that will promote strategic planning for sustainable development. The NAPs' endorsement by COP 14 drew the attention of other major actors and several donor agencies. Its implementation was the main driver for establishing the Mediterranean Partnership Programme (MEHSIP), UfM/former EuroMed H2020 initiative to de-pollute the Mediterranean by 2020, and GEF UNEP/MAP Medpartnership Project. Therefore, it is of utmost importance that the updated NAPs are developed utilizing effective participatory processes, taking into consideration the recently adopted binding measures and achieving the respective good environmental targets adopted by COP 18.

The present guidelines address in an integrated manner various aspects of the NAP preparation process such as institutional, legal, technical, follow-up and reporting, investment needs, capacity building and public participation. Specific in-depth analyses are also presented in the accompanying Appendixes with a view to provide technical guidance to the Countries for identification of potential measures and formulation of a programme of measures. The Appendixesⁱ are complemented with examples, where appropriate, addressing among others:

- i) Specific obligations and implementation timetables under the 10 Regional Plans and ECAP (Ecological Objectives 5, 9 and 10).
- ii) Updated criteria to define hotspots and sensitive areas.
- iii) Prioritization criteria of environmental issues (sectors, substances or other considerations) to be addressed in the NAP.
- iv) NBB key principles; PRTR vis-à-vis NBB
- v) Proposed set of indicators to follow-up and report on NAP implementation in accordance with Article 13 of the LBS Protocol.

1. Background

1.1 The Strategic Action Programme to Combat Pollution from Land- Based Sources

In 1975, the Mediterranean Countries recognized the importance of protecting the Mediterranean Sea from pollution and adopted the Mediterranean Action Plan. One year later, the Barcelona Convention was endorsed. These two instruments were expanded and strengthened in 1980 with the adoption of the LBS Protocol and its amendments in 1996. These developments led in 1997 to the adoption of the Strategic Action Programme to address Pollution from Land-Based Activities (SAP-MED) funded by GEF to support the long term implementation of the LBS Protocol. The SAP-MED identified priority target categories of polluting substances and activities to be eliminated or controlled by the Mediterranean Countries through a planned timetable of pollution prevention and control measures and interventions. It is an action-oriented initiative translating the objectives of the 1995-Global Programme of Action (GPA) of UNEP into regional specific activities. The key activities addressed in the SAP-MED are linked to urban environment and to industrial activities, targeting those responsible for the release of toxic, persistent and bio-accumulative substances into the marine environment, giving special attention to persistent organic pollutants (POPs). The reduction and phasing-out of targets are formulated to take into account the needs and specificities of the region, and as appropriate, in coherence with global and regional commitments under relevant international Conventions and Programmes.

1.2 The National Action Plans

The NAPs were prepared during 2004-2005 by all Mediterranean Countries through a participatory approach in accordance with Article 5 of the LBS Protocol and aimed at operationalizing the objectives of the SAP-MED nationally. The NAPs considered the environmental and socio-economic issues, policy and legislative frameworks, and the management, institutional and technical infrastructure available in the country. The NAPs described the policies and actions on the ground that each country intended to undertake to reduce pollution in line with SAP- MED targets. They incorporated mechanisms for information exchange, technology transfer and promotion of cleaner technology, public participation and sustainable financing. Their fundamental goal was to develop and implement concrete pollution prevention and control projects that enhance economic, technological, and social development at the local level; thus making a concrete contribution towards sustainable development. The NAPs were formally endorsed by the Contracting Parties to the Barcelona Convention in the 14th Contracting Parties' meeting in Slovenia in 2005 (COP 14).

1.3 The 2004 Guidelines for Preparation of National Action Plans

In order to assist the Mediterranean Countries to elaborate National Action Plans that comply with SAP-MED commitments, UNEP/MAP-MED-POL programme developed in 2004 the "Guidelines for Preparation of National Action Plans for the Reduction of Pollution of the Mediterranean From Land-Based Sources". This guidance document was presented in March 2004 in Izmit, Turkey, as part of a workshop for preparation of Sectoral Plans and National Action Plans in the framework of the SAP- MED. It comprised four guidelines:

- i) Guidelines for preparation of National Action Plans for the Reduction of Pollution of the Mediterranean from land-based sources;
- ii) Guidelines for the preparation of the baseline budget of pollutants releases for the Mediterranean region;
- iii) Public participation in the National Action Plans (NAPs) for the strategic Action programme (SAP-MED) to address pollution from land-based activities in the Mediterranean; and
- iv) Guideline for economic instruments for the preparation of the SAP-MED/NAP to address marine pollution from land-based activities in the 12 GEF eligible countries.

The 2004 NAP guidelines presented a phase-by-phase approach for formulating the NAPs based on six steps:

- i) Undertaking national diagnostic analysis and baseline budget.

- ii) Developing national/administrative region(s) issue/impacts matrix.
- iii) Setting-up of administrative region(s) plan.
- iv) Setting-up of national sectoral plans.
- v) Formulating national action plans.
- vi) Setting-up of the national list of priority actions for 2010.

These guidelines were instrumental in developing the 2004-2005 NAPs. Their key aspect was the methodology proposed for elaborating the NAPs based on National Diagnostic Analysis designed to identify the nature and severity of problems. They also presented a system for assessing the relative importance of different impacts on the coastal areas and marine environment based on a process for scoring environmental issues with potential adverse effects on human health and marine environment. The results of this assessment were used to help in selecting the priority issues at national and administrative region(s) levels for the final preparation of the NAP.

1.4 Rationale for Updating the NAP Guidelines

In 2008, the Contracting Parties to the Barcelona Convention adopted Decision IG 17/8 regarding NAP implementation in Almeria (Spain). This Decision, which marked ten years after the adoption of the SAP-MED and three years after endorsing the NAPs, requires Countries to “continue the implementation of NAPs endorsed in 2005 to the greatest possible extent foreseeing their revision in 2011.”

Although the aforementioned obligation constitutes the basis for updating the NAPs; however, the main reason is the further development of the Barcelona Convention system. This entails implementation of the ecosystem approach with the view to achieve Good Environmental Status as well as the adoption of new legally binding measures consisting of the regional plans adopted in the context of the implementation of Article 15 of the LBS Protocol. The updated NAPs will provide the Countries with a unique opportunity for streamlining the new commitments by taking into account the following aspects:

- Streamlining ECAP objectives and targets into the updated NAPs leading to the achievement of Good Environmental Status.¹
- Ensuring that the updated NAP includes, where appropriate, in accordance with country specificities, commitments and obligations of the regional plans and legally binding standards adopted by the Meetings of the Contracting Parties in 2009, 2012 and 2013.²
- Providing some basic principles and technical guidance for assessing existing measures vis-à-vis ECAP-GES and Regional Plans targets in the framework of SAP-MED; identification of gaps; and formulation of programme of measures and their implementation.

¹ Decision IG.20/10 “Adoption of the Strategic Framework for Marine Litter Management”.

Decision IG.21/3 “on the Ecosystems Approach including Adopting Definitions of Good Environmental Status (GES) and Targets”.

² Decision IG.19/7 “Regional Plan on the Reduction of BOD₅ from Urban Wastewater”.

Decision IG.19/8 “Regional Plan on the Elimination of Aldrin, Chlordane, Dieldrin, Endrin, Heptachlor, Mirex and Toxaphene”.

Decision IG.19/9 “Regional Plan on the Phasing Out of DDT”.

Decision IG.20/8.1 “Regional Plan on the Reduction of Inputs of Mercury”.

Decision IG.20/8.2 “Regional Plan on the Reduction of BOD₅ in the food sector”.

Decision IG.20/8.3.1 “Regional Plan on the Elimination of Alpha hexachlorocyclohexane; Beta hexachlorocyclohexane; Hexabromobiphenyl; Chlordecone; Pentachlorobenzene; Tetrabromodiphenyl ether and Pentabromodiphenyl ether; Hexabromodiphenyl ether and Heptabromodiphenyl ether; Lindane; Endosulfan, Perfluorooctane sulfonic acid, its salts and perfluorooctane sulfonyl fluoride”.

Decision IG.20/8.3.2 “Regional Plan on the Phasing out of Lindane and Endosulfan

Decision IG.20/8.3.3 “Regional Plan on the Phasing out of Perfluorooctane, Sulfonic Acid, its salts and Perfluorooctane Sulfonyl Fluoride

Decision IG.20/8.3.4 “Regional Plan on the Elimination of Alpha hexachlorocyclohexane, Beta hexachlorocyclohexane, Chlordecone, Hexabromobiphenyl, Pentachlorobenzene

Decision IG.21/7 “Regional Plan on Marine Litter Management in the Mediterranean”.

Decision IG.20/9 “Criteria and Standards for bathing waters quality”.

- Providing common updated criteria for assessing pollution hotspots and sensitive areas.
- Providing the main elements for follow-up and reporting on NAP implementation and its effectiveness through a restricted set of potential indicators with a view to undertake periodical assessments of NAP implementation on national and regional levels.
- Better promoting the NAP as an important sectorial policy tool fully reflected in the Parties' development policies, at national, regional and local levels.
- Ensuring better complementarities between NAP priorities/targets and implementation under UNEP/MAP-Barcelona Convention and its Protocols with similar commitments and obligations under relevant MEAs, and as well as, where appropriate, in synergy with relevant EU Directives, with a particular focus on EU MSFD, water-related and waste directives.
- Promoting a clear structure of the NAP covering selected priority sectors of the LBS Protocol and legally binding measures implementation (i.e. policy, regulatory, pollution prevention, control and phase-out measures, hotspot elimination, pollution monitoring, pollution assessment, enforcement, effectiveness, capacity building and investment needs).
- Ensuring a sustained participatory process of relevant stakeholders and other relevant policy processes, in particular the Horizon 2020 initiative.

These aspects present new elements which can be incorporated into the process for updating the NAPs, as far as possible, and in a coherent manner by the Countries.

2. The NAP updating process

The principal objective of the NAP update is to identify and prioritize national programmes of measures to achieve Good Environmental Status with regard to pollution-related ecological objectives under ECAP. This update can also provide an opportunity for the Countries to develop a concrete NAP structure that covers a variety of policy, regulatory, institutional, pollution prevention, control and phase-out measures, investment needs, hotspot elimination, monitoring, enforcement, follow-up, reporting and NAP implementation cost. These aspects constitute a framework for the updated NAP.

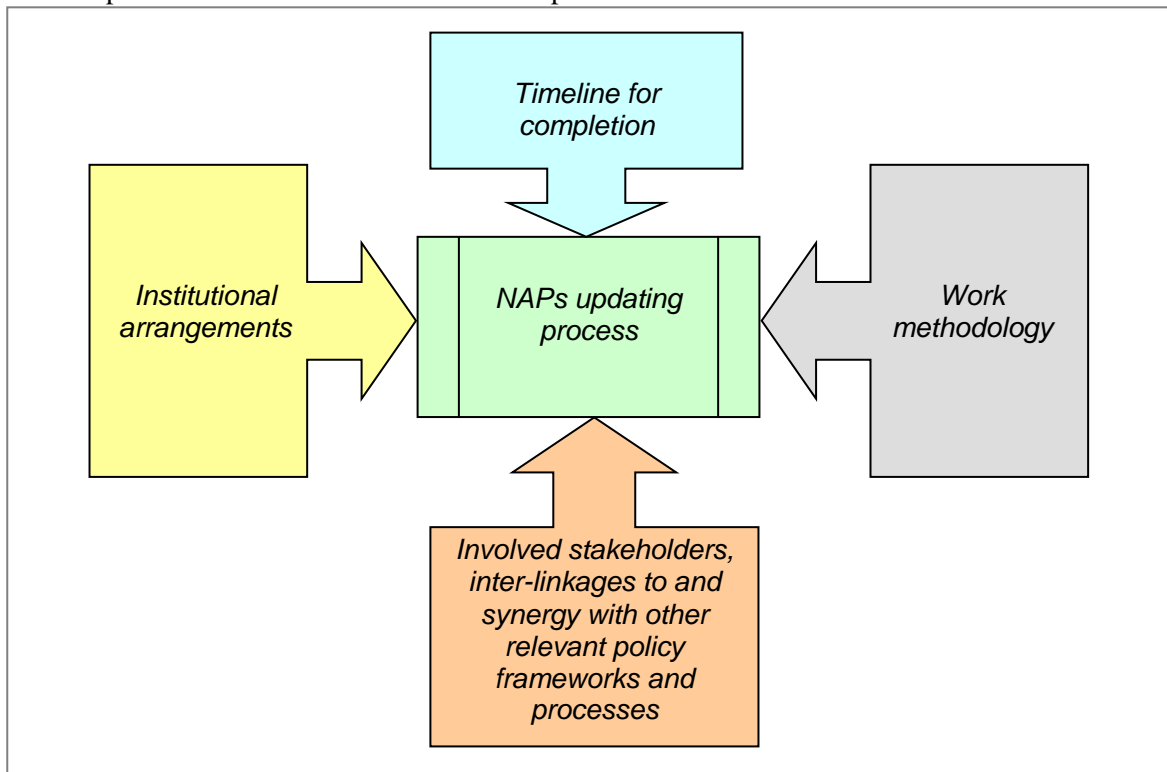

The NAP updating process consists of a series of tasks, with clearly defined responsibilities to implement a well-defined work methodology, empowered by selected stakeholders, governed by special institutional arrangements to accomplish the updated NAP in a fixed timeframe, as shown in the following illustration.

The NAP updating guidelines address two key aspects in the development of the NAP guideline document:

- i) The “institutional” aspects of the NAP updating process consisting of:
 - Institutional arrangements.
 - Work methodology.
 - Stakeholders involved and synergy with other relevant policy processes.
 - Timeline for completion of work.
 - Mechanism for approval and endorsement.
- ii) The “methodological” aspects, or tasks and responsibilities, for undertaking the NAP updating process including:
 - Assessing the midterm implementation benchmark.
 - Defining quantifiable objectives, and where appropriate, operational targets to be achieved with a view to comply with ECAP-GES and Regional Plans targets in the framework of SAP-MED.
 - Identifying gaps and issues between the assessed midterm baseline and SAP- MED targets.
 - Updating list of hotspots, prioritizing issues and identifying potential measures.

- Selecting specific and integrated pollution prevention and control measures to be addressed by the NAP on national, regional and local levels based on cross-cutting analyses, environmental impact, implementation timetable and cost effectiveness.
- Preparing a prioritized list of investment needs.
- Developing a NAP implementation follow-up and reporting plan.
- Developing a capacity building plan.
- Drafting the NAP document.

Details of the institutional and methodological aspects for accomplishing the NAP update are presented in the following sections. Countries formulating relevant integrated programmes of measures for implementation of the 11 ECAP ecological objectives may submit their integrated programmes of measures being the NAPs. In that respect, it is expected that all Mediterranean Countries will be in a position to prepare National Action Plans covering all 11 ecological objectives under the UNEP/MAP-Barcelona system in the future. In fact, the NAPs can be viewed as the first step for preparing programmes of measures by all Mediterranean Countries for pollution prevention and control in line with the ECAP ecological objectives and targets. To facilitate this aim, the Secretariat will organize consultations in the course of the NAPs updating process among all the Countries to promote exchange of information, carry out consultations, and where appropriate, to agree on common measures.

3. Institutional set-up of the NAP updating process

In order to update the NAPs, a number of institutional measures need to be established by the Country in order to successfully develop a proper NAP document that captures the critical issues of relevance. In case the institutional set-up is not developed or is not adequate in the Country, the following measures are recommended.

3.1 Institutional Arrangements

Institutional arrangements are crucial elements to ensure proper coordination and organizational development of the planned activities for updating the NAP. It is recommended to build on relevant existing processes, as appropriate, in order to avoid duplication and overlapping.

The following elements regarding the institutional arrangements for the NAP updating process are recommended:

- i) A national lead agency, possibly a ministry or government agency of equivalent level, which hosts the MAP and/or MED POL Focal Point functions, would be officially assigned the “primary responsibility” for managing the NAP updating process. This agency would be given the authority to establish or activate a multi-stakeholder coordinating and stakeholder input mechanism, provide it with administrative support and ensure the integration of substantive work, as appropriate.
- ii) A high level stakeholder review committee or a national steering committee (NSC). The NSC would be responsible for planning how public and stakeholder awareness should be raised, how stakeholders will be consulted, how information should be communicated and how questions and concerns should be managed. It is recommended that the MED POL focal point is assigned either the post of secretary or of co-chair of this committee.
- iii) An executive unit or a technical committee (TC) responsible for managing the process and for carrying out the preparation and coordination work. The TC would be also responsible for identifying and establishing “thematic groups” to take the lead on technical issues, and for ensuring that links are made to existing programmes and initiatives that affect the implementation of the NAP.
- iv) Thematic groups and experts who would be brought into the project for technical tasks identified by the TC.

3.2 Work Methodology

The recommended work methodology for updating the NAP is based on the following four steps:

- i) A meeting of key Government Departments and agencies is initiated by the NAP national lead agency to establish the TC. The outcomes of this meeting would be the expected membership of the TC; an agreed strategy for stakeholder involvement; and an outline of an initial national steering committee (NSC) or equivalent body including its composition and chair.
- ii) The first meeting of the TC is convened to agree on the rules for updating the NAP. Technical aims and objectives are outlined; responsibilities for areas of NAP updating are assigned; a mechanism for stakeholder involvement is agreed; establishment of the NSC is initiated; and a project outline plan is developed along with estimated resources required and key players that must be involved.
- iii) Periodic briefings and meetings of the TC could be used to ensure that all members are aware of the progress being made by the thematic groups, and to review the aims and findings as they progress.
- iv) The first meeting of the NSC or initiation workshop is held to brief stakeholders on the NAP and its information requirements, rationale and objectives. The project plan for NAP updating is presented. Feedback is gathered on composition of the NSC, interests and aims of stakeholders and issues that need to be addressed. Proposed project plan for the development of the NAP is

presented to the TC, finalized and communicated back to the NSC and wider stakeholder group as appropriate.

3.3 Involved Stakeholders; Inter-linkages to and Synergy with other Relevant Policy Frameworks and Processes

Many of the governmental bodies and nongovernmental organizations that had participated in the development of the initial NAP may also be involved in the NAP update process. In principle, all interested parties, including the ECAP responsible officials, should be given the opportunity to participate and to gain free access to information. The following lists some of the main groups to consider:

- *Policy makers* needed to ensure that the issues raised by the NAP are accorded appropriate priority in their sectoral policies, strategies and plans, and to seek further commitment from legislative bodies. In that respect, it is advisable to encourage politicians with responsibility for international environmental agreements to participate in the process in order to enhance coordinated implementation with other relevant international environmental agreements.
- *Government officials* needed to ensure that key staff are communicating and coordinating the necessary inputs and facilitating the implementation of actions produced by the NAPs. Consideration should be given to officials representing municipalities, environment agencies, public utilities (wastewater and solid waste), industry, agriculture and local authorities.
- *Representatives from industry and commerce* including trade associations and professional bodies. Examples include manufacturing industry, the agricultural sector, the power sector, the waste management industry, and other industrial concerns affected by potential measures to be included in the NAPs.
- *Representatives of the private sector* needed to mobilize new and additional financial resources to address priority pollution and degradation problems in partnership with public agencies.
- *Community representatives* including NGO groups representing civil society, including MAP partners, in order to ensure that their communities' concerns are taken on board.
- *Academic and research institutions* needed to address environmental issues of highly technical nature that may require specialist knowledge.
- *Focal points of international conventions and initiatives* needed to ensure programmatic linkages, where appropriate, to focal points of the relevant MEAs and to other Protocols of the Barcelona Convention, in particular the Dumping and Hazardous Wastes Protocols. Also needed are focal points of initiatives and institutions/organizations such as the Horizon 2020 network, Union for the Mediterranean (UfM), European Environment Agency (EEA), the SEIS Project, UNEP/MAP Regional Activity Centres (RACs), FAO, GFCM, ACCOBAMs, representatives of pollution monitoring institutions, and members of ECAP correspondent group, etc.

3.4 Timeline for Completion

The Contracting Parties should transmit their updated NAPs by COP 19.

3.5 Approval and Endorsement

NAP document should be endorsed by the NSC. With the view to enhance public and decision makers' awareness on the importance of the NAP and its added value, it is recommended to carry out the following tasks:

- Producing suitable communication and public relations materials which convey the contents, intentions and need for and benefits of the NAP for stakeholders.
- Establishing a consultation mechanism, with suitable commentary and explanation if necessary, to ensure that stakeholders within and outside Government are made aware of the NAP, and to gather feedback for assessment.
- Reviewing the feedback from the consultation process and adopting the NAP.

- Submitting the final version of the NAP for endorsement by the relevant national authorities (government ministers, heads of agencies, etc).
- Publishing the official version of the NAP in on the MAP and Environmental Ministry/Agency websites.
- Submitting the NAP to the Secretariat and to the Meeting of the Contracting Parties for endorsement.

4. Methodology for the NAP updating process

The following flow chart recommends the process tasks, principal steps and key issues to be considered in the NAP updating process.

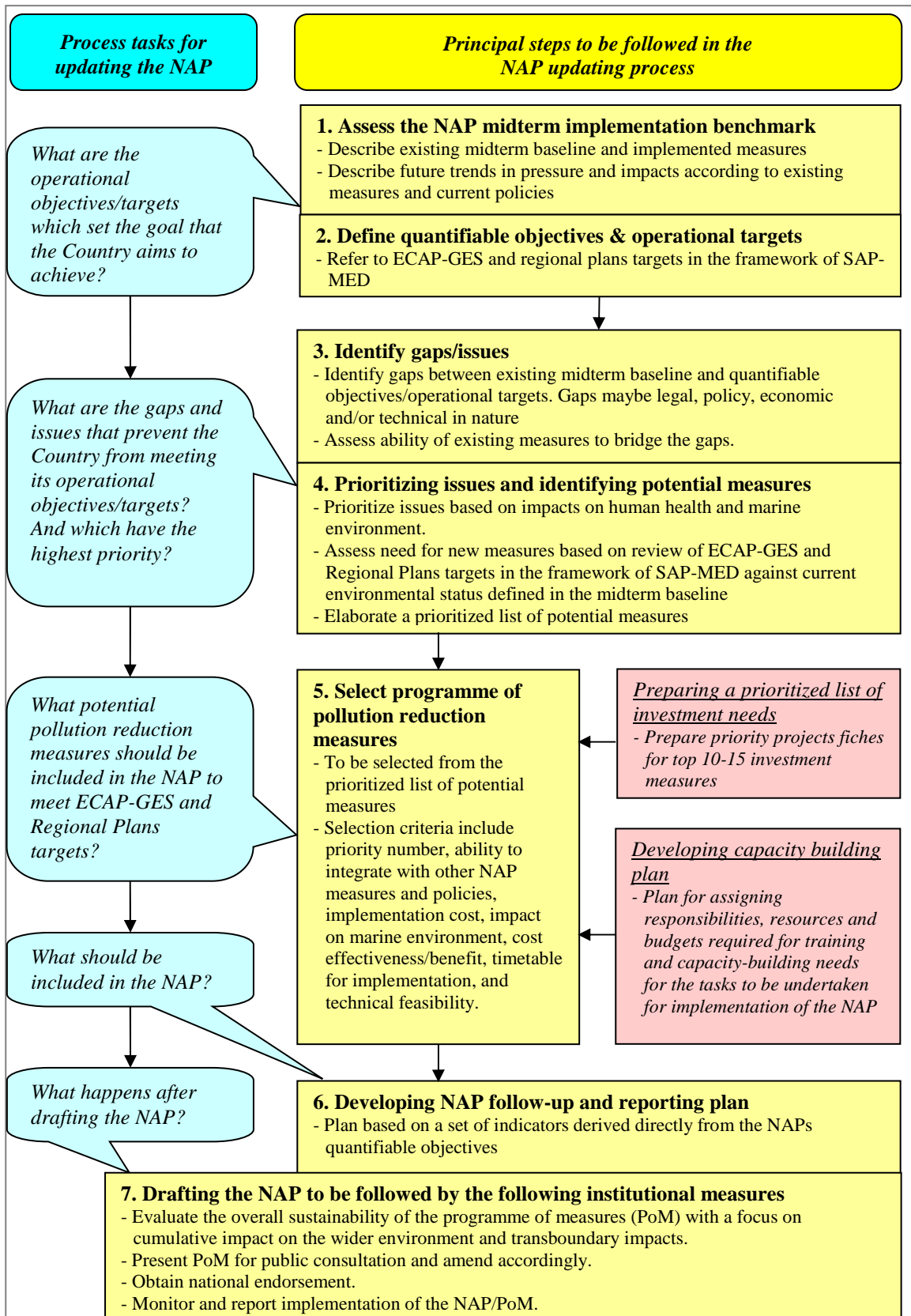

The recommended NAP updating methodology consists of the following steps:

1. Assess the state of play of existing measures and the current status of marine and coastal pollution, referred to as the NAP midterm baseline.
2. This is followed by the performance of a gap analysis to evaluate the need for implementing additional actions to fill the gap between existing measures and status of the marine pollution with reference to the defined ECAP–GES and regional plan targets in the framework of the SAP-MED.
3. Gap analysis would lead to prioritization of issues and identification of potential new measures, as appropriate.
4. The potential prioritized measures are assessed for their technical feasibility and analyzed in an integrated manner taking into account their resulting impacts on the marine environment, implementation cost, cost effectiveness/benefit, duration for implementation with the view to develop an integrated programme of measures for inclusion in the NAP.

A practical example illustrating the process for developing pollution prevention and control measures for marine litter, including a description of the quantifiable targets, midterm baseline, gaps and the selected measures to be included in the NAP, is presented in Appendix F.

Details of the recommended methodology for the NAP updating process are presented in the following sections.

4.1 Assessing the NAP Midterm Implementation Benchmark

The midterm baseline³ captures the outcomes of actions taken by the Contracting Parties in the framework of SAP- MED/NAP implementation since the initiation of this process in 2004-2005 until 2013. There is a need for the Contracting Parties to evaluate the effectiveness of these actions and existing measures vis-à-vis the long-term provisions of the SAP-MED; the legally binding provisions of the 10 Regional Plans and their timetables for implementation standards, and the GES targets of ECAP Ecological Objective 5 on eutrophication, Objective 9 on contaminants and Objective 10 on marine litter.⁴ Furthermore, there is a need to describe future trends in pressures and impacts according to the present national budget of pollutants (NBB), existing policies and measures, and their effect on the current status of the identified hotspots.

Proposed tasks and responsibilities for the thematic groups

It is expected that the main effort for assessing the midterm baseline would be the responsibility of the thematic groups. The technical committee (TC) would form these groups. However, the participation of key stakeholders in the process would be essential for obtaining reliable results. It is therefore important for the TC to identify those groups and individuals and to ensure their involvement. The following table proposes the formation of eight thematic groups to be established as appropriate in line with the specificities of each Country, and illustrates their contribution to addressing the SAP- MED sectors/pollutants.

³ The term "Midterm" is introduced as the Countries are presently half way, time wise, towards the SAP-MED targets set for the year 2025 since the adoption of the NAPs in 2005.

⁴ UNEP(DEPI)/MED ID.21/9. Decision IG.21/3 on the Ecosystems Approach including adopting definitions of Good Environmental Status (GES) and targets.

Pollutants/sectors included in Annex (I) of the LBS Protocol	Thematic groups on municipal/urban			Thematic groups on industrial			Group on agriculture	Group on monitoring
	Waste water	Solid waste	Air pollution	Waste water	Solid waste	Air pollution		
Urban municipal wastewater								
Urban Solid waste and marine litter								
Air pollution in urban areas								
Toxic, Persistent and Liable to Bioaccumulate (TPB)								
Heavy metals								
Organohalogen compounds (halogenated aliphatic and aromatic hydrocarbons, Chlorinated phenolic compounds and organo-halogenated pesticides)								
Radioactive substances								
Nutrients and suspended solids from the food industry, livestock farming, and other industrial activities								
Hazardous wastes (obsolete chemicals, lubeoil and batteries)								

Members of the thematic groups may consist of legal, policy and technical experts in their fields (wastewater, solid waste and air pollution in urban or industrial setting), in addition to marine environment experts. For the agricultural thematic group, technical experts should be qualified in best environmental practices in agriculture.

Regarding the marine environment monitoring group, it may be composed of monitoring experts from the other seven groups. It is highly recommended that members of the group coordinate with the experts of the correspondence monitoring group under ECAP. The monitoring group applies an integrated approach to examine the monitoring issue vis-à-vis the sectoral approach used by the other groups. The marine environment monitoring group should fully take into account the ongoing work for preparation of the integrated monitoring programme based on the agreed ecosystem approach indicators on eutrophication, contaminants and marine litter. The monitoring group also follows-up and reports on NAP implementation prior to presentation to the NSC for final approval.

Each thematic group describes the midterm baseline in terms of aspects related to existing legal, policy, and technical measures, in addition to the state of marine and coastal pollution as described below:

- i) **Legal Measures** (national laws and regulations) that support:
 - Implementation of measures for the prevention and control of priority substances.
 - Implementation of measures provided for in the 10 Regional Plans.
 - Ecosystem approach targets, monitoring requirements and any related measures.
 - Phasing out inputs of substances included in Annex (I) of the LBS Protocol from land-based sources.
 - Authorization and regulation of point source discharges.
 - Establishment of inspection system to assess compliance.
 - Application of sanctions in event of non-compliance.
 - Established legal and institutional structures that support:
 - Monitoring and inspection of the inputs of the priority pollutants to the Mediterranean environment.
 - Authorization and regulation of discharges of wastewater and air emissions from industrial and urban installations.
 - Public participation in decision-making processes.
 - Public access to information.
 - Reporting of measures taken and results achieved.

- ii) **Economic Measures**
 - Use of incentive policy tools such as economic and financial instruments in support and combination with traditional pollution control and command tools.

- iii) **Policy Measures** (National and regional policy frameworks) consisting of:
 - Strategies and action plans addressing treatment and disposal of municipal sewage; reduction, recycling and composting of urban solid waste; control of levels of air pollutants in cities; reduction of point source discharges and air emissions from industrial installations; disposal of hazardous wastes; safeguarding the ecosystem and maintaining the integrity and biological diversity of species and habitats.
 - Strategies that promote sustainable development, ICZM and integration of environmental protection into national development policies.
 - National strategies that promote:
 - Raising public environmental awareness and supporting educational activities.
 - Capacity building to improve the scientific base, environmental policy formulation, professional human resources, institutional capacity and capability.

- iv) **Technical measures**
 - Pollution prevention, control and phase-out schemes regarding releases of SAP- MED priority substances and groups of pollutants; BAT, BEP, SCP, etc. In that respect, the National Budget (NBB) reports for 2008 and 2013 (latter in progress), which include data on pollution loads for priority substances, should be evaluated in relation to:
 - The extent to which a comprehensive inventory of the existing pollution sources in each river basin/administrative region in the coastal zone has been performed;
 - Classification of pollution sources into sectors according to Annex (I) of the LBS protocol;
 - Identification of the potential pollution sources (point versus diffuse sources) of each pollutant targeted by the SAP;
 - Quantification/estimation of the emissions/releases on the basis of the river basin/administrative region approach; and,

Guidelines on the preparation of 2013 national budget of pollutants (NBB) are presented in Appendix B.

- Use of PRTR for reporting purposes.
- Status of hotspots and sensitive areas:
 - The Contracting Parties had recognized in 2003 the list of pollution hotspots and sensitive areas in the Mediterranean. They were listed in the NAPs as priority areas for which interventions should be targeted.
 - There is a need for assessing the hotspots and sensitive areas against the updated criteria included in Appendix C⁵ which fully take into account GES targets.

The thematic groups are strongly recommended to refer to the midterm evaluation of SAP-MED/NAP implementation report⁵; country profiles and fact sheets completed by UNEP/MAP MED POL with contribution from the Contracting Parties; the national country and regional reports prepared by the UfM with regards to the investment portfolio of NAP implementation⁶; national state of the environment reports prepared during the period 2003-2013; Mediterranean state of environment reports for 2009, 2011 and 2012; ECAP sub-regional reports on pollution prepared by UNEP/MAP MEDPOL in 2010-2011; the initial integrated assessment report elaborated under ECAP in 2011; the joint report EEA-UNEP/MAP on the progress of H2020; In addition to the UNEP/MAP transboundary analysis report and hotspot reports, information on pollutants' releases and trends can be found in the initial assessment, GES and targets reports prepared in the framework of the EU Marine Strategy Directive by the respective EU member countries, as well as through EPRTR.

4.2 Defining Quantifiable Objectives, and as appropriate, Operational Targets

In line with the NAP midterm baseline assessment, the Contracting Parties need to establish a set of “quantifiable objectives” and as appropriate “operational targets” for land-based sources. The aim is to achieve the ECAP–GES and Regional Plans targets in the framework of the SAP-MED. In this regard, it is noted that the SAP- MED objectives are defined based on the TDA 2003 baseline.

A comprehensive list of key commitments and obligations stipulated in the ECAP–GES and regional plans targets in the framework of the SAP-MED has been compiled in Appendix A for indicative purposes and with the view to facilitate the work of the Parties (i.e. the thematic groups) when elaborating their specific quantifiable objectives and where appropriate operational targets. These requirements are classified according to policy frameworks, legal/institutional structures and pollution prevention and control measures. For each of these three headings, commitments and obligations are highlighted based on SAP- MED sector/substance, along with deadlines for achievement. In referring to these requirements, it is possible for each thematic group to define the specific quantifiable objectives and operational targets needed for the NAP updating process.

4.3 Identifying Gaps/Issues

A gap analysis is performed to define the gaps between the existing baseline,⁷ which reflects the current situation, and the desired targets that constitute the aim. This process is referred to as “baseline mapping”.

Based on the list of quantifiable objectives, and where appropriate operational targets, and with reference to the elaborated midterm baseline, the thematic groups would investigate and assess the gaps between the midterm baseline and the requirements of the binding measures. This analysis would focus on:

- i) Description of the gaps and issues at the policy/legal/regulatory levels, in addition to other pollution prevention and control measures and monitoring/reporting aspects.

⁵ UNEP(DEPI)/MED WG.393 inf.3. Midterm Evaluation of SAP/NAP Implementation.

⁶ UNEP(DEPI)/MED WG.393 inf.4. Final Report on Update Priority Investment Projects for Protecting the Mediterranean Sea from pollution.

⁷ With an extrapolation up to 2025 and population and economic growth.

- ii) Description of information gaps and issues for optimal monitoring required under the ecosystem approach for Objective 5 regarding eutrophication, Objective 9 dealing with contaminants, and Objective 10 on marine litter and other LBS Protocol requirements.
- iii) Assessment of hotspots based on the updated criteria included in Appendix C with the aim to reclassify hotspots as appropriate whereby each newly classified hotspot is an issue on its own that needs to be addressed in the updated NAP.

Hence, the outcome of the gap analysis is a list of issues of legal, policy or technical nature. Since it is not possible to address all issues at the same time in the NAP, some sort of prioritization to rank from most to least important is required. Prioritization of issues and identification of potential measures derived from the gap analysis is presented in the next step.

4.4 Prioritizing Issues and Identifying Potential Measures

In this step, a systematic methodology for ranking issues and hotspots, which were identified through the gap analysis and for identifying potential measures, is presented. In principle, each sector/substance has its own gaps or issues, which may be legal, policy or technical in nature. Different administrative region(s)/river basins will have different issues for the same sector/substance. The degree of importance of each issue will depend on its impact and the significance of that impact on aspects such as human health and the marine environment. For the purpose of ranking issues, the criteria of the 2004 NAP Guidelines are proposed in Appendix D⁸ for indicative purposes. An issue/impact matrix can be utilized in order to make the preliminary assessment of the relative importance of the different impacts on the coastal areas including marine environment. The derived issues are scored in the matrix according to their relevance to the national environmental priorities taking into consideration the legally binding measures, the ECAP GES targets, the SAP targets and the requirements of the regional plans. The thematic groups are encouraged to agree on the weights assigned to different sector/substances with a view to ensure consistency in assessing the required impacts

Following the prioritization process, potential measures are identified/prioritized. These measures and their programme consist of possible actions for the management of land-based activities in order to meet commitments under the ECAP-GES and Regional Plans targets in the framework of SAP-MED. The measures may take several modes of action such as technical, legislative/regulatory, economic and policy-driven. Actions that may indirectly and only over long timeframes affect environmental status, such as research activities, should be considered as supplementary and contributing to specific measure implementation.

The TC coordinates with the thematic groups for identifying appropriate programme of measures to be included in the NAP. The TC also coordinates between all actors for common intervention areas such as policy and legal issues, monitoring, enforcement and reporting. In developing the management options, the TC should focus on the SAP- MED sectoral programmes, namely:

- i) Municipal wastewater collection and treatment.
- ii) Municipal solid waste and marine litter.
- iii) Air pollution.
- iv) Toxic, Persistent and Liable to Bioaccumulate (TPB).
- v) Heavy metals.
- vi) Organohalogen compounds.
- vii) Radioactive substances.
- viii) Industrial wastewater treatment including food industry.
- ix) Agricultural activities including livestock and farming.
- x) Hazardous wastes.

The prioritized lists of potential measures are first developed on the regional level. These are collected by the TC and combined into a single list, for each region/river basin, and for all SAP sectors/substances. The

⁸ This Appendix may be adjusted following the update of the list of priority contaminants in the Mediterranean.

regional lists are subsequently combined by the TC into a single national priority list of potential measures for all sectors/substances.

4.5 Selecting the Programme of Measures for Pollution Prevention and Control

The key objective of this phase is to select the programme of measures for pollution prevention and control from the single combined national priority list of potential measures. The purpose of this exercise is to identify the specific and integrated measures to be included in the NAP. This is accomplished by conducting cross-cutting analyses for the potential measures of national priority. Measures need to be evaluated based ability to integrate with other NAP measures and policies, implementation cost, impact on marine environment, cost effectiveness/benefit, timetable for implementation, and technical feasibility. Some of these measures will require investment projects; implementation of BAT and BEP, SCP tools; others will need updates of legal instruments, institutional structures, policy frameworks, a major revision in a national sectoral strategy, some specific actions in hotspots, improved monitoring and enforcement legislation and institutional arrangements, or even new strategies for public participation and reporting. Guidance on cost-effectiveness and cost-benefit analysis is presented in Appendix G. Reference information on selecting management options that can be found in the technical guidelines produced by UNEP/MAP are listed in Appendix H.

The following factors should be considered when selecting the appropriate pollution prevention, control and phase-out and elimination measures:

- i) Details of the principal requirements under the ECAP-GES and Regional Plans targets in the framework of SAP-MED. These constitute a time-tabled list of actions that should be addressed in the NAP. These requirements (tabulated in Appendix A) should be examined on a case-by-case basis. Some of these actions have past deadlines and should have been accomplished in the initial NAP. Others do not have a fixed date (as per the SAP- MED); hence the Country has some freedom in specifying a suitable deadline. Actions may be policy, legal, institutional or technical in nature. Some require substantive investment and need additional preparatory work in order to develop its investment portfolio.
- ii) Links should be made, when appropriate, to relevant national initiatives to eliminate duplication or conflict and maximize efficiency (e.g. chemicals management, waste management and disposal, pollution prevention and control, sustainable development, etc.).
- iii) Improved complementarities should be achieved between NAP implementation under the Barcelona Convention with similar commitments and obligations under other relevant MEAs.
- iv) The administrative requirements for implementation of NAP actions should be considered. For actions requiring institutional and regulatory strengthening measures, it is recommended to address mechanisms for adoption into local law, and responsibilities for implementation. Therefore, it is proposed to develop a detailed “road map” to show what measures will be required, what actors are needed and what resources are necessary. The roles and responsibilities of key players should be detailed, along with a mechanism for implementation. The role and inputs required of international organizations and financial and technical resources required should also be detailed.
- v) A sustained participatory process of relevant stakeholders should be ensured.

In order to facilitate the implementation of critical measures that require significant investments, Countries are recommended to refer to the UfM study on midterm evaluation of the implementation of the investment portfolio of NAP⁶. The study contains recommendations regarding potential investment needs in the Mediterranean Countries to comply with Regional Plans obligations and targets and as appropriate with SAP MED 2025 targets. For that purpose, Countries are recommended to (i) update the list of projects identified in the UfM study with the main information attached to each of them (i.e. location, state of progress and funding, capacity and estimation of pollutants loads or costs) and (ii) develop projects’ fiches for the top 10 to 15 priority national investment projects. Each fiche should include:

- i) Project rationale.
- ii) Clear de-pollution objectives.
- iii) Investment needs.

- iv) Potential internal/external financial resources for implementation.
- v) Link to national public investment policy.
- vi) Identification of key partners (including private sector).

It is also strongly recommended that roundtable or partnership meetings with representatives from key sectors and financial institutions be convened in order to involve them as stakeholders from the outset and promote the investment process. It is the responsibility of the NSC to undertake this task. The Secretariat will collaborate with relevant partners to provide the necessary support to Countries for the selection of priority investment needs and projects' fiches development based on common and environmental sound criteria. UfM has developed a number of criteria in cooperation with UNEP/MAP⁶ that require further analysis and finalization. These will be provided to the Countries for consideration at a later stage following discussion and agreement by the MEDPOL FPs.

It has to be noted that the existing Horizon 2020 Initiative is entering into a new phase 2015-2020 which will provide funding for capacity building, technical assistance and investments to support the implementation of the NAPs. Every effort should be made at national and regional levels to maximize the effectiveness of funding for the implementation of the NAPs.

In addition, it is recommended that Countries (i.e. technical committees) formulate a plan that assigns responsibilities, resources and budgets required for implementation of the NAP programme of measures. The plan should be presented and approved by the NSC.

It is recommended that the capacity building plan addresses the following issues:

- i) Formation of task teams composed, whenever possible, of existing specialized institutions and agencies already appointed by relevant ministries to perform specific tasks. Representatives of academia and various other sectors may also be involved.
- ii) Identification of priority areas where current capacity and capability need to be strengthened to implement the NAP. Priorities based on the need to meet obligations and country-priority issues would be highlighted.
- iii) Timetable for implementation of training plan summarizing the principal targets contained in the training strategy, outlining specific targets, milestones and performance and outcome indicators to allow progress to be reviewed and monitored.
- iv) Cost for implementation including projected costs of training measures. Incremental costs for measures would be identified and potential sources of funding for both incremental costs and baseline costs would be noted.

4.6 Developing the NAP Implementation Follow-up and Reporting Plan

The purpose of the NAP follow-up and reporting plan is to track performance of NAP implementation; to inform stakeholders and the Secretariat on work progress and achievements made; assess effectiveness of measures taken including capacity building and technical assistance activities/plans; and propose corrective measures as appropriate.

The Secretariat will assess the information provided by the Countries on NAP implementation to identify progress made and difficulties related to NAP implementation, and to tailor country-driven assistance to overcome challenges. In addition, the Secretariat will undertake regional synopsis for contributing to the preparation of the State of the Mediterranean Environment Report.

The outcome of the NAP follow-up and reporting plan is a set of time-bound performance indicators derived from: (i) ECAP pollution monitoring indicators in accordance with Article 12 of the Convention, Article 8 of the LBS Protocol, and (ii) the sources and management actions taken. It is recommended to streamline the regional plan indicators with NAP indicators to the extent possible.

It is the responsibility of the monitoring thematic group to develop the appropriate plan needed to follow-up performance of NAP implementation. This is achieved by means of follow up indicators whereby each

indicator provides a measure of the level of performance of the corresponding objective. The follow-up and reporting plan consists of:

- i) Details on type of information and data that need to be collected for each indicator (indicator fact sheet).
- ii) Frequency for collecting the relevant information and data that can assist in evaluating performance of NAP implementation.
- iii) Responsibility for collecting and analyzing collected information and data.
- iv) Responsibility for reporting the findings on the indicators.
- v) The Parties to whom the results of the indicators should be provided, with specific details on:
 - Public access to NAP implementation indicators.
 - National information system established or updated based on the SEIS principles.

The monitoring group derives the indicators from approved targets, and incorporates the state indicators already developed for the ECAP operational objectives. The monitoring group provides guidance for each indicator regarding:

- i) The required data and information;
- ii) Where this information can be found; and
- iii) Responsibility for data collection and analysis.

The monitoring group obtains approval of the TC and the NSC for the follow-up and reporting plan. The monitoring group coordinates with the Lead Agency for approval of the guidance notes for collection and analysis of information needed for the indicators. The monitoring group also coordinates with the Lead Agency for the development of the reporting mechanism on work progress and achievements made.

A list of indicators to be used for LBS, Dumping, HW Protocols, RPs and NAP implementation follow-up and reporting to the Secretariat is included in Appendix E. The Lead Agency is delegated with the responsibility for information collection and data analysis. The reporting frequency is yearly with a midterm evaluation in 2020 and final evaluation in 2025.

4.7 Drafting the NAP

The objective of this step is to produce a draft NAP document which is ready for distribution and discussion with relevant stakeholders. The TC is responsible for drafting the NAP document and for coordinating with the NSC for review and approval. The TC could draw on assistance from consultants, external experts and organizations if necessary.

The following points need to be considered during the drafting of the NAP document:

- i) The NAP should be presented as a policy tool at national, regional and local levels, fully reflected in the national policy documents.
- ii) The NAP should be developed as a solid communication tool for reach out to government officials and the public.
- iii) It is useful to present a clear structure of the NAP covering all aspects of implementation of the LBS protocol (i.e. policy, regulatory, pollution prevention, control and phase-out measures, hotspot elimination, monitoring, assessment and enforcement), and regionally legally binding measures to achieve Good Environmental Status.
- iv) A logical framework matrix may be useful to show clearly what steps must be taken to implement a proposed option, and what actions and resources are needed to make them possible. The log frame, illustrated in Appendix F, should address the following points:
 - Quantifiable objective/operational target and timetable for implementation.
 - SAP- MED area(s) where reduction will take place linked to the ECAP objectives and targets, and the relevant Regional Plan/Standards.
 - Measure/activity cost.
 - Leading institution and other stakeholders/partners and institutions involved.

- The reduction tracking method/monitoring (NBB, PRTR, and marine pollution monitoring).
 - Capacity building needs.
 - Indicators to measure performance.
 - Monitoring tracking method.
 - Risks and assumptions.
- v) A NAP document may include the following main topics:
- Summary of achievements made in the initial NAP and challenges facing implementation of the updated NAP.
 - Assessment of the midterm implementation benchmark.
 - Quantifiable objectives or national targets.
 - Gaps analysis and identification and prioritization of issues.⁹
 - Priority measures/programmes of measures for the National Action Plan and timetable for implementation of measures.
 - Capacity building and technical assistance plan.
 - NAP implementation financial sustainability plan.
 - NAP implementation follow-up and reporting system plan.
 - Public information, awareness raising and education plan.
 - Revised list of hotspots and sensitive areas.
 - List of investment needs with analysis of coherence between them and ECAP, regional plans and, as appropriate, SAP targets, and with 10 to 15 summary project fiches on priority investment measures.

Appendix F contains detailed outline and guidance information for drafting the updated NAP.

5. Other technical aspects of the NAP updating process to be further developed in consultation with the Contracting Parties

Updating of some of the technical aspects of the NAPs will require further elaboration in consultation with all Contracting Parties. These include:

1. Criteria proposed for prioritizing sectors, substances and other environmental considerations.
2. Considerations for future regional plans in the framework of art. 15 of the LBS Protocol.
3. UfM developed a number of criteria in cooperation with UNEP/MAP with regards to project prioritization.⁶ Such criteria require further analysis and finalization by the Contracting Parties.

⁹ In case of past legally binding targets not met, more detailed actions to get in conformity will be described.

APPENDIX A. Requirements of the Ecosystem Approach targets and Regional Plans in the framework of SAP-MED

This Appendix includes a list of the requirements and obligations to be fulfilled by the Contracting Parties for implementation of their National Action Plans (NAPs).

These requirements were derived from the following measures:

- a) Strategic Action Programme (SAP-MED), 1997.
- b) Decision IG.19/7 “Regional Plan on the Reduction of BOD₅ from Urban Wastewater”.
- c) Decision IG.19/8 “Regional Plan on the Elimination of Aldrin, Chlordane, Dieldrin, Endrin, Heptachlor, Mirex and Toxaphene”.
- d) Decision IG.19/9 “Regional Plan on the Phasing Out of DDT”.
- e) Decision IG.20/8.1 “Regional Plan on the Reduction of Inputs of Mercury”.
- f) Decision IG.20/8.2 “Regional Plan on the Reduction of BOD₅ in the food sector”.
- g) Decision IG.20/8.3.1 “Regional Plan on the Elimination of Alpha hexachlorocyclohexane; Beta hexachlorocyclohexane; Hexabromobiphenyl; Chlordecone; Pentachlorobenzene; Tetrabromodiphenyl ether and Pentabromodiphenyl ether; Hexabromodiphenyl ether and Heptabromodiphenyl ether; Lindane; Endosulfan, Perfluorooctane sulfonic acid, its salts and perfluorooctane sulfonyl fluoride”.
- h) Decision IG.20/8.3.2 “Regional Plan on the Phasing out of Lindane and Endosulfan
- i) Decision IG.20/8.3.3 “Regional Plan on the Phasing out of Perfluorooctane, Sulfonic Acid, its salts and Perfluorooctane Sulfonyl Fluoride
- j) Decision IG.20/8.3.4 “Regional Plan on the Elimination of Alpha hexachlorocyclohexane, Beta hexachlorocyclohexane, Chlordecone, Hexabromobiphenyl, Pentachlorobenzene
- k) Decision IG.20/9 “Criteria and Standards for bathing waters quality”.
- l) Decision IG.20/10 “Adoption of the Strategic Framework for Marine Litter Management”.
- m) Decision IG.21/3 on the Ecosystems Approach including Adopting Definitions of Good Environmental Status (GES) and Targets.
- n) Decision IG.21/7 “Regional Plan on Marine Litter Management in the Mediterranean”.

The requirements are categorized into three groups:

- a) Policy framework.
- b) Legal instruments and institutional arrangements.
- c) Pollution prevention and control measures.

For each of these groups, the requirements are further classified into the following SAP- MED sectors, along with its origin in *[brackets]*:

- a) Urban environment
- b) Industrial development
- c) Physical alterations and destruction of habitats
- d) Monitoring and inspection
- e) Capacity building
- f) Public participation
- g) Reporting.

Sector Substance		Policy Requirements of ECAP and Regional Plans Targets in the framework of the SAP-MED	Timetable
Urban Environment	Municipal Wastewater Treatment	Promotion of separate collection of rain waters and municipal wastewaters [<i>SAP- MED Requirement</i>]	Not specified ¹
		Promotion of reuse of treated effluents for the conservation of water resources [<i>SAP- MED Requirement</i>]	Not specified ¹
		Limit concentrations of key nutrients in the marine environment to levels which are not conducive to eutrophication ² [<i>ECAP Requirement</i>]	2015
		Prevention of direct and indirect effects of nutrient over-enrichment in the marine environment [<i>ECAP Requirement</i>]	2015
		Ensuring that water quality in bathing waters and other recreational areas does not undermine human health ³ [<i>Regional Plan Requirement</i>]	2015
	Solid Waste	Minimization of impacts related to properties and quantities of marine litter in the marine and coastal environments ⁴ [<i>Regional Plan Requirement</i>]	2015
		Control of impacts of litter on marine life to the maximum extent practicable ⁵ [<i>Regional Plan Requirement</i>]	2015
		Reduction of fraction of plastic packaging waste that goes to landfill or incineration [<i>Regional Plan Requirement</i>]	2019
		Ensuring adequate urban sewer systems, WWTP and waste management systems to prevent run-off and riverine inputs of Marine Litter [<i>Regional Plan Requirement</i>]	2020
		Application of cost effective measures to prevent any marine littering from dredging activities [<i>Regional Plan Requirement</i>]	2020
		Urban solid waste management is based on reduction at source with the following waste hierarchy: prevention, re-use, recycling, recovery, and environmentally sound disposal [<i>SAP- MED Requirement</i>]	2025
	Air Pollution	Promotion of traffic management that prioritize the use of public transport [<i>SAP- MED Requirement</i>]	Not specified ¹

¹ Deadline is not specified in the SAP.

² Concentrations based on local hydrological, chemical and morphological characteristics of the un-impacted marine region.

³ Based on concentrations of intestinal enterococci.

⁴ Measured based on trends in amounts of litter in the water column, including micro-plastics, and on seafloor.

⁵ Measured based on trends in the amount of litter ingested by or entangling marine organisms, especially mammals, marine birds and turtles.

Sector Substance		Policy Requirements of ECAP and Regional Plans Targets in the framework of the SAP- MED (<i>continued</i>)	Timetable
Industrial Development	POPs, Heavy Metals (Hg, Cd, Pb), Organometallic Compounds	Application of BAT and BEPs for environmentally sound management of POPs <i>[Regional Plan Requirement]</i>	Deadline passed ⁶
		Concentration of priority ⁷ contaminants in biota, sediment or water is kept within acceptable limits <i>[SAP- MED Requirement]</i>	Not specified ¹
		Minimization of effects of released contaminants to the marine environment such as not to give rise to acute pollution events <i>[ECAP Requirement]</i>	2015
		Prevention of acute pollution events and minimization of their impacts <i>[ECAP Requirement]</i>	2015
Physical Alterations and Destruction of Habitats	Safeguard of the ecosystem function and maintenance of the integrity and biological diversity of species and habitats <i>[SAP- MED Requirement]</i>	Not specified ¹	
Capacity Building	Support, promotion and facilitation of programmes of assistance in pollution control and reduction in the area of scientific, technical and human resources <i>[SAP- MED Requirement]</i>	Not specified ¹	
	Support, promotion and facilitation of capacities to apply, develop and manage access of cleaner production technologies as well as Best Available Techniques (BAT) and Best Environmental Practices (BEP) <i>[SAP- MED Requirement]</i>	Not specified ¹	
Public Participation	Facilitation of public access to scientific knowledge and activities for protection and management of the environment <i>[SAP- MED Requirement]</i>	Not specified ¹	
	Mobilization, participation and involvement of major actors concerned in protection and management of the environment (local and provincial communities, economic and social groups, consumers, etc.) <i>[SAP- MED Requirement]</i>	Not specified ¹	
	Enhancement of public awareness and education of pollution, and involvement of various stakeholders with regard to marine litter management including activities related to prevention and promotion of sustainable consumption and production <i>[Regional Plan Requirement]</i>	2015	
	Seek direct cooperation with other Contracting Parties, with assistance of the MEDPOL or competent international and regional organizations, to address trans-boundary marine litter cases <i>[Regional Plan Requirement]</i>	As appropriate	
	Provision of information to the public about bathing water quality and implemented management measures <i>[Regional Plan Requirement]</i>	2016	
Reporting	Application of a unified reporting system for implementing the provisions of the Barcelona Convention, the Protocols, the SAP- MED, the Regional Plans and ECAP objectives <i>[SAP- MED Requirement]</i>	Not specified ¹	

⁶Deadline specified in the binding measure precedes the date of this document.

⁷Priority contaminants as listed under the Barcelona Convention and LBS Protocol.

Sector Substance		Legal Requirements of the Regional Plans in the framework of the SAP- MED	Deadline
Urban Environment	Municipal Wastewater Treatment	Adopt emission limit values (ELV) for BOD5 in urban wastewater after treatment in accordance with the requirements of the “regional guideline on the reduction of BOD5 from urban waste water” <i>[Regional Plan Requirement]</i>	2015 or 2019 ⁸
		Enforce the adopted ELVs by monitoring discharges from municipal wastewater treatment plants into the environment <i>[Regional Plan Requirement]</i>	2015 or 2019 ⁸
	Solid Waste	Adopt preventive measures to minimize inputs of plastic in the marine environment ⁹ <i>[Regional Plan Requirement]</i>	2017
		Enforce measures to combat illegal dumping including littering on beaches and illegal sewage disposal in coastal zones and rivers <i>[Regional Plan Requirement]</i>	2020
Air Pollution	Improve processes for inspection and maintenance of vehicles and renovation of the oldest vehicles <i>[SAP- MED Requirement]</i>	Not specified ¹	
Industrial Development	POPs, Heavy Metals (Hg, Cd, Pb), Organometallic Compounds	Prohibit and/or take legal and administrative measures necessary to eliminate the production and use, import and export of POPs and their wastes <i>[Regional Plan Requirement]</i>	Deadline passed ⁶
		Prohibit the installation of new Chlor alkali plants using mercury cells and vinyl chloride monomer production plants using mercury as a catalyst <i>[Regional Plan Requirement]</i>	Deadline passed ⁶
		Adopt National ELVs for mercury emissions based on values included in the “regional plan on the reduction of inputs of mercury” from other than Chlor Alkali industry ¹⁰ <i>[Regional Plan Requirement]</i>	2019
		Cease releases of mercury from the activity of Chlor alkali plants <i>[Regional Plan Requirement]</i>	2020

⁸ Depending on national circumstances and respective capacities.

⁹ Measures may include “Extended Producer Responsibility”, “Sustainable Procurement Policies”, “Voluntary Agreements with Retailers and Supermarkets”, fiscal and economic instruments”, establishment of [mandatory] deposits, return and restoration systems, and establishment of procedures and manufacturing methodologies.

¹⁰ Chemical industries using mercury catalysts, batteries industry, non-ferrous metal industry, waste treatment, incineration plants.

Sector Substance	Legal Requirements of the Regional Plans in the framework of the SAP- MED (<i>continued</i>)	Deadline
Monitoring and Inspection	Establish a monitoring programme of the inputs of priority pollutants identified in the SAP- MED and of the quality of the marine environment [<i>SAP- MED Requirement</i>]	Deadline passed ⁶
	Establish systems of inspection to ensure compliance with conditions laid down in the authorizations and regulations [<i>SAP- MED Requirement</i>]	Deadline passed ⁶
	Establish a permanent river water quality/quantity register [<i>SAP- MED Requirement</i>]	Deadline passed ⁶
	Monitor releases of mercury into water, air and soil in order to verify compliance with the requirements [<i>Regional Plan Requirement</i>]	2015
	Monitor discharges from municipal wastewater treatment plants and take necessary measures to enforce national regulations [<i>Regional Plan Requirement</i>]	2015 or 2019 ⁸
	Monitor bathing water quality ¹¹ [<i>Regional Plan Requirement</i>]	2016
	Design National Monitoring Programme on Marine Litter [<i>Regional Plan Requirement</i>]	2017
Public Participation	Provide to the public access to information available on the state of the environment of the Mediterranean and its evolution, and of the measures taken to improve it [<i>SAP- MED Requirement</i>]	Not specified ¹
Reporting	Collect information on the state of treatment and disposal of liquid and solid wastes [<i>SAP- MED Requirement</i>]	Not specified ¹
	Prepare bathing water profiles or beach profiles ¹² [<i>Regional Plan Requirement</i>]	2016
	Establish Regional Data Bank on Marine Litter [<i>Regional Plan Requirement</i>]	2016
	Publish a report on the State and Evolution of the Mediterranean Environment [<i>SAP- MED Requirement</i>]	On regular intervals
	Report on the implementation of the measures on the reduction of BOD5 from urban waste water and on their effectiveness [<i>Regional Plan Requirement</i>]	On a biannual basis
	Report on the implementation of the National Marine Litter Monitoring Programme [<i>Regional Plan Requirement</i>]	On a biannual basis

¹¹ Classify findings as “excellent”, “good”, “sufficient” or “poor quality”, with each classification linked to bacteriological quality.

¹² Profiles consist of information about physical, geographical and hydrological characteristics of a bathing water and use to assess sources of pollution, dispersion routes, risks of contamination and negative impacts in order to implement appropriate mitigation measures.

Sector Substance		Pollution Reduction Measures under the Regional Plans in the framework of the SAP- MED and ECAP	Deadline
Urban Environment	Municipal Wastewater Treatment	Coastal cities and urban agglomerations of more than 100,000 inhabitants are connected to a sewer system <i>[SAP- MED Requirement]</i>	Deadline passed ⁶
		Ensure that all agglomerations of more than 2000 inhabitants collect and treat their urban wastewater before discharging them into the environment ¹³ <i>[Regional Plan Requirement]</i>	2015 or 2019 ⁸
		Take necessary measures to establish adequate urban sewer and wastewater treatment plants that prevent run-off and riverine inputs of litter <i>[Regional Plan Requirement]</i>	2020
	Solid Waste	Establish environmentally suitable and economically feasible systems of collection and disposal of urban solid waste in cities of more than 100,000 inhabitants <i>[SAP- MED Requirement]</i>	Deadline passed ⁶
		Implement programmes on regular removal and sound disposal of accumulations/hotspots of marine litter <i>[Regional Plan Requirement]</i>	2019
		Implement adequate waste reducing/reusing/ recycling measures in order to reduce the fraction of plastic packaging waste that goes to landfill or incineration without energy recovery <i>[Regional Plan Requirement]</i>	2019
		Close to the extent possible existing illegal solid waste dump sites <i>[Regional Plan Requirement]</i>	2020
	Air Pollution	Promote the introduction of buses using gaseous fuel or other alternative forms of energy instead of diesel oil <i>[SAP- MED Requirement]</i>	Not specified ¹
		Pursue increased regional and domestic natural gas development projects in order to substitute high sulfur fuel oil with natural gas and natural gas conversion for urban proximities <i>[SAP- MED Requirement]</i>	Not specified ¹
Industrial Development	POPs, Heavy Metals (Hg, Cd, Pb), Organometallic Compounds	Identify stock piles consisting of or containing POPs <i>[Regional Plan Requirement]</i>	Deadline passed ⁶
		Phase out inputs of the 9 pesticides and PCBs and reduce inputs of unwanted contaminants: hexachlorobenzene, dioxins and furans <i>[Regional Plan Requirement]</i>	Deadline passed ⁶
		Phase out to the fullest possible extent discharges, emissions and losses of organomercuric compounds and reduce those of organolead and organotin compounds <i>[SAP- MED Requirement]</i>	Deadline passed ⁶
		Identify existing sites which have been historically contaminated with mercury <i>[Regional Plan Requirement]</i>	Deadline passed ⁶
		Apply environmentally sound management measures to sites which have been historically contaminated with mercury <i>[Regional Plan Requirement]</i>	2015

¹³ Secondary treatment shall be applied for discharges from urban wastewater treatment plants. Primary treatment shall be applied for discharges from marine outfalls.

Sector Substance	Pollution Reduction Measures of the Regional Plans in the framework of the SAP- MED and ECAP(<i>continued</i>)	Deadline
Industrial Development (<i>continued</i>)	Achieve environmentally sound management of metallic mercury from the decommissioned plants <i>[Regional Plan Requirement]</i>	To be achieved following decommission
	Progressively reduce total releases of mercury (to air, water and to products) from existing Chlor alkali plants until their final cessation <i>[Regional Plan Requirement]</i>	2020
	Take appropriate measures to isolate and contain mercury containing wastes <i>[Regional Plan Requirement]</i>	2025
	Phase out inputs of PAHs <i>[SAP- MED Requirement]</i>	2025
	Phase out discharges and emissions and losses of mercury, cadmium and lead <i>[SAP- MED Requirement]</i>	2025
	Eliminate to the fullest possible extent pollution of the Mediterranean Sea caused by discharges, emissions and losses of zinc, copper and chrome <i>[SAP- MED Requirement]</i>	2025
	Eliminate to the fullest possible extent pollution caused by discharges, emissions and losses of organohalogen compounds <i>[SAP- MED Requirement]</i>	2025
	Eliminate to the fullest possible extent inputs of radioactive substances <i>[SAP- MED Requirement]</i>	2025
	Reduce nutrient inputs, from agriculture and aquaculture practices into areas where these inputs are likely to cause pollution <i>[SAP- MED Requirement]</i>	2025
	Dispose all wastewater from industrial installations which are sources of BOD, nutrients and suspended solids <i>[SAP- MED Requirement]</i>	2025
Dispose all hazardous wastes in a safe and environmentally sound manner <i>[SAP- MED Requirement]</i>	2025	

¹⁴ Other heavy metals include Zinc, Copper, chromium.

¹⁵ Halogenated aliphatic and aromatic hydrocarbons, Chlorinated phenolic compounds and organo-halogenated pesticides.

¹⁶ These include industrial wastewater and agriculture.

¹⁷ These include obsolete chemicals, lubeoil and batteries.

Sector Substance	Pollution Reduction Measures of the Regional Plans in the framework of the SAP- MED and ECAP (<i>continued</i>)	Deadline
Physical Alterations and Destruction of Habitats	Restore marine and coastal habitats that have been adversely affected by anthropogenic activities <i>[SAP- MED Requirement]</i>	Not specified ¹
	Remove existing accumulated litter from Specially Protected Areas of Mediterranean Importance (SPAMI) and litter impacting endangered species ¹⁸ <i>[Regional Plan Requirement]</i>	2019
Public Participation	Explore and implement National Marine Litter Cleanup Campaigns; participate in International Coastal Cleanup Campaigns and Programmes; apply “Adopt-a-Beach” or similar practices; and apply “Fishing for Litter” practices <i>[Regional Plan Requirement]</i>	2019

¹⁸ Endangered species listed in Annexes II and III of the SPA and Biodiversity Protocol.

APPENDIX B. Guidelines on National Budget of Pollutants (NBB)

Table of Contents

1.	INTRODUCTION.....	2
2.	OBJECT AND SCOPE OF THE NBB UPDATED GUIDELINES.....	2
3.	NBB CALCULATION	3
3.1.	DETERMINING THE ADMINISTRATIVE REGION/S	4
3.2.	MAPPING THE EMISSION SOURCES WITHIN THE BASIN.....	5
3.3.	PREPARING THE NBB DATABASE.....	5
3.3.1.	<i>Industrial activities</i>	5
3.3.2.	<i>Atmospheric emissions from transport</i>	8
3.3.3.	<i>Information concerning streams flowing into the Mediterranean</i>	8
3.3.4.	<i>Information concerning unregulated landfills</i>	8
3.3.5.	<i>Information concerning domestic wastewater discharge</i>	9
3.4.	ESTIMATING AIR POLLUTANTS THAT ARE DEPOSITED INTO THE MEDITERRANEAN	9
3.5.	CONSOLIDATING THE NBB DATABASE	10
4.	MED POL INFO SYSTEM.....	11
4.1.	INTRODUCTION	11
4.2.	SYSTEM OVERVIEW	11
4.3.	USER PROFILES AND ROLES	12
4.4.	NBB DATABASE DESCRIPTION	13
4.5.	REPORTING DATA FLOW.....	15
4.5.1.	<i>H2020 indicators</i>	17
4.6.	GUI – SYSTEM FUNCTIONALITIES/MODULES	17
4.6.1.	<i>Import process design</i>	17
5.	NBB AND E-PRTR HARMONIZATION	19
6.	REFERENCES.....	21

1. Introduction

In the framework of the operational strategy for the implementation of the Strategic Action Programme (SAP-MED), adopted by the 12th Meeting of the Contracting Parties to the Barcelona Convention (Monaco, November 2001), the Mediterranean countries should prepare a National Budget (NBB) of emissions/releases for the SAP-MED targeted pollutants covering all the substantial Land Based Sources. The assessment of pollutants' loads constitute an important tool for both identifying and prioritizing issues to be addressed in the NAPs and evaluating the level of achievement of SAP MED targets through the implementation of the NAPs. In this context, the Countries prepared their first NBB in 2003 followed by the second in 2008 based on 2003 agreed NBB guidelines.

In view of NAP update as mandated by COP 18, Istanbul Turkey, 2013, the Secretariat developed the Guidelines for updating NAPs that comprised a number of technical annexes including one annex containing the updated NBB guidelines.

The updated NBB guidelines presented in this Appendix B take into account comments made during the meetings of MED POL FP in March and December 2014 including proposals to ensure the NBB harmonisation with PRTR. The guidelines contain four principal sections addressing:

- a) NBB object and scope
- b) NBB calculation
- c) NBB InfoSystem
- d) NBB and PRTR harmonization

2. Object and scope of the NBB updated guidelines

These guidelines have been prepared in order to assist the countries in the estimation of Baseline Budget (NBB) for the SAP MED targeted pollutants. They are designed to be applicable to all countries.

They include the methodological principles for the gathering of data and information concerning the loads of pollutants discharged in the Mediterranean by land based sources in case no monitoring of inputs in the marine environment is in place. It also includes a detailed description of the steps that should be followed for the calculation of the total loads discharged by the various land based sources of pollution, either from PRTR data or discharge permits or on the basis of Emission Factors.

The scope of the loads of pollutants is:

- Liquid loads discharge by industrial activities, municipal wastewater, effluents from wastewater treatment plants, leachates from landfills, pollution loads from coastal streams and runoff.
- Atmospheric emissions – point source emissions and major area sources.

As for sector categories and pollutants, SAP MED covers the following categories of substances based on Annex I.C of the LBS Protocol and selected as priorities. They both cover urban environment and industrial development, radioactive substances and hazardous waste have been removed for not being within NBB scope:

Table 1. SAP MED sectors, categories and substances.

Sector	Category	Substances
Urban environment	Municipal wastewater Municipal solid waste Air pollutants	
Industrial development	Toxic, Persistent and Liable to Bioaccumulate (TPB)	Aldrine DDT Dieldrine Endrine Chlordane Heptachlor Mirex Toxaphene Hexachlorobenzene PCB/PCT PCDD/PCDF PAH Mercury Cadmium Lead Organometallic compounds
	Other heavy metals	Zinc Copper Chrome
	Organohalogen compounds	Chlorinated solvents Chlorinated paraffins Chlorobenzenes Polychlorinated naphthalenes (PCNs) Polybrominated diphenyl ethers and polybrominated biphenyls Chlorophenols Lindane Chlorophenoxy acids
	Nutrients and suspended solids	BOD ₅ Nutrients Suspended solids

As a minimum, NBB should cover all the pollutants evaluated as priority substances agreed by MEDPOL Focal points at their meeting held in Aix en Provence, France in November 2009 and listed in Annex II of Decision IG.21/3. Currently, this list is in the update process.

Sector categories (30) are established in Annex I.A of the LBS Protocol. Thus a number of subsectors (up to 97) are defined for each sector.

3. NBB calculation

The approach to 2013 NBB includes the following primary stages:

1. Determine the areas from which liquid and air emissions may reach the Mediterranean.
2. Map all emission sources in the area of interest.
3. Gather emission data for all emissions sources.
4. Assess the portion of total emissions that eventually reach the Mediterranean.
5. Consolidate data and avoid redundancy where duplicates occur.

3.1. Determining the administrative region/s

The first step for estimating the NBB is to identify the administrative region/s in which the land-based sources of pollution affecting the Mediterranean Sea are located, that is, the identification of the administrative region/s that best fits the basin area. This should be done for liquid and air emissions separately.

(a) Basin Area for liquid emissions

In this area, liquid emissions discharged by various sources have the potential to eventually be deposited in the Mediterranean, either by direct disposal of wastewater into the sea, or indirectly by runoff and wastewater disposal in streams reaching the Mediterranean.

The main contributors of liquid emissions are industrial activities, urban sewage and wastewater, runoff, and agricultural activities.

The determination of the basin area will be made with respect to the following routes of marine of emission:

- Direct marine discharge by point sources.
- Discharge to coastal streams by point sources.
- Runoff (into coastal streams).
- Direct Runoff (to seawater).

The determination of the area of influence has to be made individually for every territory or region. Generally, the boundaries set by the drainage basin can be used to determine the area of influence. In case this basin is too vast, it can be divided into sub basins according to the geographical characteristics while considering the potential reduction in pollutant loads along the route (e.g. according to degradation, adsorption etc.).

As an alternative to assessing the total runoff pollutant loads, it can also be assumed that all runoff drain goes to stream channels. Based on this assumption, pollutant loads can be assessed by sampling the pollutant loads downstream prior to the intersection with the sea.

(b) Air Basin for Atmospheric Emissions

The determination of the area from which atmospheric emissions have the potential to be carried and deposited into the Mediterranean is based on climatic and geographical analysis for each basin. The air basin will be determined for every territory or region with respect to the following:

- Proximity to the Mediterranean coast.

- Characteristic wind regime (significant portion of time in which the wind blows with a seaward component).

3.2. Mapping the emission sources within the basin

Accurate information on liquid and atmospheric sources of pollution and related activities should be mapped within their suitable basin. The general categories of emission sources are:

- Industrial activities,
- Transportation sources,
- Stream heads,
- Waste water treatment plants,
- Landfill runoffs,
- Any other category.

Once sources of pollution are determined, they should be classified according to the corresponding sector (Annex I.A of the LBS Protocol) and subsector.

3.3. Preparing the NBB database

After identifying all emission sources in the basin, a database containing emission data from all sources has to be established. Accurate, local data should be preferred wherever possible. After the available information was examined and verified, information gaps should be identified and completed if possible.

The following are the principle data sets required for a complete estimation of all pollutant loads reaching the Mediterranean Sea:

- Information concerning all industrial activities in the relevant area – liquid and atmospheric emission loads.
- Information concerning atmospheric emissions from vehicles.
- Information concerning all streams that flow into the Mediterranean – specific pollutant loads/concentration, flow volume.
- Information concerning unregulated landfills - leachate loads, runoff, and pollutant permeation to groundwater bodies that are linked to the Mediterranean water.
- Information concerning domestic wastewater discharge – direct marine discharge, collection and treatment, and effluent quality in the WWTP outlet when disposed to streams/sea.

Recommended data sources for each category are described in the next sections:

3.3.1. Industrial activities

The recommended data sources are prioritized according to the following order of precedence:

(a) Using PRTR data

PRTR reported data constitutes a good database for liquid and atmospheric emissions which is based upon actual installation-level data on production, energy and resource consumption, emission reduction, etc. This data usually undergoes quality control and is generally the best source of overall emission estimation.

Concerning E-PRTR initiative in particular, Mediterranean countries are required to address some gaps in order to convert E-PRTR into NBB data. The following table shows main differences between NBB and E-PRTR approaches:

Table 2. Comparison between NBB and E-PRTR.

<i>Issue</i>	<i>NBB</i>	<i>E-PRTR</i>
Geographical scope	Administrative regions located in drainage basins that outflow into the Mediterranean.	All regions and river basin districts
Source type	Point sources (industry and urban centers).	Industrial facilities and diffuse sources ¹ .
Scope of point sources	All point sources irrespective of their capacity.	Only if the facility exceeds the following thresholds: a) falls under at least one of the 65 E-PRTR economic activities listed in Annex I of the E-PRTR Regulation and exceeds at least one of the E-PRTR capacity thresholds b) transfers waste off-site which exceed specific thresholds set out in Article 5 of the Regulation c) releases pollutants which exceed specific thresholds specified for each media - air, water and land - in Annex II of the E-PRTR Regulation
Media	Water and air	Amounts of pollutant releases to air, water and land as well as off-site transfers of waste and of pollutants in waste water
Emission scope	Direct emissions to drainage basins or into the sea.	Direct emissions and indirect emissions (going to an external treatment plant).
Sector categories	1) Sectors according to LBS Protocol 30 categories 2) Subsectors: 97 categories	1) Annex I of the E-PRTR Regulation: 9 sector categories 2) NACE Main Economic Activity 65 categories
Groups of pollutants	<ul style="list-style-type: none"> • Hydrocarbons • Metals and compounds • Nutrients, SS and BOD/TOC • Organohalogen • Other atmospheric pollutants 	<ul style="list-style-type: none"> • Greenhouse gases • Other gases • Heavy metals • Pesticides • Chlorinated organic substances • Other organic substances • Inorganic substances

¹ The E-PRTR Regulation (Article 8) requires the Commission, assisted by the European Environment Agency, to include in the E-PRTR information on releases from diffuse sources, where such information exists and has already been reported by Member States.

<i>Issue</i>	<i>NBB</i>	<i>E-PRTR</i>
	<ul style="list-style-type: none"> • Other inorganic compounds • Other organic compounds 	
Method of quantification	a) Measurement of the concentration levels of emissions at the source and quantification using additional data on the source activity. b) Estimation of emissions based on emission factors and industrial activity rates, material flow, etc.	a) Measured (M): Release data are based on measurements. Additional calculations are needed to convert the results of measurements into annual release data. b) Calculated (C): Release data are based on calculations using activity data (fuel used, production rate, etc.) and emission factors or mass balances. c) Estimated (E): Release data are based on non-standardized estimations.

To address such gaps and in view of NBB and E-PRTR harmonization, some conceptual and technical adjustments are proposed within these guidelines, which are described in section 5.

(b) Direct measurements

Where a PRTR program is not implemented or available PRTR data need to be complemented with additional sources/installations, the elementary database should be composed using the next best information source available, which is installation-specific data on direct measurements.

This calculation usually provides the most reliable and exact results, assuming that the equipment complies with common standards, is fit for use, calibrated for the correct emission rate, is suitable for the emission that is measured and if the sampling is performed at the proper frequency.

Direct measurement includes:

- Calculation of emissions into the air from sampling results:
 - *By creating an emission factor,*
 - *By activity hours.*
- Calculation of emissions into the air from continuous monitoring data.
- Calculation of releases and transfers to effluents from sampling data.

(c) Indirect monitoring

Indirect monitoring is based on a connection between the characteristics of the industrial process and the emissions.

This method may be applied in a process in which the emissions depend directly on the conditions of the process for which the measurement is performed. Releases and transfers to effluents from industrial processes are usually a function of process characteristics, such as temperature, pressure or acidity; and therefore constitute a candidate for calculating the quantity using indirect monitoring

data. In any case indirect monitoring is used to verify the connection between the monitored parameter and the emission.

(d) Discharge permits

If no reporting data from the industrial installation is available, the assessment of pollutant loads can be made according to the discharge loads approved in the permit.

(e) Emission factors

Industrial activities for which previous emission data/information are not available, pollutant loads can be evaluated using emission factors. Emission factors are numbers that may be multiplied by a rate of activity or rate of production of any installation (such as energy generation, water consumption, fuel consumption).

The UNEP/MAP report on industrial emission factors (UNEP/MAP, 2014b) includes a set of emission factors for liquid and atmospheric emission from the majority of industrial activities.

3.3.2. Atmospheric emissions from transport

Assessing the emission loads from transportation activities is typically complex and requires the use of modeling. Because of the inherent complexity of the models, previous analysis of the transportation sector is preferable. If no such analysis is available, calculation could be done using the overall fuel consumption and available emission factors as described in UNEP/MAP report on industrial emission factors (UNEP/MAP, 2014b).

3.3.3. Information concerning streams flowing into the Mediterranean

The coastal streams that flow into the Mediterranean act as an output for both area source emissions such as agricultural and urban runoff, and point source emissions such as industrial activities with direct discharge to the streams. The assessment of pollutant loads from these sources can be done by sampling as far downstream as possible, and multiplying the average pollutant concentration by the average flow volume. In order to avoid redundancy, data from stream sampling and point source emissions should be prioritized (see section 3.5 for database consolidation).

3.3.4. Information concerning unregulated landfills

Unregulated landfills are a source of leachate, polluted runoff, and possible groundwater pollution that can potentially reach the Mediterranean. Additionally, landfills in close proximity to the coast can be a source of solid waste washing to the sea. Site specific evaluation of the landfill infrastructure should be done in order to assess the pollution loads.

3.3.5. Information concerning domestic wastewater discharge

Information should be gathered concerning the amounts of domestic wastewater directly discharged to the Mediterranean and to the coastal streams. Pollutant concentration and flow volumes should be monitored and assessed for the determination of the final loads of pollutants discharged to the Mediterranean.

3.4. Estimating air pollutants that are deposited into the Mediterranean

The assessment of the liquid loads deposited into the Mediterranean from most land based sources is usually derived directly from the discharged loads.

Nevertheless, air pollutants released to the atmosphere by various sources will only be partly deposited into the Mediterranean. Air pollution facilitates a major source of seawater pollution (heavy metals, acids, etc.) and should be carefully assessed due to its inherently complex variety of mechanisms for marine deposition. The effect of air pollution on seawater quality arises from dry and wet deposition processes occurring naturally in the atmosphere. The mechanisms of deposition vary for different kinds of particles and gases. In order to take into account all the different types of pollutants and mechanisms of deposition, very complex models should be used. Since this information is complicated to acquire and some of it is still being researched, a simplified assessment should be carried out.

The basic assumption for the evaluation is that all substances carried towards the sea by wind will eventually reach the seawater. This assumption may be too strict, but it is simple to calculate and represents a good basic evaluation of the maximum, potential pollutant loads reaching the Mediterranean.

Under this basal assumption, the amount of pollutants deposited into the Mediterranean is mainly dependent on wind direction. Air pollution will be carried and deposited onto the sea surface only with an adequate wind component and sufficient wind speed depending on the location of the source. The evaluation is based on a sea/land factor which is multiplied by the pollutant load of all sources according to their location.

The determination of sea/land factors includes several steps:

- 1 Partitioning the air basin for atmospheric emissions into several zones. Each zone should contain wind data (wind rose) from a single source (e.g. meteorological station) or an area-wide average.
- 2 Determining a minimal wind speed for areas that are not adjacent to the coastline (around 1 m/s). Every fraction of the wind rose below the minimal wind speed will not be considered as wind blowing to the Mediterranean. This is mostly true for particles settling and not for gases, but will be used for the general evaluation.
- 3 Determining a sea/land factor for every zone according to the fraction of time the wind blows towards the Mediterranean at a minimal speed. (e.g. if the wind blows towards the sea for half of the year, then only half of the atmospheric emissions from that zone will be deposited into the Mediterranean).
- 4 Allocating a sea/land factor to every emission source according to the zones defined in step 1 or according to the closest wind data source. This can be done easily using a GIS software.
- 5 Multiplying all emission loads by their allocated sea/land factor.

3.5. Consolidating the NBB database

After all available data has been collected, it has to be summarized to obtain the final pollutant loads. The following flow-chart (Figure 1) schematically illustrated the process of data processing and classification required to achieve a comprehensive assessment of the pollutant loads discharged into the Mediterranean. Orange boxes indicate the data processing activities, and the green boxes indicate the classification criteria's of the source categories.

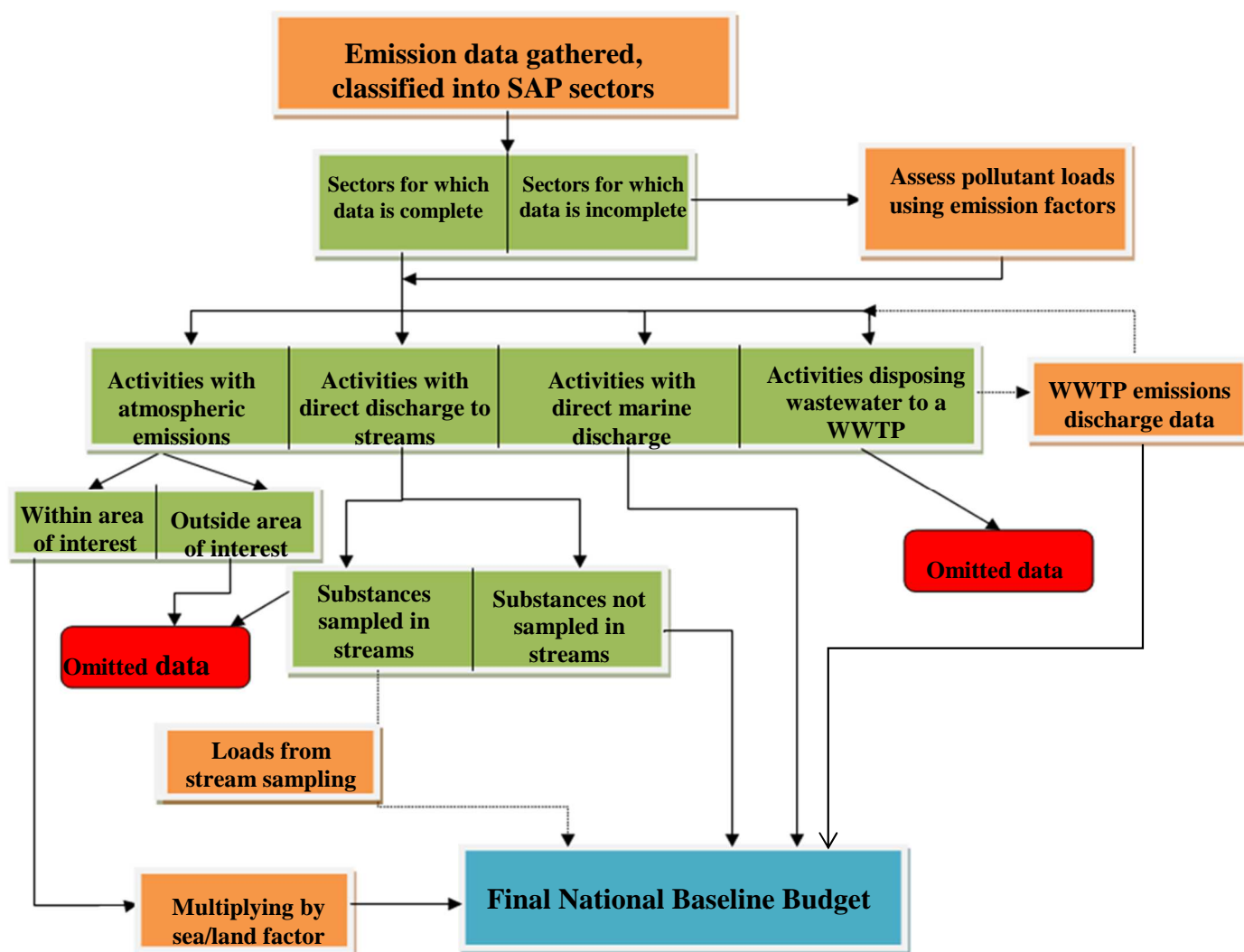

Figure 1: Flow chart of data processing and classification for the assessment of the pollutant loads discharged into the Mediterranean.

4. MED POL Info System on NBB

4.1. Introduction

In this section, the system design of the NBB-Info System, in the following the “system”, is briefly described. The “NBB Info System” is a networked information system that is intended to provide an overall support to NBB reporting and related assessment. The system provides tools for managing, sharing and preserving data and information for MEDPOL users and partners.

4.2. System overview

Interaction between the system and users can be described by functionality blocks, where implemented technologies are interconnected basing the focus on the logical functionalities they refer to. The logical view of the system is described in Figure 2.

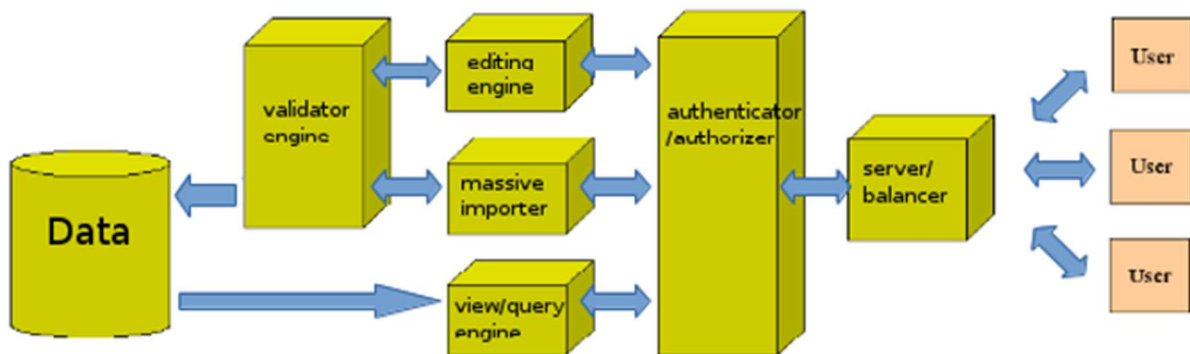

Figure 2: Logical architecture of NBB IS.

The system main components are:

- a storage layer, which manages data semantics, storage and retrieval;
- an application server and GIS layer;
- a dedicated MED POL Web application.

The system components are displayed in Figure 3.

Figure 3: NBB Info system Intranet architecture diagram.

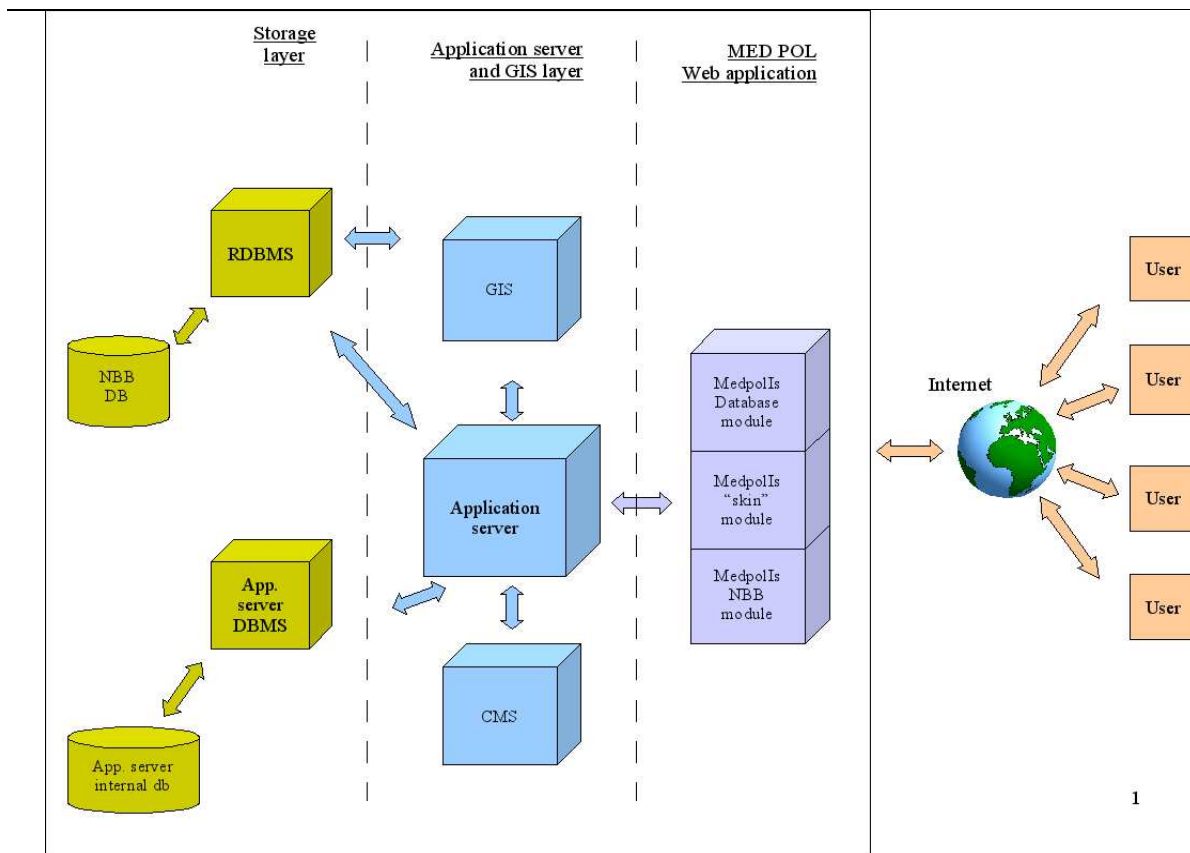

4.3. User profiles and roles

Each user of MED POL Info system is given a definite role, which defines the amount of information/data and the kind of actions they are allowed to access. Role permissions can be modified as needed.

The user profiles are:

- System administrator: Unrestricted user management; user and data management; report creation;
- Data Definer: Unrestricted data access, editing, management, querying and distribution; some report management;
- Data Provider: data access, editing and querying restricted to user's own country data;
- Data validator: data access and querying restricted to the user's own country data; some report management;
- Anonymous: Data access and querying restricted to public data.

Any user will be given a user name and a password.

System administrator and Data Definer are reserved to MED POL members.

Data Provider is reserved to each specific country user to manage drafts of new data and searching/analysing of submitted data.

Data Validator is reserved to the National Focal Point for each country; this profile is responsible of official submission of new data.

Anonymous is the profile reserved for not logged users.

4.4. NBB Database description

NBB data are stored into the NBB database. The structure of NBB database is shown in **¡Error! No se encuentra el origen de la referencia..**

The Database has several users access points, according to the different roles in the data reporting. The main entities corresponding to the different data types which can be managed by the database are:

- reports (table report),
- facilities (table company),
- value of the pollutant (table budge baseline).

The hierarchical structure is the following:

The report is the envelope which encases all the data of a single country. It contains several measures of pollutants, organized in the region where the measures has been performed. Each measure can be associated to a facility

Among the attributes of a specific measure, there are:

- pollutant (table pollutant),
- unit of measure (table unit),
- the hierarchical tern sector- subsector-process (tables sector, sub sector, process),
- the region (table region).

The geographical features of the NBB is at moment limited to the geometry of the region, which is included in the system in order to provide geographical queries (in the upload of PRTR values, the system performs a determination of the region from the geo coordinates of the PRTR facility).

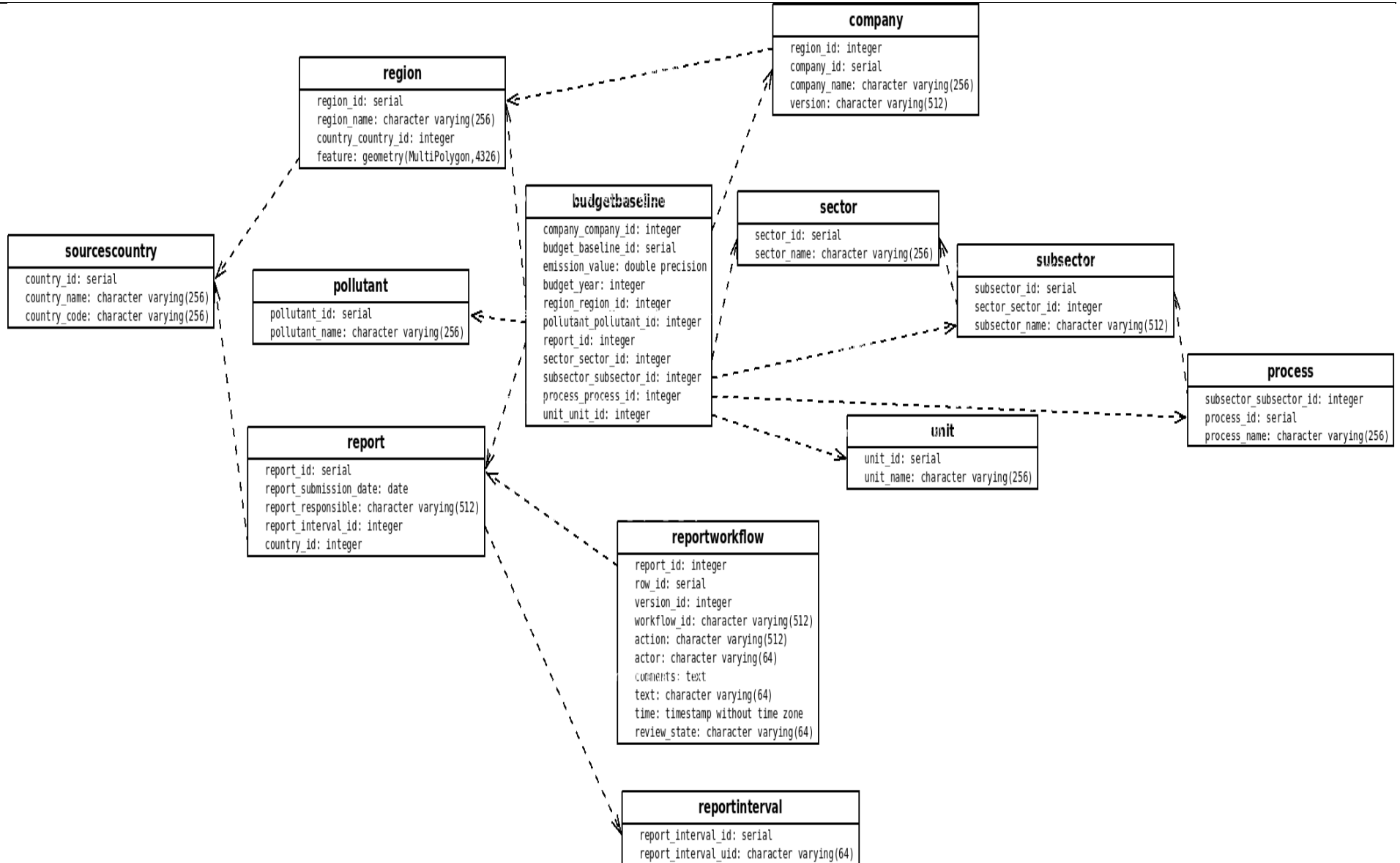

4.5. Reporting data flow

The reporting activity is the main target of the NBB Info System. The data flow is sketched in Figure 4. It is organized in the following main activities:

- initial creation of an empty report in a draft state by the MED POL staff/Data Validator (National Focal Point),
- entry of the facilities by the Data Provider,
- filling and editing of the report and change of state to official submission (performed by Data Provider and Data Validator). It is implemented an intermediate final state for the report in order to facilitate the management of the report among the Data Provider and Data Validator. Once the Data Provider has completed the data entry in the draft state, he can change the state of the report from draft to final. In this state the report is managed only by the Data Validator (usually the National Focal Point) in charge for the validation of the data entered. If the Data Validator needs to change/modify the data and needs the
- support from the Data Provider can revert the state of the report to Draft too allow the Data Provider to access to the Report and starting a new session of data entry,
- Report workflow managing which include 4 states (draft, final, officially submitted and archived) and allows to manage the data flow among Data Provider, Data Validator and Data Definer/MED POL staff.
- Data validated are always stored into the database, but at the same time linked to the corresponding report (which contains them from a logical point of view) and to its state.
- The sections of query and statistical analysis, available in specific sections of the system, refer always to the data stored into the database and belonging to the report officially submitted and archived.

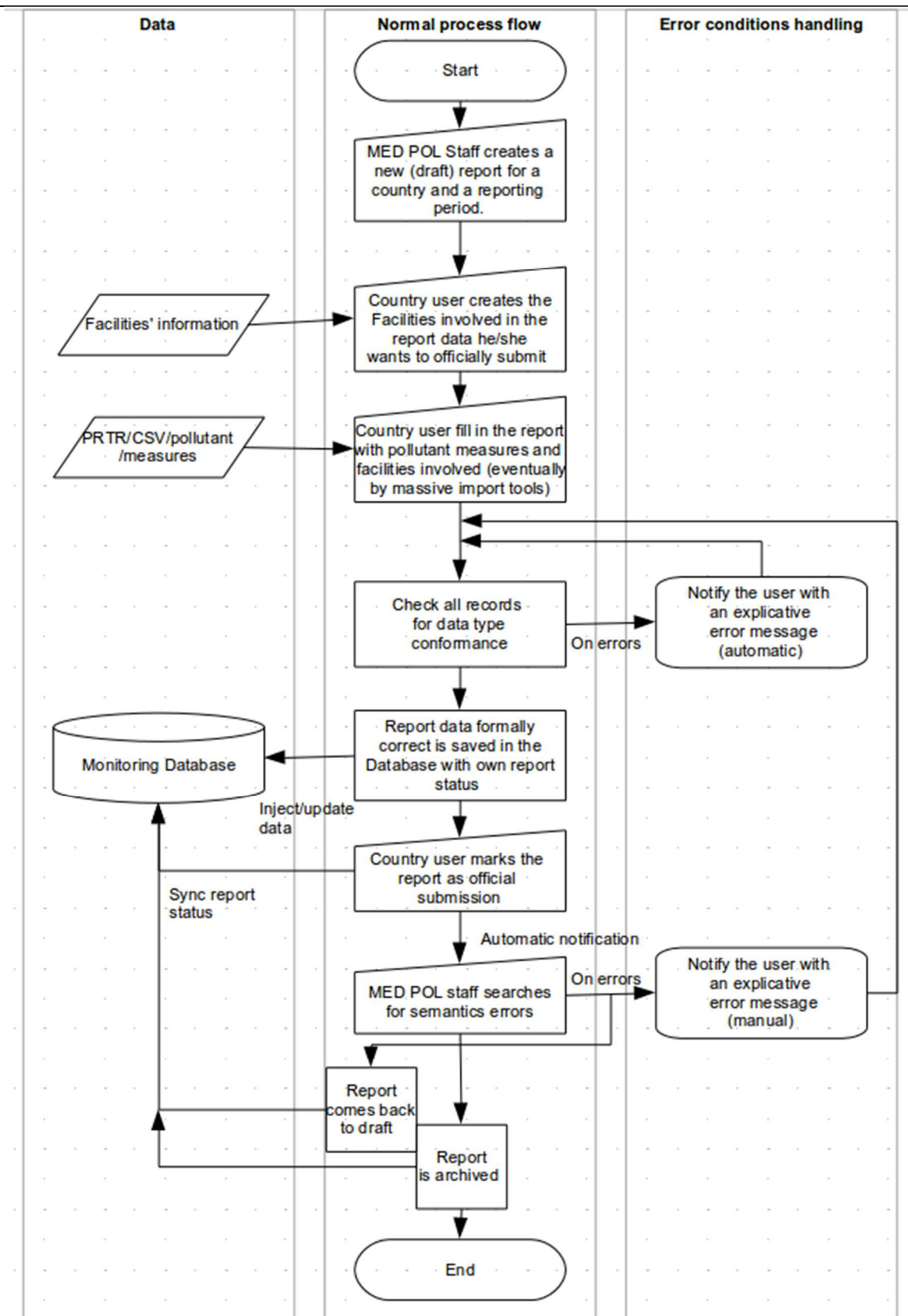

Figure 4: Data flow in the NBB IS Intranet.

4.5.1. H2020 indicators

H2020 indicators are visualized in the public section of the system. The public section has the same structure of the other sections, but it can be accessed by the anonymous users without password. H2020 indicators are organised in national folders and data can be downloaded as csv files.

The public section will include the link to the EEA webpage with the H2020 indicators. Similarly, the EEA webpage will host a link to the corresponding public page of the MED POL Info System.

4.6. GUI – System Functionalities/Modules

“NBB-IS System” GUI is designed to give quick access to most of the system functionalities and modules. Figure 6 shows a schematic illustration of the GUI typical areas (the figure refers to the Sources Data page).

Area 1 contains links to the system main sections ('navigation tabs') and the path to the current position inside the system. Area 2 is the system header, the same all over the system. Area 3 is the system 'navigation box', that is the main tool to move through the web pages of the system. Area 4 represents the content area of the current page: its content depends of the context. At last, area 5 displays personal user information/links, if login procedure was done, else the link to the login page.

4.6.1. Import process design

(a) Importing from PRTR XML file

The system accounts for the data upload from the MED POL PRTR and EPRTR XML files.

However, since the two systems are quite different and not fully interoperable, the implementation is still on-going. The system upload a subset of PRTR data which can be fitted in the data specifications of the NBB. In order to allow the upload of the data, we are performing a mapping between the data dictionaries of the system, which is still in the process.

Mapping has been performed for:

- Sectors,
- subset of subsectors,
- subset of pollutants.



Figure 5: GUI of the NBB-IS Intranet: main elements.

5. NBB and E-PRTR harmonization

The conceptual and technical adjustments for harmonization between NBB and E-PRTR are summarized as follows:

1. To select/filter only regions and river basin districts located in drainage basins that outflow into the Mediterranean.
2. To omit records regarding indirect emissions (going to an external treatment plant).
3. To compare the sector and subsectors dictionaries under NBB and under PRTR in order to identify the corresponding loads source categories and to identify not fully matching sectors/subsectors or sectors/subsectors under NBB which are not included under PRTR. Consequently:
 - dictionary entries not corresponding to any coded item in any list should be left in the NBB dictionaries;
 - the sector dictionaries are the union of the PRTR and NBB sector dictionaries;
 - for a specific sector the subsectors dictionaries are the union of the PRTR and NBB subsectors dictionaries;
4. To gather all emission data from industrial facilities regardless of specific capacity thresholds set by Annex I of E-PRTR Regulation or, alternatively, ensure that data collected are representative of the total discharges from such sector/subsector at national level, i.e.:
 - For NBB reporting purposes, it is recommended neither to adopt E-PRTR capacity thresholds nor to set national capacity thresholds.
 - If national capacity thresholds are set, to ensure that emissions gathered from each industrial sector/subsector in the country are representative of the total sector/subsector emissions in the country, i.e. they are at least 80% of the total emissions per sector/subsector. It is then up to each country to set such national capacity thresholds.
5. To compare the pollutant dictionaries under NBB and under PRTR in order to identify the corresponding loads of pollutants and to identify not matching pollutants.
 - dictionary entries not corresponding to any coded item in any list should be left in the NBB dictionaries;
 - the pollutant dictionaries in the NBB are the union of the PRTR and NBB pollutant dictionaries.
6. To gather all emission data from industrial facilities regardless of specific pollutant thresholds set by Annex II of E-PRTR Regulation or, alternatively, ensure that data collected are representative of the total discharges from such pollutants at national level, i.e.:
 - For NBB reporting purposes it is recommended neither to adopt E-PRTR pollutant thresholds nor to set national pollutant thresholds.
 - If national pollutant thresholds are set, to ensure that pollutant emissions gathered in the country are representative of the total pollutant emissions in the country, i.e. they are at least 80% of the total emissions per pollutant. It is then up to each country to set such specific pollutant thresholds.

7. In order to assure the coherency among NBB data and PRTR it is proposed to use in the NBB the same codification of the method of estimation of emissions used in the PRTR. For the sectors which do not allow the PRTR coding it is proposed to add a text field where the operator can draft the estimation method used.
8. The system should allow the prefilling of a new NBB report. This is thought to facilitate the reporting process for the following years since the operator will be able to readily check the values in the old report and update them in the new report, without retyping all from the beginning.
9. PRTR data can be massively uploaded from an XML into the database. However, since PRTR data provide only a portion of the NBB data, the solution envisaged is to allow 2 different types of prefilling:
 - prefilling of every data, using the old NBB data. In this case the Data Provider can recover all the NBB data and then update them to create the new NBB report.
 - prefilling of the old PRTR data. In this case the Data Provider can recover only the PRTR portion of the NBB data and then update only the integration to the PRTR data in order to create the new NBB data.

Moreover, the system allows adding data with the same attributes (sector, subsector, pollutant, region etc.) and only at the submission will perform the aggregation. In such a way, it is possible to integrate (adding simply a new record) data upload corresponding to a partial load.

6. References

- [1] Description, requirements and technical design recommendations for the NBB IS are described in 'NBB Info System Draft Concept Paper', UNEP, Athens 2005.
- [2] 'National Baseline Budget for 2008', UNEP-MAP, Athens 22 August 2008.
- [3] 'Web based NBB reporting system specification requirements', UNEP(DEC)/MED WG.393/3, 4 march 2014.
- [4] The schema for the main MED POL database is described in 'Conceptual Design of the MED POL Phase III Database', UNEP(DEC)/MED WG.202/2 (revised), 9 April 2002.
- [5] Reporting formats for data import in the main MED POL database are described in the same document.
- [6] Data Policy is described in the document UNEP(DEC)/MED WG.316/6.
- [7] NBB System Design Document (draft)
- [8] NBB User Manual (draft)
- [9] UNEP/MAP, 2014a. Introduction to pollutant release and transfer register (PRTR) and guidelines for reporting (UNEP(DEPI)/MED WG.399/3).
- [10] UNEP/MAP, 2014b. Industrial emission factors. Updated version 2012. (UNEP(DEPI)/MED WG.393/Inf.5).
- [11] Guidelines for the Preparation of the Baseline Budget of Pollutants Releases for the Mediterranean Region. UNEP. Athens, 2003
- [12] Regulation (EC) No 166/2006 of the European Parliament and of the Council of 18 January 2006 concerning the establishment of a European Pollutant Release and Transfer Register and amending Council Directives 91/689/EEC and 96/61/EC. European Union, 2006
- [13] The Ministry for Environmental protection, 2012. Instructions for determining optimum method for calculating releases and transfers to the environment - Primary instructions. In accordance with the provisions of Section 6(B) PROTECTION OF THE ENVIRONMENT (ENVIRONMENTAL EMISSIONS AND TRANSFERS– REPORTING AND REGISTRATION REQUIREMENTS) LAW, -2012. Israeli PRTR Release Estimation Techniques, 2012.

Appendix C. Updated criteria and methodology to assess hotspots and sensitive areas in the Mediterranean

Table of contents

1.	INTRODUCTION	3
2.	UPDATED CRITERIA AND METHODOLOGY TO ASSESS HOT SPOTS AND SENSITIVE AREAS IN THE MEDITERRANEAN	4
2.1.	STEP 1: SCREENING FOR THE LISTING OF POTENTIAL POLLUTION HOT SPOTS AND SENSITIVE AREAS ..	4
2.2.	STEP 2: ASSESSING POTENTIAL HOT SPOTS AND SENSITIVE AREAS BASED ON UPDATED CRITERIA	5
2.2.1.	<i>Categorization for hotspots and sensitive areas.....</i>	<i>5</i>
2.2.2.	<i>Criteria for evaluation of hot spots/sensitive areas.....</i>	<i>6</i>
3.	GUIDANCE ON THE IMPLEMENTATION OF EVALUATION CRITERIA AND TEST EXAMPLE.....	18
3.1.	SCREENING/COMPILATION OF A LIST OF POTENTIAL HOT SPOTS	18
3.2.	ASSIGNING THE CATEGORY SCORES FOR EACH SITE	18
4.	REFERENCES.....	21

Index of tables

<i>Table 1. Screening criteria proposed for establishing a list of potential hot spots sites.</i>	4
<i>Table 2. Categories, multipliers and scores.</i>	7
<i>Table 3. Ranking criteria for population category.</i>	8
<i>Table 4. Ranking criteria for wastewater collection and treatment category.</i>	9
<i>Table 5. Ranking criteria for drinking water quality category.</i>	10
<i>Table 6. Ranking criteria for bathing water quality category.</i>	11
<i>Table 7. Ranking criteria for Organic Matter category.</i>	12
<i>Table 8. Ranking criteria for nutrients and biological status category.</i>	12
<i>Table 9. Ranking criteria for Contaminants category.</i>	14
<i>Table 10. Ranking criteria for Marine Litter category.</i>	15
<i>Table 11. Ranking criteria for recreation and ecosystem services category.</i>	16
<i>Table 15. Ranking criteria for transboundary effects category.</i>	17

1. Introduction

The 18th meeting of the Contracting parties to the Barcelona Convention (COP 18), held in Istanbul, Turkey in December 2013, requested the Contracting parties to update the National Action Plans adopted between 2003-2005 in the framework of Article 5 of the LBS Protocol of the Barcelona Convention. With the view to support countries in following a harmonized methodology to update the NAPs, the Secretariat developed NAP update Guidelines.

The meeting of the MEDPOL FP held on 26-28 March 2014 (Athens, Greece) reviewed and endorsed the main body of the Guidelines for Updating National Action Plans (NAPs): “Guidelines for updating National Action Plans for the implementation of the LBS Protocol and its Regional Plans in the framework of SAP MED to achieve Good Environmental Status for pollution-related ECAP ecological objectives” (UNEP(DEPI)MED WG.394/10). The Secretariat was asked to particularly continue the work for finalization of the technical annexes of NAP update Guidelines including one annex on the updated criteria on hotspots and sensitive areas assessment.

The main purpose of updating the criteria for the evaluation of national hotspots and sensitive areas is to address additional developments and updated legal and technical standards to meet ECAP GES targets and the legally binding commitments under the Regional Plans (Article 15 of the LBS Protocol). The preparation of updated criteria took into account comments received from Israel, France and UfM Secretariat and benefited from experiences of other international frameworks on hotspots identification and assessment such as World Bank (WB), Union for the Mediterranean (UfM) and Regional Seas Conventions and Action Plans (RSC).

The meeting of MED POL FP held on 18 – 19 December 2014 in Barcelona reviewed and endorsed the criteria as presented in sections 2 and 3 of this Annex 4, Appendix C.

2. Updated criteria and methodology to assess hot spots and sensitive areas in the Mediterranean

The main purpose of updating hot spot and sensitive area assessment criteria is to take into account the GES targets adopted by COP 18 as well as the commitments under the Regional Plans of the LBS Protocol adopted by COP 17, 18 and 19. This ensures a better balance among health, environmental and socio economic aspects as well as pressures and related state/impact on marine and coastal environment.

The Contracting Parties may build on comparable processes including pressures and impact analysis and environmental status assessment. In other cases, the methodology for evaluation of the hot spots and sensitive areas in the Mediterranean region based on updated assessment criteria comprises the two following main steps:

- Step 1: Screening for the listing of potential pollution hot spots and sensitive areas.
- Step 2: Assessing potential hot spots and sensitive areas based on updated criteria.

2.1. STEP 1: Screening for the listing of potential pollution hot spots and sensitive areas

An initial list of potential hot spots needs to be prepared to be evaluated with the proposed criteria in section 2.2. Table 1 describes general criteria for the sites which should be included in the potential list of hot spots. A nation-wide list of sites has to be assembled for each screening criteria, leading to a final list in which all sites answer the description of at least one of the screening criteria. The list will be based on:

- a) Knowledge of the emission loads, ambient pollutant concentrations, emission trends, development programs, etc.
- b) Where pollution data is missing, the list will also include sites for which there is a reason to assume some type of unmonitored environmental pressure is present.

Table 1. Screening criteria proposed for establishing a list of potential hot spots sites.

Criteria	Description	Environmental Pressures
Densely populated areas	Large population centres, popular touristic areas or densely populated coastal areas without adequate wastewater treatment (municipal pollution hot spot site)	Wastewater, organic matter, marine litter and solid waste
Coastal industry	Sites with large untreated wastewater outlets in the sea	Wastewater, contaminants, organic matter
Big ports	Intense maritime transport routes and ports	Wastewater, solid waste, contaminants, hazardous waste

Criteria	Description	Environmental Pressures
Landfills and dump sites	Non sanitary landfills and dump sites located in proximity of the coastline or at sea	Marine litter and solid waste, Contaminants
Oil/gas exploration and exploitation, and mining sites	Oil/gas exploration and explotations and mining activities in proximity of the coastline or at the sea	Contaminants
Big aquaculture areas	Areas with intensive fish and shellfish farming	Nutrients, pharmaceutical products
Large river discharges	Large river discharges, carrying along a) solid waste, b) urban wastewater, c) industrial wastewater, d) agricultural run-offs	Nutrients, solid waste, wastewaters
Intensive agriculture areas	Sea waters receiving substantial agricultural run-offs from the intensively cultivated coastal agriculture areas	Nutrients, contaminants
Historical pollution sites	Sites where pollution occurred in the past, but the risk to the environment is still present	Accumulated nutrients, contaminants, solid waste

Generally, in order to facilitate the work of the Countries in listing and screening potential pollution hot spots and sensitive areas, the use of the criteria defined in “Negligible Effects” for each of the subcategories is recommended as described in step 2 of the methodology.

With the view to address all pollution related hot spot including marine and land areas it is recommended to include also potential sea based sources in the list, e.g. oil offshore activities, ports.

2.2. STEP 2: Assessing potential hot spots and sensitive areas based on updated criteria

2.2.1. Categorization for hotspots and sensitive areas

In 2003 UNEP/MAP evaluation, all hot spots were grouped into five categories, according to the magnitude of impacts and pressures. The five categories A, B, C, D, and E covered a range from extreme (category A) to insignificant effect (category E).

The updated methodology sets only four categories: A, B, C and D based on the resulting score for the assessment of pressures and the state of the environment (impacts).

- Priority hot spot (A),
- Hot spot (B),

- Potential hot spot / sensitive area (C),
- No hotspot (D).

The latter category is for the purpose of assessing the cases where a hot spot is eliminated.

Hotspots Definition:

- Point sources** on the coast of the Mediterranean Sea which potentially **affect** human health, ecosystems, biodiversity, sustainability or economy in a significant manner. They are the **main points where high levels of pollution loads** originating from domestic or industrial sources are being **discharged**;
- Defined **coastal areas** where the **coastal marine environment is subject to pollution** from one or more point or diffused sources on the coast of the Mediterranean which potentially **affect** human health in a significant manner, ecosystems, biodiversity, sustainability or economy.

2.2.2. Criteria for evaluation of hot spots/sensitive areas

The criteria categories are built based on categories and criteria established in 2003. The major changes have been made regarding:

- the organisation of categories and criteria has been approached from four different points of view: public health, environmental status, economics and transboundary effects,
- the inclusion of specific criteria regarding GES,
- the inclusion of alternative sub criteria for each category,
- the multipliers for balancing the importance of categories.

Thus, the criteria categories for 2014 evaluation are:

PUBLIC HEALTH	ENVIRONMENTAL STATUS and PRESSURES	ECONOMICS	TRANSBOUNDARY EFFECTS
Population Wastewater treatment Drinking water quality Bathing water quality	Organic matter Nutrients and biological status Contaminants Marine litter	Economic activities (and ecosystem services underpinning them) Investment	Transboundary effects.

Rationale and description of particular adjustments made in 2014 with respect to 2003 for each category are described below:

(a) Public health

Public health category is composed of four subcategories: population, wastewater treatment, drinking water quality and bathing water quality. The category aims to measure the potential effect of hot spots on public health. In 2003, criteria on public health was based on discharges of BOD and hazardous substances, while drinking water quality was a separate category. In the updated methodology, the size of potential population affected and the characteristics/effectiveness of wastewater collection and treatment system are the main considered criteria, in line with WB methodology (WB, 2011).

Drinking water quality (a separate category in 2003) has been included, with some minor adjustments, as a subcategory of public health in the proposed updated methodology. Bathing water quality has been introduced as a new subcategory in proposed updated methodology, in line with Decision IG.20/9.

(b) Environmental Status and Pressures:

It contains four subcategories on organic matter (BOD), nutrients (P, N), contaminants and marine litter. Different alternatives have been developed to score each category: trends in discharges to the sea (pressure) or compliance with GES targets or other related thresholds.

In 2003 evaluation, indicators on substance discharges were not defined as categories but particularly considered to rank the effects on aquatic life (discharges reducing O₂ content, heavy metals and oil), recreation (oil) or other beneficial uses (solid waste).

(c) Economics

It assesses the effects of the potential hot spot on tourism, aquaculture/fisheries and other recreational activities as well as the level of investment needed to provide for environmentally sound solutions for potential hot spots. As seen from the description of the environmental status category, in 2003 recreation category was ranked based on the level of oil discharges. Particular sub criteria on tourism and aquaculture and fisheries have been introduced in proposed updated methodology in line with WB methodology.

(d) Trans-boundary effects

With regards to transboundary effects the methodology considers location of the pollution area, the nature of pollutants as well as the distance from the border.

Based on the above criteria, the following multipliers per category are presented in the following table.

Table 2. Categories, multipliers and scores.

Category	Multiplier	Score
Public health		
1) Population	4	1-4
2) Wastewater treatment	4	1-4
3) Drinking water quality	4	1-4
4) Bathing water quality	4	1-4
SCORE	<i>16-64</i>	
Environmental Status and Pressures		
5) Organic matter	3	1-4
6) Nutrients and biological status	3	1-4
7) Contaminants	3	1-4
8) Marine litter	3	1-4

Category	Multiplier	Score
<i>SCORE</i>	<i>12-48</i>	
Economics		
9) Economic activities and ecosystem services underpinning them	4	1-4
<i>SCORE</i>	<i>4-16</i>	
10) Transboundary effects	1	1-4
<i>SCORE</i>	<i>1-4</i>	

Each potential hot spot is expressed within the following categories: A, B, C or D according to the range where the calculated total score falls:

Category	Weighted Total
Priority hot spot (A)	132 – 107
Hot spot (B)	106 – 82
Potential hot spot / Sensitive area (C)	81 – 58
No hotspot (D)	57 - 33

The following sections explain the criteria for ranking the effects/risks in each category:

2.2.2.1. Criteria on “PUBLIC HEALTH”

- Criteria on **population** affected by the potential hot spot have been based on the size and distance. Only one of the alternatives (a) or (b) needs to be met for assigning the related score. If different alternatives and different scores are possible, the precautionary principle should be applied and the worst scenario chosen:

Table 3. Ranking criteria for population category.

POPULATION¹	
severe effects (4)	(a) Population size within a radius of 10 km is > 100,000 inhabitants.
moderate effects (3)	(a) Population size within a radius of 10 km is between 10,000 -100,000 inhabitants and/or
	(b) Population size is > 100,000 inhabitants within a radius of 20 km.
slight effects (2)	(a) Population size within a radius of 10 km is between 2,000 -10,000 inhabitants and/or
	(b) Population size is between 10,000 -100,000 inhabitants within a

¹ It is recommended to also consider population during tourist seasons.

POPULATION¹	
	radius of 20 km.
negligible effects (1)	(a) Population size within a radius of 10 km is < 2,000 inhabitants and/or (b) Population size is between 2,000 -10,000 inhabitants within a radius of 20 km.

2) Criteria on **wastewater treatment** have been based on the following definitions extracted from the Regional Plan on the reduction of BOD₅ from urban waste water in the framework of the implementation of Article 15 of the LBS Protocol (Decision IG 19/7):

- **Urban wastewater** means wastewater of the mixture of domestic waste water with industrial waste water pre-treated or not and/or run-off rain water;
- **Domestic wastewater** means wastewater from residential settlements and services which originates predominantly from the human metabolism and from household activities;
- **Collecting system** means a system of conduits which collects and conducts urban waste water;
- **Wastewater Treatment Plant WWTP** means systems used to treat urban wastewater using physical, chemical and /or biological techniques;
- **Agglomeration** means an area where the population of more than 2.000 inhabitants and/or economic activities are sufficiently concentrated for urban waste water to be collected and conducted to an urban waste water treatment plant or to a final discharge point;
- **Population-equivalent (p.e.)** means the organic biodegradable load having a five-day biochemical demand (BOD₅) of 60 g of oxygen per day;
- **Primary treatment** means treatment of urban waste water by a physical and/or chemical process involving settlement of suspended solids, or other processes in which the BOD₅ of the incoming waste water is reduced by at least 20% before discharge and the total suspended solids of the incoming waste water are reduced by at least 50%;
- **Secondary treatment** means treatment of urban wastewater by a process generally involving biological treatment with a secondary settlement or other process so that the treatment results in a minimum reduction of the initial load of 70-90% of BOD₅.

In addition, according to the World Bank Group², **tertiary treatment** is considered as any additional treatment beyond secondary. Tertiary treatment can remove more than 99 percent of all the impurities from sewage, producing an effluent of almost drinking-water quality. Disinfection, typically with chlorine, can be the final step before discharge of the effluent. However, there is some concern about chlorine residuals in the effluent.

The following tables describes the criteria for ranking the category, only one of the alternatives (a), (b) or (c) needs to be met for assigning the related score. If different alternatives and different scores are possible, the precautionary principle should be applied and the worst scenario chosen:

Table 4. Ranking criteria for wastewater collection and treatment category.

² <http://water.worldbank.org/shw-resource-guide/infrastructure/menu-technical-options/wastewater-treatment>

WASTEWATER COLLECTION AND TREATMENT The effects of wastewater collection and treatment on public health have:	
severe effects (4)	(a) Urban wastewater (agglomeration more than 10,000 PE) no collected or treated ³ or primary treated only. (b) Significant loads of industrial hazardous substances are discharged to municipal collecting system without treatment.
moderate effects (3)	(a) Urban wastewater (agglomerations more than 2,000 PE) no collected or treated ³ or primary treated only. The sewer network has big leakages and the wastewater treatment plant overflows frequently and/or. (b) Industrial loads of hazardous substances are discharged to municipal collecting system without treatment.
slight effects (2)	(a) Urban wastewater (agglomerations less than 2,000 PE) no collected or treated ³ or primary treated only. (b) Urban wastewater is collected and treated: I. biological (secondary) treatment for collected wastewater and/or II. the sewer network has small leakages and the wastewater treatment plant hardly overflows and/or (c) Insignificant industrial loads of hazardous substances are discharged to the WWTP.
negligible effects (1)	(a) >99% of population connected to sewerage and/or (b) Advanced (tertiary) treatment or any additional treatment beyond secondary, e.g. disinfection for collected wastewater.

- 3) Qualitative criteria on the potential risk for land based industrial or urban solid waste disposal, industrial or urban wastewater discharge or other land based sources (e.g. run off from agriculture, farms or spills) to contaminate water sources (either groundwater or surface waters such as rivers and reservoirs) for **drinking water** have been defined:

Table 5. Ranking criteria for drinking water quality category.

DRINKING WATER QUALITY The quality of drinking water has effects on public health:	
severe effects (4)	Any industrial or urban wastewater, or solid waste or agricultural run off reaching a drinking water source without treatment.
moderate effects (3)	Any industrial or urban wastewater, or solid waste or agricultural run off reaching drinking water sources which are filtered but not disinfected before storage and distribution.
slight effects (2)	Any industrial or urban wastewater, or solid waste or agricultural run off reaching drinking water sources which are properly filtered and disinfected before storage and distribution.

³ According to Decision IG 19/7, the Parties shall ensure that all agglomerations (>2,000 PE) collect and treat their urban waste waters before discharging them into the environment. The conditions are set in Annex I.

DRINKING WATER QUALITY	
The quality of drinking water has effects on public health:	
negligible effects (1)	No discharges/run offs affecting the water sources.

4) Categories on **bathing water quality** have been based on Decision IG.20/9 regarding Criteria and Standards for bathing waters quality in the framework of the implementation of Article 7 of the LBS Protocol, however, this category is also covered by other categories, e.g. contaminants. The following requirements should be met for sampling and analysis:

- Minimum sampling frequency: at least one per month and not less than four in a bathing period including an initial one prior to the start of the bathing period.
- For classification purposes at least 12 sample results are needed spread over 3-4 bathing seasons
- Reference method of analysis: ISO 7899-2 based on membrane filtration technique or any other approved technique

Table 6. Ranking criteria for bathing water quality category.

BATHING WATER QUALITY⁴	
The quality of bathing water is:	
Poor (4)	(a) Percentage of intestinal enterococci concentration measurements (90th percentile intestinal enterococci/100 ml) is above 185 cfu/100 mL and/or (b) No monitoring data.
Sufficient (3)	(a) Percentage of intestinal enterococci concentration measurements (90th percentile intestinal enterococci/100 ml) is less than or equal to 185 cfu/100 mL
Good (2)	(a) Percentage of intestinal enterococci concentration measurements (95th percentile intestinal enterococci/100 ml) is between 101-200 cfu/100 mL
Excellent (1)	(a) Percentage of intestinal enterococci concentration measurements (95th percentile intestinal enterococci/100 ml) is below 100 cfu/100 mL

2.2.2.2. Criteria on “ENVIRONMENTAL STATUS and PRESSURES”

5) For the evaluation of the **organic matter**, releases of BOD₅ into the Mediterranean Sea (in kg/year) need to be calculated or estimated.

The following table describes the criteria for ranking the effects/risks, only one of the alternatives (a), (b) or (c) needs to be met for assigning the related score. If different alternatives and different

⁴ The values presented in Table 6 be checked by the experts

scores are possible, the precautionary principle should be applied and the worst scenario chosen. If no data are available, the category will be ranked as moderate effects (3).

Table 7. Ranking criteria for Organic Matter category.

ORGANIC MATTER Human introduction of BOD ₅ in the marine environment has:	
Severe effects (4)	(a) Significant increase of inputs of BOD ₅ into seawater from previous year(s) and/or significant deviation from the RP/national ELV for point sources and/or (b) Significant deviation from GES target and/or national/regional/sub-regional thresholds/EQS.
Moderate effects (3)	(a) Increase of inputs of BOD ₅ into seawater from previous year(s) and/or deviation from ELV from point sources and/or (b) Deviation from GES target and/or national/regional/sub-regional thresholds/EQS and/or (c) No data available.
Slight effects (2)	(a) Increased inputs of BOD ₅ into seawater and/or deviation from RP/national ELV but meeting GES targets and/or national/regional/sub-regional thresholds.
Negligible effects (1)	(a) Decrease of inputs of BOD ₅ into seawater and meeting GES targets and/or national/regional/sub-regional thresholds.

- 6) For the evaluation of the **nutrients enrichment and biological status**, either releases of Total P and/or Total N into the hot spot area (in kg/year) or their concentration in water column (mg/l) need to be calculated or estimated.

The following table describes the criteria for ranking the effects/risks, only one of the alternatives (a), (b), (c) or (d) needs to be met for assigning the related score. If different alternatives and different scores are possible, the precautionary principle should be applied and the worst scenario chosen. If no data are available, the category will be ranked as moderate effects (3).

Table 8. Ranking criteria for nutrients and biological status category.

NUTRIENTS and BIOLOGICAL STATUS Human introduction of nutrients in the marine environment has:	
Severe effects (4)	(a) Significant increase of inputs of Total N and/or Total P into seawater from previous year(s) and/or (b) Significant decrease of dissolved oxygen and/or increase of chlorophyll concentrations in water column and/or (c) Significant deviation from GES target ⁵ and/or national/ regional/sub-regional thresholds/EQS and, where appropriate, biological status

⁵ Reference nutrients concentrations according to the local hydrological, chemical and morphological characteristics of the un-impacted marine region.

<i>NUTRIENTS and BIOLOGICAL STATUS</i> Human introduction of nutrients in the marine environment has:	
Moderate effects (3)	(a) Increase of inputs of Total N and/or Total P into seawater from previous year(s) and/or (b) Decrease of dissolved oxygen and/or increase of chlorophyll concentrations in water column and/or (c) Deviation from GES target5 and/or national/ regional/sub-regional thresholds/EQS and/or (d) No data available, including biological status.
Slight effects (2)	(a) Increased inputs of Total N and/or Total P into seawater but meeting GES targets5 and/or national/ regional/sub-regional thresholds/EQS and/or (b) Decreased concentrations of dissolved oxygen and/or increased concentration of chlorophyll in water column but meeting GES targets5 and/or national/ regional/sub-regional thresholds/EQS and/or good biological status.
Negligible effects (1)	(a) Decrease of inputs of Total N and/or Total P into seawater and meeting GES targets5 and/or national/ regional/sub-regional thresholds/EQS and/or (b) Increased concentrations of dissolved oxygen and/or decreased concentrations of chlorophyll in water column and meeting GES targets5 and/or national/ regional/sub-regional thresholds/EQS and/or good biological status.

7) For the evaluation of **contaminants** (including pollution from industries), either releases of hazardous substances into the hot spot area (in kg/year) or their concentration in water, biota or sediment need to be calculated or estimated.

The contaminants to be evaluated should consider SAP substances, pollutants covered by NBB 2008/2013 as well as the priority hazardous substances agreed by MEDPOL Focal points at their meeting held in Aix en Provence, France in November 2009 and listed in Annex II of Decision IG.21/3. A minimum common list of substances is the following:

- Metals and related compounds:
 - Chromium
 - Cadmium
 - Lead
 - Mercury
 - Organic tin compounds
 - Organic mercury compounds
 - Organic lead compounds
- Organohalogen compounds:
 - Polychlorinated Biphenyls (PCBs)
 - Polychlorinated dibenzodioxins (PCDDs)
 - Polychlorinated dibenzofurans (PCDFs)

- Organohalogenated pesticides/biocides:
 - Endosulphan
 - Hexachlorocyclohexane
 - Hexachlorobenzene

- Other organic compounds:
 - Diethylhexylphthalate (DEHP)
 - Phenolic compounds
 - Brominated flame retardants
 - Petroleum hydrocarbons, oils & greases
 - Polycyclic aromatic hydrocarbons
 - Short Chain Chlorinated Parafins

While considering this list for the purpose of assessing the inputs to marine environment as appropriate, with regards to monitoring, the Contracting Parties should include as a minimum only substances which are part of the integrated and coordinated monitoring programme either at national or regional level.

Each potential hot spot or sensitive area should be assessed regarding the most representative priority substance/s.

The following table describes the criteria for ranking the effects/risks, only one of the alternatives (a), (b), (c) or (d) needs to be met for assigning the related score. If different alternatives and different scores regarding the considered contaminants are possible, the precautionary principle should be applied and the worst scenario chosen. If no data are available, the category will be ranked as moderate effects (3).

Table 9. Ranking criteria for Contaminants category.

CONTAMINANTS	
Contaminants are introduced or were previously introduced at levels giving rise to:	
Severe effects (4)	(a) Significant increase of inputs of contaminants into marine environment compared to previous year(s) and/or in the occurrences of acute pollution events and/or (b) Significant increase of contaminants concentrations in sediment and biota and/or in frequency of cases of seafood samples above regulatory limits for contaminants and/or (c) Significant deviation from GES target and/or national/ regional/sub-regional thresholds/EQS (e.g. regional ELV on Hg ⁶).
Moderate effects (3)	(a) Increase of inputs of contaminants into marine environment compared to previous year(s) and/or (b) Increase of contaminants concentrations in sediment and biota and/or in frequency of cases of seafood samples above regulatory limits for contaminants and/or (c) Deviation from GES target and/or national/ regional/sub-regional thresholds/EQS (e.g. regional ELV on Hg) and/or

⁶ 50 µg/l by 2015 and 5 µg/l by 2019 (Decision IG 20/8.1).

CONTAMINANTS	
Contaminants are introduced or were previously introduced at levels giving rise to:	
	(d) No data available.
Slight effects (2)	(a) Increased inputs of contaminants into marine environment but meeting GES targets and/or national/ regional/sub-regional thresholds/EQS (e.g. regional ELV on Hg) and/or (b) Increased concentrations of contaminants in sediment and biota but meeting GES targets and/or national/ regional/sub-regional thresholds/EQS (e.g. regional ELV on Hg).
Negligible effects (1)	(a) Decrease of inputs of hazardous substances into marine environment and meeting GES targets and/or national/ regional/sub-regional thresholds/EQS (e.g. regional ELV on Hg) and/or (b) Decreased concentrations of contaminants in sediment and biota and meeting GES targets and/or national/ regional/sub-regional thresholds/EQS (e.g. regional ELV on Hg).

- 8) **Marine litter** category addresses the effects of any solid materials discarded, disposed of or abandoned in the marine and coastal environment; solid waste from industrial sources is not addressed under this category.

The area to which this category applies is the area defined both in the Regional Plan on marine litter (Decision IG.21/7) and in Art. 3 of the LBS Protocol paragraphs (a), (c), and (d)⁷.

The following table describes the criteria for ranking the effects/risks, only one of the alternatives (a), (b) or (c) needs to be met for assigning the related score. If different scores are possible, the precautionary principle should be applied and the worst scenario chosen.

Table 10. Ranking criteria for Marine Litter category.

MARINE LITTER	
Properties and quantities of marine litter affect the coastal and marine environment:	
Severe effects (4)	(a) Significant increase of number of areas with accumulated marine litter at sea and in the land part of the coastal zone up to 1 km close to the river mouth or run-off drainage system and/or (b) Significant increase of the amount of litter washed ashore and/or deposited on coastlines and/or (c) Illegal dump sites and/or non-sanitary landfills located in the coastal area or river basin area.

⁷ Article 3 of the LBS Protocol: (a) The Mediterranean Sea Area as defined in article 1 of the Convention; (c) Waters on the landward side of the baselines from which the breadth of the territorial sea is measured and extending, in the case of watercourses, up to the freshwater limit; (d) Brackish waters, coastal salt waters including marshes and coastal lagoons, and ground waters communicating with the Mediterranean Sea.

MARINE LITTER	
Properties and quantities of marine litter affect the coastal and marine environment:	
Moderate effects (3)	(a) Increase of number of areas with accumulated marine litter at sea and in the land part of the coastal zone up to 1 km close to the river mouth or run-off drainage system and/or (b) Increase of the amount of litter washed ashore and/or deposited on coastlines and/or (c) Illegal dump sites and/or non-sanitary landfills in the river basin area.
Slight effects (2)	(a) Maintained number of areas with accumulated marine litter at sea and in the land part of the coastal zone up to 1 km close to the river mouth or run-off drainage system and/or (b) Maintained trends in the amounts of litter washed ashore and/or deposited on coastlines and/or
Negligible effects (1)	(a) Decreased trends in number of areas with accumulated marine litter at sea and in the land part of the coastal zone up to 1 km close to the river mouth or run-off drainage system and/or (b) Decreased trends in the amounts of litter washed ashore and/or deposited on coastlines and/or (c) No illegal dump sites and/or non-sanitary landfills.

2.2.2.3. Criteria on “ECONOMICS”⁸

9) The following table describes the criteria for ranking the effects/risks on **economic activities** (and **ecosystem services** underpinning them), only one of the alternatives (a), (b) or (c) needs to be met for assigning the related score. If different alternatives and different scores are possible, the precautionary principle should be applied and the worst scenario chosen.

Table 11. Ranking criteria for recreation and ecosystem services category.

ECONOMIC ACTIVITIES AND UNDERPINNING ECOSYSTEM SERVICES	
severe effects (4)	(a) Area with a significant decrease in tourism and other recreational activities and/or it is a very important tourist area (>200,000 tourists annually) and/or (b) Severe effects on aquaculture or fisheries and/or close to a very important aquaculture and fisheries area (including spawning sites) and/or (c) Severe effects on provision of ecosystem services.
moderate effects (3)	(a) Area with a decrease in tourism and other recreational activities and/or it is an important tourist area (100,000 - 200,000 tourists annually) and/or (b) Moderate effects on aquaculture or fisheries and/or close to an important aquaculture and fisheries area and/or (c) Moderate effects on provision of ecosystem services.
slight effects (2)	(a) Tourism and other recreational activities are maintained and/or it is a

⁸ Further work is ongoing in the framework of ECAP regarding ecosystem services.

	<p>tourist area between 10,000 – 100,000 tourists annually and/or</p> <p>(b) Slight effects on aquaculture or fisheries and/or relatively far from an aquaculture and fisheries area and/or</p> <p>(c) Slight effects on provision of ecosystem services.</p>
negligible effects (1)	<p>(a) Tourism and other recreational activities are increasing and/or it is a tourist area below 10,000 tourists annually and/or</p> <p>(b) Negligible effects on aquaculture or fisheries or no aquaculture and fisheries activities nearby and/or</p> <p>(c) Negligible effects on provision of ecosystem services.</p>

Once the hot spots are categorised it is recommended to collect the necessary information regarding the investment and related costs required for their elimination.

2.2.2.4. Criteria on “TRANSBOUNDARY EFFECTS”

10) The following table describes the criteria for ranking the effects/risks on **transboundary effects**.

Table 12. Ranking criteria for transboundary effects category.

TRANSBOUNDARY EFFECTS	
severe effects (4)	Downstream area close to the borders ⁹ discharging to the Mediterranean sea significant amounts of substances which are toxic, persistent and liable to bioaccumulate and/or marine litter.
moderate effects (3)	Downstream area close to the borders discharging to the Mediterranean sea <p>(a) Moderate amounts of substances which are toxic, persistent and liable to bioaccumulate and/or marine litter.</p> <p>(b) Significant amounts of nutrients and/or organic matter.</p>
slight effects (2)	Area close to the borders discharging to the Mediterranean sea <p>(a) Negligible amounts of substances which are toxic, persistent and liable to bioaccumulate and/or marine litter.</p> <p>(b) Moderate amounts of nutrients and/or organic matter.</p>
negligible effects (1)	Area far from the border with no direct/indirect effect.

⁹ Secretariat to clarify further

3. Guidance on the implementation of evaluation criteria and test example

3.1. Screening/compilation of a list of potential hot spots

For the initial list of potential sites, nation-wide data should be gathered from the following sources:

- a) PRTR (Pollutant Release and Transfer Register) data.
- b) Seawater, sediment and aquatic life monitoring data.
- c) Factory or industry emission permits.
- d) Information from local authorities (amounts of marine litter, bathing water quality, local emission sources, etc.).

3.2. Assigning the category scores for each site

Determining the score for each category is notably dependent on local quality standards and on expert judgement. The evaluation can be performed according to the following principles:

(a) Population

This category refers to the size of the affected population and its distance from the potential hotspot. A geographic analysis has to be made to determine the nature of the secondary effects, the dispersion of polluting substances and the density of the population in terms of both permanent and temporary residents.

If different alternatives and different scores are possible, the precautionary principle should be applied and the worst scenario chosen.

(b) Wastewater Treatment

The following data can be used to aid the assessment of the wastewater treatment criteria:

- (a) Evidence of marine discharge of raw sewage, or minimally treated wastewater.
- (b) The frequency of overflows and leaks in the last years and the amount of wastewater discharged in these events will be evaluated in order to decide on the significance of the impact.
- (c) Examination of the pollution load from industrial sources obtained and untreated in WWTP (such as heavy metals). Will be determined by the concentration multi-year trends of pollutants leaving the WWTP.

(c) Drinking Water

The purpose of this category is to further prioritize sites that also pollute drinking water sources beside the Mediterranean seawater. For this category, local standards will be reviewed along with the general quality of the polluted water body to assess the impact of the potential hot spot.

(d) Bathing Water Quality

This category refers to frequent health risk in the bathing water and not one-time events. The number of events or instances of high pathogens in the water has to be assessed to determine the final score. For example – “severe effect” for beaches with constant high health risk, “moderate effect” for repeated to isolated events, and “slight effects” for occasional events of high pollution.

The following requirements should be met for sampling and analysis:

- (b) Minimum sampling frequency: at least one per month and not less than four in a bathing period including an initial one prior to the start of the bathing period.
- (c) For classification purposes at least 12 sample results are needed spread over 3-4 bathing seasons.
- (d) Reference method of analysis: ISO 7899-2 based on membrane filtration technique or any other approved technique.

(e) Organic Matter

Organic matter emission is first compared to GES standards, either local or regional. When these are no available standards, the emission can be rated according to comparable orders of magnitude.

(f) Nutrients and biological status

Nutrients emission and seawater concentrations are first compared to available GES standards, either local or regional. When no specific values or other targets are available, the emission can be assessed by referring to all available data to determine the severity of the pollution.

Nutrients concentration are also affected by the characteristics of the location of discharge – for example, nutrients discharged in a partially enclosed bay are more prone to accumulate and spur eutrophication than nutrients discharged in open waters. For the final ranking, both local and regional chlorophyll concentration have to be considered, along with the magnitude of emission and its location and the distribution exists in the estuary.

The biological status can also be considered based on national standards, practices and monitoring data.

(g) Contaminants

Contaminants concentrations and emissions should be considered in the context of the types of emission sources in and around the potential hot-spots. When no knowledge of current concentration and loads is available, the evaluation will be based on a worst-scenario basis.

(h) Marine Litter

Marine litter category is based on local accounts. And refers to frequent and concentration of marine litter in the water and not one-time events. The number of events or instances of high concentration of marine litter has to be assessed to determine the final score. For example – “severe effect” for beaches with constant high marine litter problem or close to emission source of waste,

“moderate effect” for repeated to isolated events, and “slight effects” for occasional events of high pollution.

(i) **Economic activities and Underpinning Ecosystem Services**

The severity of the damage to local and regional economic activities (and ecosystem services underpinning them) can be assessed by relating to either recent trends in activity level or to nearby coastal area with similar characteristics.

(j) **Transboundary effect**

The factors to be considered in assessing transboundary effects are related to the distance from the border of the pollution area including downstream or upstream location, as well as the nature and discharge loads of the pollutants. It has to be noted that different categories of pollutants should be examined such as heavy metals, organic pollutants, nutrients and marine litter.

4. References

- [1] Decision IG.20/9. Criteria and Standards for bathing waters quality in the framework of the implementation of Article 7 of the LBS Protocol.
- [2] Decision IG.21/3 on the Ecosystems Approach including adopting definitions of Good Environmental Status (GES) and targets.
- [3] Decision IG.21/7 on the Regional Plan on Marine Litter Management in the Mediterranean in the Framework of Article 15 of the Land Based Sources Protocol.
- [4] Decision IG 19/7 on the Regional Plan on the reduction of BOD5 from urban wastewater in the framework of the implementation of Article 15 of the LBS Protocol.
- [5] COMMISSION DECISION of 1 September 2010 on criteria and methodological standards on good environmental status of marine waters.
- [6] COUNCIL DIRECTIVE of 21 May 1991 concerning urban wastewater treatment (91/271/EEC).
- [7] DIRECTIVE 2008/56/EC OF THE EUROPEAN PARLIAMENT AND OF THE COUNCIL of 17 June 2008 establishing a framework for community action in the field of marine environmental policy (Marine Strategy Framework Directive).
- [8] HELCOM 2013. Final report on implementation of hot spots programme under the Baltic Sea Joint Comprehensive Environmental Action Programme (JCP), 1992-2013. HELCOM Ministerial Meeting.
- [9] HELCOM PITF, 1999. Criteria for inclusion and deletion of hot spots: procedures and guidelines for inclusion and deletion of hot spots. PROGRAMME IMPLEMENTATION TASK FORCE. 21 May 1999.
- [10] OSPAR Commission, 2013. Common Procedure for the Identification of the Eutrophication Status of the OSPAR Maritime Area (Reference number: 2013-8).
- [11] OSPAR Commission, 2010. The Quality Status Report 2010.
- [12] OSPAR Commission, 2003. JAMP Guidance on input trend assessment and the adjustment of loads (Reference number: 2003-9).
- [13] OSPAR Commission, 1998. Principles of the Comprehensive Study on Riverine Inputs and Direct Discharges (RID). (Reference number: 1998-5)
- [14] UNEP/MAP, 2003. Second Report on the pollution hotspots in the Mediterranean. Part I and II.
- [15] UNEP/MAP, 2014. Introduction to pollutant release and transfer register (PRTR) and guidelines for reporting (UNEP(DEPI)/MED WG.399/3).
- [16] UNEP/MAP/WHO, 1996, SURVEY OF POLLUTANTS FROM LAND-BASED SOURCES IN THE MEDITERRANEAN. MAP Technical Reports Series No. 109.

- [17] UNEP/MAP/WHO, 1999. IDENTIFICATION OF PRIORITY POLLUTION HOT SPOTS AND SENSITIVE AREAS IN THE MEDITERRANEAN. MAP Technical Reports Series No. 124.
- [18] Union for the Mediterranean, 2013. Update of priority investment projects for the de-pollution of the Mediterranean Sea from pollution. Project Ref. Number: HORIZON 2020 – UFMS /NP/0102/2012.
- [19] World Bank, 2011. Final Report of the project “ADRIATIC SEA ENVIRONMENT PROGRAM: Rapid Assessment of Pollution Hotspots for the Adriatic Sea”.

APPENDIX D. Issues/impacts matrix for scoring issues associated with impacts on human health and marine environment*

Index of tables

Table 1. Issues/impacts matrix for scoring issues associated with impacts on human health and marine environment..... 2

* The table included in this Appendix is taken from the NAP Guidelines approved in 2004. The Secretariat is reviewing the list of contaminants and will present proposed changes to this table, as appropriate, at the next MED POL FP meeting in June 2015.

Table 1: Issues/impacts matrix for scoring issues associated with impacts on human health and marine environment.

Issue	Score 0 = No concern	Score 1 = Slight concern	Score 2 = moderate concern	Score 3 = major concern
Trace Metals	<ul style="list-style-type: none"> - No evidence of production or product contamination - No evidence of air emissions - No evidence of emissions from solid residues - No evidence of chemical stockpiled - No evidence of chemical being contaminant in production of other chemicals - No evidence of use of the chemical - No evidence of release from liquid effluent 	<ul style="list-style-type: none"> - Evidence of limited production - Presence of small sources with possible emissions (e.g. small incineration plants) - Some limited evidence of releases but on a small scale invoking local concerns - Some use of the chemical in small areas - Some limited evidence of releases according to national standards 	<ul style="list-style-type: none"> - Historical production evident and production for local use ongoing - Present as contaminant in other chemical production - Presence of major combustion related sources e.g. large municipal or industrial incinerators - Evidence of stockpiles of the chemical - Use of chemical in agriculture or industry sub-regionally 	<ul style="list-style-type: none"> - Major production of chemical for local and export use - Chemical evident as contaminant in large scale production of other chemicals - Known emission of chemical from large scale - Evidence of leakage from major stockpiles of the chemical poorly packaged - Large-scale use of the chemical throughout the region
	<ul style="list-style-type: none"> - No known or historical levels of chemical contaminant in the environment except background levels of naturally occurring substances - No available data to quantify evidence of the chemical found in fish, wildlife animal or human tissue 	<ul style="list-style-type: none"> - Chemical contaminants are detectable in the environment but below threshold limits defined for the country or region - Chemical contaminants are detectable from fish, wildlife, foodstuff or human samples but below threshold limits established for the country or region 	<ul style="list-style-type: none"> - Chemical contaminants are found in the environment marginally above threshold limits defined for the country or region - Limited data available to support chemical existing within fish, wildlife, foodstuff or human tissue at marginal levels above threshold standards for the country or region 	<ul style="list-style-type: none"> - Chemical contaminant is analysed repeatedly well above threshold limits in the environment defined for the country or region - Known contamination of fish, wildlife, foodstuff or humans at levels far exceeding the threshold established for the country or region

Issue	Score 0 = No concern	Score 1 = Slight concern	Score 2 = moderate concern	Score 3 = major concern
Organohalogenes	<ul style="list-style-type: none"> - No evidence of production or product contamination - No evidence of air emissions - No evidence of emissions from solid residues - No evidence of chemical stockpiled - No evidence of chemical being contaminant in production of other chemicals - No evidence of use of the chemical - No evidence of release from liquid effluent 	<ul style="list-style-type: none"> - Evidence of limited production - Presence of small sources with possible emissions (e.g. small incineration plants or bleached kraft/pulp mills using chlorine) - Some limited evidence of releases but on a small scale invoking local concerns - Some use of the chemical in small areas - Some limited evidence of releases in compliance with national standards 	<ul style="list-style-type: none"> - Historical production evident and production for local use ongoing. - Present as contaminant in other chemical production - Presence of major combustion related sources e.g. large municipal or industrial incinerators or large bleached kraft pulp mills - Evidence of stockpiles of the chemical - Use of chemical in agriculture or industry 	<ul style="list-style-type: none"> - Major production of chemical for local and export use - Chemical evident as contaminant in large scale production of other chemicals - Known emission of chemical from large scale incinerators or chlorine bleaching of pulp or other related combustion facilities - Evidence of leakage from major stockpiles of the chemical poorly packaged - Large-scale use of the chemical throughout the Region
	<ul style="list-style-type: none"> - No known or historical levels of chemical contaminant in the environment except background levels of naturally occurring substances - No available data to quantify evidence of the chemical found in fish, wildlife animal or human tissue 	<ul style="list-style-type: none"> - Chemical contaminants are detectable in the environment but below threshold limits defined for the country or region - Chemical contaminants are detectable from fish, wildlife, foodstuff or human samples but below threshold limits established for the country or region 	<ul style="list-style-type: none"> - Chemical contaminants are found in the environment marginally above threshold limits defined for the country or region - Limited data available to support chemical existing within fish, wildlife, foodstuff or human tissue at marginal levels above threshold standards for the country or region 	<ul style="list-style-type: none"> - Chemical contaminant is analysed repeatedly well above threshold limits in the environment defined for the country or region - Known contamination of fish, wildlife, foodstuff or humans at levels far exceeding the threshold established for the country or region

Issue	Score 0 = No concern	Score 1 = Slight concern	Score 2 = moderate concern	Score 3 = major concern
BOD from industrial sources	<ul style="list-style-type: none"> - No evidence of releases from solid residues - Evidence of BOD levels in Rivers in compliance with national standards - Evidence of releases of all liquid industrial effluents in compliance with the national standards 	<ul style="list-style-type: none"> - Presence of small sources from small size industries - Some limited evidence of releases but on a small scale invoking local concerns 	<ul style="list-style-type: none"> - Historical releases of BOD from medium size industry - Evidence of periodical high BOD levels in coastal rivers 	<ul style="list-style-type: none"> - BOD releases are evident as contaminant in large scale industries - Known releases of BOD from large scale industries - Evidence of leakage from major municipal solid waste landfills - Evidence of leakage from major industrial solid waste landfills
	<ul style="list-style-type: none"> - No known or historical levels of BOD in water bodies except background levels of naturally occurring substances - No evidence of any eutrophication cases 	<ul style="list-style-type: none"> - BOD levels are detectable in water bodies but below threshold limits defined for the country or region 	<ul style="list-style-type: none"> - BOD levels are found in water bodies marginally above threshold limits defined for the country or region - Historical few harmful effects for marine and rivers wildlife associated with high BOD Levels 	<ul style="list-style-type: none"> - BOD levels are analysed repeatedly well above threshold limits in water bodies - Evidence of repeated harmful effects for marine and rivers wildlife associated with high BOD levels
Issue	Score 0 = No concern	Score 1 = Slight concern	Score 2 = moderate concern	Score 3 = major concern
PCBs	<ul style="list-style-type: none"> - No evidence of production or product contamination - No evidence of air emissions - No evidence of emissions from solid residues - No evidence of chemical stockpiled 	<ul style="list-style-type: none"> - Evidence of limited production - Presence of small sources with possible emissions (e.g. small incineration plants or bleached kraft/pulp mills using chlorine); - Some limited evidence of releases but on a small scale invoking 	<ul style="list-style-type: none"> - Historical production evident and production for local use ongoing. Present as contaminant in other chemical production - Presence of major combustion related sources 	<ul style="list-style-type: none"> - Major production of chemical for local and export use - Chemical evident as contaminant in large scale production of other chemicals

	<ul style="list-style-type: none"> - No evidence of chemical being contaminant in production of other chemicals - No evidence of use of the chemical - No evidence of release from liquid effluent 	<ul style="list-style-type: none"> local concerns - Some use of the chemical in small areas - Some limited evidence of releases associated with liquid effluents 	<ul style="list-style-type: none"> e.g. large municipal or industrial incinerators or large bleached kraft pulp mills - Evidence of stockpiles of the chemical - Use of chemical in agriculture or industry 	<ul style="list-style-type: none"> - Known emission of chemical from large scale incinerators or chlorine bleaching of pulp or other related combustion facilities - Evidence of leakage from major stockpiles of the chemical poorly packaged - Large-scale use of the chemicals in the region
	<ul style="list-style-type: none"> - No known or historical levels of chemical contaminant in the environment except background levels of naturally occurring substances - No available data to quantify evidence of the chemical found in fish, wildlife animal or human tissue 	<ul style="list-style-type: none"> - Chemical contaminants are detectable in the environment but below threshold limits defined for the country or region - Chemical contaminants are detectable from fish, wildlife, foodstuff or human samples but below threshold limits established for the country or region 	<ul style="list-style-type: none"> - Chemical contaminants are found in the environment marginally above threshold limits defined for the country or region - Limited data available to support chemical existing within fish, wildlife, foodstuff or human tissue at marginal levels above threshold standards for the country or region 	<ul style="list-style-type: none"> - Chemical contaminant is analysed repeatedly well above threshold limits in the environment defined for the country or region - Known contamination of fish, wildlife, foodstuff or humans at levels far exceeding the threshold established for the country or region
Issue	Score 0 = No concern	Score 1 = Slight concern	Score 2 = moderate concern	Score 3 = major concern
Solid waste	<ul style="list-style-type: none"> - Evidence of convenient solid waste management system in the region - No noticeable interference with the recreational use of beaches due to litter - No reported entanglement of 	<ul style="list-style-type: none"> - Evidence of temporary failure of the solid waste management system - Some evidence of marine derived litter on beaches - Occasional recovery of solid waste through trawling activities 	<ul style="list-style-type: none"> - No evidence of solid waste landfill - Widespread litter on beaches giving rise to public concern regarding recreational use of beaches - High frequency of benthic 	<ul style="list-style-type: none"> - No evidence of solid waste management system - Incidence of litter on beaches sufficient to deter the public from recreational activities

	aquatic organisms with debris		litter recovery and interference with trawling activities – Frequent report of entanglement or suffocation of species by litter	– Trawling activities untenable because of benthic litter and gear entanglement – Widespread entanglement and/or suffocation of aquatic species by litter
Issue	Score 0 = No concern	Score 1 = Slight concern	Score 2 = moderate concern	Score 3 = major concern
Batteries and chemicals associated to its manufacturing	<ul style="list-style-type: none"> – No evidence of production – No evidence of air emissions – No evidence of emissions from solid residues – No evidence of batteries stockpiled – No evidence of release from liquid effluent – Evidence of extensive recycling (100%) of Batteries 	<ul style="list-style-type: none"> – Evidence of limited production – Presence of small sources with possible emissions (e.g. small incineration plants and landfills) – Some limited evidence of releases but on a small scale invoking local concerns – Presence of small stockpiles – Evidence of medium scale recycling (80%) 	<ul style="list-style-type: none"> – Historical production evident and production for local use ongoing – Presence of major combustion related sources e.g. large municipal or industrial incinerators – Evidence of stockpiles of batteries – Evidence of small scale recycling (50%) of batteries 	<ul style="list-style-type: none"> – Major production of batteries for local & export use – Chemicals from Batteries production are evident as contaminant in large scale production – Evidence of leakage from major stockpiles – Large-scale use of batteries throughout the region – Evidence of no recycling of batteries
	<ul style="list-style-type: none"> – No known or historical levels of chemical contaminant in the environment except background levels of naturally occurring substances – No available data to quantify evidence of the chemical found in fish, wildlife animal or human tissue 	<ul style="list-style-type: none"> – Chemical contaminants are detectable in the environment but below threshold limits defined for the country or region – Chemical contaminants are detectable from fish, wildlife, foodstuff or human samples but below threshold limits established for the country or region 	<ul style="list-style-type: none"> – Chemical contaminants are found in the environment marginally above threshold limits defined for the country or region – Limited data available to support chemical existing within fish, wildlife, foodstuff or human tissue at 	<ul style="list-style-type: none"> – Chemical contaminant is analysed repeatedly well above threshold limits in the environment country or region – Known contamination of fish, wildlife, foodstuff or humans at levels far exceeding the threshold

Issue	Score 0 = No concern	Score 1 = Slight concern	Score 2 = moderate concern	Score 3 = major concern
Lub Oil	<ul style="list-style-type: none"> - No evidence of production - No evidence of air emissions - No evidence of emissions from solid residues - No evidence of lub oil stockpiled - No evidence of release from liquid effluent - Evidence of full recycling of lub oil 	<ul style="list-style-type: none"> - Evidence of limited production - Presence of small sources with possible emissions (e.g. small incineration plants and landfills) - Some limited evidence of releases but on a small scale invoking local concerns - Presence of small stockpiles - Evidence of medium scale recycling of lub oil 	<ul style="list-style-type: none"> - Historical production evident and production for local use ongoing - Presence of major combustion related sources e.g. large municipal or industrial incinerators - Evidence of stockpiles of lub oil - Evidence of limited recycling of lub oil 	<ul style="list-style-type: none"> - Major production of lub oil for local and export use - Chemicals from Batteries production are evident as contaminant in large scale production - Evidence of leakage from major stockpiles of the chemical poorly packaged - Large-scale use of lub oil throughout the region - Evidence of no recycling of lub oil
	<ul style="list-style-type: none"> - No known or historical levels of chemical contaminants from lub oil in the except background levels of naturally occurring substances - No available data to quantify evidence of the chemicals originated from lub oil found in fish, wildlife animal or human tissue 	<ul style="list-style-type: none"> - Chemical contaminants from lub oil are detectable in the environment threshold limits defined for the country or region - Chemical contaminants originated from lub oil are detectable from fish, wildlife, foodstuff or human samples but below threshold limits established for the country or region 	<ul style="list-style-type: none"> - Chemical contaminants from lub oil are found in the environment marginally above threshold limits defined for the country or region - Limited data available to support chemicals originated from lub oil existing within fish, wildlife, foodstuff or human tissue at marginal levels above threshold standards for the country 	<ul style="list-style-type: none"> - Chemical contaminants from lub oil are analysed repeatedly well above threshold limits in the environment defined for the country or region - Known contamination of fish, wildlife, foodstuff or humans by chemical originated from lub oil at levels far exceeding the threshold established for the country

Issue	Score 0 = No concern	Score 1 = Slight concern	Score 2 = moderate concern	Score 3 = major concern
All issues	<ul style="list-style-type: none"> - No evidence of violation of Bilateral environmental agreements - No evidence of violation of regional and global environmental agreement - No evidence of transboundary impacts 	<ul style="list-style-type: none"> - Potential transboundary impacts 	<ul style="list-style-type: none"> - Increase of GHG emissions 	<ul style="list-style-type: none"> - Evidence of violation of regional and global environmental agreements - Potential bilateral conflict

APPENDIX E. List of indicators to assess the LBS, Dumping, Hazardous waste Protocols, NAP and Regional Plans implementation

Table of contents

1. INTRODUCTION	2
2. INDICATORS TO ASSESS THE IMPLEMENTATION OF THE LBS, DUMPING AND HAZARDOUS WASTE PROTOCOLS, LBS REGIONAL PLANS AND NAPS.....	3
3. SELECTION AND PRIORITIZATION METHODOLOGY OF INDICATORS PRESENTED IN NAP UPDATE DRAFT GUIDELINES	7

1. Introduction

The UNEP/MAP programme of work 2014-2015 adopted by the eighteenth meeting of the Contracting parties (COP 18), 3-6 December 2013, Istanbul, Turkey, mandated the Secretariat to update the MAP reporting system with the view to make it more user friendly, further strengthen its indicator-based dimension as well as complete it with the reporting requirements of the Regional Plans adopted under Article 15 of the LBS Protocol.

COP 18 also requested the contracting parties to update their National Action Plans (NAPs) that were endorsed by COP 14, Portoroz, Slovenia, 2005, in accordance with Article 5 of the LBS Protocol of the Barcelona Convention.

With the view to deliver the above tasks, the Secretariat developed the draft Guidelines for updating the NAPs, including an annex on “NAP follow-up and reporting indicators”. The Annex provided a comprehensive list of indicators of relevance for the follow-up of NAPs implementation. The listed indicators were indicators already in use and/or in process of negotiation within and/or outside MAP system, consistent with regional and international reporting requirements relevant to MAP. This document was presented at the MED POL Focal Points (FP) meeting on 26-28 March 2014 in Athens, Greece.

The MED POL FP asked the Secretariat to:

- a) continue its work and conduct an in-depth analysis of the reporting requirements of the LBS, Dumping and Hazardous waste Protocols as well as of the Regional Plans adopted in the framework of the LBS Protocol and recommend a list of ranked indicators for assessing their implementation.
- b) streamline the Protocols and Regional Plans indicators with the NAP follow up and reporting indicators.

With the view to propose the list of potential ranked indicators that fit the reporting requirements of the LBS, Dumping and HW protocols, the Regional Plans and the NAPs the Secretariat carried out a two-step analysis:

The first step included a prioritization exercise of the list of indicators presented at the March 2014 MED POL FP meeting, based on UNEP/MAP Plan Bleu and EEA experience with indicators and presented in section three of this Appendix. In addition, the Secretariat used the opportunity of the workshop on PRTR held in the framework of SEIS Project, in Ankara, Turkey, in June 2014 to review again and carry out a second scoring exercise with participation and contribution of several country experts.

In the second step, **indicators receiving more than 50% of the total scores were** further analyzed and complemented by the Secretariat with other potential indicators based on the in-depth and concrete legal and policy analysis of the relevant provisions of the Barcelona Convention and Protocols. This list was submitted at the MED POL FP meeting held on 18 – 19 December 2014 in Barcelona for its consideration. After a careful review the meeting agreed on the list presented in section 2 of this Annex IV, Appendix E while pointing out the importance of identifying this list of common indicators for the Mediterranean and requesting the Secretariat to work further on assessing the level of maturity for each indicator, for consideration at the forthcoming meetings of the MED POL Focal Points, and as appropriate by other MAP bodies.

2. Indicators to assess the implementation of the LBS, Dumping and Hazardous Waste Protocols, LBS Regional Plans and NAPs

In case of LBS&Regional Plans&NAPs implementation, the indicators should respond to questions related to pollution reduction and prevention trends in the Mediterranean region and the improvement of marine and coastal environment (to achieve the relevant ECAP GES targets) through the implementation of the LBS Protocol, its Regional Plans, Dumping as well as the Hazardous Waste Protocols of the Barcelona Convention as well as the NAPs.

The indicators are organized according to the following structure:

- SAP MED/NAP sectors (based on Annex I of the LBS Protocol).
- Relevant legal and policy questions (from the Protocols and Regional Plans).
- Title of the candidate indicators per each sector and the related codes.
- Units.
- Link to other initiatives and policy/legal frameworks (to be further completed).
- Type.
- Indicator description.
- Information on data sets and sources (to be further completed).
- Reference to the mandatory related obligations under the Barcelona Convention and related Protocols as well as the Regional Plans.
- Total scoring per each candidate indicator (from both steps of the prioritization analysis).

For ease of reference, the legal and policy questions raised per each NAP/SAP sector are presented below together with the title of the candidate indicators as well as related ECAP indicator.

I. Urban development

a) WASTEWATER (NAP/LBS and RP on BOD from WWTP)

Are the agglomerations (areas with a population of more than 2.000 inhabitants and/or economic activities sufficiently concentrated) collecting and treating their urban waste waters before discharging them directly or indirectly into the Mediterranean Sea?

- WW01. Share of population with access to an improved sanitation system (total, urban, rural).
- WW02. Wastewater collected (in population equivalent).
- WW03. Wastewater treated (in population equivalent).

Do collecting systems consider the best technical knowledge notably regarding: (a) the volume and characteristics of urban waste water; (b) the maintenance of piping system for the prevention of leaks; (c) the maintenance of pumping and boosting equipment; and (d) the separation of storm water pipes from collection pipes of WWTP, when applicable?

- WW04. Share of the treated wastewater according to the type of treatment (primary, secondary, tertiary) and, where relevant, share of wastewater reused after treatment.

- WW05. Total loads of BOD5, Total nitrogen, Total phosphorus discharged to the Mediterranean Sea from urban wastewater treatment.

Are the coastal and marine environment and health protected from the adverse effects of the urban waste water direct and or indirect discharges, in particular regarding adverse effects on the oxygen content of the coastal and marine environment and eutrophication phenomena?

ECAP common indicator 7/[WW06]. Concentration of key nutrients in the water column.

ECAP common indicator 8/[WW07]. Chlorophyll A concentration in the water column.

b) BATHING WATER QUALITY (Decision IG 20/9)

Is the quality of bathing waters in the Mediterranean countries being improved?

- BW01. Share of bathing water categories: A (Excellent quality), B (Good quality), C (Sufficient) and D (Poor quality) with respect to total number of assessed bathing waters.
- **ECAP Common Indicator 15/[IND04]** “Percentage of intestinal enterococci concentration measurements within established standards”)

c) MUNICIPAL SOLID WASTE AND MARINE LITTER (NAP/LBS and RP on Marine Litter management)

Is marine litter pollution in the Mediterranean being prevented and reduced to the minimum?

ECAP Common Indicator 16/[MW01] Trends in the amount of litter washed ashore and/or deposited on coastlines, including analysis of its composition, spatial distribution and, where possible, source.

[ECAP Common Indicator 17/[MW02] Trends in the amount of litter in the water column including microplastics and on the seafloor.

[ECAP Common Indicator 18/[MW03]. Trends in the amount of litter ingested by or entangling marine organisms focusing on selected mammals, marine birds and turtles.] (trial basis)

Is the municipal solid waste management based on the waste hierarchy (prevention, preparing for re-use, recycling, other recovery, e.g. energy recovery and environmentally sound disposal) as a priority order in waste prevention and management legislation and policy?

- MW04. Municipal waste generation per capita.

- MW05. Share of recycled, composted, incinerated, treated in waste-to-energy facilities or landfilled municipal waste with respect to collected amount.
- MW06. Share of generated municipal waste per waste composition category: paper/paperboard, textiles, plastics, glass, metals, other inorganic material, organic material.
- MW07. Number of illegal dumpsites at coastal area that have been closed/remediated over the past 10 years.

Are prevention measures related to: (a) Extended Producer Responsibility, (b) Sustainable Procurement Policies, (c) Voluntary agreements with retailers and supermarkets, (d) Fiscal and economic instruments, (e) Deposits, Return and Restoration System and, (f) Procedures and manufacturing methodologies with plastic industry, being explored and implemented to the extent possible in order to reduce the fraction of plastic packaging waste that goes to landfill or incineration without energy recovery?

- [MW0X. Share of (supermarkets) applying deposit, return and restoration system for plastic beverage bottles.]¹
- MW08. Annual consumption of plastic bags at national level per capita.
- MW09. Share of producers, manufacturer brand owners and first importers responsible for the entire life-cycle of the product with measures prioritizing the eco-design of the product and the hierarchy of waste management.

d) Urban AIR POLLUTION (NAP/LBS Protocol Annex III)

Is air quality in coastal Mediterranean cities being improved in the Mediterranean?

Indicators already agreed under other relevant multilateral international agreements and EEA as appropriate and relevant assessment described in a concise manner

II. INDUSTRIAL DEVELOPMENT (Barcelona Convention Article 8, LBS Articles 1 and 5, Annex III, Regional Plans (Mercury, POPs, BOD from food sector, NAPs, Dumping Protocol and Hazardous Waste Protocol)

a) INDUSTRIAL POLLUTION

Are the emissions/pollution inputs from industrial land based sources and activities being eliminated, or phased out in the hydrological basin of the Mediterranean?

- **ECAP Common Indicator 11/[IND01]** Concentration of key harmful contaminants measured in the relevant matrix (biota, sediment, seawater).
- **ECAP Common Indicator 12/[IND02]** Level of pollution effects of key contaminants where a cause and effect relationship has been established.²

¹ Indicator to be considered in the future

² It is recommended to consider streamlining of these two indicators (IND01 and IND 02) in the future.

- **ECAP Common Indicator 14**/[IND03] Actual levels of contaminants that have been detected and number of contaminants which have exceeded maximum regulatory levels in commonly consumed seafood.
- IND004. National loads of pollutants from point sources:
 - (a) SO₂, NO_x, NH₃, VOC, hydrocarbons, CO, CH₄, TPS, PM₁₀, PM_{2.5}, POPs, heavy metals;
 - (b) PAH, VOC, PCDD/PCDF, Hexachlorobenzene, Cadmium, Chromium, Lead and Mercury which are directly or indirectly discharged to the Mediterranean Sea;
 - (c) Total loads of BOD₅, Total nitrogen, Total phosphorus discharged to the Mediterranean Sea.
- IND05. Number of substances covered by national standards (ELV) for point source discharges into water or air.
- IND06. Share of contaminated sites with toxic, persistent and liable to accumulate substances in the coastal area which have been closed/remediated including spills from industrial accidents.
- IND07. Share of companies within Annex I of the LBS Protocol applying cleaner production, BAT and/or BEP.

b) HOT SPOTS

Is the state of the national hot spots in the Mediterranean periodically monitored and hot spots eliminated?

- HS01. Share of hot spots and sensitive areas covered by monitoring, projects/ investments and/or eliminated.

c) DUMPING

Are the quantities of the materials dumped in the sea and their impact monitored and reported to the Secretariat in accordance with Articles 10, 11 and 12 of the Dumping Protocol?

- D01. Annual quantities of materials dumped per category.
- D02. Share of number of permits issued by national competent authorities providing for strict monitoring programmes of marine environment from dumping activities.
- [D03.Number of permits for industrial waste]..

d) HAZARDOUS WASTE

Is the amount of HW generated being reduced and disposed in an environmental sound manner in the Mediterranean?

- [HW01. Amount of hazardous waste generated by Y categories.
- HW02. Amount of hazardous waste environmentally soundly managed or exported by Y categories and by disposal/recovery operation (D - disposal, R- recovery, as well as treated in waste to energy facilities).
- HW03. Number of illegal HW trafficking cases]³.

Note on the Regional Plans on the POPs

With regards to POPs Regional Plan and Stockholm Convention provisions, since the timeframe for the reporting period have already passed, related information and indicators will correspond to the reports periodically submitted by the Mediterranean countries to the Secretariat of the SC

3. Selection and prioritization methodology of indicators presented in NAP update draft Guidelines

The list of indicators included in Annex E of NAP update guidelines (Document UNEP (DEPI)MED WG.394/4) is built based on the relevant:

- a) MAP effectiveness indicators adopted in COP 16
- b) MAP reporting system indicators adopted by COP 15
- c) MSSD indicators, 2005
- d) Indicators with regards to other relevant policy frameworks, mainly Horizon 2020 Initiative and IWRM (Integrated Water Resources Management)
- e) Indicators agreed in the framework of relevant MEA.

In general, official indicators are selected based on a thematic approach as it facilitates the connection with the target and legal and political processes, while providing a clear message to policy makers.

The above mentioned indicator list consisted of a spreadsheet with all the potential indicators with fields for Indicator code, Indicator title, Units, SAP/NBB sector, Link to ECAP/Regional plans targets, Link to other policy frameworks, Type of indicator (D = Driving force, P = Pressure, S = State, I = Impact, R = Response), Description, Data source, Criteria and Total.

The selection criteria used for the Sustainable Development Indicators of the United Nations Commission on Sustainable Development (UN-CSD) are:

- Conceptually well founded.
- Understandable (clear, simple and unambiguous).
- Based on data that is readily available or available at a reasonable cost, adequately documented, of good quality and updated at regular intervals.
- Within the capacities of the governments to implement, given logistics, time, technical and other constraints.

The Secretariat used the methodology developed by UNEP/MAP Plan Bleu-RAC consisting of the following criteria:

³ Pending study reservation to ensure that are fully in line with Basel Convention.

- a. Mandatory nature of the indicator within MAP framework.
- b. Relevance
- c. Measurability
- d. Cost effectiveness
- e. Understandable

The scoring used for each criteria is described below:

1. Mandatory nature: Non Mandatory=0; Overall objective (Mandatory but not legally binding)=1; Legally binding=2

- Legally binding indicators can be those related to requirements or measures established by the Barcelona Convention, Protocols, Regional plans adopted in the framework of Article 15 of the LBS Protocol.
- Overall objective: those indicators that track the achievement of a related objective/target, e.g. from non legally binding regional plans or SAP MED, ECAP indicators or MAP effectiveness indicators that have been adopted or approved by COP but are not strictly legally binding by themselves.
- Non mandatory indicators but smart and useful for assessment purposes.

2. Relevance: It is disaggregated into the following five single criterions:

a) Meaningful: it measures the degree to which the indicators meet its intended purpose in coverage, content and detail.

Not meaningful=0; More or less meaningful=1; Highly meaningful=2

- Highly meaningful: the indicator seems intuitively reasonable and it adequately reflects the objectives/targets or phenomenon which are intended to measure and is appropriate to the needs of the user or purpose.
- Partially meaningful: the indicator is related with objectives/targets or phenomenon which is intended to measure but it does not fully reflect them.
- Not meaningful: the indicators not related with the objectives/targets or it is not appropriate to the needs of the user or purpose.

b) Applicable to different scales: it measures the ability to be disaggregated/broken down into areas of particular interest, such as regional areas.

Applicable to a single scale=0; Applicable only to some scales=1; Applicable to different scales.

- Applicable to different scales: primarily national in scope but able to be disaggregated/broken down into areas of interest, e.g. regional areas. Allow international comparison as it is consistent with those used in international indicators programmes.
- Applicable only to some scales: limited ability to be disaggregated/broken down into areas of interest, e.g. regional areas.
- Applicable to a single scale: only able to be expressed in a single scale.

c) Conceptually sound: it measures the degree to which the information precisely describes the objective/target or phenomena it was designed to measure. The indicator should be specific, aligned

with the objectives/targets or phenomenon of interest and not with other non-related objective/target or phenomenon.

Not conceptually sound=0; More or less conceptually sound=1; Highly conceptually sound=2

- Highly conceptually sound: the indicator measurement is methodologically sound and fits conceptually for the purpose to which it is being applied. It is specific and fully aligned with the objectives/targets and not with other non-related objective/target or phenomenon.
- More or less conceptually sound: the indicator measurement is more or less methodologically sound and partially fits for the purpose to which it is being applied. It is moderately specific and partially aligned with the objectives/targets, it can be aligned with other non-related objective/target or phenomenon.
- Not conceptually sound: the indicator measurement is not methodologically sound and does not fit conceptually for the purpose to which it is being applied. It is unspecific and not aligned with the objectives/targets.

d) Responsive to change/sensitivity: it relates to how significantly an indicator varies according to changes in the objectives/targets or phenomenon.

Not responsive to change=0; More or less responsive to change=1; Highly responsive to change=2

- Highly responsive to change: the indicators respond relatively quickly and noticeably to changes, but not show false movements.
- More or less responsive to change: the indicators respond moderately slowly and noticeably to changes, and can show false movements sometimes.
- Not responsive to change: the indicators respond slowly to changes and show false movements frequently.

e) Useful to decision makers: the usefulness of indicators to decision makers is related directly to the ability to track trends over time with regards the objectives/targets or phenomenon which is intended to measure.

- Highly useful to decision makers: the indicator is related directly to the ability to track trends over time with regards the objectives/targets or phenomenon which are intended to measure.
- More or less useful to decision makers: the indicator is more or less related to the ability to track trends over time with regards the objectives/targets or phenomenon which are intended to measure.
- Not useful to decision makers: the indicator is not able to track trends over time with regards the objectives/targets or phenomenon which is intended to measure.

c) Measurable. It is disaggregated into the following two criteria:

- a) Based on data readily available: it relates to the degree to which data produced are up to date, published frequently and delivered to schedule.
- b) Data needs to be collected and reported regularly and frequently. There should also be minimal time lag between the collection and reporting of data, to ensure that indicators are reporting current rather than historical information.

Not available=0; Potentially available=1; Fully available=2

- Fully available: data is directly collected and reported regularly and frequently. There is a minimal time lag between the collection and reporting of data.
- Potentially available: data is not directly collected or reported regularly and frequently. Changes in regular surveys; arrangements with data 'owner'; improved handling of raw data; or shorter release time are needed.
- Not available: data is not available.

d) Cost-effective: it measures whether data are routinely collected either by national statistical services or through international processes.

Not available=0; Potentially available=1; Fully available=2

- Fully cost-effective: data are already collected routinely either by national statistical services or through international processes.
- Potentially cost-effective: data are not routinely collected but minor efforts need to be made for data collection and reporting.
- Not cost-effective: data are not routinely collected and costly efforts need to be made for data collection and reporting.

d) Understandable: it measures whether the indicator is intelligible and easily interpreted. Indicators should be sufficiently simple to be interpreted in practice and be intuitive in the sense that it is obvious what the indicator is measuring.

Not understandable=0; More or less understandable=1; Fully understandable=2

- Fully understandable: the indicator is intelligible and easily interpreted.
- More or less understandable: the indicator is more or less intelligible and interpreted with difficulties.
- Not understandable: the indicator is unintelligible and hardly interpreted.

For each indicator, a total score was deducted from 0 to 18, with a score of 18 meaning that the indicator perfectly meets all the criteria.

APPENDIX F. Information for Developing and Drafting the NAP

Example illustrating the process for developing pollution prevention and control measures regarding marine litter starting from defining quantifiable objectives and elaboration of midterm baseline conditions, to identification of gaps, ending with the selection of required measures to be included in the NAP

Requirement	Example
<i>SAP Requirement for solid waste</i>	By the year 2025 at latest, to base urban solid waste management on reduction at source, separate collection, recycling, composting and environmentally sound disposal
<i>Requirement of the Marine Litter Regional Plan</i>	Reduction of fraction of plastic packaging waste that goes to landfill or incineration without energy recovery by 2019
<i>Relevant ECAP state targets adopted in Decision 21.3</i>	Decreasing trend in the number of/amount of marine litter (items) deposited on the coast.
	Decreasing trend in the number/amount of marine litter items in the water surface and the seafloor
	Decreasing trend in the cases of entanglement or/and a decreasing trend in the stomach content of the sentinel species.
<i>Potential quantifiable objectives and operational targets</i>	(a) To reduce 20% fraction of plastic packaging waste that goes to landfills or incinerators without energy recovery by 2019. (b) To ensure that the fraction of plastic packaging waste that goes to landfill or incinerators without energy recovering decreases at a yearly rate of 5% till 2019.
<i>NAP Mid term Baseline conditions</i>	<ul style="list-style-type: none"> - No existing quantifiable target - Plans for the construction and management of landfills and incinerators in coastal areas - Policies that hold industries' liable to damages caused to the marine environment by plastic packaging missing - Policies that promote reduction of the amount of plastic used in packaging products or in the service sector do not address required aspects - Policies that promote the development of management schemes for plastic packaging waste not yet developed - Existing reports publicizing data and information on trends of marine litter in coastal areas and coastal waters
<i>Gaps/Issues</i>	<ul style="list-style-type: none"> - Lack of national/regional laws that address measures for reducing marine litter along the coastline - Lack of investment measures for the construction and management of landfills and incinerators in coastal areas - Lack of policies that hold industries' liable to damages caused to the marine environment by plastic packaging - Weak policies that promote reduction of the amount of plastic used in packaging products or in the service industry - Lack of funding and competencies to carry out monitoring activities for generation and disposal of plastic waste - Ineffective public awareness campaigns that address the risk

	<p>caused to human health and the environment as a result of marine litter entanglement or/and the stomach content of the sentinel species</p> <p>– Restricted public access to existing reports publicizing data and information on trends of marine litter in coastal areas and coastal waters</p>
<p><i>Potential measures for consideration in the NAPs to meet SAP/RP and GES targets</i></p>	<p>(a) Legal measures</p> <ul style="list-style-type: none"> ▪ Update industrial solid waste management law to integrate marine litter and plastic recycling ▪ Develop regulation regarding monitoring system for marine litter ▪ Enforce public access to data and information on pollutants discharges to the environment including marine litter ▪ Enforce the implementation of management schemes for plastic packaging waste <p>(b) Technical measures</p> <ul style="list-style-type: none"> ▪ Construct and operate two landfills for coastal waste disposal ▪ Establish municipal solid waste collection and segregation centre <p>(c) Policy-driven measures</p> <ul style="list-style-type: none"> ▪ Sign voluntary agreements with the Plastic industry to implement EPR ▪ Sign a voluntary agreement with supermarkets to reduce single use bags by 50% ▪ Support three public awareness campaigns every year to address the risk caused to human health and the marine environment by marine litter with special emphasis on the role of plastics and microplastics

Detailed outline and guidance information for drafting the updated NAP.

Following is a proposed table of contents for the updated NAP document with additional explanation on what each section should focus on:

- i) Preface
- ii) Executive summary
- iii) Introduction
 - Background on the national SAP-MED/NAP process.
 - Overview of achievements made in the 2004 NAP and challenges facing implementation of the updated NAP.
- iv) NAP updating process
 - Institutional arrangements.
 - Work methodology.
 - Involved stakeholders and public consultation.
- v) Development of the midterm implementation benchmark
 - Data and information on the baseline situation for each of the following sectors, categorized into policy framework, legal requirements and pollution prevention and control measures:
 - Municipal wastewater
 - Municipal solid waste and marine litter
 - Urban air pollution
 - Industrial aqueous effluents
 - Industrial air pollution
 - Hazardous wastes
 - Agricultural activities
 - Legal and institutional aspects of monitoring, enforcement, reporting, capacity building and public participation
- vi) Defining quantifiable objectives
 - List of the adopted quantifiable objectives or targets based on the requirements derived from the SAP-MED, the Regional Plans and the ECAP targets (Annex A). The list of quantifiable objectives is presented in line with the following SAP- MED priority sectors and substances:
 - Urban municipal wastewater
 - Urban Solid waste
 - Air pollution in urban areas
 - Persistent organic pollutants (POPs)
 - Heavy metals and organo-metallic compounds (Hg, Cd, Pb, Zn, Cu, Cr)
 - Organohalogen compounds (halogenated aliphatic and aromatic hydrocarbons, Chlorinated phenolic compounds and organo-halogenated pesticides)
 - Radioactive substances
 - Nutrients and suspended solids from industrial development
 - Hazardous wastes (obsolete chemicals, lubeoil and batteries)
 - Monitoring
 - Capacity building
 - Public participation
 - Reporting
- vii) Gaps analysis and identification of issues
 - Results of the gap analysis between the midterm baseline and the proposed targets or quantifiable objectives. Gaps to be presented as a list of issues, whereby each is categorized in line with the SAP- MED priority sectors and substances included in section (vi).

- viii) Prioritization of issues and identification of potential measures
 - Prioritized list of identified issues on a regional level in accordance with the methodology of assessment from the issue/impacts matrix (Annex C). The list is produced for each of the SAP- MED priority sectors and substances included in section (vi).
- ix) Selection of programme of pollution prevention and control measures
 - Selected options to address each of the identified issues for the management of land-based sources of pollution contributing to the pollution of the Mediterranean Sea. Actions/measures to be categorized according to policy and legal measures and technical measures, with emphasis on these requiring significant investments for implementation.
- x) Preparation of a Prioritized List of Investment Projects
 - Top 10 to 12 priority actions/measures which require significant investments are approached as priority national projects. For each of these projects, investments portfolios (IP) and project fiches are prepared.
- xi) Monitoring plan for NAP implementation
 - Information on the institutional arrangements, resources and competencies that the Country will employ to undertake the process for monitoring NAP implementation in order to fulfill the unified list of 21 MED POL indicators included in Annex E.
- xii) Capacity building plan for NAP implementation
 - Formulation of a plan that assigns responsibilities, resources and budgets required for training and capacity-building needs for the tasks to be undertaken for implementation of the NAP.
- xiii) Arrangements for public information, awareness raising and education
 - Arrangements to be introduced to ensure that information is disseminated to the public and to explain how awareness raising and educational campaigns will be organized and implemented.

Appendix G. Guidance on cost-effectiveness and cost-benefit analysis

Table of Contents

INTRODUCTION	2
1 SECTION I: DEFINITIONS OF THE KEY TERMS AND CONCEPTS.....	3
2 SECTION II: HOW DOES THE ECONOMIC ANALYSIS FIT IN THE NAP UPDATE PROCESS?....	5
2.1 TASKS UNDER THE SPECIFIC NAP STEPS	6
3 SECTION III: COST-EFFECTIVENESS AND COST-BENEFIT ANALYSIS OF MEASURES/ PROGRAMMES OF MEASURES	12
3.1 COST-EFFECTIVENESS ANALYSIS.....	12
3.2 COST-BENEFIT ANALYSIS	14
3.3 ASSESSMENT OF COSTS, VALUATION AND TEMPORAL ASPECTS IN CEA AND CBA	15
3.3.1 <i>Costing of measures</i>	15
3.3.2 <i>Valuation of non-market goods and services</i>	16
3.3.3 <i>Discounting</i>	19
3.4 CEA, CBA OR ALTERNATIVE TOOLS?.....	19
3.5 DATA LIMITATIONS, COMPLEXITIES AND UNCERTAINTIES.....	21
4 USEFUL REPORTS.....	23
5 LIST OF REFERENCES	24
6 FURTHER INFORMATION ON COST-EFFECTIVENESS AND COST-BENEFIT ANALYSIS	26
COST-EFFECTIVENESS	26
COST-BENEFIT ANALYSIS	27

Introduction

Following the commitment of the Contracting Parties to the Barcelona Convention to update the National Action Plans (NAPs) adopted under Article 5 of the LBS Protocol of the Convention and endorsement of the NAP update Guidelines¹ (main body) at the MED POL Focal Points meeting held in Athens in March 2014, the Secretariat proceeded with the work on finalization of the technical annexes to the Guidelines including a first draft of the guidance on the use of cost-effectiveness and cost-benefit analysis for selection of the programme of pollution prevention and reduction measures. The draft guidance on cost-effectiveness was reviewed by the by the MED POL FO meeting held on 18 – 19 December 2014 in Barcelona, and the changes recommended by the meeting are integrated in this Annex 4, Appendix G.

The principal objective of the NAP update is to identify and prioritize national programme of measures to achieve Good Environmental Status (GES) with regard to pollution-related ecological objectives under the ecosystem approach (ECAP) in the framework of the LBS Protocol and the Regional Plans adopted in line with Article 15 of the LBS Protocol.

In preparing this first draft of the proposed guidance document, the work of the Secretariat was based in particular on the large number of reports and extensive experience gained in this field in the framework of the EU Marine Strategy Framework Directive (EU MSFD) implementation. Moreover, the draft guidance document is strongly rooted in the previous work carried out under the UNEP/MAP system. This especially refers to the Plan Bleu's technical reports on economic and social analysis of the uses of coastal and marine waters in the Mediterranean and on application of different tools and approaches (e.g. cost-benefit analysis, cost of degradation) to economic analysis, as well as to the UNEP/MAP Background paper on Marine Litter Regional Plan. A number of publications discussing methodological issues and practical application of different economic analysis tools that might be particularly useful to NAP update teams are provided in chapter 4 of this document.

The overall goal of the guidance document is to assist the NAP update thematic groups, stakeholders and experts to perform cost-effectiveness (CEA) and/ or cost-benefit (CBA) assessments (or, alternatively, multi-criteria analysis) in prioritizing and selecting the NAP measures/ programmes of measures to achieve GES for pollution related ecological objectives and meet Regional Plans targets. More specifically, the document aims to contribute to:

- sound analysis to underpin the NAP update process and facilitate decision making by providing attainable levels of information (quantitative and/ or qualitative) on effectiveness, costs and benefits of proposed NAP measures;
- overcoming of data gaps and other constraints;
- consistency in the approaches and outcomes of the NAP update in different Contracting Parties (by e.g. providing definitions, advices and guidance on various aspects and components of CEA and CBA) while allowing for specificities in different countries to be taken into account;
- dissemination of knowledge acquired and lessons learnt through the application of these (CEA and CBA) methodologies in related process, in particular through the work of the UNEP/ MAP Plan Bleu and in the EU MSFD implementation;

¹ *Guidelines for Updating National Action Plans for the Implementation of the LBS Protocol and its Regional Plans in the Framework of the SAP-MED to Achieve Good Environmental Status for Pollution-Related ECAP Ecological Objectives*

- capacity building in the NAP update countries.

The guidance document has three main sections. Section one proposes a number of definitions of terms related to socio-economic analysis. Section two describes at which stages of the NAP update process it is needed to compile, organise and analyse different socio-economic data. Finally, section three provides details on the possible ways of assessing cost-effectiveness, costs and benefits of NAP measures/ programme of measures, discussing particularly important and challenging aspects of the analysis, choices that need to be made and ways to address expected data gaps.

1 Section I: Definitions of the key terms and concepts

For the purpose of this guidance document and the NAP update economic analysis, the following definitions/ terms are used²:

Use of marine waters: Any human activity using or influencing the marine space and/ or ecosystem goods and services provided by marine waters.

Ecosystem services: Goods and services – benefits – that the ecosystem provides to human beings.

Degradation: Reduction in the provision of ecosystem services compared to another state.

Cost of degradation/ socio-economic losses: Foregone welfare, reflecting the reduction in the value of the ecosystem services provided compared to another state.

Socio-economic analysis: A socio-economic analysis aims to identify the impact on human welfare of a given policy. This includes economic as well as social aspects, and may include consideration of the distribution of these impacts across stakeholders. In light of this definition, an explicit distinction between „economic“ and „social“ analysis is not necessary³.

Drivers: Factors (economic sectors and policy instruments) inducing the pressures (e.g. agriculture, fishing, subsidies, regulation).

Pressures: Forces that generate changes in the state of the ecosystem and thereby the provision of its services (e.g. nutrient load, salinity, fishing effort, oil spills, invasive species).

Impacts: Impacts are the consequences for human welfare caused by the drivers and pressures affecting the state of the marine environment.

DPSIR framework: a theoretical framework used for systematically analysing environmental problems on the one hand and identifying measures on the other hand. The DPSIR framework starts with a description of the Driving forces that cause environmental Pressures. These Pressures cause a change in

² Based on WG ESA Guidance document (2010), UNEP/MAP Plan Bleu's reports on economic and social analysis in the Mediterranean, costs of degradation, and methods and tools for socio-economic assessment of forest ecosystem goods and services (2014a, 2014b, 2014 c), Arcadis report (2014) and EC Impact Assessment Guidelines (2009).

³ The NAP update process primarily uses the term 'economic' analysis, however the intention was not to exclude social aspects but rather to simplify the process and used terminology (whereas it is understood that social issues are a constituent part of the analysis).

the State of the environment. This may have Impacts on human wellbeing. If these Impacts are unwanted, policy-makers will Respond by taking actions aimed at the Driving forces to reduce their Pressures.

The Driving forces are the activities, and the social factors driving these activities, that use the marine waters, either directly or indirectly, and consequently impact the marine environment. The use of marine waters puts Pressure on the marine environment in various ways. The pressures degrade the State of the environment, which Impact upon human health and the value of ecosystem goods and services. Society can decide to Respond by acting on the Driving forces, Pressures, State as well as the Impact of the problem by implementing measures and incentives (i.e. policy instruments).

Specific examples of what is in general understood under each element in the DPSIR sequence are provided below.

Driving forces	Pressures	State (of marine waters and ecosystems)	Impacts	Responses
Socio-economic activities (uses of marine waters) i.e. economic sectors such as tourism, industries, shipping, fisheries	Emissions/pollution loads, extractions, disturbances	E.g. deteriorating bathing water quality, raised concentrations of contaminants, declining fish stocks, etc.	E.g. loss of recreation value, negative impacts on human health, reduced revenues from fishing etc.	Policies and measures aiming to reduce pressures and impacts (e.g. pollution standards, fishing quotas) and to reach set objectives (such as GES)

Use value: The use value captures the direct link between ecosystem services and human welfare.

- Direct use value includes the profits from direct use of marine environment (“economic” value) and wider benefits that are more difficult to measure, since they are not captured by market interactions, for example recreational activities such as swimming, fishing, scuba diving etc., as well as the importance to local coastal communities of maintaining their marine heritage (“social” value).
- Indirect use value includes the benefits we derive from the environment’s provision of ecosystem services such as waste decomposition or carbon sequestration.

Non-use value: The non-use value describes, for example, the importance people attach to knowing that a healthy sea surrounds them and that this resource may be passed on to future generations.

Valuation: A set of steps/ methods performed in order to determine Total Economic Value (use and non-use values) of ecosystem goods and services that do not have a market price. Valuation can be applied to assess the overall value of ecosystem services or to assess economic value of changes in ecosystem services.

Costs: Costs of measures differ depending on their type⁴. In case of technical measures, additional costs of introducing new measures mainly consist of direct investment and operational costs. The costs associated with the policy instruments and their implementation are indirect costs and they include:

⁴ Definitions of the different types of measures are provided in the main body of the Guidelines.

- *Administrative costs* for the regulator: research, information and meeting costs, enactment and lobbying costs, design and implementation costs and administration, monitoring and prosecution costs. Most of these costs are costs of labour time for researchers, court staff, legislators, government staff etc.
- *Compliance costs* for the regulated: investment in abatement equipment or additional costs related to changed behaviour, administrative costs e.g. costs of applying for permits, monitoring costs;
- *External costs*: environmental and resource costs.

Benefits: The benefits from measures can be described by identifying use and non-use values. The use values can be separated into direct use values such as fishery production and recreation and indirect use values such as values of environmental functions or the effects on living conditions. Non-use values capture the less tangible values derived from the implementation of the measures (for example the values of preserving certain ecosystems for future generations).

Once identified, expected benefits (both environmental and socio-economic ones) associated with implementation of measures can be either fully monetised or (in cases large uncertainties are involved) given for illustrative purposes only. The monetization and/ or description of benefits normally requires to carry out a literature review of available studies in the area of the proposed policy and verify whether economic estimates can be adopted in that context. There are areas where economic benefits are easier to ascertain (for example financial savings associated with the proposal or recreational and tourism benefits) whereas for others it might be more challenging due to many scientific and economic uncertainties (e.g. ecosystem services valuation, health effects, etc.). It is good practice to explain at minimum in qualitative term what are the benefits associated with the measure in question.

Cost-effectiveness analysis (CEA): A decision support method which relates the costs of alternative ways of producing the same or similar outcomes to a measure of those resulting outcomes.

Cost-benefit analysis (CBA): A decision support method which aims to compare all relevant benefits and costs (in monetary terms) of an alternative (project, policy or programme), including impacts on environmental goods and services.

Multi-criteria analysis (MCA): A decision support method that can be used to evaluate and compare different alternatives according to their performance with regard to a selected set of evaluation criteria.

2 Section II: How does the economic analysis fit in the NAP update process?

The steps in the NAP update process have been recommended in the main body of the *Guidelines* (UNEP(DEPI)MED WG.393/10). Economic analysis, that is the compilation of data necessary to perform them and the very application of cost-effectiveness and cost-benefit assessments, will need to be carried out throughout the entire process, whereas the following NAP phases are particularly important:

- Step 1: assessment of the NAP midterm implementation benchmark;
- Step 4: prioritizing issues and identifying potential measures (based on *inter alia* socio-economic losses);
- Step 5: selection of the programme of pollution reduction measures (based on criteria that will include costs and benefits from their implementation, among others).

The role of the economic analysis and specific tasks that will need to be undertaken in each NAP update step are described below. The steps for which economic assessments are of major significance are paid special attention and elaborated in more detail. The economic analysis should be undertaken by the appropriate specialists in the NAP update teams and tightly linked to the other analytical segments, drawing from them, supporting them and/ or serving as a basis for their development.

The Contracting Parties may build on other policy processes where similar economic analysis methods and approaches have been used to support their NAP update processes to ensure coherence and effectiveness.

2.1 Tasks under the specific NAP steps

Step 1: Assessment of the NAP midterm implementation benchmark

Within the first step in the NAP update, measures implemented since the first NAP was adopted need to be described and the current baseline established. Following the establishment of midterm implementation benchmark, future trends in pressures and impacts also need to be described assuming the existing policies and measures.

In conducting this part of the analysis, the NAP update teams should also compile information on economic sectors and activities affecting marine environment and analyse them in a way as to establish what are the main uses of marine environment having in mind their significance in socio-economic and in terms of their environmental impacts. Two important tasks at this phase of the economic analysis are to: 1) identify and describe different uses of marine environment with related pressures and impacts; and 2) assess direct and indirect benefits from different uses. For both, description of current conditions and projection of trends is needed.

1. Identifying and describing different uses of marine environment; identifying and describing pressures from these uses and related impacts. The key questions that need to be answered are: what are the different human activities and their impacts on the coastal and marine environment? To the extent possible, all information should be quantified. Data on pressures and impacts should be acquired from thematic experts and consultants working on the analysis of policies, NBB preparation and other pollution related aspects of the assessment of NAP midterm implementation benchmark. Additional sources (such as national and regional statistics, analytical reports and studies) will be needed to compile information on specific socio-economic topics.

At this stage the following information is recommended to be taken over from the baseline description, amended as appropriate and organised in order to enable further steps in economic analysis:

- *number and size of settlements,*
- *quantities of treated and untreated municipal wastewater discharged into the sea/tributaries; municipal waste and principal disposal methods;*
- *number, size and type of industries having an impact on marine environment,*
- *quantities and type of industrial waste and wastewater generated (the disposal of which affects marine environment);*
- *extent of agricultural activities in the coastal area,*
- *fishing (e.g. size of the fishing fleet, total catches etc.) and aquaculture activities (areas used for aquaculture, production, etc.);*

- *tourism data accompanied with pressures and impacts from tourism;*
- *number and type of ports and related pressures;*
- *use of marine waters for energy generation, if any; etc.*

In addition to the description of existing conditions, a projection of pressures and impacts under the assumed continuation of existing policies and measures need to be made. The role of the economic analysis will be to provide a projection of expected changes in the uses of marine environment to allow for estimation of pressures and impacts. UNEP/ MAP Plan Bleu's report on economic and social analysis of the uses of marine waters in the Mediterranean (2014a) can be used as a good example of how to structure and organize socio-economic data. The report is also relevant for the assessment of benefits (described in the following paragraphs).

2. Making an inventory of, and to the extent possible assessing direct and indirect benefits of different uses of marine environment. This entails collection of data on e.g. revenues, turnover, gross value added, employment, direct and indirect contribution to GDP, etc. from different economic activities⁵. In cases when adequately disaggregated (e.g. gross value added from coastal industries; employment in coastal agriculture etc.) and quantified data will not be readily available, the NAP update teams/ consultants should make an effort to come up with closest possible approximations and/ or qualitative description of benefits with the overall aim to have a clear picture of the magnitude and significance of different economic sectors.

In addition to standard economic measures of benefits (such as figures on employment, revenues, etc.), it will be also necessary to consider less conventional measures of benefits provided by marine environment (such as goods and services provided by ecosystems). Since these do not necessarily have market value, there will be a need to carry out their valuation using some of the established techniques (discussed in more detail in section III of this document) or to rely on valuation studies, if existent, that have already assessed benefits provided by respective marine ecosystems. A growing number of such studies is available in different countries and they can serve as a valuable source to overcome data gaps and/ or avoid time and resource demanding assessments being carried within NAP update. In this phase of NAP update assessment, it will be necessary to identify and describe direct and indirect benefits and compile existing information from various sources, while as the valuation itself, when necessary and opted for, will be carried out at later stages of the analysis (e.g. for estimation of socio-economic losses and selection of measures under steps 4 and 5 of the NAP update).

In carrying out the two tasks (describing the human activities affecting the marine environment and the benefits deriving from it), it is recommended that the economic expert/s in NAP update teams follow the approach to determination of geographic scope⁶ applied in the NBB preparation and use the related data

⁵ The indicators that are most commonly used to assess socio-economic benefits/ use values from different sectors are value added, production value, income and employment.

⁶ The available guidance on MSFD implementation (e.g. WG ESA, 2010) highlights the importance of adequate definition of spatial, sectoral and temporal aspects. First of all, there is a need to define the size of the ecosystem, that is, to define the relevant borders of the ecosystem subject to the analysis. In the analysis one must also determine what economic sectors should be included in order to address the consequences of the problem as well as the policy responses. To include all sectors impacting on or being affected by the marine ecosystem services or all sectors affected by measures /policy instruments might not be practically possible or even justified. For practical reasons, focus might have to be restricted to capture the main sectors connected to the problem either as drivers or as those economic sectors affected by the impacts. The temporal aspect means addressing the following two questions: i) what are the dynamics of the system? and ii) how do drivers, pressures, and states change over time? The temporal

from identification and classification of pollution sources (with related emissions). Due to the complexity of marine environment and expected lack of (disaggregated) data, the teams performing the analysis are likely to face difficulties particularly in their efforts to link certain impacts to relevant pressures and sources. Useful advices on the challenging task of establishing causal relationship between the state of ecosystems and economic activities can be found, amongst others, in the UNEP/MAP Plan Blue's report on setting the scope for assessment of costs of degradation.

Discussion of future trends in pressures and impacts, as well as discussion of effects these may have on the benefits from different uses of marine environment, in the first step of the NAP analysis will need to include information such as what pollution loads are expected over time if there is no change in current policies and measures and what will be the related impacts. Examples of the questions that need to be answered through integration of the economic and other segments of the analysis (if possible in a quantified manner) include:

- will the existing industries (as well as tourism, population, agriculture, etc.) grow or decline and to what extent/ at what pace;
- what will it mean in terms of quantities of the main pollutants reaching marine waters, direct or indirect uses of marine ecosystems;
- what impacts will it have on the state of marine ecosystems; and
- what will be the resulting impacts (gains or losses) for human wellbeing.

These projections will not be an exclusive or even predominant responsibility of the economic expert/s in the NAP update teams, however it is very important that close cooperation and coordination with experts working on pollution reduction is ensured and that all available data and knowledge are mobilized to arrive at the best possible projection of trends.

This is pivotal for determination of gaps (difference between baseline and set objectives), which make a starting point for identification of potential (new) measures that are needed to bridge the gaps. Omissions and mistakes in one phase of the analysis are likely to be carried over into the next one, thus affecting (in a negative way) accuracy and usefulness of the overall assessment. When quantification of future pressures and impacts (as well as of expected changes in benefits) will not be possible, qualitative assessments should be made to give as detailed as possible picture of the likely developments in human activities affecting marine environment over time.

Step 2: Definition of quantifiable objectives and operational targets

The definition of objectives and targets will primarily rely on the commitments stemming from the ECAP-GES and Regional Plans in the framework of SAP-MED as well as on the national priorities. Nevertheless, it is important to consider socio-economic conditions and have in mind possible specific concerns when setting up the environmental targets. A good baseline description of economic sectors (uses of marine waters) and related benefits, with projection of trends (resulting from the 2 economic analysis tasks performed in the NAP update step 1) will be of a great use for objectives and targets setting.

scale of the socio-economic and environmental impacts of concern can be addressed through scenarios analysis. Understanding the dynamics of the ecosystem is vital in order to make scenarios as well as identify the appropriate policy responses.

Step 3: Identification of gaps/ issues

Identification of gaps between midterm baseline and set objectives/ targets and assessment of the ability of existing measures to bridge the gap will also entail analysis of economic factors (including financial and/ or fiscal ones) and issues that prevent achievement of desired objectives. For example, barriers relating to wastewater management that are found in many countries are low levels of water tariffs, which slows down development of wastewater collection and treatment systems. Similarly, uptake of cleaner technologies in coastal industries is frequently hindered by the fact that there are no instruments (such as tax alleviations, pollution charges) to incentivise or dis-incentivise their introduction.

Step 4: Prioritization of issues and identification of potential measures

Prioritisation of issues and identification of measures is another step in the NAP update process where economic analysis will play a very important role, as one of the envisaged criteria for prioritisation of issues are socio-economic losses that will ensue if the set objectives are not met and if there is deterioration in the state of marine environment. The role of economic analysis at this stage of the NAP update is to provide as precise as possible data on the extent of losses that can be expected if appropriate measures are not introduced to close the gap between baseline and GES targets.

The main task under this step is to describe in qualitative and, if possible, in quantitative terms the costs that are expected to occur if the status of marine waters and ecosystems deteriorates. According to the UNEP/ MAP Plan Blue's report (2014 b), to cost of degradation corresponds to a loss of welfare and can be assessed in different ways, e.g. through a foregone benefit, a loss of profits, the increase in production costs or rise of mitigation costs. The main challenges highlighted in the report include definition of the reference against which the degradation will be assessed, establishment of causal relationships and assigning a monetary value on impacts that result from environmental change.

Various approaches – ecosystem, thematic and cost-based approach – to estimating the costs of degradation have been developed and used, mainly in the context of the EU MSFD implementation (the main elements of the three approaches are presented in table 2-1). Experiences are also gained in non-EU countries, for example as a part of the Regional Governance and Knowledge Generation (ReGoKo) project⁷, and should be utilised to the greatest possible extent in the NAP update process.

Each of these approaches employs different valuation methods including qualitative, quantitative and monetary valuation. The assessments can be qualitative and quantitative in the sense that they can provide evidence of the types of ecosystem services that might be lost and the extent of that loss, without monetisation (e.g. assessment of a decline in fish stocks without assigning a value to the change).

Monetary valuation is a way of capturing people's valuation of the ecosystem services and is applied for services that are not traded and priced in any market. To be able to compute the economic value of environmental change influencing non-market ecosystem services, special valuation methods have been developed. Valuation methods fall broadly into two main categories: economic and non-economic. Each valuation technique has its advantages and disadvantages. Market data, cost-based data (including use of abatement costs) and the "production function approach" can elicit monetary values that have a strong foundation in robust data, but these methods cannot derive values that are not traded in any market.

⁷ Under the project, UNEP/MAP Plan Bleu supports activities on strengthening the knowledge base on the socio-economic importance of maritime activities in the Mediterranean basin and on the cost of degradation of the marine environment at national level. This initiative includes the development of socio-economic assessments of key maritime activities and of ecosystem service losses for selected Mediterranean countries.

Choice modelling and contingent valuation can capture more of the total economic value of an ecosystem service (particularly non-use values), but the theoretical foundation for these analyses has been questioned. A summary table of the *pros* and *cons* of various valuation techniques is provided in the section III, preceded with a more detailed explanation of different valuation methods.

Step 5: Selection of a programme of pollution reduction measures

Selection of a programme of pollution reduction measures is a crucial step in the NAP update where NAP teams will propose a set of the most needed and effective measures from the list of prioritised potential measures. The criteria of selection will include priority rank, ability to integrate with other measures, impact on marine environment, technical feasibility, implementation timetable as well as costs of implementation and cost-effectiveness/ cost-benefit ratios (or net present values). This is therefore the NAP update stage where CEA/ CBA will be used (to the applicable/ practicable extent). More details on why, how and when to apply CEA/ CBA (or use alternative tolls) are provided in Section III of this document.

Step 6: Development of NAP follow-up and reporting plan

A set of indicators that will be included in the NAP and the plan on how to follow-up and report on NAP implementation will also need to include data/ indicators from the economic analysis the countries will deem appropriate for monitoring and eventual updating of programme of measures. It is suggested that the NAP follow up plan includes recommendations on the main research needs and adjustments in the information and statistical systems to allow for better assessment of the effectiveness and sustainability of NAP measures.

Step 7: Drafting the NAP

The final step in the NAP update includes evaluation of the overall sustainability of the programme of measures and consultations, thus offering an opportunity to check rigorousness and consistency of the economic analysis once again. In the consultation phase in particular, principles and methods used in the economic analysis should be explained and results checked with a wide range of stakeholders. Any comments and suggestions regarding the estimation of costs and benefits (how realistic are they, have any significant omissions been made etc.) should be considered and integrated to the greatest possible extent in the final version of the NAP in a concise manner. The results of the economic analysis will help decision makers to include in the final NAP an effective and sustainable set of measures to achieve ECAP GES and Regional Plans targets in the framework of SAP-MED.

2-1: Approaches to estimating the cost of degradation, UNEP/ MAP Plan Bleu (2014b)

Key issues	The ecosystem services approach	The thematic approach	The cost-based approach
<i>Ways of addressing the costs</i>	The cost of degradation is defined as the difference in values of ecosystem services provided in two different situations: the Good Environmental Status (GES) and a “Business as Usual” (BAU) Scenario.	The cost of degradation is analysed through costs, expenses and losses of benefits incurred by degradation themes arising from current environmental situation compared to a reference status characterized by GES achievement.	The cost of degradation is analysed through current quantified spending for preventing further degradation in comparison to the current situation.
<i>Objective</i>	Communicate at an early stage on the potential lost benefits if an environmental policy is not implemented. Benefits of implementing the policy could also later on be compared with the costs of implementing it.	Assess current cost of degradation and compare them with a GES situation (extra-costs). Get an overview of current socio-economic impacts of environmental degradation. Provide a knowledge base to assess costs and benefits of future measures.	Get a quantified overview of current socio-economic impacts of environmental degradation. Inform on the financing structure for more appropriate decisions regarding who should bear future costs.
<i>Main steps (as defined by WG ESA)</i>	<ol style="list-style-type: none"> 1. Define GES using the qualitative descriptors listed in the MSFD. 2. Assess the environmental status in a Business As Usual (BAU) scenario. 3. Describe in qualitative and, if possible, quantitative terms the difference between the GES and the environmental status in the BAU scenario, i.e. the degradation of the marine environment. 4. Describe the consequences to human well-being of degradation of the marine environment, either qualitatively, quantitatively or in monetary terms. 	<ol style="list-style-type: none"> 1. Define degradation themes, e.g. marine litter, chemical compounds etc.; 2. Define a reference condition, for example a condition where targets for good environmental status are achieved; 3. Describe in qualitative and, if possible, quantitative terms the difference between the reference condition and the present environmental status, i.e. the degradation of the marine environment, for all the degradation themes; 4. Describe the consequences to human well-being of degradation of the marine environment, either qualitatively, quantitatively or in monetary terms. 	<ol style="list-style-type: none"> 1. Identify all current legislation that is intended to improve the marine environment; 2. Assess the costs of this legislation to the public and private sectors; 3. Assess the proportion of this legislation that can be justified on the basis of its effect on the marine environment (as opposed to health or on-shore environmental effects); 4. Add together costs that are attributable to protecting the marine environment from all the different legislation you have assessed.
<i>Example of costs considered</i>	If more fish were available in the sea, fishing quotas could be increased and fishermen could make X € more profits. Non-use values could also be increased.	Today X € are spent to mitigate the negative effects of water pollution on aquaculture.	Today X € are spent for less environmentally damaging anti-fouling materials and other technical measures built into ships to comply with the International Oil Pollution Compensation (IOPC) Fund

3 Section III: Cost-effectiveness and cost-benefit analysis of measures/ programmes of measures

The aim of this section is to:

- provide brief explanation of the tools and outline their possible uses;
- recommend practical steps in potential application of the CEA/ CBA in the NAP update process and suggest alternative approaches in case full scale economic assessments will not be doable; and
- provide more information on methodologies and particularly challenging aspects of conducting the CEA/ CBA and point out possible ways for overcoming the challenges.

More detailed formation on the CEA and CBA (with references to different sources) can be found in chapter 6 of this document.

3.1 Cost-effectiveness analysis

The cost-effectiveness analysis has been widely applied in evaluating different policy options and specific measures/ projects and an extensive literature on both the theoretical underpinnings of the concept and on the practical experiences and *pros* and *cons* of its applications is available.

CEA is an analysis of the costs of alternative individual and/ or sets or programmes of measures designed to meet a well specified/ quantified objective. It is often interpreted as a tool that helps find the least-cost solution for meeting a prescribed target (for example, how to attain a set level of nitrogen in coastal waters at least costs). The cost-effectiveness is calculated by dividing the annualised costs of the assessed measures/ sets of measures by a quantified physical effect. Marginal costs of different assessed options can, for example, be defined as the increase in total abatement costs when pollution loads are decreased by 1 ton or 1 kilogram per year. As long as marginal costs are not equal, it is possible to obtain the same level of pollution reduction at lower costs by shifting emission reduction from high cost to lower cost measures. CEA is normally used when it is difficult or impossible to express benefits from different measures in monetary terms.

In the steps 1 – 4 of the NAP update process, baseline will be defined, specific environmental objectives/ operational targets (e.g. reduction in nutrient inputs, bringing concentrations of contaminants below the levels giving rise to pollution effects, etc.) will be determined and potential measures to bridge the gaps between the baseline and target situations identified. Provided that the data is available and the national NAP teams deem it appropriate (within the step 5 of the NAP update), it is recommended to conduct a CEA for specific measures/ sets of measures by carrying out the following tasks:

1. Assess the effectiveness of these measures in reaching the environmental objective;
2. Assess the costs of these measures;
3. Rank measures in terms of increasing unit costs;
4. Assess the least cost way to reach the environmental objective/ target.

In case sufficient data will not be available for monetary expression of costs of all measures, the experiences with the implementation of the EU MSFD show that the use of qualitative and semi-

quantitative approaches is also possible and can give valuable results. Examples of several possible approaches are summarised in points a) to d) below.

- a) Collecting opinion of experts, civil servants and scientists (through workshop and interviews) on the contribution of each measure to the GES indicators. This approach is useful in situations when physical effects of potential measures can be identified but not quantified. An illustration referring to marine litter is presented below.

Measures	Effect
Additional fishing for litter	Negative effect: decreased seafloor integrity
Additional beach cleaning on non-bathing beaches (once a year)	Less litter on the beach
Adding individually recognisable markers to fishing nets and wires	Reduce illegal or improper spill of nets (the first source of litter on the beach)

- b) A scoring system can be applied to classify:

- expected reduction of different pressures for each measure, and
- the relation (and importance) of each pressure for each individual target (and indicator)

as low, moderate, high or very high, based on the set of pre-determined criteria. Multiplying the expected reduction in pressure with the importance of a pressure for a certain target gives the on-site effect for a certain measure (displayed on a scale 1 to 5). The pressures are then scored according to their geographic dimension using the same classes (low to very high). Multiplying the on-site effect and scale of the effect gives the overall effectiveness of the measure. The effectiveness scores are then compared with costs scores in a matrix form to allow for conclusion on the overall cost-effectiveness of measures. This approach is particularly useful to overcome the knowledge gaps regarding driver-effect-pressure relations.

- c) Environmental effectiveness of measures can be evaluated and classified (as strong, potentially strong, or uncertain) and compared with categories of implementation costs (low, moderate and high). Based on such an analysis, four levels of cost-effectiveness can be defined:
- cost-effective measures,
 - moderate cost-effective measures,
 - low cost-effective measures, and
 - non cost-effective measure.
- d) A 'scale' („+++” to „---”) system can be used to assess costs and effectiveness (and possibly other criteria including benefits, feasibility, etc.) of NAP measures when monetized assessments will not be possible.

It is recommended that NAP update teams consider using the approach of evaluating and comparing effectiveness and costs (example c) to categorise measures in terms of their overall cost-effectiveness. The advantage of the approach is its simplicity. On the other hand, its application leaves a large room for arbitrary assessments and efforts should be made in the NAP update process to reduce subjectivity (by e.g. conducting the assessment in a workshop setting and reaching an agreement of various stakeholders on the assigned categories, or by defining detailed criteria on how to evaluate effectiveness).

3.2 Cost-benefit analysis

CBA is a method for comparing policy measures against the baseline situation in terms of their advantages (benefits) and disadvantages (costs). This essentially involves estimating all of the negative and positive economic, social and environmental impacts. CBA can be done at various levels, depending on data availability. It can be either a full CBA when the most significant part of both costs and benefits can be monetised, or a partial CBA in cases when quantification/ monetisation will only be possible for a part of the costs and benefits. The results of this analysis can be interpreted as a benefit to cost (B-C) ratio (total benefits divided by total costs) where a ratio larger than one indicates that the policy measure is beneficial, or as a net present value (NPV - the present value of the net benefits) where a positive NPV indicates a welfare improvement.

When conducting a full CBA in the NAP update process will be deemed appropriate, the following steps are recommended (adapted from Turner et al, 2010):

1. Definition of the details of each measure/ set of measures subject to the analysis, including the 'do nothing' option (i.e. projection of trends in pressures and impacts without analysed intervention/s).
2. Determining the spatial and temporal scales of the analysis (i.e. over what population is it appropriate to sum the costs and benefits and over what time period do the costs and benefits arise?).
3. Identification of the costs and benefits and their monetary values. Monetary value may be based on the market value of a good or service or on its replacement cost (if that can be calculated), or, in the case of some environmental goods and services, by use of various valuation techniques. To enable valid comparisons, all monetary values must refer to a common point in time – the base year – to give 'present' values. A standard discount rate is applied so that costs and benefits of measures with varying time scales can be compared (some considerations to support the choice of discount rate are provided in sub-section 3.3.3).
4. Compare the economic efficiency of various options through comparison of their benefit-cost ratios or net present values.

If the resources would permit it, it is also recommended to carry out a sensitivity analysis to assess the impact (on the benefit cost ratio and/ or net present value) of changes in the values of central parameters, e.g. the value of costs and benefits or the discount rate. By examining the impact that increasing costs (or reduced benefits) may have on the net present value, the breakeven point can be determined whereby the assessed option would be no longer justifiable.

It is preferred that the costs and benefits are expressed in monetary terms, but this is not a requirement to call an analysis a cost-benefit analysis. In cases full monetisation will not be possible, a qualitative description of costs and benefits could be performed instead to meet the needs of the NAP update and aid the decision making process.

Specific examples of the application of cost-benefit analyses are available from the UNEP/MAP Plan Bleu's (2014c) and Arcadis (2014) reports. The Plan Bleu's report is particularly valuable as it describes in detail concrete steps and methods that need to be applied at each CBA stage with an illustration for a project-level analysis (example of CBA for an afforestation project is provided). A limited number of examples from applying CBA in the framework of the EU MSFD implementation is also available.

3.3 Assessment of costs, valuation and temporal aspects in CEA and CBA

Three very important and challenging aspects in conducting CEA and/or CBA are related to techniques and approaches used to assess the costs of measures, include values for non-market goods and services and to allow for comparison of costs and benefits that occur at different times. The following sub-sections provide more information and the main guidance points for each of these.

3.3.1 Costing of measures

The main question to be answered in costing of potential NAP measures (as an input for CEA/ CBA or criteria for prioritisation of measures) is how much the implementation of the given measure costs the society (in terms of public and private costs). To answer this question, nature of the given measure needs to be determined and its breakdown into basic components and/ or inputs needed for implementation provided. Different types of measures require different types of input to be implemented, and these inputs are fundamental for costing i.e. for estimation of costs.

- Technical measures: some benchmarks or indicators usually exist for concrete interventions with tangible results (covering investment and operational costs). For example, feasibility studies may have been carried out for WWTP in a given region of the country and unit costs per population equivalent can be derived and used for similar projects/ measures. Alternatively, some international costing methods could be applied⁸, while for example using Purchasing Power Parities to adjust the costs to national circumstances. Waste management strategies can be also a useful source of information for the assessment of costs as they may include information on e.g. number of improper waste disposal sites in the coastal region the remediation of which is needed and a number of landfills to be constructed with estimation of costs. Other national plans may be a useful source of information on costs and contain e.g. information on number of industries in which technological changes are needed to address contaminants, scale of investments needed and similar. UNEP MAP Background document on marine litter regional plan (2013) and indicative costs provided therein on e.g. clean-up costs (per km of coast cleaned, per person to control litter, costs associated with fishing gear retrieval etc.) could be used for the assessment of costs of marine litter management measures.
- Legislative measures – the time needed to draft the laws and administer them are the main cost elements for this type of measures. Private costs (i.e. costs to entities to which the regulation applies) can be assessed by translating legal provisions into specific requirements needed to comply with the law and by estimating their costs.
- Policy instruments – tax breaks to stimulate introduction of cleaner technologies will have a clear cost for the national (regional and/ or local) budgets in terms of public revenues forgone. In addition to that, some indirect costs will incur relating to additional work of civil servants needed to administer the scheme. Introduction of economic instruments (e.g. pollution taxes and/ or charges, deposit-refund systems and similar) will also have a distinct cost linked to administration and enforcement (work of relevant tax and other public services, perhaps environmental funds, to collect the revenues, costs of monitoring the discharges, work of inspectorates to enforce the regulation etc.).

⁸ UfM report *Update priority investment projects for protecting the Mediterranean Sea from pollution: evaluation of NAP investment portfolio – regional analysis*, for example, assessed investment costs of priority wastewater projects by using cost functions developed by COWI under FEASIBLE model whereas an adjustment (reduction) of 80% was applied for Southern Mediterranean countries.

- Capacity building and awareness raising measures can be costed by e.g. determining how many people need to undergo training courses, take part in study visits and similar. Public campaigns costs can be assessed by breaking down the measures into type of communication materials, media time, work of specialized consultants etc.

A more difficult part of the analysis will be estimation of costs/ losses that would be incurred to the economy and society if the degradation is allowed (due to continuation of current measures and policies or under 'no measures' assumption) since these estimates include both use (direct and indirect) and non-use values.

As regards the benefits, the main questions are: How to quantify benefits? Is it always possible? How to provide for monetary expression of certain benefits that are expected to be generated by identified measures⁹? How do we value achievement of good ecological status yet make sure the estimates are not arbitrary? Answers to some of these questions can be found through the use of techniques and approaches that are not always straightforward, are somewhat sensitive and frequently disputed (such as valuation of non-market goods and services and discounting – briefly discussed in the following sub-sections).

3.3.2 Valuation of non-market goods and services

Costs of positive and negative changes in an ecosystem as well as benefits from implementing certain measures can be captured through valuation of ecosystem services and products. The UNEP/ MAP Plan Bleu report (2014c) is a useful source of information on valuation as it presents the basic concepts and describes selected valuation methods (market price, cost based, hedonic pricing, travel cost as well as stated preferences and other methods).

In order to understand the value of an ecosystem it is necessary to characterise and quantify the relationships between ecosystems and the provision of ecosystem services, and to identify the ways in which these impact on human welfare. Contributions to human welfare i.e. benefits from ecosystem services can be translated into economic value using economic valuation techniques. To arrive at economic value of changes in ecosystem services, the following steps are recommended (based on Defra, 2007):

1. Establish the environmental baseline;
2. Identify and provide qualitative assessment of the potential impacts of measures on ecosystem services;
3. Quantify the impacts of measures on specific ecosystem services;
4. Assess the effects on human welfare;
5. Value the changes in ecosystem services.

Valuation is the last stage of an often detailed assessment of the impacts on ecosystem services arising from a given measure/ set of measures or policies. As already mentioned, there are two types of valuation methods: economic, which is consistent with use in a cost-benefit analysis context, and non-economic (deliberative and participatory methods). The concept of total economic value (TEV) consisting from use and non-use values with different sub-categories is presented in figure 3-1 as it is important for understanding and comparing different valuation methods.

⁹ For example, how much will BOD₅ emissions be reduced if certain measure is implemented and what benefit will it generate for the marine ecosystems and society.

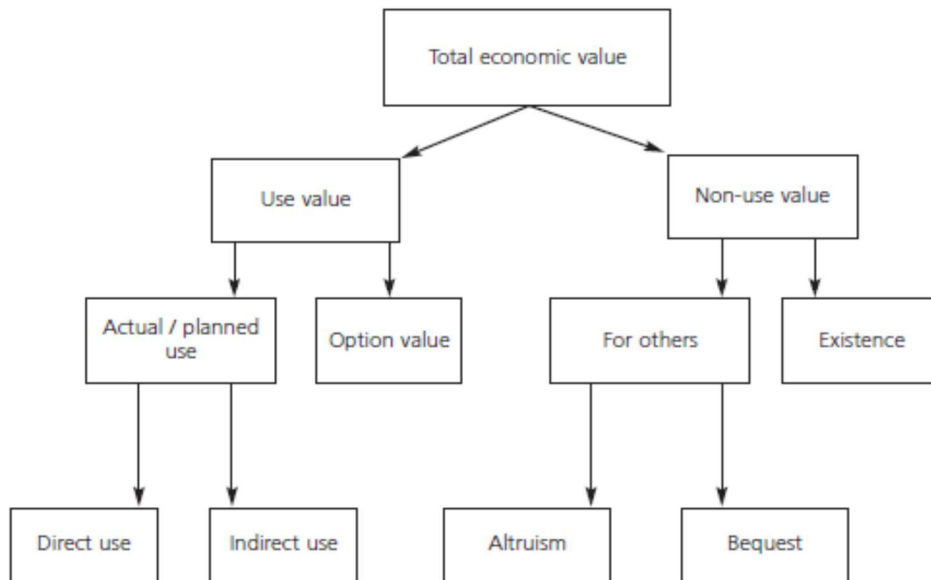

Figure 3-1: Total economic value framework, Defra, 2007

Economic valuation methods attempt to elicit public preferences for changes in the state of the environment in monetary terms. The main types of economic valuation methods available are Revealed Preference and Stated Preference methods.

Revealed Preference (RP) methods rely on data regarding individuals' preferences for a marketable good which includes environmental attributes. These techniques rely on actual markets. Specific techniques falling into this group are: market prices, averting behaviour, hedonic pricing, travel cost method, and random utility modelling. Market prices and averting behaviour can also be classified under pricing techniques¹⁰.

Stated Preference (SP) methods use carefully structured questionnaires to elicit individuals' preferences for a given change in a natural resource or environmental attribute. In principle, SP methods can be applied in a wide range of contexts and are the only methods that can estimate non-use values which can be a significant component of overall TEV for some natural resources. Contingent valuation and choice modelling are the main SP techniques used.

An indicative applicability of these methods in the context of specific categories of ecosystem services is presented in the table 3-1 which at the same time provides information on benefits and limitations of different approaches.

¹⁰ Pricing approaches use observed market prices either as direct measures of economic value of an ecosystem service (e.g. market prices, avertive expenditure, damage costs avoided) or as a proxy for the value (referred to as cost-based approaches). Cost-based approaches to valuing environmental goods and services consider the costs that arise in relation to the provision of environmental goods and services, which may be directly observed from markets such as: opportunity cost; cost of alternatives, and replacement costs. However, as these methods are based on costs, they do not strictly measure utility (and are therefore not included under the TEV framework), that is, they are non-demand curve methods and need to be used with care.

Table 3-1: Choice of valuation methods, Defra, 2007

Valuation method	Element of TEV captured	Ecosystem service(s) valued	Benefits of approach	Limitations of approach
Market prices	Direct and indirect use	Those that contribute to marketed products e.g. timber, fish, genetic information	Market data readily available and robust	Limited to those ecosystem services for which a market exists
Cost-based approaches	Direct and indirect use	Depends on the existence of relevant markets for the ecosystem service in question. Examples include man-made defences being used as proxy for wetlands storm protection; expenditure on water filtration as proxy for value of water pollution damages	Market data readily available and robust	Can potentially overestimate actual value
Production function approach	Indirect use	Environmental services that serve as input to market products e.g. effects of air or water quality on agricultural production and forestry output	Market data readily available and robust	Data-intensive and data on changes in services and the impact on production often missing
Hedonic pricing	Direct and indirect use	Ecosystem services that contribute to air quality, visual amenity, landscape, quiet i.e. attributes that can be appreciated by potential buyers	Based on market data, so relatively robust figures	Very data-intensive and limited mainly to services related to property
Travel cost	Direct and indirect use	All ecosystems services that contribute to recreational activities	Based on observed behaviour	Generally limited to recreational benefits. Difficulties arise when trips are made to multiple destinations.
Random utility	Direct and indirect use	All ecosystems services that contribute to recreational activities	Based on observed behaviour	Limited to use values
Contingent valuation	Use and non-use	All ecosystem services	Able to capture use and non-use values	Bias in responses, resource-intensive method, hypothetical nature of the market
Choice modelling	Use and non-use	All ecosystem services	Able to capture use and non-use values	Similar to contingent valuation above

Non-economic valuation – deliberative or participatory – approaches¹¹ tend to explore how opinions are formed or preferences expressed in units other than money. The decision on the choice of valuation methods does not need to be eliminatory (economic or non-economic). Instead (depending on the context) a combination of the two can be applied.

¹¹ Include qualitative semi-structured surveys, group deliberative discussions (such as focus groups or deliberative forums), citizens' juries, health-based approaches (such as quality-adjusted life years or health-year equivalents) and others.

3.3.3 Discounting

Discounting is a method used to value at the same date economic flows and stocks which have originated in different points in time. Discount rate is the rate used for discounting future values to the present. In cost-benefit analysis, there is a distinction between a private and a social rate of discount. A private rate of discount reflects the time preference of private consumers; a social rate is based on the government's view, which can be more long-sighted as it attempts, in most cases, to take into account the welfare of future generations (WATECO, 2003).

The discount rate used may have a significant impact on the outcome of the analysis, as it affects the value of future costs and benefits. Since benefits usually occur quite some time after measures are taken the temporal weight of these, given by the discount rate, will have a significant effect on the benefit side in a cost-benefit analysis. Since present values of future benefits becomes less the further ahead in the future they occur, assuming a positive discount rate, a hyperbolic discount rate is used in some cases. A hyperbolic discount rate implies a discount rate that is decreasing between different time periods (an example used by WG ESA in their 2010 Guidance document is provided in the table below).

Time horizon	Discount rate
0-10 years	3 %
10-30 years	2 %
30-75 years	1 %
> 75 years	0.5%

By using a hyperbolic discount rate the benefits occurring far into the future are given a relatively larger weight, than if a constant discount rate had been used. This might be justified by the fact that uncertainty increases as the impacts of projects occur further into the future.

Since any level of discount rate used will be questioned, a sensitivity analysis with regard to the discount is recommended to be applied in any assessment. It is also recommended to provide an explanation on the motivation behind the specific choice of discount rate.

3.4 CEA, CBA or alternative tools?

When evaluating different policy options, measures or projects, the economic analysis normally looks at two questions: i) is a given objective worth achieving, and ii) if yes, what is the most cost-effective way of achieving it. Cost-benefit analysis is used to address the first question while the second one can be answered by applying the cost-effectiveness analysis.

Another way of making the choice of using the CEA or CBA is to look at the nature of the question that is being analysed. If the task is meeting some environmental standard, complying with a law or achieving a target, then CEA is the appropriate course of action. If the question is one of choosing between a number of different possible policy or project options which do not involve compliance with standards or targets, then CBA is the most appropriate assessment tool.

Further questions to be considered in determining whether to undertake a CEA are:

- Have functional relationships between measures, pressures and impacts been described?
- Is the socio-economic data collected in the first step of the NAP update sufficient to allow a cost-effectiveness assessment?
- What are the gaps in information and what actions are needed to fill the gap?

While as CEA can help to prioritise measures, its limitation is that the estimation of costs for the application of this tool does not consider the full socio-economic and environmental impacts. The effectiveness assessment is based on the contribution of a measure to a specific target and not the full range of benefits. Another important limitation of CEA is to do with the assessment of the effectiveness of combination of measures.

CBA can provide a very useful and reliable input into the decision-making system, provided that it is carried out fully and impartially. However, translating all the costs and benefits of a project, policy or management scenario into monetary terms can be impractical or it may not give useful results. It should be remembered that CBA only provides an aid to decision making and that the option providing highest benefit per unit cost may not be the most appropriate on other grounds. In these situations multi-criteria analysis (MCA) can provide an alternative as it permits the inclusion of non-monetary criteria into the assessment and explicitly allows for stakeholder deliberations and dialogue.

Multi-criteria analysis (MCA) is a decision support method that can be used to evaluate different alternatives (e.g. different policy options) according to their performance against a selected set of evaluation criteria. These performances are presented in a so called performance matrix, or consequence table. MCA applies cost-benefit thinking to cases where it is necessary to deal with impacts that are a mixture of qualitative, quantitative and monetary data and where are varying degrees of certainty.

The main steps of MCA, as recommended in the UNEP/MAP Plan Bleu's report (2014 c), are:

Step 1: Establish the aims of the MCA, the decision makers and other stakeholders

Before starting the MCA, it is crucial to clearly define the objective of the MCA (why it is done) and to define who should be involved in the MCA process (e.g. decision makers and other stakeholders).

Step 2: Identify alternatives

After the objectives and the stakeholders are identified, the alternatives (e.g. alternative management approaches, measures or similar) to be evaluated should be listed.

Step 3: Define the criteria (and the corresponding objectives) that reflect the relevant consequences of each option

Defining the criteria is a crucial part of the MCA. The selected criteria should reflect all the important characteristics of the evaluated alternatives.

Step 4: Describe the performance of each alternative against the criteria in the performance matrix and determine the score matrix (scoring)

Before the scoring can be performed, all evaluated alternatives should be described, with regards to the selected criteria. These descriptions should be done in a neutral and objective way, not to influence the evaluation process.

Step 5: Assign weights to each of the criteria to reflect their relative importance (weighting).

This step introduces the relative importance of the criteria, and thus adds another dimension to the evaluation process. The users involved in a MCA may not only differ in their judgment of the performance on criteria, but also in the relative importance they attach to different criteria).

Step 6: Combine the weights and scores for each of the options to derive overall values.

Step 7: Analyse the results

Based on the obtained results, recommendations can be made regarding which alternative would be the best (overall) or which performs best on a single criterion.

The following strengths and weaknesses of multi-criteria analysis have been identified:

Strengths	Weaknesses
<ul style="list-style-type: none"> • Enables taking into account impacts that are not easily given monetary values. • Facilitates stakeholder involvement. • Makes the appraisal and decision-making process more transparent. 	<ul style="list-style-type: none"> • No built-in standard value, as it applies values (criteria and weights) specific to the evaluated option. • Comparisons between studies with different valuation criteria and weights are very limited. • Requires well developed participation processes and strongly depends on stakeholder willingness to participate.

In case the countries will choose to apply MCA to support selection of the programme of measures, the analysis itself will be conducted in the step 5 of the NAP update. Some elements of the MCA will however need to be determined in earlier NAP phases (e.g. alternatives to be assessed will in fact be determined in the NAP step 4 when potential measures will be identified).

3.5 Data limitations, complexities and uncertainties

Complexities of marine environment¹² pose numerous difficulties for assessing the cause-effect relationships between pressures, impacts, state and related socio-economic losses or gains. This in turn makes the assessment of effectiveness and benefits of different measures more complicated. In a cost-effectiveness analysis, for example, effectiveness can be either assessed by looking at a pressure (tons of emissions reduced) or an impact (avoided damage or improvements in environmental quality). Which of the two is applicable depends on how the objectives (which the assessed measures are set to achieve) are defined. In practice, most assessments tend to focus on pressures, since they are less challenging to measure and since the causality between measures and effects is easier to establish.

Lack of data and uncertainties due to complexity of marine environment, insufficient monitoring and information systems in many of the countries that will perform NAP update as well as other factors are expected to affect significantly economic analysis and possible application of CEA and CBA. Nevertheless, these limitations should not be used as a justification not to conduct the analysis and every effort should be made to apply the logic and elements of cost-effectiveness and cost-benefit assessments in determining programmes of pollution reduction measures and to utilise to the greatest possible extent potential of these tools.

Available studies and reviews show that carrying out full scale CBA and monetising all the costs and benefits is a significant challenge but at the same they provide examples of good practices in overcoming such challenges. These can provide ideas and point out to useful practices for the development of the NAP economic analysis.

¹² Including for example the following facts: the seas are an open access resource; there are transboundary effects and mixing/ accumulation of pollutants and impacts; there are gaps in scientific knowledge on the dynamics of marine ecosystems and their reaction to external stresses; and similar.

To address data gaps, the NAP update teams need to make sure that all the useful sources of information are identified in the beginning of the process including in particular any information on non-economic uses of marine waters, non-use values, correlations between drivers, pressures and state/ impacts. Available data should be used in the best possible way and a pragmatic approach should be employed, while setting the basis for more comprehensive analyses in the future. Usage of a mix of quantitative and qualitative data and expert judgments is strongly encouraged in all the cases when full quantification will not be possible.

The following simple recommendations drawn from the existing experiences with similar types of the analysis can be useful:

- Start preparations early;
- Identify all relevant national sources and studies; identify comparable regional/ international sources and examples;
- Know (agree upon) what role will the economic analysis have in the decision making process;
- Assess available data and decide on appropriate tools to be used;
- Organise data in the manner that will allow consequent steps in the analysis (e.g. develop a database of measures with uniform data on costs and effects of measures)
- Identify any areas where new assessments/ data collection is necessary having in mind time and resource limitations;
- Try to keep the analysis simple, focusing on the main pressures and impacts;
- When quantification is not possible, use qualitative approaches;
- Identify research needs and adjustments in the monitoring and statistical systems for the future.

It is also strongly recommended to the NAP update teams to note down any gaps in knowledge, lack of data, and uncertainties that will be faced in the process, to explain clearly assumptions and approximations made, and to discuss possible effects all of these may have on the deployed methodologies and obtained results.

4 Useful reports

European Commission DG ENV (2010). WG ESA: Economic and social analysis for the Initial assessment for the marine strategy framework directive: a guidance document [*Provides a comprehensive overview of issues relevant for the EU MSFD Implementation most of which are highly significant for the NAP update too. The most relevant topics covered include economic and social analysis of the use of marine waters; cost of degradation; and valuation methods*]

Plan Bleu (2014a), Economic and social analysis of the uses of the coastal and marine waters in the Mediterranean, Characterization and impacts of the Fisheries, Aquaculture, Tourism and recreational activities, Maritime transport and Offshore extraction of oil and gas sectors, Technical Report, Plan Bleu, Valbonne, available from: www.planbleu.org [*Report prepared in the context of implementation of the MAP Ecosystem Approach Initiative EcAp; it analyzes fisheries, aquaculture, tourism and recreational activities, maritime transport and offshore exploitation of oil and gas at the scale of the Mediterranean basin as well as at a sub-regional level. Production and socioeconomic indicators are presented for each sector*]

Plan Bleu, ACTeon (2014b), Scoping study for the assessment of the costs of degradation of the Mediterranean marine ecosystems, Technical Report, Plan Bleu, Valbonne [*Discusses the relevance of different assessment methods that can be applied for assessing the costs imposed on society by the current state of degradation of the Mediterranean marine & coastal ecosystems*]

Plan Blue, EFIMED and CTFC (2014c) Methods and tools for socio-economic assessment of goods and services provided by Mediterranean forest ecosystems, Technical Report, Plan Bleu, Valbonne [*Provides useful information on the theory behind valuation methods, cost-benefit and multi criteria analysis together with concrete examples on the application of these tools and methodologies*]

Arcadis (2014), Background document summarising experiences with respect to economic analysis to support member states with the development of their programme of measures for the Marine Strategy Framework Directive [*Prepared in the framework of WG ESA activities, contains discussion of the concepts and practices from different Member States (including ongoing work) on the role and approach of economic analysis in the EU MSFD PoM development*]

European Commission (2003). WATECO Guidance document n.o. 1. Economics and the environment [*Contains information on the methodological tools for undertaking the economic analysis and on preparations for conducting the cost-effectiveness analysis*]

5 List of references

1. Arcadis (2014). Background document summarising experiences with respect to economic analysis to support member states with the development of their programme of measures for the Marine Strategy Framework Directive. Report prepared for the EC DG Environment, Working group on economic and social assessment (WG ESA)
2. Defra (Department for Environment, Food and Rural Affairs) (2007). An Introductory Guide to Valuing Ecosystem Services. London: Department of Food and Rural Affairs.
3. European Commission (2003). Common Implementation Strategy for the Water Framework Directive (2000/60/EC). Guidance document n.o. 1. Economics and the environment. The implementation challenge of the Water Framework Directive. Available online: <http://ec.europa.eu/environment/water/water-framework/economics/pdf/Guidance%201%20-%20Economics%20-%20WATECO.pdf>
4. European Commission (2009). Impact assessment guidelines. Available online: http://ec.europa.eu/smart-regulation/impact/commission_guidelines/commission_guidelines_en.htm
5. European Commission (2014). Programmes of measures under MSFD; Recommendations for establishment / implementation and related reporting, Draft, 27 May 2014
6. European Commission DG ENV (2010). Working group on economic and social assessment (WG ESA): Economic and social analysis for the Initial assessment for the marine strategy framework directive: a guidance document
7. Goerlach, B. Interwies, E and Newcombe, J. (2006). How are we performing? The Role of ex-post Cost-Effectiveness-Analyses in European Environmental Policies. Paper presented at the 2006 Berlin Conference on the Human Dimensions of Global Environmental Change
8. Joint Research Centre of the European Commission (2013). *Research needs with regard to the socio-economic analysis under the Marine Strategy Framework Directive*; Report from the workshop held in October 2013 under STAGES (Science and Technology Advancing Governance of Good Environmental Status) project
9. Plan Bleu (2014a). Economic and social analysis of the uses of the coastal and marine waters in the Mediterranean, Characterization and impacts of the Fisheries, Aquaculture, Tourism and recreational activities, Maritime transport and Offshore extraction of oil and gas sectors, Technical Report, Plan Bleu, Valbonne
10. Plan Bleu, ACTeon (2014b). Scoping study for the assessment of the costs of degradation of the Mediterranean marine ecosystems, Technical Report, Plan Bleu, Valbonne

11. Plan Blue, EFIMED and CTFC (2014c). Methods and tools for socio-economic assessment of goods and services provided by Mediterranean forest ecosystems, Technical Report, Plan Bleu, Valbonne
12. Renda, A. Schrefler, L. Luchetta, Giacomo, L. Zavatta, R. (2013) Assessing the Costs and Benefits of Regulation, Study for the European Commission, Secretariat General; Final report
13. Turner, R. Hadley, D. Luisetti, T. Lam, V. and Cheung, W. (2010). Socio-economic assessment within a marine strategy framework. London: Department for Environment, Food and Rural Affairs. Available at: <http://www.defra.gov.uk>
14. UNEP/ MAP (2013), Background Document on Marine Litter Regional Plan Measures and Indicative Cost Estimation of Measures Implementation (UNEP(DEPI)/MED WG.387/Inf.13)

6 Further information on cost-effectiveness and cost-benefit analysis

Cost-effectiveness

Elaboration of the concept and possible application	Source
<p>CEA is used to establish the “least cost solution” to achieve a certain predetermined output. A CEA is an analysis of the costs of alternative individual and/ or sets or programmes of measures designed to meet well specified objective (quantified in physical terms). It can be used to identify the highest level of a physical benefit given available resources (e.g. delivering the maximum reduction in risk exposure subject to a budget constraint), as well as the least-cost method of reaching a prescribed target (e.g. a given concentration level of nitrogen in coastal waters at least costs).</p> <p>CEA is used when measurement of benefits in monetary terms is difficult, or in any other case when any attempt to make a precise monetary measurement of benefits would be redundant due lack of scientific evidence and/ or open to considerable dispute, or where associated uncertainties are high. In the case of multiple objectives a more sophisticated weighted CEA is required, which gives weights to objectives to measure their priority scale.</p> <p>In a CEA, the focus lies in first instance on the direct costs¹³ i.e. the cost of investment and operation associated with the implementation of measures. However if the measure is a policy instrument, an estimation would be necessary of the indirect costs as well. Typically a CEA mainly looks into the financial compliance costs; sometimes a rough estimation of (part of) the administrative costs is made but external costs are rarely known and usually not used.</p>	<p>Arcadis report, 2014</p>
<p>The purpose of a cost-effectiveness analysis is to find out how predetermined targets, e.g. threshold values for nutrients or other pollutant loads in a catchment/ coastal waters can be achieved at least cost. Theoretically speaking, the least cost allocation of pollution abatement strategies is found if the marginal costs of the proposed measures are equal. The marginal costs of these abatement measures can for example be defined as the increase in total abatement costs when pollution loads are decreased by 1 ton or 1 kilogram per year. As long as marginal costs are not equal, it is theoretically possible to obtain the same level of pollution reduction at lower costs by shifting emission reduction from high cost measures to lower cost measures.</p>	<p>Turner et al, 2010</p>
<p>A cost-effectiveness analysis seeks to find the best alternative activity, process, or intervention that minimises resource use to achieve a desired result. An <i>ex-ante</i> CEA is performed when the objectives of the public policy have been identified and an analyst or an agency has to find the least cost-option of achieving these objectives. The cost-effectiveness of a policy option is calculated by dividing the annualised costs of the option by a quantified measure of the physical effect, such as animal or plant species recovered,</p>	<p>Goerlach et al, 2006</p>

¹³The direct cost is the cost of investment and operation associated with the implementation of measures. Indirect costs are costs associated with the policy instruments and their implementation and the policy’s impact on other environmental targets and on other sectors in the economy.

<p>tons of emissions of a given pollutant reduced, kilometres of river length restored, and so on. In this context, the effects of a policy can be both reduced pressures (for example, the least-cost option to reduce CO₂ emissions), or avoided impacts (for example, the cheapest way to keep global warming below 2°), where the latter is usually more difficult to assess. Different options that achieve/ have achieved the same effect are then compared based on their cost. CEA, therefore, does not ask, nor attempts to answer, the question whether the policy is justified, in the sense that its benefits to society will exceed its costs to society. CEA is sometimes used as a second-best option when a full-blown CBA would be desirable, but many effects cannot be captured in monetary form.</p>	
<p>An analysis of the costs of alternative programmes designed to meet a single objective. The programme which costs less will be the most effective.</p>	<p>WATECO, 2003</p>

Cost-benefit analysis

Elaboration of the concept and possible application	Source
<p>CBA is a method for comparing policy measures against the baseline situation in terms of their advantages (benefits) and disadvantages (costs). This essentially involves estimating all of the negative and positive economic, social and environmental impacts, including items for which the market does not provide an observable measure of value, accruing to all affected societal parties. According to the EC Impact Assessment Guidelines, a CBA can be done at various levels, depending on data availability. It can be either a full CBA when the most significant part of both costs and benefits can be monetised utilising economic values derived through various economic techniques (e.g. market, revealed and stated preference-based methods); or a partial CBA in cases where only a part of the costs and benefits can be quantified and/or monetised.</p>	<p>Arcadis report, 2014</p>
<p>CBA is a means of project or policy appraisal. It involves identifying and measuring, in monetary terms, as many of the costs and benefits as possible that relate to a particular project or course of action. This helps to determine whether the project or policy will produce a net gain or loss in economic welfare for society as a whole. As a rule, a project (or policy option) is deemed to be efficient if total benefits exceed total costs.</p> <p>A CBA compares the costs and benefits in monetary terms. The results of this analysis can be interpreted as a benefit to cost (B-C) ratio, i.e. total benefits divided by total costs, where a ratio larger than one indicates that the policy measure is economically beneficial, or as a net present value (NPV), that is the present value of the net benefits where a positive NPV indicates a welfare improvement. Strictly speaking, only those costs and benefits are included in a CBA that can be quantified in monetary terms. However, it will hardly ever be possible to monetise all impacts all the time: those impacts that cannot be monetised are often left out of the analysis. Non-monetised impacts, if considered relevant, can nonetheless be included in a qualitative discussion accompanying the discussion of the CBA results.</p>	<p>Turner et al, 2010</p>
<p>Cost-benefit analysis (CBA) is a technique for the assessment of the relative desirability of competing alternatives (events, project, management or policy measures). The assessment involves the comparison of the current (<i>base case</i>) situation to one or more <i>alternatives</i> considering the differences between the base case and the alternatives. For example, to evaluate the impact of the application of thinning on the output of forest goods and services in a particular forest, the base case (without thinning) would be compared to the</p>	<p>UNEP/MAP Plan Bleu, 2014c</p>

<p>alternative scenario (with thinning). The analysis would focus on the differences in costs and benefits, in the situations with and without the management measure. The CBA compares the costs and benefits measured in monetary terms.</p> <p>The cost-benefit analysis can be conducted from different perspectives. <i>Private CBA</i> considers only those costs and benefits from the analysed alternative, which are imposed onto or accrue to a private agent (e.g. individual or firm). Thus, it also considers transfer payments (e.g., subsidies, taxes), which the private agent receives or pays to the administration. This type of CBA is also often called financial appraisal. <i>Social CBA</i> in turn attempts to assess the overall impact of an alternative on the welfare of the society as a whole.</p>	
<p>CBA is carried out in order to compare the economic efficiency implications of alternative actions. The benefits from an action are contrasted with the associated costs (including the opportunity costs) within a common analytical framework. To allow comparison of these costs and benefits measured in widely differing units, a common denominator is used: money. This is where most problems usually start since some resources, especially environmental resources, are difficult to evaluate in monetary terms. Many of the goods and services provided by ecosystems, such as amenity, clean air, biodiversity sustenance, are not traded on a market, hence, no market price is available which reflects their economic value. Such prices need to be estimated instead through the use of valuation studies, for example eliciting people's willingness to pay for a particular environmental good. By comparing costs and benefits in monetary terms, a CBA provides an assessment of whether a policy option (or a project) is worth implementing (that is whether the benefits outweigh the costs).</p>	<p>Goerlach et al, 2006</p>
<p>The evaluation of an investment project with a long-term perspective from the viewpoint of the economy as a whole by comparing the effects of undertaking the project with not doing so.</p>	<p>WATECO, 2003</p>

APPENDIX H. Reference information on technical guidelines produced by UNEP/MAP for selecting management options for pollution prevention and control

- UNEP/MAP/MED POL/WHO: **Municipal wastewater treatment plants in Mediterranean coastal cities – Inventory of treatment plants in cities of between 2,000 and 10,000 inhabitants.** MAP Technical Reports Series No. 169, UNEP/MAP, Athens, 2008.
- UNEP/MAP/CP RAC: **State of the art of sustainable production in the Mediterranean.** MAP Technical Reports Series No. 165, UNEP/MAP, Athens, 2006. (English, French, Spanish).
- UNEP/MAP/MED POL/WHO: **Municipal wastewater treatment plants in Mediterranean coastal cities (II)** UNEP/MAP: Athens, 2004. (English, French).
- UNEP/MAP/MED POL: **Inventories of PCBs and nine pesticides.** UNEP/MAP: Athens, 2004. (English, French)
- UNEP/MAP/MED POL: **Plan for the management PCBs waste and nine pesticides for the Mediterranean Region.** UNEP/MAP: Athens, 2004. (English, French).
- UNEP/MAP/MED POL/WHO: **Guidelines for the management of industrial wastewater for the Mediterranean Region.** UNEP/MAP: Athens, 2004. (English, French).
- UNEP/MAP/MED POL/WHO: **Guidelines on sewage treatment and disposals for the Mediterranean Region.** UNEP/MAP: Athens, 2004. (English, French).
- UNEP/MAP/MED POL: **Guidelines for river (including estuaries) pollution monitoring programme for the Mediterranean Region.** UNEP/MAP: Athens, 2004. (English, French).
- UNEP/MAP/MED POL/WHO: **Reference handbook on environmental compliance and enforcement in the Mediterranean region.** UNEP/MAP: Athens, 2004. (English, French).
- UNEP/MAP/MED POL/WHO: **Guidelines on environmental inspection systems for the Mediterranean region.** UNEP/MAP: Athens, 2004. (English, French).
- UNEP/MAP/MED POL/WHO: **Guidelines on management of coastal litter for the Mediterranean region.** UNEP/MAP: Athens, 2004. (English, French).
- UNEP/MAP/MED POL: **Plan for the management of hazardous waste, including inventory of hazardous waste in the Mediterranean region.** UNEP/MAP: Athens, 2004. (English, French).
- UNEP/MAP/RAC/CP: **Guidelines for the application of Best Available Techniques (BATs), Best Environmental Practices (BEPs) and Cleaner Technologies (CTs) in industries of the Mediterranean countries.** UNEP/MAP: Athens, 2004. (English, French).
- UNEP/MAP/RAC/CP: **Plan for the reduction by 20% by 2010 of the generation of hazardous wastes from industrial installations for the Mediterranean region.** UNEP/MAP: Athens, 2004. (English, French).
- UNEP/MAP/MED POL: **Plan on reduction of input of BOD by 50% by 2010 from industrial sources for the Mediterranean region.** UNEP/MAP: Athens, 2004. (English, French, Arabic).
- UNEP/MAP/RAC/CP: **Guidelines for the application of Best Environmental Practices (BEPs) for the rational use of fertilisers and the reduction of nutrient loss from agriculture for the Mediterranean region.** UNEP/MAP: Athens, 2004. (English, French, Arabic).

UNEP/MAP/RAC/CP: **Guidelines for the application of Best Available Techniques (BATs) and Best Available Practices (BEPs) in industrial sources of BOD, nutrients and suspended solids for the Mediterranean region.** UNEP/MAP: Athens, 2004. (English, French).

UNEP/MAP/MED POL: **Riverine transport of water, sediments and pollutants to the Mediterranean Sea.** UNEP/MAP: Athens, 2003. (English)

UNEP/MAP/MED POL: **Mariculture in the Mediterranean.** UNEP/MAP: Athens, 2004. (English).

UNEP/MAP/MED POL: **Sea Water Desalination in the Mediterranean: Assessment and Guidelines.** UNEP/MAP: Athens, 2003. (English, French)

UNEP/MAP/MED POL: **Guidelines for the management of fish waste or organic materials resulting from the processing of fish and other marine organisms.** UNEP/MAP: Athens, 2002. (English, French, Spanish & Arabic)

UNEP/MAP: **Atmospheric Transport and Deposition of Pollutants into the Mediterranean Sea: Final Reports on Research Projects.** UNEP/MAP: Athens, 2001. (English)

UNEP/MAP/WHO: **Remedial Actions for Pollution Mitigation and Rehabilitation in Cases of Non-compliance with Established Criteria.** UNEP/MAP: Athens, 2001. (English)

UNEP/MAP/WMO: **Atmospheric Input of Persistent Organic Pollutants to the Mediterranean Sea.** UNEP/MAP: Athens, 2001. (English)

UNEP/MAP/MED POL: **Guidelines for the Management of Dredged Material.** UNEP/MAP: Athens, 2000. (English, French, Spanish and Arabic)

UNEP/MAP/MED POL/WHO: **Municipal Wastewater Treatment Plants in Mediterranean Coastal Cities.** UNEP/MAP: Athens, 2000 (English, French).

UNEP/MAP/WHO: **Identification of Priority Hotspots and Sensitive Areas in the Mediterranean.** UNEP/MAP: Athens, 1999. (English, French).

UNEP/MAP/WMO: **Atmospheric Input of Mercury to the Mediterranean Sea.** UNEP/MAP: Athens, 1998. (English).

UNEP/MAP/WMO: **The Input of Anthropogenic Airborne Nitrogen to the Mediterranean Sea through its Watershed.** UNEP/MAP: Athens, 1997 (English).

UNEP/MAP/WHO: **Guidelines for submarine outfall structures for Mediterranean small and medium-sized coastal communities.** UNEP/MAP: Athens, 1996 (English, French).

UNEP/MAP/WHO: **Guidelines for treatment of effluents prior to discharge into the Mediterranean Sea.** UNEP/MAP: Athens, 1996 (English).

UNEP/MAP/FAO: **Baseline studies and monitoring of DDT, PCBs and other chlorinated hydrocarbons in marine organisms (MED POL III).** UNEP/MAP: Athens, 1986 (Parts in English, French or Spanish only).

UNEP/MAP/FAO: **Baseline studies and monitoring of metals, particularly mercury and cadmium, in marine organisms (MED POL II).** UNEP/MAP: Athens, 1986 (Parts in English, French or Spanish only).

UNEP/MAP/IOC/WMO: **Baseline studies and monitoring of oil and petroleum hydrocarbons in marine waters.** UNEP/MAP: Athens, 1986 (Parts in English, French or Spanish only).

