

00188

GUIDELINES of LAKE MANAGEMENT



Volume 9

Reservoir Water Quality Management

GUIDELINES of LAKE MANAGEMENT

Volume 9

Reservoir Water Quality Management

M. Straškraba and J. G. Tundisi



International Lake Environment Committee

Copyright © 1999 by the **International Lake Environment Committee Foundation**

Opinions expressed in this volume are those of the authors and do not necessarily reflect those of the International Lake Environment Committee Foundation.

Designations employed and the presentation of material in this publication do not imply the expression of any opinion whatsoever on the part of the International Lake Environment Committee Foundation concerning the legal status of any country, territory, city or area, or of its authorities, or concerning the delineation of its frontiers or boundaries.

International Lake Environment Committee Foundation

1091 Oroshimo-cho, Kusatsu, Shiga 525-0001, Japan

Tel : +81-77-568-4567

Fax : +81-77-568-4568

Email : info@mail.ilec.or.jp

URL : <http://www.ilec.or.jp>

ISBN 4-906356-26-5

CONTENTS

PREFACE.....	1
1 INTRODUCTION.....	3
1.1 IMPORTANCE OF RESERVOIRS AND PROBLEMS OF THEIR MANAGEMENT.....	3
1.2 RESERVOIRS OF THE WORLD AND THEIR DISTRIBUTION.....	7
1.3 GOAL OF THE BOOK AND TO WHOM IT IS DIRECTED.....	9
1.4 OUTLINE HOW TO READ THE BOOK.....	11
2 ASPECTS AND APPROACHES TO WATER QUALITY MANAGEMENT.....	13
2.1 WHAT THE MANAGER HAS TO CONSIDER.....	13
2.2 APPROACHES TO WATER QUALITY MANAGEMENT.....	15
2.3 SUSTAINABLE RESERVOIR WATER QUALITY MANAGEMENT.....	17
2.4 RESERVOIRS IN THE ECONOMIC DEVELOPMENT OF REGIONS	20
2.5 INTEGRATED WATERSHED MANAGEMENT.....	21
2.6 ENVIRONMENTAL IMPACT ASSESSMENT.....	24
2.7 HUMAN ACTIVITIES WITH MAJOR IMPACT ON FRESHWATER RESOURCES.....	25
3 TECHNICAL ASPECTS OF RESERVOIR CONSTRUCTION.....	29
3.1 RESERVOIR USES.....	29
3.2 IMPORTANT VARIABLES OF RESERVOIR HYDROLOGY.....	30
3.2.1 Reservoir construction on the river continuum.....	30
3.2.2 Flow and retention time.....	32
3.2.3 Reservoir depth, size and basin morphology.....	33
3.2.4 Outlet location.....	33
3.3 RESERVOIR SYSTEMS.....	34
4 RESERVOIRS AS ECOSYSTEMS.....	37
4.1 THE WATERSHED AND THE RESERVOIR INFLOW.....	40
4.2 THE PHYSICAL SUBSYSTEM.....	41
4.3 SPATIAL VARIABILITY IN RESERVOIRS.....	47
4.4 THE CHEMICAL SUBSYSTEM.....	49
4.5 THE BIOLOGICAL SUBSYSTEM - RESERVOIR FOOD WEB.....	53
4.6 RESERVOIR BACTERIA AND VIRUSES.....	56
4.7 WATER QUALITY CHANGES DURING RESERVOIR AGING.....	57
4.8 LIMNOLOGICAL TYPES OF RESERVOIRS.....	58
4.8.1 Classification based on reservoir throughflow.....	60
4.8.2 Reservoir mixing classes.....	61
4.8.3 Trophic classification.....	63
4.8.4 Combined classification.....	66

5 RESERVOIR FISHERIES AND ITS RELATION TO WATER QUALITY.....	67
5.1 FISH COMMUNITIES IN RESERVOIRS.....	67
5.2 BIOMASS AND FISH PRODUCTION IN RESERVOIRS.....	69
5.3 MANAGEMENT OF FISHERIES AND AQUACULTURE.....	71
5.4 RELATIONS OF FISHERIES TO WATER QUALITY.....	72
5.4.1 Sensitivity of fish to water quality.....	72
5.4.2 Influence of fish on water quality.....	72
5.5 FISH INTRODUCTIONS.....	74
6 RESERVOIR POLLUTION AND WATER QUALITY DETERIORATION.....	75
6.1 SOURCES AND COMPLEXITIES OF POLLUTION.....	75
6.2 CLASSIFICATION OF WATER QUALITY PROBLEMS.....	76
6.2.1 Organic pollution.....	78
6.2.2 Eutrophication.....	80
6.2.3 Nitrate contamination.....	81
6.2.4 Siltation.....	81
6.2.5 Hypolimnetic anoxia and gas release.....	82
6.2.6 Acidification.....	82
6.2.7 Salinization.....	83
6.2.8 Bacterial and viral contamination.....	83
6.2.9 Health effects and waterborne diseases.....	83
6.2.10 Heavy metal pollution.....	84
6.2.11 Agro-chemicals and other toxic chemicals.....	85
7 THEORY OF ECOTECHNOLOGICAL MANAGEMENT.....	86
7.1 ECOSYSTEM THEORY APPLIED TO RESERVOIRS.....	86
7.2 PRINCIPLES OF ECOTECHNOLOGICAL MANAGEMENT.....	90
8 RESERVOIR WATER QUALITY AND HOW IS IT DETERMINED.....	95
8.1 APPLICATION OF RESERVOIR LIMNOLOGY AND ECOTECHNOLOGY TO WATER QUALITY MANAGEMENT.....	95
8.2 VARIABLES OF WATER QUALITY AND THEIR INTERRELATIONS.....	97
8.3 RELATIONSHIPS BETWEEN WATER QUALITY AND QUANTITY.....	101
9 SAMPLING, MONITORING AND WATER QUALITY EVALUATION.....	104
9.1 WATER QUALITY DETERMINATION AS A SYSTEM.....	104
9.2 SAMPLING BEFORE THE RESERVOIR IS CONSTRUCTED.....	106
9.3 OPTIMIZATION OF DISTRIBUTION AND TIMING OF SAMPLING.....	106
9.4 MANUAL SAMPLING.....	109
9.5 AUTOMATIC MONITORING.....	111
9.6 SATELLITE IMAGING.....	112
9.7 DATA STORAGE AND HANDLING.....	113

9.8	WATER QUALITY EVALUATION.....	114
9.8.1	Reservoir water quality evaluation indexes.....	114
9.8.2	Evaluation according to individual variables.....	115
9.9	DRAWING MANAGEMENT CONCLUSIONS.....	123
10	APPROACHES AND METHODS OF WATERSHED MANAGEMENT.....	125
10.1	CLEAN PRODUCTION	125
10.2	ORGANIC POLLUTION MANAGEMENT.....	127
10.3	NUTRIENT SOURCES AND EUTROPHICATION MANAGEMENT.....	127
10.3.1	Tertiary treatment.....	127
10.3.2	Agricultural practices.....	127
10.4	TOXICS, HEAVY METALS, PESTICIDES AND THE LIKE.....	128
10.5	METHODS OF ACIDIFICATION MANAGEMENT.....	128
10.6	SILTATION MANAGEMENT.....	129
10.7	SALINIZATION AND ITS MANAGEMENT.....	129
10.8	MEASURES AT THE RESERVOIR INFLOW.....	129
10.8.1	Preimpoundments.....	130
10.8.2	Wahnbach plant.....	130
10.9	DIVERSION OF EFFLUENTS.....	130
10.10	WETLAND MANAGEMENT.....	131
10.11	MANAGEMENT OF STREAMSIDE VEGETATION FOR WATER QUALITY PROTECTION.....	133
10.12	SUMMARY OF WATERSHED MANAGEMENT TECHNIQUES.....	133
11	IN-LAKE ECOTECHNOLOGICAL MANAGEMENT.....	135
11.1	MIXING AND OXYGENATION.....	135
11.1.1	Destratification - artificial circulation.....	136
11.1.2	Hypolimnetic aeration.....	138
11.1.3	Epilimnetic mixing.....	139
11.1.4	Layer aeration.....	140
11.1.5	Speece cone.....	140
11.1.6	Propeler mixing and oxygenation.....	140
11.2	METHODS TREATING SEDIMENTS.....	141
11.2.1	Sediment removal.....	141
11.2.2	Sediment aeration and oxidation.....	142
11.2.3	Sediment capping.....	143
11.2.4	In-lake phosphorus inactivation.....	143
11.3	BIOMANIPULATION.....	143
11.4	HYDRAULIC REGULATION.....	146
11.4.1	Use of selective offtakes.....	146
11.4.2	Hypolimnetic siphoning.....	147
11.4.3	Curtains.....	148

11.5	OTHER METHODS.....	148
11.5.1	Algicide use (particularly copper poisoning).....	148
11.5.2	Manipulation of the underwater light regime.....	148
11.5.3	Macrophyte control.....	149
11.5.4	Water level manipulation.....	150
11.6	CONFRONTATION OF DIFFERENT ECOTECHNOLOGICAL APPROACHES.....	150
12	MANAGEMENT OF RESERVOIR OUTFLOW.....	152
12.1	ENVIRONMENTAL CHANGES IN THE RIVER BELOW A RESERVOIR.....	152
12.2	MANAGEMENT OF THE RESERVOIR OUTFLOWS.....	155
12.2.1	Managing water quality within the reservoir and its watershed.....	155
12.2.2	Use of selective offtakes.....	155
12.2.3	Management of reservoir outflows.....	156
13	WATER QUALITY MANAGEMENT OF SPECIFIC RESERVOIR TYPES.....	158
13.1	DRINKING WATER RESERVOIRS.....	158
13.2	POWER GENERATION RESERVOIRS.....	159
13.3	URBAN RESERVOIRS.....	160
13.4	RECREATION AND TURISM ON RESERVOIRS.....	161
13.4.1	Recreation in the reservoir watershed.....	161
13.4.2	Recreation at the lake shore.....	161
13.4.3	Recreation on the lake surface.....	162
13.5	RESERVOIR SYSTEMS.....	163
13.5.1	Management of reservoir cascades.....	163
13.5.2	Reservoir multisystems.....	164
13.5.3	Pumping schemes.....	165
13.5.4	Water transfers.....	167
14	MATHEMATICAL MODELLING OF WATER QUALITY MANAGEMENT.....	168
14.1	GOAL OF THE CHAPTER.....	168
14.2	PROBLEMS FOR WHICH THE MATHEMATICAL MODELS ARE USEFUL.....	168
14.3	GENERATIONS OF MODELS.....	169
14.4	SIMPLE CALCULATION MODELS.....	171
14.5	COMPLEX DYNAMIC MODELS.....	174
14.6	WATERSHED AND REGIONAL MODELS USING GIS.....	177
14.7	MANAGEMENT (PRESCRIPTIVE) MODELS.....	178
14.8	EXPERT AND DECISION SUPPORT SYSTEMS.....	180
14.9	SELECTION OF AN APPROPRIATE MODEL.....	182

15 CASE STUDIES.....	183
15.1 SLAPY RESERVOIR, A TEMPERATE CASCADE RESERVOIR.....	183
15.2 BARRA BONITA, A SUBTROPICAL/TROPICAL CASCADE RESERVOIR.....	186
15.3 ŘÍMOV RESERVOIR, A TEMPERATE DRINKING WATER RESERVOIR.....	188
15.4 BROA RESERVOIR, A TROPICAL WATER SUPPLY AND RECREATION RESERVOIR.....	190
16 CONCLUSIONS.....	193
16.1 GUIDELINES FOR FUTURE RESERVOIR CONSTRUCTION.....	193
16.2 FUTURE NEEDS AND DEVELOPMENTS OF RESERVOIR WATER QUALITY MANAGEMENT.....	194
16.3 CONSEQUENCES OF GLOBAL CHANGES ON RESERVOIR WATER QUALITY.....	196
16.4 FUTURE DEVELOPMENT IN RESERVOIR MANAGEMENT.....	199
REFERENCES.....	201
SUGGESTED FURTHER READING.....	201
REFERENCES CITED IN TEXT.....	203
GLOSSARY.....	217
INDEX.....	224

PREFACE

This book was designed for use by anyone who is interested in reservoir water quality. The book specifically stresses reservoirs as opposed to lakes, however, reservoirs and lakes have much in common and reservoirs are considered transitional between rivers and lakes. Thus rivers and their respective watersheds play an important role in the reservoir water quality. The authors attempted, as much as possible, to balance attention to different aspects. An important element of this book that differentiates it from similar efforts is the presentation of knowledge about both temperate and tropical regions.

Reservoir water quality management is controlled by a team of participants that represent many different disciplines and decision levels. These include engineers, limnologists (biologists, chemists, bacteriologists), and local and regional managers. Because not everyone is interested in each of the individual topics treated in this book with the same intensity, Fig. 1.4 provides a guide to help the reader make best use of the information contained within.

Chapter 1 is an introduction into the book, defining reservoirs, outlining the importance of reservoirs, problems of their management and reservoir distribution over the world.

Chapter 2 is an overview of the aspects of and approaches to water quality management. It itemizes topics that are important for managers and separates water quality management strategies into three major categories according to goals and time horizons under consideration: these are corrective, preventive, and sustainable management. Preventive measures should be fostered. The responsibility of water managers must extend beyond the reservoir itself, and more attention by professionals should be devoted to relating water quality issues to broader branches of the economy. The short-sightedness of first losing valuable resources that enter watercourses as effluents and later trying to extract these and decrease harm at very high costs must be more widely understood. Sustainable management of water resources, which requires the longest time horizons, is elucidated and within the book.

In **Chapter 3** we stress interrelations between site selection and technical construction of the dam and specific water quality features of the reservoir. The depth of the outlets and retention time are particularly important characteristics. Different potential reservoir uses are related the design of these technical constructs, affect water quality, and may impose specific requirements. Special problems are encountered in some types of reservoir systems.

Chapter 4 presents the reservoir ecosystem as composed of the following four major subsystems: the watershed, the reservoir proper, the outflow and the socio-economic and management subsystems. These subsystems are mutually coupled. The dominant role of the watershed in reservoir water quality is demonstrated. It is elucidated that changes of water quality within the reservoir are determined, not only by reservoir physics (hydrology, hydrodynamics) and chemistry, but are also highly dependent on interrelations between these and biota. The tight couplings of physics, chemistry and biology are important because they represent both a key for understanding water quality and an essential tool in many

management techniques. Because there is feedback between these components, the classical ecological representation of the relationship of physics → chemistry → plants → animals (so called bottom-up effects) must be replaced by the concept of top-down controls that are effective in an opposite sequence: humans → fish → zooplankton → phytoplankton → chemistry → physics. Phosphorus is discussed as a dominant force in reservoirs, which can limit biological production or, when in excess, can lead to eutrophication and subsequent water quality deterioration. Theoretical retention time is an easily estimated measure that many reservoir features are linked to and it is demonstrated that a solid understanding of the character provides the manager with many important predictive possibilities.

Fish, fisheries and their relations with water quality are the focus of **Chapter 5**. The strong influence of fish populations on water quality is emphasized. The failure of many fish introductions signals that the success of the fish transfers is dependent on knowledge of their effect on local populations. The cultivation of selected local species is usually preferable.

Chapter 6 is a review of the many means and symptoms of reservoir water quality deterioration.

Chapter 7 is an attempt to present principles of ecotechnology as a sound, theoretically-based management strategy that results in the least overall harm to an environment that includes reservoir ecosystems. Issues of sustainability and methods of evaluation must be placed in context. The chapter provides a guide to enable the use ecotechnology and limnological knowledge in the practice of daily water quality control.

The next two chapters, **Chapters 8 and 9** provide an outline of individual water quality characteristics and methods of measurement. The chapter on water quality sampling (Chapter 9) provides a means of switching from the "data rich but information poor syndrome" to full use of sampling and monitoring efforts and results. The methods of data evaluation are provided for selected variables, as based on intercomparisons between reservoirs and simple models.

In contrast to the preceding chapters, which presented only principles, the chapter about watershed- (**Chapter 10**) and in-lake- ecotechnological water quality management techniques (**Chapter 11**) provide specific details that are part of selected key procedures. Advantages and disadvantages of each approach are discussed, particularly in regards to long-term effects.

Specific topics related to management of reservoir outflow water quality and reservoir systems are the subjects of **Chapters 12 and 13**, respectively. Mathematical modeling is introduced as a tool to help managers with difficult tasks (**Chapter 14**). Modeling techniques are presented, the emphasis is placed on bringing those models to the attention of managers.

A few case studies that demonstrate how the knowledge of limnologists, engineers and managers can be collectively used to forge new solutions are outlined in **Chapter 15**. We hope that the glossary of terms at the end of the book (**Chapter 18**) will facilitate better reader orientation.

Milan Straškraba and José Galicia Tundisi
České Budějovice and São Carlos, February 1997

CHAPTER 1

INTRODUCTION

Reservoirs - man made lakes - deserve the latter name because they are artificial lakes that were created by man for particular purposes. This creation makes reservoirs different in many respects than lakes; thus, several aspects of their management are different. They are lakes in the respect that they can be described as a volume of water of particular composition that contains various life form. However, natural lakes fill depressions, whereas reservoirs usually fill a river valley that has been dammed by a wall. As is true of lakes, reservoirs are rather variable; there is no uniformity of location, size, or shape. Nature was as creative during the formation of lakes as man has been in constructing reservoirs.

1.1 IMPORTANCE OF RESERVOIRS AND PROBLEMS OF THEIR MANAGEMENT

One reason for the variability is the many purposes for which reservoirs have been built; as expected and as we will later demonstrate, there is some correspondence between reservoir features and their uses. There are "lakes" as small as a few meters in size, and there are also "reservoirs" on the roofs of houses of the same size. However, this discussion will not include such small water bodies; our treatment of reservoirs includes those with a dam height of at least 15 m (and any volume) or a minimum dam height of 10 m and a volume of at least 1.10^6 m³. Many features of reservoirs differ from lakes only quantitatively, while others qualitatively. Quantitative differences cover features which both lakes and reservoirs possess, but these are "on the average" different for these two water body types. When we say "on the average", we mean that some of these quantitative features overlap to some extent, as the variability of both natural and artificial lakes is very great. For example, we can name the theoretical retention time for either water body, i.e., the length of time necessary to fill a lake or reservoir with water entering via its inflows. This is much shorter for reservoirs than for lakes. Nevertheless, there are lakes that are fed by large rivers and are rather throughflowing; i.e., they have relatively short retention times. Also, there are relatively large reservoirs situated on small rivers and these take years to be filled. Qualitative differences between reservoirs and lakes can be distinguished by other features. By qualitative differences we refer to those features of reservoirs which lakes do not have, and vice versa. An example of a qualitative difference is the location of maximum depths; the maximum depth of lakes is generally centrally located while in reservoirs it is usually along one end. The most important qualitative and quantitative differences between both water types are summarized in Tab. 1.1. Some natural lakes have been changed into reservoirs by increasing their volume after damming; we call these **dam lakes** and have not included them in this work. Dam lakes have features that are intermediate between lakes and reservoirs, depending on the proportion between the depth of the original natural lake and the increased depth after damming. In cases in which the depth is predominantly due to the additional elevation of the surface, reservoir characteristics will predominate.

Tab. 1.1 Comparison of dam reservoirs and lakes. From Straškraba *et al.* (1993).

CHARACTERISTIC	LAKES	DAM RESERVOIRS
QUALITATIVE (ABSOLUTE) DIFFERENCES		
NATURE	natural	man-made
GEOLOGICAL AGE	old (\geq Pleistocene)	young (<50 years)
AGING	slow	rapid
FORMED BY FILLING	depressions	river valleys
LOCATION IN WATERSHED	central	marginal
SHAPE	regular	dendritic
SHORE DEVELOPMENT RATIO	low	high
MAXIMUM DEPTH	near-central	extreme (at the dam)
BOTTOM SEDIMENTS	autochthonous	allochthonous
LONGITUDINAL GRADIENTS	wind-driven	flow-driven
OUTLET DEPTH	less developed surface	more pronounced deep

QUANTITATIVE (RELATIVE) DIFFERENCES		
WATERSHED: LAKE AREA	lower	higher
RETENTION TIME, R	longer	shorter
COUPLING WITH WATERSHED	lesser	greater
MORPHOMETRY	U-shaped	V-shaped
LEVEL FLUCTUATIONS	smaller	larger
HYDRODYNAMICS	more regular	highly variable
CAUSES OF PULSES	natural	man-made operation
WATER RESOURCE SYSTEMS	rare	common

For example, the comparison of the geometric means of 309 natural lakes and 107 reservoirs in U.S.A. resulted in the values given in Tab. 1.2.

Tab. 1.2 Geometric means for some parameters of natural lakes and of reservoirs in U.S.A. (Based on Ryding & Rast 1989).

	LAKES	RESERVOIRS
DRAINAGE AREA [km ²]	222	3228
SURFACE AREA [km ²]	5.6	34.5
DRAINAGE: SURFACE AREA RATIO	33	93
SHORELINE DEVELOPMENT RATIO	3	9
RETENTION TIME [years]	0.74	0.37
MAXIMUM DEPTH	11	20

From a water quality point of view, many of these features are very important and water quality management must include these considerations. Many of the management techniques developed for lakes can also be used for reservoirs, but many are reservoir specific. The whole group of methods designed for watersheds is appropriate for use in management of both lakes and reservoirs. For reservoirs, the importance of watershed management techniques is stressed in

comparison to lakes because larger watershed area/lake area ratios indicate that the watershed is more influential over a reservoir than a lake.

Reservoirs are rather considered as a transition between rivers and lakes. The ecosystem characteristics for which reservoirs occupy an intermediate position relative to rivers and natural lakes can be deduced from the following differences between rivers and lakes: rivers are considered elongate while lakes circular/ovoid, flow in rivers is rapid and directional while in lakes slow and non-directional, flushing rate in rivers is rapid while in lakes slow, watershed influence is very great in rivers while low in lakes and spatial structure of rivers is characterized by longitudinal gradients while in lakes vertical gradients prevail (following Thornton *et al.* 1990).

Based on the location of a reservoir, within or beside a river, we have defined and named two basic reservoir types in order to clearly distinguish between the two: (i) those constructed by damming a river, which we call **dam reservoirs** (also called valley reservoirs or mainstream reservoirs), and (ii) those located beside the river, which we call **impoundments**. While dam reservoirs are very common, impoundments are mainly of ancient origin (e.g., Sri Lanka), although some have been built recently (London drinking water supply system). These two reservoir types have different features that also affect their water quality management (Tab. 1.3).

Tab. 1.3 Differences between dam reservoirs and impoundments. From Straškraba *et al.* (1993).

CHARACTERISTICS	DAM RESERVOIR	IMPOUNDMENT
LOCATION	on the river	beside the river
DAM CONSTRUCTION	damming a valley	surrounding walls
DEPTH	deep to shallow	shallow
FORM	dendritic	more regular
INFLOW	river(s)	channel
OUTFLOW	river	channel

In this book, dam reservoirs are emphasized because they are much more common.

The period of intensive reservoir construction is over, although some construction continues, specially in third world countries. Many huge reservoir projects have been supported there by the World Bank and other international organizations. In addition to positive results achieved by reservoir construction and by fulfilling planned endeavors, a number of negative consequences have been observed. The time is now ripe to evaluate the pros and cons of reservoir construction and develop standard ways to evaluate them (Chapter 2.3).

Problems of water quantity are not treated in this manual unless they are linked to water quality. First, it is clear that the primary goal of a water manager is water availability. If a drought occurs and water becomes scarce, any other goals become subordinate. Water quality management options are restricted during such conditions. Low water stages and droughts are not uncommon situations for engineers, as the planning of reservoir construction includes consideration of the variability of natural distribution patterns of flow. Water flows that correspond to some n-day or

n-year conditions are taken into account. This implies that "unusual" situations with low flow that result in half-empty reservoirs as well as flood conditions that require spillover are considered. However, water quality considerations are not included in the planning process and this results in conflicts between managing water quantity and water quality. Additional constraints related to water quality management are associated with the needs of downstream water users. Some pre-set minimum flow standards are common, but restrictions on the water quality of outflow also have to be considered and can restrict some management options.

Water quality can be defined as an ensemble of physical, chemical and biological (including bacteriological) characteristics of the given water. Which characteristics are considered important depends on the intended use of the corresponding water: safe drinking water has to fulfill many restrictions; different characteristics might be decisive for fish life and so on. This will be discussed in detail within Chapter 6.

The science that examines physical, chemical and biological variables and their interrelations inside a water body and the interrelations of a water body with its surroundings is limnology. A strong coupling exists between limnology and water quality management. Limnology provides the water quality engineer not only with the values of relevant water quality variables but also with a deeper insight into the interrelations and importance of variables. It also enables a broader perspective for use in the development of new and adequate management methods. Such are the **ecotechnological methods** - cheap approaches that emphasize use of nature's capabilities and are less dependent on expensive high technology, as will be discussed in Chapter 7. Nevertheless, the goals of the two disciplines, water quality management and limnology, are not identical. Water quality management is focused on evaluation and application of variables that affect the use of water while limnology is a broad study of all aspects of natural surface waters of various types. The fuzzy borders and interactions between the two disciplines allow a new perspective for both disciplines. For a water quality engineer, the knowledge of limnology aids an understanding of the causes and relations of water quality problems, and enables selection of adequate management methods. It also enables more knowledgeable use of newly developed management options and development of new ones. For the limnologists consideration of water quality problems can foster a broader consideration of the human environment and satisfy the desire to apply practical solutions. Chapter 4 is devoted to limnological features of reservoirs, which are particularly important in the study of water quality.

Water quality problems are treated in detail in Chapter 6 and their management is discussed in Chapters 10 and 11.

During the recent history of humanity, new problems have arisen and are of an increasing scale and complexity. Recovery of water after these problems have been solved takes longer and longer. The tragedy is that, although some of the problems have been diminished at the local level, none have been solved on a world wide scale. The question remains: what kind of water quality problems will arise next? Present theory enables solutions for some of the difficulties. Practical solutions, however, are often hindered by high costs. Other problems have not yet been solved, even from a theoretical point of view, and all problems need further study to increase the efficiency of solutions. Danger stems from the fact that new problems are emerging with an ever

increasing frequency. There are two kinds of deep difficulties in this regard: the disproportion between the speed of problem creation and solution, and the situation of pollution costs that are rising more rapidly than availability of manpower, financial and material means available for use in solutions. A new global problem has begun to emerge: unsustainability of the present trends of development. We cannot continue with the present attitudes towards the environment, unless we are prepared to accept substandard living conditions for future generations. This knowledge suggests a need to change attitudes and create new approaches towards the management of natural resources, including aquatic habitats. Chapter 2.3 will address these issues in greater detail.

1.2 RESERVOIRS OF THE WORLD AND THEIR DISTRIBUTION

Fresh water may seem to be abundant on the earth, but the increasing demand by growing populations and the irregular distribution of both human habitation and aquatic resources create pressure to increase available water storage in many parts of the world.

Reservoirs have been built on all of the world's continents except the Antarctic. They are constructed intensively in regions where natural water reserves are inadequate, but are also constructed in regions with an extreme abundance of water. About 10% of the territory of Finland is covered by water, yet many reservoirs, some of them of considerable size (e.g. Porttipahta with $1,353 \cdot 10^6 \text{ m}^3$ of water), have been built. Canada is well known for its abundance of lakes, yet the Southern Indian Reservoir Complex covering $2,391 \text{ km}^2$, with a volume of more than 23 km^3 was constructed in the 1960s in the Subarctic Region (approx. 55-58 degrees North); a number of other Canadian reservoirs have been constructed as well.

The distribution and volume of reservoirs that were created prior to 1986 are illustrated in Fig. 1.1. As compared with the volume of lakes, disregarding the Great Lakes and Baikal, this reservoir volume represents 53%.

The irregularity of water resource distributions is related to global conditions on the earth surface. Figure 1.2 depicts the hydrological budget of the planet, with evident minima (negative budgets, i.e. evaporation exceeding precipitation) in the vicinity of latitudes 15-25 on both sides of the Equator. The semiarid areas of the globe are particularly lacking in water, and reservoir construction is much more intensive under such circumstances. As an example, Spain has approximately 1,000 reservoirs with a volume of more than 40 km^3 within a territory of $500,000 \text{ km}^2$. All rivers are dammed, many of them with cascades of reservoirs in succession for great distances. In Australia, drinking water is transported for distances that exceed thousands of kilometers; further more, complicated water systems in the highest mountains in the Northeastern portion of the continent supply a large territory in Southern Australia.

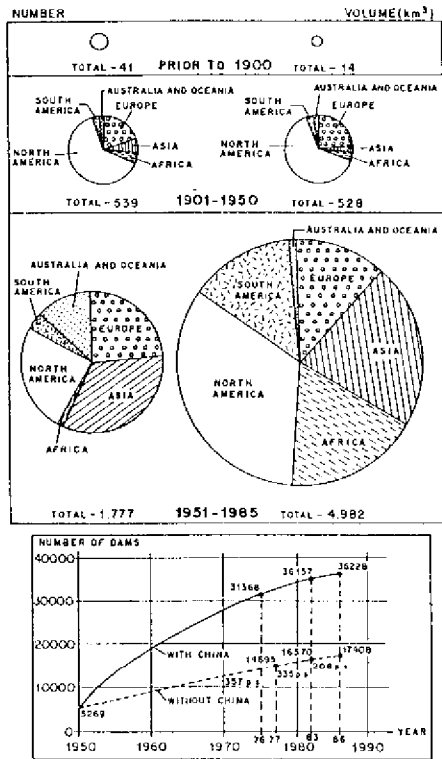

Fig. 1.1 The number and volume of large reservoirs during the period prior to 1985. Redrawn from Lvovich *et al.* (1990).

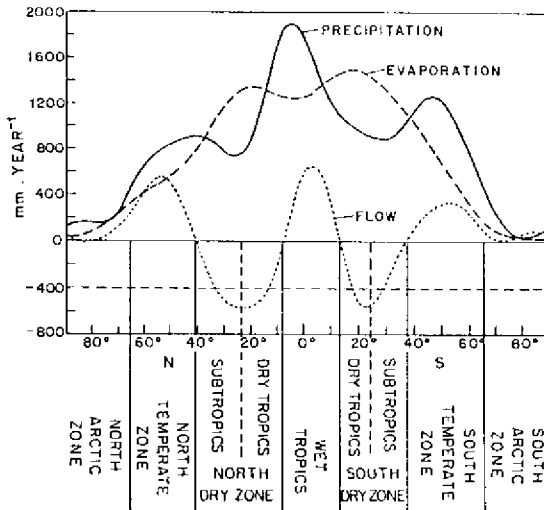

Fig. 1.2 Hydrological budget of the globe and major hydrological regions.

Tab. 1.4 lists the 20 largest reservoirs of the world. These were constructed prior to 1982 or were in construction at that time. Their location as well as the location of reservoirs mentioned in the text are shown in Fig. 1.3.

Tab. 1.4 Twenty reservoirs of the world with the largest volume (from ICOLD 1984).

RESERVOIR	COUNTRY	VOLUME (10 ⁶ m ³)
1 BRATSK*)	RUSSIA	169 270
2 HIGH ASWAN	EGYPT	168 900
3 KARIBA	ZIMBABWE/ZAMBIA	160 368
4 AKOSOMBO	GHANA	147 960
5 DANIEL JOHNSON	CANADA	141 831
6 GURI	VENEZUELA	135 000
7 KRASNOYARSK	RUSSIA	73 300
8 W.A.C. BENNETT	CANADA	70 309
9 ZEYA	RUSSIA	68 400
10 CABORA BASSA	MOZAMBIQUE	63 000
11 LA GRANDE 2	CANADA	61 715
12 LA GRANDE 3	CANADA	60 020
13 UST-ILIM	RUSSIA	59 300
14 KUIBYSHEV	RUSSIA	58 000
15 CANIAPISCAU BAR. KA3	CANADA	53 790
16 UPPER WAINGANGA	INDIA	50 700
17 BUKHTARMA	KAZAKHSTAN	49 800
18 ATATÜRK	TURKEY	48 000
19 IRKUTSK	RUSSIA	46 000
20 TUCURUÍ	BRAZIL	43 000

*) The world's largest "reservoir" is Owen Falls in Uganda with 204,800 10⁶ m³ of water, however, a major part of the water capacity is from a natural lake; therefore this reservoir is best placed in the group we define as "dam lakes".

1.3 GOAL OF THE BOOK AND TO WHOM IT IS DIRECTED

The goal of this book is to present a summary of reservoir water quality management problems, decisive processes that determine these problems, and potential solutions for these problems with special emphasis regarding dam reservoirs. This book is designed for use by three types of professionals: managers responsible for water supply, water quality engineers who deal with applied problems, and reservoir limnologists who study both theoretical and applied topics. We have attempted to cover problems in both temperate and tropical climates and those observed in both, developed and developing countries. Tropical conditions are markedly different, in many respects, from temperate regions, which have been much more thoroughly studied. Methods employed by developed countries are often very expensive in terms of both finances and environmental consequences. Materials and technology, the fabrication and use of which may itself create environmental deterioration, are integral in these methods. In this book emphasis will be placed on cheap, lowtech, nature-friendly approaches that we call ecotechnological. We have not included a description of determination methods of water quality. These methods are similar

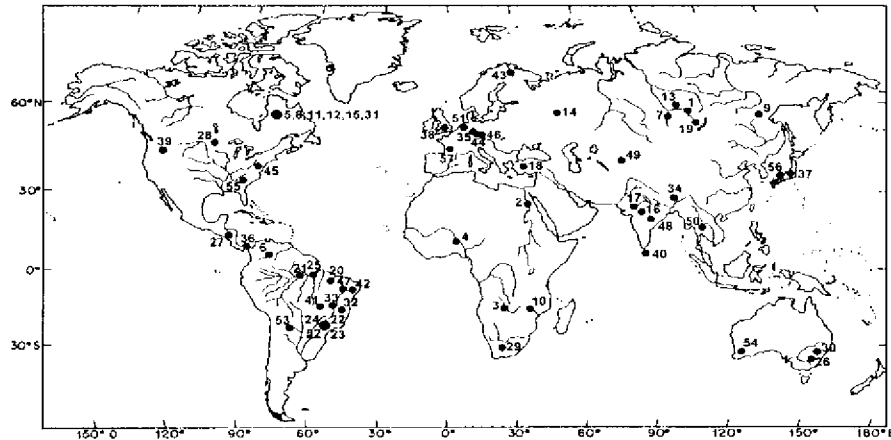

Fig. 1.3 Location of the 20 largest reservoirs and reservoirs mentioned in text. The numbers 1 - 20 correspond to reservoirs listed in Tab. 1.4. Number 21 - Balbina, 22 - Barra Bonita, 23 - Billings, 24 - Broa, 25 - Curua Una, 26 - Eildon Dam, 27 - El Cajon, 28 - Fairmont, 29 - Hartbespoort Dam, 30 - Hume, 31 - Indian Reservoir Complex, 32 - Itaipu, 33 - Itumbiera, 34 - Kaptui, 35 - Kličava, 36 - Lake Gatun, 37 - Lake Yumoko, 38 - London drinking water supply reservoirs, 39 - Moses Lake, 40 - Parakrama Samudra, 41 - Paranoa, 42 - Paulo Afonso, 43 - Porttipahta, 44 - Řimov, 45 - Round, 46 - Slapy, 47 - Sobradinho, 48 - Srinaquatind Dam, 49 - Ukhtarma, 50 - Ujboratan, 51 - Wahnbach, 52 - Xavantes, 53 - Yacuetá, 54 - Canning, 55 - De Gray, 56 - Asahi, 57 - Kleime Kinzig.

to those used in other types of surface waters and a number of books devoted to this problem (WHO 1984, WHO 1988, APHA 1989, Wetzel & Likens 1991, Chapman 1992) are readily available for those seeking further information regarding water quality estimation.

We intend to show:

- managers** - the importance of a whole system approach and respect for water quality problems and the inter-connection of water quality with water quantity problems. We also offer methods of directing water quality monitoring systems and illustrate their use in management,
- water quality engineers** - the need for more advanced theories and inclusion of biological considerations in management decisions,
- limnologists** - the strength of the whole system approach and the need to include the whole watershed, the relations of limnological characteristics with water quantity, and consideration of human activities including socio-economic and political aspects. We also illustrate the usefulness of integration of limnological, social and economical approaches.

Simultaneously it is our intention to urge:

- managers** - to understand the need for coping with the development problems of the present world by switching to approaches that are compatible with sustainable development by changing attitudes towards the global environment with respect for future generations,
- water quality engineers** - to change their attitudes and focus on inexpensive, non-traditional technologies that use nature's capabilities and are compatible with sustainable development,

limnologists - to exceed the boundaries of traditional limnology and develop profound quantitative system approaches and strive toward practical application of results toward solving water quality problems.

1.4 OUTLINE HOW TO READ THE BOOK

Utilization of this book might depend on the interest of the reader and position in one of the previously discussed categories, as well as the reader's familiarity with particular covered topics. Figure 1.4 illustrates our recommendation of how to best utilize this book.

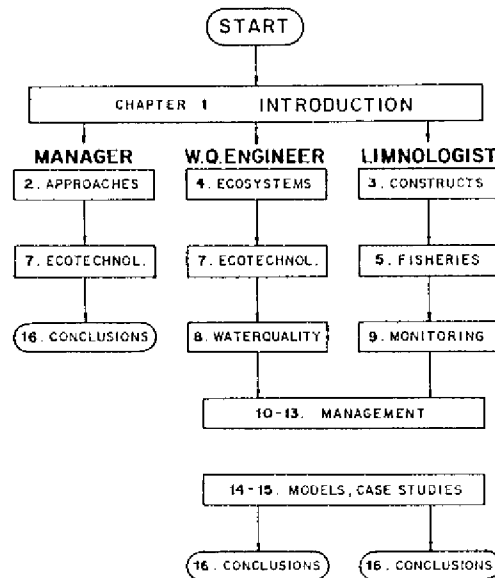

Fig. 1.4 How to follow this book.

Chapter 2 is directed at local managers and presents basic ideas that should be respected during management of a territory where reservoirs are used for any purpose. The technical parameters of reservoirs with different uses and reservoir systems are outlined (Chapter 3).

Reservoir limnology, as relevant to water quality problems, is treated in Chapter 4. We stress that the only functional reservoir management is one that includes system watershed - reservoir - outflow. Specifics of reservoir fisheries suggesting the relationships between reservoir fisheries and water quality are presented in Chapter 5. Major water quality problems that are often encountered in reservoirs are presented in Chapter 6.

Solution of management problems is first discussed in Chapter 7, which covers broad

ecotechnological issues rooted in ecosystem theory. Chapter 8 covers characterization of reservoir water quality and Chapter 9 covers water quality sampling, monitoring and evaluation.

Ecotechnological methods of water quality management are divided into two groups: Management of the watershed (Chapter 10) and In-lake management methods (Chapter 11). Management of specific reservoir types is the subject of Chapter 12, which summarizes common problems and their solutions for such reservoir types as drinking water, recreation and power generation reservoirs. The problems of reservoir outflows are addressed in Chapter 13.

The use of mathematical models as an inevitable tool for managing complex systems such as reservoirs is outlined in Chapter 14 to the extent that an understanding of the use of such models by managers at all hierarchical levels can be achieved. Case studies are restricted to a few well-studied reservoirs. We have attempted to include somewhat similar reservoirs in both temperate and tropical regions.

For those readers who seek additional information, Chapter 17 includes a list of further recommended sources. The references cited in the text are listed separately. For reader-friendliness, the volume includes a glossary of common terms and abbreviations.

CHAPTER 2

ASPECTS AND APPROACHES TO WATER QUALITY MANAGEMENT

This chapter is aimed at regional managers and decision makers who encounter problems with water supply, recreation, fisheries or those involving multiple use of reservoirs. The authors would like to discuss basic concepts of reservoir water quality management and emphasize the importance of these principles. We will also discuss the differences between short term corrective solutions that immediately diminish difficulties and long term solutions that aim to prevent problem creation. Sustainable development and innovative approaches can allow long term successes to be attained.

2.1 WHAT THE MANAGER HAS TO CONSIDER

Management of water resources is a necessary element of wise regional management; an integral element of the management of water resources is water quality management of reservoirs. This is not a simple task because the problems that often occur involve complex biological systems. Water quality problems are influenced by intensively interacting components both within and outside the water system (Fig. 2.1). This evokes a need to consider many components simultaneously. Below we specify categories that must be considered, i.e. general topics, activities within the watershed, technical features of the reservoir, and aspects of water quality.

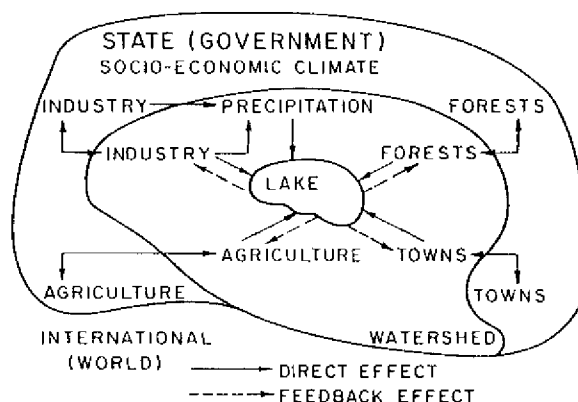

Fig. 2.1 Relations of the water system to its surroundings.

Complex problems necessitate corresponding handling methods. Systems analysis and modeling are helpful approaches. For reservoirs, these approaches are outlined in Chapter 4.1 and more details on modeling are included in Chapter 14.

The most important management items can be summarized as follows:

- * Often the problem to be solved is related to other problems and neglect of these interrelations results in the creation of new, unexpected problems.
- * Solutions should be developed before the problem starts. Planning ahead is an important step toward success.
- * Political decisions that result in short-term solutions are less efficient and less valued by voters than long-term measures.
- * Responsibility to our children and grand-children mandate fundamental attention to sustainable development.
- * New problems may begin to appear continuously as economic activities grow, thus predictions can alleviate or eliminate further problems.
- * Consideration of biogeophysical, economic and social aspects is fundamental.
- * Costs of whole reservoir/watershed management have to be considered before the best solution is decided.
- * Partnership with local industry, commerce, universities and organizations is useful in enabling public understanding of the situation.
- * Environmental impact assessment procedures are useful decision-making tools for new projects or major changes to existing features.
- * Monitoring is an important decision-making tool. However, it has to be properly designed to meet project specific needs and must include methods of data evaluation.
- * Water quality engineers must be consulted for immediate and long-term problems; problems of sustainable development may benefit from the limnologist's perspective.
- * Water availability and quality may limit further economic development. Therefore, prevention of water losses in the territory and the water distribution systems and of universal water-saving devices and procedures is essential.
- * Water quantity and water quality are related. Decreased water quantity results in deteriorated water quality; therefore, more difficulties are expected during dry periods.
- * Water quality is largely determined by activities in the watershed. Clearly detectable pollution sources (point sources) from enterprises are accompanied, and sometimes exceeded in importance, by diffuse, nonpoint sources, such as those related to agriculture, erosion, deponies etc.
- * Most reservoirs are or eventually become multipurpose, which is the basis of conflicts between user groups. Resolution of these conflicts is enabled by joint participation of the respective parties.
- * Reservoirs undergo a process of rapid aging after filling. In the first few years after filling water quality is much worse than in the following stabilized period. Predictions made for the stabilized situation do not reflect these initial years with deteriorated water quality.

From the above outline, there follows a number of more specific, both simple and complex questions that the manager should ask:

- 1) What is the watershed size, area, and the relationship of the watershed area/reservoir area?
- 2) What is the structure of the hydrographic network in the watershed?
- 3) What are the main sources of pollution in the watershed?
- 4) How is the mosaic in the watershed organized? Consider wetlands, riparian forests, other forests and vegetation, agriculture, industry, and settlements. What is the relationship of area between these components?

- 5) What are the types and declination of soil in the watershed, including consideration of their erodibility and effect on water composition?
- 6) What are the predominant soil uses in the watershed?
- 7) What are the consequences of soil uses? Consider erosion, suspended material transportation, transport of pollutants, and contamination of groundwater.
- 8) What are the possible consequences of deforestation in the watershed for rivers and for the reservoir?
- 9) What are the inputs of nutrients (N, P) to the reservoir?
- 10) What is the water retention time of the reservoir?
- 11) What is the composition of reservoir sediments and the concentration of N, P in the sediments?
- 12) Are there contaminants in the sediments? If so, what are their concentrations?
- 13) What is the rate of application of herbicides and pesticides in the watershed.
- 14) What use does the public make of the watershed and reservoir? Include consideration of fisheries, recreation, irrigation, transportation, hydroelectricity, drinking water supply, agriculture in the watershed and types of crops cultivated.
- 15) What are the economic values of the watershed related to the production, recreation and all other uses?
- 16) What historical development has taken place? Consider the current number of inhabitants in the watershed and expected trends into the future.
- 17) What existing database is available? Consider maps, water quality data, climate records, satellite images, human health problems related to water supply and population size.
- 18) What is the state of vegetative cover? Include consideration of both natural vegetation and agricultural crops in the watershed.
- 19) What is the state of wetlands and riparian forests in the watershed? Do any need restoration and/or protection?
- 20) What is the rate of sediment deposition in the reservoir?
- 21) What kind of environmental legislation regulates watershed and reservoir water uses and management policies?
- 22) What are the major existing impacts? Consider industries (type, production, type of waste produced), mining operations (type, production, conservation), agriculture and others.
- 23) Analyze the position and distance of pollution sources in relation to rivers, wetlands and reservoirs.

2.2 APPROACHES TO WATER QUALITY MANAGEMENT

According to the time scale of management, we can distinguish three horizons (Fig.2.2): (i) short term horizons requiring immediate corrective actions to **improve** conditions that are getting worse (**corrective management**) (ii) medium term horizons with management directed at **prevention of** creation of problems (**preventive management**) (iii) the longest time horizon that include accountability for future generations - **sustainable management**. At present emphasis should be placed on medium term horizons while striving toward long-term horizons. Sustainable development is a recent topic and is treated separately in Chapter 2.3.

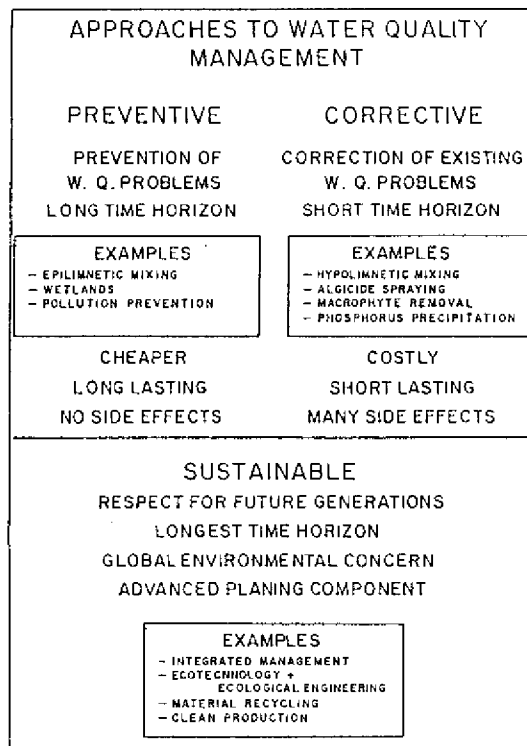

Fig. 2.2 Approaches to water quality management

Corrective (=curative, remedial) management measures are often favored because neither managers or the public view the problems as serious until they become catastrophic. Typical examples of a corrective measures employed in water quality management include spraying lakes with algicides when heavy blooms create conflicts with water treatment and recreation, mixing the reservoir after fish-kills, removal of macrophytes, and spraying with DDT to control mosquitoes.

These types of corrections are usually very costly and their effect lasts only a short time. They are much less effective than preventive measures and, calculated over a longer time period, they are more expensive. It is much less expensive to change the design of the reservoir than to change the constructed reservoir. For example, in Yaciretá Reservoir (Argentina), changes were made in the spill water system during the period of construction that lowered the costs of actions that take place after the closure of the dam.

Additionally, many corrective measures have undesirable side-effects. When some algicides and/or pesticides are used, they accumulate in sediments and the tissues of living organisms and create health problems. A classical example is the use of DDT, which both accumulates in organisms near the point of application and is transported to very remote localities. High concentrations of DDT have been found in some birds in the Arctic, demonstrating the distant spreading of compounds around the world. One classical algicide, copper sulfate, was commonly used to

eradicate blue-green algae that are harmful to domestic animals and humans. Recently, health problems have occurred in several localities where drinking water was treated with copper sulfate. The origin of these problems was discovered to stem from copper that accumulated in large amounts in sediments and was released into the water.

Destratification of the reservoirs is a method employed to improve water quality when treated water has undesirable tastes and/or odors or when fish die from lack of adequate oxygen levels. Compressors are used to accomplish destratification and the noise associated with these is disturbing to recreationists. Also, in several instances, supersaturation of nitrogen has occurred, and resulted in mass fish mortality.

Preventive management differs from corrective management in that the focus is on creating conditions that do not produce water quality problems. Preventative management is not only confined to the planning stage, but is useful if new problems start to emerge. For sustainable functioning of a reservoir, preventive management is the only solution. In this direction limnology provides the necessary background for efficient water quality management. The methods of ecotechnology that are inexpensive and produce the least harm to the global environment (Chapter 7) must be used.

2.3 SUSTAINABLE RESERVOIR WATER QUALITY MANAGEMENT

Sustainable development is most often defined as "*development that meets the needs of the present without compromising the ability of future generations to meet their own needs*".

This definition is the outcome of activities of the Brundtland Commission on the Environment; the environment was the main concern of the World Summit in Rio de Janeiro in 1992. The Rio Declaration on Environment and Development states the following objectives: the concern of human beings for sustainable development; human entitlement to a healthy and productive life in harmony with nature; the necessity of equitably meeting the developmental and environmental needs of present and future generations. To achieve these objectives, environmental protection should constitute an integral part of the development process.

The main document of the Summit, AGENDA 21 (abbreviation for Agenda For The 21st Century, Anonymous 1993), stresses the need of solving accumulating problems in the global environment. We have to solve them before they become unsurmountable. We have responsibility for future generations - to leave resources and conditions that enable their healthy lives and further development.

Those items contained in the document that are related to freshwater resources are provided in Tab. 2.1.

Sustainable development means adequate use of resources that enables continued availability of these resources for use by future generations. Measures to attain sustainable development are directly related to resolution of complexes involving biogeophysical, economic and social

problems by use of long term preventive actions.

Tab. 2.1 Portions of Chapter 18 of *Agenda 21*: Protection of water quality and of freshwater resources.

-
- A. Integrated development of water resources and their management
 - B. Evaluation of water reserves
 - C. Protection of water resources, quality of water and of aquatic ecosystems (main pollution types, biodiversity of aquatic organisms, the role of international organizations, monitoring of water quality)
 - D. Drinking water supply and water treatment
 - E. Water and sustainable development of cities
 - F. Water for sustainable production of food and for the development of rural areas
 - G. Effect of climate change on water resources
-

In this endeavor, consideration of reservoir water quality problems must be an integral part. This includes examination of future demands for reservoir construction very carefully, as building these structures has both positive and negative effects (Tab. 2.3). In addition to means of acquisitions we must seek ways to conserve, avoid increased use, prevent losses and make more efficient use of water resources by decreasing wastage. When conservation issues are ignored, as is usually the case, new reservoirs must be built; careful evaluation of possible sites in respect to expected water quality and damages to the environment must be performed. Preventive actions should be taken, as they are much less costly but much more long-lasting. Extensive changes in the structure of production processes in agriculture and factories are needed in this direction. The losses of millions of tons of soil, nutrients and other potentially valuable materials to reservoirs, lakes and seas have to be stopped; these losses are irrecoverable and produce great damages to water quality and the environment in general. The habit of mankind to solve only immediate problems by any means, without investigating the potential hazards of these activities, must be exchanged for a careful examination of the broad aspects of our environment.

Managers of water quality are responsible, or at least co-responsible, for taking care of sustainable reservoir water quality. A change in attitudes of both managers and the public is necessary to accomplish sustainability for future generations. As applied to the reservoir/watershed interaction, the following activities should be considered by the manager:

- * Introducing low-tech, nature friendly methods of ecotechnology and ecological engineering.
- * Using approaches of integrated management. Integrating managers with engineers, scientists and local community.
- * Putting more effort toward prevention of pollution and deterioration of waters than toward purification and other corrective measures. Demanding focus on "**clean technology**" and pollution prevention rather than costly extraction of the diluted matter by purification. Exchanging "end of the pipe" for "start of the pipe" methods.
- * Implementing programs of recycling of materials that lead to decreased water pollution.
- * Supporting decreased water use and conservation measures.
- * In each case evaluating several possible management options, including innovative ones, to determine the most perspective choice. Considering the global rather than local cost (damage) of each option to the environment. Long term horizons and sustainability of clean water resources

must be the goals.

- * Substituting imission criteria for emission criteria, which presently dominate.
- * Giving more attention to methods for diffuse pollution abatement.
- * Increasing the use of mathematical models for evaluation of specific problems and potential solutions.
- * Introducing methods of intensive monitoring of "global changes" from the hydrological, chemical and biological point of view. Inexpensive and reliable monitoring systems must be manufactured and installed.
- * Supporting decentralized management in addition to the centralized management actions.
- * Evaluating ecological processes such as wetland and riparian forest functions in terms of economic considerations.
- * Preserving the biodiversity of the watershed (terrestrial and aquatic) by protecting and recovering forests and the spatial heterogeneity of the landscape, and by maintaining mosaic habitat patterns including refuges and corridors for animal migration. Headwater and inflow water quality will be protected.
- * Training reservoir managers and water management technicians in innovative management approaches and methods.
- * Improving general environmental education in the region.
- * Teaching industrial managers and local community members about the consequences that their decisions and activities have for available water quality and quantity.

These activities should ensure:

- 1) controlled development to enable long-term maintenance of the water resources and minimization of adverse effects on these and other resources,
- 2) options for future development are not foreclosed, and,
- 3) that efficiency in water and other resource use including capital are key criteria in strategy selection.

One of the follow-ups of *AGENDA 21* is the launching of *GLOBAL WATER PARTNERSHIP* at the 1995 Stockholm meeting. This partnership includes nongovernmental organizations, governmental representatives, multinational banks, United Nations' agencies and professional organizations.

Tab. 2.2 The items to which the *GLOBAL WATER PARTNERSHIP* is aimed.

-
- * Encouraging external support agencies, governments and other stakeholders to adopt consistent, mutually complementary policies and programs;
 - * Building mechanisms for sharing information and experiences;
 - * Developing effective and innovative solutions, including capacity development, toward solving problems that are common to the implementation of integrated water management programs and promulgating practical policies and good practices based on these solutions;
 - * Supporting integrated water-management programs at the local, subregional, regional, river-basin or national levels by collaboration, at their request, with governments and existing partnerships; and by forging new partnerships, and,
 - * Helping to coordinate needs with available resources.
-

2.4 RESERVOIRS AND ECONOMIC DEVELOPMENT OF REGIONS

Reservoir construction interferes with social and economic systems of the region as related to the following aspects:

1) Relocation of populations and interference with productive systems, which are often dependent on the affected river. For example, in Lake Volta, farmers were trained to be fishermen. On the other hand, in Lake Yaciretá (Argentina), fishermen were trained to be farmers. The relocation of populations also changed the social life of the region. Tab. 2.3 summarizes different effects that the construction of Lake Yaciretá has created.

2) Sometimes, inundation of parts of towns disrupts local commerce and industry. Relocation of these areas can produce several conflicts between reservoir proponents and the existing local political and social systems. Below the reservoir, mass fish kills in the river may occur.

Tab. 2.3 Problems created by construction of Lake Yaciretá (Argentina).

-
- * 50,000 people had to be relocated¹⁾.
 - * About 30% of the two largest cities located on the shore was submerged.
 - * The water supply system of cities was disrupted and problems of eutrophication endangered the reservoir supplied drinking water.
 - * Populations in rural areas were affected by relocation and their water supply was disrupted.
 - * Fishermen were forced to move to villages far from the lake and, hence, urged to change jobs.
 - * Oxygen supersaturation created by the overflow caused mass mortality of fish downstream (Fig. 2.1).
 - * Within the reservoir, areas of low circulation were created in some bays that had no inflow; in these areas, anoxic conditions led to fish kills.
 - * Reproduction of some species of fish was increased, but many others decreased.
 - * The need to protect steep banks along the reservoir from erosion increased the cost of construction.
 - * The need to regulate downstream flows decreased the flood regulation capacity of the reservoir.
-
- ¹⁾ The same number of people was relocated in Lake Kariba and Lake Kanji, in Lake Volta it was 70,000 and the greatest number of people to be relocated was in the Lake Naser - 120,000 people.

In many countries, particularly in South America, reservoirs were constructed with the aim of enhancing economic development of the regions. This sometimes produced better use of resources in the area near the reservoir. For example, in the Tucuruí Reservoir, a large scale migration of fishermen occurred after the trophic upsurge began with the filling of the reservoir. In some cases, a system of irrigation was developed and this stimulated local agriculture. The large scale construction of reservoirs in Brazil prevented the implementation of other types of energy production such as nuclear power plants.

A very interesting economic development occurred in the reservoirs of São Paulo State. There, in the Tietê river, a large waterway was created by the construction of six reservoirs. Transportation of agricultural products was enabled and this added an important economic value to the region. Additionally, recreation and tourism were stimulated by this waterway. In Lake Kariba, the introduction of the freshwater sardine *Limnothrix tanganyicae* and the cultivation of a species of crocodile stimulated fisheries and commerce (C. Magadza, personal communication).

These and other experiences lead to a need for balanced decisions weighing pros and cons of reservoir construction. Tab. 2.4 summarizes different aspects to be considered.

Tab. 2.4 Possible environmental effects of reservoir construction. Not all events may occur in each case.

POSITIVE EFFECTS

- * Production of sources of energy - hydroelectricity
- * Creation of low energy water purifiers
- * Retention of water in the area
- * Creation of drinking water and water supply sources
- * Representative reserves of biological diversity
- * Increase of welfare for portions of local populations
- * Creation of recreation possibilities
- * Protection of the outflowing river from flooding
- * Increase in fishery possibilities
- * Water storage for low flow periods
- * Enable navigation
- * Increase irrigation potential

NEGATIVE EFFECTS

- * Displaced local populations
 - * Excessive human immigration
 - * Deteriorated conditions for original population
 - * Health problems created by spread of water-borne diseases
 - * Loss of edible native riverine fish species
 - * Loss of agricultural land and valuable timber resources
 - * Loss of wetlands and land/water ecotones - useful natural structures; loss of the natural floodplain and conversion of wildlife habitat
 - * Loss of biodiversity (unique species); displaced wildlife populations
 - * Loss of mature agricultural land, well cared for generations, such as rice paddy
 - * Excessive human immigration to the reservoir region and increase in many associated social, economic and health problems
 - * Need for adequate compensation for loss of agricultural lands, fisheries grounds and housing as well as compensation for loss of fishing, recreational and subsistence activities
 - * Degradation of local water quality
 - * Decrease in flow rates below the reservoir and increase in flow variability
 - * Decreased downstream temperature and silt/nutrient transport
 - * Decreased dissolved oxygen at the bottom and the outflow of the reservoir (sometimes to zero)
 - * Decreased pH and organic matter content in the outflow
 - * Increased H₂S and CO₂ at the bottom and outflow of the reservoir
 - * Fish migration barrier
 - * Loss of valuable historic or cultural resources. For example, loss of countless Native American burial grounds and other sacred sites in Oregon resulting in the loss of cultural identity for some tribes
 - * Decrease aesthetic values
-

2.5 INTEGRATED WATERSHED MANAGEMENT

In addition to the watershed above the reservoir integrated watershed management also covers the reservoir itself and the river below. However, not just these physical units need be integrated, but also the issues of water quality and quantity, environmental problems and economic considerations. In order to ensure satisfaction of future needs, integrated watershed management aims at long-term decisions, rather than short-term fixes for immediate needs.

Organization of integrated management so that scientifically sound policies and practices that are more effective and anticipate and resolve present and future environmental problems is illustrated in Fig. 2.3.

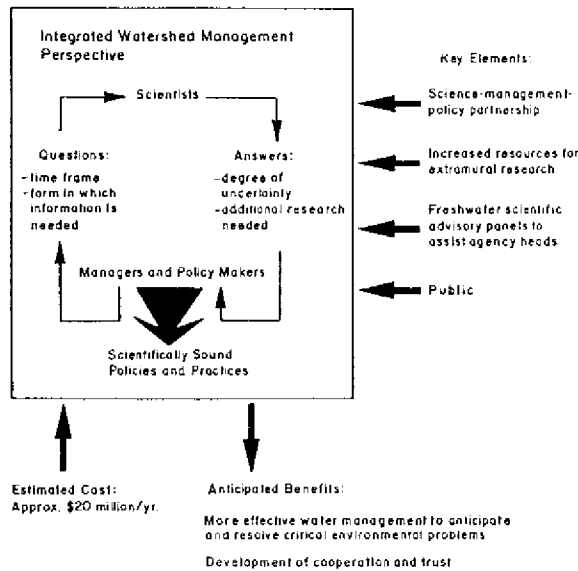

Fig. 2.3 Example of an integrated watershed management.

The figure illustrates that partnership is needed with the management sphere and the scientific and research community; the local population is also involved and is usually represented by organized environmental and or commercial-industrial groups or locally organized ad hoc committees composed of representatives of all the above groups.

For the purposes of appropriate watershed and reservoir management, it is advisable to develop an integrated management information and partnership system. Because local authorities, populations, industries and commerce are both users of reservoir facilities (water, recreation, fishery, boat traffic, navigation) and polluters of the watershed and the reservoir, their participation helps to resolve controversies and integration of management. The nearest university or appropriate research institute should also be involved and may provide advice on possible new management methods. If an agency is funding the regional development programs, reservoir management, or research on the watershed and reservoir, it is advisable to include one of their representatives in the management council. Funding agencies are usually more willing to support well-organized projects and existence of a local management council is evidence of this. An important element of integration might be an information system; this could include data regarding economic activities in the region relevant to water needs and water pollution, potential new water users and expected increases in water use and pollution, as well as data about water use, water pollution, related costs etc. (Strebel *et al.* 1994, Tundisi & Straškraba 1995).

Figure 2.4 illustrates the possibility of creating a local management council that brings together

interested partners for frank, open, direct and frequent interactions. The advantage of a partnership is that members obtain direct information that may give them ideas about potential problems and their complexities and potential solutions. The partnership will enable members to recognize that the solution of the existing problems is not just the singular interest of the reservoir manager but that they themselves will profit if problems are solved. In this way, conflicts of interest are expressed more calmly and resolution is easier to obtain. An example of such local organization is the *ECOSYSTEM CHARTER FOR THE GREAT LAKES - ST. LAWRENCE BASIN*. In 17 points this Charter summarizes the local peoples right to live in an ecosystem that supports their health and well-being as well as that of diverse communities of beneficial organisms and conditions for achieving these goals.

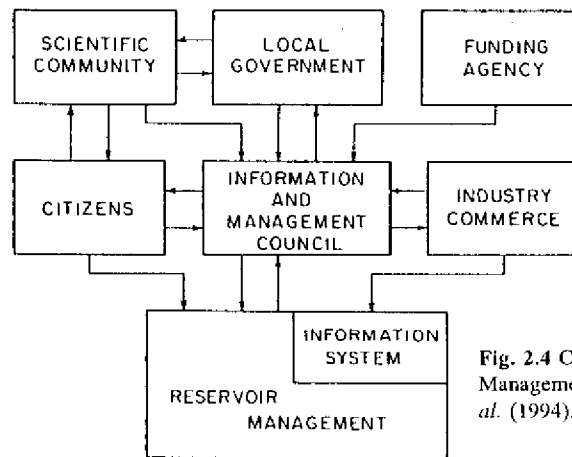

Fig. 2.4 Components of a Local Information and Management Council. Modified from Strebel *et al.* (1994).

Increases in the costs of raw materials, energy, water, pollution fees and increased pressure by environmental groups on industrial enterprises pushes these entities to reconsider their production methods and seek to retain competitiveness while demonstrating good will toward environmental protection. One scientifically rooted procedure with broad consequences that is favored by large international trusts is the **life cycle evaluation** of products. The evaluation consists of following a product throughout its whole life cycle, from creation to disposal. It includes the following: mining raw materials; processing for basic chemicals or metals; transportation, production of final materials needed for the product; production of the final product; packaging and distribution and also the product's fate and environmental consequences upon use and, finally, disposal of remains or unused parts (e.g., packing materials, non-functioning parts or non-repairable damaged products). Each step is evaluated regarding the economy of the product, including the needs for materials, energy, and water and environmental consequences. This evaluation procedure is illustrated in Fig. 2.5. Many factories that have implemented such an evaluation have found considerable savings are obtainable and hence an increase in competitiveness. This is accompanied by considerable savings in water and energy resources and consequently reduces pollution. Therefore, it is hoped that this procedure will become widely used and will benefit water quality. Water quality managers must stress the usefulness of this procedure to press towards such evaluations. Local water management councils may be very helpful in this direction.

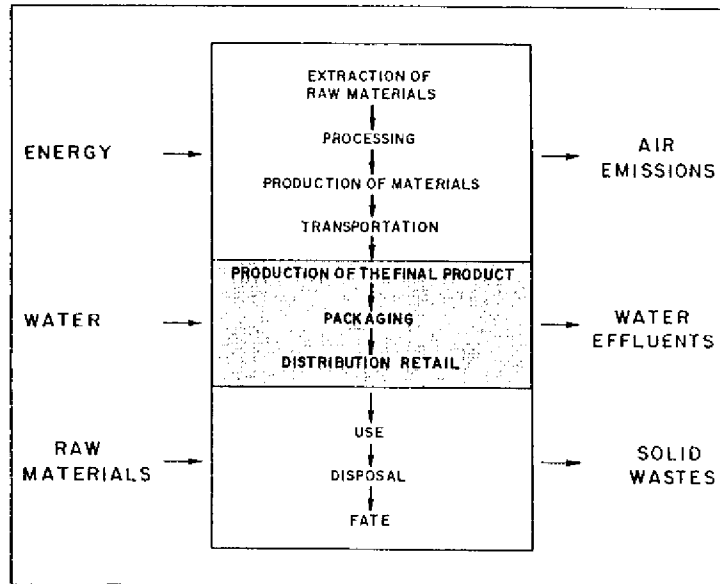

Fig. 2.5 Life cycle evaluation of a product.

In integrated management, consideration should be given to the economic advantages resulting from multiple use of the reservoir. After a defined period that may vary between 10 and 20 years of evolution of the region around the reservoir, the economy diversifies as beneficial uses of the reservoir complex develop upstream and downstream (tourism and recreation, irrigation, fish farming). Consequently an economy that may have been exclusively dependent upon a power plant, can begin to make good use of the whole reservoir system and flourishes. An equally important consideration in integrated management is the further use of the supporting infrastructure of the dam site. This infrastructure (buildings with their engineering systems like telephone connections, sewers, water supply) is deactivated after closure of the dam and the start of operations, and thus, can be utilized for training courses and establishment of research activities.

2.6 ENVIRONMENTAL IMPACT ASSESSMENT

The method that is most useful in assessing the effects of potential new economic activities while simultaneously involving local populations in the decision - making process is the Environmental Impact Assessment (EIA). We may distinguish two basic situations in which EIA should (or must) be applied: (i) before decisions are made about reservoir construction, and (ii) when an addition to a previously designated reservoir use is necessary (the reservoir will become multipurpose) or new construction or economic developments must be included in management of the reservoir watershed.

Any EIA of a reservoir will be based on the reliability of available data, thus, the reliability of the data will affect the accuracy of the EIA. Permanent monitoring of the reservoir using an appropriate and continuous sampling program should produce a good data base. Such programs function as a sensor in the watershed and reservoir. Establishment of a special multidisciplinary team that has specialized experience in EIA and extensive field knowledge in the region is the ideal situation, but is not easy to achieve. Before construction of the reservoir, an analysis of how use of natural resources and how local social economy relates to the ecology of the region should be completed. To be effective, an EIA should be started several years prior to the construction of the reservoir and should include cause-and-effect relationships, rather than just structural details. Disruption of processes integrated across land-water interfaces needs both qualitative and quantitative evaluation. Inadequate EIAs result in poor assessments of economic impacts and erroneous estimates of appropriate compensation for losses. The preparation of an EIA follows general procedures and steps (Fig. 2.6) which need to be modified for each specific project. The scope may also depend on the amount of knowledge already accumulated for each specific project.

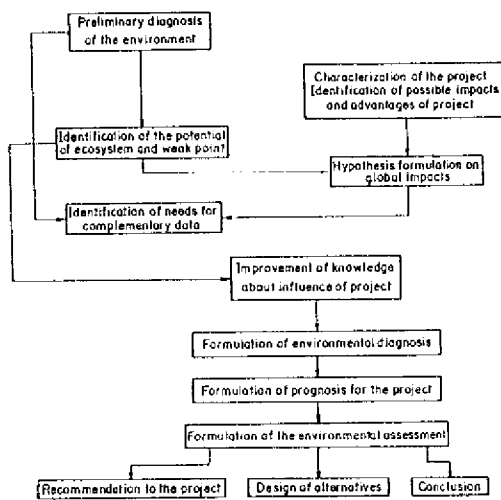

Fig. 2.6 Steps of the Environmental Impact Assessment.

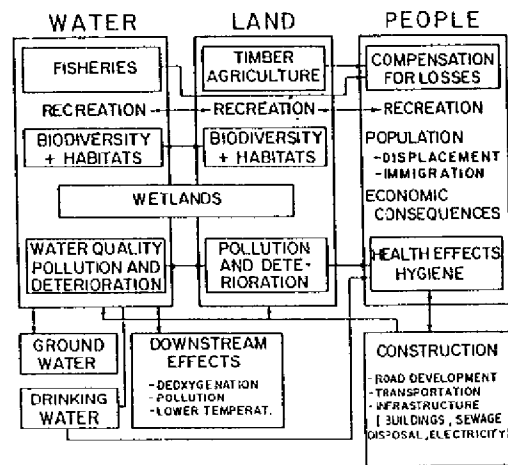

Fig. 2.7 Variables to be taken into account for an Environmental Impact Assessment.

Figure 2.7 illustrates possible variables to be taken into account, when implementing an EIA for a watershed or a reservoir before construction begins.

2.7 HUMAN ACTIVITIES WITH MAJOR IMPACT ON FRESHWATER RESOURCES

Table 2.5 lists some activities that have major impacts on freshwater resources and, in particular, reservoirs. These impacts are discussed in the following sections.

Tab. 2.5 Major impacts of human activities on inland aquatic ecosystems.

- * Deforestation
 - * Mining operation
 - * Road and railroad construction
 - * Reservoir construction
 - * Discharge of sewage and other wastes
 - * Urban development
 - * Agriculture and agroindustry
 - * Irrigation
 - * Salinization and waterlogging of irrigated fields
 - * Recreation and tourism
 - * Waterways construction and water transport
 - * Channel construction, river channelization and water transfers
 - * Wetland destruction
 - * Population displacement
 - * Introduction of exotic species
 - * Inadequate exploitation of biomass
 - * Water transfer and water withdrawal leading to decreased groundwater recharge
 - * Atmospheric pollution from industry and car exhausts causing acid rain
-

Deforestation. Forest removal along river banks produces several undesirable changes in ecological processes, such as reduction of allochthonous materials available to rivers and loss of a "filter system" for nutrients and suspended material. Disappearance of riparian forest deprives waterfowl and other wildlife of food and shelter. Thus, the function of a "buffer zone" between the terrestrial system and the river is lost. Increased siltation of waters is another consequence.

Mining. Gold mining by filtration of sediments from the bottom of the river is an important impact. Because gold near the river is amalgamated with mercury, contamination of organisms in the river food chain will occur. Sand and bauxite mining are two other operations that disrupt ecological processes. Coal and iron mining also have direct and indirect effects on freshwater ecosystems.

Road and railroad construction. Road and railroad construction cause major changes in wetlands and small rivers. Immediate impacts occur both during and after construction. Increased erosion results in increased eutrophication due to increased nutrient loads simultaneous reduction of light availability to algae and higher plants during periods of increased turbidity.

Reservoir construction. Construction of reservoirs upstream may interrupt natural inundation of wetlands and floodplains. This changes water quantity and quality considerably.

Discharge of sewage and wastes. Untreated wastes from point and non-point sources cause several changes in the food chains of rivers, floodplains and wetlands. Discharge of untreated sewage and sewage with only primary and secondary treatment (no nutrient removal) from cities is resulting in severe eutrophication problems. Discharge of agroindustrial wastes from the food processing industry, such as fertilizers, herbicides, pesticides and residues of agriculture impairs water quality.

Urban development. Sewage from cities results in more per capita pollution than sewage produced in rural areas with latrines and septic tanks. The same is true for accumulated solid wastes.

Agriculture and agroindustry. Improper storages of fertilizers, agrochemicals and manure are a major non-point source of pollution. Excess fertilizers, resulting from improper application, are not incorporated by plants and enter run-off during rain events. Erosion is increased by agricultural practice and results in greater reservoir siltation. Water storage losses of the territory are also of importance. Salinization and waterlogging of irrigated fields may also result from agricultural practices.

Irrigation. This major cause of extensive salinization is particularly troublesome in semiarid areas. Excessive irrigation projects often result in major disasters, such as the Soviet cotton project that left the Aral Sea changing into a dust bowl, with rusting trawlers abandoned in the salty sand. Related local health problems are enormous.

Salinization. There are several reasons for salinization: use of salt associated with fertilization, use of salt for road deicing, irrigation and natural excess of evaporation over precipitation in certain regions and periods.

Recreation and tourism. Rapidly growing tourism, summer housing, aquatic sports (in particular motor boating), swimming, sport fisheries and other kind of recreational activities are not compatible with production of a reliable drinking water supply. Additionally, these activities increase demands for construction of roads, hotels and other facilities.

Waterway construction and navigation. Construction of transport features (locks, river straightening) can destroy natural river functioning, slow down or increase water flow velocities, and increase bottom disturbance and bank erosion.

Channel construction, river channelization. These major technological actions often related to waterways construction have negative consequences on the hydrology of the region, available water reserves, and biological distributions. The perspective that protection against floods should be achieved by construction of higher and higher dams ironically leads to increased flood damages. Water, rather than being stored within the territory in wetlands, meandering rivers, oxbows and forests, flushes unhindered to lower river reaches. The town of Utrecht in Holland was very recently threatened by the danger of being flooded to a height of 5 meters and is good example of the kind of disasters awaiting countless other cities.

Wetland destruction. Wetland losses are leading to decreased water capacity in the territory and loss of habitats for many species of plants and animals. Groundwater level recharge is decreased in certain areas, but increased in others; the consequences of these changes on crop production can be devastating.

Population displacement. When concentrations of people are relocated, construction of settlements and summer houses that lack systems of waste purification cause increases in water

pollution, eutrophication and hygienic problems.

Introduction of exotic species. Introduction of both aquatic and terrestrial species causes changes in the local food chain. For example, the intentional or accidental introduction of predatory fish often leads to loss of valuable local species. In Eastern Brazil the introduction of *Eucalyptus* produced extensive alterations in the chemical composition of lakes (Saijo & Tundisi 1987).

Inadequate exploitation of biomass. The removal of key species of terrestrial and aquatic organisms leads to changes in the landscape and aquatic environment.

Water transfer and water withdrawal leading to decreased groundwater recharge. Excess withdrawal of water leads to emptying the reservoirs, which is connected with decreased water quality. Water transfers, especially long distance ones, may be dangerous due to unexpected consequences for the regions, for the aquatic fauna. Decreased groundwater recharge leads to drying wells, drying vegetation, losses in agricultural crops.

Atmospheric pollution from industry and car exhausts causing acid rain. Acid rain with the consequent acidification causes major changes in the composition of aquatic chemistry and biology. The appearance of toxic forms of aluminum and other heavy metals has negative effects on forests and waters.

CHAPTER 3

TECHNICAL ASPECTS OF RESERVOIR CONSTRUCTION

3.1 RESERVOIR USES

Most reservoirs were built for a single purpose. Ancient reservoirs were usually constructed beside a river. After preparing the selected site, a channel leading from the river was excavated and used to fill the reservoir. From the point of view of water quality management these impoundments are markedly different from more dominating dam reservoirs, which are constructed by damming a river. In this book, we do not deal with specifics of impoundments, rather we emphasize specifics of dam reservoirs. Historically reservoirs were first constructed for irrigation. In more recent years, the first reservoirs were built for flood protection; other uses followed, including augmentation of river flow for irrigation of crops below the reservoir; navigation; drinking water supply; fisheries; industrial water supply, and; most recently, power generation and recreation. Fishery resources were usually a by-product, induced in temperate regions for recreation, and in the tropics for food production. With time, most reservoirs have served secondary functions.

Storage of a certain **quantity of water** is usually the primary interest of the reservoir manager. With increasing environmental degradation and multiple use of reservoirs, water quality has become a issue of great concern. Drinking water supply has the greatest requirements for high water quality. In addition, some technical processes require water that possesses specific quality parameters limits, and fishes cannot thrive and remain edible for humans in highly polluted waters. Recreational values, another recent reservoir use, also necessitate relatively clean water.

These two aspects, quantitative and qualitative, are closely coupled; we cannot use more water than the available quantity and low water levels bring about water quality deterioration. This relationship is a typical complication for reservoirs and is the source of a number of management difficulties. Damage to domestic or industrial water supply, fisheries and or recreation interests downstream of the reservoirs are also of concern. Damages to reservoir outflows occur even when the reservoir water itself is not the cause of these water quality difficulties: the causes can be low water flows and nutrient rich outflows. Multiple use of many tropical reservoirs create conditions that facilitate the spread of water-borne diseases.

In addition to the major uses for which reservoirs are built, they have many other functions:

- 1) They serve as water purifiers by eliminating impurities and retaining sediments, organic matter, excess nutrients and of other pollutants (Chapter 4).
- 2) They very often serve as a recreation site, with on-lake activities such as swimming, canoeing, motor boating, sailing, boardsailing, water skiing, angling, rowing, and ice-skating and on-shore activities such as angling, walking, bird-watching, sun-bathing, and camping.
- 3) They represent a biological resource that can be the site of the following agricultural uses: fish breeding, caged fish farming, mussel farming, and plant production including reeds and other

aquatic crops.

4) Some parts of reservoirs serve, or can be preserved for conservation areas for aquatic plants, birds and other animals as well as areas of aesthetic value.

Construction features (for example, the reservoir water volume in relation to river flow or in relation to the location of intakes and outflows) affect water quality conditions within the reservoir. Construction characteristics are related to the primary purpose for which the reservoir was built. The primary purpose affects reservoir size, as given by site selection for dam construction, height, as determined by valley morphometry, volume stored, and capacity relative to flow, which determines the reservoirs retention time (Tab. 3.1). However, these parameters are only average features and variability of specific reservoir characteristics and uses is high.

We previously discussed some of the primary purposes for which reservoirs have been built. Other single purposes include irrigation, navigation, recreation and sewage disposal. However, in recent years most reservoirs are multipurpose, either by design or conversion after construction. Nowadays, it is common that all kinds of reservoirs are used for recreation, electricity generation, etc. This results in conflicts between various users that must be resolved by managers.

Tab. 3.1 Features of reservoirs constructed for various primary purposes

PRIMARY USE	SIZE	DEPTH	RETENTION TIME	OUTFLOW DEPTH
FLOOD PROTECTION AND FLOW REGULATION	small to medium	shallow	regionally dependent	surface
WATER STORAGE	small to medium	---	extremely variable	below surface
HYDROELECTRICITY	medium to large	deep	variable	near-bottom
DRINKING WATER SUPPLY	small	preferably deep	high	intermediate to deep
FISH CULTIVATION	small	shallow	low	surface
PUMP STORAGE	small to medium	deep	extreme variability	near-bottom
IRRIGATION	small	shallow	long	surface
NAVIGATION	large	deep	short	whole profile
RECREATION	small	shallow	long	surface

From a water quality perspective, the location and shape of the reservoir outlets (both to the river below and offtakes for different purposes) is the single most important technical feature that must be designated for each dam reservoir.

3.2 IMPORTANT VARIABLES OF RESERVOIR HYDROLOGY

3.2.1 Reservoir construction on the river continuum

A continuous gradient of physical conditions exists from the headwaters to the mouth of undisturbed river systems. Conditions for reservoir construction along the river as well as conditions for biota depend on the position of the reservoir in the river network. Twelve stream orders were distinguished in a system of classification by Ward & Stanford (1983). Under this

system, the first order represents creeks that flow directly from a spring, while second order streams result when two first order streams join, and third order streams result when two second order streams join, and so on. When a reservoir is built along a river's length, the physical, chemical and biological conditions of the river are disrupted to some greater or lesser degree. The effects on areas downstream of a reservoir are determined by the position of the dam along the river, and correspondingly by the stream order. Some distance below the dam, riverine conditions may return to natural characteristics of the undammed river (Fig. 3.1). A 're-set distance' is a calculation of the recovery distance for a particular set of variables and expresses the degree of perturbation of river conditions (Ward *et al.* 1984).

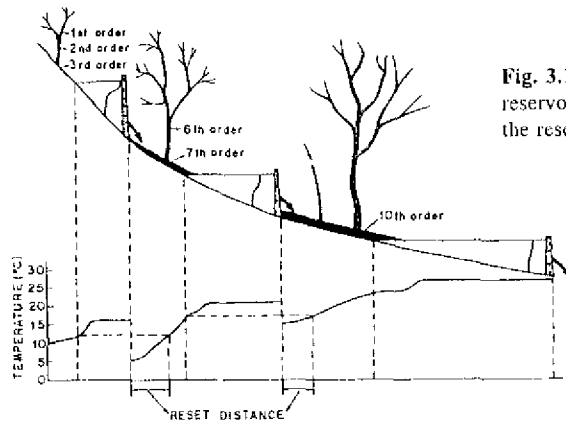

Fig. 3.1 The effect of stream order on the reservoir characteristics and characterization of the reset distance below a reservoir.

From the viewpoint of reservoir water quality, both the location of the dam in relation to its position in the stream order sequence and dam elevation determine numerous important hydrologic reservoir features. These include rates of flow, landscape patterns in the river valley, temperatures of inflowing streams, level of insolation, degree of turbidity and consequential underwater light regime, and nutrient chemistry, which affects reservoir biota. As an example, Fig. 3.1 illustrates some major differences between reservoirs that are located on streams of different orders:

(A) A reservoir located on a low order stream in mountainous areas that are undisturbed by civilization is fed by a small creek with the following predictable characteristics: low flow, temperature, input of organic matter, and nutrient salts, sparse plankton levels and a characteristic assemblage of fish species that feed on benthos. The reservoir is typically located in a deeply incised valley that has extremely steep riparian slopes. This mountainous position is usually characterized by low temperatures, high humidity and precipitation levels and isolation. Such a reservoir can only result in a deep, stratified, flow through and oligotrophic system. Horizontal gradients will be scarce or nonexistent. Any differentiation between such reservoirs that are in the same geographical region will be due to geological features (calcareous or noncalcareous underlying rock) or environmental characteristics such as the degree of exposure to sun and winds (affecting temperature and mixing).

(B) A reservoir that is constructed in the middle reaches of a river is fed by a river with the following general characteristics: medium flow, moderate declivity, average temperatures,

increasing levels of natural organic matter and nutrient salts, occasional turbidity, a developed phytoplankton community, and an assemblage of fish that can survive in standing water. The limnology of an unpolluted reservoir is largely determined by the morphology of the valley; namely shallow reservoirs will be unstratified and deep reservoirs will be stratified. Another important determinant is the theoretical retention time determined, for a specific flow, by the volume of the water body. Retention time can vary within wide limits. In small reservoirs with very low retention times, horizontal gradients will be low, stratification will not be very pronounced and planktonic biomass will not be well developed. Larger reservoirs with long retention times will exhibit well-developed horizontal and vertical gradients of physical and chemical variables, reasonable plankton growth and fish assemblages normally found in lakes.

(C) Reservoirs that are constructed on large lowland rivers with very gradually sloping banks will be characterized by inundation of large areas, extreme horizontal variability with well-developed wetland communities with extensive shallows with riparian vegetation. Such reservoirs are usually eutrophic and high natural organic loads are likely to contribute to the formation of an anoxic hypolimnion. Shallow reservoirs are usually well mixed by wind, thus, stratified conditions only develop in areas where the depth exceeds levels affected by wind-mixing.

3.2.2 Flow and retention time

The ratio of the reservoir volume, V , to the inflow rate, Q (per day or per year) determines the theoretical retention time of the reservoir (V/Q), which is also known as water residence time, hydraulic detention time, retention rate or flushing rate. The theoretical retention time is determined from the following relationships:

$$R = V / Q \text{ [days]}$$

where Q is the average flow rate per day (=flow rate in $\text{m}^3.\text{s}^{-1}$ multiplied by the number of seconds in a day, 86400), and

$$V \text{ is the reservoir volume in } \text{m}^3.$$

To be more precise, retention time should be calculated for each year or each appropriate shorter time period. If the water level and hence the actual reservoir volume vary substantially, the figure should be calculated separately for each subperiod (week, month) and averaged.

Theoretical retention time is realized during reservoir filling; the actual number of days necessary for reaching full storage capacity is obtained (under actual flow and precipitation conditions present during the period of filling - these may be quite different from long-term averages). R gives no information about actual average retention times of water parcels within the reservoir. There may be occasions when water parcels traverse the path from inflow to outflow in times that are much shorter than calculated theoretical retention times (this is commonly referred to as short-cut current or underflow). Water level fluctuations not only cause changes in the retention time, but also may encourage increased erosion of the shores, and may cause higher turbidity levels and other negative water quality effects.

Retention time is related to major water quality differences between reservoirs. This axiom is more pronounced for deep and stratified reservoirs than it is for shallow unstratified reservoirs. Additionally, the flow from the input river has a more drastic mixing effect in the former than the latter.

Dam reservoirs typically exhibit longitudinal zonation caused by unidirectional water flow.

3.2.3 Reservoir depth, size and basin morphology

The depth of the reservoir has a major influence upon water quality. Of particular importance are the depth relative to the surface area and wind intensity of the given region. This is because these factors effect the intensity of mixing in the reservoir. We call a reservoir **hydrologically shallow** if it is fully mixed by wind activity and **hydrologically deep** if the intensity of mixing is not strong enough to prevent stratification of the water masses (for more detail see Chap. 4).

The size of the reservoir is therefore related to mixing conditions. We can distinguish the following size categories (Tab. 3.2):

Tab. 3.2 Size categories of reservoirs.

CATEGORY	AREA [km ²]	VOLUME [m ³]
large	10 ⁴ - 10 ⁶	10 ¹⁰ - 10 ¹¹
medium	10 ² - 10 ⁴	10 ⁸ - 10 ¹⁰
small	1 - 10 ²	10 ⁶ - 10 ⁸
very small	< 1	< 10 ⁶

Basin morphology is determined by the characteristics of the original valley that was filled. The usual profile is triangular and is shallow at the river entrance and deepest adjacent to the dam. The location of the reservoir, as compared with naturally occurring lakes, is eccentric, in that lakes usually occupy a central position in the watershed.

3.2.4 Outlet location

Reservoirs that provide primary or secondary functions as water storage facilities for a variety of uses can be divided into the following types as distinguished by outflow design: those that have a simple outflow that directs water into the river below the reservoir and those that have outlets that are designed and directed for a specific purpose. For both of these types, the location (particularly elevation) of the reservoir, design of the outlet structure and associated operational releases are hydrological factors that have a bearing on water quality. This is because the outlet design effects flow and stratification conditions within the reservoir. Water quality changes rapidly in strongly stratified reservoirs if a large amount of outflow takes place at certain levels. Therefore, these changes must be considered when selecting a level of corresponding water quality based on previous observations. Usually, water can flow out of a reservoir from one of the following three depths: from the surface (flow over the reservoir crest), from the bottom (bottom release), and through the outflow to turbines or the river downstream. Figure 3.2 illustrates the depth location of the offtakes for a number of selected reservoirs. In some instances, the outflow is positioned in a particular depth and in dam reservoirs that are used primarily for hydroelectricity generation the opening is usually quite large. In some instances, the outlet structure is large enough to drain the entire reservoir. These features are important because they co-determine reservoir water quality stratification, as is further discussed in Chapter 4. The differences in water quality between reservoirs and lakes are explained dominantly by the existence of surface outflows in lakes versus deep outflows - typical characteristics of reservoirs.

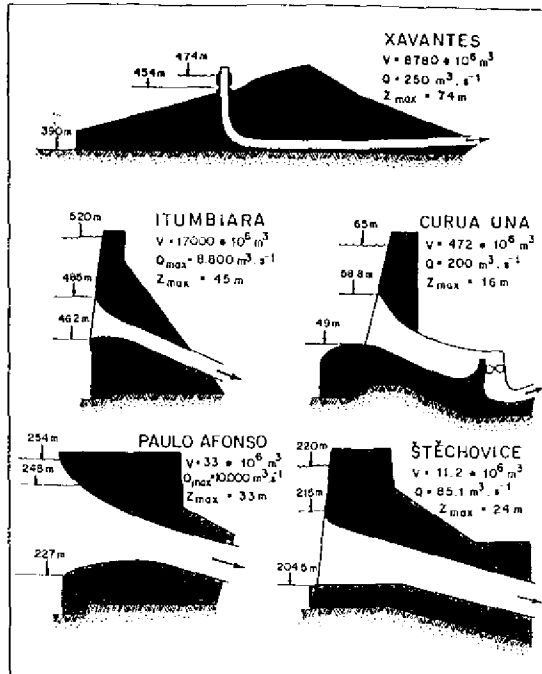

Fig. 3.2 Profiles of selected dams with emphasis to the outlet depths and shapes.

Multiple outlet structures are sometimes included in dam construction to improve the quality of raw water that is treated and used for drinking water. These modifications enable offtake of water from different depths that may, at given time periods, possess the best available water quality. However, stratification of water quality within the reservoir depends on, among other things, the outflow of particular water layers. Intensive offtake from one level causes great changes in stratification. Therefore, although a layer with the best water quality may have been detected this location may change during intensive offtake.

3.3 RESERVOIR SYSTEMS

The term reservoir systems refers to multiple reservoirs that are connected hydrologically and whose operation is interrelated toward fulfilling some common goal or goals, such as water supply or generation of electricity. Four types of reservoir systems are illustrated in Fig. 3.3. **Reservoir cascades** are chains of reservoirs that are located on one river. **Reservoir multisystems** are groups of reservoirs that are located on different branches of one river system or on several river systems and whose releases of water are shared. **Reservoir pumping schemes** are characterized by pumped water that circulates between reservoirs. **Water transfers** are represented by one or a series of reservoirs from which water is pumped to another river system for increasing its discharges. Water quality of reservoir systems is described in Chapter 13.5.

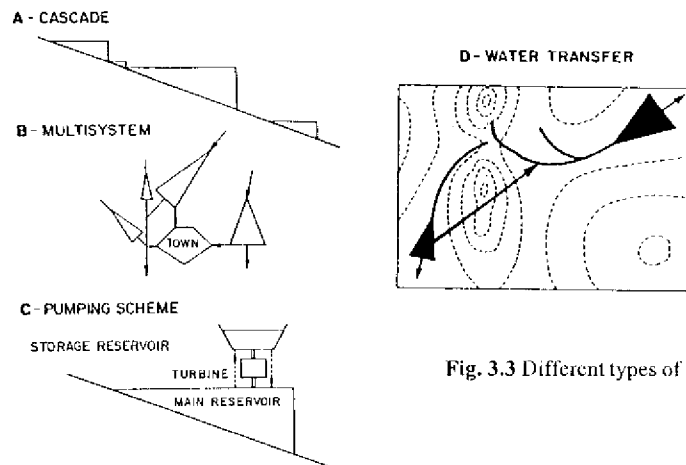

Fig. 3.3 Different types of reservoir systems.

From a water quality standpoint, reservoir cascades are specific because any effect on an individual reservoir will be transferred to those below it. In a reservoir cascade, the water quality of the top reservoir is usually similar to the water quality of a solitary reservoir. The water quality of the second and lower reservoirs are usually all modified. The extent to which a reservoir modifies the water quality of another reservoir below it depends upon whether the higher reservoir is a deep, stratified reservoir (profound effects) or a shallow reservoir (less effects). The intensity of these influences depends upon the connecting stream order, trophic levels in the reservoir and the distance between reservoirs. Reservoirs that are located on higher order streams and have greater retention times have greater effects upon the outflowing river. The distance between one reservoir and another is also relevant; at a distance of several hundred kilometers from the reservoir, the river resumes a natural state and water quality effect from the upper reservoir are no longer observed. This effect is most important where reservoirs are closely situated.

Reservoir multisystems are complex water storage schemes that are used for multipurpose water supply in locations and periods when there is a water shortage particularly in countries with water deficits. Their water quality is usually characterized by great irregularities related to changes in flow. In particular, when participating reservoirs belong to different geological formations and nutrient types, simultaneous management of water quantity and water quality issues for each reservoir may be difficult.

Pumping schemes are implemented because electricity needs are usually irregularly distributed during different parts of the day and over different days in a week. There is an excess of electricity during certain periods and insufficiency during others. In a period of excess electricity, water is pumped uphill to a reservoir, often one of restricted size. The elevation difference is used

to intensify energy production during periods of increased needs. Water quality will be affected primarily while pumping or release is in progress. Water quality usually does differ significantly between the two water bodies, however, in some cases substantial changes in water quality may take place.

Water transfers were constructed as large and extensive aqueducts in ancient times. The amount of water transferred by these ancient systems into other watersheds was not large. Nowadays however, several more recently constructed schemes have attained enormous water transfer capacities. This can effect not only water quality, but also the water budget of the region. An example of this phenomena is the Aral Sea, which changed from a flourishing lake to a dust bowl after mismanagement. Extraction of large amounts of water for overly ambitious irrigation projects designed to support huge state cotton farms during the communistic regime in Russia, resulted in alteration of the water budget for the region.

Water transfers can produce many changes. Sometimes, they become major pathways for the transmission of water borne diseases. They are also responsible for loss of water quality and complex chemical effects. Water transfers may affect local populations. When water transfers are related to irrigation, they may cause high salinization in certain regions.

In the semiarid regions of south-east Australia, extensive water systems were implemented in the 1920s to transfer water from water-rich rivers that flow from the Australian Alps into the Pacific Ocean to vast dry territories in New South Wales and South Australia. Salinization connected with crop irrigation has created many agricultural problems and "dead" areas.

CHAPTER 4

RESERVOIRS AS ECOSYSTEMS

To address water quality concerns, the reservoir must be treated as an ecosystem consisting of a number of interacting subsystems. From the reservoir water quality point of view, it is useful to distinguish the following subsystems (Fig. 4.1):

- the **watershed and the reservoir inflow(s)**,
- the **reservoir proper**,
- the **reservoir outflow(s)**,
- the **socio-economic and management subsystem**.

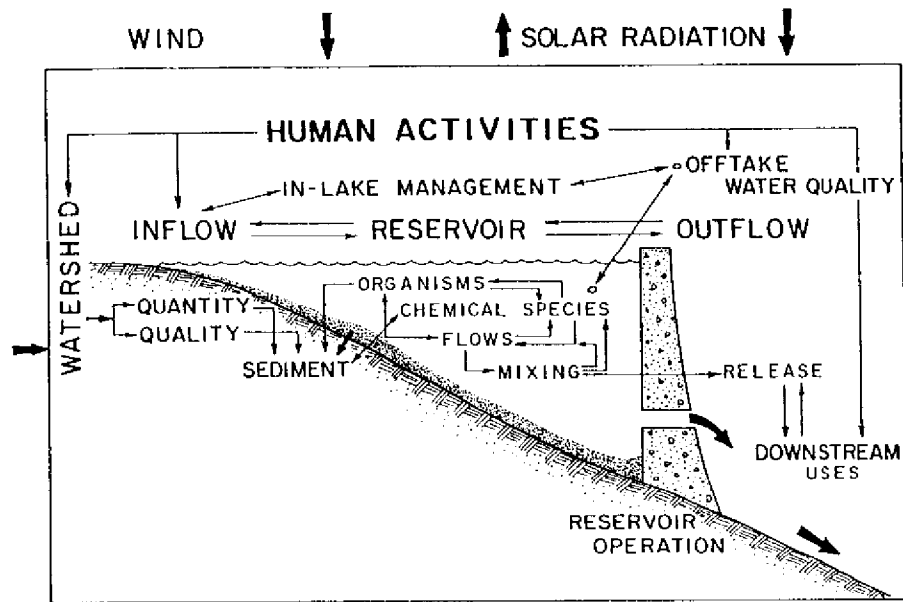

Fig. 4.1 Major components of the reservoir ecosystem: watershed and inflow, reservoir proper and reservoir outflow. Human activities as a component of the ecosystem.

The **watershed**, including natural elements such as climate, precipitation, vegetation, and human activities, creates the character of water that flows into the reservoir, distribution of this water over time and affects water quality within the reservoir.

The water quantity and water quality characteristics of the **reservoir inflow(s)** are the dominant determinant of water quality within the reservoir. Using knowledge of the inflow(s) water quantity and quality, it is possible to predict potential reservoir water quality before construction. Because inflow water quality is so important, the reservoir is very sensitive to influences caused

by any activities within the watershed.

The **reservoir proper** is a collector and digester of input and effects within the watershed. Effects within the watershed include internal physical, chemical and biological processes and these in turn effect water quality within the reservoir (Fig. 4.2). The reservoir water quality dynamics can be subdivided into the physical, chemical and biological subsystems, but more detailed subdivisions can be also used.

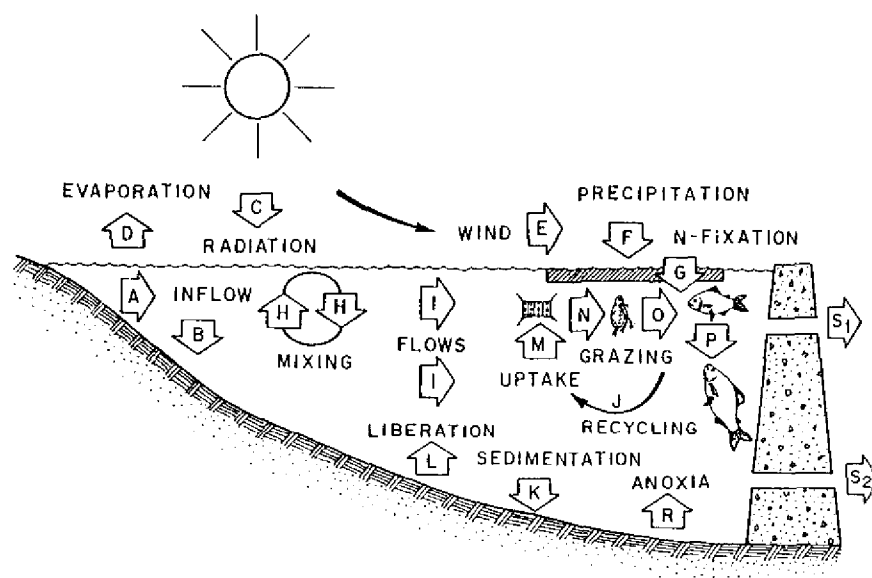

Fig. 4.2 Processes within the reservoir proper. The processes A to E and H and I as well as S belong to the physical subsystem, processes F, G, K, L and R to the chemical subsystem and the remaining represent the biological subsystem. All three subsystems are highly interwoven.

The water quality of the **reservoir outflow** is determined by the water quality at the depth of the reservoir outlet(s). Additional water quality changes may occur due to processes at the reservoir outlet, use of turbines and/or spillways, and changes in gases related to altered hydrostatic pressure and contact with the air. Water quality may also change down-river of the outlet.

The **management and socio-economic subsystem** consists of reservoir uses, laws regulating water quality and quantity and the management system that is responsible for determining actions necessary to cope with demands.

Mutual interactions between subsystems are very important. The watershed determines inflow water quality, which affects decisions concerning activities in the watershed. Water quality in the reservoir, determines outflow water quality, and poor quality outflow affects decisions concerning the reservoir. Each of these systems is part of a broader environment, for example a reservoir is part of its geographical surroundings, socio-economic conditions of a political region exceeding

the given watershed, and developments anywhere in the world may result in problems such as air pollution that may affect water quality in a specific reservoir.

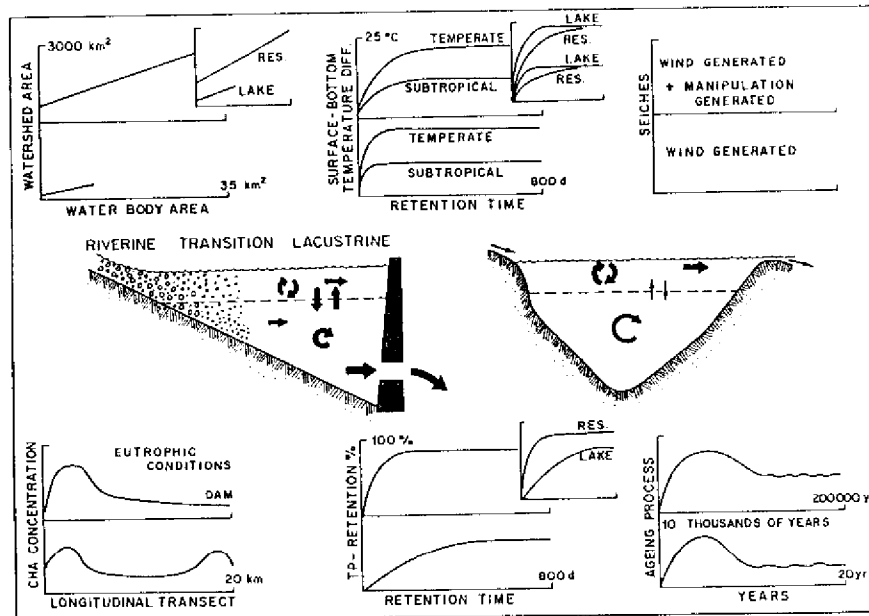

Fig. 4.3 Differences between a lake and a reservoir in the basin shape and mixing, watershed/waterbody area relation, temperature stratification in dependence on retention time, origin of seiches, longitudinal distribution of selected variables exemplified by chlorophyll-a, retention of total phosphorus as dependent on retention time and duration of the ageing process.

Before we can discuss individual reservoir subsystems, we must clarify the basic differences between the limnology of reservoirs and that of lakes. Many readers of this volume might be most familiar with limnology and water quality conditions in lakes, which are documented in numerous publications. Reservoirs, however are different than lakes in terms of their age, origin, morphology, shape, position within the watershed, and uses, as well as in respect to limnological behavior. In Fig. 4.3 these major differences in limnological behavior are demonstrated. The center of the figure illustrates differences in the shape and consequential mixing in the reservoir and the lake. In a lake, intensive mixing takes place dominantly in the upper layers, whereas intensive deep mixing takes place in reservoirs. The driving forces behind this difference are the position of the outflow and intensity of the throughflows (these factors also determine theoretical retention time as specified in Chapter 3.2). In a lake the outflow is superficial, while in most reservoirs it is located in deeper strata. As shown in the upper left corner of the figure, the reason that reservoirs have shorter retention times is that they have a higher ratio of watershed area to waterbody area. Consequences are shown in the middle and upper right portion of the graph. Temperature conditions in reservoirs encompass a much larger range as a result of shorter

theoretical retention times. The internal movements of water masses in reservoirs are largely dependent on reservoir manipulation, and wind also effects these movements in both reservoirs and lakes. Chemical and biological consequences that are elucidated in respective subsystem chapters are provided in the lower left and middle portion of the graph. Longitudinal differences along the path from the inflow to the dam are a unique limnological feature of reservoirs and have great implications on water quality (Chapter 4.3). Retention time is a deciding factor in the chemical subsystem of a reservoir. It is important to recognize that water quality undergoes rapid processes of aging in the few first years after filling and processes of much slower evolution afterwards. Consequently, water quality is much worse in the first years than it is afterwards (Chapter 4.7). A similar process of aging takes place in lakes, but may extend for thousands of years.

4.1. THE WATERSHED AND THE RESERVOIR INFLOW

Measurement or estimation of the amount of water that enters the reservoir via inflows is necessary for two reasons. One reason is purely quantitative: to determine water levels, possible use of reservoir water and potential supply to the downstream river. The second reason is qualitative: changes in flow result in changes in water quality. Flow effects pollution levels because increased flows may lead to dilution and/or flushing of pollutants from the territory and can increase soil erosion. Gross geographical variations in water budgets are related to river flows as shown in Fig. 1.2. Variability is more important in terms of water quality than absolute flow rates. Flow variability differs from region to region, but is much higher in dry and semiarid regions than in regions with more balanced water budgets. Increased flow variability is associated with increased irregularities and susceptibility of flooding.

Vegetation cover and land use have major consequences for the nutrient load brought to the reservoir. The nutrient load from natural vegetation, in particular forests, is much lower than that from fields. Impermeable man-made surfaces of urban areas negatively affect water quality. Simultaneously, they radically increase the danger of floods. Deforestation results in drastic increases of a number of chemical concentrations. On the other hand, in the case of forest fertilization as realized in some countries a negative effect of the forest on inflow nutrient concentrations and eutrophication can be observed. Also, *Eucalyptus* forests now cultivated in many parts of the world have negative effects. Estimates of the effect of different land uses on river water quality can be made on the basis of areas of different land uses in the watershed and specific load coefficients. However, large variability due, e.g., to different crops cultivated and the dependencies between flow rates and flow variability have to be taken into consideration. With increasing flow periodicity, which is related to higher rainfall being further dependent on soil moisture intensity, soil erosion increases. Turbidity is affected by the size and types of suspended particles - the smaller and lighter the particles, the higher the turbidity.

Oxygen levels in water from the inflow river are derived from oxygen exchange in turbulent reaches, oxygen produced by algal and macrophyte photosynthesis, as well as that consumed during decomposition of organic matter. COD is an indication of slowly decomposing organic matter, and is evidenced by stained water in bogs or effluents from paper mills and other types

of industry. BOD is a measure of the amount of easily decomposing organic matter and mainly originates from sewage. High COD is often associated with increased color and the high color can result in an increase of up to tenfold in treatment costs.

Increased attention should be given to inflow temperatures. Approximate temperature conditions in a stream can be calculated by using the geographic position of the stream (latitude, altitude) and distance from the source (Callow & Petts 1992). Because inflow temperatures are very important in determining the behavior of the inflow within the reservoir, (see next subchapter) monitoring of temperatures is recommended.

4.2 THE PHYSICAL SUBSYSTEM

In a reservoir or a lake, the following zones can be designated: open water, which encompasses the center of the water body and includes most of the water volume, the littoral zone, which is located in the shallows, and the benthic zone, which is located at the bottom (Fig. 4.4).

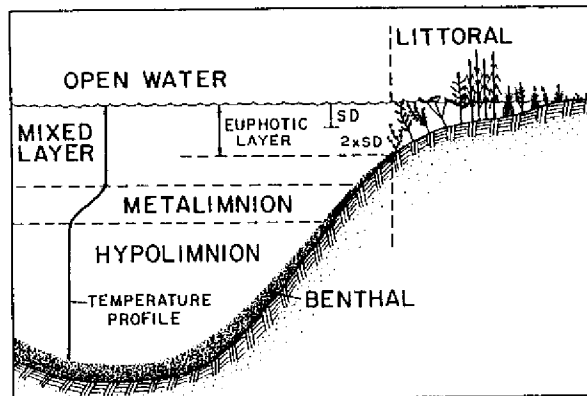

Fig. 4.4 Major vertical regions in a reservoir with indication of the distinction between mixing zone and euphotic zone.

In the open water zone of a reservoir, there are multiple water movement and mixing processes, as shown in Fig. 4.5. Only some processes indicated in the figure need consideration in connection with reservoir water quality. Basically, these may be classified into two groups: those which are related to heat and momentum exchange processes at the reservoir surface and those which are related to flows. In lakes, solar heating and wind reaching the water surface create vertical and horizontal differentiation of water masses. In intensively throughflowing reservoirs the dominant factor is the unidirectional flow of water from the inflow to the dam. In reservoirs with retention time of less than about 300 days this factor is also very important, but not dominant. This overall water movement creates complicated flows, longitudinal differentiation of reservoir water and more irregular temperature distribution and results in density stratification.

From a physical (hydrological) stand point, we can define two basic water body types: shallow water bodies, or those that do not become stratified, and deep water bodies, or those that become stratified. The distinction is not limited to depth, but includes the relationship between size, depth and throughflow. Another factor decisive in this consideration is the wind speed over the waterbody surface. Small waterbodies, with a depth of only a few meters, may stratify if protected from wind activity, while large water bodies may be mixed, although they may be up to 20 meters deep. Even very deep reservoirs will not stratify if their retention time is less than a few days.

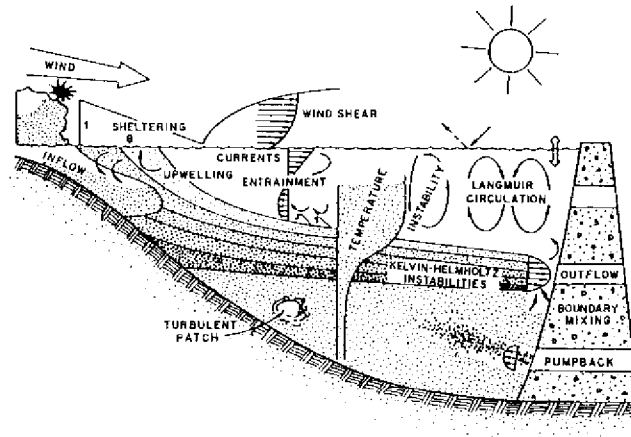

Fig. 4.5 Detailed outline of the different mixing processes and water circulation in a reservoir. Redrawn from Ford (1987). The importance of these processes for water quality differs: very important is the inflow (density) current and upwelling, with the Kelvin-Helmholz instabilities producing mixing of the density current with surrounding water. If the current is weak, it may disperse (fully mix with the surrounding water) due to these instabilities. The currents due to wind shear and instability determine the stratification. Turbulent patches of microscopic size are important particularly for mixing in almost stagnant regions. Sheltering before the wind activity functions on the 1:8 basis (the length of the sheltered zone representing eight times the height of the shelter) is important for small reservoirs.

The open water zone of a deep reservoir can be separated into three sub-zones (Fig. 4.4):

a) The **mixing zone** reaches a depth of z_{mix} and is where the thermocline is located. Daily mixing, due to the effect of wind and cooler temperatures at night, tends to homogenize any vertical differences within the mixing zone. The mixing zone is popularly called the epilimnion. However, epilimnion is in fact the upper illuminated zone where primary organic production takes place. This layer extends to a depth of z_{cu} , and is defined as the depth to which 1% of the surface illumination is received, which is roughly equivalent to twice the Secchi disk depth. Light falling on the reservoir surface is partially (approximately to 10%) reflected at the surface and partially absorbed in the first few centimeters of water. Light penetrates to a certain depth in accordance with the Lambert-Beer law; i.e., exponentially. The exponent equals the extinction coefficient, determined by the amount of colored organic matter, turbidity, and the amount of phytoplankton. The two depths, z_{mix} and z_{cu} , are not necessarily the same, although light (=energy) penetration partially determines water temperature and, therefore, mixing depth.

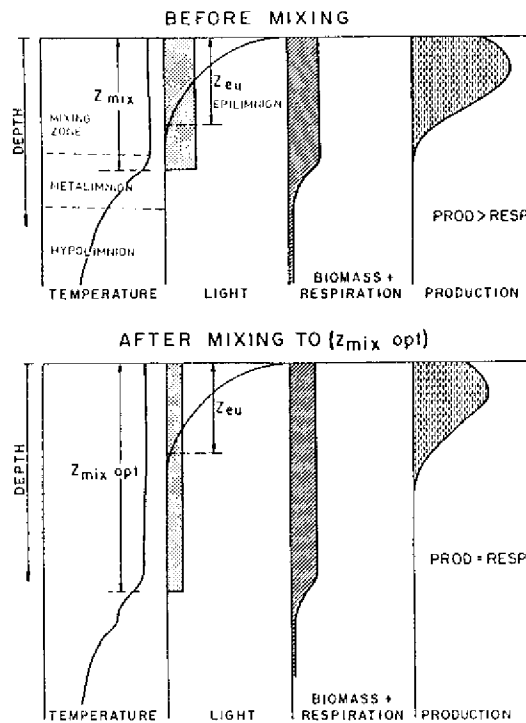

Fig. 4.6 The effect of mixing (both natural and artificial) on phytoplankton biomass and production. Phytoplankton is mixed to the depth z_{mix} , while light is available only up to the depth z_{eu} . Therefore, if mixing is deep, the phytoplankton production is low, and consequently decreases also its biomass.

Whether $z_{mix} < z_{eu}$, $z_{mix} = z_{eu}$ or $z_{mix} > z_{eu}$ is consequential in phytoplankton production and hence eutrophication of the water body. This is explained in Fig. 4.6, and is connected with the management technique of "epilimnetic mixing". The depth of the mixing zone is strongly correlated with the water body size. In small and wind protected waters mixing zones usually reach only 2 meters, however, mixing zones can reach up to 25m in the temperate regions and up to 50m in tropical regions. Other variables involved in the determination of mixing depth are the amount of suspended particles and colored organic matter. High color, turbidity, or high phytoplankton concentrations cause shallower euphotic and mixing layers (Fig. 4.7).

b) The **hypolimnion** is a dark zone that is characterized by less vertical mixing and is where the bulk of decomposition process takes place.

c) The **metalimnion** is the intermediate zone between the two zones discussed above. This is usually a fairly narrow zone, and the maximum width is only a few meters. In an ideal situation, the **thermocline** is located in the middle of the metalimnion.

The boundaries between zones are determined by density differences. Density depends mainly on temperature, but is also affected by salinity and turbidity. The relation is nonlinear; density

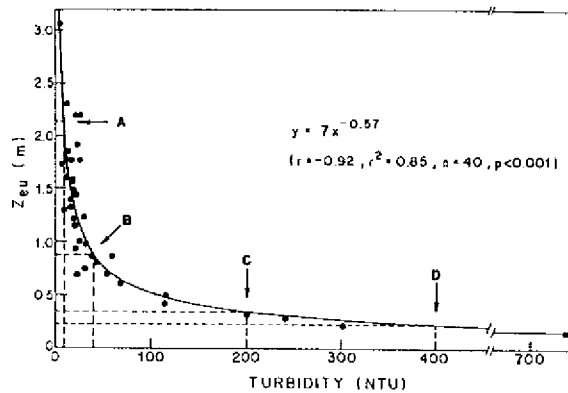

Fig. 4.7 Dependence of the depth of the epilimnion (z_e) on turbidity.

increases from 0° to 4°C and then progressively declines with increasing temperature. Density (ρ) corresponding to any temperature (T) can be calculated from the equation:

$$\rho = 1 - 6.63 \cdot 10^{-6} (T-4)$$

That is, the change in density for degree C is much less at lower temperatures than at higher temperatures. In the tropics, the change in density related to a one degree Celsius change in temperature is equal to differences observed after a temperature change of a few degrees in the temperate region.

In lakes that are deep enough to stratify, the three zones are usually clearly distinguishable because there is a very sharp temperature (density) gradient in the metalimnion, as illustrated in Fig. 4.6. Under these circumstances, a simplified estimation of z_{mix} is possible: it is the first depth (beginning at the surface) where the temperature drops by at least 1°C per meter. This method is only valid for temperate lakes with long retention times. In tropical regions, depth temperature differences, that define the boundary between the mixing zone and the hypolimnion are much smaller.

In reservoirs, the temperature profile is usually much more irregular than that of lakes. Determination of z_{mix} , particularly in throughflowing reservoirs, is difficult. High variability of flows and other water movements related to reservoir operations produce fluctuations in the temperature depth profile. A deep discontinuity is often seen at the outflow level and is referred to as hydraulic stratification. Water below the outflow level is more stagnant than the water at or above this level.

The annual course of temperatures at a reservoir surface is similar to that of lakes and depends mainly upon geographical location (particularly latitude and altitude) and size. Fig. 4.8 is a schematic representation of the latitudinal variability of surface temperatures of medium sized lakes located at low elevations. Lakes that are located in more oceanic climates are warmer and their annual temperature cycle is postponed. As a general rule, surface temperature decreases by 0.7 to 0.8°C for every 100 meter increase in elevation. Temperature

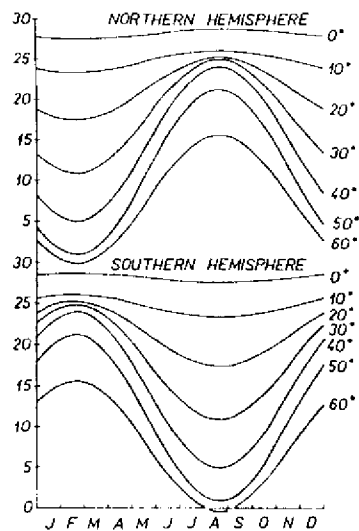

Fig. 4.8 Geographical differences of surface temperatures in medium size lakes and long retention reservoirs. From Straškraba (1980).

decrease with increase in water body size, but the maximum difference between smallest and largest lakes in the same geographical region is only a few degrees. The geographic classification of lake stratification is described in Chapter 4.8.

Reservoirs are different from lakes in that the surface temperatures (to a lesser extent) and depth distribution of temperatures are additionally dependent on the theoretical retention time. Fig. 4.9 shows temperatures at different depths for a temperate reservoir with the retention time of 12 days when it has a bottom and a surface outflow. Major differences are evident particularly for temperatures at 20 and 30 m. For temperate reservoirs the depth difference during the period of annual maximum temperatures are expressed in the right part of Fig. 4.9. They are expressed as the temperature difference between the surface and the depth of 30m (ΔT_{0-30}). The figure shows that, in a reservoir with a retention time that exceeds 300 days, conditions for a reservoir are the same as that of a lake with a similar geographic position and size. The temperature at the bottom of these waterbodies is constant for the whole year. In reservoirs with shorter retention times, the bottom temperature increases with decreasing retention time until, finally, there is no difference between the surface and bottom temperature in those reservoirs that have very short retention times. The surface temperature is a few degrees lower in low flow reservoirs than in those with long retention times (the latter also have surface temperatures that are identical to lakes as provided in Fig. 4.9). There is a smooth relation of ΔT_{0-30} and theoretical retention time of the reservoir. In subtropics and tropics, the same relationship exists but the temperature differences between the surface and bottom are much smaller, as seen for the subtropical Canning Reservoir.

An understanding of reservoir physics and consequential water quality conditions is not possible without knowledge of the horizontal changes within a reservoir. In accordance with differences

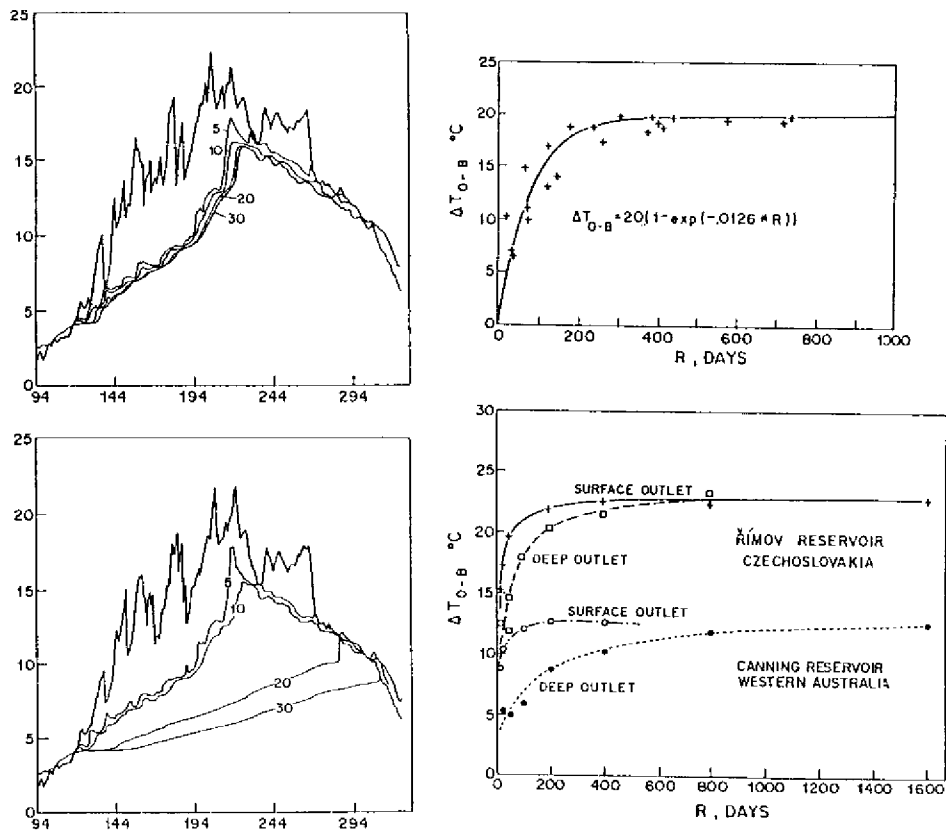

Fig. 4.9 Temperature stratification in reservoirs in dependence of the outlet location. Left - Upper panel - annual changes of temperature in a temperate reservoir with the theoretical retention time $R = 12$ days and with the bottom outlet. Lower panel - The same reservoir with the surface outlet (values calculated by the model DYRESM). Right - Upper panel: observed dependence of the degree of stratification in a number of Central European reservoirs on the theoretic retention time, R . Lower panel: The same dependence calculated with the model DYRESM for the temperate Římov and a subtropical Canning Reservoir, with localization of outlets in the depth as observed and at the surface (the latter representing a lake situation).

in density between the inflow water and reservoir water, water can spread to different depths as it enters the reservoir. When this inflow plunges to a depth of corresponding density, the flow creates a **density current**. The stream may flow along the reservoir bottom as an underflow or some intermediate depth as an **interflow** (Fig. 4.10). The inflow water mixes with reservoir water at the surface or when it plunges and flows at a specific level or along the bottom. Mixing also takes place in the reservoir hypolimnion in the case of a bottom or near-bottom flow.

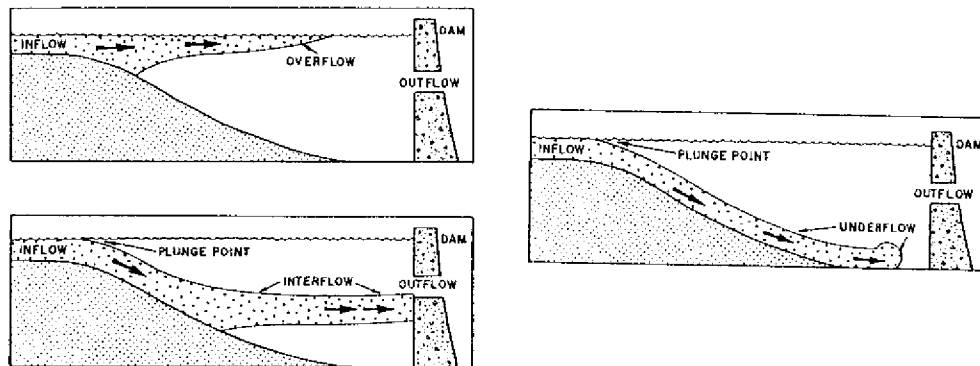

Fig. 4.10 Three types of density currents in a stratified reservoir: overflow, interflow and underflow. The inflow plunging point is shown.

4.3 SPATIAL VARIABILITY IN RESERVOIRS

The degree of horizontal and vertical heterogeneity within a reservoir is decisively influenced by reservoir morphometry, flow and stratification conditions. The following major zones can be distinguished (Fig. 4.11):

- (i) **riverine** (or back-water),
- (ii) **transitional** (between riverine and lacustrine),
- (iii) **lacustrine**.

Conditions in larger **bays** or coves might resemble those found in the main reservoir body and may have similar zonation. Specialized micro-environments may develop in the littoral zone; these could consist of shallows with wetlands, submerged trees, etc.

The size of a horizontal zone varies in each individual reservoir and depends upon morphometry, retention time, thermal stratification, season, and geographical location. In deep temperate reservoirs during the summer, if they have retention time shorter than 10 days, the whole reservoir may become a riverine zone whereas, when with an R of more than 200 days, the riverine zone is short and most of the reservoir is lacustrine (Fig. 4.12). The longitudinal distribution of variables depends on the extent of individual zones, as shown on the example of phosphorus and chlorophyll-a in some reservoirs (Fig. 4.13). Due to phosphorus input the maximum development of chlorophyll-a is located in the transitional zone.

Hydrodynamic conditions cause horizontal variability in most reservoirs. Local short-time horizontal differences also can occur in the surface layer, for example, surface scum consisting of cyanobacterial blooms may accumulate on the downwind portion of the reservoir.

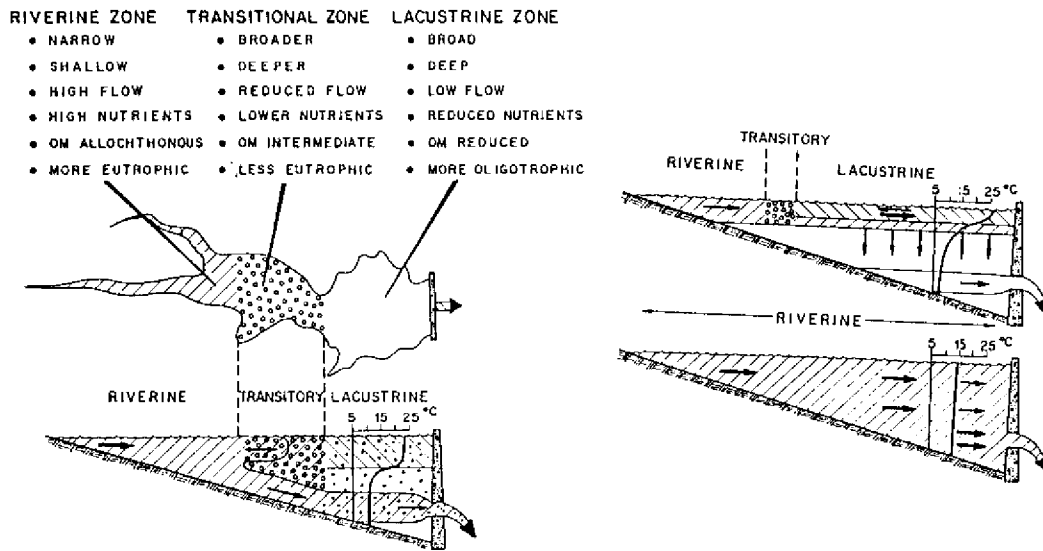

Fig. 4.11 Longitudinal zonation in a reservoir after Kimmel & Groeger (1984) and changes in the zone extension, flow and mixing pattern for reservoirs (reservoir conditions) with different ranges of R . Top - $10 < R < 100$ days, center - $R > 100$ days, bottom - $R < 10$ days

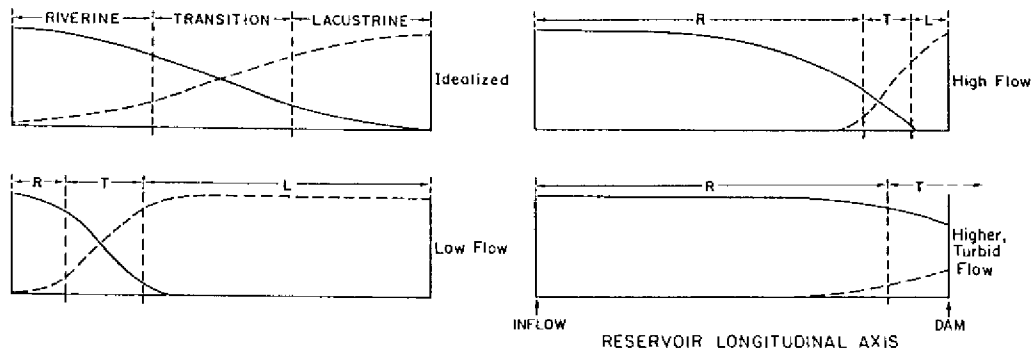

Fig. 4.12 Schematic differences in the extent of the three zones in conditions of different flow rates and corresponding retention times. Redrawn from Thornton *et al.* (1990).

Density currents appear when inflow water travels directly to the outflow in a narrow layer. This is particularly common when flows are higher than average and the temperature of the inflow stream is close to the temperature of the outflow. During such periods, the actual time of passage of water parcels through the reservoir is very short, even if retention time of the total water mass is long. Short-cut (density) currents are sometimes used in management strategies (Chapter 11.4).

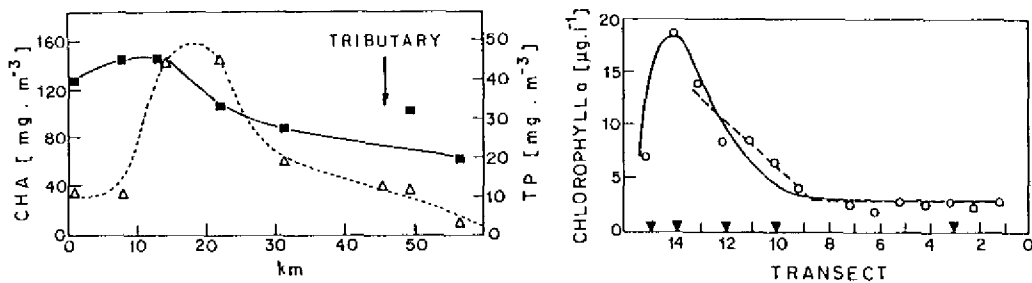

Fig. 4.13 Horizontal differences in the distribution of a few dynamic variables along reservoirs. Left panel: Asahi River Dam Reservoir according to observations by Kawara *et al.* (1995) from June. Squares and full line - total phosphorus. The position of one point is influenced by a side tributary. Triangles and dashed line - chlorophyll-a. Right panel: full line connects the observation in DeGray Reservoir according to Thornton *et al.* (1982) and the dashed line is an approximation for the rapidly decreasing concentration in the transition zone and constant concentration in the lacustrine zone. The inverted triangles on the axis indicate the optimum location of observations.

4.4 THE CHEMICAL SUBSYSTEM

Chemical elements occur in water in several forms. These are: dissolved inorganics, dissolved organics, elements bound on abiotic particles and elements that are biologically bound. These can be represented by different chemical species and are very often a mixture of those mentioned. Among various forms an exchange usually proceeds at variable rates. The exchange rate depends on chemical equilibration processes, sorption and desorption by particles and uptake and release by organisms. Thus, aquatic chemistry is not just a process described by classical chemistry, but a dynamic process involving the biology of aquatic organisms. This is an important consideration in chemical analyses; chemically determined amounts of some elements will differ if abiotic particles of certain sizes and/or organisms are included. Processes that occur during sample transportation can radically change the proportions and forms of the elements present. In particular, death, uptake and excretion of some elements can be decisive.

In regards to particulate fractions, the sorption - desorption processes play significant roles, particularly in highly turbid waters that are characteristic for certain dry regions with particular soil types. Another important physical - chemical process is particle sedimentation. This process is affected by particle and water density (and therefore, by temperature), size and shape of particles (sedimentation, as driven by these processes is described by Stokes Law), processes that take place on the surface of particles and water turbulence and stratification. The same rules govern sedimentation of phytoplankton, particularly those that are dead or dying. Some species of phytoplankton avoid sedimentation by different mechanisms, such as active movement and density regulation.

Mineral composition of reservoir water is summarized by its conductivity, hardness, alkalinity

and salinity and is specified by individual mineral components. Most mineral components belong to the conservative ones as they do not enter intensively the chemical-biological processes in the reservoir. Their behavior is primarily due to water movements and mixing. For these reasons, they can be used as natural traces in certain circumstances.

Nutrients represent a special category, due to their effect on biological production in the reservoir. They are nonconservative, as they enter processes involving biological transformation such as uptake by organisms for growth needs and release by these organisms during life (excretion) and after death. Nutrients are considered biogenic elements, or those which are essential for life. The following nutrients are listed in the order of greatest to least amounts necessary for life: C, N, P and S (which are known as macroelements because they are needed in relatively large quantities) and Si, Cu, Mn and others (which we call micronutrients). Fig. 4.14 illustrates the processes of phosphorus transformation; the **phosphorus cycle** is considered the most critical process in organic production within reservoirs. In respect to eutrophication, phosphorus is most important of the three nutrients possibly critical (C, N and P) not only because it is limiting in most reservoirs, but also because a phosphorus load is easily depleted in waterbodies. The most critical part of the phosphorus cycle is P-uptake by phytoplankton and, less importantly, by pelagic bacteria. Soluble reactive phosphorus ($\text{PO}_4\text{-P}$) is taken up to such an extent that concentration of this nutrient in surface water layers can be as low as a few micrograms per liter, which equals to that which is naturally released by organisms. The bioavailability of organic phosphorus varies considerably and depends on the organic phosphorus species. Phosphorus taken up by phytoplankton accumulates in sediments in large amounts, especially in eutrophic conditions. In some instances, P levels in the upper millimeters of the sediment can be greater than that in the whole water column. Figure 4.14 clearly illustrates that

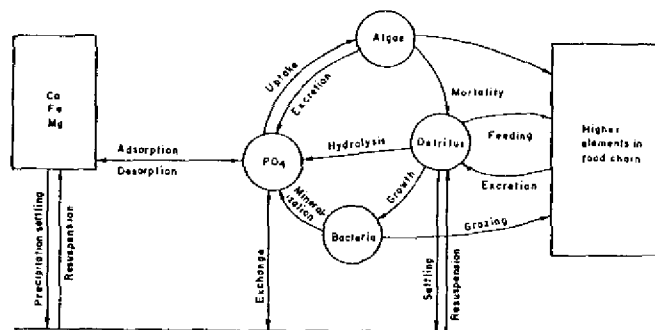

Fig. 4.14 Processes of phosphorus transformations in a reservoir.

a major change takes place in phosphorus cycling when either the hypolimnion of the reservoir is anoxic or oxygen reaches the sediments. Under anoxic conditions, phosphorus accumulated in sediments is readily released to adjacent water, however when the sediment surface is oxic this exchange is greatly reduced. In the latter case, a layer of trivalent iron at the sediment surface prevents intensive release. Iron and manganese are simultaneously released with phosphorus causing increased treatment cost. Under oxic conditions, sediment water exchange takes place by diffusion and is governed by the concentration gradient between the two media. This fact and the

diffusion and is governed by the concentration gradient between the two media. This fact and the usual large amounts of phosphorus accumulated in the sediments of reservoirs explain why releases continue long after the P-input to the reservoir has been stopped. Internal loading of the reservoir takes place because the phosphorus now moves from the sediments to adjacent water layers.

Reservoirs function as effective traps for phosphorus. Phosphorus both in abiotic particles and that taken up by phytoplankton eventually accumulates in the sediments. Thus, the amount of phosphorus that leaves the reservoir is much lower than the amount that enters the reservoir. The difference between the inflow and outflow amount is expressed as the retention coefficient in the percentage of the inflow amount and the relationship of this amount with reservoir retention time is shown in Fig. 4.15.

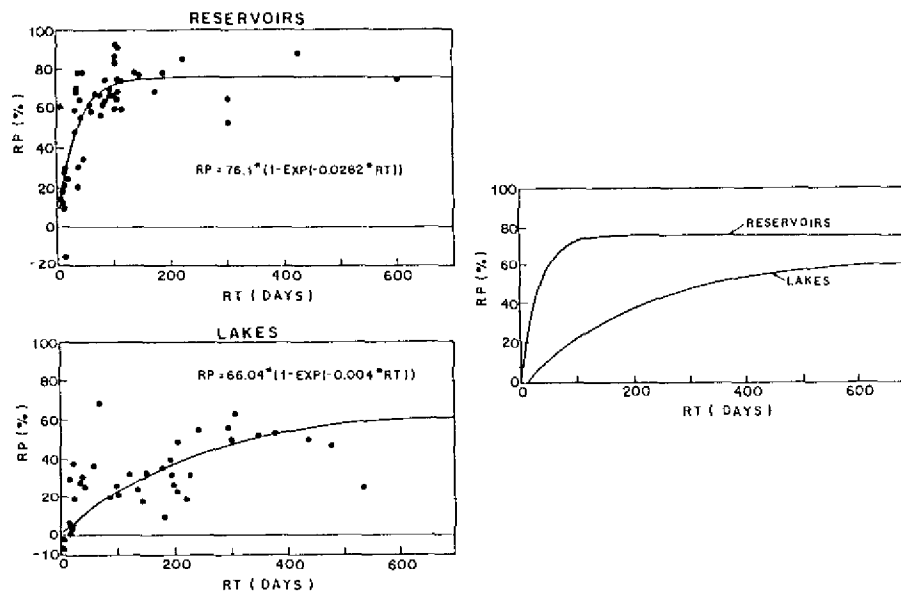

Fig. 4.15 Retention of phosphorus by reservoirs and by lakes in the temperate region. Dots are annual average observations for different water bodies and different years, the line is a statistically calculated relation with the equation given. In the left panel the two curves are compared.

The **nitrogen cycle** is illustrated in Fig. 4.16. This cycle differs from the phosphorus cycle because different groups of bacteria actively participate in the cycling process. Because bacteria do not need light, the processes are also intensive in the hypolimnion. Additionally, some species of pelagic cyanobacteria are able to fix atmospheric nitrogen in times of insufficiency. The nitrogen fixation process has high energetic requirements, therefore, it usually does not occur in waters with a nitrogen surplus. The presence of heterocysts in cyanobacteria enables these organisms to fix nitrogen. As shown in the left and right part of Fig. 4.16, the nitrogen cycle also differs in the hypolimnion of oligotrophic and eutrophic waters. This difference is due to rich

oxygen concentrations in oligotrophic waters and low oxygen concentrations in eutrophic waters. Nitrification ($\text{NH}_4 \rightarrow \text{NO}_3^- \rightarrow \text{NO}_2^-$) prevails in the oxygen rich hypolimnion of oligotrophic

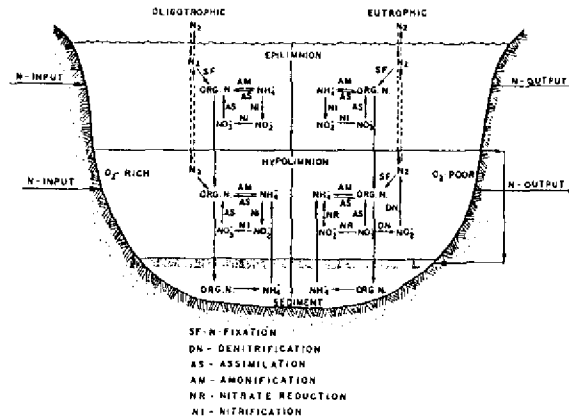

Fig. 4.16 Processes of nitrogen transformations in a water body. In the left part conditions in an oligotrophic water body are shown, while the right part shows the processes in a eutrophic water body. The main cause is the oxygen rich hypolimnion in the oligotrophic and anoxic hypolimnion in the eutrophic situation.

reservoirs while ammonification ($\text{NO}_2 \rightarrow \text{NO}_3^- \rightarrow \text{NH}_4$) prevails in low oxygen or the anoxic hypolimnion in eutrophic waters.

Organic matter that enters reservoirs from the watershed is designated as **refractory** when it decomposes slowly (e.g., "humic substances" such as "black waters" of Amazonia or those that originate in industry such as paper mills) and **decomposable** or more precisely **easily decomposable** which usually originates from sewage. The summary characterization of the first category is by chemical oxygen demand (COD) and of the second is by the biological oxygen demand (BOD). Another measure of "humic substances" - different fulvic acids - is the water color as given by the Pt scale. This is related to the water extinction coefficient as determined in Chapter 4.2. Organic matter in the waterbody is also produced by phytoplankton and macrophytes. This source of organic matter can be dominant in eutrophic waters that are situated on rivers and have a high degree of classical purification (= low organic load), but high nutrients. This is the situation when the degree of tertiary treatment is low and point nutrient sources are high. Specific organic compounds enter water, particularly as pesticides and herbicides that are released from agricultural soil and other organic pollutants and toxic organics from industry (see Matsui 1991, ILEC Guidelines of Lake Management Volume 4).

Oxygen conditions in the reservoir depend on a number of processes. The most important of these are: (i) the rate of phytoplankton production and respiration (=enrichment of water with oxygen during the day and utilization during the night), (ii) oxygen concentration and temperature of reservoir inflow, (iii) the rate of oxygen exchange at the air - water interface, (iv) the rate of phytoplankton sedimentation and decay in deeper strata, (v) the organic matter content of the sediments and resulting oxygen consumption, and (vi) mixing conditions in the reservoir.

Phytoplankton production is restricted to the illuminated epilimnion and decomposition primarily takes place in deeper strata. Oxygen concentrations are, therefore, often vertically differentiated, with surplus at the surface and deficit in deeper strata. In oligotrophic waters, oxygen is present in the hypolimnion, while in eutrophic waters anoxic conditions prevail in the hypolimnion. During the periods of mixing, oxygen concentration is usually consistent throughout the whole water column, while during periods of stratification, oxygen levels also become stratified. Oxygen stratification is less pronounced in rapidly throughflowing reservoirs. Shallow reservoirs have no stratification of oxygen levels or stratification appears in calm sunny periods and disappears during the windy conditions or after cool nights.

Decreasing pH resulting from input of acid rain creates a number of chemical changes, because pH regulates many chemical processes. Changes that are important factors in water quality are particularly related to phosphorus and nitrogen content, decomposition of organic matter and concentration of aluminum in toxic forms. Most of these processes take place in groundwater and changed conditions are present in reservoir inflows. Phosphorus input may decrease. Nitrification ceases at pH 5.4 - 5.6 and nitrogen fixation ceases at pH < 5.0. As a consequence, inorganic nitrogen accumulates. The decrease of P and increase of N, both in mineral form, can change the relations between phosphorus and nitrogen and therefore limitation conditions for phytoplankton growth (Chapter 4.5). Decomposition of organic carbonaceous substances ceases at pH < 5.0. Concentrations of dissolved aluminum that are toxic to higher animals and humans increase as aluminum undergoes dissolution from less soluble forms.

4.5 BIOLOGICAL SUBSYSTEM - RESERVOIR FOOD WEB

The **food web** of the reservoir is represented by several major groups of organisms, designated in accordance with their life styles and feeding habits. Organisms are mutually interrelated, not only through their feeding activities, but also by allelopathic reactions induced by chemical compounds released by organisms, by organism behavioral reactions, and by recycling of nutrients and other relations. This relationships is called a food web because each organism may eat many items, often of both plant and animal origin. Nevertheless, for a simplified representation limnologist often distinguish a **food chain** including producers, herbivores, predators, second order predators and decomposers (Fig. 4.17). Knowledge of aquatic organisms and a reservoir's food chain is important because the presence or absence of certain species and composition of the food chain can serve as indicators of long term status of water quality and early warning signs of approaching changes (Chapter 9.8). Through food chain manipulation, improvement of water quality can be achieved (Chapter 11.3).

The food web of the pelagic or open water region of a reservoir is inhabited by plankton. Plankton can be separated into bacterioplankton, phytoplankton, and zooplankton. **Bacteria** are discussed in Chapter 4.6. **Benthos** is a group of animals that usually dwell in the bottom mud and collect organic particles that originate from material produced or introduced in the open water region and eventually reach the bottom. Benthos provide food for bottom-dwelling and omnivorous fish and are important for bioturbation which is the mixing of surface layers of the sediment. The importance of benthos is high in shallow reservoirs, but it diminishes with the

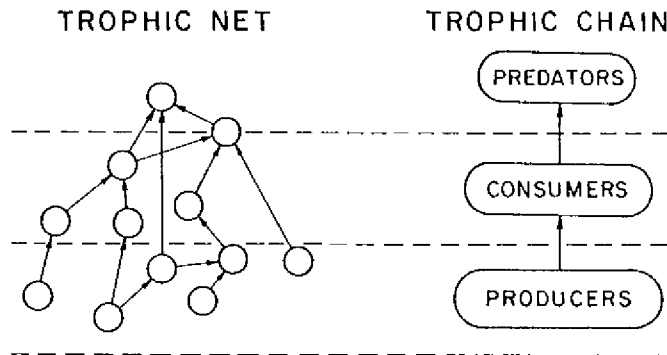

Fig. 4.17 Simplified representation of the trophic food chain and trophic net. In the real trophic net many species are present, which interact in different ways. Trophic chain is the simplified representation of the trophic net, omitting the interrelations within and among the trophic levels. In its simplest form the trophic chain is represented by three levels: primary producers (Cyanobacteria, algae and higher plants), consumers (organisms eating primary producers) and predators (organisms eating consumers).

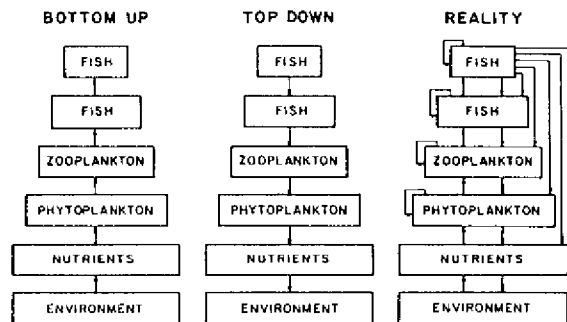

Fig. 4.18 More detailed representation of the food chain and different types of basic relations: bottom up, from the environment to the highest trophic link and top down, in the opposite direction. In reality, both types of relations act simultaneously, there are indirect relations (e.g., of fish on the zooplankton) as well as internal relations within each trophic level.

increasing reservoir depth. The litoral region is usually not well developed in deep reservoirs because of their short-term water level fluctuations, but might grow well in extensive shallows or in shallow reservoirs. Litoral region is overgrown by higher flowering plants - **macrophytes**. Macrophytes are the substrate for **periphyton**, consisting of sessile algae and microscopic animals feeding on them.

One major result of reservoir limnology is the recognition that the interrelations between different groups of organisms are very intensive, and the effects are not only bottom up from the physical

environment through nutrients to primary organic production up to the top predators among fishes, but also top down, from the higher organisms down through the lower organisms to the reservoir chemistry and physics (Fig. 4.18). The change of one population is able to change the water quality conditions considerably.

Reservoir **phytoplankton** includes algae and cyanobacteria. It is sustained by a constant input of nutrients from the inflows and recirculated from zooplankton. When retention time is long, the growth rate of phytoplankton increases with increasing flow due to the higher nutrient loading. Simultaneously, mortality increases due to sedimentation, grazing by zooplankton and washout. This trend is valid up to a certain amount of inflow (corresponding to a reservoir retention time that is less than a few days), at which point the phytoplankton growth can no longer compensate for losses due to the washout and the population crashes. In this respect, the reservoir behaves as the so called continuous microorganism culture. Different species of algae have different growth rates, nutrient requirements, sedimentation rates and are consumed by zooplankton in varying degrees, as related to size differences and other factors. The three most common and most distinct groups of phytoplankton are shown in Fig. 4.19.

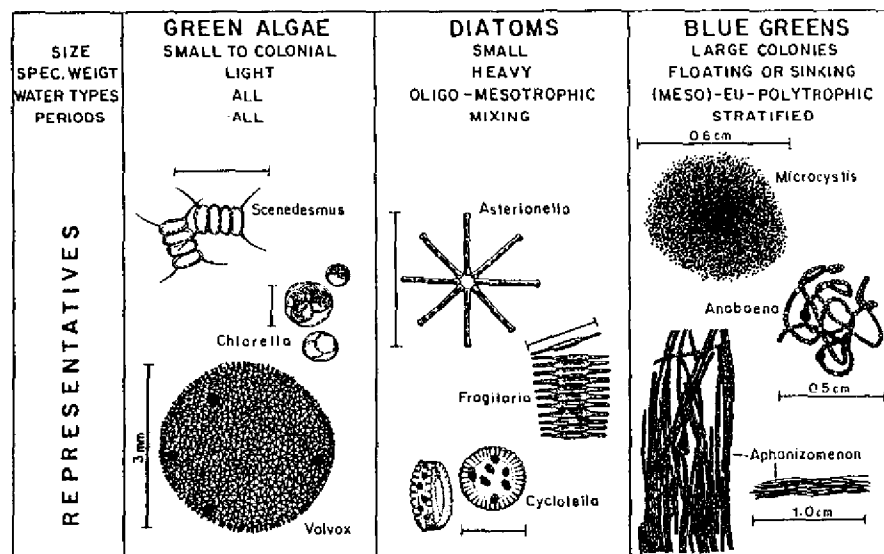

Fig. 4.19 Three most common and most differentiated groups of algae, their characteristics and some typical representatives.

A measure commonly used to quantify the amount of algae present in a reservoir is the content of **chlorophyll-a in the sample**. The chlorophyll-a content of algal fresh weight is different for different phytoplankton groups and species, and is lower when algae live in a well-illuminated column (during stratified periods) and higher if column illumination is low (during mixing). High concentration of chlorophyll-a, particularly if originating from **colonial blue-greens**

(Cyanobacteria), is detrimental to water quality. High chlorophyll-a levels are associated with excess organic matter which decreases oxygen concentrations in deeper layers of reservoirs when it decomposes. This results in odor and taste problems even after the water is treated for drinking supply. Accumulation of surface scum of blue-greens cause aesthetic concerns in reservoirs that are used for recreation. Toxic strains of these organisms are particularly dangerous, both to people and animals (Chapter 6).

The growth rate of phytoplankton depends primarily upon the availability of light and temperature, concentration and load of critical nutrients. Figure 14.1 illustrates how the chlorophyll-a concentration as a measure of the phytoplankton biomass is related to the concentration of phosphorus.

Zooplankton is a group of microscopic or very small animals that swim in the open water zone of reservoirs. This group includes animals the size of protozoans up to those of the size of crustaceans, reaching, with few exceptions the maximum size a few millimeters. Exceptions include the predatory cladoceran *Leptodora* and the larvae of phantom midges (*Chaoborus*) that can attain a length of about 1 cm. The dominant group among protozoans are the ciliates, which use their cilia to collect bacteria and algae. Rotifers are intermediate in size, and feed either by filtration (most species) or predation. Most crustaceans filter-feed off phytoplankton (cladocerans) or are omnivores (copepods). Zooplankton serve to improve water quality by controlling phytoplankton development during grazing activities (Chapter 11.3).

Fish found in reservoirs include zooplankton feeders, benthos feeders, omnivores and predators. The role of predatory fish in controlling the structure of the entire open-water association is explained in 11.3. Reservoir fisheries are treated in Chapter 5.

4.6 RESERVOIR BACTERIA AND VIRUSES

Bacteria decompose organic matter in reservoirs and a measure of this activity is the BOD₅. Bacteria are also part of the detritus food chain, as depicted in Fig. 4.20. Bacteria are consumed by higher organisms including the heterotrophic flagellates, ciliates and larger zooplankton. The amount of free-living bacteria present is related to the amount of organic matter brought by the inflow and the activities of phytoplankton. Organic matter exuded by phytoplankton are the major carbon source for bacterial growth, thus peak occurrences of bacteria are found when phytoplankton starts to decay.

Bacterial indicators of fecal pollution and pathogenic bacteria are of specific hygienic concern. Indicators include psychrophilic, mesophilic and coliform bacteria. The number of **psychrophilic bacteria** found in mountain streams and unpolluted reservoirs ranges between 1 and 10⁴ per milliliter; in lowland streams of heavily inhabited regions, the number is between 10 and 10⁶ per milliliter. High psychrophilic bacteria counts are found in polluted in-flow streams and in less polluted streams during high flow events. Within the reservoir, the number of hygienically important bacteria often slowly decreases due to sedimentation and consumption by zooplankton. In surface waters, **mesophilic bacteria** counts are usually 1-2 orders of magnitude

lower than psychrophilic bacterial counts. **Coliform bacteria** are exclusively of fecal origin (from man and warm-blooded animals) and enter reservoirs from allochthonous sources.

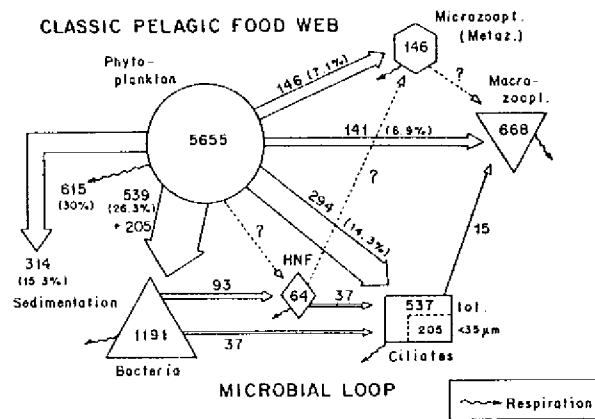

Fig. 4.20 The microbial loop (=detritus food chain) as accompanying the classic pelagic food web. Important is the participation of bacteria and some other groups of microorganisms. The sizes of the compartments represent their biomass and the size of the arrows the intensity of feeding relations in a specific case.

The most common waterborne bacterial pathogens are *Shigella*, *Salmonella*, *Campylobacter*, toxigenic *Escherichia coli*, *Vibrio* and *Yersinia* (Meybeck *et al.* 1989). Among human viral pathogens, *Hepatitis A*, *Norwalk* and *Rotavirus* have been responsible for numerous disease outbreaks. Other viral agents that are capable of waterborne transmission include enteroviruses (*Coxsackievirus*, *Echovirus*, *Adenovirus*), *Parovirus* and "gastroenteritis type A". New water borne viruses are continuously discovered with newly developed and improved methods of detection.

4.7 WATER QUALITY CHANGES DURING RESERVOIR AGING

The term **reservoir aging** is used to describe rapid changes and deteriorated water quality that occur during the first few years after a reservoir is filled. This period is also called **trophic upsurge** because higher biological production takes place during this period. Much slower limnological changes, which last for decades or centuries, are referred to as **reservoir evolution**.

The process of reservoir aging is very important from a management perspective because it is observed in the first few years of existence of every new reservoir and water quality deteriorates during this period. Water quality problems that commonly occur during reservoir aging and their respective causes are given in Tab. 4.1.

The length of the aging period differs between reservoirs, however, the average span is between four to more than ten years. In Amazonian reservoirs, stabilization takes a minimum of 10 years,

depending upon the rate at which the submerged Tropical Humic forest decomposes. Aging of the reservoir depends upon two types of processes, namely physico-chemical and biological. The

Tab. 4.1 Water quality events and problems that occur during reservoir aging and their causes.

PROBLEM	CAUSES
INCREASED CONCENTRATIONS OF ORGANIC MATTER.	Leaching of organic matter from soil. Decomposition of drowned vegetation.
INCREASED COLOR.	Color indicates concentration of resistant organic matter. Color changes occur very slowly and increased values are lasting signs of aging.
LOW OXYGEN CONCENTRATIONS (PARTICULARLY IN HYPOLIMNION).	Oxygen is consumed during decomposition of dissolved and particulate organic matter that enters through the inflows and is released from disturbed soil and decaying vegetation.
HIGH NUTRIENT CONCENTRATIONS.	Nutrients are leached from disturbed soil.
EXCESSIVE GROWTH OF VEGETATION (PARTICULARLY FLOATING AQUATICS).	New tropical reservoirs are particularly susceptible to this problem.
INCREASED PHYTOPLANKTON PRODUCTION.	Algae grow rapidly as the result of increased nutrient concentrations.
INCREASED FISH PRODUCTION.	Some species of fish are able to reproduce rapidly in response to the high food supply, nevertheless, some years must pass before the fish population is well established.

physico-chemical process is controlled by latitude, volume, retention time, amount of organic matter accumulated during filling, activities in the watershed, and amount of input of suspended material. In regards to biological processes, the most important element is the rate and degree of development of fish populations and the control by these organisms over the rest of the system. The aging process is shorter in rapidly throughflowing reservoirs than it is in these with slower throughflows. The geographical location (more rapid aging in tropics) and time required for filling (slow and intermittent filling prolongs the aging period) are decisive factors in the aging process. The sequence of events that normally take place during reservoir aging are shown in Fig. 4.21.

Most reservoirs stabilize after existing for a few years. Subsequent to the aging process, **limnological evolution** of the reservoir occurs and is largely driven by the impact of human activities, such as intensification of land uses and industrial activities.

4.8 LIMNOLOGICAL TYPES OF RESERVOIRS

Classification of reservoirs is a practical means of organizing knowledge about different reservoirs. However, it is important to recognize that exact classes of reservoirs do not exist in reality. A continuum of transitions from one extreme to another are present in all of the criteria that are used as a basis for classification. Nonetheless, a break-down of this continuum into individual classes is a practical descriptive tool and enables easier evaluation of respective conditions. Moreover, multiple variables are used in some classification schemes to deal with different classes, making their use easier for management. Because the process of splitting a continuous row of possible values into "classes" according to one criterion is somewhat arbitrary

we must expect the occurrence of many transients and modifications.

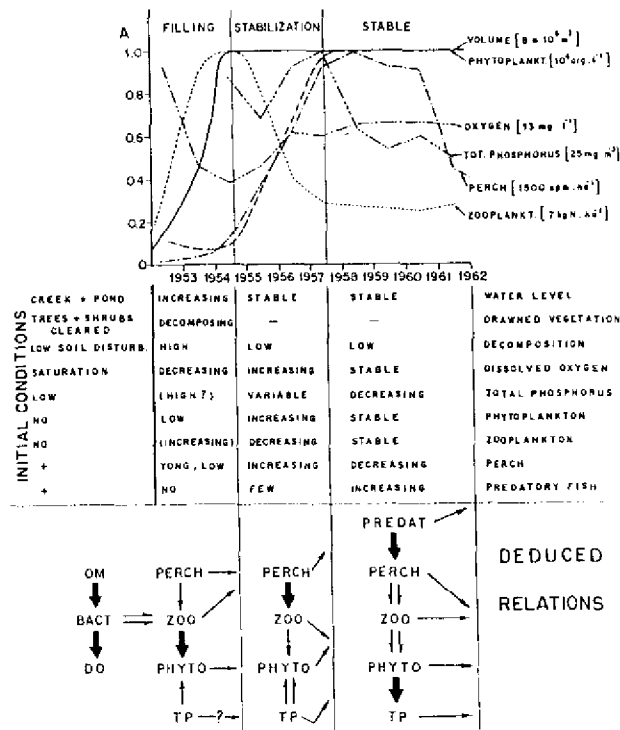

Fig. 4.21 Aging process within the first years after filling the reservoir. In the upper part of the figure the specific curves for the development of biomass, abundances and concentrations of individual components as observed in the Kličava Reservoir, Czech Republic are given. Perch is the dominant fish species in this period. The three major phases are the filling phase, stabilization phase and stable phase. The central part shows the state of different components given on the right of the figure. The lower part shows the deduced interrelations and their strength, indicated by the thickness of the arrows. The arrows pointing out indicate the increasing, decreasing or stable character of the changes during the given phase.

Presently, there is no reservoir classification system of general validity. All systems are based on local experience and data. The first serious attempt to classify reservoirs was devised by Margalef (1975) and was based on data from about 100 reservoirs, that were located throughout Spain. The system is predominantly based on two criteria, one of which is related to the degree of mineralization of reservoir water and the other is related to trophic characters. Four groups of reservoirs were evident and classification based on the degree of mineralization resulted in a clear geographical separation of the two groups. Two groups separated by trophic characters were called "less eutrophic" and "more eutrophic". Margalef discusses whether or not the study of the deepest point of the reservoir is appropriate for characterization of the reservoir trophic characters because in some reservoirs "exaggerated" concentrations of chlorophyll-a were detected and probably resulted from transport from the riverine or intermediate zone. Nonetheless, from a water quality

perspective, it is correct to use these values as representative. Water usage depends on concentrations that were generated both directly (e.g., during water treatment) and indirectly (e.g., through the deterioration of oxygen conditions of the hypolimnion). Another classification system is that devised by Zhadin (1958) and intended for Russian reservoirs. Because these are often huge, very shallow reservoirs, this classification system is not generally applicable.

The **reservoir classification** we propose is based on four major criteria:

- 1) **Reservoir throughflow**
- 2) **Geographic location**
- 2) **Trophy**
- 3) **Water quality**

The classification variables discussed herein differ, one is specific to reservoirs and the other three were originally designed for lakes. In applying these systems for use on reservoirs, we must consider different classes of reservoir throughflow and how these affect the classification. The most developed criteria is the geographical classification of lake mixing types; the trophic classification is also fairly well developed. The least developed is the more specific water quality criterion. The first three criteria are limnological and are based on natural differences between water bodies. Matching reservoir throughflow with "natural" variables is, of course, only possible in the sense that similar differences in throughflow can also be observed in natural riverine lakes (although, as pointed out in Chapter 4.2, the consequences of throughflow differ in natural lakes and reservoirs). Trophic characterization is now considered an important water quality variable due to input of anthropogenic sources of nutrients, but trophic classification was originally applied to waters that were not affected by human impact. Water quality criteria are not just anthropogenic, but are also much more diversified due to the high variability of human effects. In this chapter, we only discuss the first three classification criteria; the fourth is discussed in Chapter 9.

4.8.1 Classification based on reservoir throughflow

Reservoirs can be roughly distinguished into three classes according to their theoretical retention times, and a fourth class that is a specific mixing type occurs at the boundary between the first and second reservoir classes. The three major classes are as follows:

Class A - **rapidly throughflowing reservoirs**, $R \leq 15$ days

Class B - **reservoirs with intermediate retention times**, $15 \leq R \leq \text{one year}$

Class C - **reservoirs with long retention times**, $R > \text{one year}$.

This classification is mainly based on the data and mathematical modeling concerning temperate reservoirs (in particular Slapy Reservoir in the Czech Republic), but has been verified by use in some tropical an/or subtropical reservoirs. It is well known that reservoirs undergo rapid and extensive changes in flow and water levels, thus we re-emphasize that boundaries between classes were, more or less, arbitrarily selected. Depending on the seasonal pattern of operation in relation to river discharge, the same reservoir can belong to different classes during different time periods. Class A is characterized by full mixing, and Class B reservoir conditions correspond to geographically and morphologically conditioned lake mixing class. The third category, Class C, is intermediate and is characterized by mixing class, but distinguished to varying degrees by the effects of throughflow. Therefore, we can speak about different reservoir situations rather than

reservoir classes. In Class B, further differentiation of conditions is connected with the depth of the outlet or outflow. In reservoirs with surface outlets, the conditions are more lake-like, while considerable deviations are observed when outlets are located deep within the reservoir (see Fig. 4.9).

A specific class is represented by **hydraulically stratified reservoirs**, as documented in Tundisi (1984) in Brazil. These are reservoirs that for geographical reasons or shallowness are not stratified, but stratification sometimes appears, because of a density interflow or underflow. The manner in which these flows are created (Chapter 4.2) suggests that an original density difference must exist within the reservoir before an interflow or underflow is created. However, this density difference can be small and strongly separated by the flow. In the tropics, this phenomenon may result in large scale production of anoxia, gases, and accumulation of nitrogen and phosphorus in the artificial hypolimnion. An example of this class is the Barra Bonita Reservoir in São Paulo, Brazil, or Štěchovice Reservoir in the Czech Republic.

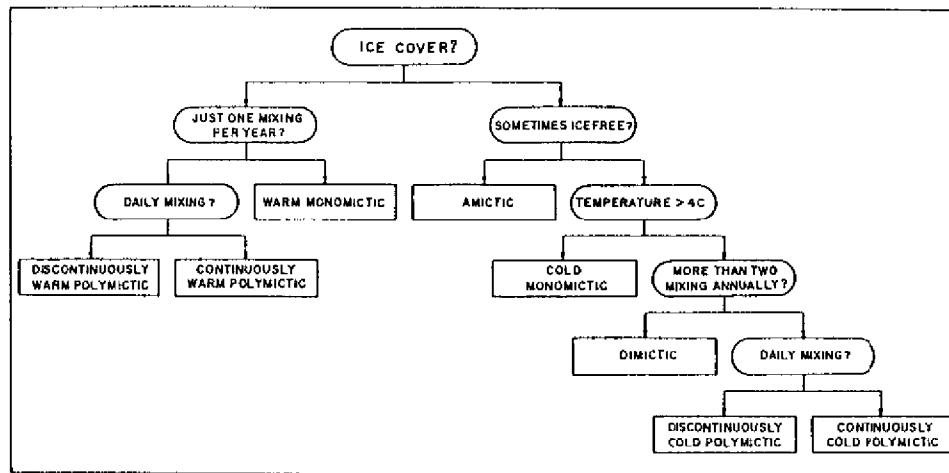

Fig. 4.22 A dichotomous key for the distinction of mixing types. Redrawn from Steinberg *et al.* (1995).

4.8.2 Reservoir mixing classes

The dichotomous key shown in Fig. 4.22 provides characters that determine corresponding mixing classes. Figure 4.23 represent patterns of stratification of individual mixing types. As previously discussed, this method is only valid for reservoirs with long retention times. Conditions are distorted by flow in reservoir of the intermediate type. Two basic variables, geographical latitude and altitude separate the classes. With the increasing altitude the geographical delineation between water mixing classes shifts toward the Equator. At higher altitudes there is higher solar radiation due to the shorter path the sun rays have to pass through the atmosphere. As concerns latitudes at low elevations, in tropics (latitudes 0 - 23) the **oligomictic** type is characteristic, with mixing rarely occurring. Mixing in tropical waters is much deeper than in temperate waters, and temperature differences between the mixed zone and hypolimnion are minimal. Nevertheless, the nonlinear dependence of water density on temperature result in a much higher change of density

per degree at high temperatures, and the density differences between strata can be similar to **dimictic** water bodies in temperate region. Daily temperature differences may exceed annual variations. **Deep polymictic** lakes occur at higher elevations in tropics, where seasonal temperature variations are low and mixing happens several times irregularly throughout the year due to strong winds. **Warm monomictic** water bodies with one annual overturn occur at latitudes

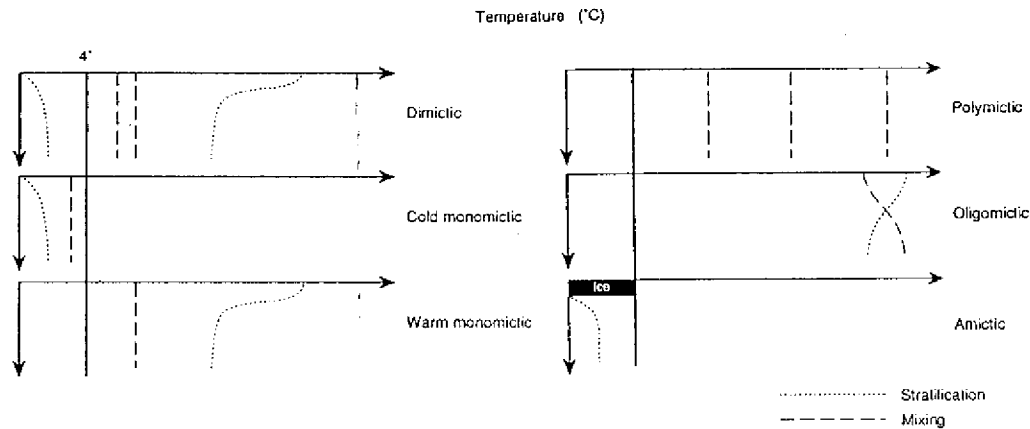

Fig. 4.23 Schematic representation of the changes of temperature stratification conditions during the annual cycle in different mixing types. From Chapman (1992).

between about 23 - 40 degrees. They circulate at temperatures higher than 4°C. **Dimictic** mixing type in temperate region (latitudes 40 - 68°) is characterized by two periods of turnover, during spring at temperatures around 4°C, and during fall, and two periods of stratification, summer stratification and inverse winter stratification (with surface temperatures lower than temperatures of deeper strata and freezing at the surface). Further North, a sequence of classes is encountered until the more or less constantly frozen lakes in the high Arctic and Antarctic. As an example of the shift of latitudinal borders toward the equator we observe that at latitude 50 the dimictic class can be substituted by the cold monomictic class on the average at elevations above 1000 m.a.s.l, and amictic lakes occur at 3000m.

The presence of drowned vegetation may have a drastic effect on all aspects of reservoir limnology. An example is presented in Fig. 4.24, where a reservoir in Amazon with extensive areas of drowned forests is confronted with a reservoir of the semiarid region in Brazil. The reservoir without vegetation has, in spite of high input of suspended material from the watershed, good hypolimnetic oxygen conditions. For the huge Amazonian reservoirs an anoxic hypolimnion and reduced mixing are characteristic. The reservoirs also produce as the result of decomposition of the drowned forests intensive gas emissions of methane and carbon dioxide. Preliminary results for the hydroelectric reservoir Curua Una show 21 mg.m².day⁻¹ CO₂. Rosa (1997) estimated the annual contribution of methane and carbon dioxide of Curua Una (area = 100 km², average depth = 6m) as 5.7 10³ kg.m⁻².y⁻¹ C for CH₄ and 53.7 10³ kg.m⁻².y⁻¹ C for CO₂. Comparative methane emission (measured as methane bubbles) of several Amazonian reservoirs suggest a decrease of

emissions with time since closing the dam (Matvienko & Tundisi 1996).

Meromixis is a feature that can occur in all classes discussed above. This results when a part of the reservoir water that is near the bottom is not mixed with the rest. In reservoirs, this is usually related to construction, whereas a small protection dam is built during construction of the major dam. Water becomes trapped and accumulation of chemical constituents takes place.

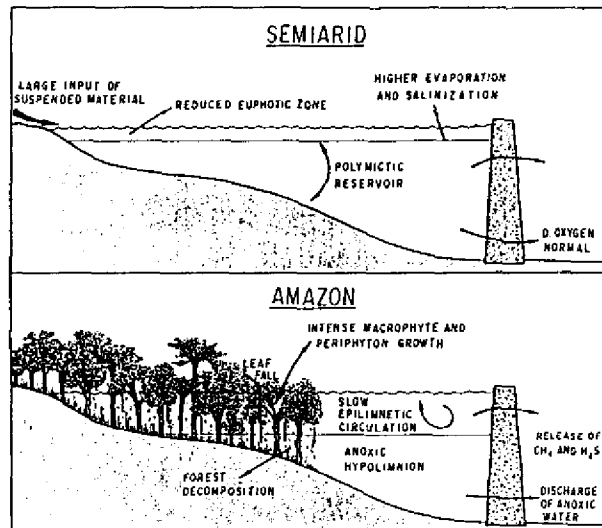

Fig. 4.24 Comparison of a semiarid and a tropical reservoir in Brazil.

One mixing type is ubiquitous - the **shallow polymictic** class. Polymixis occurs in hydro-dynamically shallow waterbodies all over the world. The force of wind is able to produce complete mixing and short periods of surface heating or cooling, respectively, create or destroy stratification.

4.8.3 Trophic classification

The following classes are recognized:

- a) **oligotrophic**
- b) **mesotrophic**
- c) **eutrophic**
- d) **hypertrophic**
- e) **dystrophic**, and
- f) **calcitrophic**.

The first five were defined by classical trophic typology, however the last was more recently defined to address calcareous lakes.

For reservoirs, further differentiation is characterized by: (i) reservoir throughflow (ii) geographical location, and (iii) turbidity. The effect of reservoir throughflow was previously

discussed. Turbidity is particularly important in arid and semiarid regions.

The classes **oligotrophic**, **mesotrophic** and **eutrophic** are delineated in accordance with the amount of critical nutrients and primary production realized particularly as algal biomass (usually measured by CHA). The drawback of trophic classification is that it is geographically conditioned because it relies on both critical nutrient concentrations and productivity. Productivity is affected by geographically conditioned solar radiation, and the mixing type and depth, turbidity, and trophic relations within the system. Productivity increases with solar radiation, but algae are exposed to the underwater light climate and not to surface radiation. Factors decreasing the underwater light climate are the increasing depth of mixing and increasing turbidity. Reservoirs which are shallow or have shallow mixing depth have higher productivity and higher chlorophyll. Last but not least, the delineation of classes also depends on subjective experiences, depending on the specific situation in different countries. At the present level of understanding trophic classes seem to be somewhat dependent on the range of conditions encountered in a given region. In countries with very clean and few eutrophic waters, there is a tendency to set lower criteria for classes. A lake that is called mesotrophic in a "nutrient rich" country may be called eutrophic in "nutrient poor" countries. In Tab. 4.2, example values are given for distinguishing classes as reported by Hilbricht-Ilkowska (1989) from Poland and by Moore & Thornton (1988). The same phenomena is seen when waters are compared in Scandinavia with those in the European mainland, and even greater differences occur when waters of temperate with tropical conditions,

Tab. 4.2 Comparison of trophic classes as defined for Poland by Hilbricht-Ilkowska (1989) and for USA by Moore & Thornton (1988). P = Poland, U = USA.

	TP		CHA	
	P	U	P	U
oligotrophic	-	<10	-	<4
mesotrophic	≤50	10-20	≤10	4-10
moderately eutrophic	≤100	>20	≤30	>10
strongly eutrophic	≤300	-	> 30	-
hypertrophic	>300	??	> 100	??

are compared. However, some approximate delineation according to algal biomass (measured as CHA) as given in Tab. 4.3 is acceptable. In reservoirs the classification is complicated by throughflow and turbidity as pointed out particularly by Walker (1985), Lind *et al.* (1993) and Thornton & Rast (1993). For tropical conditions see Salas & Martino (1991).

A difference between tropical and temperate waters is that nitrogen limitation is much more common in tropical than in temperate waters. Carbon is the third most important macroelement for algal growth and can be limiting anywhere, if both nitrogen and phosphorus are in excess. This is often the case during summer in highly eutrophic and polytrophic waters, when there is limited exchange of carbon with the atmosphere and deeper strata. The reasons for more common nitrogen limitations in the tropics are both natural and anthropogenic. While northern soils are very permeable for nitrogen but retain phosphorus, the reverse trend is true for the tropics. In

Tab. 4.3 Trophic classes based on chlorophyll-a after Straškraba *et al.* (1993).

CHL [µg.l ⁻¹]	TROPHIC GRADE	RAW WATER	TREATMENT	
SUMMER AVERAGE	ANNUAL MAXIMUM			
0.3-5	<10	oligotrophic	excellent	standard
5-10	10-30	mesotrophic	suitable	standard
10-25	30-60	slightly eutrophic	not very suitable	exceptions
>25	>60	highly eutrophic	unsuitable	special treatment

prosperous Northern Hemisphere countries, nitrogen fertilizer use is much more common than in tropical countries. Two approaches can be used to distinguish if carbon, nitrogen or phosphorus are limiting; these are the Redfield ratio and the bioassay. A simple preliminary estimate is based on the ratio of C:N:P, which is important in algal biomass production. The Redfield ration is the ideal ratio for algae and equals 106:16:1 if concentrations are expressed in atomic weight. It must be noted, however, that this ratio is only a broad average, and varies widely for individual species of algae. The ideal nitrogen: phosphorus ratio ranges between 6:1 and 30:1 as expressed by atomic weight. In waterbodies with normal algal composition, switching between P to N limitation ranges somewhere between 10:1 to 20:1. Some studies suggest that the ratio also affects the percentage of cyanobacteria in the total phytoplankton population, however, other studies contradict this hypothesis and it cannot be considered a general phenomenon. Cyanobacteria, particularly when forming heterocysts, signal nitrogen fixation, which does not occur if there is an excess of dissolved nitrogen in the water. The form of nitrogen is very important in energy transformations because nitrates must first be converted to ammonia as ammonia is more readily taken by phytoplankton than nitrate. Bioassays are accomplished by various techniques; the most simple of these uses a culture of algae as background. In the temperate region, the alga most commonly used in bioassay analysis is *Selenastrum capricornutum*. The growth curves of algal population incubated in bottles under standard light and temperature conditions are noted for control cultures and cultures enriched with N and P. Enhanced growth resulting from additions of either N or P is considered an indication of respective limitation. As mentioned previously, the needs of one algal species and culture are not necessarily identical with the needs of the other phytoplankton species or populations. Moreover, the amounts of added nutrients are important. The consequence of both of these factors (difference between one species and a population and different reactions between conditions in a culture and under natural conditions to different nutrient doses) is that the results may not be conclusive.

Dystrophic classes (brownwater lakes), with production affected by a high water color appear in forested areas. The color results from an excess of dissolved, decomposition-resistant organic matter from decomposed vegetation. The black waters of the Amazon typify this class. The pH of dystrophic waters is low and may limit the existence of some organisms (Chapter 6.2).

The **calcitrophic** class distinction is necessary because trophic relations in calcareous waters are different from those in waterbodies with a more balanced salt composition. One important process that distinguishes calcareous waters is phosphorus coprecipitation; calcium not only precipitates and forms white flocculants but also adsorbs phosphorus. This creates algal production conditions

that are markedly different than those of noncalcareous waters. Table 4.4 lists some characteristics of calcitrophic reservoirs.

Tab. 4.4 Characteristics of calcitrophic waterbodies as compared with noncalcareous waterbodies (based on Koschel 1987).

Concentrations of CaCO ₃	Maxima > 1 mg.m ⁻³ , present as crystals and calcite shells of some algae
Carbon dioxide	Decreased, limits primary production
Nutrients	Decreased, -"
Periodicity	Highest concentrations of calcite in summer
Self-purification capacity	Increased
Particulate matter	Higher concentrations, low light levels limit primary production, increased sedimentation, reduction of nutrient concentrations
Phytoplankton biomass	Reduced

4.8.4 Combined classification

Mutual relations exist among the various criteria showing that for reservoirs the throughflow criterion is critical in classification of reservoirs. This criterion modifies other lake-derived classification systems that the full "lake" realization that we describe under mixing classes only takes place in low flow reservoirs. In the other two reservoir throughflow categories this is highly modified. Interrelations among the three criteria, throughflow, mixing and trophy, are outlined in Tab. 4.5.

Tab. 4.5 Interrelations between basic reservoir types as characterized by throughflow, mixing and trophy.

	THROUGHFLOWING	INTERMEDIATE	LONG RETENTION
RETENTION TIME R	≤ 20	20 < R ≤ 300	R > 300
MIXING CLASS	Fully mixed	Intermediate stratification	Well developed stratification
TROPHIC CLASS	Flow prevents full plankton development	Additional effects of flow and modified stratification	Classical trophic classes

CHAPTER 5

RESERVOIR FISHERIES AND ITS RELATION TO WATER QUALITY

Reservoirs have important potential for use in fish production. In many regions of the planet, such as Russia, the USA, Africa and South-East Asia (Fernando & Holčík 1991), fisheries production in reservoir is very intensive.

5.1 FISH COMMUNITIES IN RESERVOIRS

One of the most dramatic results of reservoir construction is the alteration of water flux from the river to the reservoir and consequential changes in fish fauna. These alterations, from a lotic to a lentic environment, produce new habitats types for which many common river fish species are not well adapted. For example, in many reservoirs there is a deep pelagic area, that is not utilized by most native fish species. When we examine the development of and structural and functional organization of reservoir fish fauna, the following five groups of processes must be considered:

- a) productivity of each reservoir immediately after being filled,
- b) eutrophication and nutrient enrichment received from the watershed,
- c) development of complex biotic interactions within the reservoir,
- d) hydrological regimes, and,
- e) the management of each reservoir.

According to Kubečka (1993) the first two groups of processes directly influence fish composition and biomass, whereas complex biotic interactions also influence the eventual composition of fish fauna. Reservoir construction affects fish fauna downstream as well as upstream, since many wetlands and flood-plains downstream may be depleted of water, at least during initial phases of reservoir operation. According to Fernando & Holčík (1991), the fish fauna of a reservoir depends primarily on existing native fish fauna in the hydrographic basin. These species may colonize a new reservoir very rapidly and can exploit the reservoir's responsible potential as a lentic environment. Once the reservoir is in operation, fish biomass falls quickly. Two factors seem to be responsible for this reduction; these are the existence of an extensive, deep pelagic zone and the drastic reduction in current velocity. Subsequent to reservoir filling very slow, natural colonization of the pelagic zone occurs. The family Clupeidae is a good example of fish that successfully colonize reservoirs, as demonstrated in Tab. 5.1.

On example of changes in fish fauna after dam construction is the changes observed in Caborra Bassa Reservoir, Africa. Of the 38 species of fish that existed before the dam, almost all have disappeared. Cichlidae like *Tilapia rendali* and *Sarotherodon mortimeri* survived in the reservoir in low densities. Some species of Siluridae, Characidae and Cyprinidae experienced explosive growth immediately after the dam was closed (Jackson & Rodgers 1976). In the case of Lake

Tab. 5.1 Examples of colonization of reservoirs by members of the family Clupeidae.

SPECIES	RESERVOIR	BIOMASS [kg.ha ⁻¹]	AUTHOR
<i>Sterathrissa leonensis</i>	Kainji L., Africa	23.6	Lelek 1973
<i>Pellonula afzelinsi</i>	Kainji L., Africa	23.6	Lelek 1973
<i>Clupeichthys aesarensis</i>	Ulboratana R., Thailand	5.9 - 14.2	Lelek 1973
<i>Etrivaza fluviatilis</i>	Parakrama Samudra, Sri Lanka	60	Newakla & Duncan 1984
<i>Clupeonella cultiventris</i>	5 reservoirs on the Dniepr River, Russia		Shimanovskaya <i>et al.</i> 1977
<i>Corica subarna</i>	Kaptui Lake, Bangladesh	100	Fernando & Holčik 1991
<i>Godusia chana</i>	"		
<i>Cosmialosa mannianna</i>	"		

Volta, Ghana, mass fish mortality was observed after the dam was closed, and was caused by accelerated deoxygenation. Of the many common river species in the genus *Alestes*, only two have disappeared (Lelek 1973). On the other hand, there was a considerable increase of *Tilapia* spp., such as *Sarotherodon galileus* (which feeds on phytoplankton and periphyton) *Tilapia zillii* (which feeds on detritus) and *Sarotherodon niloticus* (which feeds on macrophytes and algae). Fish species that inhabit the reservoir after the dam is closed migrate either directly to tributaries or to areas that are influenced by the tributaries. Current velocity differs in several regions of the reservoir and is an extremely important factor in the distribution of fishes. Fish are apparently able to locate tributaries by detecting water quality changes. Maintenance of the water flux in the ancient river bed of the reservoir system can stimulate fish migration in the reservoir. Populations of fish can, therefore, survive in the reservoir by utilizing tributaries, as demonstrated in studies of several reservoirs (Jackson 1960). Strictly rheophilic species lack critical habitats and they either disappear rapidly in lentic waters or they survive by using tributaries for reproduction, but their biomass in the reservoir diminishes considerably. Reservoir filling results in spatial reorganization of the system and can result in new wetlands as well as a very deep pelagic zone. In some cases, it was demonstrated that several years after filling the reservoir contained more fish species than the river, probably due to the variety of niches produced during the spatial reorganization of the system. This phenomena also depends on evolution of the reservoir and the process of temporal and spatial succession. Establishment of aquatic vegetation immediately after reservoir filling can encourage an increase in fish biomass. This vegetation is colonized by a large, varied invertebrate assemblage, which can serve as fish food. Extensive macrophyte stands and a high concentration of periphytic algae are fundamental in development of varied feeding sources for fishes, as demonstrated by Lake Kariba. Thus, trophic upsurge very much depends on growth of phytoplankton, periphyton and macrophyte biomass. When littoral and marginal areas of the reservoir are colonized by macrophytes, the survival of alewives and young fishes generally increases. Aquatic vegetation produces food and provides shelter from predators and adequate reproductive habitats. Reproduction of the fishes in the reservoir is directly related to the existence of upstream wetlands.

Pelagic zone of the reservoirs and fish fauna.

Many reservoirs include an extensive pelagic zone which can be colonized by planktophages and their predators. In some reservoirs, planktophagous fishes colonize the pelagic zone, immediately after filling, and increase biomass even as compared with the lotic environment. Predators that

colonize the pelagic zone consume these planktophagous fishes. For example the Nile Perch (*Lates niloticus*) and the Tiger Fish (genus *Hydrocynus*) in Lake Kariba developed high biomass due to availability of food. In the case of *Hydrocynus*, 70% of its food is composed a single species of planktophagous fish - the freshwater sardine *Limnotrissa miodon*. A change in feeding habits has been documented for some species of fish, that colonize reservoirs, e.g., *Hydrocynus* sp. are generalists in rivers, but become predators of planktophagous fishes in reservoirs. Out of 110 species that once inhabited Itaipu Reservoir, only 83 survived. Some of the species that disappeared, such as pacu (*Piaractus mesopotamicus*), were commercially important. Pacu feeds on vegetation from the gallery forest. Some migratory species, like *Leporhinus elongatus* and *L. obtusidens*, remained in the reservoir and utilized the upstream floodplain during part of their life cycle. One species (*Plagioscion squamosissimus*), introduced into Itaipu and other reservoirs, grows very well in many of the reservoirs. This species is a pelagic fish, and preys on small carnivorous or planktophagous fishes. Several species of detritus feeders disappeared in Itaipu and other reservoirs. One important findings in the study of South American reservoirs is that the interaction of the reservoir with upstream wetlands and floodplains is a fundamental element in the survival and reproduction of the fish species in the reservoir (Agostinho *et al.* 1994). That is, spatial reorganization of the system that introduces new components of heterogeneity during the evolution of the reservoir produces higher diversity of fish species and greater biomass. This is a very important consideration for a manager who is trying to increase diversity and biomass of fish in reservoirs.

5.2 BIOMASS AND FISH PRODUCTION IN RESERVOIRS

As mentioned earlier an increase in biomass occurs immediately after the dam is closed, although a considerable decrease in diversity is always observed. In the case of reservoirs, however, the ecosystem is extremely dynamic and is always in a continual process of reconstruction. A continual colonization by several species occurs during the first years when the reservoir is subject to morphometric alterations (due to rising water level) and changes in the water chemistry and biogeochemical cycles. The evaluation of fish stocks in reservoirs is a difficult task, and one that demands utilization of several methods. Selected data on fish catch and production are summarized in Tab. 5.2.

One estimation method that is commonly used for lakes and reservoirs is the morphoedaphic index. This method according to Ryder (1965), can be expressed as:

$$\text{Morphoedaphic index (MEI)} = \text{TDS} / z_{av},$$

where TDS is the concentration of total dissolved solids in mg. l⁻¹ and

z_{av} is the average reservoir depth.

Henderson & Welcomme (1974) have found that a better fit is observed when the morphoedaphic index is expressed as:

$$\text{MEI} = \text{TDS} / \text{conductivity}.$$

Tab. 5.2 Fish production in several tropical reservoirs.

RESERVOIR	CATCH tons.year ⁻¹	PRODUCTION kg.ha ⁻¹ .year ⁻¹	AUTHOR
7 reservoirs of Parana watershed (Brazil)	4.51		Petrere & Agostinho 1993
17 reservoirs of the Nord-east of Brazil	151.8		Paiva <i>et al.</i> 1994
Reservoirs in Africa	99.5		Marshall 1984
Lakes in Africa	58.4		Bayley 1988
Sobradinho Res., Brazil	24 000	57.1	Petrere 1986
Itaipu, Brazil		11.6	Petrere 1994
Guri, Argentina	300	10	Alvarez <i>et al.</i> 1986

They conducted an intensive study that demonstrated that fish catch is related to limnological variables, but also includes a fishing effort variable. Schlesinger & Regier (1982) proposed that the trend of higher fish catch in lower latitude areas could be due to higher temperatures in those ecosystems; they verified significant positive correlation among the fish catch and average air temperature, when all or practically all other limnological variables were considered equal.

However, Kerr & Ryder (1988) warn that fish yield indicators must be differentiated between lakes and reservoirs + rivers. The reasons for this are as follows:

1) Abiotic factors exert inordinately large effects on the biota of rivers and reservoirs. There is wide seasonal and annual variability in morphological dimensions and hydraulic factors. Accordingly, Henderson *et al.* (1993) found stronger statistical relationships between these factors in reservoirs than in lakes.

2) In the reservoirs, species of fish differ from those of the original river. Many species lack coevolutionary adaptations for these new circumstances. Annual recruitment by these species can vary widely and result in erratic yields. Often, high production levels are represented by only one introduced species (*Lates niloticus*).

. In USA reservoirs, Jenkins (1967) and Jenkins & Morais (1971) developed multiple regression equations that relate environmental factors to fish stocks and angler catches. They found that retention time was a strong predictive variable, as were total dissolved solids, reservoir depth and reservoir age. Dolman (1990) classified fishes in Texas reservoirs based on species densities. He distinguished five groups that inhabited reservoirs in different areas of the state. He used rotenone poisoning solely in the bays to census fish populations, thus obtaining poor estimates for pelagic species. Length of growing season, elevation, turbidity, pH, total alkalinity, conductivity and hardness of each reservoir were limnological variables used to discriminate between different groups.

A positive bilogarithmic relationship between the degree of eutrophy, which is expressed as the normal phosphorus load, and the fish yield of lakes and reservoirs was developed by Lee & Jones (1991). The authors also describe species changes with increasing eutrophication, which results in a decrease or disappearance of highly-valued, cold-water fishes and an increase of less desirable species. Mass mortalities of juvenile fish occur in winter in Hartbeespoort Dam, South

Africa because of hypereutrophic conditions. Another indication of the fish catch used by some reservoirs in Nigeria is one that uses recorded fish effort per boat in artisanal fisheries. Another measurement is experimental net fishing. The development of sustainable fish stocks in reservoirs is part of the biological component of limnological succession according to Kubečka (1993).

5.3 MANAGEMENT OF FISHERIES AND AQUACULTURE

Management of reservoir fish fauna and maintenance of a sustainable fish stock is a complex task. It involves not only a deep understanding of ecology of the system, including limnology and fisheries biology, but also on the rules of reservoir operation and desired multiple uses. Therefore, knowledge of ecology of the system and management of the fish stock are coupled. Introduction of exotic species into a reservoir can cause extraordinary management complications. Frequently, lack of scientific knowledge about the structure of the food web, species interactions and the growth rate of populations can lead to extremely complex situations, sometimes with irreversible dominance of non-commercial species. Management of the fish stocks must begin, therefore, with determination of species presence and diversity, the structure of the food web, and regulating functions such as predator-prey relationships. Management of fish stocks must include consideration of estimates of the fish catch, the fisheries effort and the number of fishermen that are likely to use the reservoir. The use of echosounders is a recently developed tool that is useful in fisheries management. Knowledge of the biology of fish species is necessary in order to determine reproduction timing and requirements, and interactions of biological characteristics of fish populations with hydrological and climatological features. One must also consider whether the reservoir has a monospecific or multispecies composition when estimating potential fish catch, because fisheries effort differs for each species. Therefore, well-managed fisheries harvest is supported by good statistical data regarding fish production, fisheries effort, average catch per fisherman, number of fisherman that utilize the reservoir, and current market information. Another important event in fisheries management is the follow-up process after reservoir aging and resulting alterations in the fish fauna structure. Considering the natural alteration produced by the reservoir or due to other factors such as contamination. The determination of the main location and distribution of important species and species stocks in relation to various regions of the reservoir is also necessary. For some reservoirs, we can define the fish stock and fisheries management areas into the following three regions: the lacustrine region with a deep pelagic zone, the transition zone, in some cases with an area of intensive macrophyte growth and the lotic inflow zone. The lotic riverine zone is commonly inhabited by migratory fish, which reproduce in marginal shallows.

One of the most important developments in fisheries management is the implementation of a variety of fish ladders. The efficiency of these systems is debatable because the effectiveness of some designs may be variable in different reservoirs. Generally, their efficiency is found to be very low. It is necessary to adapt each mechanism to one specific reservoir, while considering the reservoir's fish species.

Development of aquaculture in reservoirs is a good perspective. Considering the high levels of dammed rivers throughout the world, cultivation of fishes and other vertebrates (alligators,

capibaras), crustaceans and molluscs could considerably increase production of aquatic biomass of aquatic origin. However, the following precautions must be acknowledged:

- a) techniques must be carefully selected,
- b) an increase of eutrophication can occur, and
- c) the spread of tropical water borne diseases must be prevented.

5.4 RELATIONS OF FISHERIES TO WATER QUALITY

5.4.1 Sensitivity of fish to water quality

Fish fauna within a reservoir change in accordance with water quality characteristics, which may be related to the following two factors: a) the introduction of pollutants by tributaries that can influence different portions of the reservoir; and b) the change in the operation of the system throughout the hydrological year. For example, large fish kills were observed in Barra Bonita Reservoir (Brazil) in 1994 due to a combination of increased retention time and the discharge of poorly oxygenated water from polluted tributaries. The release of water with low oxygen levels upstream produced extensive fish kills downstream. The water was released from a highly polluted urban reservoir upstream and plunge into the deeper strata of Barra Bonita. Simultaneously, very high ammonia concentrations, exceeding 3 mg.l^{-1} , occurred. Fish kills are observed in temperate regions when reservoirs are frozen, but also occur in very shallow, eutrophic reservoirs when oxygen concentrations drop below certain limits.

In temperate regions, fish species are very sensitive to low oxygen concentrations, and the lower limit is usually considered to be somewhere around 2 mg.l^{-1} . Condition of pH can also be limiting; fish usually do not occur in temperate regions in waters that have a pH that is less than about 5, and never occur in waters where the pH is below 4.5. The situation is completely different in the Amazon region, and perhaps in tropical black water, rivers in general, where fish live in oxygen-deprived waters for most of the year.

Fish sometimes survive in waters that are contaminated by certain kinds of pollutants, however, consumption of these fish may then be harmful for humans. Examples include the disease "minimata" in Japan that was caused by accumulation of mercury in fish, the same diseases, which appeared in newly flooded reservoirs in Northern Canada, and the case in which an Indian population that relies on fish was poisoned by mercury that leached from soils adjacent to the reservoir.

5.4.2 Influence of fish on water quality

Fish play a major role in the reservoir biocenoses and are, thus, important from a water quality perspective. The presence or absence of certain species of fish and the amount of fish present in a reservoir co-determine the composition and amount of zooplankton and phytoplankton present in the reservoir.

Estimation of the amount of fish present is not easy; fisherman statistics are sometimes an unreliable representations of the total biomass because usually only larger fishes (both larger species and sizes) are caught and noted as well as the uncertainties inherent in reporting, etc.

Census methods such as electrofishing, use of nets of various sizes, rotenone poisoning in coves, catch per effort and mark-recapture censuses are more reliable for use in estimations, although some of these provide relative rather than absolute estimates. With the recent advancements in echo-sound technology, (double-beam echosounder) the best estimates of biomass and size distribution can be obtained.

The species composition of fish fauna is highly dependent upon geographical features and, according to Fernando & Holčík (1991), lakes and reservoirs are characterized by a lack of truly pelagic species, and most reservoirs are inhabited by species that originated in the shore regions. A few clupeid genera are exceptions to this generalization and inhabit large African reservoirs (see above). A useful method of classifying fish is in accordance with their feeding habits. In respect to trophic interrelations, the groups provided in Tab. 5.3 can be recognized. The species named as examples are representatives of genera living in Europe, Northern N. Asia and Northern U.S.A.

Tab. 5.3 Fish grouped in accordance with their feeding relations.

GROUP	FEEDING ON	EXAMPLES (Holarctis)
Zooplankton feeders	Zooplankton	<i>Rutilus, Blicca</i>
Plant feeders (incl. phytoplankton)	Macrophytes	<i>Tilapia, Ctenopharyngodon</i>
Benthos feeders	Chironomidae	Common carp
Predators	Fish	<i>Esox, Lucioperca</i>

In all instances, the groups indicated are valid only for adult fishes, whereas juveniles feed on small zooplankton, and gradually move to larger prey as greater sizes are achieved. In populations in which juveniles dominate (Fig. 5.2), a considerable impact on the zooplankton populations may occur. The balance between zooplankton-feeding fish and predatory fish is important in the control of zooplankton composition. In Chapter 11.3 we will discuss how the species composition of zooplankton depends on feeding pressures of fish and how this relationship is used in reservoir water quality management.

Sport fishermen may have very biased information about the density of fish populations in the reservoir. They are usually only interested in fish of "permissible" size, and, therefore do not consider small fish. However, young fish may be the dominant element in the fish populations. When overpopulation reaches a certain extreme degree, healthy fish may have greatly retarded growth and carp that are below 20 cm total length (well below the average adult length) be sexually mature and reproducing. Sport fishermen may not recognize that stocking the reservoir with juvenile fish can make the situation even worse. Surprisingly, overfishing appeared to be the explanation for the disappearance of the greatly valued cold-water fish in Lake Erie (Welch 1978, cited in Lee & Jones 1991).

The presence of zooplankton-feeding fish and their predators is significant both in evaluating the water quality of supply reservoirs and as a biomanipulation tool (see Chapter 11). Recent investigation in Great Lakes (Stow *et al.* 1995) indicate that it is possible to reduce the consumption of PCB contaminating the lakes by proper fisheries management.

5.5 FISH INTRODUCTIONS

Welcomme (1988) lists 1354 international introductions of 237 freshwater organisms (not only fish) into 140 countries. The hazard of introductions is in our inability to predict its outcomes. It is also clear that on a global scale the introductions created until now more harm than profit. Fish introductions are a dangerous operation, often with negative effects on local fisheries but also some successful examples. The introduction of weeds, parasites and other noxious animals accompanies fish introductions.

Introduction of exotic species in reservoirs has produced several direct and indirect effects. Depending on the existing feeding niches in the reservoir, the impact of introduced species can be small and they may colonize niches with a low number of competitors. This is the case in Lake Kariba, where introduction of planktophagous species that exploit the pelagic zone was successful. However, other introductions can completely change the structure of the food web and cause further complications, as described by Zaret & Payne (1973). These two authors detailed extensive changes in the food chain that occurred after introduction of *Cichla ocellaris* (local name tucunaré) in the reservoir Lake Gatun, Panama. A successful case of exotic fish introduction in the reservoirs of northeast Brazil was described by Fernando (1991). In this case, production increased very rapidly and *Tilapia* spp. represent 30% of the total fish catch within these reservoirs.

CHAPTER 6

RESERVOIR POLLUTION AND WATER QUALITY DETERIORATION

6.1 SOURCES AND COMPLEXITIES OF POLLUTION

Reservoir water pollution types are not different in any way from those found in other waters, however, the realization and consequences of pollution can differ between reservoirs, rivers, and lakes. The greatest challenge facing solutions to water pollution is not merely the steady increase, but also the escalating diversity of water quality problems (Fig. 6.1). The figure also stresses other unpleasant features of aquatic pollution. The time span between the appearance of new problems is rapidly increasing, yet before humankind has solved one problem, new problems appear. The extent of the problems is also increasing, in contrast to older problems, which were mostly local. Prior to heavy industrialization, organic pollutants from small towns did not progress beyond the stream closest to the source. Now we are faced with quite a different situation; diffuse pollution leaching from agricultural fields is threatening whole countries and acidification far beyond the source country's borders. We do not seem yet to be at the end - global warming and global changes are beginning to encompass the whole planet (Chapter 16). This is not just the result of rapid growth and consumption by humankind, but is exacerbated by our bad habits. With the onset of stream channelization we began disruption of the natural return cycle of matter from nature to humans and back to nature, and nowadays matter is returned in quantities that exceed the natural digestive and homeostatic capacity of the environment. Many pollution types occur simultaneously and interact in manners and inflict consequences that are insufficiently known to us.

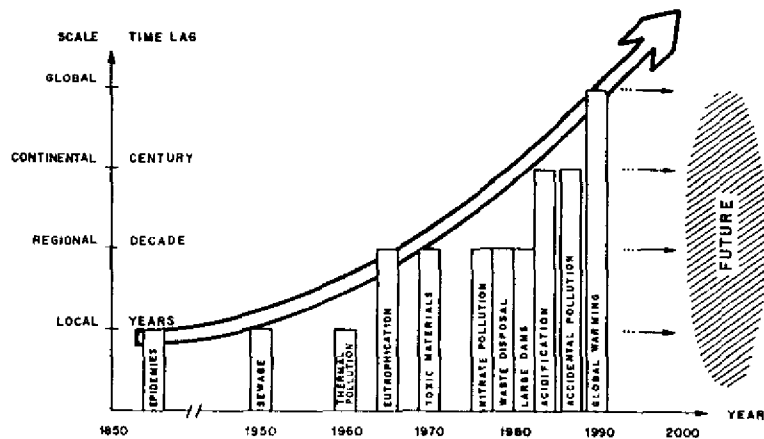

Fig. 6.1 Time development of water quality problems. The frequency of the occurrence of new problems increases and the scale and time lag between the appearance of the problem and its solution increases, too. From Somlyódy (1994).

6.2 CLASSIFICATION OF WATER QUALITY PROBLEMS

Water quality problems can be classified according to the sources and causes of pollution provided in Tab. 6.1. The realization of each problem in reservoirs is briefly explained below. Sources are generally separated into point sources and non-point (diffuse) sources. The non-point sources are much more difficult to manage (Fig. 6.2).

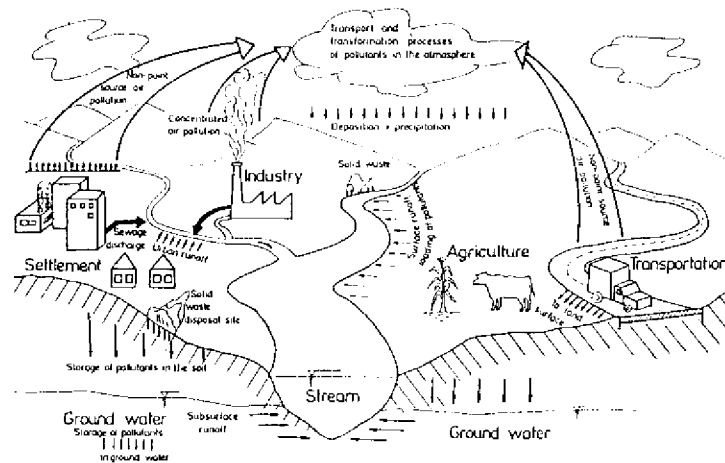

Fig. 6.2 Schematic representation of non-point source pollution. From Jólankai (1983).

Tab. 6.1 Common water quality problems in reservoirs

-
- * Classic organic pollution
 - * Eutrophication: excessive organic matter production within a reservoir due to high nutrient input
 - * High nitrate contamination and associated hygienic problems
 - * Hypolimnetic anoxia
 - * Acidification: decrease of pH and associated leaching of metals; may be caused by acid rain and accompanying mass transfer of contaminated atmospheric gases
 - * Turbidity problems resulting from siltation
 - * Salinization due to excessive fertilizer application on land or due to irrigation in arid and semi-arid regions
 - * Bacterial and viral contamination
 - * Health and water-borne diseases
 - * Heavy metal pollution
 - * Agro-chemicals and other toxic chemicals; accumulation of toxins in sediments and bioaccumulation in living organisms
 - * Decreased water volume and levels
-

The problems presented in the table were not placed in order of significance and the position of any item does not suggest corresponding importance, as major local differences prevail due to specific land use and intensity. A study of ILEC (Kira 1993) points out the following five major problems (Fig. 6.3) that occur on a global scale:

- 1) Accelerated siltation
- 2) Contamination by toxic chemicals
- 3) Eutrophication
- 4) Declining water levels and decreased water volume
- 5) Acidification

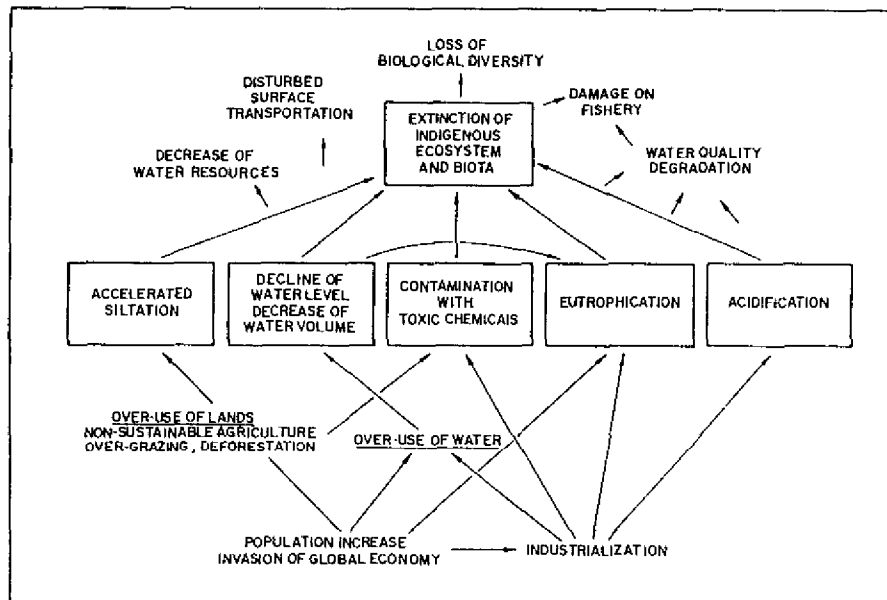

Fig. 6.3 The five most important water quality problems in lakes and reservoirs as recognized by the ILEC study, their causes and consequences. Redrawn from Kira (1993).

The environmental health of a reservoir is affected by the results of human activities in the watershed that include: (i) disposal of domestic wastewater, (ii) disposal or runoff of agricultural wastewater, particularly if it includes effluents from animal husbandry, (iii) runoff from farmlands or lands that are subject to erosion, (iv) runoff in regions that are subject to atmospheric pollution such as of acid rain, (v) concentrated seepage from ore dumps, (vi) toxic organic compounds from pesticides that are used in agriculture and forestry, and (vii) runoff contaminated by xenobiotics, persistent organic compounds used as industrial catalysts, and minute traces of pharmaceutical compounds resulting from unknown activity and hospital waste (Bernhardt 1990). These factors all result in water quality degradation, loss of biological diversity and loss of water resources.

Based on previous experience with environmental problems, we know that there is a strong relationship between the degree of pollution and density of population in both poor and rich countries, from subarctic through temperate and tropical regions. The following three are major input sources to watersheds and, thus, drive this relationship:

- i) urbanization
- ii) industrialization
- iii) large scale agricultural development

Decreases in the water retention capacity of a watershed is another important consequence of population growth which simultaneously also represents decreased pollutant retention capacity. Channelization of streams and rivers is a technique that has created numerous water quantity and water quality problems. Some wealthy countries are now attempting to return streams to their natural beds. Figure 6.4 illustrates recent increased damage in the U.S.A. due to floods, which are attributed to decreased water retention capacity, as well as other environmental consequences of development. Although reservoirs generally increase water retention, evidently they are not adequate for flood control, and other measures are necessary.

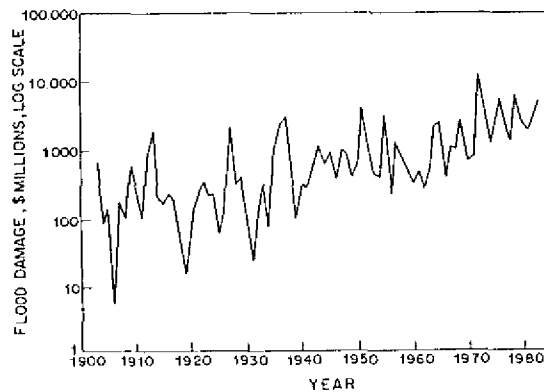

Fig. 6.4 Increasing flood damage. Note that the scale is logarithmic. Redrawn from Naiman *et al.* (1995).

As a reservoir evolves and multiple uses increase, sources of pollution and deterioration diversify, and render existing problems enormously complex.

6.2.1 Organic pollution

The primary large-scale consequence of population growth and urbanization is high input of **untreated sewage** into reservoirs. When sewage enters a reservoir, it increases both decomposable organic matter and nutrients. Symptoms of organic pollution are mixed and include large-scale decomposition of organic matter, increased hygienic contamination, and eutrophication. Distinguishing between increases in organic matter and nutrient levels is necessary because different control measures are employed to solve the problems each factor produces.

Two major potential sources of organic pollution can be distinguished; these are human settlements and aquaculture. In developed countries, pollutants originating from settlements are, for the most part, reduced to acceptable limits. However, recreational activities within reservoirs may be a major uncontrolled source, particularly when many people visit a reservoir for swimming or other activities. Intensive aquaculture within a reservoir or its inflows can also be an important source of contamination.

In less developed regions, organic pollution entering the inflows can be quite high, and the viable management solution is reduction, both by conventional means and ecotechnology, such as wetland enhancement and creation.

Figure 6.5 is an overview of the effects of organic pollution on a reservoir. As sewage enters the reservoir, a series of problems related to the chemistry and biology of the reservoir begins. The hypolimnetic water undergoes intense changes and a decrease in quality. Economical losses associated with anoxic conditions in the reservoir are very high, since it may no longer be feasible for use as drinking water, as a result of high contamination by components released from sediments (CO_2 , H_2S , iron, manganese, and phosphorus) and highly increased treatment costs. Corrosion of structures may be observed due to high CO_2 and H_2S concentrations. This can include the turbines in hydroelectric power plants and even the reservoir wall. This was the case in El Cajon Reservoir, which was mentioned previously.

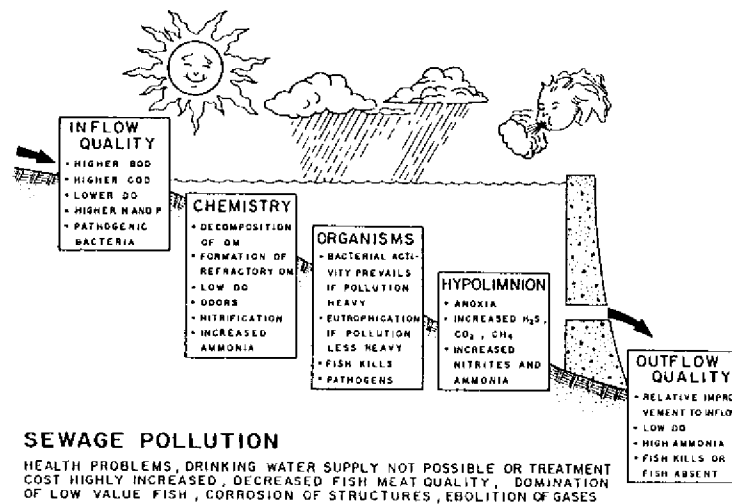

Fig. 6.5 Schematic representation of major consequences of sewage pollution in a reservoir. Below the economic impacts are listed.

Entering from external sources, pathogenic bacteria experience explosive growth and sanitary conditions rapidly deteriorate. Simultaneously, high nutrient input stimulates rapid growth of algae and/or higher plants. Alternatively, when toxics are entering the reservoir growth of plants can plummet.

It should be noted that, to a certain degree, these effects are similar to those of eutrophication, as illustrated in Fig. 6.6. In both cases, the stimulating agent is organic matter; the major difference is that in eutrophic waterbodies, this is chiefly a consequence of natural matter produced within the waterbody (predominantly by algae), whereas in polluted waters, the source is external and most often from human settlements or industry. In conjunction with this difference, the latter usually contains other ingredient in addition to organic matter. These may include microbial contamination, heavy elements and other pollutants. Depending on the degree

of prior treatment, if any, and what sources fed the sewers, organic matter of this origin may be only partially degradable.

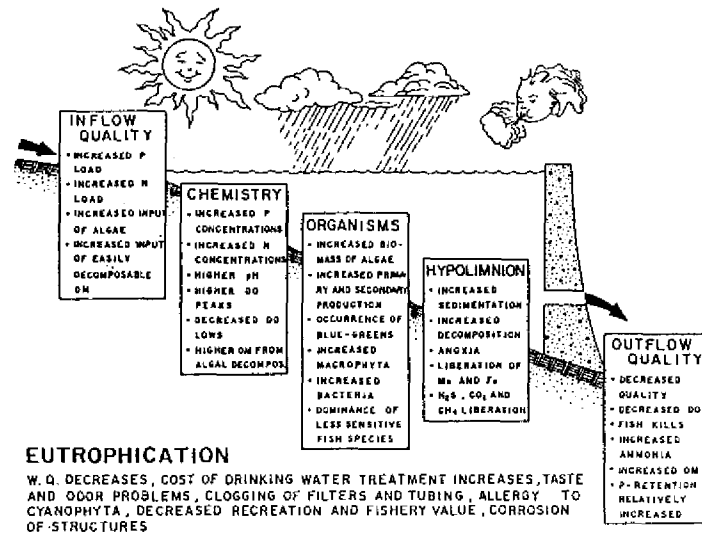

Fig. 6.6 Schematic representation of major consequences of eutrophication in a reservoir. Below economic impacts are listed.

6.2.2 Eutrophication

Eutrophication (Fig. 6.6) can be defined as excessive organic production within a reservoir due to high nutrient input. Dominant sources of these nutrient inputs are the same as those of organic matter - sewage and agriculture. Where sewage is concerned, a high degree of eutrophication is also caused by **treated sewage**, which levels of organic matter that would be harmful to the reservoir, but still contains enriched nutrient levels, in particular phosphorus, which is the most critical. Wallsten (1978) investigated 25 Swedish lakes in the period from 1934 through 1975 and observed no increased total phosphorus concentrations in agricultural areas, yet highly increased levels in lakes that receive sewage from neighboring industries and communities. Simultaneously, there was a 50% general increase in conductivity and 150% increase of sulphate. The pattern of phosphorus concentration as related to passage of time in a wealthy European country is illustrated in Fig. 6.7. After a period of exponential increase that occurred until 1976, there was a stagnation, which was followed by rapid decline. Evidently, with proper management, it is possible to obtain considerable improvements.

Masses of algae, including Cyanobacteria that may become toxic to organisms and humans are produced in eutrophic water bodies. The cost of treating eutrophied and polluted water, as reported from Brazil, is four times as high as the treatment of clean primary sources. Recovery from eutrophication is very slow; in some lakes, it has taken up to ten years after external sources of phosphorus were terminated for full recovery of the trophic category of the lake (e.g., from eutrophic to mesotrophic). A less intensive effect was observed in some lakes/reservoirs, where phosphorus and chlorophyll concentrations decreased but not to a degree that justified trophic

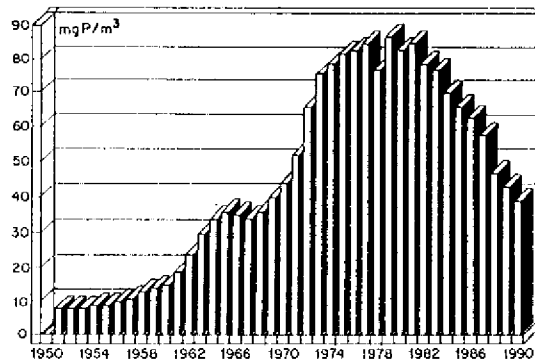

Fig. 6.7 Time sequence of phosphorus concentrations in Switzerland.

recategorization. The length of time required for recovery depends on the degree of the accumulation of phosphorus in the sediments. Phosphorus is continuously released from the sediments to free water.

6.2.3 Nitrate contamination

Nitrogen compounds act in two very different ways in water:

- i) as a nutrient, which may become critical for development of phytoplankton in some waters (generally the case in brackish and marine waters)
- ii) by direct creation of hygienic problems.

It appears that, in most of the world, limitations due to nitrogen deficiencies is not widespread, thus nitrogen's role in the creation of hygienic problems is the more important of the two. When a specific nitrate concentration is exceeded (laws in different countries specify values between 20 - 50 mg.l⁻¹), there is a danger associated with use of the water for consumption by babies. Methemoglobinemia is a deadly disease that can result under some conditions, particularly when preparation of artificial milk takes place under poor hygienic conditions when nitrates turn into nitrites.

6.2.4 Siltation

Turbidity of reservoirs is a natural consequence of erosion, however, levels have greatly increased in recent years due to human activities. Erosion is generally higher in semiarid and arid countries than in regions characterized by well-developed vegetation. These two regions also vary in terms of the size structure and other features of silt. In semiarid/arid regions, very fine silt prevail, whereas the composition of silt in the temperate region is much coarser. Waters in areas with fine silt tend to have persistent turbidity, or turbidity that lasts long after the eroding waters reach their eventual destination. Sedimentation rates of this kind of turbidity are very low, and ordinary turbulence in the water is enough to keep these fine particles suspended for a period up to several months. In regions with more balanced water budgets, vegetation can largely prevent erosion. Erosion is determined by the average amount of rain, and also by the frequency, intensity and duration of rain events.

Agriculture is a major source of increased erosion, because most agricultural soil remains barren or with insufficiently developed vegetation for long periods of time. Meadows are an exception, being overgrown continuously, but grazing can reach such an extent that erosion becomes high. Additionally, many fields are still plowed up and down the slope, whereas contour plowing can efficiently reduce the danger of erosion. The terrace agriculture of certain Asiatic countries is an example of old traditions that lead to minimization of erosion. Other sources of erosion include road construction and any building activities, during which vegetation is removed and the underlying soil is left barren for prolonged periods of time. Losses of soil have long-term consequences for agriculture. Weathering of rocks is a very slow process and, at some point, the effort of renewing lost soil is far greater than that of minimizing losses. This is particularly critical in regions with shallow soil layers.

The most direct consequence of siltation of reservoirs is a corresponding decrease of reservoir capacity. The example mentioned in Chapter 10.6 illustrates, that such losses can be extreme, and may decrease the life span of reservoirs to just a few decades. Treatment of turbid waters for use as drinking water is expensive. Other consequences of turbidity include decreased plant and phytoplankton productivity (which could be desirable in eutrophic water bodies) and decreased biodiversity. Fine silt in semiarid/arid countries interferes with feeding by zooplankton and, thus, control of algae is diminished. One example of the positive effect of natural siltation occurred along the lower Nile, where annual sediment loading enriched the fertility of the soil, however, after construction of the High Aswan Dam, fertility of the soil rapidly decreased.

6.2.5 Hypolimnetic anoxia and gas release

Because this is a consequence of several of the previously discussed problems, we treat it here as a separate entity. These can also result from other sources. For instance, it was recently shown that accumulation of methane gas in Amazonian reservoirs is due to the degradation of drowned forests. This is accompanied by accumulation of H_2S in the hypolimnion. Consequently, decreased pH in the reservoir, accompanied by low pH downstream, causes increased corrosion of turbines and loss of fisheries. Rising manganese and iron concentrations cause increased costs of treating water for consumption. In eutrophic waters, nutrient releases from the sediments enhance pelagic productivity.

6.2.6 Acidification

Acidification is defined as a decrease in pH. This is often due to a mass transfer of atmospheric gases that create acid rain. The main source of these atmospheric gases is industry, but other sources such as automobile exhaust significantly contribute to this buildup. In specific instances, acid drainage from coal mines can lower pH up to 2.7. Associated to acidification are changes in leaching of heavy metals (particularly the toxic form of aluminum) from soil into ground- and surface- waters. Consequences of acidification of reservoirs are specified in Fig. 6.8. These may lead to endangerment of water supplies. In regions originally characterized by high pH levels biodiversity (not necessarily biomass) of algae, zooplankton and benthos decreases. Sensitive fish species are eradicated, until only the hardiest (*Salvelinus americanus*) remain. In Atlantic salmon (*Salmo salar*), no fry survive where pH is below 4.7 (Lacroix 1989), and no temperate fish are able to live in regions where the pH is below 4.5.

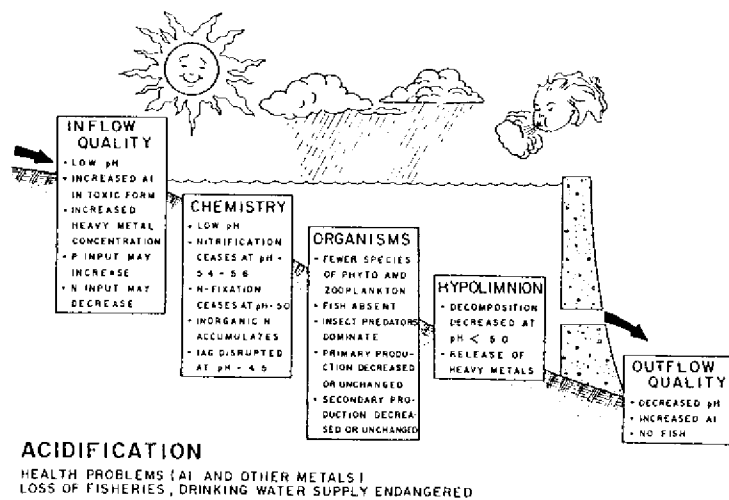

Fig. 6.8 Schematic representation of major consequences of acidification in a reservoir. Below economic impacts are listed

6.2.7 Salinization

Two major sources of increasing salt concentrations can be distinguished:

- i) excessive fertilizer application on land and salting of roads, and
- ii) soil irrigation in arid and semi-arid regions.

Fertilizers contain many ingredients besides phosphorus and nitrogen compounds. Thus, a steady rise of salinity is observed along with the increase of nitrogen in waters. In arid and semiarid countries, heavy irrigation schemes result in accumulation of salts in groundwater and, eventually in streams and reservoirs. When water levels drop drastically during dry seasons and water becomes concentrated, dramatic salinization effects are observed. The capacity to supply water is lost and changes in the composition of reservoir biota occur. In northeast Brazil, annual evaporation of approximately 2000 mm exceeds the average maximum precipitation of 1200 mm. Therefore, rapid increase in salinity occurs within reservoirs and results in undesirable consequences on multiple uses. A series of impacts on the human health of rural and urban populations that use reservoir water has been observed. One consequence of large scale salinization is the increase in blood pressure rates and consequential renal disease.

6.2.8 Bacterial and viral contamination

These are largely the consequences of sewage, application of manure to fields and, in some instances, contamination from animals as discussed in the following section. The most dangerous source of this type of contamination is effluents from hospitals.

6.2.9 Health effects and waterborne diseases

With the creation of large reservoirs in Africa and other tropical countries, enormous increases in the spread of waterborne diseases that infect humans and domesticated animals occurred. For instance, in the Volta Dam region, schistosomiasis infestation increased from a 3% level before

reservoir construction to 70% afterwards. The transmitting agents of waterborne diseases include several kinds of aquatic worms, mollusks and crustaceans. The most dangerous and widespread waterborne diseases include the following: parasitic protozoans - *Plasmodia*, *Giardia*, *Entamoeba*, *Cryptosporium*, *Naegleria*; and parasitic worms - *Schistosoma* (blood flukes), *Taenia saginata* (beef tapeworm), *Ascaris lumbricoides* (large intestinal roundworm). Waterborne diseases are not restricted to tropics; some reservoirs in U.S.A. harbored *Giardia* and 23,000 people were infected during 84 separate outbreaks. These pathogens are carried by wildlife (beavers, coyotes, muskrats, voles) and cattle. Malaria infestation increased from 16% to 25% after the construction of the Srinagarind Dam in India.

6.2.10 Heavy metal pollution

Most heavy metals that reach water bodies are deposited in sediments. Concentrations in sediments can be as high as six orders of magnitude greater than water. Higher concentrations of heavy metals are found in small-grained sediments. However, the generally accepted assumption that accumulation is negligible in sediments with material < 63 μm does not seem generally valid, as Horovitz (1996) found in selected rivers in U.S.A. A careful summary of this situation in England, a heavily industrialized country, was completed by Foster *et al.* (1996) and demonstrated that the most severe sources of heavy metal pollution are those of urban runoff and industrial pollution. In lowland rivers, increased concentrations are not transported far from the source, thus detection of the source is much easier. Urban lakes appear to obtain greater atmospheric deposition than their rural counterparts by at least one order of magnitude. Foster *et al.* also demonstrated that wetlands function as a valuable site for diminishing heavy metal concentrations. Heavy metals (and other toxics) can also be significant in atmospheric pollution as the accumulation of plumbum in the tissues of some Antarctic birds demonstrates.

Increased concentration of heavy metals, particularly aluminum, are associated with alterations of pH conditions in soil and are correlated with acidification. Reservoirs function as traps for heavy metals, and, in some instances, up to 90% of metals that enter via inflow and air can be trapped in reservoir sediments.

In the Bitterfelder Muldestausee Reservoir and in the heavily industrialized and contaminated Leipzig area, Eastern Germany, the following elevated concentrations of heavy metals were found: arsenic that originated from treatment of uranium ores; thorium that partly originated from natural volcanic origins, but increased due to mining; bismuth that was a secondary product of coal mining; wolfram in regions with iron ore treatment; antimon from industrial origins; zinc, due to complex contamination; molybdenum that was mainly a product of ash distribution by the petrochemical industry; and, uranium that originated from uranium mines. Most of these metals were bound to particulate matter, and accumulated at high levels in sediments of the reservoirs. In one rapidly-flushed weir located in this region, 1,500,000 kg of zinc, 200,000 kg of chromium and 8,000 kg of cadmium had accumulated.

Increased concentrations of mercury have occurred in some pristine areas after elution from soil in newly filled reservoirs. Mercury principally concentrates in reservoir fish. An example of this is the Indian River project in Subarctic Canada. Amazonian reservoirs have experienced increased mercury levels due to its use in gold mining operations.

6.2.11 Agro-chemicals and other toxic chemicals

Increased water toxicity results from runoff from mining operations, industrial waste discharge, agricultural practices and improper disposal of solid wastes. Pesticides and herbicides, along with heavy metals, are the main toxic substances that enter aquatic systems and accumulate in the sediments and eventually reach the food chain. Effects on human health range from common enteric diseases to deadly levels of toxins that may be passed on in mother's milk. Organisms bio-accumulate toxins, most often in their livers or body fats. Thus, toxins represent a time bomb; their effect is not realized for long periods of time, but once a certain limit is exceeded catastrophic consequences appear, which, moreover, have an effect which is transferred to newborn generations. Reservoirs act in the same delayed manner; they trap toxins but retain the possibility of release during altered chemical (pH, redox, anoxia) conditions.

Toxic chemical compounds may also be of natural origin, and may appear irregularly or unexpectedly. These cases usually occur in volcanic regions, as dissolved salts or gases are released. Such an event had drastic consequences in Lake Nyos of Cameroon, when, in 1986, 1,700 people and more than 3,000 cattle died. This was caused by accumulation and subsequent escape of dissolved gaseous carbon dioxide from the lake.

CHAPTER 7

THEORY OF ECOTECHNOLOGICAL MANAGEMENT

7.1 ECOSYSTEM THEORY APPLIED TO RESERVOIRS

In Chapter 4 we demonstrated that a reservoir can be treated as a managed ecosystem. Thus it is useful to review the basic principles, which govern ecosystems functions. These principles along with short descriptions are provided in Tab. 7.1.

Tab. 7.1 Basic principles that govern ecosystems (Following Straškraba 1993).

- * **ECOSYSTEMS CONSERVE ENERGY AND MATTER.** Neither energy or matter is created or destroyed, however, one form can be converted to another.
 - * **ECOSYSTEMS STORE INFORMATION.** In nature, information is stored in physical, chemical and biological structures. In organisms, this information is coded in gene pools.
 - * **ECOSYSTEMS ARE DISSIPATIVE.** Dissipation means that continuous degradation of energy and matter takes place from more to less organized forms. Dissipation provides the force needed to maintain order and structures. An example of dissipation is the formation of detritus from dead organisms.
 - * **ECOSYSTEMS ARE OPEN SYSTEMS.** They are open to energy, matter and information. Ecosystem functioning depends not only on continuous inputs of energy, but also on input of matter from the earth's crust. Therefore, ecosystems are vulnerable to external inputs.
 - * **ECOSYSTEMS GROW.** Growth is the process in which new structures are created from less structured materials. Biological growth is a strictly regulated process and is driven by laws of genetics.
 - * **ECOSYSTEMS ARE CONSTRAINED.** They are externally constrained by the physical environment, e.g. solar energy available for plant growth, temperature of the surroundings, and others. The individual organism cannot grow for infinity, and organism population densities are constrained.
 - * **ECOSYSTEMS ARE DIFFERENTIATED.** The differentiation of an ecosystem is in accordance with the mode of feeding (trophic net) and social status of the individual within a group. This type of organization is typically classified as hierarchic.
 - * **ECOSYSTEMS ARE MULTIPLE FEEDBACK SYSTEMS.** This means that some feedback effects exist between neighboring elements and some are mediated through other elements. Indirect, mediated effects predominate over direct effects. Due to the complexity of interrelations and indirect effects, ecosystems may behave in ways that are not yet understood.
 - * **ECOSYSTEMS ARE CAPABLE OF HOMEOSTASIS.** This is maintenance of a healthy steady state over a wide range of conditions. However, there are limits beyond which an ecosystem cannot assimilate change. Once an ecosystem is forced beyond these limits, homeostasis breaks down and major damage may occur.
 - * **ECOSYSTEMS HAVE CAPACITY TO ADAPT AND SELF-ORGANIZE.** Adaptation to changing external conditions can be very rapid, both for individual organisms, and for populations and associations. The self-organization capability means that restructuring of species composition can occur when external or internal conditions are changing. The transfer of information within the ecosystems, its control is diffuse.
 - * **ECOSYSTEMS ARE COHERENT.** Long term simultaneous development of different species in their mutual interactions and inter-actions with the abiotic environment produces a coherent system, with species that are adapted to their environment.
-

Ecosystem theory offers a number of pointers for the proper management of reservoirs and their watersheds (Tab. 7.2). In particular, ecological theory helps to solve water quality problems

with natural biological controls rather than using more environmentally damaging chemical controls. Therefore, ecosystem theory principles are applied to reservoir water quality management in order to attain optimization of practical actions.

Tab. 7.2 Principles of theoretical ecology as applied to management of reservoirs and their respective watersheds

PRINCIPLE	EXAMPLES OF USAGE
BOTTOM-UP EFFECTS	* Chemical determination of biological production * Fish yield determination by natural food production
TOP-DOWN EFFECTS	* Biomaniplulation
LIMITING FACTORS CONCEPT	* Eutrophication abatement * Upper limits of production
SUB-SYSTEM INTERACTIONS	* Terrestrial/aquatic interactions * Watershed/reservoir interactions
POSITIVE FEEDBACK	* Exponential (sigmoidal) reactions
NEGATIVE FEEDBACK	* Nutrient concentration depends on utilization by phytoplankton
INDIRECT EFFECTS	* Water temperature affected by phytoplankton development
CONNECTIVITY	* Upstream - downstream effects
ECOSYSTEM ADAPTABILITY	* Chemical pest management inactive after organisms adaptation
ECOSYSTEM SELF-ORGANIZATION	* Unforeseen reactions of reservoir ecosystems
ECOSYSTEM SPATIAL HETEROGENEITY	* Conservation and management of riparian forests * Protection of headwaters * Protection of shoreline
ECOLOGICAL SUCCESSION	* Reservoir aging and evolution
BIOLOGICAL DIVERSITY	* Reforestation by a variety of native species as means to retain diversity * Wetland maintenance (high diversity areas) * Preservation of ecotones
COMPETITION	* Stop introductions of exotic species without proper knowledge and consideration of effects
PULSE EFFECTS THEORY	* Maintenance of forests and wetlands in the watershed minimize negative pulse effects * Regulation of algal blooms
THEORY OF COLONIZATION	* Few pelagic or lacustrine fish species in reservoirs

In the following section, explanations of the theoretical principles in Tab. 7.2 and ways that they are applied to reservoir management are provided.

Bottom up effects. In nature we recognize the trophic chain, which leads from the physical and chemical environment to plants (in water, these are mainly phytoplankton), animals that eat plants (grazers, in water these are often filter feeders), predators that eat grazers (like most fishes) and finally to top food-chain predators (like fish that eat smaller fishes) and humans who eat predatory fishes (see Fig. 4.18). Development of biological communities is determined from the bottom part of this chain. Plant (phytoplankton) growth in the reservoir is determined by nutrients that enter the reservoir via inflows, or air. Therefore, if the amount of plants reaches undesirable

quantities, they can be reduced by alternation of the nutrient load using methods outlined in Chapter 10.

Fish communities are controlled by the amount of available oxygen; if oxygen concentration is too low, fish cannot survive. Thus, the fish yield of the reservoir can be improved by increasing oxygen concentration using different mixing techniques discussed in Chapter 11.1.

Top down effects. Simultaneously with bottom up effects, a top-down, or effect from above, takes place (see Fig. 4.18). Higher members in the trophic chain effect those below them. These effects are realized in both quantitative and qualitative ways. The quantitative effect is manifested, e.g., by grazing of phytoplankton by zooplankton, or by the decrease of non-predatory fish by predators. The amount of phytoplankton is continuously decreased by zooplankton. The qualitative effect consists of changes of species composition (not just quantity) at lower trophic levels. In the first above example, zooplankton not only decrease the amount of phytoplankton, but also change the zooplankton species composition. Because they feed selectively on larger phytoplankton, these may be eliminated, and smaller species may prevail. Predatory fish prey selectively on certain species of prey. Fish species that are not eaten increase in the reservoir. Qualitative effects are sometimes greater than quantitative effects. Management applications of the top-down effect are discussed in Chapter 11.3.

Limiting factor concept. Plants are limited by the amount of nutrients, but need only certain amounts of each nutrient, thus, the nutrient that is in shortest supply as related to a plant's requirement is the limiting factor. In management, reduction of the limiting factor alone (in waters this is usually phosphorus, but is sometimes nitrogen, silica, or others) can cause changes in plant composition. Plants are able to grow up to a certain maximum rate and reach only maximum biomass. A large amount of excess nutrients will not enable plants to exceed this maximum. For the manager, this means that a reduction of nutrients, if it is down to a level that is still higher than the maximum needs of plants, will not lead to plant reduction. Reductions must fall below the upper limit of each plant's needs in order to effect a reduction in biomass (Chapter 9).

Sub-system interactions. Every system consists of sub-systems. The management system of a reservoir might be divided into the watershed subsystem, the reservoir inflow, the reservoir, the reservoir outflow, and the management subsystem. Among such subsystems, strong interactions take place. The terrestrial system that immediately surrounds the reservoir, effects water quantity because water is utilized for growth of terrestrial vegetation and the amount that reaches the reservoir can be reduced, by tree leaves falling into water and decaying there. The strong effect of the watershed on the reservoir is well known, however, here we are emphasizing *inter-relations*; the reservoir and the watershed affect each other. The microclimate around the reservoirs is different, the human population on the shores usually increases.

Negative feedback. The description under the heading "Top-down Effects" is an example of a negative feedback. Feedback occurs when one component of a system influences a second one, and the second one simultaneously effects the first one. If the effect of the second one on the first is negative, we call this negative feedback. Nutrient concentration (component one) supports

phytoplankton and is simultaneously decreased (negatively effected) during utilization by phytoplankton (component two).

Positive feedback. If the effect of component two has a positive effect on component one, we call this positive feedback. For example, reservoir construction has a positive effect on regional development in some countries.

Indirect effects. Increased water temperature encourages phytoplankton development. However, recent studies show that dense phytoplankton populations indirectly cause increased water temperature, due to more intensive adsorption of solar radiation. The amount of detritus that originates from a large phytoplankton bloom produces large scale indirect effects in the reservoir.

Connectivity. There is a connection between elements of systems. The watershed is connected with the reservoir and the reservoir is connected with the outflow river. The river above the reservoir could change because the reservoir is constructed - e.g., some fishes that reproduce in the reservoir can migrate upstream and change the invertebrate fauna of the reservoir inflow. Evidently, the reservoir markedly affects its outflow.

Ecosystem adaptability. Chemical pest management becomes inactive after organisms become adapted to the chemicals that are used to combat them.

Ecosystem self-organization. The structure (internal physical structure, stratification, biological assemblages, chemical compounds present and interactions) of a reservoir is not constant but is changing in response to various pressures in the environment. Management must respect this ability. For instance, selective intake of water from a given stratum reorganizes stratification. A management strategy that is directed toward selectively destroying certain species will result in domination by other organisms. The reservoir ecosystem often reacts in an unforeseen way.

Ecosystem spatial heterogeneity. Ecosystem theory teaches about the values of heterogeneity. In terms of water quality, vegetated natural shorelines are more valuable than paved shores. They possess higher biological buffering capacities during high scouring of shores in wind-exposed sites. Protection of shorelines by planted vegetation combined with protective wire nets is a near-natural ecotechnology (Chapter 11). Riparian forests serve to protect inflows against pollution and function as 'biological filters' that remove phosphorus, nitrogen and other pollutants from the inflows, retain suspended materials, and decrease sedimentation.

Ecological succession. Ecology has shown that ecosystems evolve, and, during that evolution, a succession of vegetation and animals occurs and changes the appearance and function of the ecosystem. Lakes evolve naturally during very long time intervals that can last hundreds of thousands of years. A reservoir evolves at a much faster rate, and major changes take place during the first few years. This process called reservoir aging (or trophic upsurge) is described in greater detail in Chapter 4.7. The years that follow this period of poor water quality are followed by slow evolution characterized by continuing filling of the reservoir by sediments and other effects.

Biological diversity. Biological diversity within the reservoir is important in maintaining the self-purification function of the reservoir, and for support of fishery resources. In the watershed, the importance of biodiversity is much broader, and includes the function of retention of pollutants in vegetated areas. Reforestation with native species as means of retaining watershed diversity has very positive effects, both in terms of water quantity and quality. Wetland areas near the reservoir and within the watershed form significant buffer zones in the land/water ecotone and behave as a native aquatic species reserve. Wetlands can serve as epicenters for re-colonization of reservoir biota after large floods, toxic spills and other catastrophic events.

Competition among organisms. Complex relationships exist in nature and these have extensive consequences for the whole system. Introductions are successful only if they are analyzed in terms of competition between organisms, adaptability and ecosystem self-organization capabilities. For instance, introductions of the fish species *Scirpion squamosissimus* (corvina) into reservoirs in the Southern Brazil was very successful because this species inhabits the pelagic region, in difference to local species. Fantastic growth of this species in recent years resulted in fisheries revival in Barra Bonita Reservoir, where it was introduced.

Pulse effects theory. This theory asserts that destructive reactions to high pulses sometimes occur in ecosystems. Maintenance of forests and wetlands in the watershed serve to delay or suppress negative pulse effects. Pulses are sometimes positive, such as those used during the management technique of intermittent mixing (Chapter 11).

Theory of colonization. Colonization of lakes originated from rivers, which are much more ancient ecosystems. Therefore, very few truly pelagic (lacustrine) fish species exist in reservoirs. The introduction of pelagic species produced profit in many large reservoirs. Investigations of local waterbodies prior to reservoir construction with the hope of determining the eventual plankton composition of the reservoir is futile, because algae and invertebrates are transported long distances by birds. Conditions that develop within the reservoir are decisive.

7.2 PRINCIPLES OF ECOTECHNOLOGICAL MANAGEMENT

General ecotechnological rules were derived by Straškraba (1993) and Tundisi & Straškraba (1995) from theoretical principles of ecosystems, which were recognized earlier by Jørgensen *et al.* (1992). These general rules are translated below into more detailed operational principles for management of reservoir water quality.

Because the positive consequences of managing the reservoir by treating it as an ecosystem were discussed in the preceeding section, we will now concentrate on **negative** consequences that result when these principles are **not respected**.

Manage the reservoir as a component of the watershed system. Any change in the watershed may have considerable effects on the reservoirs. Negative effects commonly result from certain agricultural practices. The effects of watershed activities on the reservoir are related to both water quality and quantity. Decreased flow due to mass irrigation has changed a very large lake, the

Aral Sea in the former USSR, to a dust bowl with fishery trawlers rusting in the sand. Health problems of populations in villages and towns around the lake are far greater than those of the average Russian. Integrated river basin management provides further background on this topic (Chapter 2).

Manage reservoir ecosystems as interconnected sets of subsystems. Human society is a very important subsystem and insufficient collaboration with local population during formation of management decisions highly reduces the probability of their successful realization. Any management option directed at one component of the ecosystem, e.g., phytoplankton, has to take the other components into consideration. Mass destruction of algae can lead to fish kills resulting from a corresponding drop in oxygen levels. Consequently zooplankton, which controls phytoplankton growth, may change composition in subsequent periods, with a positive effect on phytoplankton development (Chapter 11).

Considerable feedback between the reservoir and the watershed is apparent during reservoir construction. Complete social changes take place within the whole territory.

Evaluate global environmental effects of management options. The use of brute-force technology, e.g., heavy machinery and tons of chemicals for environmental management, have negative consequences for the global environment. The environmental cost of energy production needed to run this machinery and the necessary construction of access roads is high. More important in terms of environmental deterioration are the costs of mining for metals and chemicals, treating these raw materials and finally, construction of the machinery. This usually occurs at different areas of the world and is, therefore, not obvious to the local user. However, local improvements are meaningless if they result in global degradation.

Evaluate long-term effects of options. Using only curative (end of pipe) water quality management practices increases treatment costs enormously. Management options that have positive short-term effects often lead to long-term negative effects. A typical example of this is the use of copper compounds to decrease algal blooms. This method acts almost instantaneously to reduce algal crops, however, if repeated several times, accumulation of copper in the sediments and subsequent release to the water column degrades water usage for man and animals and the reservoir is no longer suitable for a drinking water supply.

Emphasize management based on prevention of pollution. The economic success of the "clean production" demonstrates that preventing pollution saves not only costs for water treatment, but increases factory profit simultaneously.

Save good water quality. As mentioned above the cost of treating polluted waters is often far greater than the cost of treating clean sources. This difference affects the public sector, which is usually responsible for water distribution. Thus, conservation and protection of headwaters is more cost-effective in the long run.

Evaluate a broad spectrum of management options. Very often local tradition dictates that only a limited number of potential management options are considered for a particular problem.

Neglect of other classical and innovative options leads to improper use of techniques, much higher costs than necessary and potential harm to the global environment (Chapters 10 and 11).

Respect development sustainability. One question that should be asked regarding the water quality management of a reservoir is how long the present mode and degree of use can be guaranteed? The likelihood that a reservoir will fill with sediment in a short time is an obvious problem, and illustrates the need to consider sediment load prevention measures. An example of a less obvious potential issue is the ever-increasing demand for water; we must think not only about the immediate satisfaction of society demands, but must take measures to ensure water availability in the future (Chapter 2).

Consider reservoir sensitivity to inputs. Reservoir construction must account for input of solar radiation, which represents the force of evaporation, as well as inputs of water. This basic principle was neglected during construction of Aswan Reservoir at the exact geographical latitude of maximal negative water budget, and evaporation that greatly exceeded precipitation led to disasters in downstream agriculture and fisheries as far as the shores of the Mediterranean. If all major point sources of pollution are not treated, safe use of drinking water cannot be guaranteed. The same is true if the input of sediments, dissolved nutrient salts and toxic chemicals of any from non-point sources is not minimized. Corresponding management methods that include the use of pre-impoundments are provided in Chapter 10.

Emphasize management options based on mutual interactions between biotic components and their interrelations with abiotic ones. Ecotechnology strives to make use of those options that best use nature's capabilities. Procedures such as wetland recovery, biomanipulation or epilimnetic mixing are not only very inexpensive, but also do not entail additional environmental deterioration associated with the use of large amounts of energy and chemicals, transportation of goods and machinery, and support materials. However, a high level of knowledge is necessary for successful use of ecotechnology.

Consider reservoir ecosystem dynamics. The importance of reservoir dynamics in the ecosystem was previously discussed. If respect to these dynamics is lacking, changes intended to improve water quality may erroneously lead to deterioration. Management costs increase, if they are not based on prediction of water quality dynamics which enables early actions that can prevent water quality difficulties.

Confront conflicting uses. Dynamic interactions exist in both the natural domain and the social sphere. One use of water can preclude or restrict other uses. This fact must be taken into account during the planning stage and sound and environmentally safe compromises must be forged between different incentives. Economic evaluation of management options with respect to different uses is necessary.

Retain natural structures such as shores, forests, wetlands, individuals and groups of trees, and landscape heterogeneities. Steps must be taken to protect and improve spatial heterogeneity by ensuring the existence of riparian forests, wetlands and natural vegetation mosaic. Loss of river meanders, wetlands and riparian forests lead to deterioration of water quality in inflow rivers

and, consequently, in the reservoir. A recent estimate of Chinese lakes in one region showed that their number had decreased from 1066 in 1950 to just 326 recently, resulting in a 600 km² decrease of lake area. Data on reservoirs in China show that if practices do not change, they will be eliminated due to sedimentation. In Sweden, rivers that were channelized and paved are presently being returned to natural shapes and with vegetation and wetlands at high costs, because negative effects were found to exceed the costs of previous management practices. Costs associated with flooding are ever increasing (see Fig. 6.4), due to continuing landscape mismanagement.

Retain biodiversity. The destruction, lack of protection and insufficient recovery of natural wetlands does more than impoverish local flora and fauna. Nitrogen problems rise as the denitrification function of wetlands is lost. Of particular importance, destruction of wetlands results in decreased water retention and water quality deterioration in the territory.

Colonization of introduced species is a dangerous endeavor, because the intricate relationships of native fauna and flora are not known a priori. When organisms are introduced into new environments, they may behave quite differently than they did in their native habitats. Introduction of foreign species that possess positive qualities in their native regions often result in disasters in other regions because the competition with local organisms in the new environment is completely different. Thus, introductions of exotic species without thorough knowledge should be stopped. The neglecting of cultivation of local species due to the facility to deal with introduced species whose biology and cultivation is sufficiently known has negative consequences. A good example of this tendency is evident in South America. Instead of cultivating local, useful species, *Tilapia* spp. were favored because of their ease of cultivation. This resulted in a setback in research on local species, their biology, reproduction, etc. Only now are these studies undertaken with the aim of cultivation of local, native fish.

Along with introduced fish species, a host of aquatic plants and animals are also introduced and these can harm the environment and, in some cases, human health. For example, along with the introduction of *Tilapia* spp. to Brazil, a number of non-native invertebrates were also introduced. The introduction of a South American species, *Cichla ocellaris* (tucunaré in local terminology), from Northern Brazil into southern reservoirs was unsuccessful. This predator species caused complete disruption of the natural food chain. Introduction of the same species to Lake Gatun in Panama also had harmful consequences in the food chain.

Determine assimilation capacity for various pollutants and do not exceed it. Ecosystems, including water-bodies, are capable of assimilating specific amounts of various pollutants. After exceeding this capacity, considerable increases in respective concentrations occur and can cause eventual breakdown of the ecosystems structure. Moreover, the capacity for various pollutants is enormously different, and also depends upon the physical nature and chemistry of the environment, as well as the ecosystem composition. Figure 7.1 shows that no significant degradation of water quality is evident in water bodies until a certain threshold is reached, but then rapid rise in certain undesirable water quality parameters occurs.

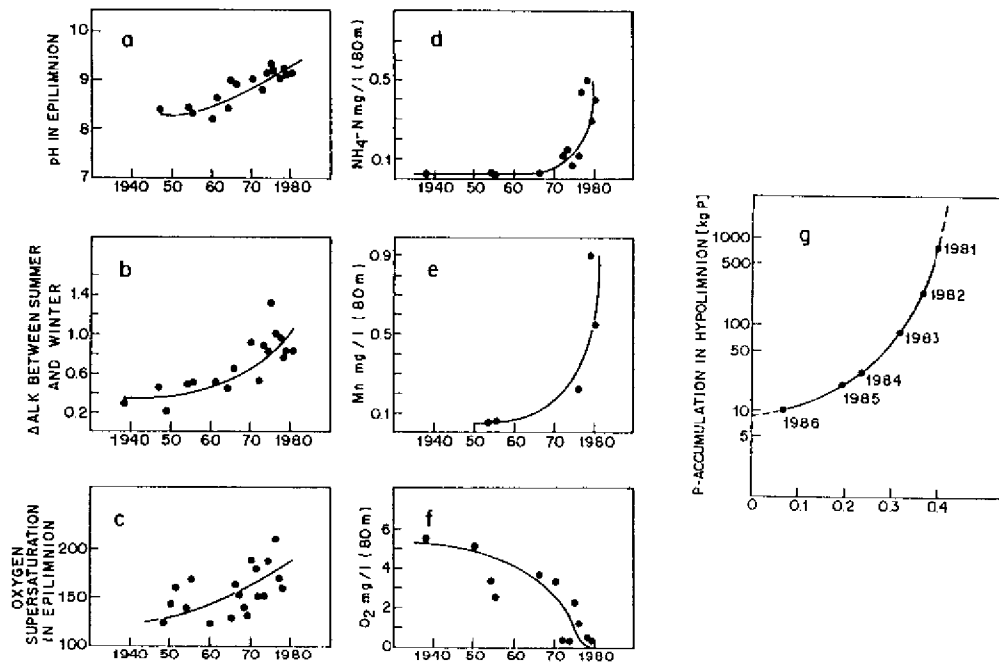

Fig. 7.1 Time changes of several water quality variables in a water body. Note the slow changes at the beginning of observations and rapid exponential increase afterwards. Lake Sempachersee, Switzerland. Modified from Gächter *et al.* (1983).

Tyson (1995), an upper-level watershed manager, recognized the following management rules:

- * develop methodologies of integrated river basin management which include land-use management and water planning;
- * improve the volume and accuracy of national and global assessments of water resources;
- * develop, promulgate and implement new, innovative approaches to water supply and sewage treatment;
- * develop, promulgate and implement waste minimization and recovery techniques;
- * develop low-tech, low-cost treatment options;
- * increase the application of use-related waste receiving standards;
- * develop and apply economic evaluation tools to both environmental costs and benefits; and
- * inform, educate, and train both professionals and the public.

CHAPTER 8

RESERVOIR WATER QUALITY AND HOW IT IS DETERMINED

8.1 APPLICATION OF RESERVOIR LIMNOLOGY AND ECOTECHNOLOGY TO WATER QUALITY MANAGEMENT

Knowledge of basic limnological features that are found in reservoirs and functioning mechanisms within the ecosystem is an important management tool, especially for use in formulating ecotechnological actions. Management of reservoirs that supply drinking water require detailed information because stringent water quality standards must be met. A list of norms according to WHO is given in Tab. 8.1.

Tab. 8.1 List of variables relevant for assessment of drinking water supply.

Color (FCU)	Ammonia	Cyanide
Odor	Nitrate/nitrite	Heavy metals
Suspended solids	Phosphorus/phosphate	Aluminum
Total dissolved solids (TDS)	Total organic carbon	Arsenic & selenium
Turbidity (NTU)	BOD	Oil and hydrocarbons
Conductivity	Sodium	Organic solvents
pH	Magnesium	Phenols
Dissolved oxygen (DO)	Chloride	Pesticides
Hardness (as CaCO ₃)	Sulphate	Surfactants
Chlorophyll-a (CHA)	Fluoride	Fecal coliforms
Total coliforms	Pathogens	

For every reservoir, we need an understanding of the hypsographic curves that relate water volumes and surface areas to water levels. We also need to know the outlet elevations and their size. Usually, information about the watershed is collected during pre-investigations.

The following basic groups of limnological reservoir characteristics must be considered:

a) **Flow rates** of major inflows. We consider major inflows those that collectively represent 90% or more of the total inflow. Flow rates are important in estimating the load of particular substances in the reservoir and in predicting the flow patterns through the reservoir. Higher flows may disproportionately increase the load due to flushing of substances from soil and increased erosion (Chapter 10). During high flows, the riverine zone of the reservoir relocates and short-cut currents can be produced (Chapter 4). Outflow rates and the location of inflows at any particular time must be known.

b) **Water level fluctuations** in the reservoir. When water levels rise, the water from the main reservoir body enters the bays, whereas during decreasing levels, material in the shores and bays is removed. Water level fluctuations enhance sediment-water interactions and increase the amount of suspended solids and dissolved nutrient concentrations.

c) **Retention time**. The theoretical retention time of water in the reservoir, R , determines a

number of reservoir features including the following: loading decreases with increasing R; reservoir stratification increases with increasing R, retention of nutrients increases with increasing R, phytoplankton is flushed from the reservoir when R is low and amounts of sediments and bottom fauna are higher at lower R. Reservoirs that have retention times below about 300 days have less developed stratification, obtain higher nutrient loads and retain much less phosphorus (Chapter 4). Reservoirs with long retention times have a greater tendency to become eutrophic and the frequency of cyanobacteria blooms is higher. Hypolimnetic anoxia occurs at lower levels of pollution in reservoirs that have long retention times and eutrophication occurs more often than in throughflowing reservoirs.

d) **Outlet location.** Stratification in the reservoir and consequent changes in chemistry and biology, the quality of outflow, sedimentation within the reservoir, and the potential retention of different pollutants by the reservoir are all affected by the placement of outlet structures.

e) **Vertical and horizontal circulation.** If the vertical stratification results in a hypolimnetic anoxic zone, one or more of the following harmful effects may result: increased release of nutrients from the sediments can result in eutrophication; increased concentrations of manganese and iron as well as unpleasant tastes and smells that can decrease drinking water quality and increase treatment costs; fisheries and fish growth in the reservoir can be degraded by elimination of valued species; abolition of gases can produce unpleasant smells; and; increased corrosion can decrease the life span of turbines and degrade concrete. Also, depending on the spill water discharge system, the downstream river may be seriously affected and mass fish mortality may result. The turbulence of a reservoir affects photosynthesis of phytoplankton in several ways, and can either enhance or depress photosynthetic efficiency. Horizontal circulation also affects the horizontal distribution of organisms, producing in some cases aggregation of phytoplankton (cyanobacteria) or floating macrophytes. Vertical circulation may affect also the light transmission and correspondingly the phytoplankton, periphytic and macrophyte productivity.

f) **Chemical composition of the water.** Reservoir water quality responds to the hydrochemistry of the region, reservoir retention time, and input resulting from human activities in the watershed. The chemical composition of the water affects aquatic life within the reservoir. Nutrient inputs can increase the biomass of some phytoplankton species and simultaneously decrease diversity. High salinity and low pH interfere with the overall integrity of the food chain. Therefore, management of the chemical composition of the water is an important consideration.

g) **Biological characteristics of the reservoir.** The flora and fauna of a reservoir are combining the result of recruitment from the watershed and life conditions within the reservoir. Colonization of the reservoir by organisms from remote localities including other watersheds is possible by several mechanisms such as transportation by birds, wind, rain, and invertebrates may be transported by large vertebrates.

Management of aquatic biota is of fundamental importance in reservoir management. Interactions and successions of organisms must be taken into account. Management of different reservoir zones introduces several possibilities that enable control of plankton growth, macrophytes and fish, and development of alternative aquaculture. Biomanipulation of reservoirs is a powerful management tool. Table 8.2 relates the use of limnological characteristics found in reservoirs to ecotechnological management options.

Tab. 8.2 The relationship of limnological characteristics to management options.

LIMNOLOGICAL CHARACTERISTICS	MANAGEMENT ACTIONS
Vertical and horizontal water circulation	Produce vertical water movements to reduce euphotic zone. Induce more intensive horizontal circulation to avoid aggregation of organisms and suspended material.
Retention time	Regulate retention time to meet required water quality needs upstream/downstream and achieve multiple uses.
Chemical composition of water	Regulate and control reservoir inputs. Regulate retention time. Preserve gallery forests and wetlands.
Biological characteristics	Regulate the reservoir biomass. Introduce biomanipulation techniques to control growth of important organisms.

8.2 VARIABLES OF WATER QUALITY AND THEIR INTERRELATIONS

The variables for basic assessment of reservoir water quality can be divided into the following categories:

- (a) flow rate at the time of sampling and information on the regulation of outflow and offtake by waterworks;
- (b) water quality variables indicative of stratification which include temperature, dissolved oxygen, pH, sulfides, hydrogen sulfide, iron and manganese;
- (c) water quality variables that indicate eutrophication, which include phosphorus, nitrogen, transparency, chlorophyll-a (CHA), primary production, and composition of phytoplankton, zooplankton, and fish stock;
- (d) variables that characterize the organic matter content (COD, BOD, color),
- (e) microbiological variables, and
- (f) mineral budget (conductivity, alkalinity, sulfates, chlorides).

Hydrometeorological measurements can also be valuable in evaluating water quality. In the following discussion, more detail is provided regarding the importance of the variables belonging to the above groups.

Measurement of **temperatures** at different depths provides an indication of mixing, stratification and flow patterns within the reservoir. In Chapter 4.8 basic stratification types were discussed.

Transparency is primarily determined by the combined effects of water color (due to dissolved substances), mineral turbidity, and the presence of algae. Pronounced seasonal variation is characteristic of phytoplankton. In temperate regions, turbidity due to flooding usually disappears shortly after the event, whereas in semiarid and arid regions, the fine structure of suspended solids prevents rapid sedimentation and consequently affects nutrient availability to phytoplankton, decreases light penetration and phytoplankton photosynthesis, interferes with zooplankton filtration and affects prey visibility.

Nutrients. Only **nitrogen** and **phosphorus** are considered, because they are the major factors that limit primary production of phytoplankton in reservoirs, however, silica is also important for the development of diatoms. In industrial countries, the likelihood of microelements limitation is low because microelement levels are often increased by human activity. A conspicuous decrease of nitrogen and/or phosphorus concentration in the upper layers of reservoirs during the phytoplankton growth indicates intensive utilization, and may eventually limit phytoplankton biomass. Very low concentrations, often only a few $\mu\text{g.l}^{-1}$, result during balanced consumption and supply, and are regulated by the processes taking place in the reservoir, which include excretion of ammonia and phosphates by zooplankton and fish, transport of nutrients from the hypolimnion, and many others.

Ammonia enters streams from sewage treatment plants, large-scale breeding farms and industry such as gasworks, food industry and viscose rayon manufacturers. Ammonia is effectively retained in soil and water. It is preferred to other nitrogen compounds by phytoplankton. Concentration of ammonia in the surface layer of reservoirs is highest in late winter and early spring and may reach up to $500 \mu\text{g.l}^{-1} \text{NH}_4$. An average annual concentration that exceeds $150 \mu\text{g.l}^{-1}$ in the surface layer indicates a high supply from the watershed or, more often, decomposition of nitrogenous organic compounds (autochthonous as well as allochthonous) and the release of ammonia in the reservoir. Ammonia concentrations higher than $250 \mu\text{g.l}^{-1}$ are chronically toxic to fish and invertebrates at a $\text{pH} \geq 9$.

Nitrates are extremely detrimental to human health. Toxic nitrites result from nitrate reduction. In the presence of organic nitrogenous compounds, nitrites can become precursors of carcinogenic nitrosamines. Nitrates are produced in soil by nitrification of ammonia and, mediately, organic nitrogen as well. Nitrates easily leach from soils, especially during heavy rains and thaws when soil cohesion has been impaired. Nitrates from precipitation are retained in forested watersheds. If forests are dying or dead because of the impact of emissions or acid rain, nitrates are released rather than retained. Nitrates also are released from forests for several years after timber cutting.

Nitrites are especially toxic to organisms with haemoglobin. Nitrites can arise from nitrate reduction in anoxic environments, e.g., groundwater, reservoir hypolimnia, human intestines with unstabilized bacterial flora (e.g., in intestines of babies), or as an intermediate product of nitrification.

Phosphorus is the element that most frequently limits primary production. In unlimited populations of phytoplankton, the N:P weight ratio in biomass is approximately (10)16(20):1. Phosphorus fertilization applied to barren soil or snow is easily flushed into waterbodies, but vegetated soil efficiently retains phosphorus, as long as the soil particles themselves are not washed away. It follows that soil erosion increases P input into waters. Total phosphorus concentrations in forested drainage and properly cultivated fields usually do not exceed an annual average of $50 \mu\text{g.l}^{-1} \text{P}$. Phosphates in detergents that reach sewerage systems and large-scale breeding farms are the main sources of P in water. Phosphorus concentrations are usually much lower in the downstream ends of reservoirs due to uptake by algae and sedimentation, which is greater in the upstream end. During the growing season, phosphorus can decrease to a few $\mu\text{g.l}^{-1}$, especially in the surface layer. This value represents a balance between the consumption of

phosphorus, particularly by phytoplankton, and supply from various sources. Reservoirs can retain phosphorus efficiently, depending on their retention time. Accumulated phosphorus in reservoir sediments can be released during hypolimnetic anoxia.

The contents of **organic compounds** in reservoirs is evaluated by measuring the chemical consumption of oxygen, using either the permanganate (COD_{Mn}) or dichromate (COD_{Cr}) method. Only a small proportion of measured organic compounds is easily biologically decomposed in surface water. A measure of the amount of biochemical consumption of oxygen in 5 days at 20°C (BOD_5) is used to estimate decomposable organic compounds. The proportion of easily-degraded compounds (BOD_5) in COD_{Cr} usually ranges between 0.10 - 0.15. Values lower than 0.10 are found in waters with a high amount of slowly decomposing organic substances of either natural origin or from human activities. Values over 0.15 indicate the presence of large amounts of algae or recent pollution. When algae are abundant, the BOD_5 value is not only indicative of the amount of dissolved organic compounds, but is also affected by respiration and decomposition of algae.

Water **color** depends in part on organic compounds. Unpolluted surface water is mainly colored by humins and ferrocompounds. Water color in reservoirs is darker in peat bog regions, and is increased by pollution from paper mills. Color usually does not change significantly in the course of a year, except during flood events.

Absence of **oxygen (anoxia)** near the bottom is one of the most serious phenomena that affects reservoir water quality. Under anoxic conditions, some substances, including phosphorus, iron, and manganese are rapidly released from bottom sediments. Sulfides (hydrogen sulfide) can also develop. When the oxygen content of bottom waters decreases to zero, iron and manganese occur in higher concentrations than under oxic conditions. Oxygen concentration is of critical importance to aquatic organisms; fish and other organisms die at very low concentrations. The oxygen content at the reservoir bottom also affects the composition of benthos. Metalimnetic oxygen minima can result in degradation of water quality in middle water layers. Such layers must be avoided when water is diverted to the waterworks. The occurrence of anaerobic zones in the inflow portion of a reservoir usually indicates an oversupply of biologically decomposable organic compounds from the watershed.

In anaerobic waters, **iron and manganese** are released from complexes that do not otherwise easily dissolve. Concentrations can sometimes increase to 200 mg.l⁻¹ Fe and 100 mg.l⁻¹ Mn. These are the approximate limits of normal concentrations. Any further increase can cause difficulties in water treatment processes.

Hydrogen sulfide is easily recognized by its smell. This indication of presence is more sensitive than analytical methods. Hydrogen sulfide is usually in balance with other sulfides that are regulated by pH and concentrations of individual cations. The presence of sulfides indicates anoxic water conditions and signals water treatment difficulties due to the corresponding presence of iron and manganese.

All standard **bacteriological variables** are indicative of allochthonous pollution (from tributaries and banks). They can also be used to trace the location of inflow water mass within the reservoir,

however are of little value in assessing autochthonous bacterial flora resulting from production processes in the reservoir. The following groups are recognized: psychrophilic bacteria, mesophilic bacteria, coliform bacteria, and fecal streptococci.

Higher **psychrophilic bacteria** counts are not necessarily of fecal origin. Decomposing organic matter can make water treatment difficult because undesirable odors are produced. High psychrophilic bacteria counts are found in polluted inflow streams and during high flow rates. These levels are slowly decreased in reservoirs as a result of sedimentation and elimination by zooplankton.

Mesophilic bacteria counts in surface waters are usually by 1-2 orders of magnitude lower than psychrophilic bacterial counts. Mesophilic bacteria originate exclusively from allochthonous sources, and their numbers in reservoirs also diminish as a result of sedimentation and elimination by zooplankton.

Coliform bacteria originate exclusively from fecal origins (from humans and other warm-blooded animals), and enter reservoirs from allochthonous sources. Their numbers decrease in reservoirs as a result of dying, sedimentation, and elimination by zooplankton. These processes are slower during cold seasons (sedimentation is the least affected by temperature), however, also depend on flow, concentration of organic compounds, content of suspended matter (which may reduce the bacterial counts) and other factors. Fecal bacteria counts are always lower in the surface layers of reservoirs than in the inflow waters. In deep, stratified reservoirs with retention times that are one month or more, inflow concentrations decrease by two or more orders of magnitude. Concentrations near the dam are usually so low that measurements are not accurate and, therefore, are not useful. Alternatively, shallow unstratified reservoirs that have short retention times and polluted inflows are characterized by high concentrations of coliform bacteria in some layers near the dam, especially after sediment perturbation (swimming). In shallow reservoirs, the difference of coliform concentrations between the inflow and the reservoir is negligible. In deep, stratified reservoirs, high concentrations of coliform bacteria near the dam are very rare.

Fecal streptococci originate exclusively from fecal origin, do not grow in external environments, and die more rapidly than coliform bacteria, thus, they are good indicators of very fresh pollution. In the inflows, they usually reach numbers that are one order of magnitude lower than coliform bacteria. In the reservoirs, their counts decrease most rapidly towards the dam - they are two orders of magnitude lower than coliform bacteria near the dam. Their other characteristics are identical to those of coliform bacteria.

Phytoplankton is an autotrophic constituent of bioeston. Determination of composition and density of phytoplankton is essential in evaluation of the trophic conditions within reservoirs. Measurements are expressed either as the concentration of chlorophyll-a or as biomass, which is determined by microscopic counting and sizing. The species composition of phytoplankton contains other information valuable (e.g., evaluation of predominant components or saprobic index). Phytoplankton are only able to photosynthesize in the clear euphotic layer. Dead phytoplankton settle to deeper dark layers during sedimentation, and also by circulation during

homothermy. Phytoplankton contribute to the content of organic matter in raw water, and can impair organoleptic qualities of drinking water at high concentrations. Algal blooms sometimes also produce allergens.

Zooplankton can directly affect the composition and quantity of phytoplankton in a reservoir. Zooplankton size and species composition are naturally determined by fish-feeding pressures, a factor that is indicative of the long-term character of a reservoir's biology. Zooplankton can also be artificially regulated. The size structure of zooplankton is an important water quality variable. Fish which feed on plankton can select large individuals with great precision. Size structure is the most important characteristic of zooplankton because of this selective pressure by predators. Reservoirs that differ in terms of the size and species of zooplankton also differ in phytoplankton development. The proportion of large water fleas in the total zooplankton biomass is critical (Hrbáček *et al.* 1986). This information can be obtained relatively easily during biomass determinations in a sample that has been divided into size fractions. Nets of 0.7 mm mesh are suitable for separating large and small zooplankton.

Species composition of **benthos** can indicate the presence of long-term oxygen availability at the bottom of a reservoir. Samples are best taken from the deepest portion of the reservoir during the warmest season. Benthos can be used to assess the saprobic situation in reservoirs.

The presence of **fish** that feed on zooplankton and predatory fish is significant, both in evaluation of the water quality of supply reservoirs and in formulating biomanipulation tools (Chapter 11.3). Temperate fish species that have significant undesirable effects on zooplankton populations include roach, bream, silver bream, bleak, rudd, whitefish, perch (body length up to about 17 cm) and pop. In the tropics, fish species are much more geographically differentiated than in temperate regions (Chapter 5).

8.3 RELATIONSHIPS BETWEEN WATER QUALITY AND QUANTITY

In the present, quantitative aspects predominate over engineering praxis regarding reservoir management. Reservoirs have been predominantly built with respect to water quantity and the guarantee of sufficient water quantity is still the basic requirement of reservoir operation. However, water quality aspects are of increasing concern, because a growing number of reservoirs are used for water supply purposes, water quality is of legislative concern. Because water quality is closely correlated with water quantity, new approaches are needed to meet water quantity and water quality demands that are sometimes mutually exclusive or conflicting.

Several kinds of the interrelations exist between water quantity and water quality. These are treated separately below.

a) **Within the watershed.** Clean water for use by humankind is taken from rivers and groundwater and polluted portions are returned to these sources. Evapotranspiration, which is connected with crop cultivation and natural vegetative cover not only decrease the quantity of flow, but also concentrate the chemical composition of flowing waters. Intensive irrigation (e.g.,

Australia) produces high levels of salinization in whole regions, particularly in groundwater. The concentration of chemical species changes with flow, and this relationship is dependent upon pollution sources, which include diffuse sources, point sources, farm fields, runoff of heavy rains following drought periods, etc. Wetlands have positive effects on the water retention capacity of a region and are also capable of considerable water quality improvements because they retain large amounts of many kinds of pollutants. An increase of the water retention capacity created by construction of trenches and pre-reservoirs can enormously increase retention of phosphorus, which is a critical nutrient in development of massive algal populations (eutrophication).

Because of the strong relationship between flow and chemical concentration, short term floods can contribute most of the annual pollution load to reservoirs. Three basic types of pollution concentration - flow relationships are provided in Fig. 8.1. In cases where one source clearly dominates, different relationships exist. In most rivers, no clear-cut relationships such as those shown in the figure exist, due to the mixed character of pollution sources in the watershed. During a given season, concentration - flow relationships change in an hysteresis fashion dependent on increasing or decreasing flows (Fig. 8.2). Similar changes can also be observed during floods; concentrations are higher when water rises than they are in decreasing phases.

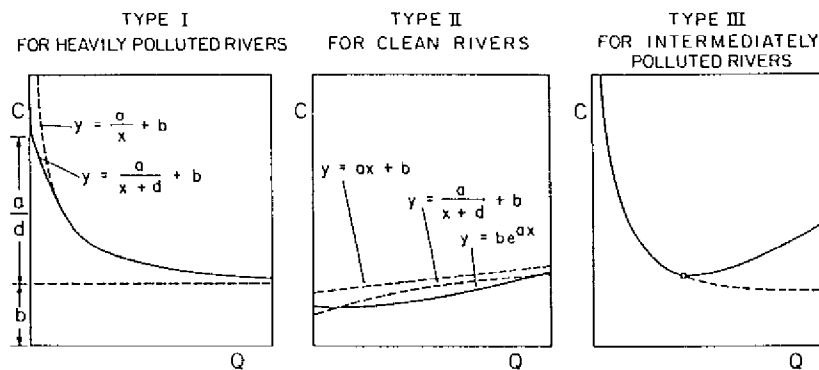

Fig. 8.1 Three types of dependencies between the concentration of chemical water quality variables and flow rates in rivers, in dependence on the type of pollution sources and their intensity. Type I is characteristic for rivers with a strong point source, while type II for rivers with diffuse sources, where the increase of concentration with the intensity of the sources might be steeper than given in the figure. Redrawn from Jolánkai (1983).

b) **Within the reservoir.** Changes of inflow quantity and associated changes of quality have direct consequences on reservoir water quality. Inflow quantity also affects mixing among different layers of the reservoir waterbody, and, thus, may have both positive and negative effects on quality of these layers. Water quality changes in a reservoir are closely connected with retention time. Water level fluctuations create water quality changes due to increased washout from the shores and degradation of higher vegetation in these areas and a loss of associated protective functions.

c) **At the reservoir outflow (to the river) and outlet (to the plant).** Changes in water quality in different depths of the reservoir depend on the depth at which water is released and the amount of water released. Outflow water quality can be modified by changing the layer from which water

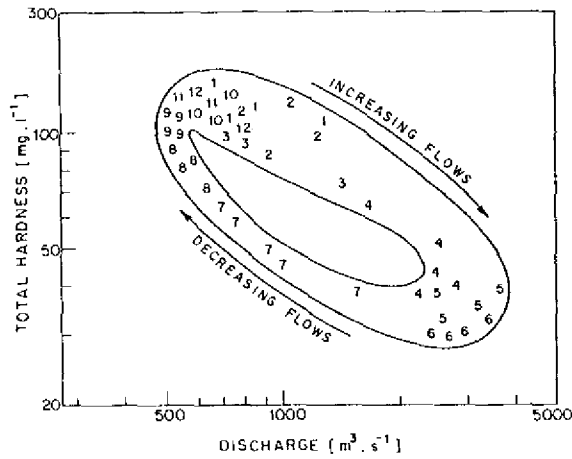

Fig. 8.2 Hysteresis effects of the concentrations of chemical water quality variables, exemplified by total hardness. The numbers in the graph indicate months of observation.

withdrawn, however, removal of water has a feedback effect on the layer from which it was taken. Users downstream of the reservoir must be supplied with a minimum amount of water, and also water that meets specific quality standards. There are many possible conflicts between water quantity and water quality demands. Flushing of the reservoir to improve water quality may be limited by quantitative needs. Maintaining minimum downstream flows of specific water quality standards is legally guaranteed in many countries.

Selection of the outflow level allows the manager several means to improve reservoir water quality.

CHAPTER 9

SAMPLING, MONITORING AND WATER QUALITY EVALUATION

9.1 WATER QUALITY DETERMINATION AS A SYSTEM

Any water quality investigation, whether focused on reservoirs or other waterbodies, must begin with a defined goal and proposed optimal methodology for meeting this goal. Past experience has demonstrated that it is easy to accumulate water quality data, but without analysis, interpretation of results and application of information, the effort is meaningless. Monitoring tends to be 'data rich but information poor' (Ward *et al.* 1986).

One approach is to treat the investigation as a system with subsystems that represent the stages in analysis of the problem. The subject locality, methods of data collection, and methods of data evaluation all must be considered in relation to the defined goals of the investigation. Figure 9.1 outlines this systems approach.

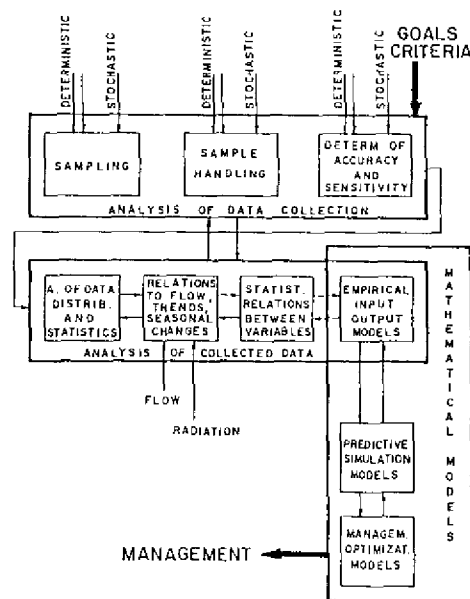

Fig. 9.1 Water quality investigation as a system, leading to the selection of appropriate management strategies.

The following stages are recognized:

- (1) Definition of goals preferably formulated as a list of questions and types of desired results.
- (2) Plans for data collection such as a sampling schedule (time, place and frequency of

sampling), and sample handling (transportation, preservation, variables to be measured and analysis methods).

(3) Data analysis - types of statistical data distribution, and character of the relationships between variables and the nature of the final outcomes (e.g., which method of analysis or mathematical models will be used) determines the procedures to be used.

(4) Interpretation of results, presentation of conclusions, and recommendations.

The following comments must be followed carefully:

(a) Although the schedule of the investigation above has been outlined in stages, each stage forms part of a whole and is not a separate entity.

(b) It is preferable that all stages are decided as much as possible, beforehand, because the lack of measurements of a variable that is necessary for interpretation of the investigation may greatly hinder the success of the objectives.

(c) The data selected for collection must depend on the objectives of the investigation.

(d) Definition of the objectives depends upon the level of prior knowledge of the subject and the locality, as well as the abilities of the investigators (level of education, experience, and knowledge of local problems). Collection of prior information related to the subject is, therefore, imperative in the early stages of investigation. Education of staff (e.g., learning skills in new methods) may often be necessary.

(e) Special attention should be focused on feedback effects between steps in the above procedure. Any sampling schedule depends on the type of statistical and spatial data distribution and on the relationships between variables. The data analysis methods depend on the expected evaluation and goals.

(f) For measurements of each variable, three characteristics that can be summarized as "precision" have to be taken into account. These are: levels of **sensitivity** (the lowest difference the procedure is able to detect), the lower limit of **detectability** (some methods do not give reliable estimates for the low values encountered in reservoirs, although they are very accurate for higher concentrations) and the level of **accuracy** (e.g., modern electronic instruments are very sensitive, but very inaccurate if not carefully calibrated).

(g) When selecting among methods with different degrees of precision, the information content of results desired must be considered. Determining the concentration of specific variables in one location with a time-consuming, expensive method that is very highly sensitive and accurate, may be wasted effort if the value changes considerably from spot to spot or changes rapidly during transport of the sample to the laboratory.

(h) In this case, it is often more profitable to sample at multiple locations or measure multiple variables. If the evaluation will examine relationships between variables, e.g., chlorophyll and phosphorus, it is preferable that both variables are measured from the same samples and with the same accuracy. For instance, precise determination of reactive phosphorus (phosphate) is only possible if completed immediately (within minutes) after sample collection. This is because organisms in the sample utilize and release phosphorus at rates that do not correspond to natural conditions. Also, sensitive organisms that die in the sample change the values considerably. Such immediate determination is not possible within most schedules. Thus, an easier means of total phosphorus determination, although less directly related to phytoplankton activity, is advantageous.

It is a common error in "data rich information poor" investigations to find uneven levels of precision among different determinants. It is a better use of time, money and effort to establish a common level of accuracy and precision during the initial stages of the investigation.

9.2 SAMPLING BEFORE THE RESERVOIR IS CONSTRUCTED

Prior to reservoir construction water quality investigations are part of a larger watershed and reservoir site investigation. The goal of a site investigation is to determine the state of the environment, its potential effect on the reservoir, and the potential effect of reservoir construction on the site and its respective populations. In many countries, an Environmental Impact Assessment (EIA) is a prerequisite for any large construction project. EIA brings together available information and knowledge of local conditions and ecology (Chapter 2.4).

In terms of water quality, the goal of the investigation is to estimate the possible water quality of the future reservoir and suggest steps necessary to reach desired water quality standards for designated reservoir uses or to help make selections between reservoir construction alternatives. These may include alternative dam locations, dam heights, potential construction of pre-impoundments in the watershed, installation of purification plants at major pollution sources, and many other water quality related alternative design features.

The site selection for this kind of analysis has to be based on the recognition of local situation in the watershed including land use patterns, location of industry and communities, degree of purification of industry effluents, and areas of increased diffuse pollution sources. The expected future development in the watershed, such as anticipated construction of new factories, population relocations and expected centers of recreation must be considered. All inflows that collectively represent 90% or more of the total inflow should be followed. In a case in which a very strong source of pollution in a small creek is anticipated due to the location of industry, this source is significant and cannot be neglected because of the small size of the creek. In the case of point sources, sampling sites should be located both above and below the source to enable estimation of the pollution contribution of this source.

9.3 OPTIMIZATION OF DISTRIBUTION AND TIMING OF SAMPLING

It is well known from theory, that to a certain point, more results can be obtained from more information, however, this increase in information eventually loses value and eventually more confusion than clarification can be obtained after the amount of information exceeds some critical value. Although a priori determination of the optimum level of information for a particular task is difficult, we must consider this general trend and seek ways to optimize data collection.

In general, the selected number of sampling stations on horizontal and vertical scales are, by necessity, a compromise between costs of time, money, manpower and objectives, including consideration of the reservoir size, seasonality and thermal structure. It is best to begin such an investigation with a detailed sampling event of a few easily-measured variables such as

temperature, pH or conductivity. This will help determine the areas where the largest changes are located. However, changes also occur in specific locations due to alternative inflow intensities, water levels and seasons and these must be considered.

Often, the differences between closely spaced sampling stations can be quite high. Therefore, the use of integrated, mixed samples is preferable to isolated spot samples. Water from a selected number of sampling locations, e.g., across the reservoir width can be combined into a large container, and subsamples taken after proper homogenization from this composite sample can be used for analysis. The use of a sampling tube or pump enables integration over depth. However, this kind of integration cannot be used for the determination of gaseous components like oxygen and pH.

The timing of sampling should depend on the expected degree of variability with time. Regular sampling intervals are easier to analyze statistically, but more frequent sampling in periods of great changes will yield an increase in the precision of time dependent values. Less frequent intervals may be appropriate during periods of low biological activity, such as colder seasons in the temperate region. Frequent sampling during flooding will greatly increase the estimates of annual loads. Floods might, indeed, be responsible for a large fraction of the loads. This is particularly true for the inflows, where pollutant concentrations strongly depend on flow rates. Because the organization of sampling in accordance with rapid changes during floods might not be easy, time integrated sampling is recommended. This is accomplished by use of several types of automatic samplers. A simple sampler that does not need a power supply can continuously divert a small fraction of flow to a container. More complicated pump operated samplers are able to automatically adjust the amount of water sampled to the flow rate, so that samples are both time-integrated and weighted by flow intensity.

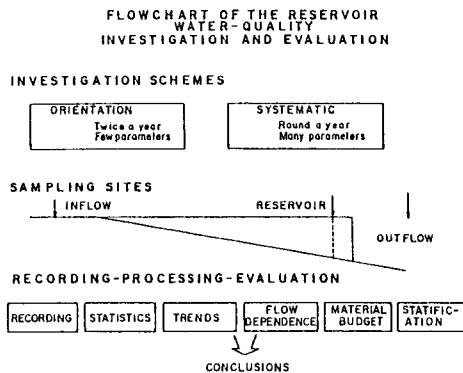

Fig. 9.2 Schematic representation of the orientation and systematic scheme of reservoir investigation and the sequence leading from water quality data recording through data processing to water quality evaluation and drawing conclusions.

For standard water quality control, two schemes are suggested: an **orientative scheme** used in small reservoirs in which there are no serious water quality problems, and a **systematic scheme**

used elsewhere. For investigations directed to increase limnological knowledge specific schedules corresponding to the problem to be solved must be selected.

In the **orientative scheme**, water samples are collected at only one site, within the reservoir proper, during the period of maximum stratification and full mixing. In the systematic scheme, samples are collected at the inflows, the main body of the reservoir, and point at which water is diverted to waterworks or outflows (Fig. 9.2). Examination of water quality at these three sites is necessary for accurate management assessments. In larger reservoirs, particularly those with more complicated shapes and several major inflows that possess different characteristics, more sampling locations must be monitored. Sampling is done at least in monthly intervals.

INFLOW: The tributary sampling site(s) must be located above potential maximum flood stage below the closest point source of pollutants. The sample collection should encompass the entire cross-section of the inflow tributary, because side releases located upstream can create large differences between conditions at opposite shores. Water that flows directly into the reservoir from a major pollutant source must be sampled separately. As pointed out above, if several tributaries enter the reservoir, each tributary that supplies more than 10% of the total inflow should be sampled for quantity and quality measurements.

MAIN BODY OF THE RESERVOIR: The reservoir must at least be sampled at its deepest spot, usually located near the dam. If intakes are not located near the dam, sites close to the location of these intakes must also be sampled. When the intakes are large, as is the case in hydroelectric reservoirs, sampling sites must be located a specific minimum distance from the intakes so that the region affected by the suction of the intakes is avoided. The number and distance between sampling depths will depend upon the reservoir depth and degree of stratification. The use of an automatic device (e.g., a thermistor) is recommended to estimate the degree of stratification on the sampling date, sampling depths can then be selected accordingly. Samples that are consistently collected at the same depths over the year are easier to analyze statistically, but important additional information can be obtained if samples are collected from depths where major changes occur. An indication of the depth of the epilimnion can be obtained by first determining the Secchi disc depth and assuming that the epilimnion depth is equal to three times the Secchi disc depth. The "surface" is sampled 20 - 30 cm below the water surface, to avoid particles that accumulate at the surface and the microstructure of the surface water mass. The "surface" layer should not be sampled near the shoreline because wind-blown scum often accumulates there. The "bottom" is sampled 1 - 2 m above the floor of the reservoir. In a stratified waterbody, individual vertical sampling depths should not be separated by more than 10 m.

One depth profile is usually sufficient for small to medium depth reservoirs. However, this profile should at least be complemented by samples collected from the inflow zone of the reservoir. In large reservoirs, which possess bays that can be of a size of a small to medium sized reservoir, differentiation in these bays may be great enough to warrant more sampling localities. In shallow, non-stratified and non-throughflowing reservoirs, horizontal differences are predominantly wind driven, thus, samples should be taken along several vertical profiles.

OUTFLOW: The quantities of water that is diverted or discharged from a reservoir, as well as

the layers from which water is withdrawn, should be determined for all outflows and outlets. Water quality sampling at the outflow is necessary to monitor the effect of the reservoir on downstream use.

9.4 MANUAL SAMPLING

One general problem in analysis of sampling of variables that can make evaluation of the results misleading or difficult is the inconsistency of procedures between various laboratories. A suggested procedure for checking the comparability of values obtained by different laboratories acting within the same watershed, state or geographical region is laboratory inter-calibration, which is accomplished by sending the identical samples to different laboratories and comparing the results. In marine samples basic variables with fairly simple sampling and determination methods were found to vary considerably when samples were processed by different experienced teams. Similar situation is to be expected for freshwater determinations.

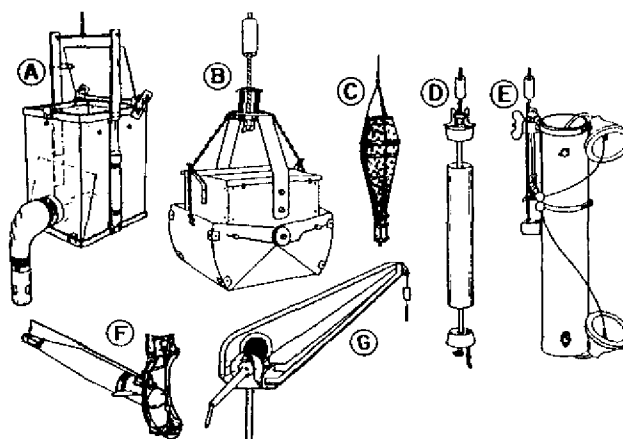

Fig. 9.3 Instruments for manual water quality sampling. A - Schindler zooplankton sampler, B - bottom sediments and benthos grab, C - Apstein type plankton net, D - Ruttner's water sampler, E - VanDorn water sampler, F - Clarke-Bumpus zooplankton sampler, G - winch for lowering the above instruments.

Instruments used in manual water quality sampling are depicted in Fig. 9.3. A winch is necessary for such instruments, as shown in Fig. 9.3G. Measurement of **temperature changes** at different depths is easily accomplished with use of a thermistor, resistance or other electric thermometer. However, values obtained with such devices should be confirmed with an accurate (calibrated) mercury thermometer during each sampling event.

Zonal sampling bottles (samplers) of any available type can be used (Fig. 9.3D,E). The construction of the sampler must allow water to flow freely through the open descending bottle to ensure that samples are collected from the required depth. The sampler must be equipped with a discharge tube that is long enough to touch the bottom of the bottle that is used to determine

dissolved oxygen concentration and pH. Reagents used in determination of dissolved oxygen are added to the bottle and the pH is measured immediately. For chemical analyses, it is advisable to flush the sample bottle at least twice its full volume before collecting the sample. If the water sample makes contact with air, or if reagents are not added immediately, analytic results can be biased, especially at oxygen concentrations lower than 2 mg.l^{-1} .

Because some determinations are very time consuming and expensive, and samples location and depth often do not produce a representative value, it is advisable to collect representative samples.

Samples must be protected from sunlight, overheating and undercooling during transportation and handling. Portable polystyrene boxes (or polystyrene - insulated boxes) or battery operated refrigerators are suitable for this purpose. Specific requirements for **preservation of samples** depend on the variables to be determined. For instance, samples collected for total phosphorus determination can be preserved by acidification. Whenever possible, samples should be preserved immediately after collection because considerable changes can take place during sample transport and storage.

Bacteria. Direct sampling and cultivation methods are distinguished. Direct method samples are preserved at the time of collection with formal. Cultivation methods require extreme sterility, and surface samples are best collected with the sample bottle fastened on a firm wire so that contamination is prevented.

Samples for measurement of **phytoplankton** (including CHA) are either collected zonally (which is time consuming), or with a simple tube that can sample the entire production layer at one time. A 3 - 5 mm diameter plastic tube that is 4 - 6 m long is equipped with a simple closing mechanism. Several samples collected with the tube, preferably at several locations across the reservoir, are combined in a container and, after mixing, subsamples are removed for different purposes. A pump can also be used to obtain integrated samples that encompass the production layer. In this case water collected from different depths is combined in a large container and the sample is withdrawn from this composite. Because most pumps have a high capacity, the outflow stream to the containers might need to be divided. Lugol solution is the preferred preservation for phytoplankton sample. Because iodine is the main component of Lugol solution, it is fairly unstable and the samples will need addition of fresh solution after some time. Nanno- and picoplankton cannot be measured in the manner we have discussed. Quantitative determination of larger colonial phytoplankton species like *Volvox* can better be obtained from quantitative net samples such as those used for zooplankton, because densities of these organisms are much lower than most phytoplankton. Sampling for **chlorophyll** requires that samples are filtered immediately after collection and the filtrate is kept dry in an exhaustor, in darkness and refrigerated, or at least in cold, during transport.

Zooplankton can be sampled with Apstein-type nets (Fig. 9.3C). For determination of zooplankton zonation, a large sampler, preferably the Schindler type (Fig. 9.3A) or a pump with a high sucking speed which zooplankton cannot avoid is required. The Clarke-Bumpus sampler (Fig. 9.3F) has a meter that determines the filtered volume and is operated from a running boat. Layered samples or oblique hauls produce samples that are integrated over certain depth intervals.

The lowest level of the sampler can be determined by a predetermined boat speed and line length and by using a simple inclinometer to indicate the slope of the line. Using a triangular rule the desired inclination, corresponding to the desired depth, is calculated. Microzooplankton are not quantitatively sampled by nets because fine dense nets that can retain even the larger of these organisms are easily clogged and standard nets have far too large openings to retain them. Moreover, concentrations of rotifers and protozoans are large enough so that large volume samples are not necessary. Samples that range from a few hundred milliliters up to 1-2 liters require specific preservatives, because many protozoan species lose integrity if standard preservatives are used.

A recent method for quantitative characterization of plankton is the use of apparatuses that enable automatic sizing, such as a Coulter counter or cytofluorometers (for phytoplankton only). Sizing appears to be a good substitute for cumbersome quantitative taxonomic determinations (Sprules, 1984). Sizing is also an important measure for water quality evaluation.

Bottom samples are taken with a grab (Fig. 9.3B). The height of the grab must exceed that of the soft mud layer, otherwise the top layer where benthos is most concentrated can be lost.

9.5 AUTOMATIC MONITORING

Two methods of automatic monitoring are distinguished: (i) monitoring by lowering a probe into different depths, and (ii) monitoring by recording measurements in time. In some instances it is possible to combine the two approaches.

Many types of recording instruments are now available for use of both methods. Data storage is automated by use of a special storing device (data logger) or by attaching the instruments to a computer. The second alternative has the advantage that very plastic data processing is allowed immediately. This can be in the form of statistical elaboration of data (recalculations to selected kind of units, averages, integral over periods, etc.) or as graphical representations. Data from specialized loggers have only a limited range of data elaboration functions. For full analysis, the data must first be entered into a computer. The advantage of data loggers is that they are much more rigid, less weather sensitive and require less energy to operate. Some loggers can operate unattended for months while they record several variables in hourly or shorter intervals.

Two basic kinds of data records can be obtained: analog and digital. An analog record (in the form of a time or depth graph) is very useful for rapid analysis of changes, while the digital records provide more exact individual values. Storage of digital values and simultaneous presentation in the form of analogues is the optimum combination. Instantaneous records of variables that change rapidly is of low utility, and it is preferable to obtain values integrated over time periods of certain length. For instance, wind speed varies within seconds, and integral (=average) over some interval provide information that is more useful and easier to interpret.

Depth profile instruments can be classified into two types: (i) those that are lowered to a certain depth which is recorded manually, and (ii) free falling probes. The reaction time of the first type

must be considered. Free falling probes are capable of automatically recording the profile with a resolution within millimeters.

Monitoring of certain indicators over time provides the manager with exact information, however, interpretation of this information may not be easy. Therefore, some monitoring systems offer simple forms of interpretation. For instance, a warning signal is emitted if some predetermined absolute value is exceeded. In more advanced systems, a warning signal is emitted if a predetermined rate of change of a critical variable is exceeded. Thus, the manager is notified that a management option may be needed to improve the situation.

Data may be transmitted to management headquarters over large distances by use of radios. Figure 14.3 demonstrates how an automatic water quality control can be installed if water quality variables that are critical for the system are recorded, such as chlorophyll-a concentrations in eutrophic drinking supply reservoirs. If chlorophyll increases its rate of change above a certain limit, the control indicates that water quality problems will soon start to appear, and some corrective action may automatically be triggered. Another example is the triggering of mixing devices such as the epilimnetic mixing described in Chapter 11.1. The use of monitoring combined with other mathematical modelling applications is described in Chapter 14.8.

With all kinds of automatic instruments available, two qualities must be carefully distinguished; these are the **sensitivity** and **accuracy** of the instruments. While the sensitivity of the instruments is usually very high, their accuracy is highly dependent on the accuracy of calibration. Automatic instruments that are used prior to careful calibration can produce completely erroneous results. Although many recently developed instruments include provisions for automatic calibration, a periodic check with a classic chemical or other determinant is greatly recommended. Usually the control of only one value is insufficient. Calibration of extreme values produces the highest determination accuracy.

9.6 SATELLITE IMAGING

The use of satellite imagery in reservoir water quality monitoring is mainly useful for large reservoirs. Satellite images can be combined with aerial photographs, which are another useful tool. The need for a reservoir sampling scheme that permits control and calibration of the satellite images or aerial photographs is fundamental to the success of this method. Therefore, both high altitude (satellite) and low altitude (aeroplane) images have to be permanently calibrated with classic ground level sampling and/or monitoring data. Usually, the variables that can be followed and are useful include chlorophyll-a, suspended materials, turbidity and temperature. One pitfall of this technique is that it does not allow recognition of the vertical distribution of variables. When vertical measurements of water quality are available and a satellite image of the reservoir is provided (recorded simultaneously with the sampling), the average concentration per unit surface can be calculated by integration.

Satellite images also offer an overview of the plume of water as it enters the reservoir. Vertical sampling at discrete depths can provide a quantitative measurement of such variables as

suspended materials and chlorophyll-a. By coupling the surface image with the vertical sampling an estimation of the average concentration of material entering the reservoir and location of the entering plume may be obtained.

The use of satellite and aerial imagery can help in formulation of management decisions. The following information can be obtained:

- 1) horizontal distribution of Cyanobacteria blooms;
- 2) areas of concentration of suspended inorganic and organic matter;
- 3) areas of high and low turbidity;
- 4) horizontal displacement of river plumes that may carry pollutants and suspended material into the reservoir;
- 5) horizontal distribution of chlorophyll-a and location of low and high concentrations of phytoplankton;
- 6) location of mass fish kills in the reservoir;
- 7) distribution of total phosphorus and nitrogen can be depicted with some careful analysis and reservoir specific correlations with other variables such as chlorophyll-a, temperature and transparency or adsorption coefficients; and
- 8) detection of macrophyte concentrations.

In Barra Bonita Reservoir (Brazil), Novo *et al.* (1993) described the horizontal distribution of chlorophyll-a, suspended inorganic matter, nitrogen and phosphorus by the use of LANDSAT imagery and horizontal sampling conducted simultaneously with the satellite image at 30 stations.

9.7 DATA STORAGE AND HANDLING

Data obtained by determining individual water quality variables must be processed before they can serve as a basis for further assessments. Tabulation of data is the first step. Entering records into a software database will further simplify data analyses. One basic data processing technique is calculation of annual or seasonal averages, and determination of minimal and maximal values. Temporal trends are also determined, in order to determine if water quality is improving or deteriorating. This requires that observations are recorded over numerous years because many water quality variables display dramatic seasonal variations. Another factor that complicates the evaluation of water quality changes is the dependence of variables on the flow rate. Changes due to the effect of storage, measured as the difference between the quality of inflow and outflow or diverted waters, are affected by stratification and processes that cause horizontal water quality gradients along a reservoir. Assessment of changes is facilitated by estimating the budget of chemical substances in the reservoir (i.e., differences between their inflow and outflow quantities). This difference is affected by long-term trends, as well as flow rates and stratification in the reservoir.

Water quantity and quality data in the inflow, outflow and the reservoir body must be stored. Modern PC spreadsheets and/or databases (LOTUS 1-2-3, QUATRO, EXCEL, PARADOX, FRAMEWORK - for review see Neethling 1986) are best suited for this purpose, with rows that can represent variables and columns that can represent dates. Special tables can be prepared for

the stratification of each variable, with rows that represent individual depths, and columns that represent sampling dates. All depth measurements are recorded, even if they were measured only once in a given period. When a depth is not measured, the corresponding cell should be left blank. The advantages of this storage method are easy calculation of basic statistics, pseudographic expression of results, and an easy transfer for use in graphic representation software packages.

9.8 WATER QUALITY EVALUATION

9.8.1 Reservoir water quality evaluation indices

Due to the large number of water quality variables and their high variation, a water quality index may help to describe the overall situation (Thanh & Biswas 1990). However, these authors state: "Unfortunately, the number of water quality indices used in different countries and states of USA is as high as the number of variables themselves". Several index and classification systems exist for lakes. They are very local, and are based on specific conditions in the given country or region. The only reservoir classification system is one that is based on Texas fish assemblages by Dolman (1990). There is no generally accepted classification system.

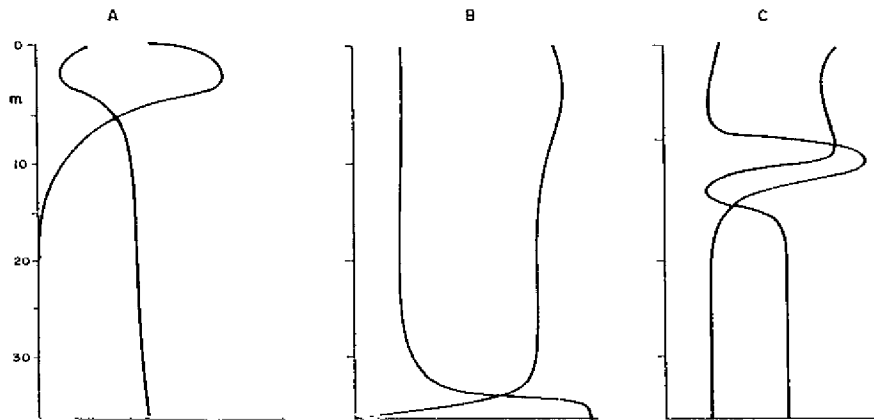

Fig. 9.4 Examples of characteristic depth profiles of oxygen

As an example, we give here the General Lake Water Quality Index (GLWQI) which was formulated by Malin 1984) for Finnish deepwater lakes. His index is based on the following variables, chosen by means of principal component and cluster analysis: oxygen, conductivity, pH, color, manganese and TP. The index is represented by a dimensionless number, regarded as a relative measure of water quality. For each variable a value function (0 to 1) is graphically depicted, after derivation by means of the regression analysis. The value functions should indicate

how individual measurements compare with data from the whole country. These value functions are shown in Fig. 9.4. The GLWQI is then calculated, based on the volume-weighted mean of

all variables, and therefore ranges from 0 to 1. No attempt was made to delineate any classes according to the values of the index.

A recent trend in biosurveys is based on the concept of ecoregions. Ecoregions are defined as mapped regions of relative homogeneity within land surface form, soil, potential natural vegetation, and general land use. In aquatic ecoregions waterbodies are grouped that would be similar in the absence of permanent human settlements; such regions are substantially less diverse than an entire nation or state (Hughes *et al.* 1992). Although ecoregions have sometimes been considered "an objective basis for establishing regional criteria that are feasible and protective of aquatic systems" (Biggs *et al.* 1990) it is difficult to use in reservoir management except, perhaps, in regions that have large reservoir concentrations. The reason is that almost all reservoirs will belong to another ecoregion.

Because very few general classification and evaluation systems that are based on water quality indexes or ecoregions exist for reservoirs, the following evaluations are based on individual variables. Another reason to base an evaluation on individual variables is because these variables characterize water quality standards, which define the water quality goals of waterbodies.

9.8.2 Evaluation according to individual variables

In this section, we present evaluation considerations for a selected number of water quality variables that are most important in reservoir water quality evaluation. However, more variables exist, particularly chemical attributes, that must also be observed. New chemical compounds are added to the market daily, and their environmental effects are often unknown. Many such compounds are known to be harmful in higher concentrations, particularly if they enter water that will eventually be used for public consumption. Those that are considered in water quality norms are listed in Chapter 8. We have attempted to discuss the variables in approximate order of their importance in general water quality characterization. This is also somewhat paralleled by ease of determination of the respective variables. First the most general and easily determined variables are discussed and are followed by more specific variables. For each variable, evaluation in respect to different targeted water uses is mentioned and remarks regarding different reservoir classes are included. Our main considerations are drinking water supply, recreation, irrigation and fisheries. For other uses (hydropower generation, navigation, flood protection and flow augmentation) water quality is of less importance, although hydropower generation can also be negatively affected by the hypolimnetic anoxia.

For most variables a relationship exists between river flow and concentration (Chapter 8.3). For this reason, seasonal water quality changes in the reservoir must be evaluated in relation to changes of inflow rates. In a large reservoir, side inflows characterized by precipitation conditions in their respective watershed may differ from those of the main inflow and may cause spatial and seasonal irregularities in water quality.

Transparency. Each of three components mentioned in Chapter 8.2 (color, mineral turbidity and algae) has a different effect on transparency, as measured by the Secchi Disc, and also on water usage. Mineral turbidity, which is most simply expressed by means of the concentration of total suspended solids or nephelometric turbidity units (NTU), normally ranges from 1 - 1000 NTU.

However, the measure of total suspended solids is only very loosely related to transparency. Important is the size (the same concentration of small particles produce higher transparency than that of large ones) and character of the particles. Medium and high mineral turbidities create difficulties in treatment of drinking water. Turbidity also leads to reservoir infilling and decreased reservoir age. Fishes are hindered in highly turbid waters because mineral matter has a negative effect on the development of planktonic fish food and because visibility of food and predators is reduced. Phytoplanktonic turbidity, which is turbidity caused by algal biomass, can be estimated only after separation of algae from mineral and color turbidity. In territories with balanced hydrologic budgets and relatively regular distribution of precipitation events, turbidity is usually restricted to periods of heavy rains and increased erosion. The duration of such periods is usually short, commonly lasting several days. In this case, it is possible to use the transparency measured during a period of low flow as a background level from which to calculate transparency due to phytoplankton. Table 9.1 presents helpful parameters for the evaluation of background transparency.

Tab. 9.1 Classification of reservoirs by phytoplankton caused transparency.

PHYTOPLANKTON CAUSED TRANSPARENCY [m]	RESERVOIR	TROPHY
<0.3	not transparent	hypertrophic
1 - 2	poor transparency	eutrophic
3 - 6	semi-transparent	mesotrophic
>6	clear	oligotrophic

Oxygen. Background oxygen concentration in water is largely a result of the solubility of oxygen in water at different temperatures. An estimate of the amount of oxygen at saturation can be obtained by using this equation:

$$DO [mg.l^{-1}] = 14.624 - 0.40776 T + 0.00811362 T^2 - 0.000078765 T^3 [T \text{ in } ^\circ C]$$

The difference between the oxygen concentration calculated by using the equation and actual concentration is the percent of oxygen saturation. An increase of oxygen in water results from photosynthetic processes by phytoplankton, whereas a decrease is due to decomposition processes, which include bacterial and algal respiration and decay of organisms and organic matter. Decomposition is sometimes of allochthonous origin, from decomposition of organic pollution brought by the inflows, and is otherwise autochthonous, predominantly due to respiration and decay of organisms. The actual oxygen concentration in water is a result of the ratio between oxygen production and utilization. At the reservoir surface, low oxygen saturation is an indicator of allochthonous organic pollution, because decomposition of organic matter brought in by the inflows prevails over photosynthetic production. High oxygen concentrations during the cold periods and somewhat lower concentrations during warm periods suggest oligotrophy, i.e., prevalence of physical control over biological control of oxygen. This is also accompanied by high oxygen saturation in the hypolimnion. Oxygen saturation during warm periods that is higher than saturation during cold periods is a sign of meso- to hypertrophy. It is accompanied by low hypolimnetic oxygen concentrations. High daily oxygen variations signal eutrophy or hypertrophy, because during the day photosynthesis prevails whereas respiration prevails at night. High oscillations in concentrations of the surface layer around a low saturation level indicate that the reservoir is both polluted and eutrophied.

A good general indicator of **oxygen conditions** in a reservoir is the oxygen concentration in the hypolimnion. For temperate reservoirs, the values given in Tab. 9.2 are considered critical in terms of the suitability of the reservoir for drinking water supply.

Tab. 9.2 Indication of the suitability of temperate reservoirs for drinking water supply by a critical concentration of oxygen in the hypolimnion. After Dillon & Rigler (1975).

CONCENTRATION OF O ₂ [mg.l ⁻¹]	SUITABILITY OF RESERVOIR
> 5	excellent
< 5	suitable
< 2 briefly	not very suitable
< 2 for a long time	unsuitable

The development of low oxygen and anoxia is much more common in tropical reservoirs than in temperate reservoirs. Although the indicators in Tab. 9.2 are also valid for tropical reservoirs, it is often necessary to produce drinking water under low hypolimnetic oxygen conditions.

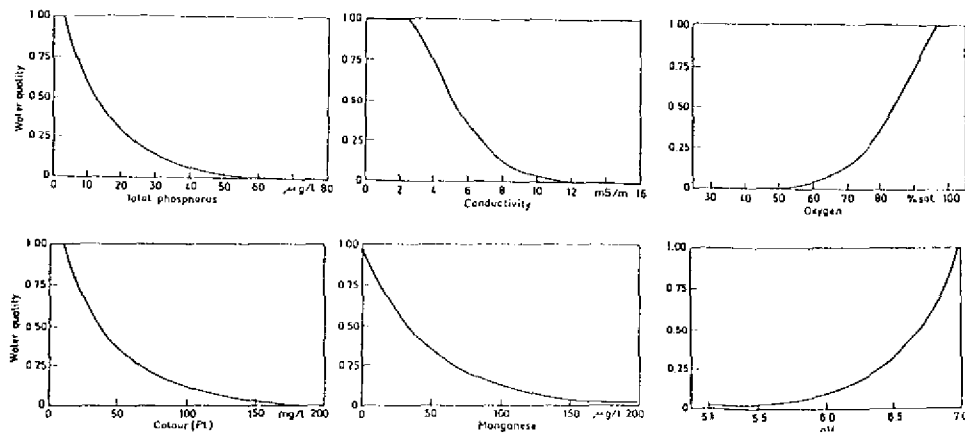

Fig. 9.5 Value functions for the General Lake Water Quality Index for Finnish deepwater lakes (Malin 1984).

Depth profiles of oxygen are often similar to the depth distribution of other variables. The density difference between different layers is decisive, therefore, temperature stratification is a good indicator of the depth at which major changes are expected. Basic types of depth profiles of oxygen and related variables are shown in Fig. 9.5. They are distinguished by the following characteristics:

(a) A marked change in the mixed zone. This type of curve denotes the effects of biological production processes in the surface layers. The change is caused by production of organic matter, incorporation of nutrients, carbon dioxide consumption (changes in pH and alkalinity), and oxygen production by phytoplankton. The change can be caused by variables increasing by production (like oxygen), or decreasing by consumption (e.g., phosphorus). The degree of change

depends on the intensity of production processes and density differences in the thermocline layer.

(b) A marked change at the bottom. This indicates a strong decomposition effect. Diminished oxygen or enhanced carbon dioxide concentrations can be the result of either direct or indirect causes. Direct causes are oxygen consumption and CO₂ production during the decomposition process. The indirect cause is the anaerobic environment at the bottom of the reservoir, which results in an increased rate of release of various substances (e.g., Fe, Mn, sulfides, ammonia, phosphorus). In anoxic sediments precursors of carcinogenic components (e.g., dissolved methane, lignin and humic compounds) are also formed. These compounds form during contact with chlorine that is used during drinking water treatment trihalomethanes, THM, (e.g., chloroform). The potential for THM formation is related to the concentration of organic carbon.

(c) A pronounced change in middle depths. This indicates either decomposition effects in the metalimnion (metalimnetic minima) or inflow of water layers with differing concentrations. Physical processes play a major role in the latter case.

These main types of curves should only be regarded as those that are most frequently observed. Because three principal processes, production, decomposition and oxygen deficit, can affect most parameters simultaneously, there are many modifications and combinations of these curves.

Phosphorus. The evaluation of phosphorus concentrations in the surface layers of a reservoir is related to the amounts of CHA produced in the waterbody. As discussed in Chapter 14.4, the relationship is nonlinear and has a saturation character (Fig. 14.1). We can distinguish the critical values of PO₄-P and TP given in Tab. 9.3.

Tab. 9.3 Critical average annual values of PO₄-P and TP (µg.l⁻¹) at the reservoir surface. Modified and extended from Ryding & Rast (1989).

	TEMPERATE REGION	TROPICAL REGION
Oligotrophic	> 10	> 10
Mesotrophic	10 - 35	> 20
Eutrophic	35 - 100	> 50
Hypertrophic	> 100	> 200

In the hypolimnion, there is a linear relationship between the concentration of oxygen and concentration of phosphate phosphorus; e.g., in the temperate dimictic Lake Gersau in Switzerland, the phosphorus concentration increased from about 10 µg.l⁻¹ at 6 to 8 mg.l⁻¹ O₂ to 50 µg.l⁻¹ when oxygen concentration decreased to 1-2 mg.l⁻¹. These figures correspond to a decrease of about 7 µg.l⁻¹ PO₄-P for a 1 mg.l⁻¹ increase of oxygen (Stumm & Baccini 1978). Similar relations are seen in Fig. 7.1 and other observations in the temperate region, so this relationship can generally be considered valid. In connection with the relationship between phosphorus and CHA, it is evident that an increase of oxygen concentrations in the hypolimnion and or prevention of low oxygen levels that lead to anoxia by use of ecotechnological methods has a very positive effect on reservoir water quality.

Nitrogen. Natural background concentrations of nitrogen compounds are generally as follows: nitrate nitrogen less than 0.2 mg.l⁻¹ (corresponding to less than 1 mg.l⁻¹) nitrates); ammonia

nitrogen 0.1 - 0.2 mg.l⁻¹; and nitrites less than 0.002 mg.l⁻¹. If observed values are higher than these, possible sources of pollution must be considered. Increased concentrations of nitrates indicate pollution by mineral fertilizers that are applied to fields in the watershed. Increased ammonia is usually a sign of increased pollution from animal husbandry. Other sources of ammonia include sewage and industrial pollution e.g., ammonia used in pulp and paper production. Low concentrations of nitrogen in relation to phosphorus (Chapter 4.5) can result in nitrogen limitation of phytoplankton. A trophic state index for nitrogen was elaborated by Katzer & Brezonik (1981). As discussed earlier, nitrogen is also of hygienic importance. Increased concentration of nitrogen compounds creates difficulties in treating drinking water (exceedance of local norms, which vary between 10 and 50 mg.l⁻¹ nitrates, 0.5 to 2 mg.l⁻¹ ammonia and 0.1 to 1 mg.l⁻¹ nitrites).

Organic matter. Organic matter is measured as organic carbon, COD and BOD. While measurement of organic carbon does not distinguish between easily decomposable and refractory organic matter, BOD is an indicator of easily decomposable matter and COD is an indicator of the sum of easily decomposable and refractory OM. When evaluating BOD₅ in a reservoir, we must include the contribution of allochthonous organic production. This can be estimated from chlorophyll-a concentration. The BOD₅ equivalent of algal biomass that is expressed as chlorophyll-a is approximately 0.025 mg BOD₅ per 1 µg CHA (Straškrabová *et al.* 1983). An estimation of the BOD conditions in the reservoir can be obtained by using the model of Straškrabová (1976) - see Chapter 14.

Mineral composition - hardness - salinity. Water that is used for some technical purposes may impose specific hardness and salinity requirements. Increased hardness and salinity may clog and corrode pipes and machines. Hardness and salinity are also critical factors in drinking water. Water that does not exceed minimum quality criteria may still be undesirable from the users' point of view. Food products vary when they are produced from raw water that is high or low in mineral content. Hard water is very good for preparation of coffee, whereas tea is not as good if prepared with the same water. Concentrations of sulphates that exceed 400 mg.l⁻¹ make drinking water taste unpleasant. Natural concentrations of chlorides are usually between 2 and 10 mg.l⁻¹. Excessive amounts indicate industrial effluents, sewage, and large runoff from agriculture and roads. Chlorides and sulphates from agriculture originate in mineral fertilizers. Salting of roads in winter periods also contributes significant amount of chlorides. In arid and semiarid regions, concentrations are significantly higher and vary more during the year than they do in wet territories.

The value of pH. At the water surface, balanced pH varies between 6.0 and 7.2 during periods of low photosynthetic activity. In the hypolimnion, pH values are usually lower. A pH value lower than 6.0 either indicates dystrophic character or consequences of acidification. Dystrophy is also indicated by brown colored water, whereas acidified waters are usually clear. The consequences of acidification in the reservoir were shown earlier in Fig. 6.8.

Bacteria. The three groups mentioned in Chapters 4 and 8 have rather different indicator capabilities: Psychrophilic and mesophilic bacteria indicate the presence of easily decomposable organic matter, whereas coliforms and streptococci are of faecal origin. Concentrations that

indicate substantial pollution of the inflow streams are summarized in Tab. 9.4. When evaluating bacterial counts in reservoirs, we must consider the throughflow, mixing and trophic categories of the reservoir. In small, shallow, unstratified reservoirs the risk of high "inflow" concentrations near the dam is always present. In deep reservoirs with intermediate and long retention times, this occurrence depends on the course of inflow through the reservoir. In density currents, concentrations can be much higher than in quiescent water. The occurrence of high concentrations near the dam, if not caused by a density current, may indicate contamination from a nearby tributary. Concentrations of psychrophilic bacteria as high as 10^3 or even higher may occur in eutrophic reservoirs when masses of phytoplankton are decomposing. Values of psychrophilic bacteria that are greater than 10^4 per milliliter indicate allochthonous organic matter pollution from various sources. A high proportion of mesophilic bacteria as compared with psychrophilic bacteria indicates contamination from sources such as manure or silage. Coliforms are exclusively of fecal origin, however, the source of these can include any warmblooded animals in the watershed as well as humans. Coliforms are often undetected in the lacustrine zone of stratified reservoirs (due to their high sedimentation - see Chapter 4.6). Increased values in the lacustrine zone may indicate disturbance of the sediments during swimming and other activities. Fecal streptococci indicate very fresh pollution because they rapidly die in water.

Tab. 9.4 Levels of bacterial indicators that suggest substantial pollution of the inflow streams.

INDICATOR	COUNTS per ml
Psychrophilic	10^2 - 10^6
Mesophilic	10^4 - 10^5
Coliform	10^2 - 10^3
Fecal Streptococci	$>10^2$

Heavy metals. Most cases of increased concentrations of heavy metals are connected with improper human activities. It is difficult to measure very low concentrations. A better indication of the heavy metal burden in the reservoir is the chemical composition of sediments. Sediments accrue heavy metals for long periods of time. The most contaminated of the sediments are those at the beginning of the intermediate zone in reservoirs where most of the allochthonous particulate matter is deposited. If pre-reservoirs exist, most of the sediments are accumulated there.

Toxic organics. The common and important classes of toxic organics are mineral oil, petroleum products, phenols, pesticides, polychlorinated biphenyls and surfactants. Toxic effects of phenols can be observed on fish at concentrations as low as 0.01 mg.l^{-1} . Specific evaluation is needed for each class.

Phytoplankton composition. Phytoplankton composition changes seasonally and is geographically dependent. The geographical dependence is due, not only to physical variables like radiation and temperature, but also to biotic interrelations in the given waterbody. For these reasons, the only good systems of phytoplankton composition evaluation are locally derived, not worldwide. Local systems are too numerous to be discussed here. Evaluation requires detailed knowledge of phytoplankton species and such an evaluation is not possible by using a general

phytoplankton atlas. As an example, Tab. 9.5 is a summary of the system, used for drinking water supply reservoirs in the Czech Republic, which combines species composition and CHA. A rough evaluation of water quality based on the mass appearance of different major groups of algae is possible. Cyanophyta, mainly colonial forms such as representatives of the genera *Aphanizomenon*, *Microcystis* and *Oscillatoria*, signal conditions that are eutrophic to hypertrophic. The predominance of diatoms signals lower trophy and better water quality, however, mass appearance of diatoms, in particular of the colonial species, may result in water treatment difficulties including clogged filters. The presence of small green algae in reservoirs, particularly when densities are low, is usually a sign of good water quality.

Tab. 9.5 Assessment of qualitative composition of phytoplankton in drinking water reservoirs. Predominant genera and species and maximal concentrations of CHA are listed.

SPRING ASPECT (SAMPLING IN APRIL - MAY)	
Composition suitable for treatment with standard technology	Chrysophyceae (<i>Chromulina</i> , <i>Chrysococcus</i> , <i>Mallomonas</i> , <i>Dinobryon</i>), Cryptophyceae (<i>Cryptomonas curvata</i> , <i>C. reflexa</i> , <i>C. ovata</i> , <i>Rhodomonas</i>) not more than 50 mg.m ⁻³ Bacillariophyceae (<i>Asterionella</i> , <i>Melosira</i> , <i>Stephanodiscus</i> , <i>Cyclotella</i>) not more than 40 mg.m ⁻³
Unsuitable species composition, requiring special treatment	Bacillariophyceae (same species) over 40 mg.m ⁻³ Chrysophyceae (<i>Uroglena</i> , <i>Synura</i>) over 50 mg.m ⁻³ Chlorophyceae (Volvocales: <i>Chlamydomonas</i> , <i>Chloromonas</i>) over 60 mg.m ⁻³
SUMMER ASPECT (SAMPLING IN JULY-SEPTEMBER)	
Composition suitable for treatment with standard technology	Bacillariophyceae (<i>Asterionella</i> , <i>Fragilaria</i> , <i>Stephanodiscus</i> , <i>Cyclotella</i> , <i>Melosira</i>) Cryptophyceae (<i>C. reflexa</i> , <i>C. marssonii</i> , <i>C. ovata</i>) not more than 40 mg.m ⁻³ Dinophyceae (<i>Ceratium</i> , <i>Peridinium</i>), Chlorophyceae (Chlorococcales: <i>Scenedesmus</i> , <i>Crucigenia</i> , <i>Planktosphaeria</i> , <i>Pediastrum</i> , <i>Coelastrum</i>) not more than 50 mg.m ⁻³
Unsuitable species composition requiring special treatment	Cyanophyceae (<i>Aphanizomenon</i> , <i>Microcystis</i> , <i>Anabaena</i> , <i>Oscillatoria</i>) Dinophyceae (<i>Peridinium</i>) over 40 mg.m ⁻³ , Chlorophyceae (Volvocales: <i>Chlamydomonas</i> , <i>Chloromonas</i> , Chlorococcales) over 50 mg.m ⁻³

Phytoplankton quantity and biomass. A specialist is necessary for proper determination and evaluation of phytoplankton biomass, as determined by microscopic counts and sizing of different species. Evaluation systems that combine phytoplankton biomass in the manner just described with biomass data of dominant species and species groups provide good assessment of waterbody conditions. However, the most generally applicable measure of the phytoplankton biomass is the quantification of chlorophyll-a. This is true in spite of the fact that the concentration of chlorophyll-a is not constant, but varies with differing algal groups and seasonal difference in both temperate and subtropical regions. Cyanophyta contain a low percentage of chlorophyll-a, whereas diatoms and green algae have generally the highest chlorophyll content. Seasonal changes of the chlorophyll-a content in algae are determined by differences in light availability for phytoplankton. When solar radiation is low and mixing is deep, the CHA content is higher than during seasons of high surface light and high light availability to the phytoplankton population concentrated in surface layers during distinct thermocline development. For this reason, it is

sometimes best to simply consider CHA a water quality variable and disregard its relation to biomass. In this case, CHA is a good measure and its evaluation in trophic considerations can be based on Tab. 4.3 in Chapter 4.

Nutrient addition tests. For evaluation of critical nutrients and measurement of trophic capacity of reservoirs, standard growth tests are conducted using selected phytoplankton species that are easily cultivated. A commonly used alga is *Selenastrum capricornutum*. For the determination of limiting nutrient, phosphorus or nitrogen is added to the test culture and the growth response of the culture is noted. The algal growth reacts on nutrient concentration in an asymptotic manner. For evaluation of trophic character, the asymptote height of the growth curve is considered a comparative value of trophic potential. However, the reaction of the culture is not necessarily identical to the reaction of the natural phytoplankton assemblage.

Periphyton. Microscopic examination of periphytic growth on glasses exposed at different reservoir depths can provide indication of the algal growth and water quality conditions at the respective depths.

Zooplankton. Water quality evaluation by analysis of species composition of biological populations has been used with great success in flowing waters, however, is not as useful in reservoirs assessments. Even in flowing waters, major differences in the composition of communities in different geographical regions makes the analysis complicated. Although plankton species occupy large geographical areas, their relationship with the environment depend on the presence and composition of fish species, which have more restricted distributions. In Europe, zooplankton size composition provides a clear water quality clue (Tab. 9.6). The presence of large *Daphnia* species in plankton is a clear indicator of phytoplankton control by zooplankton populations, and the resulting low phytoplankton biomass is favorable for the reservoir.

Tab. 9.6 The size structure of zooplankton in reservoirs with both overpopulated and balanced fish stocks.

	ANNUAL AVERAGES FOR RESERVOIRS WITH FISH STOCKS	
	BALANCED	OVERPOPULATED
Proportion of large water fleas not passing < 0.7 mm in the total biomass of zooplankton	> 20 % (15 - 40)	< 5 % (1 - 10)
Proportion of large water fleas > 0.7 mm in the biomass of water fleas	> 40 % (30 - 50)	< 15 % (1 - 20)

Toxicity tests with organisms. There are two basic types of toxicity tests and each has a specific goal: (i) short term testing to detect the degree of toxicity present in a reservoir or its inflow, and (ii) continuous monitoring of short-term and acute toxicity by use of organisms such as *Daphnia* or fishes. Often, easily cultivable species such as the aquarium fish, *Brachydanio rerio*, are used. In the U.S.A., rainbow trout *Oncorhynchus mykiss* are often used. Systems that continuously receive water from the reservoir serve as a warning if organisms within them begin to die. More

detailed observations include evaluations of the growth of *Daphnia* populations or behavior of fishes. Elaborate systems enable automatic measurements of species reactions to receiving waters.

Biomarkers. This relatively new approach enables detection of toxic effects by determination of the level of some variable in the bodies of organisms that are exposed to a toxic environment. Chronic toxicity which is very difficult to detect by using classic methods, is determined by measurement of such effects in selected organisms. These measurements may include concentrations in the blood or selected organs.

9.9 DRAWING MANAGEMENT CONCLUSIONS

After evaluation of individual water quality variables, it is necessary to draw appropriate conclusions and formulate suggestions for use in management decisions. Conclusions can be divided into the following three groups (Fig. 9.6): (i) conclusions that concern the watershed; (ii) conclusions that concern management of the reservoir, and (iii) conclusions that concern water treatment plant.

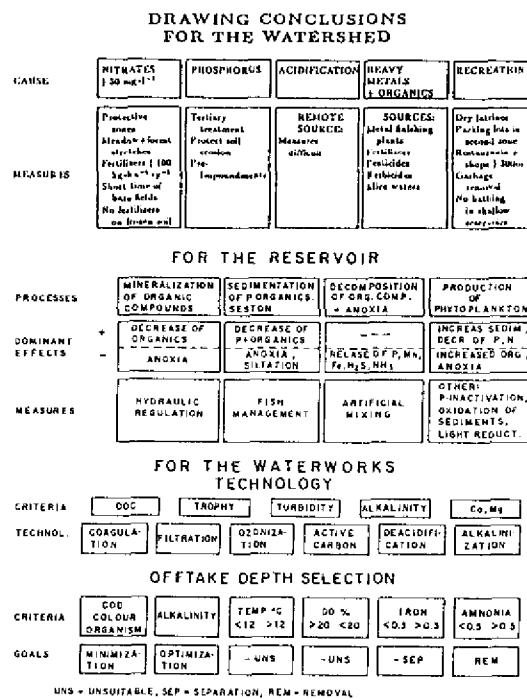

Fig. 9.6 Scheme of drawing conclusions from water quality measurements for management. Conclusions are drawn separately for the watershed, for the reservoir and in case of drinking water reservoirs also for the waterworks. A specific problem is the selection of appropriate offtakes if the reservoir possesses multilayer outlets. From Straškraba *et al.* (1993).

Conclusions that concern the watershed are based on detection and handling of pollution sources with methods provided in Chapter 10. Chapter 11 provides recommended options for improvement of water quality within the reservoir. Suggested options should always be evaluated in terms of their efficiency, possible harm to the environment and economic consideration.

In terms of design of the water treatment plant, Tab. 9.7 provides necessary criteria and appropriate technology. Principal criteria that can also be used in planning new reservoirs include the following characteristics of inflow water: (i) contents and composition of organic matter; (ii) potential development of phytoplankton as producer of autochthonous organic matter, which can exceed the allochthonous input (depending on the quantity of the critical nutrient, which is usually phosphorus); and, (iii) turbidity and mineral composition. Dissolved organic compounds are the primary problem in treating water, because suspended compounds are usually easily removed. Naturally colored substances that originate in the watershed are the easiest compounds to remove, especially macromolecular compounds.

Tab. 9.7 Tentative criteria for the design of the technology required to treat reservoir water, based on the quality of the inflow. According to Straškraba *et al.* (1993).

CRITERION	APPROXIMATE RANGE	TECHNOLOGY
Dissolved organic carbon [mg.l ⁻¹]	< 4	-
	4 - 10	coagulation + filtration
	10 - 20	coagulation + ozonation + activated carbon + adsorption + filtration
Trophic status (load of P or N less than 1 and 7 g.m ⁻² .y ⁻¹)	> 20	unsuitable drinking water production
	oligotrophic	filtration
	mesotrophic (load of P and/or N 1-2 and 7-15 g.m ⁻² .y ⁻¹)	coagulation + filtration
Non-settling colloids [as turbidity]	eutrophic (load of P and/or N more than 2 and 15 g.m ⁻² .y ⁻¹)	coagulation + ozonation + activated carbon + adsorption + filtration
	< 5	-
Alkalinity [mmol.l ⁻¹]	> 5	coagulation + filtration
	< 0.2	deacidification, or coagulation with a pre-polymerized coagulant
Contents of Ca ²⁺ Mg ²⁺ ions [mmol.l ⁻¹]	> 0.2	-
	< 0.4	alkalinization, augmentation of the contents of Ca ²⁺ and Mg ²⁺ ions
	0.4 - 5	-
	> 5	unsuitable for drinking water production

CHAPTER 10

APPROACHES AND METHODS OF WATERSHED MANAGEMENT

Types of pollution and methods of water quality management do not differ between watersheds of lakes and reservoirs. However, the intensity with which the pollution of a watershed can affect a waterbody often differs. Pollution is much more intensive in reservoirs because there is a higher watershed input to reservoirs. When similar pollutant concentrations are present in rivers, the load that reaches the reservoir is generally higher than a lake, due to the higher hydraulic load (lower retention times) of reservoirs. Nevertheless, lakes often have several small inflows and the water quality of these might be more difficult to control than that of a dominant river that enters a reservoir. A method of concentrating tertiary water treatment at the inflow (The Wahnbach method) was designed for reservoirs with one dominant inflow.

The two common types of pollution sources, point and diffuse sources, require separate methods of water quality management. The management of point sources is mainly a technical problem and is usually simpler than management of diffuse sources. Classical purification methods are broadly elaborated, however, unavailability of financial resources strongly limits their application, particularly in poor or undeveloped countries. For this reason, solutions must be shifted from the end-of the pipe methods to the initial manufacturing process. Nowadays several pollution types usually occur simultaneously, and management of these situations necessitates the use of combined approaches. Management of deleterious effluents from the watershed involves the development of ecotechnological "know-how" regarding soil types and processes, timing of agricultural and industrial activities, and drainage patterns. Table 10.1 lists some eco-technological methods that can be used to solve certain problems that arise in watersheds.

It is difficult to distinguish between management types, because one management method is often used to control several kinds of pollution and one kind of pollution may be managed by use of several methods. A typical example of this is the use of wetlands, which are effective in solving many problems. In the following discussion we have distinguished these groups of management methods: Clean production, classic organic pollution management, nutrients and eutrophication management, management of toxins, acidification management, siltation management, management of salinization, management measures at the reservoir inflow, and wetland management.

10.1 CLEAN PRODUCTION

The most important management method is usually not under the control of agencies that manage water. It is summarized as "Clean Production" (Misra 1996), and consists of making changes in the processes within a production plant, such that much less pollution results. Major advantages are inherent in this approach that can benefit the producer. Aside from saving the expense of fees imposed for creating pollution, considerable savings of energy,

Tab. 10.1 Ecotechnological methods applied to reservoir watershed management and recovery. After Straškraba *et al.* (1993), modified.

PROBLEM TO BE SOLVED	METHODS
ORGANIC POLLUTION	Clean production Diversion of effluents Purification plants Wetlands
EXCESS NUTRIENTS AND EUTROPHICATION	Diversion of wastes Tertiary treatment plants Progressive agricultural practices Meadow and riparian forest zones on the vegetated banks Natural and constructed wetlands Pre-impoundments at the inflows Wahnbach P-reduction plant
EUTROPHICATION AND OXYGEN DEPLETION OF RIVERS RESERVOIRS SILTATION	River restoration Re-oxygenation Erosion control Rehabilitation of river banks Reforestation Groundwater recharge Pre-impoundment of inflows
HEAVY METAL CONTAMINATION	Reduction of polluted effluents Wetlands
ACIDIFICATION	Liming Organic matter additions
SALINIZATION	Improved irrigation practices Decreased fertilizer applications Decreased road salting
DECREASED BIODIVERSITY DUE TO RESERVOIR CONSTRUCTION	Prohibit introduction of foreign species Reintroduction of native species Maintenance of wetlands as nursery grounds Maintenance of preserved areas for native species

water and various materials used in the production process can be obtained. As an example, the introduction of the clean production approach in fifty galvanizing plants in The Netherlands resulted in a drop of pollution to 55% of original levels during the first year and, after gaining more experience, to 37% in the second year. In two large enterprises in the Czech Republic, primary savings attained by introduction of clean production techniques amounted to 50 million Czech Crowns, an amount worthy of serious consideration by the producers. By focusing on this technology, activity shifts to the production area. Interest in this method is primarily created by the ability to save considerable amounts of money, but perhaps good will toward solving environmental problems also plays a role. Agencies that manage water must teach industry leaders to use this kind of approach and claim initiative for pollution abatement. An even wider approach analyzes the whole production process; the life cycle of a product is examined with the goal of minimizing wastes during the entire production, starting with raw material mining and following through to the decay of the final product after use (Chapter 2.5). This effort usually exceeds the capabilities of one producer and demands synchronization of efforts by several enterprises. The

environment has profited greatly in recent efforts of this kind by wise and progressive industry leaders, who are also able to increase their competitive capabilities.

10.2 ORGANIC POLLUTION MANAGEMENT

The construction of purification plants with the most modern functions and operating procedures are described in Novotny & Somlyódy (1995). For plants that already exist, upgrading is a particularly appealing prospect, i.e., increasing efficiency of the existing units and successive addition of new ones, in order to extend the plant's functions. The amount of effluents received is a decisive factor in determining the organic matter load of the effluents from the plant. Reductions in the amount of effluent produced by water savings in industry and homes results in considerable decreases. Other approaches are provided in Tab. 10.1 and are described in subsequent sections.

10.3 NUTRIENT SOURCES AND EUTROPHICATION MANAGEMENT

10.3.1 Tertiary treatment

Classic purification plants with primary and secondary treatment units are highly efficient at removing organic matter, but their ability to simultaneously decrease nutrients, particularly phosphorus content, is low. Tertiary treatment entails reduction of nutrient concentrations in plant outflow. This is primarily achieved by chemical phosphorus precipitation.

10.3.2 Agricultural practices

The following agricultural practices (Best Management Practices - BMP) are useful in reducing washout of fertilizers from fields:

- a) avoid the use of fertilizers and erosion inducing agricultural practices in a protective buffer strip surrounding the waterbody;
- b) protect riparian forests and/or create protection zones with mosaics of meadows and forests;
- c) limit use of nitrogen fertilizers to quantities that do not exceed 100 kg.(ha farmlands)⁻¹. y⁻¹;
- d) distribute fertilizers dosages primarily during periods of most rapid growth;
- e) use slow release fertilizer forms, e.g., pellets;
- f) leave natural organic matter in plowed fields to slow nitrate elution;
- g) minimize the time during which fields lack vegetation cover and use catch crops; and
- h) do not apply fertilizers to frozen soil or unvegetated or unsewn fields.

Riparian forests and vegetated protective buffers prevent surface soil particles from washing into streams and lakes/reservoirs. Nonetheless, they are unable to prevent leaching of nutrients from distant, elevated locations.

A future prospect in the effort to halt increasing nitrogen concentrations in waterbodies is the use of crops that fix nitrogen and thus need little nitrogen fertilization, as researched in Brazil.

10.4 TOXINS, HEAVY METALS, PESTICIDES AND THE LIKE

The only efficient management method for all toxins is to localize their sources and stop their distribution in the environment. This may not be easy, as some toxins are distributed by atmospheric processes over large distances. An example is the finding of increased concentrations of PCB in the Antarctic.

From the review by Foster *et al.* (1996) discussed in Chapter 6 follows for heavy metals that the most efficient method, definitely, is to stop pollution from industrial point sources. This means that they have to be located first by the analysis of sediments. The second major source appeared the urban drainage, which will be easy to disclose but much more difficult to manage. A method useful for decreasing the burden of the river with heavy metals is the passage of contaminated water through wetlands. It is clear that wetlands cannot take up heavy metals indefinitely as some saturation is inevitable, but the accumulation possibilities of vegetation seem to be for most heavy metals studied quite high.

One method that was suggested to decrease the concentration of mercury appearing in some instances in newly filled reservoirs (particularly bioaccumulated in fish) in pristine conditions is to remove the topsoil from the reservoir bottom. This is not to be recommended not only for its very high costs. First the topsoil removal highly increases the nutrient (particularly phosphorus) and organic matter load of the reservoir. Second, this natural occurrence usually lasts just for a period of few years and not to permit the consumption of fish might be a feasible solution. This is not possible in all instances, as the example of Subarctic Canada shows. The filling of Southern Indian Lake created such highly increased mercury concentrations in fish, which represent a very important diet for the local Indians.

10.5 METHODS OF ACIDIFICATION MANAGEMENT

The only sustainable management of acidification is in decreasing internationally the sulfur air pollution. In 1985 the Convention on Long-range Transboundary Air Pollution was signed requiring all signatories to reduce sulfur emissions by 30% of their 1980 levels. The Second Sulfur Protocol signed in 1994 takes the critical loads for sulfur deposition as the long-term objective, resulting in differentiated reduction needs of different countries. Countries also agreed to comply with emissions standards for new large combustion installations and to reduce the sulfur content of some fuels.

Short-term management solutions are mostly confined to one procedure - liming of the waterbodies. It is to be noted that this is a typical unsustainable curative procedure; very high amounts of lime are continuously used and cannot be supplied indefinitely.

A recently proposed management advocated that addition of nutrients or sludge (organic matter) to acidified lakes may have a positive effect. The creation of artificial eutrophication in these nutrient poor waters helps to increase pH and revert unfavorable chemical processes, thus creating positive feedback for support of aquatic life. In regions with highly eutrophic waterbodies that obtain the same amount of acid rain as highly acidified regions, no signs of acidification are

observed. This is mainly due to buffering capabilities of waters in more calcareous areas and/or regions of intensive agricultural cultivation. Fertilizers contain the necessary nutrients and minerals, and are also bound to salts and contain admixtures that further increase the buffering capacities of receptive waters. This does not just effect lake and reservoir water; the same is true for groundwater and surface streams and rivers. However, this does not hold true in low buffer regions, when only the lake is supplied with nutrients, while entering streams, groundwater and rainwater all have low buffer, low pH waters. Therefore, use of this idea as a management strategy needs further investigation and consideration.

10.6 SILTATION MANAGEMENT

Turbidity causes particularly pronounced problems in reservoirs, due to rapid filling associated with sedimentation. The lifetimes of some reservoirs that were constructed along turbid rivers are estimated to last only about 50 years, and many reservoirs constructed earlier have already ceased to function due to infilling. Turbid water is not suitable for drinking, and treatment of drinking water with high amounts of sediment (sludge) which results increases the price of treatment.

However, in eutrophic lakes and reservoirs, a positive effect may result from turbidity because decreased available light results in decreased algal production and biomass. Mineral or mixed mineral - soil particles interfere with zooplankton feeding and also provide a location for phosphorus adherence. Some soil particles have a high oxygen consumption capability, and the lake and/or reservoir can rapidly switch to anoxia, with negative consequences for water treatment (undesirable odors, increased iron and manganese). Management of turbid inflows is realized in some reservoirs by means of hydraulic regulation (Chapter 11.4). Construction of a Wahnbach-type plant at the inflow (Chapter 10.8.2) reduces inflow turbidity. This somewhat counteracts the positive effect of reduced phosphorus load which leads to decreased algal biomass because improved light conditions support algal growth.

10.7 SALINIZATION AND ITS MANAGEMENT

Salinization is not a problem that is specific to lakes and reservoirs, but includes groundwater, streams and other surface waters. It is mainly caused by soil salinization in connection with irrigation in arid and semi-arid regions, however, excessive fertilizer application in developed countries also leads to continuously increasing salt content. For example, in Czech Republic, the trend of increasing nitrate concentrations that appear to be primarily of agricultural origin is accompanied by a similar steady rise of total salts. Salty inflows change water density and subsequently affect flow and mixing conditions in lakes and/or reservoirs.

10.8 MEASURES AT THE RESERVOIR INFLOW

Two basic types of measures are in use at the reservoir inflows: (i) construction of pre-reservoirs, and (ii) the Wahnbach system of Bernhard.

10.8.1 Preimpoundments

Pre-impoundments or pre-reservoirs are relatively small reservoirs located near the reservoir inflows and elsewhere in the territory that are designed to protect the main reservoir from excessive siltation and phosphorus loading. In Chapter 4, we discussed the enormous capacity of reservoirs for phosphorus retention and the relation of this to the theoretical retention time. This knowledge was used by Benndorf and Uhlmann at the Technical University of Dresden (Germany) (Uhlmann *et al.* 1971, Benndorf 1973, Benndorf *et al.* 1975, Uhlmann *et al.* 1977) to develop detailed steps and designate necessary parameters for the construction of reservoirs designed to optimize phosphorus retention (Fig. 4.15). This method was also successfully applied in South Africa (Twinch & Grobler 1986). The most recent verification of the validity of this procedure was by Pütz (1995) who challenged the prediction of average pre-reservoir phosphorus retention efficiency as calculated using the procedure outlined in Fig. 14.2. Pütz observed excellent agreement in 11 pre-reservoirs in Saxony with different retention times. In the pre-reservoir to Eibenstock Reservoir in Germany, good agreement was also found for monthly averages during the annual cycle. In these temperate climates, phosphorus elimination was low in winter, but rose to 80% in summer (Pütz 1995). However, during detailed observations in the pre-reservoir to Kleine Kinzig Reservoir in Germany under similar climatic conditions, annual periodicity was not as pronounced and dropped to just 25 - 60% in winter. Exceptions were observed just twice during the two year study, both of which followed shortly after periods of flooding (Hoehn 1994).

10.8.2 Wahnbach plant

Bernhardt (1967) calculated the contribution of point and non-point sources in the watershed of Wahnbach Reservoir, a drinking supply reservoir in the industrial region around Bonn (Germany), and concluded that elimination of all point sources would not decrease phosphorus concentration at the inflow to a level sufficient for prevention of eutrophication. Moreover, it would be very costly to construct tertiary treatment facilities at all point sources. He concluded that the best solution was installation of a P- elimination facility directly at the reservoir inflow. This is now known as the Wahnbach procedure - an advanced facility that reduces concentrations of orthophosphate (soluble reactive) P by about 92%, and total phosphorus by more than 96%. Simultaneously, turbidity and organic matter are reduced. The resulting decrease of the chlorophyll-a content represents 95% (data given for 7 year averages). Individual processes involved in the procedure were quantified in papers by Bernhardt & Schell (1979, 1993).

10.9 DIVERSION OF EFFLUENTS

The best example of diversion of effluents occurred at Lake Washington (Washington, USA). All effluents that originally flowed into the lakes were diverted to nearby Puget Sound, which has much higher purification capacity. The success of the effort to save this lake is known worldwide (Edmondson 1991). The procedure was very costly and was only supported by citizens after informative campaigns by Edmondson and his group. The lake is almost entirely urban, surrounded by inhabitants on all shores. On a smaller scale, partial diversions have been implemented in other places. In some cases, it is appropriate to divert the effluents of shore facilities to the outflow, particularly if the facilities located are close to the dam or when effluents

enter drinking supply reservoirs.

10.10 WETLAND MANAGEMENT

It is apparent from the many values of wetlands provided in Tab. 10.1 that the purification capacity of wetlands is multifaceted. They function to trap silt, organic pollution, nutrients and toxic compounds. These functions were first recognized in natural wetlands and were used to create conditions that optimize these functions. Nowadays, at least two basic types of wetlands can be distinguished: natural, near-natural or restored wetlands such as the reedbed sewage treatment wetland depicted in Fig. 10.1 (lower part), and constructed wetlands such as the root-zone sewage treatment wetland shown in the upper part of Fig. 10.1. These differ in their degree

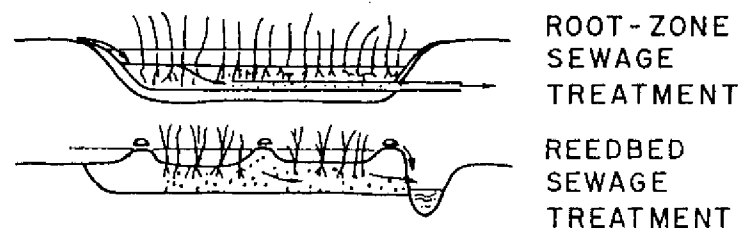

Fig. 10.1 Representatives of the two basic types of wetlands. According to Klapper (1993).

of artificiality. While the first group simulates natural wetlands, the second is an ecotechnological construct specifically intended for selected functions. This distinction is also valid for wetlands created artificially; they are designed either to recreate natural (extensive) function of wetlands in a territory, usually in places where wetlands were once common, or they are structures designed to maximize vegetative uptake of certain effluents. In the first case, usually only conditions for water retention and natural plant growth are created. We will call these recreated wetlands, although the activity is not necessarily limited to places where natural wetlands once existed. Constructed wetlands, the latter type, are much more technically complex, with mechanical pretreatment of inflow, layering of substrates with special qualities, systems of tubing for regular distribution of polluted water, regulation of flow into different wetland units, and distribution of polluted water to certain substrate layers, etc.

In the USA, wetland protection is legislatively regulated, and in many cases, wetlands that are impacted by development must be mitigated by creation of compensatory wetlands in the same ecoregion. It is required that these mitigative wetlands serve the same functions and values of the lost wetlands.

An example of a large recreated wetland is the Kis-Balaton Reservoir in Hungary. It occupies a 70 km² area of territory that was covered by wetland in ancient times, and was designed to decrease eutrophication in Lake Balaton (A = 596 km²), which is a tourist resort that is economically important for the country (Szilágyi *et al.* 1990). Since construction of Kis-Balaton

Reservoir, the situation in Lake Balaton has improved markedly. In the USA, wetlands are often recreated, e.g., in Ohio in conjunction with research activities directed by Prof. Mitsch of the University of Ohio, Columbus. An experimental wetland is under construction in Italy on the River Po, with goals of recreating floodplain wetlands along the river (Prof. Bendricchio of the University of Padua). In a natural wetland, both terrestrial and aquatic components are often represented. These may be quite diverse and include meadows and cultivated fields, forests and swamps, shallow and open water and regions overgrown by emergent, submerged and floating vegetation, all of which may be tightly interwoven. These wetlands are bird-sanctuaries, and provide habitat for all kinds of aquatic life. Many species that are otherwise terrestrial require wetlands for reproduction. The landscape function of such areas for recreation, bird-watching, or simply aesthetic beauty is an additional value.

The most common type of created wetlands are those created for primary purification of effluents from villages or for secondary purification of effluents from larger communities. An area of 50-500 m² is sufficient to significantly decrease the organic and nutrient content of the effluent from a village populated by about 100 inhabitants (Žáková 1906, Magmedov 1996). The usual concern in the temperate region is that a created wetland will not function in winter when most vegetation has senesced, however, this is not supported by observations: it is evident that the roots of plants are the most active part in the purification process, and continue to function in winter months. Useful summaries of the use of constructed wetlands for water quality improvement are found in Anonymous (1988), Hammer (1989), Fisk (1989) and Moshiri (1993).

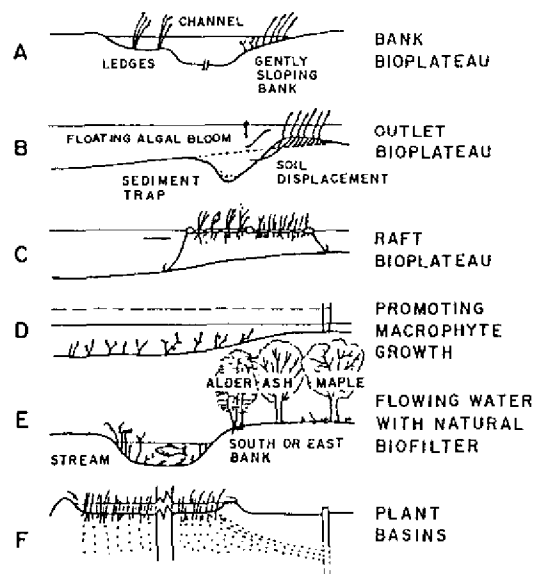

Fig. 10.2 Different methods of the use of aquatic and terrestrial vegetation for water quality protection in rivers. According to Klapper (1993).

10.11 MANAGEMENT OF STREAMSIDE VEGETATION FOR WATER QUALITY PROTECTION

Vegetation is not only useful in the uptake of aquatic pollution in wetlands, but is also effective within and beside rivers. Vegetation that serves this purpose can be cultivated in different ways, ranging from maintenance of near-natural aquatic and bank vegetation (Fig. 10.2, parts D and F) to elaborate cultivated plantings. Fig. 10.2 depicts these different scenarios. In part A, the creation of bank bioplateaus was accomplished by using overgrown, shallow off-channel areas or created channel margins for intensive planting or support of naturally colonized vegetation. When vegetation is planted, isolated clumps of plants (left) can develop into a continuously vegetated margin in just a few years (right). This, of course, requires areas of low pollution, because normal growth will not be observed in highly polluted or turbid waters. Good conditions for development of riparian and emergent vegetation exist when water-levels are kept nearly constant and/or there is reduced flow within these plateaus for at least a significant part of the year. In part B of Fig. 10.2, an outlet bioplateau is depicted. These are used in areas of outflow from deeper river portions or nearby ponds. The displaced soil forms a sediment trap on the inlet side of the bioplateau and this soil accumulation represents additional area for vegetation. The vegetation functions as a pollution filter. In deeper rivers, the creation of raft bioplateaus is very effective in reducing pollution (part C). Part D illustrates a means of supporting plant growth by lowering the water level during spring. This serves to efficiently retain dissolved and suspended nutrients and harmful substances. The natural biofilter illustrated in part E also serves to shade the stream by supporting trees. Vegetated basins beside the river with groundwater flow between the bank and the stream (shown in part F) are more or less equivalent to the creation of small wetlands in suitable places along the river.

10.12 SUMMARY OF WATERSHED MANAGEMENT TECHNIQUES

All of the described consequences of improper watershed uses result in reservoir deterioration and severe economic losses. As previously mentioned in this book, it is much more complex and costly to remedy a problem than to prevent it. In order to improve preventive capabilities and provide adequate management approaches, the following measures should be taken:

- a) Good agricultural practices should be designed to slow erosion and silt input into reservoirs. Decreased uses of pesticides and herbicides and strict control of toxic substances should be required. Fertilizers should be applied in ways that maximize their utilization by plants and, thus, prevent introduction to water.
- b) Sewage should be treated by traditional or new (ecotechnological) methods. Tertiary treatment should be used to reduce phosphorus loads.
- c) Strict control of industrial effluents should be enforced, in particular by encouraging industry to use clean technology.
- d) The utilization of in-lake management techniques should be mastered, particularly inexpensive ecotechnological techniques.
- e) Foster water savings and environmental management that increases the water retention capacity of the watershed (and also pollution).
- f) Conduct continuous surveys and monitor the system, including satellite surveillance.

- g) Provide permanent training of technicians that operate reservoirs, which will enable optimal water quantity and quality management.
- h) Foster continuous interaction between planners, managers and scientists in order to address changes and update planning and management strategies.
- i) Develop partnerships in public and private sectors in order to improve watershed management strategies.
- j) Initiate awareness campaigns and community involvement to produce cultural changes and improve attitudes regarding environmental issues.
- k) Encourage environmental education of school children in the value of the watershed.

Application of these basic principles of watershed management are fundamental in the success of the endeavor to improve the current situation:

- a) Take steps to protect and improve spatial heterogeneity by ensuring the existence of riparian forests and natural vegetative mosaics. An important element in ensuring qualitative and quantitative forest recovery is the planting of native tree species rather than quick-growing non-native species. Riparian forests are capable of functioning as a 'biological filter', which can remove phosphorus and nitrogen from the inflows and retain suspended materials, thus decreasing reservoir inputs.
- b) Take steps to maintain, protect and encourage the recovery of natural wetlands so that biological diversity is enhanced and denitrification is encouraged. Wetland areas near the reservoir and within the watershed provide significant buffer zones in the land/water ecotone and serve as a native aquatic species reserve which can provide seeds for use in colonization of the reservoir. Wetlands are epicenters for re-colonization of reservoir biota.
- c) All point sources of nutrient pollution must be treated, even if the use of pre-impoundments is necessary to accomplish this task.
- d) Take steps to avoid the input from non-point sources of sediment, dissolved nutrient salts and any toxic compounds. This may involve: (i) changing agricultural practices within the watershed (what crops are grown; the nature and manner of fertilizer application, i.e., when and how applied), and/or (ii) protection of the reservoir shoreline with vegetation such as trees that are able to withstand flooding or floating, submergent and emergent macrophytes.
- e) Take steps to avoid sediment input by construction of pre-impoundments along main river courses. A reservoir-specific protection procedure is the Wahnbach-type phosphorus elimination facility placed at the reservoir inflow (Bernhardt & Schell 1979).

CHAPTER 11

IN-LAKE ECOTECHNOLOGICAL MANAGEMENT

Many techniques are available for improvement of water quality within the body of the reservoir. These are listed in Tab. 11.1 and discussed in detail within this chapter.

Tab. 11.1 Management techniques for improving water quality within the reservoir water body.

MEASURE	MEANS	REFERENCES
ARTIFICIAL MIXING AND OXYGENATION	1. Destratification 2. Hypolimnetic aeration 3. Epilimnetic mixing 4. Metalimnetic mixing 5. Layer aeration 6. Speece cone 7. Propeller mixing	Symons <i>et al.</i> 1967 Bernhardt 1967 Straškraba 1986 Stefan <i>et al.</i> 1987 Kortmaa <i>et al.</i> 1994 Speece <i>et al.</i> 1982 Fay 1994
SEDIMENT REMOVAL	Dredging the sediments	Bjork 1994
SEDIMENT AERATION	Sediment injection	Ripl 1976
SEDIMENT COVERING	Covering sediments with inert matter	Peterson 1982
PHOSPHORUS INACTIVATION	Alum precipitation	Cooke & Kennedy 1988
BIOMANIPULATION (FISH MANAGEMENT)	Zooplankton control - -phytoplankton reduction	Gulati <i>et al.</i> 1990
HYDRAULIC REGULATION	1. Selective offtake and withdrawal 2. Hypolimnion siphoning 3. Curtains	Straškraba 1986 Olszewski 1967
ALGICIDES	1. Copper poisoning 2. Other algicides	
LIGHT REDUCTION	Shading, covering, suspensions, colors	Jørgensen 1980
MACROPHYTE CONTROL	1. Harvest 2. Phytophagous fish 3. Natural enemies	

11.1 MIXING AND OXYGENATION

The aim of artificial mixing procedures is oxidation of either a deoxygenated hypolimnion or the entire waterbody and/or inhibition of phytoplankton growth. Figure 11.1 illustrates these four basic mixing types: - destratification by mixing of the entire water column; re-aeration of the hypolimnion; "epilimnetic" mixing; and, the layer aeration. Additionally, a specific metalimnetic aeration device was designed by Stefan *et al.* (1987) which oxygenates the metalimnion without disturbing the hypolimnion or the epilimnion. Oxygenation without mixing is achieved by the use of the Speece cone.

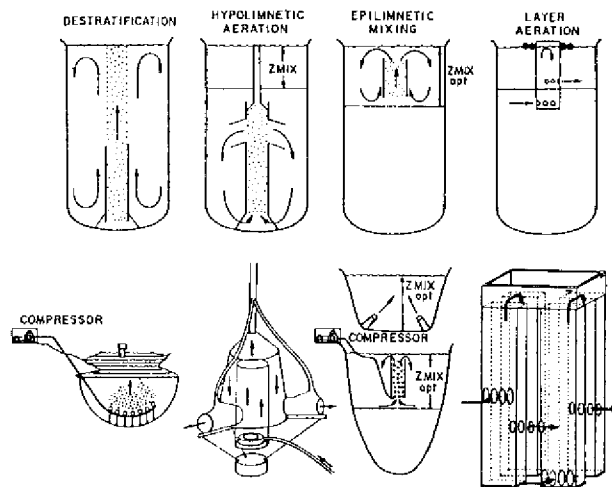

Fig. 11.1 Four basic types of mixing. The top row shows schematically the mixing, the bottom row the actual arrangements. The hypolimnetic aerator is represented by the LIMNO partial air-lift hypolimnetic aerator of the firma Aqua Techniques.

11.1.1 Destratification - artificial circulation

Destratification is accomplished by injection of compressed air from a diffuser into water at a reservoir bottom (Fig. 11.2A). These three goals are simultaneously sought:

- a) destratification to prevent algae from remaining in the illuminated layer and causing a decrease in phytoplankton biomass formation;
- b) circulation to decrease pH and cause a shift from blue-greens to less noxious green algae; and
- c) aeration to oxidize the hypolimnion and consequently seal the bottom to prevent release of phosphorus, iron and manganese.

Some of the complex consequences of destratification on aquatic ecosystems are shown in Fig. 11.2B. This complexity is one reason that success is difficult to achieve. Although destratification is often considered a standard method, that can be accomplished by a mechanical engineer, knowledge of limnological processes is obviously necessary.

Undesirable consequences may result in some cases. For example during the process of admixing, water from the hypolimnion may be brought to the surface and consequently result in higher phosphorus levels and increased algal growth. Early examples of practical use of destratification are summarized by Pastorok *et al.* (1981) who reported that from out of 40 relatively full destratification attempts there was a significant change in biomass in 65 of the cases, of which 70% underwent a biomass decrease and 30% experienced an increase and were accompanied by changes in species composition. Figure 11.2C illustrates a model investigation, suggesting that insufficient mixing can have extremely negative effects. Therefore, successful application of destratification requires adherence to rules designated by Lorenzen & Mitchel (1973) and

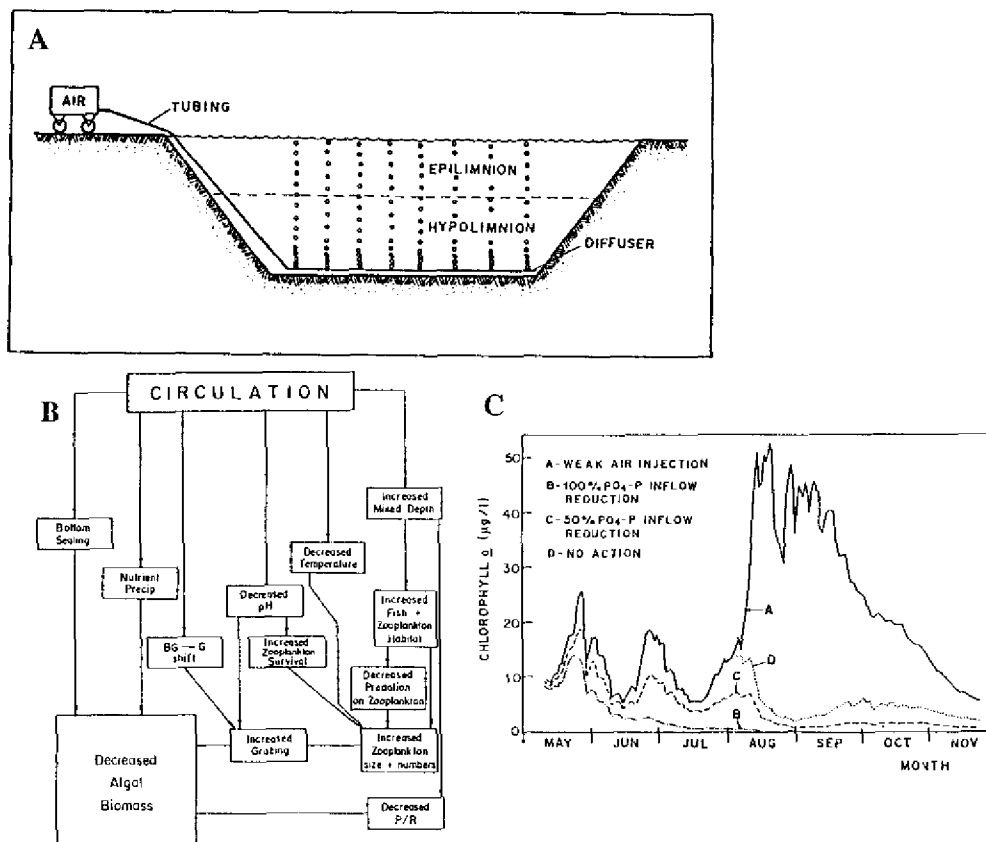

Fig. 11.2 Destratification and its consequences. A - Destratification with a compressor and diffuser, B - Consequences of circulation for water quality according to Pastorok *et al.* (1981), C - Model investigation by Stefan and Hanson (1980) showing the chlorophyll-a concentrations following different intensity of mixing (directed by the intensity of air injection) and different degree of simultaneous inflow phosphorus reduction. Note that weak mixing may produce much more harm than profit.

Schladow (1993). An air flow of oxygen has to surpass $0.09 \text{ m}^3 \cdot \text{ha}^{-1}$, otherwise the mixing is inactive. Detailed model studies by Schladow (1993) determined the realistic shape of rising plumes and allowed calculation of the necessary forces that will efficiently circulate the entire column. If these rules are not obeyed, water quality may become degraded rather than improved. In a wilderness region in Australia, solar panels were used to drive the compressor for a small reservoir instead of disturbing the environment by construction of an electrical line. Steinberg & Zimmermann (1988) applied destratification method intermittently to cope with the growth and loss-rate responses of different algal species, thus the biomass of Cyanobacteria as well as other algal species has minimized. This approach is based on theoretical development (Reynolds *et al.* 1984) and requires that personnel are knowledgeable about phytoplankton and linnology.

The advantages of destratification, in compliance with the conditions given by Lorenzen & Mitchel (1973) and Schladow (1993), are as follows: (i) hypolimnetic oxygen increases; (ii) there is no phosphorus release from the sediments; (iii) the amounts of iron and manganese remain low or absent; and, (iv) the amount of algae decreases. Negative environmental impacts were documented by Fast & Hulquist (1982) when compressed air caused supersaturation of dissolved nitrogen and resulted in downstream fish kills. Cost of the procedure is low, and is limited to the price of the compressor and corresponding energy demands and the installation cost of the pipe and diffuser.

11.1.2 Hypolimnetic aeration

Several types of commercial aerators are now available that can aerate the hypolimnion without destroying the thermocline (Bernhardt 1967, Anonymus 1989). One type of hypolimnetic aerator is outlined in Fig. 11.3.

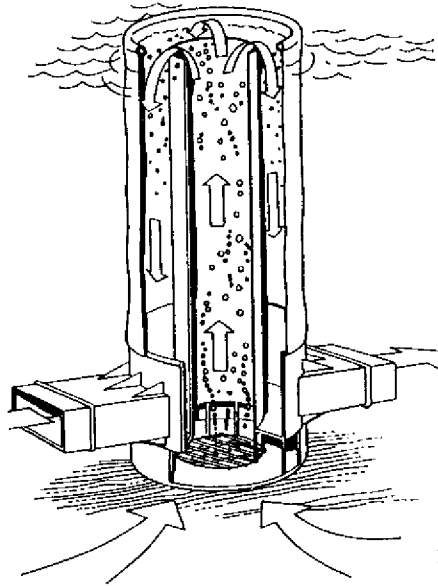

Fig. 11.3 One type of hypolimnetic aerator.

The advantage of this procedure is that aeration is accomplished without transferring concentrations of elements from the hypolimnion to the epilimnion, thus, algae growth is not enhanced. Improved oxygen conditions in the hypolimnion permit cultivation of sensitive fish, improve water quality by decreasing iron, manganese, and taste and odor problems in drinking water supply, reduce damage by corrosion to turbines and other structures and improve downstream water quality. This type of aeration is appropriate as a corrective technique in cases of high hypolimnetic oxygen deficits, but is not applicable for shallow lakes or narrow nearbottom anoxic layers. Possible negative environmental impacts may be inflicted upon pristine areas during transportation and installation of large equipment and by installation and use of electricity. The investment cost in this technique is much higher than destratification because of specialized equipment requirements. The operating costs depends on the area of hypolimnion to

be treated, rate of oxygen consumption in the reservoir and degree of thermal stratification. These costs can be estimated by a method devised by Cooke *et al.* (1993).

11.1.3 Epilimnetic mixing

This method is strongly recommended because, as opposed to other mixing methods that consist of corrective actions, epilimnetic mixing seeks to prevent or reduce the formation of phytoplanktonic biomass. Using this method, surface water layers are mixed to an "optimum depth", $z_{mix,opt}$. The "optimum depth" is the mixing depth that results under given light conditions in phytoplankton column respiration which is identical with phytoplankton production. Some "impoundments" have been constructed with a depth that corresponds to $z_{mix,opt}$; in this case the entire reservoir is mixed. This principle is illustrated in Fig. 4.6 and described in the discussion of depth distribution of light and mixing in waterbodies. Under natural conditions, photosynthesis integrated over the water column (striped area) exceeds respiration integrated over the mixed column (shaded area). When mixing reaches the depth $z_{mix,opt}$, production drops, because the biomass is mixed to deeper strata and obtains less average light (dotted area). At this mixing depth the respiration is higher and is equal to production (shaded area = striped area). The method of calculating $z_{mix,opt}$ is given in Steel *et al.* (1978). Two types of mixing systems are currently in use: some systems use compression units that discharge air bubbles through diffusers as described in destratification methods above (Symons *et al.* 1967) and are located at the $z_{mix,opt}$ depth, and others physically transport water by the use of pumps (Cooley & Harris 1954, Ridley *et al.* 1966 - successful application in London reservoirs).

Some of the many advantages of epilimnetic mixing include the following: (i) algal crops remain low, even during highly eutrophic conditions; and, (ii) impoundments constructed according to $z_{mix,opt}$ prevent the formation of a mid-summer hypolimnion and resulting deoxygenation and release of nutrients from the sediments. No negative environmental impacts are evident, but if the technology fails, rapid growth of algae follows. Treatment of raw eutrophic riverine water is accomplished with overall costs that are greatly reduced.

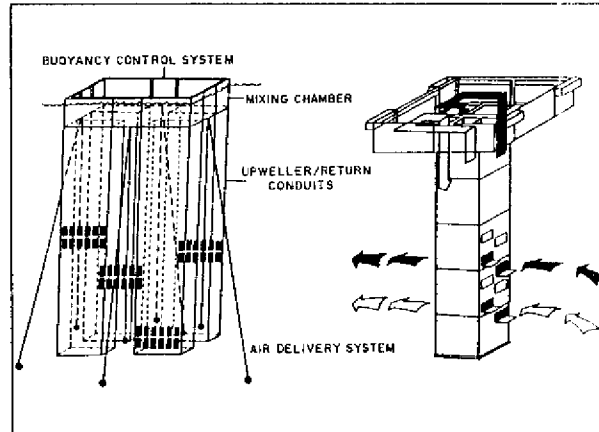

Fig. 11.4 Two possible types of layer aeration according to Kortman *et al.* (1988).

11.1.4 Layer aeration

This is a new approach that is based on detailed knowledge of stratification conditions in a given waterbody and the consequences of these in terms of water quality (Kortman *et al.* 1988). Under this strategy, heat and oxygen in a stratified reservoir are redistributed into discrete layers. Manipulation of the thermal structure can create desirable physical and chemical (in particular oxygen) conditions. In this way the negative effects previously mentioned that often accompany destratification are avoided. Detailed limnological knowledge is necessary for successful implementation of this method. A special device is used to take water by air lifting from a desired depth by air lifting and release it at another depth (Fig. 11.4). The device is now commercially available from Ecosystem Consulting Service, Ltd. (1995).

11.1.5 Speece cone

Speece cone (Speece *et al.* 1982, Speece 1994) is a highly technical device designed to oxygenate water with little mixing. The device works by releasing water supersaturated with oxygen into the reservoir hypolimnion by means of diffusers.

Fig. 11.5 is an illustration of the procedure. Kennedy *et al.* 1995 report the investment costs for a large reservoir (volume $1.29 \cdot 10^9 \text{ m}^3$) are approximately 5 million US\$ and operating costs are about 800,000 US\$.

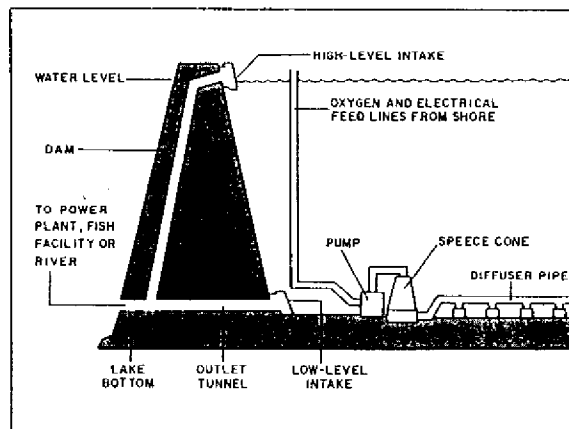

Fig. 11.5 The Speece cone for reservoir oxygenation with oxygen supersaturated water.

11.1.6 Propeller mixing and oxygenation

Propeller mixing and oxygenation is a system that differs from all previously discussed methods in the manner in which mixing is accomplished. The others are based on mixing accomplished by raising air bubbles from below. This method entails mixing from above by use of a propeller. The propeller is attached to the bottom of a pontoon and can be used in many different applications. It is combined with a compressor that jets bubbles into the propeller region so that the surface layer becomes oxygenated. Technical specifications are given in Fay (1994). No information is available at the present time regarding results achieved with the use of this device.

11.2 METHODS OF TREATING SEDIMENTS

Sediments accumulate phosphorus over long periods of time and the resulting concentration of phosphorus in the upper few millimeters of the sediment can be much greater than the phosphorus content in the entire water column. The dissolved fraction of this large phosphorus store is constantly exchanged with the adjacent water. The dominant direction of exchange depends on, among other things, the differences in concentrations at the water - sediment boundary and on oxygen and redox conditions at the sediment surface. When water is deprived of phosphorus, e.g., by reduction in the reservoir load, phosphorus is released from the sediment to the water. Because of the large phosphorus storage in the sediments, eutrophic conditions may continue for several years after phosphorus supply to the reservoir is considerably reduced. Anoxia at the bottom is a condition that can enhance this exchange by a factor of 10 or more. Various procedures are used to decrease the release of phosphorus from the sediments. Methods that increase the near-bottom oxygen concentrations were discussed in section 11.1. Additionally, upper layers of sediment can be removed from the reservoir, sediment can be oxygenated by elaborate chemically based procedure and/or mechanical barriers can be used to terminate the transport of phosphorus in the sediments to water.

11.2.1 Sediment removal

This method consists of removing the upper layers of sediment that contain high phosphorus levels. Methods of sediment removal and their respective cost-effectiveness were reviewed by Peterson (1982). Several types of dredging equipment are used (Fig. 11.6). The sediment must be transported to a disposal area as a slurry containing 80-90 percent water. A mathematical model by Stefan & Hanson (1980) can be used to predict dredging depth to minimize internal nutrient recycling in shallow lakes.

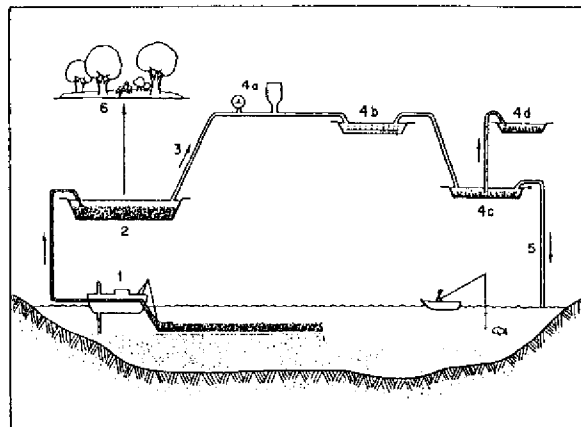

Fig. 11.6 Schematic representation of sediment removal. 1 - The bottom mud suction dredger, 2 - Settling pond for sediment drying up, 3 - run-off water to the aluminum sulphate automatic dosing instrument 4a and its aeration basin 4b. The overlying water is returned from the sedimentation basin 4c to the lake through tube 5, while the dried treated sediment is used as fertilizer in agriculture. Redrawn from Eiseltová (1994).

The advantage of this method is that the results are long-lasting. In Lake Trummen in Sweden, P concentration dropped from peaks as high as $900 \mu\text{g.l}^{-1}$ to a level less than $10 \mu\text{g}$ and remained that low for the whole period of observations, which extended more than 9 years. Negative impacts include the extensive area needed to store dredged slurry while it is drying and before it can be used as fertilizer (under the condition of low heavy metal contents) or be otherwise disposed. The cost of dredging is high; the estimate given by Peterson (1981) is between 0.23 and 15.3 US\$ per m^2 for dredging, assuming that 1 meter of sediments need to be removed only for dredging, not including disposal and transport costs.

11.2.2 Sediment aeration and oxidation

Until the present time, the RIPLOX method of sediment aeration and oxidation (Fig. 11.7) has only been used in Scandinavia and Germany (Ripl 1994). The goal of this method is to decrease phosphorus release from sediments. Ferric chloride is applied to the sediments that are low in iron to decrease phosphorus release. Simultaneously, lime is added to create a pH level that is optimum for denitrification ($7.0 < \text{pH} < 7.5$). Consequently, calcium nitrate is injected into the top 30 cm of sediments to oxidize and break down organic matter and denitrify the sediments. The procedure must be specifically adapted for each application in accordance with existing chemical conditions in the sediments.

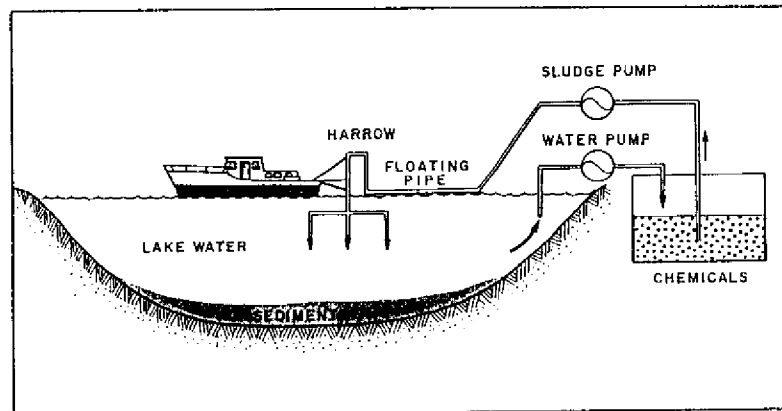

Fig. 11.7 The RIPLOX procedure of Ripl. The harrow reaching the sediment, located on a boat, injects the chemicals into the sediment. The diluted chemicals are pumped by a sludge pump via a floating pipe to the boat. Redrawn from Eiseltoová (1994).

The advantage of this method is that no large space is required as described for sediment removal. The major limitation is that injection requires special equipment that can only be used on flat and shallow bottoms. The costs of this procedure in a very shallow Swedish lake (mean depth ~2m) was 112,000 US\$ (1995 prices), most of which was spent on development of the equipment. The cost of chemicals used amounted to 1,650\$. As opposed to mixing devices, the

equipment is appropriate for other uses and, thus, increases overall cost effectiveness of this procedure.

11.2.3 Sediment capping

An alternative to sediment aeration and oxidation that is less expensive is capping the sediments with foil, raw ash, crushed bricks, sand or other inert materials. A review of the properties, costs and effectiveness of materials often used in sediment capping is contained in Cooke *et al.* (1993).

11.2.4 In-lake phosphorus inactivation

Spreading $AlSO_4$ over the lake surface is a procedure used to precipitate phosphorus from the lake and seal the bottom against phosphorus release. Alum form gelatinous flocks that sorb dissolved phosphorus. Flocks accumulate on the bottom and sorb phosphorus that leaches out of sediments. Experience has shown that chemical coagulation of phosphorus is highly effective in lakes and reservoirs for at least several years (usually 4-5, sometimes up to 14 years - Cooke *et al.* 1993). Long term positive effects have not been observed after treatment with Ca or Fe, which are theoretical substitutes for Al. No special equipment was used in most instances (Cooke *et al.* 1986). Quak *et al.* (1993) developed a technology using heavy machinery. Calculation models by Kennedy & Cooke (1982) and Kennedy *et al.* (1987) are used to determine the necessary dose of alum for a given lake. The reservoir CHA-TP models presented in Chapter 14 can be used to estimate chlorophyll-a levels at a given phosphorus concentration that is reached by the treatment.

The advantage of this method is that no special equipment is needed, and the effect is long lasting. Limitations are that use of this method is not feasible in waterbodies that are overgrown by macrophytes, waterbodies with intensive resuspension or in waterbodies with low pH. In reservoirs that have retention times shorter than one year, this management method is suitable for use only if the phosphorus load is low. This is because when phosphorus load is high, the capacity of alum flocks to bind phosphorus is rapidly exhausted. Phosphate phosphorus is removed more efficiently than organic fractions, and dissolved organic phosphorus is removed less efficiently than particle bound phosphorus. Possible negative environmental impacts can occur in connection with toxicity of aluminum at pH less than 6. Concentrations below $50 \mu g.l^{-1}$ Al in the lake water are not considered harmful to organisms. Bioaccumulation of Al in fish occurs when Al concentrations are high. Accumulation in plants can result in reduced ability for uptake by the roots. The cost of this method varies in dependence on the concentration needed and manpower cost.

11.3 BIOMANIPULATION

The theoretical basis for 'biomanipulation' a term coined by Shapiro *et al.* (1975), was already established during the 1960's by Hrbáček *et al.* (1961). The principle of the method is food chain manipulation by maintaining low feeding pressure on zooplankton by fish, so that large species of zooplankton predominate, that are capable to keep phytoplankton under control. This is accomplished when the number of zooplankton feeding fish is low. In reservoirs with stunted, overcrowded fish populations these fishes grow very slowly, but, due to their high numbers and small size (small animals have relatively greater food requirements), decimate large zooplankton

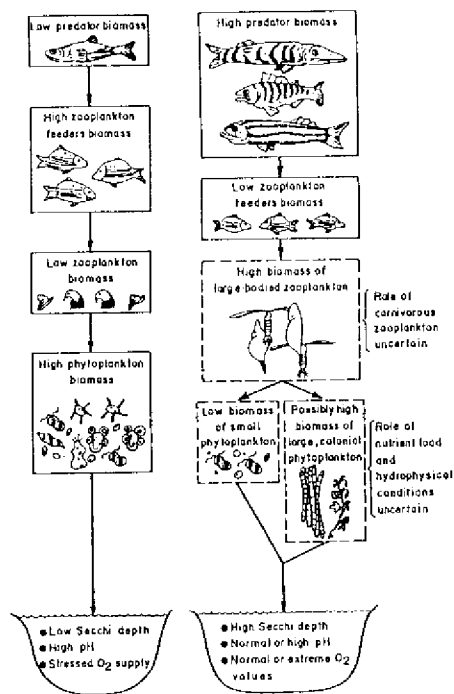

Fig. 11.8 Schematic representation of biomanipulation. The left part shows the consequence of low predatory fish biomass and excessive zooplankton feeding fish biomass on the composition of zooplankton and phytoplankton and consequently low transparency, high pH and low hypolimnetic oxygen concentrations. The right part shows the consequence of increasing the predator biomass and decreasing the biomass of zooplankton feeders on decreasing the phytoplankton biomass and consequently high transparency, lower pH and sufficient oxygen in the hypolimnion. One danger is in the possibility of switching of the system to large algae (in deep waters) or macrophytes (in shallow waters). Redrawn from Benndorf *et al.* (1984).

species. Small zooplankton species are unable to control the algae (Fig. 11.8).

Development of fish populations that lead to control of zooplankton and phytoplankton can be achieved by the following three ways:

- temporary eradication of stunted fish populations by using rotenone poisoning and predator stocking (rotenone is not toxic for invertebrates and phytoplankton - Stenson *et al.* 1978);
- continuous introduction of predatory fish and net-harvesting of non-predatory fish; collaboration with local sport fishery and use of commercial fishery methods is needed; and,
- reservoir drawdowns during reproduction periods of undesirable fish species by exposing eggs on shore vegetation.

Winter fish kills in reservoirs that freeze may also cause modifications of species composition.

Recent reviews of all aspects of biomanipulation (Gulati *et al.* 1990, DeBernardi & Guissani 1995, Shapiro 1995) show that this method is only successful under certain circumstances. A thorough evaluation of biomanipulation experiments published prior to 1992 (22 whole lake experiments and 10 enclosure experiments, with one exception all were performed in the wet region of north temperate zone) is summarized as follows:

1) Success, measured by decreased phytoplankton biomass, was achieved in 2/3 of the 25 observations, whereas in 28% the results were ambiguous and, undesirable results were obtained only in two cases.

2) When phosphorus concentrations were very high, no successes were observed. Therefore, in very eutrophic waterbodies, it is necessary to combine biomanipulation with nutrient reduction by using other methods.

3) Success is generally more pronounced in shallow and small water bodies, more specifically because control of fish populations is easier under such conditions.

4) A shallow waterbody or shallows of deeper waterbodies may switch to a macrophyte dominated state and it is to be decided which consequences this has for the respective use of the water body.

5) Creation and stabilization of a strong population of piscivorous, predatory fish population is difficult and time consuming, unless achieved by commercial net fisheries. The use of rotenone poisoning is often required to start the conversion.

6) The extent of planktivorous fish that must be removed depends considerably upon the species and size composition of the fish community.

7) Due to very different organism turnover times, a stable new equilibrium may require several years to develop. However, this is also true for other eutrophication processes.

8) Biomanipulation procedures cannot be considered a routine method because use of this method depends on a number of special circumstances and can only be performed with the participation of skilled limnologists.

9) Criteria for successful application of biomanipulation must be based upon local and waterbody type specifics.

Applications of biomanipulation techniques are more complicated in subtropics and tropics due to high fish diversity, vast differences in species composition between sites, presence of omnivorous fish, and more complicated food chains. For information about application in reservoirs of the southern part of United States see Stein *et al.* (1995). Successful applications and experiments were reported with use of the grass carp *Hypophthalmichthys molitrix* which feeds directly on large colonies of phytoplankton and macrophytes, in Israel (Leventer & Teltsch 1990) and Brazil (Starling 1993). However, as is true of all other fish introductions, care should be taken before introduction of foreign species. In Israel, the introduction of grass carp affected populations of other species (Gophen 1995). The first experimental results from tropics have begun to appear (e.g., Arcifa *et al.* 1986, Roche *et al.* 1993), but more knowledge of the food webs is necessary.

The advantage of this method, aside from the very low cost, is that it is fully natural, with no chemicals or machinery required; the only means used is manpower. This method also combines the requirements of fisheries with that of water quality, however, education of sport fishermen is required. The limitation is the required continuous control of fish populations, which tend to return to stunted populations, not by natural forces, but because of sport fisheries selectively removing predatory rather than zooplankton feeding fish. This method has no potential negative environmental impacts if performed without rotenone poisoning. Rotenone poisoning is undesirable in drinking water reservoirs and may result in kills of rare or endangered species. The cost depends on the way the method is performed. Costs are low if combined with organized

fisheries efforts but increase when these efforts are not combined. The cost of rotenone is high.

11.4 HYDRAULIC REGULATION

The goal of hydraulic regulation is selection and release of bad quality layers from the reservoir without considerable admixing with other layers or selection of good quality layers for consumption. This can be most easily accomplished by multiple outlets, if present. Thus, water with a high concentration of unwanted substances (phosphorus, toxins, radioactivity) can rapidly pass through the reservoir. The use of plastic curtains can also be useful in regulating mixing at the reservoir inflow.

11.4.1 Use of selective oftakes

'Dilution as a solution to pollution' is a useful technique in lakes and reservoirs (Welch & Patmont 1980) when sufficient water with low phosphorus and algae is available. A decrease of retention time to 10 or 5 days resulted in dramatic improvement in algal blooms in the successful case of Moses Lake, Washington. Because of high water volume and water quality demands, this method is rarely realized in the entire reservoir, rather it is best performed on selected layers. Figure 11.9 presents several possibilities and indicates the probable positive and negative effects of each alternative. Flushing of either the epilimnion or hypolimnion will depend on the goal: whether a decrease in algal mass or flushing of a deoxygenated hypolimnion with high nutrients and/or other troubleshooting ingredients is desired. The use of bottom outlets that removed hypolimnetic water and sediment proved to be a useful method in some South American reservoirs. Another possibility is the use of a shortcut current to pass nutrient or accidentally polluted inflow through the reservoir as rapidly as possible and with the least possible mixing with other layers. The cheapest way to improve the quality of oftakes for consumption involves hydraulic regulation by choosing the best timing and depth of outflow.

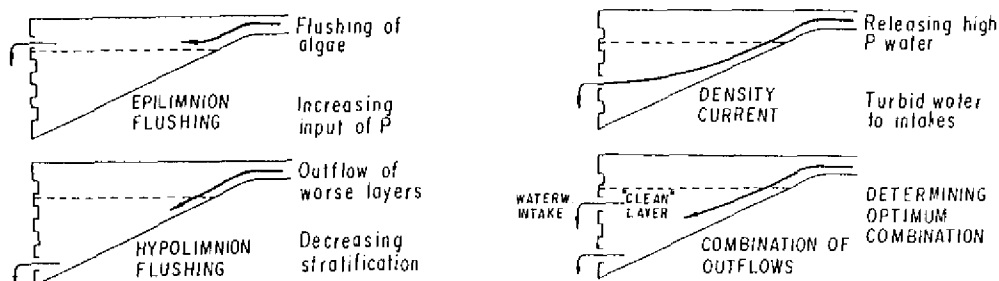

Fig. 11.9 Function of the selective oftakes. For each use the text on the right indicates in the top row the advantages and in the bottom row the possible negative effects. From above: Withdrawal through the surface outlet is used for flushing of excessive algae. Simultaneously, the phosphorus input to the surface layer increases. Hypolimnion flushing is used to release oxygenless and iron, manganese and phosphorus rich hypolimnetic waters. Simultaneously, stratification is decreased. By creating density currents a peak of phosphorus or pollution rich water (e.g., during floods) can rapidly pass the reservoir. Simultaneously, turbid layers may reach the raw drinking-water intakes.

Several scenarios are possible provided the limnological situation of the reservoir is well understood. A simple, but rarely adopted, precaution is to ensure, during the planning stage, that the reservoir possesses a multiple outlet structure with the outlet pipes spaced vertically at about 5m intervals. A minimum provision is to include a surface and a bottom water discharge. Much better control is afforded by reservoirs with multiple offtake horizons so that good quality water can always be abstracted by selecting the appropriate outlet depth in relation to thermal stratification.

The greatest advantage of this method is the negligible cost. The limitations include the required knowledge of inflow water quality and depth distribution within the reservoir. Dynamic changes in the quality of a specific water layer can take place when the inflow rate and outflow rate and elevation of offtake are changed and these are not easily understood unless hydrodynamic models such as the ones discussed in Chapter 14 are used. For some purposes, such as flushing the hypolimnion, the supply of water can be limiting. Conflicts between different uses can also be a hindering factor. Possible negative downstream impacts caused by releases must be considered.

11.4.2 Hypolimnion siphoning

This simple method of eliminating accumulated phosphorus, iron and manganese in the anoxic hypolimnion was introduced many years ago by a Polish limnologist (Olszewski 1948). The method consists of siphoning water from the hypolimnion of the lake or reservoir. It is easier to perform in a reservoir than in a lake for which it was originally designed, because the siphon can simply hang over the dam wall and does not require any energy to operate other than initial start-up. This method was recently performed in a small, shallow Swiss lake and produced some positive effects by decreasing the hypolimnic phosphorus concentration, but the effect on oxygen was offset by increased hypolimnetic temperatures (Livingstone & Schanz 1994). This illustrates that an estimate of the character of the water that will replace that which is siphoned off is needed before using this method. This can only be determined if the stratification of the waterbody is well known.

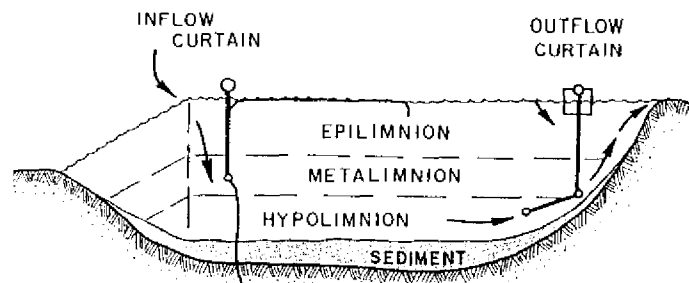

Fig. 11.10 The possible use of submersible curtains. The inflow curtain placed at the surface distributes the inflowing water to deeper strata. If the inflow curtain will be placed at the bottom, the inflowing water will be diverted to the reservoir surface. Similarly the outflow curtain may direct the flow to outlets from the top, bottom, but also middle layers of the reservoir.

11.4.3 Curtains

The use of plastic curtains to modify the outflow depth can substitute for multiple outlets to some degree. However, there are limits in the depth selection. The creation of near-surface and near-bottom outlets are more feasible and can be realized by anchoring a curtain of an appropriate height at the bottom and lifting it by use of floats, or by anchoring a curtain at a certain height above the bottom and lifting it to the surface (Fig. 11.10). Outlets at intermediate depths require a more elaborate arrangement. Materials must be strong enough to resist water movements, and, considerable leaking around the edges and bottom must be taken into account.

At the inflow, curtains have been used in a few instances to direct flow into the hypolimnion or epilimnion (e.g., Aseada *et al.* 1996). Considerable mixing with the reservoir water occurs because water passing the curtain submerges or rises in accordance with density differences.

11.5 OTHER METHODS

11.5.1 Algicide use (particularly copper poisoning)

The addition of algicide such as simazine or copper sulfate has long been used as an emergency measure to control excessive algal growths, usually when these are already well-advanced. The dosage of CuSO_4 application varies between 6 kg and 20 $\text{kg}\cdot\text{ha}^{-1}$, depending on the depth of the algal layer. A concentration of 1-2 $\text{mg}\cdot\text{l}^{-1}$ must be reached in order for the application to be effective.

The only advantage of the method is that it works rapidly. The limitations include the short duration of the effects. Also, in alkaline waters with levels above 150 $\text{mg}\cdot\text{l}^{-1}$ CaCO_3 or in waters with high organic matter content, a chelated form must be used; otherwise, Cu is rapidly lost from solution. The method is not advisable because of its negative environmental impacts. CuSO_4 is toxic to fish, zooplankton and other organisms. In some instances the absence of zooplankton control resulted in a phytoplankton peak after detoxification, because zooplankton regenerates far slower than phytoplankton. The application of copper leads to its long-term accumulation in sediments. The negative side-effects observed during 58 years of copper sulfate treatment in Fairmont Lake (Minnesota) are described by Hanson & Stefan (1984). In the case of algicide use, addition of a toxic chemical to drinking water, even in low concentrations, is undesirable. The costs depend on the dosage and frequency of application.

11.5.2 Manipulation of the underwater light regime

This method is used to reduce algal column photosynthesis and corresponding capacity for algal biomass growth. Reduction of light availability can be achieved in two ways: either the light intensity that reaches the surface is decreased or the light absorption capacity of water is decreased. The first can, to some degree, be achieved in regions with low sun by shading the waterbody by surrounding tree growth. The placement of soot on the water surface has been suggested for some very small waterbodies, however, in larger waterbodies wind activity disturbs this cover. A decrease in light availability to the algal populations can be achieved by deep mixing of these populations with some of the techniques described in section 11.1. An additional manipulation might be possible by increasing the background light attenuation coefficient (ϵ_q) by

suspension, as suggested by Ridley & Steel (1975), or by use of artificial colors. Artificial coloring used in food products has been successfully applied in some Danish lakes (Jørgensen 1980). In small ponds, a decrease in photosynthesis and subsequent decrease in pH (high pH causes ammoniac poisoning of fish fry) was achieved by use of this technique (Hartman & Kudrlička 1980, Jirásek & Heteša 1980). Toxicity of some coloring agents may be a limiting factor.

11.5.3 Macrophyte control

Macrophyte control can be directed to either support or to diminish macrophyte growth. An increase in macrophyte growth is desirable when shore protection against wave erosion and a buffer zone against pollution. In reservoirs, shallows are usually not extensive and large and frequent water level fluctuations discourage the growth of rooted macrophytes. However, the situation is different in shallow reservoirs with less variable water levels. Macrophyte reduction techniques are based on macrophyte harvesting, the use of herbivorous organisms, and the use of pesticides. As discussed in Chapter 4, competition for light between phytoplankton and rooted macrophytes and the switching between macrophyte and phytoplankton dominated conditions in shallow reservoirs and reservoir shallows can be initiated by changes in turbidity. Reservoir drawdown can also reduce the growth of submerged vegetation. Winter drawdowns in regions that freeze are particularly effective. Some vegetation types regenerate very rapidly.

Macrophyte harvest is accomplished by use of a number of specially adapted boats, one of which is shown in Fig. 11.11. The best design depends on the type of plants to be harvested and whether the plants are floating, softly-rooted, submergents or tightly-fixed emergents. The area that needs to be treated determines the necessary size and capacity of the supporting boat. For more details it is referred to Anonymous (1979) and Moss (1995).

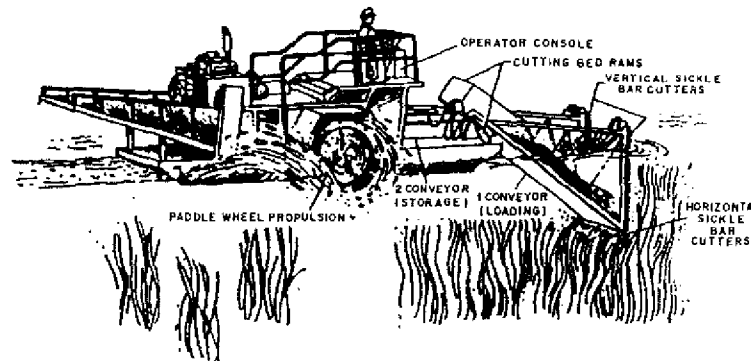

Fig. 11.11 One elaborate type of macrophyte harvester. Redrawn from Moore & Thornton (1988).

Mammals, fishes and invertebrates all feed on macrophytes. Support of the proliferation of the water cow, manatee (*Halicore dugong*), which lives in Florida and the West Indies, is used in Florida to increase consumption of aquatic macrophytes and thus decrease the blockage of waterways. Among fishes, surprisingly efficient consumers of aquatic macrophytes have evolved

only in one region of the world. This is Eastern Asia, particularly China, where several species of phytophagous fish species exist. Some, like the grass carp *Hypophthalmichthys molitrix* are successfully used in other regions for the reduction of macrophytes. This fish thrives easily and is tasty, so it is useful for both macrophyte reduction and human consumption. In addition, the species is capable of feeding on large colonies of Cyanophyta, and thus can bring about another positive water quality effect. As discussed in section 11.3, this fish is cultivated in some regions of subtropics and survives in tropical conditions and attempts to use are it have been undertaken in other parts of the world.

Among invertebrates, considerable success in reduction of tropical floating vegetation was achieved with the use of grasshoppers. Other reported attempts are with the weevils (*Neochetina eichhorniae*, *N. bruci*) and the alligator flea beetle *Agasicles hydrophila*.

In regard to control of vegetation with herbicides, we refer to the handbook by Gangstad (1986) that also contains a review of other plant management methods.

Emphasis should be placed on methods that do not require use of toxic chemicals, because negative environmental impacts of the use of these chemicals is widely understood. Ecotechnological advantages of methods based on the natural enemies of plants are obvious, however, extreme care and thorough investigation and evaluation is necessary before organisms are introduced in areas outside of their natural range. There is great danger that these species could resort to the eating of other plants such as agricultural crops, and they could become dangerously abundant and suppress native desirable species. The cost is highest for harvesting methods, and is affected by the utilization of the harvested plants. If they are used as green fertilizers or fodder for domestic animals, some costs expended during harvest can be recovered. The use of phytophagous organisms is inexpensive, and, in the case of phytophagous fishes, a quality food source can be obtained.

11.5.4 Water level manipulation

Decreasing water level may have consequences for macrophyte reduction and for reduction of reproduction of some undesirable fish species, laying eggs on vegetation. Rapidly overgrown shores are in some countries immediately grazed by animals. When shrubs start to grow, a negative effect on water quality can be expected. Drying of sediments causes their compaction and consolidation, increased oxidation of organic matter and decrease of the organic content of mud. After refilling the reactive phosphorus concentration can temporarily increase because mineralization processes in the mud take place.

11.6 CONFRONTATION OF DIFFERENT ECOTECHNOLOGICAL APPROACHES

In terms of ecotechnology (Chapter 7) the best approaches are those that are most natural and do not rely on the use of chemicals, equipment or energy. Of the procedures discussed, the following procedures best satisfy conditions: biomanipulation, selective withdrawal, epilimnetic mixing and layer aeration. Nonetheless, there is a need for higher knowledge about the efficiency of these techniques in particular reservoir ecosystem situations. The possible applications of any of the

in-lake methods must be evaluated in connection with the possibilities of managing the watershed. It should be noted that all preventive methods should be preferential over curative methods, to which most of the in-lake methods belong. The only truly preventive in-lake method is epilimnetic mixing. The most adverse method is the use of copper sulfate, which develop into a "time bomb" when copper accumulates in sediments and is later released into the water. Similarly, the use of other algicides, particularly in drinking water reservoirs, is undesirable. Alum treatment is suspected to be involved in adverse long-term health effects. However, Lam *et al.* (1995) have shown that, of the chemicals commonly used for water quality control in drinking water reservoirs, alum (and lime) appears to be more suitable than either copper, other algicides or chlorine in combating toxic cyanobacterial blooms. In comparing the application of copper and alum, not just the toxicity is important, but also the amount and frequency of application of the chemical. In this respect, alum treatment is far better, because one application lasts for several (up to 14) years, whereas copper must be added up to several times a year, particularly in the tropics.

CHAPTER 12

MANAGEMENT OF RESERVOIR OUTFLOW

River impoundments cause direct and indirect changes in environmental conditions downstream of the reservoir. This is a serious concern for the reservoir owners and managers, because the law in many countries mandates responsibility for water quality deterioration, fish kills and other value losses. Possible downstream effects are outlined in Chapter 12.1. Management must consider these water quality and environmental effects as well as uses of the river below the reservoir (Chapter 12.2).

12.1 ENVIRONMENTAL CHANGES IN THE RIVER BELOW A RESERVOIR

In terms of river hydrology, three kinds of effects can be distinguished, depending upon specific reservoir uses. In water supply and irrigation reservoirs, water that is withdrawn is entirely lost to the downstream river reach and this results in severe water quality consequences and impacts on river biota, especially if the reduction of river flows is great. As an example, a series of reservoirs on the Colorado River in western USA have reduced flows in the river to such an extent that flows into Mexico amount to minimal flows of poor quality water. Flow regulation reservoirs ameliorate extreme flow regimes, nevertheless, negative effects such as the disastrous changes in the Nile Delta that were caused by the Aswan High Dam by interruption of the continuity of sediment flows can occur. The most damaging effects occur below hydroelectric reservoirs during peak operations, which cause enormous short-term fluctuations of river flow. To decrease flow variations below such reservoirs, a re-regulation reservoir is often constructed with the purpose of retention of the peak flows and subsequent releases of water in a more even pattern to downstream areas.

Tab. 12.1 Major water quality characteristics of reservoirs that are decisive in changing downstream water quality and river conditions.

WATER QUALITY	EFFECTS UPON DOWNSTREAM RIVER CHARACTERISTIC
HYDROLOGY.	Greatest effect in semi-arid regions, considerable effect in temperate regions, and least effect in wet tropics.
STREAM ORDER.	Inverse with the level of stream order - greatest effects in lowest stream order and vice versa.
RESERVOIR DEPTH.	None or minor effects in shallow reservoirs, but increasing effects occur with increasing depth of the reservoir.
RESERVOIR OUTLET DEPTH.	No outlet depth effects in shallow (unstratified, wind-mixed) reservoirs, but increasing effects occur with increasing outlet depth in stratified reservoirs.
RETENTION TIME.	Reservoirs with short retention times do not have much effect on downstream river, but effect increases with prolongation of retention time.
TROPHIC DEGREE.	Effect on the downstream river increases with greater reservoir biological productivity.

Limnological characteristics of the reservoirs themselves are very influential in the intensity of the reservoir effects on the downstream river. Some of these characteristics are outlined in Tab. 12.1. The multivariate character of reservoir ecosystems should be borne in mind and that the listed effect of changing one variable is only valid in comparable conditions: for example, a deeper reservoir will only have a greater effect than a shallow one if it has the same retention time.

Physical, chemical and biological variables in the downstream river are affected by the reservoir in various ways (Tab. 12.2). Factors listed in the table represent gross generalizations that do not account for multivariate effects. There are many possible combinations found within stratified reservoirs. The situation within the reservoir at the depth of outflow is decisive for outflow water quality - the water that flows to the river below. Therefore, the rules for the development of reservoir water quality under different conditions described in Chapter 4 are decisive. Mathematical models of reservoir water quality discussed in Chapter 14 can indicate the consequences of the reservoir on the outflowing river. Some models also enable reservoir operation that results in optimal effects on downstream aquatic resources. Additional changes can be caused by gas saturation in spillgates (oxygen saturation but gaseous nitrogen supersaturation) and hydrological effects caused by instantaneous increases in outflow volume, such as those that occur in hydropower reservoirs. A study by Barrilier *et al.* (1993) on the Upper Seine River in France demonstrated the effects of the wave front: resuspension of sediments, deoxygenation of water, increase of nutrients, and dissolved and particulate organic matter.

Tab. 12.2 Downstream water quality effects

VARIABLE	CHANGES IN DOWNSTREAM WATER QUALITY
PHYSICAL VARIABLES	
RIVER CHANNEL STRUCTURE.	River channels that are located below dams can be substantially damaged by decreased, increased, and particularly by erratic flow rates.
HYDROLOGY.	Decreased flow rates result when usage of reservoir water is high, such as occurs in irrigation reservoirs or when evaporation rates are high. Periodic flow increases, and increased variability and disruption of natural hydrological cycles occur, particularly below hydropower reservoirs.
THERMICS.	A decrease in average temperature occurs. The degree of temperature decrease escalates with greater reservoir retention time and outlet depth. Geographical distinctions: in temperate regions, temperatures below reservoirs are higher than in unaltered river systems in winter but are lower in summer; in tropical regions, the temperatures are increased in both winter and summer. The annual temperature range is increased in surface outflow reservoirs but decreased in deep-water outflow reservoirs (Fig. 12.1). Vernal temperature rises are delayed in surface outlet reservoirs and even further delayed in deep-water outflow reservoirs.
SILT CONTENT (=TURBIDITY).	Decreased silt loading occurs. This may cause a decrease in floodplain soil fertility with corresponding consequences on agricultural, wetland and forest productivity.
DETRITUS.	The composition of particles changes from abiotic to biotic and particle size decreases.
LIGHT.	Light penetration is increased.
CHEMICAL VARIABLES	
OXYGEN.	If the reservoir is eutrophic and the outlet depth is below the thermocline, DO concentrations in outflow water may drop to near-zero values.
H₂S and CO₂.	Values increase, especially in eutrophic, stratified reservoirs that have long retention times.
pH.	Values decrease, except when the inflow pH is very low, such as those that occur in blackwater reservoirs in

the Amazon.

NITROGEN. Gaseous nitrogen content increases in aerated reservoirs to supersaturation levels that cause fish kills. This is not due to high gaseous nitrogen in the outflow depth of the reservoir, rather it is related to processes that occur during aeration at the spillgates.

ORGANIC MATTER. Organics decrease downstream when there are no sources of in-lake organic production. Phytoplankton production can result in overwhelming in-lake organic matter production in highly eutrophic reservoirs that receive low organic matter input.

PHOSPHORUS. Phosphorus concentrations decrease, and the amount of decrease is higher when retention time and trophic degree are greater. An exception occurs when bottom waters are released from eutrophic reservoirs that have anoxic hypolimnia. Reduced phosphorus levels result in decreased biological productivity in the outflow river.

NITRATES. Nitrate concentrations are usually nearly unchanged, but sometimes increase slightly. When strong reducing conditions exist in the reservoir, the concentration of nitrates downstream is decreased.

NITRITES. Concentrations of nitrites are usually increased, particularly during deep-water releases from reservoirs of higher trophic degree.

TOTAL SOLIDS. Total solids concentrations remain nearly unchanged.

BIOLOGICAL VARIABLES

PLANKTON. In general, plankton abundance increases downstream.

PHYTOPLANKTON COMPOSITION. The phytoplankton composition changes downstream. In small rivers, there is a transition from riverine (periphytic) species to pelagic species; in large rivers, the number of lacustrine species increases below a reservoir.

PHYTOPLANKTON PRODUCTION. Specific phytoplankton production (per unit mass of phytoplankton) can be extremely high if hypolimnetic phytoplankton that are chlorophyll-a enriched are released to the river and reach high light conditions.

PHYTOPLANKTON BIOMASS AND CHLOROPHYLL-A. Amounts depend on the location of the outflow: surface outflow delivers more phytoplankton, whereas hypolimnetic releases reduce transport of phytoplankton biomass. Phytoplankton from the hypolimnion has higher chlorophyll-a content.

ZOOPLANKTON. A small river below a reservoir is highly enriched in zooplankton. In a large river or reservoir, a transition from potamoplanktonic composition to pelagic composition takes place. Zooplankton biomass usually increases in the outflow as compared with the inflow due to flushing from the lake.

BENTHOS. Increases below slightly eutrophic reservoirs, and usually decreases below highly eutrophic reservoirs in connection with anoxia. Composition is usually highly changed. Detrimental effects of short-term water level fluctuations on benthos are high.

FISH. The reservoir represents a barrier in fish migration, and spawning waters often cannot be reached. Feeding habitats are often reduced. Fish occurrence below reservoirs varies greatly according to specific conditions: Changes can include fish kills due to gaseous nitrogen supersaturation, decline in fisheries, and improved oxygen and feeding conditions in some situations.

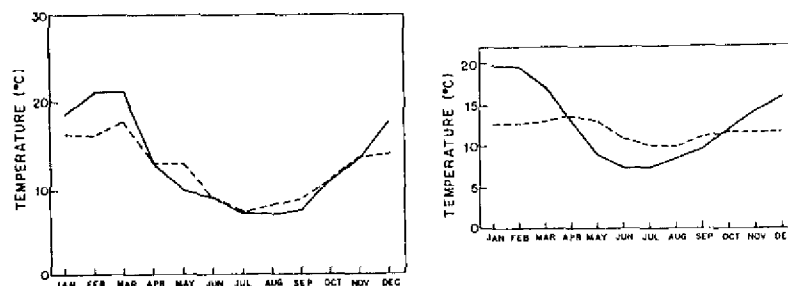

Fig. 12.1 Leveling of the long-term (average for 13 years) annual inflow temperature variations below the dam (dashed line) confronted with the same locality before the dam construction (full line) in two Australian reservoirs. Redrawn from McMahon & Findlayson (1995).

Situation is different in tropical and arid regions. Evaporative loss can have a significant effect in areas where hydrological budgets are negative and evaporation exceeds precipitation.

Biological consequences to the nature of rivers downstream of large reservoirs are very great, as has been demonstrated by many studies. If the reservoir causes a reduction in maximal flows and scouring effects, increased macrophyte growth can occur downstream. Below the reservoir, complete disruption of the river ecosystem is often observed and can result in fish kills and impoverishment of fish populations. Deterioration of the drinking water supply and loss of high value recreational sites can also occur. However, there can be also positive effects such as cases in which the outflow from deep oligotrophic reservoirs improves water quality in a polluted river to such an extent that trout or similar fish species are able to survive. Because reservoirs function as settling and biological oxidation basins and phosphorus trap (Chapter 4) a significant improvement in outflow water quality can occur under some circumstances.

The reset distance discussed in Chapter 3 defines the extent of river length that is affected by the reservoir and the point at which conditions in the river return to normal in an undammed river. This distance can vary considerably and is determined by the position of the river in the watershed, geography of the area, and other variables. Inflows that enter the river below the reservoir are also important. For example, below Balbina Reservoir (Brazil), deoxygenated waters persist for as far as 20 km from the outflow. The Eildon Dam outflow modifies conditions in the river for 138 km, and below Hume Reservoir (both in Australia), the temperature effect ceases only after 200 km. The effect of large reservoirs can extend as far as river deltas, and result in the loss of estuary ecosystems, reduction of fishery habitats, and saltwater intrusion into delta farmlands.

12.2 MANAGEMENT OF THE RESERVOIR OUTFLOWS

The following three basic options are currently in use:

- 1) management of the water quality in the reservoir watershed and the reservoir itself by use of various options;
- 2) use of selective offtakes to withdraw water of the best possible quality; and,
- 3) use of additional means to improve the gas conditions of outflow water.

12.2.1 Managing water quality within the reservoir and its watershed

Water quality management of the entire reservoir watershed and in the reservoir itself are the best options to achieve high quality outflow water. Methods to achieve this goal are provided in Chapters 10 and 11.

12.2.2 Use of selective offtakes

Selective offtakes use an outflow depth that corresponds to the layer of best water quality in the reservoir. This is particularly important in offtakes for drinking water treatment plants, but is also important for river outflow considerations. The use of selective offtakes in reservoir water quality management, as illustrated in Fig. 11.9, has important consequences on reservoir outflow. However, it must be noted that changing the outflow depth for all reservoir water or a

considerable portion, such as during irrigation, has consequences on water quality at the outflow depth. This is because outflowing water is replaced by water from surrounding strata and this water usually differs in terms of water quality. Thus, the dynamic nature of water quality must be acknowledged and respected. The use of reservoir water quality models that cover hydrodynamic conditions (Chapter 14), offer considerable help in attaining this goal.

Use of selective offtakes began fairly recently and during the construction of most existing reservoirs, water quality and environmental problems were not considered. McMahon & Findlayson (1995) point out the high costs that are incurred when selective offtakes must be constructed in existing reservoirs for environmental reasons. For example, they estimated that the cost of one recently constructed new outlet in the Upper Yarra Dam in Australia was 10 million US\$. They also analyzed probable future changes in perspectives due to Global Changes (Chapter 16).

A new method designed to modify the outlet depth was recently developed, particularly for small and medium size reservoirs. This method is based on the use of plastic curtains near the dam wall, as described Section 11.4. These plastic curtains, of course, have only limited potential in selection of offtake levels. Relatively easy is the selection of the surface or bottom water, however, selection of the intermediate levels creates more difficulties. Leakage of water around the curtain edges cannot thus far be avoided. Pressure exerted on the curtains from internal water movements is enormous and the subject material must be high quality and strong to endure. Certain private firms are capable of constructing such curtains for small reservoirs (e.g., Ecosystem Consulting Service, Inc. located in Coventry, Connecticut, USA).

12.2.3 Management of reservoir outflows

Possibilities of improving water quality at the location of the dam are fairly limited, and consist mainly of modifications of the gas regime of the outflow. Tab. 12.4 lists alternative techniques that are used to manage outflows. Rather than discussing the details of each procedure, a significant reference is provided for each method.

Tab. 12.4 Techniques for management of reservoir outflows. References provided are either the inventor, a thorough summary of the usage, or both.

TECHNIQUE	REFERENCE
Selective withdrawal	Gaillard 1984, Pařizek 1984, Filho <i>et al.</i> 1990
Aeration/oxygenation at hydropower outlet works	Cassidy 1989
Spill-water reaeration	Cassidy 1989
Czech method of oxygenation	Haindl 1973
Epifilmnetic pumps	Quintero & Garton 1973 Mobley & Harshbarger 1987

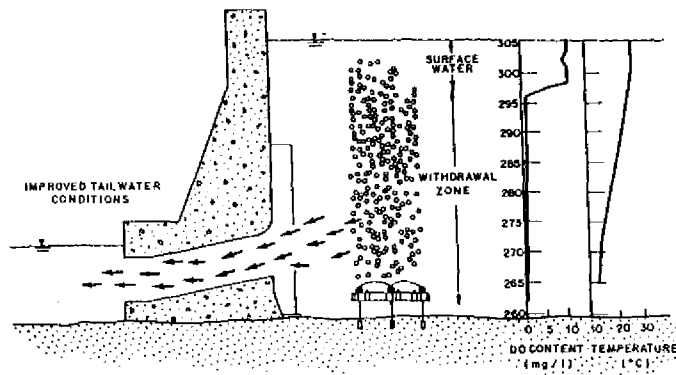

Fig. 12.2 Aeration near turbine intakes to improve downstream water quality. Redrawn from Mobley (unpublished).

Management of total outflow coupled with reservoir operational systems produce changes in the upstream ecological system. For example, a 2-meter drawdown in the operational level of Porto Primavera Reservoir (Brazil) saved a 700 km² upstream wetland.

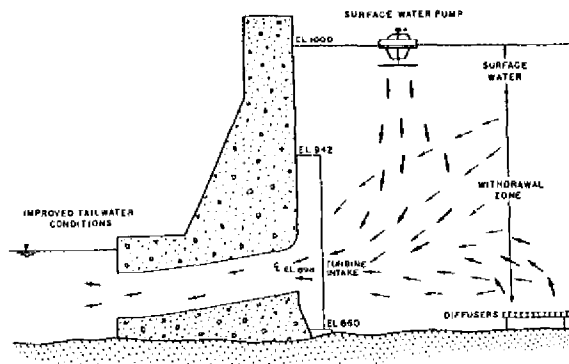

Fig. 12.3 Combination of oxygenation and mixing with a surface water pump or propeller near turbine intakes to improve downstream water quality. Redrawn from Mobley (unpublished).

Several approaches regarding aeration/oxygenation that are discussed in Chapter 11.1 can be included in management of hydropower outlets. The use of destratification in the vicinity of the dam is shown in Fig. 12.2. Figure 12.3 illustrates the use of a combination of oxygenation from the bottom and mixing by a propeller or a water pump from the surface. An improvement is achieved in cases of deoxygenated water at the turbine intake levels. Outflow oxygen concentration can be increased to levels suitable for fish and other aquatic life and devoid of smells by using such approaches. Additionally, outflow temperatures can be increased in comparison with unmanaged situations and structures are protected against corrosion.

CHAPTER 13

WATER QUALITY MANAGEMENT OF SPECIFIC RESERVOIR TYPES

13.1 DRINKING WATER RESERVOIRS

The strictest water quality requirements apply to drinking water reservoirs. With increasing anthropogenic stress on the environment, World Health Organization standards lists, in WHO Guidelines for Drinking Water Quality (1984), an ever-increasing number of variables that are recommended for regular monitoring in drinking water. This is related to the situation outlined in Fig. 6.1, in which an escalating number of new types of pollution are created. The chemical industry produces thousands of new chemicals annually, some of which leach into the environment and represent potential hazards to human health.

Optimally, drinking water reservoirs are located in mountainous or hilly areas that are sparsely populated. Forested watersheds are optimal, but *Eucalyptus* forests that were introduced in many countries have a less positive effect than more natural forest assemblages. In regards to the reservoir type, deep stratified reservoirs are highly preferable. Oligotrophic to mesotrophic conditions and a fairly well oxygenated hypolimnion must be maintained by use of all possible means. Anoxic hypolimnia are undesirable, due to potential release of manganese, iron and phosphorus. Release of these elements greatly increases treatment costs, and can cause odor and taste problems. The latter problems result from proliferation of a number of organisms that develop in anoxic conditions. After treatment with chlorine, organochlorides produce undesirable tastes in treated water. The only way to avoid such problems is to avoid anoxia. Management methods that can be used to reach this goal include a host of options provided in Chapters 10 and 11.

One management method that is specific to drinking water reservoirs is the use of automatic selection of the best water layer from which water is withdrawn for treatment. This can only be used if the whole reservoir is in the oligotrophic or mesotrophic state and possesses multiple outlets that enable selection from densely spaced layers. A simple measure of best water is the horizontal transparency of individual layers. Layers with the most transparent water usually contain less dissolved and particulate organic matter and these layers are best suited for treatment. Transparency can be automatically measured by submersible illuminometers at suitable time intervals (e.g., daily), and offtake for treatment can be changed accordingly.

Another management method that is particularly suitable for drinking water reservoirs is biomanipulation. Using biomanipulation, stricter requirements are more easily achieved and regulation of the fisheries is also feasible. Conditions necessary for successful biomanipulation are discussed in Chapter 11.3.

Many conflicts between requests for high water quality and large volume of water quantity are

resolvable. For improvement of drinking water, it is preferable to flush the reservoir during stratification periods by releasing undesirable strata to the river. Such strata are usually at the reservoir bottom, but sometimes release of surface water with excess algae is desirable (Chapter 11.4). Flushing may not be feasible because of water deficiencies or potential impacts to downstream uses. Recreational activities that take place on the river below the reservoir can be adversely affected by hypolimnetic cold water releases. Other conflicts arise with multiple uses. A typical example is the request to combine drinking water supply with recreation. Drinking water reservoirs and their respective watersheds are often located in the most environmentally attractive areas. There is increasing pressure to make recreational use of these areas, both within the watershed and the reservoir itself. Considerable hygienic restrictions are necessary (Chapter 13.4) to accommodate these additional uses. Combination with power generation is another source of conflicts, whether performed according to the original plan for the reservoir use or as a supplemental use. Conflicts can arise over different requirements for the selection of the release depth, the need to produce energy even during times that will severely decrease pool levels and result in degraded water quality and many specific use requirements.

Reservoirs for drinking water are common in developing countries even in highly populated areas. However, because of increasing population growth and many sources of pollution, these reservoirs are subject to enormous anthropogenic stress. Consequently, costs of water treatment are high and the danger of epidemic events related to poor water quality increases (e.g., intoxication due to toxins from blue-greens, in particular *Microcystis* strains). For example, Billings Reservoir in São Paulo, Brazil is a drinking water reservoir that is quite eutrophic because of heavy blue-green algae blooms. However, in addition to providing drinking water supply, the reservoir is also used for power generation. To achieve these purposes, water is pumped from the extremely polluted Tieté River through town and receives enormous amounts of pollution and garbage. The water is pumped near the location of the drinking water intake. Very poor water quality and many supply problems result.

13.2 POWER GENERATION RESERVOIRS

Reservoirs that are solely used for power generation have the least stringent water quality requirements, however, there are also limits that need to be guaranteed. Significant corrosion of the dam and the turbines can occur when hypolimnetic water is anoxic, and, in tropical conditions, the entire water profile can reach damaging levels of CO₂, H₂S and methane saturation. For example, in Willow Creek Reservoir, USA, Strycker (1988) reports serious leakage of the dam. In the Curua Una Reservoir in the Amazon region of Brazil, turbines had to be replaced after only four years of service. In the El Cajon Reservoir in Honduras, interference with electrical transmission lines occurred over the reservoir because of gas abolition from sediments.

Although hydroelectricity is now considered the cleanest method of power generation (aside from wind power generation, which has much more restricted use), it is not without environmental problems. Major power generation reservoirs require large areas of space and are often constructed in areas that are often highly populated. Relocation of large numbers of people can create a number of socio-economic problems (Chapter 2). Effects on the downstream river are

mostly negative and result in long "reset distances", mainly because of decreased temperatures and oxygen conditions. Intermittent deep water releases can cause damage to the river channel and degradation of river use (Chapter 12).

Water quality requirements are emphasized by most present day power generation reservoirs because multiple uses dictate criteria.

Due to typically short retention times, water quality in power generation reservoirs responds to flow variability between years (Chapter 4). In dry periods, large shore areas are exposed and water quality is degraded due to low pool levels, consequently, downstream use is also degraded and fish populations in the river below the reservoir can be completely destroyed. In temperate regions, dangerous water quality situations are associated with low pool levels in winter. Ice on the surface of the reservoir prevents re-oxygenation and mass fish kills can occur, further deteriorating water quality to an extent that it is inappropriate for even non-consumptive uses.

Reservoir cascades and pumping schemes that are typically used for power generation in several countries including Spain and Brazil (Chapter 2) have specific management problems that are discussed in Chapter 13.5.

13.3 URBAN RESERVOIRS

Urban reservoirs are usually restricted in size and range from very small pond-like waterbodies to impoundments of several million cubic meters. They are subject to very high anthropogenic pressure from surrounding communities and the condition of water quality within the reservoir is closely tied to the hygienic and economic conditions of the surrounding populations. Even if most pollution is removed from the water, there is often a high level of eutrophication, due to the use of washing powders that contain superphosphate. These reach the lake, particularly during heavy rain and storm events. For this reason, the use of detergents associated with car washing and similar activities around the lake should be restricted. Additionally, the use of chemicals in garden and lawn care can be a source of toxins that can poison aquatic life.

The only management option that is specifically recommended for urban reservoirs is stormwater runoff prevention (Novotny & Olem 1994). Urban runoff collection is usually separated from standard effluent collection systems that are conveyed to the cleaning plant. This is because urban runoff consists of huge water masses with low organic matter but high turbidity and garbage. If this was all conveyed to the purification plant, the capacity of the plant would quickly be exceeded. Increases in treatment plant capacities to meet the demands of storm events are quite expensive. When stormwater is collected and treated separately, water quality is improved at lower costs. The response of reservoir phytoplankton depends on the degree of turbidity and input of nutrients caused by the storm. The reaction consists of a phase of decreased phytoplankton biomass due to decreased photosynthesis during low light conditions caused by turbidity input, followed by a phytoplankton bloom stimulated by increased nutrient inputs and improved light conditions following sedimentation of turbidity.

Most of the management options described in Chapters 10 and 11 are useful in management of urban reservoirs. Planting and protection of shore vegetation is highly recommended as it serves as a natural barrier to pollution. Fisheries that are regulated with respect to biomanipulation principles are feasible, particularly in small waterbodies that primarily serve aesthetic purposes. Unregulated fisheries that favor extraction of predatory fish could result in water quality degradation. The presence of numerous aquatic birds is a sign of good water quality and proper regional management. However, if large flocks of ducks or geese are fed by people, considerable pollution can result.

In larger urban reservoirs located in densely populated developing countries, the major problem is multiple use conflicts. For example, the Xuanwu Reservoir in Nanjing, China, which has a volume of 3.32 km³ but average depth of only 2 m and average theoretical retention time of 54 days, is used as a tourist resort with swimming activities, but also serves as an aquatic farm, as a source for industrial and domestic water supply, and for irrigation of agriculture. Consequently, pollution and siltation levels are very high and dredging activities were necessary by 1954. Without dredging, the reservoir would become filled with sediment in just a few decades.

13.4 RECREATION AND TOURISM ON RESERVOIRS

These three basic categories of recreation that affect reservoirs are distinguished:

- a) recreation in the reservoir watershed;
- b) recreation at the lake shore; and,
- c) recreation directly on the lake surface.

13.4.1 Recreation in the reservoir watershed

The same rules and management options that apply to human activity in the watershed also apply to recreational activities in reservoirs. In the watershed, the need for proper waste treatment in individual houses, hotels and other facilities is particularly important. Special care must be taken during use of fertilizers and other chemicals. Soil erosion associated with road building and other construction must be strictly controlled, because this is a major source of siltation in the watershed.

13.4.2 Recreation at the lake shore

Recreational activities at the lake shore are closely connected with recreation that takes place directly on the lake. Any activity that takes place on the lake is linked to movements on the shore. These shore-based activities usually have a deeper impact on water quality and need more attention than activity on the lake. In general, more time is spent on the shore, and more pollution is created and more destructive activities take place on the shore.

The following include some of the many shore-based recreational activities: housing, camping, walking, fishing, picnicking, bird watching, and sunbathing. Shelters and campsites are often the location of most serious impacts, but the other activities cannot be ignored, especially because they are usually connected with construction of access roads, restaurant and hotel facilities, path construction and other amenities that destroy the natural character of the shores and their

associated environments. Road construction can create drastic changes in the hydrology of surrounding wetlands, and can result in increased erosion and non-point source pollutants. Dillon & Rigler (1975) designed a method of estimating the maximum housing capacity of a lake. However, the conditions under which this method of estimation is valid are specific to Canada and USA, and possibly some portions of Europe. The method is not appropriate for other conditions.

The need for strict rules that govern placement and specifics of facilities, including hygienic issues, is evident. The capacity of the reservoir to accommodate recreation is not unlimited and certain restrictive rules must be in place. Among these, garbage collection should be facilitated and washing of cars should be strictly prohibited.

Destruction of shore vegetation, which provides a buffer zone and ameliorates siltation and pollution, is often related to degraded water quality.

13.4.3 Recreation on the lake surface

There are many types of recreational activities that take place directly on the reservoir surface. Each represents some danger to water quality, depending on intensity. It is difficult to quantify a "safe" level of recreational intensity (such as the number of people days per unit area of lake). This is because the degree of impact is influenced by overall reservoir water quality and a vast combination of different activities. Activities that are usually considered harmless may become serious after the level of use exceeds some limit. An individual Environmental Impact Assessment is necessary to estimate the potential impact of recreation to determine reasonable

Tab. 13.1 Recreational activities that take place on the reservoir surface and potential water quality consequences.

ACTIVITY	CONSEQUENCES
Sport fishery	interference with biomanipulation procedures, pollution caused by improper disposal of fish remains and fishing supplies, excess fish feeding, introductions of non-native fish
Commercial fisheries	see (1) at the bottom of the table
Swimming	stirring of sediments causes turbidity and increase in proliferation of coli bacteria, hygienic impurities, danger of infections
Scuba diving	rarely a source of pollution
Canoeing, rowing, windsurfing	negligible problems within the lake, potential impacts by associated shore activities
Sailing	large sailboats can introduce a major pollution source
Houseboats	input from sanitary systems which can include sewage, detergents, excess organics and trash
Motor boating and water skiing	shore erosion caused by waves, oil and fuel pollution
Cruisers and large boat traffic	danger is minimized by hygienic arrangements (dry toilets, preservation of wastewater and wastes)
Ice skating	no known problems

(1) Impacts caused by commercial fisheries and aquaculture vary greatly depending on specific methods. Organic loads associated with fish farming in cages and mussel farming can be greater than the amount of organic matter removed from the lake during fish or mussel harvest.

limits for various activities. Various activities and potential corresponding impact on the reservoir are listed in Tab. 13.1.

Special management guidelines must be elaborated to regulate onshore and on-lake activities listed in Tab. 13.1. In particular, houseboats, large yachts and motorboats should be greatly limited or prohibited.

Recreation and tourism in reservoirs can have an important economic impact in some communities. There is a strong relationship between recreation, tourism, water quality and human health. Therefore, when managing water quality for recreation, human health must also be considered. Research to determine early warning signals of ecosystem deterioration that is accompanied by degradation in human health is needed. For example at Lobo (Broa) Reservoir, the high concentration of aquatic birds perpetuates fish parasitoses. The water quality remains adequate for swimming, but the fish are no longer suitable for consumption.

13.5 RESERVOIR SYSTEMS

Common types of reservoir systems were described in Chapter 3.3. Problems specific to the management of the four types described are provided in this chapter.

13.5.1 Management of reservoir cascades

In Chapter 4.4 we have illustrated the positive effects that a reservoir has on water quality, and in Chapter 10.8 the positive water quality function of pre-reservoirs was explained. These concepts provide a basis for understanding the potential management problems and options involved in reservoir cascades. In a series of reservoirs, if no additional sources of pollution are introduced during their course, considerable water quality improvement is obtained, particularly if the reservoirs are stratified and their retention times exceed specific limits. The observations documented in Chapter 4 suggest that, under such circumstances, the self-purification capacity of successive reservoirs diminish due to the lower degree of purification of organic matter and of phosphorus when their inflow concentrations are lower. Examples of water quality changes in cascade reservoirs include the Tennessee Valley Authority reservoir cascade on the Columbia River in USA, many reservoir cascades on rivers in Spain, the Vltava Reservoir Cascade in the Czech Republic and a number of cascades in Brazil. Successive improvement of water quality within a cascade is usually observed if additional, local pollution sources do not exceed improvements due to reservoir functions. The primary management option that is specific for this type of reservoir system is the use of this cleaning capacity. The highest water quality is obtained from a cascade reservoir that obtains the least local pollution. This effect is maximized if selective offtakes are used to feed lower reservoirs. This is only feasible in certain countries where drinking water supply has been given political priority. Under such circumstances it is also useful to specify one or several reservoirs in the cascade for the sole purpose of high quality water and suspend other functions as appropriate.

Complex management problems can arise in connection with desired multiple use and different uses of individual reservoirs in the cascade. It is necessary to find a balanced, optimized solution

that may require the sacrifice of some individual use requirements to the overall multi-goal performance of the system. A very detailed model for the whole system that addresses water quantity and water quality demands is needed to convince and enlist cooperation of the users. Often, the ability to meet the demands of individual users is dependent on the specific situation and timing (i.e., dependent of flow, water levels, pollution levels, stratification, etc.) and eventually most needs can be achieved.

13.5.2 Reservoir multisystems

Reservoir multisystems differ from cascades in that the reservoirs are located on different rivers, but the water is used in one central location. This is often the case for water or energy supply of communities or regions (Fig. 13.1). This is particularly common in dry regions where an individual watershed does not produce sufficient water. Therefore, production of sufficient water quantity is the dominant management goal in these systems and water quality problems are of secondary importance. The methods of integrated management outlined in Chapter 2 are the only possible means of satisfying both water quantity and water quality goals.

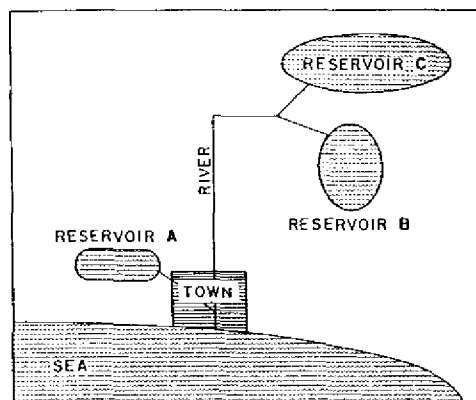

Fig. 13.1 An example of reservoir multisystem for water supply of a town.

An approach to integrated management of a reservoir multisystem is schematized in Fig. 13.2. Three levels or steps are distinguished. The first level takes different reservoirs within the system with their characteristics into consideration, in respect to both water quantity and to water quality. At the second level, different water uses that must be satisfied to some degree by the system are considered. Resulting management strategies for all reservoirs and all uses are represented in the third level. Different options, including the no control option, are considered on a daily and seasonal (monthly) basis. A specific method used to analyze this complex problem is Analytical Hierarchical Process (AHP) (Fig. 13.3). After definition of the problem and its structure (such as that provided in Fig. 13.2), a hierarchic graph is to separate the problem into manageable units. The analysis consists mainly of pair-wise comparisons at different problem levels. Finally, the whole problem is examined altogether.

13.5.3 Pumping schemes

Mermel (1991) lists 326 pumping schemes from all over the world, the majority (217) of which, are in Europe. There are two reasons to install pumping operations:

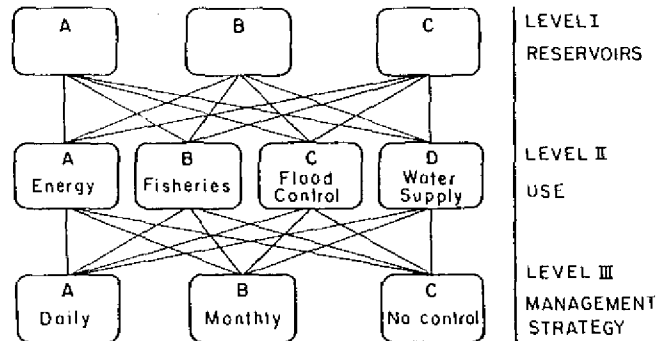

Fig. 13.2 Different hierarchical levels of the problem.

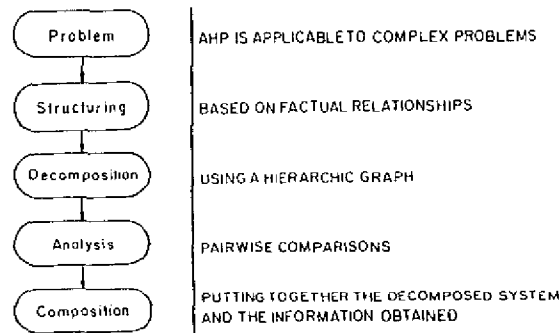

Fig. 13.3 The analytical hierarchical process of analyzing the integrated management problem of a reservoir multisystem.

- a) to provide energy generation in critical periods at the expense of energy losses in excess periods; and,
- b) to enable cooling of power generation plants (coal burning and atomic).

An interesting case is represented by the Round Reservoir in New Jersey, USA with a volume of up to $210 \cdot 10^6$ cubic meters that is used for flow augmentation of the Raritan River, which, in turn, provides water that is pumped to the reservoir during the high water stage (Owens *et al.* 1986).

This category does not include schemes of pumping water from a river into impoundments that are used for drinking water supply, as in the case of London's drinking water supply.

Pumping for energy generation. Because production of hydroelectricity can be started within minutes, it is often generated solely during periods of greatest need, mostly during the hours of sunrise and dusk. During periods of low electricity demand, water from a power generation reservoir is pumped to a smaller storage reservoir located at an elevation twenty to forty meters above the main reservoir elevation. In other situations, the order is reversed: the main reservoir is located upstream and water is pumped from a downstream reservoir. The world's largest pumping operation moves water from Lake Michigan into a holding reservoir. This water is then released during periods of high electricity demands to accommodate peak demand. These peak operations are related to slow filling of the storage reservoir, stagnation for periods lasting from a few hours to days, and rapid release of large volume of water. Consequently, water quality changes occur, not only in the storage reservoir, but also in the main reservoir. Different daily and weekly cycles take place in different reservoirs. These range from a single night of pumping up to a several night cycle, and less regularly, weekly cycles of longer pumping during weekends. Irregular cycles are also observed in accordance with electricity demands. Sometimes, two types of pumping operations are distinguished. The most common operation is designated as combined, or is perhaps better called supplementary, and is operated on a dam that also serves to generate power independently of pumping. Pure pumped storage is a sealed system and additional water is only needed to compensate for losses due to leakage and evaporation. In the later operation, water quality is not a priority and often the reservoir is nearly completely emptied.

The difference in sizes between the main reservoir and the pump storage reservoir is enormous, and so are the depths of offtake and release of water. Therefore, effects on water quality are quite variable and no generalizations are possible. One exception is the statement that the effect is small in the main reservoir if the pumped volume is only a small portion of its volume and the water quality of a small, regularly operated pumped storage reservoir is identical to, or dominated by, the water quality of the main reservoir. Complete mixing occurs during pumping in small storage reservoirs but the effects on stratification in large water bodies is very low. Some positive effects on oxygen conditions occur in cases in which mixing occurs in the main reservoir. Pumping of low quality polluted water to the main reservoir also sometimes occurs. Water quality changes can occur in relation to large water level fluctuations. The greatest adverse effect of pumping operations is the impact on fishes. Although some observations indicate that, under certain circumstances, damage to fish that pass the pumps is not great, other observations indicate that mortality occurs due to mechanical and pressure effects. A study by Robbins & Mathur (1976) indicates that fish have adapted their nest building habits in accordance with regular water level fluctuations and during large drawdowns nests are exposed.

Management of individual pumped storage operations totally depends on knowledge of local conditions. Attempts to develop crops that are resistant to temporal desiccation and minimize negative aesthetic effects associated with large muddy areas during drawdowns have been initiated, but no general recommendations have yet been established.

Pumping water for cooling purposes is a specific case, primarily used by atomic power plants. Heated waters that are released create thermal pollution that is detrimental to plant and animal life. Additionally, the danger of radioactive contamination must be avoided.

13.5.4 Water transfers

The most fully developed water transfer systems exist in semiarid regions of Australia. Water is transferred from mountainous watersheds that are characterized by high precipitation to satisfy water needs in arid watersheds that are up to 2000 km away. A similar situation is under development in other semiarid regions such as California and Southern Africa. Water quality problems that arise during this effort are primarily associated with the proliferation of recreation in previously pristine mountainous areas and increased agricultural utilization of watersheds. Plans for gigantic water transfers in the former Soviet Union were mostly unrealized. This is fortunate because environmental consequences of such large-scale activities cannot be adequately assessed with the current state of knowledge. In many cases where such large-scale transfers were realized, they led to enormous problems or disasters. Allanson *et al.* (1990) warn against premature realization of such projects in their review of the limnology of South Africa because proper environmental management of such projects is not easily foreseeable. McMahon & Findlayson (1995), in their review of the situation in Australia, point out a number of environmental problems that are related to these systems and the high price of *a posteriori* solutions.

Management of water quality in a heterogeneous system relies on detailed knowledge and availability of on-line information. Whether or not such efforts will be elaborated by the use of automatic or semiautomatic water quality control systems is a question that can only be answered in the future.

CHAPTER 14

MATHEMATICAL MODELING OF WATER QUALITY MANAGEMENT

14.1 GOAL OF THE CHAPTER

The goal of this chapter is to demonstrate to reservoir managers, limnologists, chemists, sanitary engineers and other interested parties the possibilities that mathematical modeling offers as a tool to help accomplish tasks and support decisions. The chapter is not intended to teach construction and solution of computer models. These technical topics are covered by books and specific chapters in books such as Jørgensen (1983), Orlob (1983), Straškraba & Gnauck (1985), Jørgensen & Gromiec (1989) and Jørgensen (1992).

The main focus is a description of various water quality models and how they are used. Models are classified in terms of their usefulness in water quality management, not according to classical model categories. Methodological approaches used in different models will be mentioned only when an approach restricts their use. Existing models that have proved useful in decision making processes will be emphasized. Many more research-oriented models exist and are listed in a publication regarding reservoirs by Straškraba (1994) and in a chapter regarding water quality models of lakes, reservoirs and wetlands by Straškraba (1995). Rather than present a broad review of existing models, a few models that are very useful in terms of management are presented.

Mathematical models are now extensively used in water quality management. Some idea of the extent of their use can be obtained from the survey by Alasaarela *et al.* (1993), who assembled questionnaires from 100 institutions. The results document the use of 105 models (both produced in the institute and elsewhere) that were applied in 800 situations and required approximately 500 person work years. On the average, modeling teams consisted of 4 persons.

Water quality is closely related to water quantity, however, water quantity modeling is simpler than water quality modeling and also has a longer tradition of use, therefore, is more fully developed. Information on water quantity as related to reservoir problems is reviewed in Biswas *et al.* (1993) and other similar sources. The use of weather radar and satellites is progressing, particularly in some countries like England and USA. The main use of these technologies is usually flood control, but information on flow conditions that are relevant for water quality management is also obtainable.

14.2 PROBLEMS FOR WHICH THE MATHEMATICAL MODELS ARE USEFUL

Mathematical models are used in reservoir water quality management for the purposes outlined below.

In general:

- to estimate pollution sources in the watershed by means of simple calculation models.

Before reservoir construction:

- to estimate budgets of major water quality components of rivers that will enter the reservoir, of the reservoir, and of the reservoir outflows;
- to provide reasonable estimates between several alternate construction sites, dam heights, and outflow and outlet structures so that decisions are supported; and,
- to predict conditions in future reservoirs and the consequences of different management options on water quality within the watershed.

For existing reservoirs:

- to predict possible future reservoir water quality conditions when environmental conditions in the watershed are altered by human activities;
- to provide estimates for decisions between different water quality management options for use in long-term planning;
- to support short-term operational management decisions regarding water quantity and quality; and,
- to optimize sampling schedules investigations and controls of reservoir water quality.

14.3 GENERATIONS OF MODELS

In order to enable selection of the most appropriate model, a water quality specialist must be acquainted with the terms that characterize major classes of models and approaches.

Computers are classified into five generations of successively more powerful machines, and likewise, mathematical models are classified into five generations of usefulness in terms of management. The generations distinguished by Abbott *et al.* (cited according to SASR, 1992) from the perspective of hydraulics modeling (including water quality aspects) are characterized as follows:

- 1st generation: computerized formulae of the early 1960's;
- 2nd generation: one-off numerical models for individual specific sites, not generally applicable (since 1960's);
- 3rd generation: generalized numerical modeling systems for computers experienced mathematical specialists, usually mainframe based but also processed on PC's;
- 4th generation: user-friendly software products, PC or work station based, widely applied by professionals; and,
- 5th generation: "intelligent" modeling systems for technically skilled but non-expert users.

The model groups useful for water quality management are as follows:

- (1) Simple static calculation models consisting of algebraic equations or graphs;
- (2) Complex dynamic models that provide analysis of timing aspects of water quality conditions; and,
- (3) Geographical information systems (GIS) that provide computer software for problems that require spatial resolution. The basis of GIS is computerized maps and procedures for entry and

treatment of spatial data. For instance, a specific watershed can be included in the database and corresponding pollution sources can be indicated. Through the use of models, the expected pollution input can then be calculated. Recently, several attempts to apply GIS in watershed management (GEO-WAMS - DePinto 1994) or combine watershed models with reservoir models (LWWM - Wool *et al.* 1994) have appeared.

(4) Prescriptive models calculate water quality conditions but do not directly indicate appropriate management options for a given situation. By means of scenario analysis, it is possible to test management alternatives and predict potential consequences for water quality. This can be useful in selection of the most appropriate management possibilities.

(5) Management or optimization models that incorporate selection procedures to choose the most suitable option according to a set of criteria that is appropriate for the given situation. Such models can allow simultaneous analysis of several management alternatives (multiparameter models) or several goals (multi-goal models).

(6) Expert systems use qualitative and quantitative expressions to guide the user toward relevant answers to complex water quality questions. The most important advantage of expert systems is their ability to cover qualitative characteristics in addition to quantitative characteristics and to handle complex decision rules. The name of this model group originated from the basis in which these answers are obtained - the judgment of experts in the given field. An interactive mode is available in which the user interacts with the computer software during the session by selecting from questions offered by the computer, obtaining answers, and answering questions offered by the computer.

(7) Decision support systems (DSS) represent a further extension of expert systems. They incorporate other computer software products relevant for a specific water quality decision problem for which the system was constructed. A graphics package that generates explanatory drawings and texts can be an integral part of DSS and all of the model types mentioned above can be incorporated in the system. The entire decision support system is automatically driven based on questions by the computer and answers by the user.

For practical purposes, fourth and fifth generation models are most useful for water quality management. In accordance with mathematical approaches, the degree of sophistication and purpose of fourth and fifth generation models can be classified into seven groups. Of these groups, groups 1 through 5 are predominantly fourth generation, whereas groups 6 and 7 are of the 5th generation. Some group 3 models can also be classified as 5th generation. Moreover, all models are either deterministic or stochastic. **Deterministic** models calculate one (average) value for each situation and/or unit of time. **Stochastic** models result in a range of values that can be expected for each situation and/or each unit of time. Often a deterministic model is first developed and later a stochastic formulation is constructed. Therefore, both deterministic and stochastic versions of the same model are possible. Stochastic runs are much more time consuming because the same model is calculated many times with slight variations in parameters so that the range of possible outputs, considering model parameter uncertainties is considered. Therefore, stochastic formulation provides a range of values (expressed, e.g., as the confidence intervals of predictions) that can be expected under given conditions for variables included in the model.

The capability of every model to provide useful predictions and hints for management depends

on the degree of its testing. There are several approaches for testing, however, the most important in terms of application is validation. Validation is a procedure in which model output is compared with observations that are independent of those that were used during the construction of the model. The most simple validation consists of using another series of observations from the same reservoir. However, this does not necessarily justify the expectation that the model will be useful for other reservoirs and situations. The most useful models are those that were tested with data from many different localities, including different parts of the world, and, optimally by different people. A model might be well-suited for one reservoir condition, but not necessarily suitable for other reservoirs with different conditions. Very often models that are suitable in one geographic territory are not as useful in others. A situation often encountered is that most models have been developed and tested under temperate Northern Hemisphere conditions and their application in tropics or in temperate Southern Hemisphere regions does not provide comparable results.

14.4 SIMPLE CALCULATION MODELS

Models in this group are predominantly based on statistical elaboration of large datasets. Therefore, they are limited by the extent of material covered in the analysis. Often, data are not adequately representative, particularly reservoir data. This is because the reservoir ecosystem is highly dependent on hydro-meteorological inputs with high variability. The applicability of these models can be very limited if the input data used for characterizing the environment were from a small number of seasons, localities, or from a restricted area. If several data sets are treated independently, the resulting statistical approximation often varies from one data set to another. However, not just the equation that represents the average relationships between different variables can be deduced from the data, but also the variability of this relationship. If this is taken into consideration, differences between individual approximations can either appear insignificant or may appear very important. Very often, the data set contains localities of different character, e.g., both lakes and reservoirs, shallow and deep lakes, calcareous and non-calcareous localities, humic and nonhumic reservoirs, highly throughflowing and stagnant reservoirs, etc. The proportion of localities of different character varies from one data set to another and this decreases the prediction capability of the simple models. It is particularly inappropriate to expect, from such generalized relationships, that each reservoir will behave according to the results of the model. It should be understood that only average behavior of a series of localities is obtained, and each locality behaves differently to some degree.

Many empirical chlorophyll-a (CHA) vs. total phosphorus (TP) relationships that are represented in the literature serve as a good examples of this truism. In spite of individual differences, all have increasing concentrations of CHA with increasing TP and increasing levels of reactive (orthophosphate) phosphorus (OP) in common. However, these parallel increases are only valid up to a certain concentration of TP and then terminates (Straškraba 1985, Prairie *et al.* 1989, McCauley *et al.* 1989). The average saturation limit is around 100 $\mu\text{g l}^{-1}$ for TP and about half that amount for OP. These values are simply orientative, as individual lakes do not necessarily follow this average trend. Not only can the curve be shifted up or down, but individual years can fluctuate due to the effect of variables other than phosphorus concentration. There is large variability in the responses of algae to OP and TP because large differences in the fraction of TP

available to algae can occur. From both theory and observations, we know the following: shallow localities can bear more CHA than deep localities; waterbodies with balanced fish populations have less CHA because fish control zooplankton by grazing; and, phosphorus in calcareous lakes, and likewise algae, are co-precipitated with calcium.

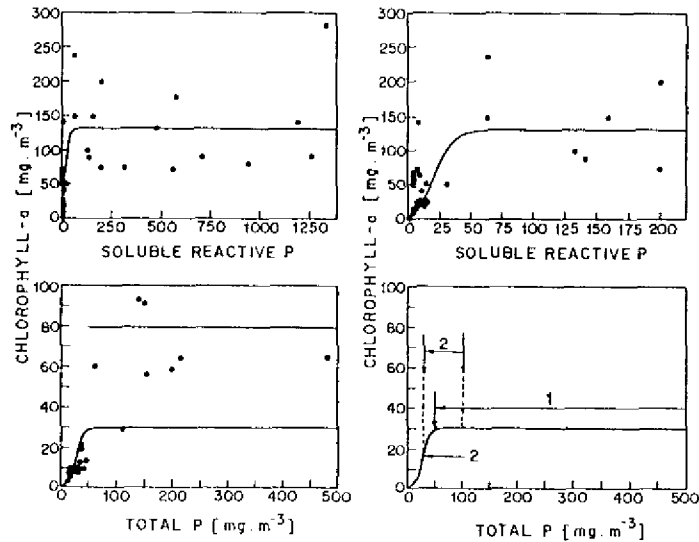

Fig. 14.1 A simple empirical model for the rough relation between the seasonal average phosphorus concentration in the reservoir and seasonal average chlorophyll-a concentration. A and B - the same observations from England showing the whole range and the selected lower range of $\text{PO}_4\text{-P}$ concentrations. C - difference between deep waters (lower line) and shallow waters (upper line). D - 1 shows the range of TP concentrations in which the concentration of CHA is not affected. A decrease of concentration from $500 \text{ mg}\cdot\text{m}^{-3}$ to about 50 need not produce any decrease of CHA, while a much smaller decrease, labeled 2, produces a very significant decrease.

This also implies that maximum CHA concentration, achieved during TP saturation, will differ in accordance with these effects. As shown in Fig. 14.1, this asymptotic character is very important in estimation of the response of a reservoir in decreasing TP (and/or OP) concentration. When the concentration is very high (above the saturation limit), reduction of TP by more than one half can still fail to effect CHA, whereas in TP concentrations that are below saturation limits, the response is dramatic. However, another complication must be considered; the decrease of external input of phosphorus to the reservoir is not necessarily accompanied by a corresponding decrease in lake concentrations. This is because phosphorus can be accumulated in reservoir sediments to such a degree that continual release can result in saturation for years. In this case, the response of the reservoir to decreased phosphorus input by a corresponding decrease in CHA levels is deferred.

Another model of this category is the Benndorf - Uhlmann model (Uhlmann *et al.* 1971, Benndorf *et al.* 1975) which estimates the efficiency of pre-impoundments in reducing

phosphorus (OP) concentrations. This model was broadly applied following a technical norm in the former East Germany (Pütz *et al.* 1975). The model is graphic (Fig. 14.2) and enables estimations based on easily available data. The main goal is to calculate pre-reservoir phosphorus retention based on light availability at the given locality and theoretical retention time. The model specifies a critical retention time, below which phosphorus retention does not reach full capability. Pre-reservoirs that are constructed for phosphorus reduction should have a volume related to flow that yields an optimal critical retention time (taking seasonal variability of flows into account). This allows maximum phosphorus reduction for the lowest possible reservoir construction and maintenance costs. It is important to consider the limited lifetime of the pre-reservoir (if no periodic cleaning is accomplished), during which phosphorus accumulates in the sediments. This model was extensively and successfully tested in several localities, including areas in Germany and South Africa (Twinch & Grobler 1986).

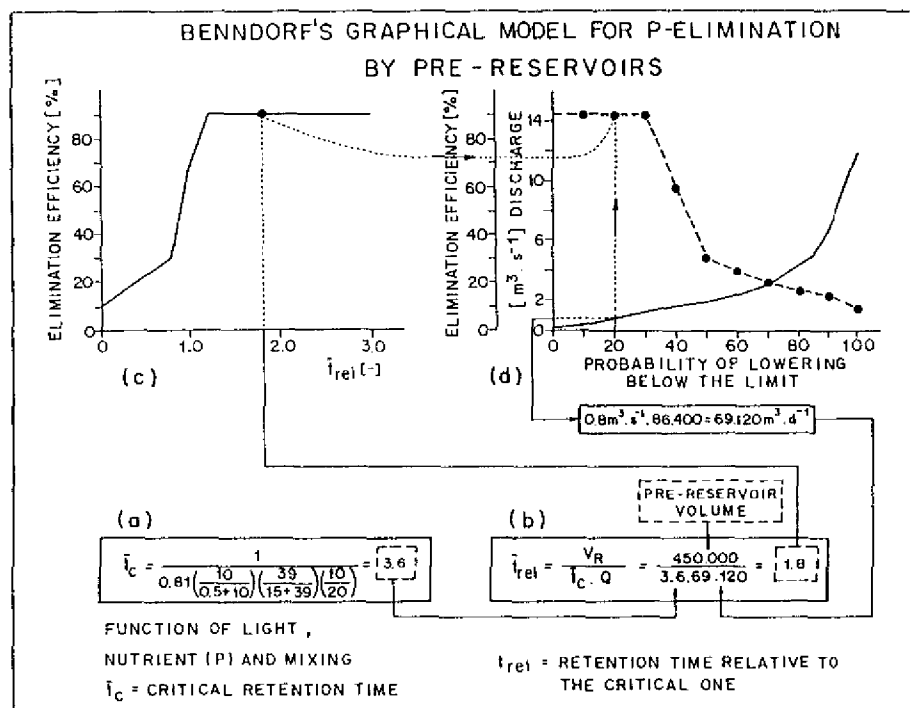

Fig. 14.2 Explanation of Benndorf's graphical model for PO₄-P-elimination by impoundments. We know the pre-reservoir volume and discharge of its inflow recalculated to $m^3 \cdot day^{-1}$. First we calculate in part (a) the critical retention time, t_c . The numbers in three parentheses are for the function of light, of the critical nutrient and mixing (not explained in detail here). From t_c we calculate in part (b) the retention time relative to the critical one, t_{rel} . From the graph (c) we can now read that the elimination efficiency will be in this case 90%. In the graph (d) the dashed line representing the relative elimination curve is calculated, corresponding to the full line giving the probability of not exceeding the given flow rate that we have to know for the given locality.

Many simple calculation models are successfully used in water quality management. Those with the broadest uses are models that estimate the load of various elements based on the land-use pattern. Examples are AGNPS by Young *et al.* (1989) for analysis of agricultural non-point source pollution, TETrans by Corwin & Waggoner (1991) for analysis of TP load in reservoirs, and **Catchment Resource Assessment Model (CRAM)** by Chapman *et al.* (1995). These models consist of specific load coefficients that correspond to different types and units of land use. The actual computation for a given locality is obtained by multiplying specific coefficients by the number of corresponding units (areas of various types of land cover, population numbers, number of domestic animals of different species, etc.). To assist in calculations of specific areas, GIS is included in some models. This is used to map various land uses, soil types, and other characteristics of the territory. We must bear in mind that individual specific coefficients differ between regions with different soil types, agricultural practices and other characteristics. The morphology of the landscape, distance of areas from water, mutual relationships, etc. are also important and variability can be observed in close-by localities.

Some other more broadly applicable models are listed in Tab. 14.1. Each entry is supplied with information about the model use. This may help the user estimate the need for more verification before application and may help judge the degree of uncertainty involved in use of the model.

Tab. 14.1 Simple models that are most useful for estimation of various reservoir features and prediction of responses to management plans.

MODEL	AUTHOR	APPLICABLE REGION OF MODEL USE
* Nitrogen retention by shallow reservoirs	Kelly <i>et al.</i> 1987, extended by Howarth <i>et al.</i> 1996	N. Hemisphere
* Phosphorus retention by stratified reservoirs	Straškraba <i>et al.</i> 1995	N. Hemisphere
* Retention of organic matter by reservoirs	Straškrabová 1976	Central Europe
* Hypolimnetic oxygen demand by reservoirs	Staufe 1987	United States
* Lake Number Model - specification of stratification	Imberger & Patterson 1990	Australia
* Temperature stratification model RESTEMP	Straškraba & Gnauck 1985	Central Europe
* Model of DO and P in stratified lakes	Chapra & Canale 1991	United States
* Model of end-of summer oxygen profiles in lakes	Molot <i>et al.</i> 1992	United States
* Model of hypolimnion discharge scenarios	Horstman <i>et al.</i> 1983	United States

14.5 COMPLEX DYNAMIC MODELS

For purposes of modeling rivers and reservoirs, Ambrose *et al.* (1982, according to McCutcheon 1989) distinguished the following four levels based on criteria given below:

- Level 1 - Steady state solution, simple kinetics;
- Level 2 - Steady hydrodynamics, specified or handled empirically, steady or time variable water quality;
- Level 3 - Unsteady hydrodynamics, but simplified solutions, simplified reservoir solutions, dynamic water quality; and,
- Level 4 - Unsteady hydrodynamics with full equation routing, ability to handle backwater and stratified reservoirs, dynamic water quality.

In dynamic models, we distinguish **state variables** - those obtained by solving the model, **site constants** - those that characterize fixed features of the waterbody such as morphometry, and **forcing functions** - those that describe inputs that change annually, such as solar radiation, flow, inflow phosphorus concentration, and **parameters of the biological components** of the system such as characteristics of light saturation of the phytoplankton. **Model inputs** consist of data that characterize the specific reservoir and situations for which the model calculation is to be performed.

The question which level is appropriate for a particular application will depend on several circumstances. This topic is discussed in Chapter 14.9.

For each level we have included a small selection of models that have been used fairly extensively and are recommended.

Level 1

A typical level one model is LAKE, produced by ILEC (Jørgensen 1992). LAKE is not limited to use on reservoirs and is more of a teaching tool than an application model. For a sequence of n-years, LAKE calculates the following state variables: annual average concentrations of TP, CHA, biomass of zooplankton and fish, as well as average and maximum primary production and fish yield. The inputs that have to be entered are the annual phosphorus and nitrogen load and exchange coefficient for sediment phosphorus. Switching between TP and N limitation of phytoplankton is included. However, only TP and N are calculated as dynamic state variables, the rest is based on empirical relations.

Level 2

Lung Phosphorus Model was produced by Lung & Canale (1977). Model input consists of lake loads of particulate and dissolved phosphorus, which are the only state variables of this model. Algal development is not modeled. Important processes include phosphorus sedimentation and exchange of phosphorus between water and sediments.

A model by Jørgensen *et al.* (1978) has been very successful. It was first applied to Lyngby Lake from 1952 to 1958 and later was applied to analyze changed conditions in the period from 1959 to 1975. The model closely matched changed conditions caused by conveyance of wastewater to the sea and increased nutrient concentrations in tributaries.

AQUAMOD 3 by Dvořáková & Kozerski (1980) and Straškraba & Gnauck (1985) is a three layer model with the mixing zone, hypolimnion and sediment layer empirically specified. In

addition, it is possible to calculate the metalimnion thickness and exchange of phosphorus and algae through the layer. The state variables are phosphorus, phytoplankton and zooplankton. It is particularly appropriate for reservoirs because retention time is treated as an important driving function.

SALMO (Benndorf & Recknagel 1982) is a model that includes schematic distinction between the epilimnion and hypolimnion to enable examination of interactions between phytoplankton biomass and changing external nutrient load, temperature, light, mixing and zooplankton grazing. The model SALMOSED (Recknagel *et al.* 1995) is newly developed and enables input regarding two types of sediment layers and exchange of phosphorus between water and sediments. The original model was applied to reservoirs in Eastern Germany and SALMOSED was applied to a lake of medium depth, Lake Yunoko, Japan.

CE-QUAL-RIVI is a model appropriate for crude planning analysis of reservoir eutrophication (Bedford *et al.* 1983, Anonymous 1986 - manual for application) and was used fairly widely in U.S.A.

WASP4 (Ambrose *et al.* 1988) covers hydrodynamics, conservative mass transport, eutrophication, dissolved oxygen kinetics and toxic chemical - sediment dynamics. It is mainly useful for rivers, but lakes can also be simulated.

MINLAKE (Riley & Stefan 1988) is an extension of RESQUAL II, an earlier model, and was recently extensively modified to allow estimation of the effect of climate changes on USA lakes (Stefan & Fang 1994).

BLOOMII by Los (1991), which was developed to examine eutrophication of shallow lakes, was elaborated to produce the model DELWAG-BLOOM-SWITCH, a management model for eutrophication control in shallow lakes. The model is extensively used in The Netherlands.

MIKE is a dynamic water quality model existing in a number of versions, of which MIKE12 (Ecological Modelling Centre 1992) is a model with a simplified two-layer representation applied also to reservoirs.

Canale & Seo (1996) and Seo & Canale (1996) have estimated the prediction errors of eight total phosphorus lake models (i.e., models that predict only (or also) annual changes of total phosphorus concentrations) during seven years of observations in Shagawa Lake, Minnesota, and found that models that do not adequately account for sediment effects produce large errors. Low errors were found for the two original models by Seo called CONSTANT SEDIMENT FEEDBACK PHOSPHORUS MODEL and MECHANISTIC WATER-SEDIMENT MODEL, Chapra & Canale's (1991) total phosphorus model which contains only one variable and one coefficient, and Lung & Canale's (1977) model described above. Seo & Canale stress that a non-linear relationship exists between model complexity and prediction capability of phosphorus models; accuracy increases only up to a limited (low) model complexity and then decreases markedly. Straškraba (1995) demonstrated that the prediction capability of chlorophyll-a models does not significantly increase in those that are more recently developed or more complex.

Similar to the phosphorus models, the standard error of prediction is approximately 50%.

Level 3

Hydrologic simulation program - Fortran (HSPF) is a model designed for detailed management analysis of watersheds that incorporates the effect of watershed processes on stream water quality. The model enables input of data regarding stream reaches, nonstratified reservoir reaches, and a choice of two overland runoff components. It predicts up to 22 variables and was used in several applications in USA.

Level 4

DYRESM is the most widely used reservoir hydrodynamics model and has been applied in a number of European, American and Asiatic localities, as well as a number of localities in Australia (Imberger & Patterson 1981, Imberger 1982). The model is continuously being improved. A recent version is two dimensional and enables simulation of the horizontal spread of inflow into different layers of the reservoir (Hocking & Patterson 1991). The recently derived DYRESM-WQ (**D**ynamic **R**eservoir **S**imulation **M**odel for **W**ater **Q**uality) covers water quality variables (Hamilton & Schladow 1995) and is commercially available from the Water Research Centre of the University of Western Australia at Perth, Western Australia. The model simulates stratification and flow conditions, phytoplankton assemblages, nutrient levels (different forms of phosphorus and of nitrogen), dissolved oxygen, BOD, iron and manganese, and sedimentation of detritus. A version that is currently in preparation will include the processes of phosphorus exchange with sediments.

The Finnish three dimensional water quality-transport model is a coupling of a hydrodynamic and ecological model. It was used for a number of Finnish lakes and reservoirs (Virtanen *et al.* 1986) and is continuously updated.

ASTER and MELODIA are models that were applied in France to models stratification and biological conditions in the Reservoir Pareloup, which belongs to an extensive reservoir multisystem (Salencon & Thébault 1994).

14.6 WATERSHED AND REGIONAL MODELS USING GIS

IIASA and RAISON are two largely used information systems that were specifically developed for water quality problems. The system developed over years at IIASA (e.g., Fečra *et al.* 1990) is applicable for different territories for which mapped or tabular data exists. The system is capable of processing data and then combining results for a particular purpose and is able to make management predictions.

RAISON was developed by a group led by D. Lam of the National Water Research Institute in Canada (Lam *et al.* 1994). The name is an abbreviation for "**R**egional **A**nalysis by **I**ntelligent **S**ystem **o**n a microcomputer. It is considered an expert system (Chapter 14.8). The knowledge base stores and manipulates information such as documents, rules, models and scanned

photographs. For example, one can browse the knowledge base, search for keywords or phrases in a document, and display a map of locations where the keywords are found. The inference engine, a part of any expert system, is used to discover and analyze patterns in data or knowledge records, i.e., constructing rules based on an induction model through generalization from specific examples. Also, rules or examples by experts can be entered directly into the system and there is also a fuzzy logic option for those cases where the value of an attribute is not precisely definable. The system is extensively used for purposes such as analyzing regional drinking well data, analyzing satellite images to yield water quality data, and visualizing results of hydrodynamic modeling of lake circulation and contaminant transport. A world-wide database of water quality characteristics in a number of lakes and reservoirs is available from ILEC (Data Book of World Lake Environments, 1991). This allows examination of water quality in a given geographic region and selection of situations that closely resemble that which interests the user. It also enables input of new data from specific localities, including detailed geographical maps and maps provided by other relevant disciplines, such as soil surveys, vegetation cover maps, and data regarding water use and demands.

14.7 MANAGEMENT (PRESCRIPTIVE) MODELS

This category comprises fourth generation models that are very useful for management, however, they are very complicated and difficult to use. Practical use of these models by water quality specialists is very limited and cooperation with a computer center or research institution is usually necessary. These models are also known as optimization models because they use an optimization procedure to determine best performance of the study system under specified criteria.

These models are either based on simple static calculations or dynamic simulations, depending on whether a time-independent or time-dependent solution is required. The difference between these is that, besides different parameters that characterize the given situation, parameters that can be manipulated are distinguished. Consider the case of a descriptive eutrophication model that predicts concentrations of chlorophyll and other important water quality variables like oxygen for a reservoir, based on parameters that characterize conditions in the inflow river and the reservoir. The manipulation possibilities are expressed as parameters that can be changed by management. For instance, it is possible to decrease the critical nutrient load by constructing tertiary purification plants or other means. It is also possible to induce artificial mixing up to a given depth and apply biomanipulation techniques. These management options affect model parameters and the model is capable of calculating consequences on water quality that were caused by changes in these parameters. The major component of an optimization model is called a **goal function**. This is the function that the user seeks to minimize or maximize (mathematically, both maxima and minima represent optima). The goal function could be to maximize the oxygen or other critical water quality variable level, or to minimize the amount of money spent on attaining a specified level of water quality improvement. Optimization with constraints means that some or all of the management parameters are limited, i.e., they must remain within specified limits due to natural conditions, management limitations, etc. The following examples illustrate these kinds of constraints:

- (1) inflow phosphorus levels cannot be reduced more than the capabilities of treatment plants or other reduction methods enable;
- (2) it is impossible to mix a waterbody beyond its greatest depth, and there is a natural depth of mixing; and,
- (3) there is no feasible reason to reduce the level of chlorophyll or increase the concentration of oxygen above a certain limit.

Another use is a query of the optimum combination of options to use in the given reservoir when limited funds are available for improvement of water quality. Of course, the same reservoir will behave differently in different years due to the effects of weather and associated differences in flow rates, phosphorus loads, etc.

Today, multiparametric formulation is used most often because it offers many management options. Multi-goal formulation is even more complex because it allows several goals to be followed simultaneously. Examples of this type of formulation and its advantages will be provided in Chapter 14.8.

It must be understood that optimization procedures only select among possibilities included in the model and are limited by the validity of the model, including its assumptions and formulations and the constraints imposed. Therefore, model conclusions should be used with caution and the user should consider the limitations of the model, possible inadequacies of its formulation, and possible insufficiency of input data.

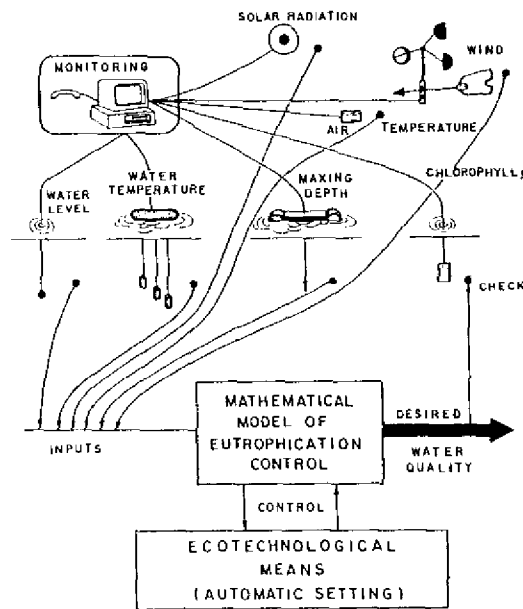

Fig. 14.3 The use of automatic monitoring in connection with an online mathematical model to control eutrophication.

Two basic types of management models are distinguished: prediction models and operational models. The first are intended for long-term horizons and off-line functions. By off-line function, we mean that the model is run before any decision is made and several alternatives are investigated. Operational models are intended for on-line use, while the computer is connected to automatic devices that provide information about the state of reservoir water quality and is also connected to devices that activate water quality management options. For instance, chlorophyll concentration and meteorological parameters can be automatically recorded and fed into the computer model. Short term predictions by the model can be used to switch mixing devices on or off, or to specify the intensity of phosphorus purification (Fig. 14.3). Examples of such on-line operational water quality management systems are provided in Tab. 14.2 together with planning optimization models that are useful for water quality specialists.

Tab. 14.2 Models for use in water quality optimization.

-
- * Dynamic optimization of eutrophication by phosphorus removal. Used for a Japanese lake (Matsumura & Yoshiuki 1981)
 - * Optimal control by selective withdrawal (Fontane *et al.* 1981)
 - * Optimizing reservoir operation for downstream aquatic resources. Applied on Lake Shelbyville, Illinois (Sale *et al.* 1982).
 - * GIRL OLGA for cost minimization of eutrophication abatement using time dependent selection from five management options (Schindler & Straškraba 1982). Applied on several reservoirs in the Czech Republic
 - * Stochastic optimization of water quality (Ellis 1987)
 - * COMMAS for prediction of environmental multi-agent system (Bouron 1991)
 - * DELWAG-BLOOM-SWITCH for management of eutrophication control of shallow lakes (van der Molen *et al.* 1994)
 - * GFMOLP, a fuzzy multi-objective program for the optimal planning of reservoir watersheds (Chang *et al.* 1996)
-

14.8 EXPERT AND DECISION SUPPORT SYSTEMS

Because these two model types are used for similar purposes and their handling by the user is similar, they are discussed together herein. Furthermore, expert systems are essentially portions of decision support systems (DSS). DSS were named for their ability to support decisions and are **not** intended to make decisions. Final decisions must always be made by wise, experienced people. However, in order to make adequate decisions, people need varying amounts of information that is often not easily obtainable. For such complex systems as water quality systems, it is difficult to preview consequences of different options because there are many nonlinear relationships and complicated interactions. DSS is a tool that provides managers with necessary information regarding potential consequences of various decisions. DSS uses both the experiences of numerous experts and capabilities of the computer to rapidly calculate many complex relationships. The interactive DSS function allows the user to try various versions of decisions under different possible situations, etc. (Fig. 14.4).

REH is an example of a water quality DSS and was prepared by a group of researchers associated with Prof. A. Gnauck at Brandenburgian Technical University, Cottbus, Germany

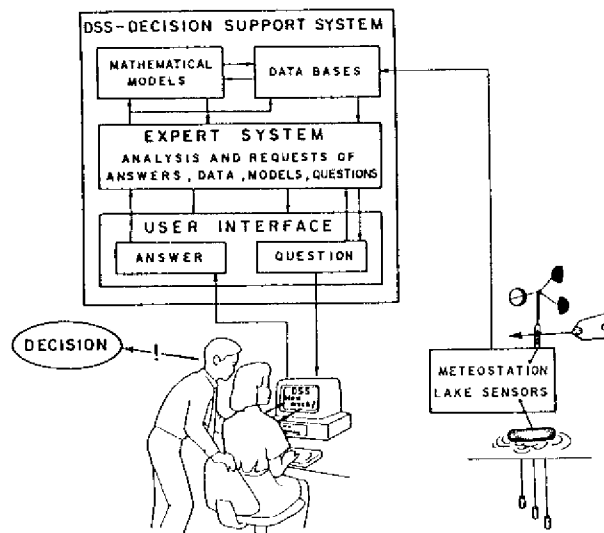

Fig. 14.4 The structure of a Decision Support System for water quality control.

(Gnauck *et al.* 1989). The system is intended to support the manager in multi-criterial decisions (up to 10 criteria), by interactively searching for a compromise between different levels of criteria satisfaction. To a certain degree, the compromise is subjective and the user must rank the criteria and satisfactory levels of fulfillment. The system is very plastic, but for each application a specific subroutine needs to be constructed in FORTRAN to answer the question. Recently, a reservoir water quality model GIRL OLGA was combined with the DSS REH and is currently under investigation in the Biomathematical Laboratory, University of South Bohemia at České Budějovice, Czech Republic.

Tab. 14.3 Decision support systems for water quality management

MODEL NAME	PURPOSE	AUTHOR
----	selection of control strategy for lake eutrophication	Grobler <i>et al.</i> 1987
----	DSS for environmental decisions	Fedra 1990
----	analysis of environmental catchment policies	Davis <i>et al.</i> 1991
MASAS	evaluation of micropollutants	Ulrich <i>et al.</i> 1995
AQUATOOL	water resources management	Andreu <i>et al.</i> 1991
HEC-3	multipurpose quantitative operation of reservoir systems	Hacstad Methods 1993

Only a few DSS are currently available for water quality management decisions. A review of these models is provided by Somlyódy & Varis (1992). Existing DSS are listed in Tab. 14.3.

14.9 SELECTION OF AN APPROPRIATE MODEL

The first step in selecting a model is specification of the exact desired goal for which the model will be used. The selected model must be one that is intended to answer the questions of interest. The type of model is much less important than the designated purpose because each model is specifically designed to answer specific questions and may be incapable of addressing other concerns.

Another selection consideration is the specific kind of data available for use with the model. Use of the most advanced models is impossible if the water quantities and qualities of reservoir inflows have not been measured. In some cases it may be possible to obtain data required to use the model, but this involves expenditures of money and time. Most water quality variables vary in accordance with seasons and flow rates.

Availability of personnel that are skilled in the use of models could be a significant limitation. Learning the use of models can be difficult and time consuming. Appropriate model selection requires balance between the importance of the problem, money, time, people and availability of the adequate models.

One warning bears repeating: models only produce a gross simplification of reality and caution is always necessary when considering model results. Moreover, three levels of uncertainties influence the use of even the best models (Hilborn 1987). These are:

- 1) noise - natural variability that occurs frequently enough to be routine (various sampling schemes and statistical analyses are required to accommodate this uncertainty);
- 2) states of nature that are not well known; and,
- 3) surprises - unanticipated events (flexible adaptive management strategies cope with surprise more effectively than rigid, dogmatic strategies).

These uncertainties are inherent in any complex system and may occur in any specific case.

CHAPTER 15

CASE STUDIES

In this chapter we have limited our discussion to four reservoirs, two of which are located in Czech Republic and two of which are located in Brazil. These reservoirs are located in the countries with which the authors are most experienced. The selection allows comparison between the temperate region and the tropical region; therefore, somewhat comparable reservoirs were selected from each region, namely, a cascade power generation reservoir and a drinking water reservoir. Of course, exact comparisons are not possible: e.g., the Brazilian reservoirs are shallower than the Czech reservoirs. The difference between temperate and tropical reservoirs is not only influenced by geography, but also by different land use patterns and economic and cultural differences.

15.1 SLAPY RESERVOIR, A TEMPERATE CASCADE RESERVOIR

Slapy Reservoir (Tab. 15.1) is an example of a temperate cascade reservoir with intermediate retention time that is used for power generation.

Tab. 15.1 Basic data about Slapy Reservoir

Location	Czech Republic
River	Vltava
Geographical coordinates	49°37'N, 14°20'E
Elevation	271 m a.s.l.
Surface area	13.1 km ²
Catchment area (40% forest, 50% intensive agriculture)	12900 km ²
Volume	270 10 ⁶ m ³
Maximum depth	53 m
Mean depth	21 m
Length	44 km
Shape: riverine, average width	300 m
Filled in the year	1954
Normal range of annual water level fluctuations	5 m
Theoretical retention time	38 days
Primary use	power generation
Other uses	local water supply, recreation
Trophic status	meso/eutrophic

Slapy Reservoir is one of the few localities in the world (both freshwater and terrestrial) for which long-term detailed ecological observations exist. Observations have been recorded at Slapy Reservoir since it was filled in 1954. A long series of standard measurements of a few individual water quality variables have been recorded for many lakes and reservoirs, but the observations

of Slapy Reservoir are much more complete, and include physical, chemical, bacteriological, plankton and fish observations. This was accomplished by a team of experienced limnologists of what is now known as the Hydrobiological Institute of the Czech Academy of Sciences (during the first few years observations were recorded by a team at the Water Research Institute). The location of the reservoir on Vltava River (= Moldau of the composer Dvořák) enables some comparisons with the ancient and recent status of the river. Climatic and daily water temperature data from several spots within the cascade were available from the database of standard measurements maintained by the State Hydrometeorological Institute. From 1976 to 1982, detailed automatic recordings were collected at a site that is 9 km upstream the dam, and is the location of hydrobiological field station.

The following three **phases of development** of Slapy Reservoir are differentiated:

Period 1 - period 1954 - 1961, before upstream construction of Orlik Reservoir (Volume 722 10^6 m³, length 75 km, maximum depth 70 m, completed 1960) with Kamýk Reservoir (13 10^6 m³), its re-regulation step;

Period 2 - period 1962 - 1966, after the construction of Orlik and Kamýk reservoirs; and,

Period 3 - period 1967 - today, since the operation of old paper mills in the upper reaches was stopped in 1966.

Recent years, following political changes in the country, may represent another period, that is characterized by a decrease in nutrients and other pollutants due to decreased field fertilization and increased environmental awareness.

In the **first period**, two important developments coincided: the processes of reservoir aging and high trophic development caused by the inflow from the Vltava River that was loaded with nutrients from the wide catchment. In this period the reservoir was highly eutrophic, with dense summer blooms of Cyanophyta (predominantly *Aphanizomenon flos aquae* and *Microcystis aeruginosa*) that reached an annual average of more than 4 mg.l⁻¹ fresh weight, but maxima reaching up to 25 mg.l⁻¹ for the top 3 meters. The reservoir water was very brown due to effluents from paper mills in the upper reaches of the Vltava River (up to 200 km upstream of the reservoir). There were also large bogs in the upper reaches but their contribution to the color of Vltava River, some 150 km downstream was negligible, as was clearly demonstrated after the paper mills were closed in the third period. The transparency was low due to both dissolved organic matter and eutrophic conditions. Primary production was hindered by the high color, which reduced light penetration, but phytoplankton biomass was high, due to the high phosphorus and nitrogen concentrations. Benthos in the river reach of the reservoir was composed mainly of tubificids living in the deep anoxic sediment that accumulated. In winter, there was a layer of ice, that was thick and strong enough to support light vehicles. The shores of the reservoir were mostly uninhabited, but slowly became a recreation site, including construction of summer huts. Temperature stratification corresponded with the dimictic type that is characteristic for the region, but was modified due to the short retention time.

In the **second period** the trophic levels in the reservoir dropped dramatically, because large quantities of nutrient were trapped in Orlik Reservoir. The average phytoplankton biomass dropped to about 2 mg.l⁻¹ fresh weight. Instead of a free river with a natural temperature regime, inflow to Slapy Reservoir was now composed of cold hypolimnetic waters from Orlik, with

temperatures that were barely modified by passage through the Kamýk re-regulation reservoir. Temperature stratification changed, and deepwater temperatures were lower than before. The ice was reduced during winter months but remained thick enough to support pedestrians and allow sample collection. The heavy blooms of Cyanophyta disappeared; they were shifted to Orlik Reservoir where they eventually resulted in degradation of tourism and recreation. The phytoplankton composition became more mesotrophic/slightly eutrophic in character. Spring phytoplankton was dominated by diatoms, whereas in summer, green algae with Cryptomonadina were dominant. Slight Cyanophyta blooms appeared every summer after 1980. Color decreased, but the decrease was minor due to the slow rate of decomposition of colored organic matter from paper mills. Recreation pressure on the reservoir increased, and by 1963 there were about 3000 houseboats and many huts, recreation centers, hotels, and camping facilities on the reservoir shores.

Budget calculations in the **third period** enabled demonstration that decreases in the organic matter after closure of old paper mills in the upper reaches corresponded with decreased effluent levels (new paper mills with insufficient water purification were still running). Water transparency increased by about twice the previous level, from 0.5 - 2 meters to 1.5 - four meters. There was a steady rise in concentrations of nitrate and total nitrogen, but ammonia remained consistently low. Since the beginning of detailed studies in 1960, the concentrations of nitrate nitrogen rose from about 0.5 mg.l⁻¹ to almost 5 mg.l⁻¹ in the 1990's. The amounts of chlorides, sulfates and calcium increased simultaneously at nearly the same rate, and conductivity did likewise. There was no corresponding increase in phosphorus concentrations; a recent study demonstrated this is due to the phosphorus retention capacity of Orlik Reservoir.

Comparison of **detailed observations** from all three periods enabled recognition of major differences between a solitary and cascade reservoir in the same locality. The long-term series of limnological measurements taken during a wide range of flow conditions enabled recognition of the influence of retention time on stratification and other water quality variables. This became the basis for reservoir classification and management. Phosphorus limitation of phytoplankton production became apparent and the asymptotic character of the phosphorus - CHA relationship was derived for the first time. The function of fish populations as controlling agents of trophic levels in the reservoir was recognized.

Over the course of the three periods several **management problems** occurred. The high level of trophic development degraded recreational uses, recreation activities impaired water quality, sources of high levels of nitrates and other salt concentrations were introduced by agriculture, and high phosphorus concentrations that were input by untreated sewage resulted in the development of Cyanophycean water blooms. Since the 1970's the capital of the Czech Republic, Praha (= Prague) began to experience water shortage and new sources were sought. One potential source that was investigated was treatment and distribution of Slapy Reservoir water. This instigated some restrictions on shoreline and water recreation, including prohibition of recreational houseboats and motorboats.

More detailed information about Slapy Reservoir is available in the ILEC "Data Book of World Lake Environments (1991)".

15.2 BARRA BONITA - A SUBTROPICAL/TROPICAL CASCADE POWER GENERATION RESERVOIR

The Barra Bonita Reservoir (Tab. 15.2) is an example of a subtropical/tropical cascade reservoir with an intermediate retention time, that is used for power generation.

Tab. 15.2 Basic data about Barra Bonita Reservoir

Location	Brazil, State São Paulo
River	Tieté and Piracicaba
Geographical coordinates	22°29'S and 48°34'W
Elevation	430m
Surface area	
Catchment area (30% forest, 50% intensive agriculture, 20% pasture)	324.84 km ²
Volume	3.6 10 ⁶ m ³
Maximum depth	25 m
Mean depth	10 m
Length	48 km
Shape: riverine, average width	2 km
Filled in the year	1963
Normal range of annual water level fluctuations	5 m
Theoretical retention time	90 days
Primary use	power generation
Other uses	local water supply, recreation, sport fisheries
Trophic status	eutrophic

The **seasonal cycle** of air temperature typically changes by only 15°C between winter and summer. Rainfall normally occurs between September and March, followed by a six months dry period. Yearly cumulative precipitation ranges between 1200 and 1500 mm. Maximum wind velocity of 20-25 km.h⁻¹ occurs in the winter (July - August). Rainfall, wind and flushing rates are the major forcing functions in this reservoir.

The reservoir water volume and water level are related to both climatological factors such as rainfall or dry periods, and to water uses. In a typical year, the total flushing rate oscillates between 190 m³.s⁻¹ to 570 m³.s⁻¹. The average yearly flushing rate is 344 m³.s⁻¹. Changes in the flushing rate are an important forcing function in this system, and they rapidly modify ecological conditions both within the reservoir and downstream.

Two main rivers flow into the reservoir: Piracicaba and Tieté. There are considerable differences in water quality when the water of two rivers mix in the main reservoir. This produces extensive spatial heterogeneity and other special conditions. Differences in the spectral composition result from varying concentrations of dissolved organic matter and particulate matter in the rivers and the reservoir. Other sources of spatial heterogeneity include small rivers that flow into the reservoir, and shallow bays or other areas of low circulation. Additional causes of spatial heterogeneity in the reservoir are macrophyte stands and gallery forests along the small tributaries. The reservoir has several compartments that were visible on a satellite image. These

compartments are characterized by different degrees of reflectance in the water masses resulting from various concentrations of dissolved organic matter, biomass, and other suspended material.

Nutrient input into Barra Bonita Reservoir has two components: non-point sources from agricultural activities such as sugar cane plantations and cattle production, and point sources that originate along the main rivers and tributaries (including sewage discharge). Geologic flux is related to soil use and contribute 658 tons of phosphorus and 12,175 tons of nitrogen per year. The hydrological flux of nitrogen is 25,389 tons.year⁻¹ for the Tieté River and 26993 tons.year⁻¹ for the Piracicaba River. For the Tieté River, the predominant form of nitrogen is ammonia and nitrite. In the Piracicaba River, nitrite is the predominant form of nitrogen. Total phosphorus contribution of both rivers amounts to 1,545 tons.year⁻¹.

A particularly important source of **impact** to Barra Bonita Reservoir is suspended materials that peak in the summer and produce drastic changes in the water quality, particularly in terms of dissolved oxygen concentration and light penetration. Mass fish kills are related to the high concentrations of suspended material. Overall sources of impacts to Barra Bonita Reservoir can be summarized as follows:

- * N and P inputs from non-point and point sources (including sewage discharge);
- * Input of suspended material from agricultural activities, and runoff during precipitation;
- * Navigation;
- * Tourism and recreation;
- * Deforestation in the watershed; and
- * Introduction of exotic species of fishes.

The consequences of these impacts include the following:

- * Eutrophication;
- * Siltation;
- * Excessive growth of macrophytes;
- * Blooms of Cyanophyta (*Microcystis* sp. in summer and *Anabaena* sp. in tropical winter); and
- * Loss of native fish species.

The reservoir **management plan** is primarily based on watershed management. The watershed of the Barra Bonita Reservoir is used for agricultural activities such as sugar cane plantation. Thus one of the main objectives of the management plan is to control inflow of non-point sources of phosphorus, nitrogen, organic matter and other pollutants into the reservoir. This can be achieved through the use of proper agricultural practices and protection of the reservoir shore by use of native vegetation. The plan specifies the use of native species remaining in protected forest fragments near the reservoir, as a seed source for reforestation efforts. Another important component of the management plan is protection of riparian forests along the tributaries and protection of macrophyte stands in the upper reservoir that function as nutrient traps and denitrification sites. The management plan also includes intensive use of the pelagic zone by introduced fish species. In many reservoirs the pelagic zone is not efficiently used by the native fish community and management strategies offer this possibility. Subdivision of the watershed into smaller units is another feature of the plan. This measure seeks to facilitate rapid implementation and application of the plan. Controlled operation of the spill water to remove

Microcystis sp. blooms in the summer and *Anabaena* sp. in the winter is another important management component.

Barra Bonita is intensively used for navigation by tourism and transportation vessels. Management will work to solve pollution problems related with these activities. A partnership between the public sector and the private companies responsible for navigation is being stimulated. The transportation vessels are also used for continuous water quality sampling. Surveillance by satellite imagery enables that changes in water reflectance that could result from input of suspended material or Cyanophyta blooms to be rapidly detected thus immediate mitigative measures can be taken. Continuous environmental education regarding water quality, watershed protection and river management are among the management goals. This will help the general public, students, and schoolteachers to engage in management activities. A continuous monitoring program is in progress.

15.3 ŘÍMOV RESERVOIR - A TEMPERATE DRINKING WATER RESERVOIR

Římov Reservoir (Tab. 15.3) is an example of a temperate drinking water reservoir with an intermediate retention time.

Tab. 15.3 Basic data about Římov Reservoir

Location	Czech Republic
River	Malše
Geographical coordinates	49°08'N, 14°30' E
Elevation	471 m a.s.l.
Surface area	2.1 km ²
Catchment area (40% forest, 50% intensive agriculture)	444 km ²
Volume	33.6 10 ⁶ m ³
Maximum depth	47 m
Mean depth	17 m
Length	13 km
Shape: riverine, average width	161 m
Filled in the year	1978
Normal range of annual water level fluctuations	3 m
Theoretical retention time, long term average	96 days
Primary use	drinking water supply
Other uses	-
Trophic status	mesotrophic

The long-term average theoretical retention time of this reservoir designates it as a transient type with stratification that is influenced by water flow. These effects are much less pronounced than in Slapy Reservoir which has a much shorter retention time. There is pronounced horizontal variability along the reservoir and phytoplankton peaks start in the inflow zone. Later, most of the phytoplankton shifts along the reservoir until it reaches the dam, so there is no correspondence between the phytoplankton production and biomass at the dam, because the biomass comes from the inflow region. The critical nutrient for phytoplankton development is phosphorus, which

reaches mean levels between 16 and 30 $\mu\text{g.l}^{-1}$ at the reservoir surface in different summers. Phytoplankton has a spring Cryptophyceae, and small centric diatom peak, followed by a "clear water phase" resulting from overgrazing of phytoplankton by zooplankton. Summer composition of phytoplankton is primarily large-celled and colonial algae and Cyanobacteria species.

Because this reservoir has been consistently monitored since construction, the data provide detailed observations on the **aging process** of reservoirs. The data support the new idea that aging is not just a consequence of increased nutrient and organic matter content during the first few years of existence. An important role is played by the differences in development rates of major groups of organisms and subsequent changes in biotic interactions. Development of fish populations takes a few years and, during this time, there is no control of lower trophic elements by predators (feeble or lacking top-down control).

Considerable attention was focused on the **effect of fish** on plankton, with particular respect to biomanipulation techniques. One condition for use of these techniques is complete knowledge of fish populations in the reservoir. According to data obtained by the classic capture - recapture method the biomass of fish larger than 10 cm varied between about 140 and 440 kg.ha^{-1} but up to 850 kg were present in the aging period. Reproduction of the most common fish species, perch (*Perca fluviatilis*), was intentionally reduced in some years by lowering the water level after egg-laying, so eggs were dried out near the shore. Changes in plankton composition were observed in years with high and low fish biomass. Specific field experiments were conducted to examine the effect of fish on possible prolongation of the "clear water phase" and lowering of phytoplankton concentrations, both of which are favorable for drinking water supply. An important function of the juvenile fishes was disclosed and a double beam echosounder was used to gain more exact data about their numbers and biomass. This modern technique provides accurate data about density and biomass of all fish sizes in the reservoir, particularly if coupled with classic techniques that simultaneously survey species representation. It was discovered that phosphorus limitation plays a role in the "clear water phase" in addition to zooplankton grazing, which is apparently the dominant force.

Intensive studies were focused on the **microbial food chain**. The results indicate that this previously neglected component has a major effect on cycling of matter in the reservoir. The main participants are bacteria, heterotrophic nanoflagellates and ciliates, the latter two of which feed on bacteria. Studies were conducted during years characterized by different fish stocks. The percentage of large-sized phytoplankton during summer peaks was significantly lower in the low biomass years, and the percentage of large cladocerans increased from very low values to 20% in the same years.

A new **automatic technique** called "clean layer" was designed to decrease the amount of coagulants used during drinking water treatment. The technique is based on the uneven water quality depth distribution in the reservoir and correlation between organic matter content and layer transparency. Automatic transparency measurements with a submersible instrument enabled the depth location of the cleanest layer to be revealed. As Řimov reservoir possesses multiple outlets, it was possible to take water for treatment from the optimum layer.

Successful cooperation between scientists and the agencies responsible for the reservoir management and water treatment enabled practical application of research results, however, controversy remained over the hydroelectricity production from the reservoir. The optimal strata released differs in accordance with water quality goals and hydroelectricity production goals. Additional complications are caused by summer cottages along the river below the reservoir, because the owners protest against release of cold water strata from the reservoir.

Drinking water supply from the reservoir suffers from excess algae, associated organic matter and increasing concentrations of nitrates. An increase of the water uptake to supply additional inhabitants was suggested. For these reasons, suggestions regarding ways to improve the water quality were formulated. These consisted of: (i) construction of a pre-reservoir; (ii) tertiary treatment of effluents from the town located upstream of the reservoir; (iii) change in agricultural practices to decrease the nitrogen load, and, (iv) application of biomanipulation techniques within the reservoir. Realization of items (ii) and (iii) were initiated. Biomanipulation techniques were attempted, however, in a very unsatisfactory and ineffective way. Cultivated fry of predatory perch-pike were introduced to the reservoir in large amounts, but their conditions before release did not guarantee their survival. Item (i) is a part of the larger goal of increasing water capacity, which was not realized because other solutions were found.

15.4 BROA RESERVOIR, A TROPICAL WATER SUPPLY AND RECREATION RESERVOIR

Broa Reservoir (Tab. 15.4) is an example of a tropical reservoir with a short average, but highly variable retention time, used for recreation and local drinking water supply.

Tab. 15.4 Basic data about Broa Reservoir

Location	Município de Itirapina, near S. Carlos, Brazil, São Paulo State
River	Lobo River, Itaqueri River
Geographical coordinates	22°15'S, 47°49'W
Elevation	770 m a.s.l.
Surface area	6.8 km ²
Catchment area (60% savanna, 20% agriculture, 20% forests)	227.7 km ²
Volume	22 · 10 ⁶ m ³
Maximum depth	12 m
Mean depth	3 m
Length	8 km
Shape: riverine, average width	300 m
Filled in the year	1936
Normal range of annual water level fluctuations	2 m
Theoretical retention time	20 days
Primary use	local water supply, recreation
Other uses	power generation
Trophic status	oligo/mesotrophic

Lobo-Broa Reservoir (commonly called Broa) was constructed with the initial purpose of

producing hydroelectricity. In the last 20 years, primary use of the reservoir changed to recreational uses and tourism due to the excellent water quality in the reservoir. In S. Paulo State, oligotrophic waters that are suitable for recreation are uncommon. A scientific study of the reservoir began in 1971, as a pilot project for research and training in ecology of reservoirs. The study that started in the reservoir was extended to the watershed.

The **Climate** in the vicinity of the reservoir is determined by equatorial and tropical air masses, with some influences of the cold fronts from the south in winter and autumn. The climate is characterized by the following data: annual isotherms between 19°C and 21°C; isotherms in the coldest winter month (July) between 15°C and 17°C; isotherms in the warmest summer month (January) 21°C to 23°C. Potential evapotranspiration between 900 and 1000 mm.yr⁻¹ and relative humidity is less than 75%.

The **reservoir hydrology and limnology** are determined by the climatological forcing functions, namely rainfall in the summer, and wind during winter and autumn. A constant wind along the main axis of the reservoir produces turbulence sufficient to produce homothermy.

Lobo-Broa Reservoir can be **divided into two regions**, each of which have approximately constant hydrological and ecological characteristics. The upper reservoir has abundant macrophytes and a wetland region. The lower reservoir is deeper, well mixed and vertically homogeneous. The upper portion of the reservoir is important for retention of nitrogen and phosphorus, and denitrification, thus is a protection area for the whole reservoir. Spatial distribution of limnological conditions is observed in this reservoir. This was demonstrated by C:N:P relationships, primary productivity of phytoplankton, zooplankton distribution, conductivity and dissolved oxygen levels. The upper reservoir region is also a nursery for several fish species.

Lobo-Broa Reservoir has a **management plan** that was implemented in 1979/1980, and proved to be very successful in maintaining the watershed landscape and water quality. This plan consisted in the following measures:

- * protection of wetlands and riparian forests along the tributaries and in all hydrographic networks; Protection of major tributary headwaters;
- * maintenance of macrophytes at the reservoir river entrance in order to maximize denitrification, phosphorus retention, and removal of suspended material;
- * maintenance of low retention time (maximum of 20 days of theoretical retention time);
- * maintenance of recreational areas and a community education system in order to foster preservation of the reservoir and good water quality;
- * a permanent garbage collection system to reduce solid waste impact; and,
- * development of a system of partnerships including the public sector, recreational companies and consortiums to share management responsibilities.

Maintenance of over 20 years of good water quality (conductivity has always ranged from 10 to 20 $\mu\text{S cm}^{-1}$) stimulated investments towards development of tourism. These were estimated to be 200 million US\$ in a 20 year span and included construction of buildings houses and shops, development of the tourist industry and creating a transportation infrastructure. Thus, good water quality generated high economic input into the region. The research, which the management plan

was based upon and first stimulated maintenance of good water quality in a good state, amounted to 5% of the costs returned and was mainly used to construct research facilities, buy necessary equipment and pay the salaries of researchers.

Impacts associated with humans activities are characterized as follows:

- * deforestation of gallery forests;
- * discharge of domestic sewage;
- * nutrient input through agricultural activities; and,
- * impacts due to recreation and sand mining.

Sand mining produced an episode of rapid deterioration in the upper part of the reservoir that resulted in the following consequences: (i) loss of transparency, and reduction of dissolved oxygen levels, (ii) destruction of the macrophyte stands, which interfered with fish reproduction and reduced fish stocks. Drastic changes were observed in zooplankton fauna: *Argyrodiaptomus furcatus*, which is typical of transparent oligotrophic water, was replaced by *Notodiaptomus iheringi* which is characteristic of turbid waters. This change was attributed to the inability of *Argyrodiaptomus furcatus* to filter large particles and subsequent outcompetition by *Notodiaptomus iheringi*, which is able to cope with large particles. After the sand mining plant was heavily fined and was required to install special filters, the reservoir recovered rapidly - in about six months. The zooplankton fauna returned to its original composition and *Argyrodiaptomus furcatus* still dominates the copepod fauna. This episode shows that, with the use of good indicators, recovery is possible within all system levels.

In addition to the examples above, the Lobo Broa **ecosystem research** has been used for several other activities, such as training of school teachers, science education, demonstration of comparative ecology of reservoirs and education of the general public.

More details about Broa-Lobo Reservoir can be found in Tundisi & Matsumura Tundisi 1995.

CHAPTER 16

CONCLUSIONS

Water is a necessity of life and a scarce commodity wherever the population size exceeds the availability of this finite resource. When this occurs, paradigms and mental images of water management shift and the concern about adequate water supply rapidly increases. We have dealt with this topic in previous chapters. This concluding chapter has the following goals: (i) to draw conclusions from the knowledge presented in this book to enable construction of future reservoirs that will optimize their water quality function, (ii) to assess future needs regarding different aspects of reservoir water quality management; (iii) to anticipate reservoir water quality consequences due to expected "Global Change", and, (iv) to predict the future demands of reservoir management.

16.1 GUIDELINES FOR FUTURE RESERVOIR CONSTRUCTION

The present knowledge how limnological concepts apply to water quality processes enables us to specify features of future reservoirs and their respective dams, which will optimize water quality. First, if drinking water supply is the main planned use of the reservoir, or if this use is anticipated, multiple offtakes are the condition for using effective options and selection of highest quality layers. In the same respect, several possible outflow levels to the downstream river are useful, for maintaining both downstream and reservoir water quality. Construction of the turbine outlets and spillways should be planned that maximizes oxygenation of water which is important for downstream water quality. As far as the character of the reservoir is concerned, a deep stratified reservoir is advantageous in temperate and subtropical region. The greater the depth, the better. In tropics a fully mixed reservoir might be advantageous to prevent formation of hypolimnetic anoxia. In terms of water quality several smaller reservoirs that are located at high elevations are much better than one large lowland reservoir, even if we disregard the possibility of combining several reservoirs into one system while selecting from the most suitable water quality among them. However, a water resource system only provides advantages if water quality is the dominant requisite, or is at least a subdominant aspect.

During the planning stages, watershed aspects are as important to water quality as the site for the dam itself. More effort should be focused on estimating present and future land uses and more investments are needed to utilize recirculation in plants, efficient purification of effluents including tertiary treatment to decrease phosphorus load, and best management practices in agricultural production. Agriculture that is located close to reservoir shores may have more negative effects than those that are remote. Preservation of forests and wetlands is of primary importance.

16.2 FUTURE NEEDS AND DEVELOPMENTS OF RESERVOIR WATER QUALITY MANAGEMENT

The greatest problem facing further development of water quality management is not technical, it is social, or rather psychological and educational. It is due to a need for change in the attitudes of engineers and managers, and progressive abandonment of outdated viewpoints that suggest that the present technology can overcome all problems. It appears that the use of brute force technology is, at present, creating more problems than it solves. We do not mean to negate the value of technology - it is quite necessary but we need to change our attitudes toward use of technology. The skills of wise engineers should be used to master the use of technology as nature knows it: creative, sensitive, fine tuned, systems oriented, rather than use one-sided brute force, which has no regards for secondary consequences and long-term effects. In the future, managers and engineers must make use of nature's possibilities and abilities during planning and construction activities, namely **ecological engineering**. They must master methods of management that are based on knowledge about methods of sustainable reservoir ecosystem function - **ecotechnology**. This requires deep thought, broader skills, and demands full use of human intellect.

More information exchange is needed between specialists of different disciplines, and particularly between specialists and the public. The public pays for water and must be informed regarding supply problems so that full cooperation is attainable. Information sharing is increasingly important particularly between North and South by means such as computer networking. In this respect ILEC plays an important role by organizing meetings and courses to train water quality specialists from the South.

A general trend towards more intensive water quality management is to be expected as the population pressure on the environment increases. This will include **operational management**, based on automatic monitoring, data evaluation and operational water quality control. At present, control automation is being mainly developed to control water quantity in different kinds of reservoir systems. We expect that reservoir systems and multipurpose reservoirs in densely populated areas will be the first candidates for the application of automated operational control of water quality. In respect to management methods, two orientations are desirable in the future: **preventive methods in the watershed** rather than corrective actions and **ecologically based methods** as biomanipulation and epilimnetic mixing examples demonstrate the merits of this orientation.

Limnologists and water quality specialists must move from collection of extensive, static data towards a **systems evaluation** and knowledge of underlying processes and comparison between reservoirs.

Remote sensing is a methodology that will definitely impact water quality management, particularly for large reservoirs. However, substantial extensions of present methods are needed. The approach was developed for oceans, which have a much more uniform physical, chemical and biological composition and corresponding optical properties are more easily distinguished than they are in reservoirs. For instance, optical properties of yellow organic matter that

dominates the ocean are already fairly well known (Jerlov 1976). However, application of this knowledge to freshwater, which differs in terms of composition and origin of organic matter and particulates predominating particularly in tropical and dry conditions, is very far from justified. Therefore, a number of ground level calibrations and theoretical studies must be completed before successful application of this method to fresh waters can be accomplished.

Mathematical modeling is expected to play an extensive role in water quality management. Although modeling is presently still within fairly early stages of development, it offers greater potential than is currently utilized. It is expected that specialized expert systems and incorporation of a number of specific models into decision support systems will be most useful. The inadequacies of the present models of reservoir water quality are due to the inclusion of many site- and case- specific parameters, which are difficult to estimate. Moreover, these models often fail to adequately predict the consequences of major changes of inputs or management options. This is because methods of representing adaptation of the biological components and the capability of the reservoir ecosystem to change the species composition and respective interrelations with the physical and chemical environment is currently under development. Also, the high degree of feedback effects between physical, chemical and biological processes is not presently incorporated.

We can distinguish these directions for further development of ecotechnology in regards to water quality management:

- a) methodological;
- b) economic and technological; and,
- c) ecological (limnological).

From the methodological point of view, there are many inadequacies in the current methods of determination of specific water quality variables. Some are appropriate for rapid automated in situ measurements, which enable information to be obtained regarding spatial distribution. Other variables require more lengthy laboratory analysis and are thus more difficult to assess. At present, sampling schedules are not optimized, and the "data rich but information poor" approach is prevalent, providing managers with large amounts of data, but few useful conclusions. The transition to automated operational management is difficult due to both technical and mathematical inadequacies.

World economics are unable to cope with the present trend of diminishing resources. It is now recognized that pricing systems must change considerably to reflect the full price of resources and environmental consequences including the needs of future generations. Nevertheless, development of a corresponding economic value system is slow and acceptance of the necessity of these changes by world society is even slower. Technology is driven by the present value system; environmental costs are not acknowledged and the belief of unlimited possibilities is still prevalent in the engineering world. "Ecological economics" is under development (see the special journal "Ecological Economics" that appeared recently). However, economic valuation is not in itself a full cure for these problems because an objective estimate of future values of, e.g., minerals that may support the future (unknown) technology is impossible to predict. Aside from "cleaner production" approaches mentioned in Chapter 2, we must develop other similar

philosophies. New market economy incentives such as "accountable pollution certificates" (e.g., Novotny, 1988) must be developed. We must also focus more on what is currently called the "participation principle", i.e., involving all responsible parties in the discussions and decisions that affect the environment. These parties may include industry representatives, environmental agencies, and interested public.

Ecological knowledge regarding aquatic ecosystems is still restricted to local empirical knowledge of basic interrelations between environmental effects and a few physical, chemical and biological variables, and to fairly raw knowledge of the processes involved in governing these ecosystems. For reservoirs, an additional difficulty is that many limnological investigations do not distinguish between natural and man-made lakes, and, in certain respects neglect the reservoirs systematic differences. The consequences of different shapes, outflows which are usually shallow in lakes and deep in reservoirs, retention times, etc. are often neglected. Knowledge of processes that drive water quality changes in waterbodies is mainly derived from experiments on components that are removed from the ecosystem context. Within the ecosystems, these processes may run differently due to variables not considered in the experiment, and different behaviors between cultivated and wild populations. Extremely rapid capabilities of organisms to acclimate and adapt to new situations are neglected and consequences of these phenomena are unknown. Much more knowledge is needed regarding the self-organization capability of the ecosystem and the self-structuring of aquatic ecosystems under changing conditions. Moreover, the multivariate character of processes and synergetic effects of variables are difficult to study and are presently inadequately understood.

Knowledge of reservoir water quality problems and potential solutions are not globally balanced. Waterbodies and water conditions are less understood in the South, however, knowledge and approaches from the North are not always applicable. More effort must be devoted to research and management of reservoirs in the South.

16.3 CONSEQUENCES OF GLOBAL CHANGES ON RESERVOIR WATER QUALITY

Global changes are associated with many events, such as the increased world population, resource over-utilization, increased technological development, and increased world globalization. One change that is particularly important in reservoir management is the expected world **Climate Change**.

In many parts of the world we are now observing an increase of major weather irregularities, particularly in temperatures and precipitation. These irregularities include both increases and decreases. Both extremes of these changes lead to increasing damage to reservoirs from empty reservoirs to flood damages. Both are also connected with deterioration of water quality.

The occurrence of erratic weather patterns is also expected to increase in the near future due to the effect of increasing amounts of greenhouse gases and changes in the landscape (particularly deforestation). It is expected that **Global Warming** or, more correctly, **Global Change** will be associated with geographic shifts in both natural and agricultural vegetation.

What consequences will these Global Changes have on reservoirs and water quality management? First of all, most predictions indicate that world average temperatures will increase by only 1-2 degrees. However, changes will be distributed irregularly over the globe, both in macroscales as well as in mesoscales. Warming will probably have the greatest biological effects at high latitudes, and low latitude boundaries of cold and cool-water species ranges. Water availability has currently dropped below 1000 m³ per person per year (a common water quality benchmark) in a number of countries (e.g., Kuwait, Jordan, Israel, Rwanda, Somalia, Algeria, Kenya) or is expected to fall below this benchmark in the next 2 to 3 decades (e.g., in Libya, Egypt, South Africa, Iran, Ethiopia). In the relatively small territory occupied by England, for example, large regional differences in rainfall and temperature are predicted, and, moreover, these include both increases and decreases. Common to all regions is the increasing irregularity of weather (as already observed) which may prove to be more difficult to cope with than relatively slow average changes. A change in the volume and distribution of water will affect both ground and surface water supply and all kinds of uses. Relatively small changes in temperature and precipitation, together with non-linear effects on evapotranspiration and soil moisture, can result in relatively large changes in runoff, especially in arid and semiarid regions. A warmer climate could decrease the proportion of precipitation that fall as snow, and lead to reductions in spring runoff and increases in winter runoff.

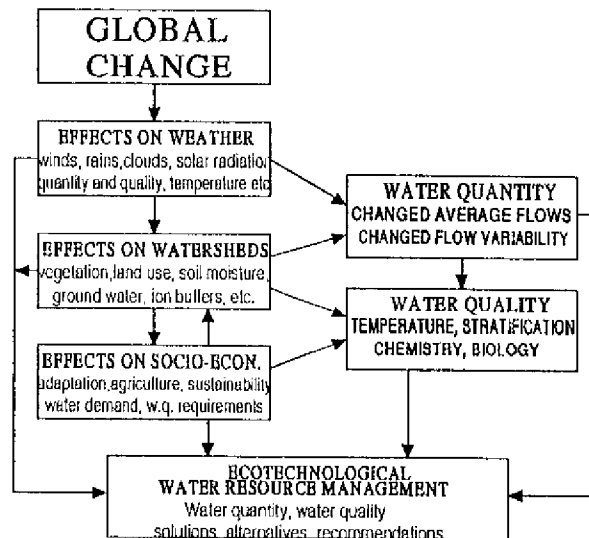

Fig. 16.1 Expected consequences of Global Changes on reservoir water quality.

For reservoir water quality management the following three basic types of consequences of Global Changes can be expected (Fig. 16.1): (i) direct effects on air temperature and flow; (ii) indirect effects due to changes in natural and agricultural vegetation; and, (iii) increased water demands on reservoirs, which may include pressure to build new reservoirs. Changes in spectral composition of radiation are expected to produce changes in the organisms and organic matter in waters. Direct effects of air temperature and flow changes will affect water temperature and

water quality stratification. These variables have a considerable effect on many water quality processes. The change in reservoir retention time, along with consequences discussed in Chapter 4, will be significant. The hydrological budget directly affects the nutrient load and, hence, the trophic state of reservoirs. Indirect effects of vegetation changes will not only enhance or diminish the hydrological changes, but they can also cause major changes in nutrient and pollutant loads, including organic matter. The increase in classic pollution will result from increased water treatment demands in communities where urban runoff is combined with the sewer system. Consequences of decreased water levels and increased pollution inputs will not only cause increased productivity and trophy, but will also have considerable negative consequences on oxygen conditions in reservoirs. Thus it is expected that costs of drinking water supply from reservoirs will increase. Water quality of the reservoir outflows will also deteriorate. More consideration of water quality aspects during planning and construction of new reservoirs and detailed evaluation of global environmental effects on these reservoirs will be necessary.

The degree to which Global Change will impact reservoirs will depend on base-line conditions in the water supply system and the ability of water resource managers to respond to climate changes, population growth, changes in demand, changes in technology, and economic, social, and legislative conditions. In wealthier countries with integrated water-management systems, improved management may be able to protect water users from these changes at minimal costs. In many other countries, there may be substantial economic, social and environmental costs, particularly in regions that already are water-limited. Management options include the following: more efficient use of existing supplies and infrastructure; institutional arrangements to limit future demands and promote conservation; improved monitoring; forecasting of floods and droughts; rehabilitation of watersheds to increase water retention capacity in the territory, especially in the tropics; and construction of additional reservoir and wetland capacity to capture and store excess flows produced by altered snowmelt and storm patterns.

Reservoirs can contribute to climate changes by producing methane and other gases that are liberated to the atmosphere. In Amazonian reservoirs, decomposition of inundated forests resulted in significant gas production in the hypolimnion. Wetlands associated with reservoirs are other sources of gases that could increase the greenhouse effect.

Water conservation is an important major goal for the future. Leaking water distribution systems, excess use of water by industries and luxurious water consumption by individuals must cease. There are a number of ways water can be conserved in each of these respects. These are obvious for distribution systems and have been previously discussed in terms of industry as related with clean production and product life cycle evaluation in Chapters 10.1 and 2.3. Recommendations for water savings during domestic uses are listed in Tab. 16.1.

The potential for future water quality requires that people become actively involved in water quality management and learning of public and representatives of other branches of economy about the needs to save water.

Tab. 16.1 Conscientious use of domestic water. According to Moore & Thornton (1988), highly simplified

- * Inspect the plumbing system for leaks
 - * Install flow control devices in showers
 - * Turn off all water during vacations or long periods of absence
 - * Insulate hot water pipes to avoid having to clear the "hot" line of cold water each time
 - * Make repairs promptly
 - * Reduce the water in the toilet flush tank (with bottles filled with water)
 - * Never use the toilet for trash basket
 - * Accumulate a full laundry load before washing or use a lower water level setting
 - * Take shower instead of bath
 - * Turn off shower water while soaping body, lathering hair or massaging scalp
 - * Bottle and refrigerate water to avoid running excess water from the lines to get cold water
 - * To get warm water, turn hot water on first; then add cold water as needed
 - * When washing dishes by hand, use one pan of soapy water for washing and a second for rinsing
 - * Plan landscaping and gardening to minimize watering requirements
 - * When building or remodeling, consider: (i) installing smaller than standard bath tubs, (ii) locating the water heater near the area where hottest water is needed
-

16.4 FUTURE DEVELOPMENTS IN RESERVOIR MANAGEMENT

Volumes of data and information about reservoirs are increasing quickly. Several research groups and research centers around the world contribute to this knowledge. However, it is necessary to improve synthesis and analysis of available data in order to produce innovations in research and management. The integration of a watershed approach with reservoir functions and the reservoir response to inputs is one of the most important future developments to be considered. Integration of remote sensing with geographic information and limnological and hydrological data will be a useful tool for future management of reservoirs or reservoir systems. As suggested by Naiman *et al.* (1995), interaction of freshwater sciences with management is imperative to advance the multiple uses of reservoirs and to provide new insights into regional management and regional development.

The use of a single reservoir or a reservoir cascade to enhance regional development has been attempted in several regions and resulted in both failures and successes. An example of failures in large scale development was observed in the Amazonian reservoirs. Although they provided hydroelectricity, their role in regional development was small due to inherent difficulties within the region. Alternatively, a large reservoir construction in the S. Francisco River (Northeast of Brazil - six reservoirs in 100 km of the river), provided a means for extensive regional development. For example, the irrigation scheme alone provided more than 90,000 jobs in the region. The use of the power plant infrastructure to provide regional development opportunities is a recent idea that is being pursued by several financing agencies in Brazil (The Xingó hydroelectric power plant construction facilities have being transformed into an Integrated Center for Regional Development).

An important future goal for reservoir management is to increase the number of qualified managers with interdisciplinary training in such a way that they can function as catalysts in many

disciplines.

Community participation is another important future goal. This requires training opportunities for the school teachers and the general public. The management of a reservoir or reservoir cascade is more creative and more consolidated with the inclusion of partnerships between the private sector, public sector, universities, and state and local agencies. These partnerships can seek funds and establish a user's consortium in order to coordinate multiple uses of the system (Tundisi and Straškraba, 1995).

The integration of the reservoir operation system (water level, water flow, hydrological regime) with multiple use needs (irrigation, hydroelectricity, recreation, fisheries and aquaculture) should also be stimulated and, to that end, a common language should be pursued between engineers, limnologists, biologists, economists and managers.

REFERENCES

BOOKS FOR FURTHER READING

- Anonymous.** 1979. *How to Identify and Control Water Weeds and Algae*. Applied Biochemists Inc., Mequon, Wisconsin.
- Allanson B.R., R.C. Hart, J.H. O'Keeffe & R.D. Robarts.** 1990. *Inland Waters of Southern Africa. An Ecological Perspective*. Kluwer Academic Press, Dordrecht.
- Biswas A.K., M. Jellali & G. Stout.** (Eds). 1993. *Water for Sustainable Development in the Twenty-first Century*. Oxford University Press, Delhi.
- Callow P. & G.E. Petts.** 1992. *The Rivers Handbook*. Blackwell Sci. Publ., Oxford.
- Calmano W. & U. Förstner.** 1996. *Sediments and Toxic Substances (Environmental Effects and Ecotoxicity)*. Springer Verlag, Berlin.
- Chapman D.** (Ed.). 1992. *Water Quality Assessment*. Chapman & Hall, London.
- Cooke G.D., E.B. Welch, S.A. Peterson & P.R. Newroth.** 1986. *Lake and Reservoir Restoration*. Butterworths, Boston.
- Cooke G.D., E.B. Welch, S.A. Peterson & P.R. Newroth.** 1993. *Restoration and Management of Lakes and Reservoirs*. Lewis Publishers, Boca Raton, Fl.
- DeBernardi R. & G. Giussani** (Eds). 1995. *Bio-manipulation in Lakes and Reservoirs Management*. Guidelines of Lake Management. Vol. 7. International Lake Environment Committee, Kusatsu.
- Edmondson W.T.** 1991. *The Uses of Ecology. Lake Washington and Beyond*. Univ. of Washington Press, Washington.
- Eiseltová M.** (Ed.). 1994. *Restoration of Lake Ecosystems - a Holistic Approach*. International Waterfowl and Wetlands Research Bureau, Slimbridge, Gloucester, UK.
- Eiseltová M. & J. Biggs.** (Eds). *Restoration of Stream Ecosystems - an Integrated Catchment Approach*. International Waterfowl and Wetlands Research Bureau, Slimbridge, Gloucester.
- Fisk D.W.** 1989. *Wetlands: Concerns and Successes*. American Water Resources Association, Bethesda, Maryland.
- Gangstad E.O.** 1986. *Freshwater Vegetation Management*. Thomas Publications, Fresno, California.
- Gulati R.D., E.H.R.R. Lammers, M.-L. Meijer & E. Van Donk.** 1990. *Bio-manipulation. Tool for Water Management*. Kluwer Acad. Publishers, Dordrecht.
- Hammer D.A.** 1989. *Constructed Wetlands for Wastewater Treatment*. Lewis Publications, Chelsea, Michigan.
- ILEC.** 1991. *Data Book of World Lake Environments. A Survey of the State of World Lakes*. International Lake Environment Committee, United Nations Environment Programme, Otsu.
- Jørgensen S.E.** 1983. *Application of Ecological Modelling in Environmental Management*. Elsevier, Amsterdam.
- Jørgensen S.E.** 1986. *Fundamentals of Ecological Modelling*. Elsevier, Amsterdam.
- Jørgensen S.E.** 1980. *Lake Management*. Pergamon Press, Oxford.
- Jørgensen S.E. & M.J. Gromiec.** 1989. *Mathematical Submodels in Water Quality Systems*. Developments in Environmental Modelling Vol. 14. Elsevier, Amsterdam.
- Jørgensen S.E. & H. Löffler.** 1990. *Lake Shore Management*. Guidelines of Lake Management, Vol. 3. International Lake Environment Committee, Kuomachi.
- Jørgensen S.E. & R.A. Vollenweider.** (Eds). 1988. *Principles of Lake Management*. Guidelines of Lake Management Vol. 1. International Lake Environment Committee, Kusatsu, Japan.
- Klapper H.** 1992. *Eutrophierung und Gewässerschutz*. Gustav Fischer, Jena.
- Matsui S.** 1991. *Toxic Substances Management in Lakes and Reservoirs*. Guidelines of Lake Management Vol. 4. International Lake Environment Committee, Kusatsu.
- Meybeck M., D. Chapman & R. Helmer.** 1989. *Global Freshwater Quality. A First Assessment*. World Health Organization and UNEP, Blackwell, Oxford.
- Misra K.B.** (Eds). 1996. *Clean Production (Environmental and Economic Perspectives)*. Springer-Verlag, Berlin.
- Mitsch W.J. & S.E. Jørgensen.** (Eds). 1989. *Ecological Engineering*. John Wiley & Sons, New York.

- Moore L. & K. Thornton.** (Eds). 1988. *The Lake and Reservoir Restoration Guidance Manual*. First Edition. US EPA 440/5-88-002, Washington, D.C.
- Moshiri G.A.** (Ed.). 1993. *Constructed Wetlands for Water Quality Improvement*. Lewis Publishers, Boca Raton, Florida.
- Munawar M. & G. Dave.** (Eds). 1997. *Development and Progress in Sediment Quality Assessment*. SPB Academic Publishing, Amsterdam.
- Novotny V. & G. Chesters.** 1981. *Handbook of Nonpoint Pollution. Sources and Management*. Van Nostrand Reinhold, New York.
- Novotny V. & H. Olem.** 1994. *Water Quality - Prevention, Identification, and Management of Diffuse Pollution*. Van Nostrand Reinhold, New York.
- Novotny V. & L. Somlyódy.** (Eds). 1995. *Remediation and Management of Degraded River Basins*. Springer Verlag, Berlin.
- Orlob G.T.** 1983. *Mathematical Modeling of Water Quality: Streams, Lakes, and Reservoirs*. Wiley, Chichester.
- Ryding S.O. & W. Rast.** (Eds). 1989. *The Control of Eutrophication of Lakes and Reservoirs*. The Parthenon Publishing Company, Park Ridge, N.J.
- Stahre P. & B. Ubonas.** 1990. *Stormwater Detention for Drainage, Water Quality, and CSO Management*. Prentice Hall, Englewood Cliffs, New Jersey.
- Steinberg Ch., H. Bernhardt & H. Klapper.** 1995. *Handbuch Angewandte Limnologie*. Ecomed Verlagsgesellschaft, Landberg.
- Straškraba M. & A. Gnauck.** 1985. *Freshwater Ecosystems. Modelling and Simulation*. Elsevier, Amsterdam.
- Straškraba M., J.G. Tundisi & A. Duncan.** 1993. *Comparative Reservoir Limnology and Water Quality Management*. Kluwer Academic Publishers, Dordrecht.
- Thanh N.C. & A. Biswas.** 1990. *Environmentally-sound Water Management*. Oxford University Press, Oxford.
- Thomann R.V. & J.A. Mueller.** 1987. *Principles of Surface Water Quality Modeling and Control*. Harper Collins Publishers, New York.
- Thornton K.W., B.L. Kimmel & F.F. Payne.** 1990. *Reservoir Limnology: Ecological Perspectives*. Wiley, New York.
- Torno H.C., J. Marsalek & M. Desbordes.** (Eds). 1986. *Urban Runoff Pollution*. Springer Verlag, Heidelberg.
- Vant W.N.** (Ed.). 1987. *Lake Managers Handbook*. National Water and Soil Authority, Wellington.
- Walesh S.** 1989. *Urban Surface Water Management*. Wiley Interscience, New York.
- Wetzel R.G. & G.E. Likens.** 1991. *Limnological Analyses*. 2nd Edition. Springer, New York.
- WHO.** 1984. *Guidelines for Drinking-Water Quality*. Volume 1, Recommendations. World Health Organization, Geneva.
- WMO.** 1988. *Manual on Water Quality Monitoring*. WMO Operational Hydrology Report No 27, WMO Publication No 680. World Meteorological Organization, Geneva.

REFERENCES CITED IN TEXT (in addition to those above).

- Agostinho A.A.H.F. & J.M. Petrere, Jr.** 1994. Itaipu Reservoir (Brazil): In: Cowx I.G. (Ed.) *Impacts of the impoundment on the fish fauna and fisheries*, Fishing News Books: 171-184.
- Alassareta E., M. Virtanen & J. Koponen.** 1993. The Bothnian Bay Project - past, present and future. *Aqua Fennica*, 23: 117-124.
- Alvarez E.L.B. & J. Pachaco.** 1986. Aspectos ecológicos del embalse de Guri. *Interciencia*, 11: 325-333.
- Ambrose R.B., Jr., P.E.T.A. Wool, J.P. Connolly & R.W. Schanz.** 1988. *WASP4, A Hydrodynamic and Water Quality Model - Model Theory, User's Manual, and Programmer's Guide*. Environmental Research Laboratory, Office of Research and Development, U.S. Environmental Protection Agency, Athens, Georgia 30613
- Andreu J., J. Capilla & E. Sanchis.** 1991. AQUATOOL, a computer assisted support system for water resources research management including conjunctive use. In: Loucks D.P. & J.R. DaCosta (Eds) *Decision Support Systems: Water Resources Planning*, Nato ASI Series, Vol. G26. Springer-Verlag, Berlin.
- Anonymous.** 1986. CE-QUAL-R1: A numerical one-dimensional model of reservoir water quality. User's

Manual/Instruction. *US Army Corps of Engineers, Environmental Laboratory, Waterways Experiment Station, Report E-82-1.*

Anonymous. 1988. Constructed Wetlands and Aquatic Plant Systems for Municipal Wastewater Treatment. *U.S. Environmental Protection Agency, EPA 625/1-88/022, US EPA, Washington, DC.*

Anonymous. 1993. The Rio Declaration on Environment and Development. The Global Partnership for Environment and Development. *A Guide to Agenda 21.* United Nations, New York.

Anonymous. 1989. TIBEAN - The revolutionary technology of lake restoration. *Petersen Schiffstechnik GMBH, Hamburg.*

APHA. 1989. *Standard Methods for the Examination of Water and Wastewater.* American Public Health Organisation, Washington, D.C. 1268 pp.

Arcifa M.S., T.G. Northcote & O. Froelich. 1986. Fish - zooplankton interactions and their effects on water quality of a tropical Brazilian reservoir. *Hydrobiologia*, 139: 49-58.

Asaeda T., D.G.N. Priyantha, S. Saitoh & K. Gotoh. 1996. A new technique for controlling algal blooms in the withdrawal zone of reservoirs using vertical curtains. *Ecol. Engineering*, 7: 95-104.

Barillier A., J. Garnier & M. Coste. 1993. Experimental Reservoir Water Release: Impact on the Water Quality on a River 60km Downstream (Upper Seine River, France). *Wat. Res.*, 27: 635-643.

Bayley P.B. 1988. Accounting for effort when comparing tropical fisheries in lakes, river floodplains, and lagoons. *Limnol. Oceanogr.*, 39: 963-972.

Bedford K.W., R.M. Sykes & C. Libicki. 1983. Dynamic advective water quality model for rivers. *J. Environm. Engng Div., ASCE* 109: 535-554.

Benndorf J. 1973. Prognose des Stoffhaushaltes von Staugewässern mit Hilfe kontinuierlicher und semikontinuierlicher biologischer Modelle. *Int. Revue ges. Hydrobiol.*, 58: 1-18.

Benndorf J., H. Kneschke, K. Kossatz & E. Penz. 1984. Manipulation of the pelagic food web by stocking with predaceous fish. *Int. Revue ges. Hydrobiol.*, 69: 407-428.

Benndorf J. & F. Recknagel. 1982. Problems of application of the ecological model SALMO to lakes and reservoirs having various trophic status. *Ecol. Modelling*, 17: 129-145.

Benndorf J., M. Zesch & E.M. Wiesner. 1975. Prognose der Phytoplanktonentwicklung in geplanten Talsperren durch Kombination von wachstumskinerischen Modellvorstellungen und Analogiebetrachtungen zu bestehenden Talsperren. *Int. Revue ges. Hydrobiol.*, 60: 737-758.

Bernhardt H. 1967. Aeration of Wahnbach Reservoir without changing the temperature profile. *J. Amer. Water Works Assoc.*, 59: 943-964.

Bernhardt H. 1990. Control of reservoir water quality. In: Hahn H.H. & R. Klute (Eds) *Chemical Water and Wastewater Treatment.* Springer, Berlin.

Bernhardt H. & H. Schell. 1993. Effects of energy input during orthokinetic aggregation on the filterability of generated flocs. *Wat. Sci. Tech.*, 27: 35-65.

Bernhardt H. & H. Schell. 1979. The technical concept of phosphorus-elimination at the Wahnbach estuary using flocc-filtration (The Wahnbach System). *Z.f. Wasser- und Abwasser- Forschung*, 12: 78-88.

Biggs B.J.F., M.J. Duncan, I.G. Jowett, J.M. Quinn, C.W. Hickey, R.J. Davies-Colley & M.E. Close. 1990. Ecological characterization, classification, and modeling of New Zealand rivers: an introduction and synthesis. *New Zealand J. M. Freshw. Res.*, 24: 277-304.

Bjork S. 1994. Sediment removal. In: Eiseltová M. (Ed.) *Restoration of Lake Ecosystems - a holistic approach.* International Waterfowl and Wetlands Research Bureau, Slunbridge, Gloucester, UK.

Bouron T. 1991. COMMAS: A Communication and Environment Model for Multi-Agent Systems. In: Mosekilde E. (Ed.) *Modelling and Simulation 1991*, European Simulation Multiconference, June 17-19, 1991. The Society for Computer Simulations International, Copenhagen, Denmark: 220-225.

Canale R.P. & D.-I. Seo. 1996. Performance, reliability and uncertainty of total phosphorus models for lakes-II. Stochastic analyses. *Wat. Res.*, 30: 95-102.

Cassidy R.A. 1989. Water temperature, dissolved oxygen, and turbidity control in reservoir releases. In: Gore J.A. & G.E. Petts (Eds) *Alternatives in Regulated River Management.* CRC Press, Boca Raton, Florida: 27-62.

Chang N.-B., C.G. Wen, Y.L. Chen & Y.C. Yong. 1996. A Grey Fuzzy Multiobjective Programming Approach for the Optimal Planning of a Reservoir Watershed. Part A: Theoretical Development. *Wat. Res.*, 30: 2329-2334.

- Chapman R.A., P.T. Manders, R.J. Scholes & J.M. Bosch.** 1995. Who should get the water? Decision support for water resource management. *Wat. Sci. Tech.*, 32(5-6): 37-43.
- Chapra S.C. & R.P. Canale.** 1991. Long-term phenological model of phosphorus and oxygen for stratified lakes. *Water Res.*, 25: 707-715.
- Cooke G.D., E.B. Welch, A.B. Martin, D.G. Fulmer, J.B. Hyde & G.D. Schriever.** 1993a. Effectiveness of Al, Ca, and Fe salts for control of internal phosphorus loading in shallow and deep lakes. *Hydrobiologia*, 253: 323-335.
- Cooke G.D. & R.H. Kennedy.** 1988. Water quality management for reservoirs and tailwaters. Report 2. In-reservoir water quality management techniques. *Technical Report E-88-X, U.S. Army Engineer Waterways Experiment Station, Vicksburg, Mississippi.*
- Cooley P. & S.L. Harris.** 1954. The prevention of stratification in reservoirs. *J. Instn. Wat. Engrs.*, 8: 517-537.
- Corwin D.L. & B.L. Waggoner.** 1991. TETrans: A user-friendly, functional model of solute transport. In: Barnwell T.O., P.J. Ossenbruggen & M.B. Beck (Eds) *Watermatex '91*. Pergamon Press, Oxford: 57-66.
- Davis J.R., P.M. Nanninga, J. Biggins & P. Laut.** 1991. Prototype decision support system for analyzing impact of catchment policies. *J. Water Resour. Plng. Mgmt., ASCE*, 117: 399-414.
- DePinto J.V. & P.W. Rodgers.** 1994. Development of GEO-WAMS: A Modeling Support System for Integrating GIS with Watershed Analysis Models. *Lake and Reservoir Management*, 9(2): 68.
- Dillon P.J. & F.H. Rigler.** 1975. A simple method for predicting the capacity of a lake for development based on lake trophic status. *J. Fish. Res. Bd. Canada*, 32: 1519-1531.
- Dolman W.B.** 1990. Classification of Texas reservoirs in relation to limnology and fish community associations. *Trans. Amer. Fish. Soc.*, 119: 511-520.
- Dvořáková M. & H.-P. Kozerski.** 1980. Three-layer model of an aquatic ecosystem. *ISEM Journal*, 2: 63-70.
- Ecological Modelling Centre (EMC).** 1992. MIKE12, a short description. *Report from the Ecological Modelling Centre. Ecological Modeling Centre, Horsholm, Denmark.*
- Ecosystem Consulting Service.** 1995. Layer air systems. Selective outflow systems. *Ecosystem Consulting Service, Inc., Coventry, Connecticut.*
- Ellis J.H.** 1987. Stochastic water quality optimization using imbedded chance constraints. *Water Resour. Res.*, 23: 2227-2238.
- Fast A.Q. & R.G. Hulquist.** 1982. Supersaturation of nitrogen gas caused by artificial aeration in reservoirs. *Technical Report, E-82-9: U.S. Army Engineer Waterways Experiment Station, Vicksburg, Mississippi.*
- Fay F.M.** 1994. Oxygenation and agitation of lakes using proven marine technology. *Lake and Reservoir Management*, 9(1): 102-105.
- Fedra K.** 1990. Interactive environmental software: Integration, simulation and visualization. In: Pillmann W., A. Jaeschke (Eds) Proceedings: *Informatik für den Umweltschutz*, 5.Symposium, 19-21 September 1990, Wien Österreich: 735-744.
- Fedra K., E. Weigkricht & L. Winkelbauer.** 1990. Models, GIS and Expert Systems for Environmental Impact Analysis. In: Pillmann W. (Ed.) *Computer Applications for Environmental Impact Analysis*. International Society for Environmental Protection (ISEP), Envirotech Vienna: pp. 13-22.
- Fernando C.H.** 1991. Impact of fish introductions in tropical Asia and America. *Can. J. Fish. Aquat. Sci.*, 48 (Suppl. 1): 24-32.
- Fernando C.H. & J. Holčík.** 1991. Fish in reservoirs. *Int. Revue ges. Hydrobiol.*, 76: 149-167.
- Filho M.C.A., J.A.O. de Jesus, J.M. Branski & J.A.M. Hernandez.** 1990. Mathematical modelling for reservoir water quality management through hydraulic structures: a case study. *Ecol. Modelling*, 52: 73-85.
- Fonseca O.J.M.** 1990. Acidification of streams by acid mine drainage in the state Rio Grande do Sul. *Acta Limnologica Brasileira*, Vol. III, Tomo 2: 979-992 (In Portuguese).
- Fontane D.G., J.W. Labadie & B. Loftis.** 1981. Optimal control of reservoir discharge quality through selective withdrawal. *Water Resour. Res.*, 17: 1594-1604.
- Ford D.E.** 1987. Mixing processes in DeGray Lake, Arkansas. In: Kennedy R.H. & J. Nix (Eds) *Proceedings of the DeGray Lake Symposium*. Technical Report E-87-4, U.S. Army Engineer Waterways Experiment Station, Vicksburg, Miss: 186-205.
- Foster I.O.L., S.M. Charlsworth & S.B. Proffitt.** 1996. Sediment-associated heavy metal distribution in urban

- fluvial and limnic systems, a case study of the River Sowe, U.K. *Arch. Hydrobiol., Beih. Ergebn. Limnol.*, 47: 537-545.
- Gaillard J.** 1984. Multilevel withdrawal and water quality. *J. Environm. Engng Div., ASCE*, 110: 123.
- Gächter R., D. Imboden, H. Bühler & P. Stadelmann.** 1983. Mögliche Massnahmen zur Restaurierung des Sempachersees. *Schweiz. Z. Hydrol.* 45: 246-266.
- Gnauck A.G., R. Straubel & A. Wittmus.** 1989. Mehrkriterialer Steuerungsentwurf zur Wassergutbewirtschaftung von Fluss-gebieten. *Messen, Steuern, Regeln Berlin*, 32: 294-299.
- Gophen M.** 1995. Long-term (1970-1990) whole lake biomanipulation. In: De Bernardi R. & G. Giussani (Eds) *Biomanipulation in Lakes and Reservoirs Management*: 171-184.
- Grobler D.C., J.N. Rossouw, P. van Eeden & M. Oliveira.** 1987. Decision support system for selecting eutrophication control strategies. In: Beck M.B. (Ed.) *Systems Analysis in Water Quality Management*. Proceedings of a Symposium held in London, U.K., 30 June - 2 July 1987. Pergamon Press, Great Britain: pp. 219-230.
- Gulliver J.S. & H.G. Stefan.** 1982. Lake phytoplankton model with destratification. *J. Environm. Engng Div., ASCE*, 108: 864-882.
- Haestad Methods.** 1993. HEC-B, SEDIMOT-II and STORM. Haestad. Methods, Software Reference Handbook, Haestad, Waterbury, Connecticut.
- Haindl K.** 1973. Suitable solution of bottom outlets of dams and oxidation outlets for the improvement of water quality in rivers. *Proceedings IAHR, Istanbul*.
- Hamilton D.P. & S.G. Schladow.** 1996. Modelling the sources of oxygen in an Australian reservoir. *Verh. Internat. Ver. Limnol.*, 25: (in press).
- Hanson M.J. & H.G. Stefan.** 1984. Side effects of 58 years of copper sulphate treatment of the Fairmont Lakes, Minnesota. *Water Res. Bull.*, 20: 889-900.
- Hartman P. & J. Kudrlička.** 1980. (Prevention of gill necrosis of fish by controlling photosynthetic assimilation of pond phytoplankton - In Czech). *Bull. VÚRH Vodňany*, 1980 (3): 11-15.
- Henderson-Sellers B., J.R. Davis, I.T. Webster & J.M. Edwards.** 1993. Modern Tools for Environmental Management: Water Quality. In: Jakeman A.J., M.B. Beck & M.J. McAleer (Eds). *Modelling Change in Environmental Systems*. John Wiley & Sons Ltd., Chichester, England: 519-542.
- Henderson H.F., R.A. Ryder & A.W. Kudhongania.** 1973. Assessing fishery potential of lakes and reservoirs. *J. Fish. Res. Bd. Canada*, 30: 2000-2009.
- Henderson H.F. & R.L. Welcome.** 1974. The relationship of yield to morphoedaphic index and numbers of fishermen in African inland fisheries. *CIFA Occas Pap. 1, FAO, ROME*: 1-19.
- Hilborn R.** 1987. Living with uncertainty in resource management. *North American Journal of Fisheries Management*, 7: 1-5.
- Hilbricht-Ilkowska A.** 1989. Assessment of watershed impact and lake ecological state for protection and management purposes. In: Salánkai J. & S. Herodek (Eds) *Conservation and Management of Lakes*. Akadémiai Kiadó, Budapest: 61-70.
- Hocking G.C. & J.C. Patterson.** 1988. Two dimensional modelling of reservoir outflows. *Verh. Internat. Verein. Limnol.*, 23: 2226-2231.
- Hocking G.C. & J.C. Patterson.** 1991. A quasi two-dimensional reservoir simulation model. *J. Environm. Engrg. Div., ASCE*, 117: 595-613.
- Hoehn E.** 1994. The effect of the pre-reservoir on trophic state and the development of phytoplankton in an oligo- mesotrophic drinking-water reservoir (Kleine Kinzig) in the Black Forest (Germany). *Arch. Hydrobiol. Beih. Ergebn. Limnol.*, 40: 263-274.
- Horowitz A.J.** 1996. Spatial and temporal variations in suspended sediment and associated trace elements - requirement for sampling, data interpretation, and the determination of annual mass transport. *Arch. Hydrobiol. Beih. Ergebn. Limnol.*, 47: 515-536.
- Horstman H.K., R.S. Copp & F.X. Browne.** 1983. Use of predictive phosphorus model to evaluate hypolimnetic discharge scenarios of Lake Wallenpupack. *Lake and Reservoir Management, EPA, Washington, DC*: 165-170.
- Howarth R.W., G. Billen, D. Swaney, A. Townsend, N. Jaworski, K. Lajtha, J.A. Downing, R. Elmgren, N. Caraco, T. Jordan, F. Berendse, J. Freney, V. Kudryarov, P. Murdoch & Z. Yhao-Liang.** 1996. Regional

nitrogen budgets and riverine N & P fluxes for the drainages to the North Atlantic Ocean: Natural and human influences. *Biogeochemistry*, 20: 1-65.

Hrbáček J., O. Albertová, B. Desortová, V. Gottwaldová & J. Popovský. 1986. Relation of the zooplankton biomass and share of large Cladocerans to the concentration of total phosphorus, chlorophyll-a and transparency in Hubenov and Vrehlice Reservoirs. *Limnologica (Berlin)*, 17: 301-308.

Hrbáček J., M. Dvořáková, V. Kořínek & L. Procházková. 1961. Demonstration of the effect of the fish stock on the species composition of zooplankton and the intensity of the whole plankton association. *Verh. Intern. Verein. Limnol.*, 14: 192-195.

Hughes R.M., T.R. Whittier, S.A. Thiele, J.E. Pollard, D.V. Peck, S.G. Paulsen, D. McMullen, J. Lazorchak, D.P. Larsen, W.L. Kinney, P.R. Kaufmann, S. Hedtke, S.S. Dixit, G.B. Collins & J.B. Baker. 1992. Lake and stream indicators for U.S. EPA's Environmental Monitoring and Assessment Program. In: McKenzie D. (Ed.) *Ecological Indicators*. Elsevier, Barking, England: 305-336.

ICOLD. 1984. *World Register of Dams*. International Commission on Large Dams, Paris.

Imberger J. 1982. Reservoir dynamics modelling. In: O'Loughlin E.M. & P. Cullen (Eds) *Prediction in Water Quality. Proceedings of a Symposium on the Prediction in Water Quality, Canberra 1982*. Australian Academy of Science, Canberra: 223-248.

Imberger J. & J. Patterson. 1981. A dynamic reservoir simulation model - DYRESM5. In: Fischer H.B. (Ed.) *Transport Models for Inland and Coastal Waters*. Academic Press, New York: 310-361.

Imberger J. & J.C. Patterson. 1990. Physical limnology. *Advances in Applied Mechanics*, 27: 303-475.

Jackson P.B.N. 1960. Ecological effect of flooding of the Kariba Dam upon middle Zanbezi fishes. *Proceedings of the 1st Federal Science Congress Salisbury, May, 18-22, (1960) Zimbabwe*.

Jackson P.B.N. & F.H. Rogers. 1976. Cabora Bassa fish populations before and during the first filling phase. *Zoologica Africana*, 11: 373-388.

Jenkins R.M. 1968. The influence of some environmental factors on standing crop and harvest of fishes in US reservoirs. In: Lanc, C. *EIEd Reservoir Fishery Resources Symposium*, American Fisheries Society, Washington, D.C.: 298-321.

Jenkins R.M. & O.J. Morals. 1971. Reservoir sport fishing effort and harvest in relation to environmental variables. In: Hall G.E. (Ed.) *Reservoir Fisheries and Limnology*, Special Publ., Amer. Fish. Soc. 8: 371-384.

Jerlov N.G. 1976. *Optical Oceanography*. Elsevier, Amsterdam.

Jirásek A. & J. Heteša. 1980. (To the biotechnology of carp fry cultivation - In Czech). *Československé rybníkářství*, 1980 (4): 3-4.

Jolánkai G. 1983. Modelling of non-point source pollution. In: Jørgensen S.E. (Ed.) *Applications of Ecological Modelling in Environmental Management*. Elsevier, Amsterdam: 283-385.

Jørgensen S.E. 1992. *Lake Model for IBM PC*. International Lake Environment Committee, Kusatsu, Japan.

Jørgensen S.E., H. Mejer & M. Friis. 1978. Examination of a Lake Model. *Ecol. Modelling*, 4: 253-278.

Jørgensen S.E., B.C. Patten & M. Straškraba. 1992. Ecosystem Emerging: Towards an Ecology of Complex Systems in a Complex Future. *Ecol. Modelling*, 62: 1-27.

Kalčeva R., J. Outrata, Z. Schindler & M. Straškraba. 1982. An optimization model for the economic control of reservoir eutrophication. *Ecol. Modelling*, 17: 121-128.

Katzer C.R. & P.L. Brezonik. 1981. A Carlson type trophic state index for nitrogen in Florida Lakes. *Water Res. Bull.*, 17: 713-715.

Kawara O., H. Nago & S. Takasugi. 1995. A study on the eutrophication of the Asahi River Dam Reservoir. *Harmonizing Human Life with Lakes. 6th International Conference on the Conservation and Management of Lakes - Kasumigaura '95*. International Lake Environment Committee: 713-716.

Kelly C.A., J.W.M. Rudd, R.H. Hesslin, D.W. Schindler, P.J. Dillon, C.T. Driscoll, S.A. Gherini & R.H. Heskey. 1987. Prediction of Biological Acid Neutralization in Acid Sensitive Lakes. *Biogeochemistry*, 3: 129-140.

Kennedy R.H., J.W. Barko, W.F. James, W.D. Taylor & G.L. Godshalk. 1987. Aluminium sulphate treatment of a eutrophic reservoir: Rationale, application methods, and preliminary results. *Lake and Reservoir Management*, 3: 85-90.

Kennedy R.H., J.N. Carroll, J.J. Hains, W.E. Jabour & S.L. Ashby. 1995. Water Quality Management at a Large Hydropower Reservoir: Design, Operation and Effectiveness of an Oxygenation System. *Harmonizing Human*

- Life with Lakes. 6th International Conference on the Conservation and Management of Lakes - Kasumigaura 95.* International Lake Environment Committee: 517-520.
- Kennedy R.H. & G.D. Cooke.** 1982. Control of lake phosphorus with aluminium sulphate: dose determination and application techniques. *Wat. Res. Bull.*, 18: 389-395.
- Kimmel B.L. & A.W. Groeger.** 1984. Factors controlling primary production in lakes and reservoirs: A perspective. Lake and Reservoir Management. *Proceedings of the Third Annual Conference, October 18-20, Knoxville, Tennessee. U.S. EPA, Washington, DC:* 277-281.
- Kira T.** 1993. Major environmental problems in world lakes. *Mem. Ist. Ital. Idrobiol.*, 52: 1-7.
- Kortmann R.W., M.E. Conners, G.W. Knoecklein & C.H. Bonnell.** 1988. Utility of layer aeration for reservoir and lake management. *Lake and Reservoir Management*, 4: 35-50.
- Kortmann R.W., G.W. Knoecklein & P.H. Rich.** 1994. Aeration of Stratified Lakes: Theory and Practice. *Lake and Reservoir Management*, 8(2): 99-120.
- Koschel R.** 1987. Pelagic calcite precipitation and trophic state of hardwater lakes. *Arch. Hydrobiol., Beih. Ergebn. Limnol.*, 33: 713-722.
- Kubečka J.** 1993. Succession of fish communities in reservoirs of Central and Eastern Europe. In: Straškraba M., J.G. Tundisi & A. Duncan (Eds) *Comparative Reservoir Limnology and Water Quality Management*. Kluwer Academic Publishers, Dordrecht: 153-168.
- L'vovich M.I., G.F. White, A.V. Belyaev, J. Kindler, N.I. Koronkevic, T.R. Lee & G.V. Voropaev.** 1990. Use and transformation of terrestrial water systems. In: Turner B.L., II (Ed.) *The Earth As Transformed by Human Action*. Cambridge University Press, Cambridge: 235-252.
- Lacroix G.L.** 1989. Ecological and physiological responses of Atlantic Salmon in acidic organic rivers of Nova Scotia, Canada. *Water, Air, and Soil Pollution*, 46: 375-386.
- Lam D.C.L., C.I. Mayfield, D.A. Swayne & K. Hopkins.** 1994. A Prototype Information System for Watershed Management and Planning. *J. of Biol. Systems*, 2: 499-517.
- Lam A.K-Y., E.E. Prepas, D. Spink & S.E. Hruday.** 1995. Chemical control of hepatotoxic phytoplankton blooms: Implications for human health. *Wat. Res.*, 29: 1845-1854.
- Lelek A.** 1973. Sequence of changes in fish populations of the new tropical man made lake Kaingi, Nigeria, West Africa. *Arch. f. Hydrobiol.*; 71: 381-420.
- Lelek A. & El Zarkas.** 1973. Ecological comparison of the pre impoundment fish-faunas of the river Niger and Kainji Lake, Nigeria. In: Ackerman W.C., G.F. White & E.B. Worthington (Eds) *Man Made Lakes. Their Problems and Environmental Effects*. Geophys. Monogr. 17: 655-660.
- Leventer H. & B. Teltsch.** 1990. The contribution of silver carp (*Hypophthalmichthys molitrix*) to the biological control of Netofa reservoirs. *Hydrobiologia*, 191: 47-55.
- Lind O.T., T.T. Terrell & B. Kimmel.** 1993. Problems in reservoir trophic state classification and implications for reservoir management. In: Straškraba M., J.G. Tundisi & A. Duncan (Eds) *Comparative Reservoir Limnology and Water Quality Management*. Kluwer Academic Publishers, Dordrecht: 57-67.
- Lorenzen M.W. & R. Mitchell.** 1975. An evaluation of artificial destratification for control of algal blooms. *J. Amer. Water Works Assoc.*, 67: 373-376.
- Los F.J.** 1991. *Mathematical simulation of algae blooms by the Model BLOOM II. Version 2.* Documentation Report. Delft Hydraulics, The Netherlands.
- Lung W.S. & R.P. Canale.** 1977. Projection of phosphorus levels in White Lake. *J. Environm. Engng Div., ASCE*, 103: 663-667.
- Magmedov V.G., M.A. Zacharenko, L.I. Yakovleva & M.E. Ince.** 1996. The use of constructed wetlands for the treatment of runoff and drainage waters: the UK and Ukraine experience. *Water Sci. Tech.*, 33: 315-323.
- Malin V.** 1984. A general lake water quality index. *Aqua Fennica*, 14(2): 139-145.
- Margalef R.** 1975. Typology of reservoirs. *Verh. Internat. Verein. Limnol.*, 19: 1841-1848.
- Marshall B.E.** 1984. Towards predicting reservoir ecology and fish yield from pre impoundment physico-chemical, data. *CIFA Tech. Pap. (12) FAO*, Rome.
- Matsumura T. & S. Yoshiuki.** 1981. An optimization problem related to the regulation of influent nutrient in aquatic ecosystems. *Int. J. Syst. Sci.*, 12: 565-585.
- Matvienko B. & Tundisi J.G.** 1996. Biogenic gases and decay of organic matter. *Int. Workshop on Greenhouse*

- Gas Emissions from Hydroelectric Reservoirs, Eletrobrás, R.J.*: 1-6.
- McCauley E., J.A. Downing & S. Watson.** 1989. Sigmoid relationships between nutrients and chlorophyll among lakes. *Can. J. Fish. Aquat. Sci.*, 46: 1171-1175.
- McCutcheon S.C.** 1989. *Water Quality Modeling Vol. 1 Transport and Surface Exchange in Rivers*. CRC Press, Boca Raton, Florida.
- McMahon T.A. & B.L. Finlayson.** 1995. Reservoir system management and environmental flows. *Lakes & Reservoirs. Research and Management*, 1: 65-76.
- Mermel T.W.** 1991. The world's major dams and hydro plants. *International Water Power and Dam Construction Handbook 1991*: 52-62.
- Mobley M.** Forebay Oxygen Diffuser System to Improve Reservoir Releases at TVA's Douglas Dam. (manuscript)
- Mobley M.H. & E.D. Harshbarger.** 1987. Epilimnetic pumps to improve reservoir releases. *Miscellaneous Paper E-87-3, Proceedings CE Workshop on Reservoir Releases. U.S. Army Engineer Waterways Experiment Station, Vicksburg, Mississippi*: 133-135.
- Molot L.A., P.J. Dillon, B.J. Clark & B.P. Neary.** 1992. Predicting end-of-summer oxygen profiles in stratified lakes. *Can. J. Fish. Aquat. Sci.*, 49: 2363-2372.
- Moss B.** 1995. Manipulation of Aquatic Plants. In: De Bernardi R. & G. Giussani (Eds) *Bio-manipulation in Lakes and Reservoirs Management. Guidelines of Lake Management*, 7: 97-112.
- Naiman R.J., J.J. Magnuson & D.M. McKnight.** 1995. *The Freshwater Imperative*. Island Press, Washington DC.
- Neethling J.B.** 1986. Review of generic software for environmental applications. In: Zannetti P. (Ed.) *ENVIROSOFT 86. Proceedings of the International Conference on Development and Application of Computer Techniques to Environmental Studies, Los Angeles, U.S.A., November 1986*. Computational Mechanics Publications, Southampton: pp. 3-17.
- Novotny V.** 1988. Diffuse (nonpoint) pollution - a political, institutional, and fiscal problem. *J. Wat. Pollut. Control. Fed.*, 60: 1404-1413.
- Olszewski P.** 1967. Die Ableitung des hypolimnischen Wassers aus einem See. *Mitt. blat Fed. Europ. Gewässerschutz*, 14: 87-89.
- Owens E.M., S.W. Effler & F. Trama.** 1986. Variability in thermal stratification in a reservoir. *Water Res. Bull.*, 22: 219-227.
- Paiva M. P., M. Petrere Jr., A.J. Petenate & F.H. Nepomuceno.** 1994. Relationship between the number of predatory fish species and the fish yield in large north eastern Brazilian reservoirs. In: Cowx I.G. (Ed.) *Impacts of the impoundment on the fish fauna and fisheries*, Fishing News Books: 120-129.
- Pařízek J.** 1984. Využití efektu čisté vrstvy (Utilization of the "clean layer" effect - In Czech). In: Straškraba M., Z. Brandl & P. Porcalová. (Eds) *Hydrobiologie a kvalita vody údolních nádrží*. ČSVTS, České Budějovice: pp. 72-83.
- Pastorok R.A., T.C. Ginn & M.W. Lorenzen.** 1980. Review of aeration (circulation for lake management). *Restoration of Lakes and Inland Waters. Internat. Symposium on Inland Waters and Lake Restoration, Portland, Maine*: 124-133.
- Pastorok R.A., T.C. Ginn & M.W. Lorenzen.** 1981. Evaluation of aeration/circulation as a lake restoration technique. *U.S. Environmental Protection Agency, EPA-600/3-81-014. Washington, DC*.
- Peterson S.A.** 1982. Lake restoration by sediment removal. *Water Res. Bull.*, 18: 423-435.
- Peterson S.A.** 1981. Sediment Removal as a Lake Restoration Technique. *U.S. Environmental Protection Agency, EPA-600/3-81-013, Corvallis*.
- Petrere M.** 1986. Fisheries and fish farming assessment at Itaparica (Northeast). *Consultant's Report to the World Bank. Washington D.C.*
- Petrere M.** 1994. Synthesis on Fisheries in large tropical reservoirs in South America. Consultant's document prepared under FAO/UN request from the Inland Water Resources and Aquaculture Service - Fishery Resources and Environmental Division. Presented at the "Sinposio Regional sobre Manejo de la Pesca en Embalses em America Latina", La Habana, Cuba, October 1994.
- Petrere M. Jr. & A.A. Agostinho.** 1993. The fisheries in the brazilian portion of the Parana River. Document

presented at the ONU/FAO/COPESCAL meeting "Consulta de Expertos sobre los Recursos Pesqueros de La Cuenca del Planta. Montevideo, Uruguay: 5-7.

Prairie Y.T., C.M. Duarte & J. Kalff. 1989. Unifying nutrient-chlorophyll relationships in lakes. *Can. J. Fish. Aquat. Sci.*, 46: 1176-1182.

Pütz K. 1995. The importance of pre-reservoirs for the water-quality management of reservoirs. *J. Water SRT - Aqua*, 44: 50-55.

Pütz K., J. Bendorf, M. Frimel, W. Henke, H. Krinitz & H.S. Schirpke. 1975. Phosphatelimination in Vorsperren. *Fachbereichs-standard TGL 27885/02*.

Quaak M., J. van der Does, P. Boers & J. van der Vlugt. 1993. A new technique to reduce internal phosphorus loading by in-lake phosphate fixation in shallow lakes. *Hydrobiologia*, 253: 337-344.

Quintero J.E. & J.E. Garton. 1973. A low energy lake destratifies. *Trans. Amer. Soc. of Agricultural Engineers*, 16: 973-978.

Recknagel F., M. Hosomi, T. Fukushima & D.-S. Kong. 1995. Short- and long-term control of external and internal phosphorus loads in lakes-A scenario analysis. *Wat. Res.*, 29: 1767-1779.

Reynolds C.S., S.W. Wiseman & M.J.O. Clarke. 1984. Growth- and loss-rate responses of phytoplankton to intermittent artificial mixing and their potential application to the control of planktonic algal biomass. *J. Appl. Ecol.*, 21: 11-39.

Ridley J.E., P. Cooley & J.A. Steel. 1966. Control of thermal stratification in Thames Valley reservoirs. *Proc. Soc. Wat. Treat. Exam.*, 15: 225-244.

Ridley J.E. & J.A. Steel. 1975. Ecological aspects of river impoundments. In: Whitton B. (Ed.) *River Ecology*. Blackwell Sci. Pub., Oxford: 565-587.

Riley M.J. & H.G. Stefan. 1988. Development of the Minnesota Lake Water Quality Management Model "MINLAKE". *Lake and Reservoir Management*, 4: 73-84.

Ripl W. 1976. Biochemical oxidation of polluted lake sediment with nitrate - a new lake restoration method. *AMBIO*, 5: 132-135.

Ripl W. 1994. Sediment treatment. In: Eiseltová M. (Ed.) *Restoration of Lake Ecosystems - a holistic approach*. International Waterfowl and Wetlands Research Bureau, Slimbridge, Gloucester, UK: 75-81.

Ripl W. & S. Ridgill. 1995. Sustainability of river catchments. In: Eiseltová M. & J. Biggs (Eds) *Restoration of Stream Ecosystems* International Waterfowl and Wetlands Research Bureau, Publication 37, Slimbridge, Gloucester, UK: 5-17.

Robbins T.W. & D. Mathur. 1976. The muddy run pumped storage project: A case history. *Trans. Amer. Fish. Soc.*, 1: 165-172.

Roche K.F., E.V. Sampaio, D. Teixeira, T. Matsumura Tundisi, J.G. Tundisi, H.J. Dumont. 1993. Impact of *Holosthetes heterodon* Eigenmann (Pisces:Characidae) on the plankton community of a subtropical reservoir: the importance of predation by *Chaoborus* larvae. *Hydrobiologia*, 254: 7-20.

Rosa L.P. 1997. Relatório técnico científico da COPPE sobre as medicoes de gases do efeito estufa na Hidroelétrica de Curua-Una, Amazonas.

Ryder R.A. 1965. A method for estimating the potential fish production of north-temperate lakes. *Trans. Amer. Fish. Soc.*, 94: 214-218.

Saijo Y. & J.G. Tundisi. 1985. *Limnological studies in Central Brazil. Rio Doce Valley Lakes and Pantanal Wetland*. 1st Report, Water Research Institute, Nagoya University.

Salas H.J., & P. Martino 1991. A simplified phosphorus trophic state model for warm-water tropical lakes. *Water Res.*, 25: 341-350.

Sale M.J., E.D. Brill Jr. & E.E. Herricks. 1982. An approach to optimizing reservoir operation for downstream aquatic resources. *Water Resour. Res.*, 18: 705-712.

Salencon M.-J. & J.-M. Thébault. 1994. Démarche de modélisation d'un écosystème lacustre: application au Lac de Paeloup. *Hydroécol. Appl.*, 6: 315-327.

SASR. 1992. Project No 6: Research and Technological Development for the Supply and Use of Freshwater Resources: Report on Monitoring and Modeling. 1. *Krüger Consult AS and Danish Hydraulic Institute. Commission of the European Communities, Brussels.*

Schindler Z., & M. Straškraba. 1982. Optimální řízení eutrofizace údolních nádrží. *Vodohospodársky časopis*

- SAV*, 30: 536-548.
- Schladow S.G.** 1993. Lake destratification by bubbler plume systems: A design methodology. *J. Hydraulics Engng Div., ASCE*, 119: 350-368.
- Schlesinger D.A. & H.A. Regier.** 1982. Climatic and morphoedaphic indices of fish yield from natural lakes. *Trans. Amer. Fish. Soc.*, 111: 141-150.
- Seo D.-I. & R.P. Canale.** 1996. Performance, reliability and uncertainty of total phosphorus models for lakes-I. Deterministic Analyses. *Wat. Res.*, 30: 83-94.
- Shapiro J.** 1995. Lake restoration by biomanipulation - a personal view. *Environ. Rev.*, 3: 83-93.
- Shapiro J., V. Lamarra & M. Lynch.** 1975. Biomanipulation, an ecosystem approach to lake restoration. In: Brezonik P.L. & J.L. Fox (Eds) *Proc. Symp. Water Quality Management Through Biological Control*. Univ. Florida Press, Gainesville, Florida: 85-96.
- Somlyódy L. & O. Varis.** 1992. Water quality modelling of rivers and lakes. *International Institute for Applied Systems Analysis, WP-92-041, Laxenburg*.
- Somlyódy L.** 1994. Water Quality management: can we improve integration to face future problems? *International Institute for Applied Systems Analysis, WP-94-34, Laxenburg*.
- Speece R.E.** et al. 1982. Hypolimnetic oxygenation studies in Clark Hill Lake. *J. Hydraulics Engng Div., ASCE*, 108: 225-244.
- Speece R.E.** 1994. Lateral thinking solves stratification problems. *Water Quality International*, 3: 12-15.
- Sprules W.G.** 1984. Towards an optimal classification of zooplankton for lake ecosystem studies. *Verh. Intern. Verein. Limnol.*, 22: 320-325.
- Starling F.L.R.M.** 1993. Control of eutrophication by silver carp (*Hypophthalmichthys molitrix*) in the tropical Paranao Reservoir (Brazilia, Brazil): a mesocosm experiment. *Hydrobiologia*, 257: 143-152.
- Stauffer R.E.** 1987. Effects of oxygen transport on the areal hypolimnetic oxygen deficit. *Water Resour. Res.*, 23: 1887-1892.
- Steel J.A.** 1978. Reservoir algal productivity. In: James A. (Ed.) *Mathematical Models in Water Pollution Control*. Wiley, New York: 107-135.
- Stefan H.G., M.D. Bender, J. Shapiro & D.I. Wright.** 1987. Hydrodynamic, design of a metalimnetic lake aerator. *J. Environm. Engng Div., ASCE*, 113: 1249-1264.
- Stefan H.G. & X. Fang.** 1994. Model simulations of dissolved oxygen characteristics in Minnesota lakes: Past and future. *Environmental Management*, 18: 73-92.
- Stefan H.G. & M.J. Hanson.** 1980. Predicting dredging depths to minimize internal nutrient recycling in shallow lakes. Restoration of lakes and inland waters. *International symposium on inland waters and lake restoration, September 8-12, 1980, Portland, Maine*, U.S. Envir. Prot. Agency, Washington, D.C.: 79-85.
- Stein R.A., D.R. DeVries & J.M. Dettmers.** 1995. Food-web regulation by a planktivore: exploring the generality of the trophic cascade hypothesis. *Can. J. Fish. Aquat. Sci.*, 52: 2518-2526.
- Steinberg C. & G.M. Zimmerman.** 1988. Intermittent destratification: a therapy measure against Cyanobacteria in lakes. *Environmental Technology Letters*, 9: 337-350.
- Stenson J.A.E., T. Bohlin, L. Henrikson, B.E. Nilsson, H.G. Nyman, H.G. Oscarson & P. Larsson.** 1978. Effect of fish removal from a small lake. *Verh. Intern. Verein. Limnol.*, 20: 794-801.
- Stow C.A., S.R. Carpenter, Ch.P. Madenjian, L.A. Eby & L.J. Jackson.** 1995. Fisheries management to reduce contamination consumption. *BioScience*, 45: 752-758.
- Straškraba M.** 1976. Empirical and analytical models of eutrophication. *Proc. Eutrosyn '76 Karl-Marx-Stadt*, 3: 352-371.
- Straškraba M.** 1980. The effect of physical variables on freshwater production: analyses based on models. In: LeCren E.D. & R.H. Lowe-McConnel (Eds) *The Functioning of Freshwater Ecosystems*. Cambridge Univ. Press, Cambridge: 13-84.
- Straškraba M.** 1985. Managing of eutrophication by means of ecotechnology and mathematical modelling. *International Congress Lakes Pollution and Recovery, Rome, 15th - 18th April, 1985*: 17-28.
- Straškraba M.** 1986. Ecotechnological measures against eutrophication. *Limnologica* (Berlin), 17: 239-249.
- Straškraba M.** 1993. Ecotechnology as a new means for environmental management. *Ecol. Engineering*, 2: 311-331.

- Straškraba M.** 1994. Ecotechnological models for reservoir water quality management. *Ecol. Modelling*, 74: 1-38.
- Straškraba M.** 1995. Models of algal blooms. *Harmonizing Human Life with Lakes, 6th International Conference on the Conservation and Management of Lakes - Kasumigaura '95*. International Lake Environment Committee: 838-842.
- Straškraba M., I. Dostálková, J. Hejzlar & V. Vyhánek.** 1995: The effect of reservoirs on phosphorus concentration. *Int. Revue ges. Hydrobiol.*, 80: 403-413.
- Straškrabová V.** 1976. Self purification of impoundments. *Water Res.*, 9: 1171-1177.
- Straškrabová V., B. Desortová, K. Šimek, V. Vyhánek & B. Bojanovski.** 1983. Ovlivnění biochemické spotřeby kyslíku v povrchových vodách přítomností řas. (The influence of algae on biochemical oxygen demand in surface waters) (In Czech). *Vodní hospodářství, B*, 33: 165-168.
- Strebel D.E., B.W. Meeson & A.K. Nelson.** 1994. Scientific information system: A conceptual framework. In: Michener W.K., J.W. Brunt & S.G. Stafford (Eds) *Environmental Information Management and Analysis: Ecosystem to Global Scales*: 59-85.
- Strycker L.** 1988. Decaying dam holds tide of trouble. *The Register-Guard*, 121(331) Eugene, Oregon: 1-8.
- Stumm W. & P. Baccini.** 1978. Man-Made Chemical Perturbation of Lakes. In: Lerman A. (Ed.) *Lakes, Chemistry, Geology, Physics*. Springer-Verlag, New York: 91-126.
- Symons J.M., W.H. Irwin, R.M. Clark & G.G. Roebeck.** 1967. Management and measurement of DO in impoundments. *J. Sanit. Engng Div., ASCE*, 93: 181-209.
- Szilágyi F., L. Somlyódy & L. Kocsos.** 1990. Operation of the Kis-Balaton reservoir: evaluation of nutrient removal rates. *Hydrobiologia*, 191: 297-306.
- Thornton J.A. & W. Rast.** 1993. A test of hypotheses relating to the comparative limnology and assessment of eutrophication in semi-arid man-made lakes. In: Straškraba M., J.G. Tundisi & A. Duncan (Eds) *Comparative Reservoir Limnology and Water Quality Management*. Kluwer Academic Publishers, Dordrecht, The Netherlands: 1-24.
- Thornton K.W., R.H. Kennedy, A.D. Mahoun & G.F. Saul.** 1982. Reservoir water quality sampling design. *Water Resour. Bull.*, 18: 261-265.
- Tundisi J.G.** 1984. Estratificacao hidraulica em reservatorios e suas consequencias ecologicas. *Cienc. Cult.*, 36: 1498-1504.
- Tundisi J.G. & T. Matsumura Tundisi.** 1995. The Lobo Broa Ecosystem Research. In: Tundisi J.G., C. Bicudo, T. Matsumura Tundisi (Eds) *Limnology in Brazil*. Brazilian Academy of Sciences. Brazilian Limnological Society.
- Tundisi J.G., Y. Saijo & T. Sunaga.** 1997. Ecological effects of human activities in the Middle Rio Doce Lakes. In: Tundisi J.G. & Y. Saijo (Eds) *Limnological Studies on the Rio Doce Valley Lakes, Brazil*. Brazilian Academy of Sciences. USP, EESC, CRHEA: 477-482.
- Tundisi J.G. & M. Straškraba.** 1995. Strategies for building partnerships in the context of river basin management: The role of ecotechnology and ecological engineering. *Lakes & Reservoirs: Research and Management*, 1: 31-38.
- Twinch A.J. & D.C. Grobler.** 1986. Pre-impoundment as a eutrophication management option: a simulation study at Hartbeespoort Dam. *Water S.A.*, 12: 19-26.
- Tyson J.M.** 1995. Quo vadis - sustainability. *Wat. Sci. Tech.*, 32(5-6): 1-5.
- Uhlmann D., J. Benndorf & A. Gnauck.** 1977. Entwicklung von Modellen zur Vorhersage der Phytoplanktonentwicklung und Wasserbeschaffenheit in eutrophierten Staugewässern. *Wissenschaftliche Zeitschrift der Technischen Universität Dresden*, 26: 271-278.
- Uhlmann D., J. Benndorf & W. Albert.** 1971. Prognose des Stoffhaushaltes von Staugewässern mit Hilfe kontinuierlicher oder semikontinuierlicher Modelle. I. Grundlagen. *Int. Rev. ges. Hydrobiol.*, 56: 513-539.
- Ulrich M., D.M. Imboden & R. Schwarzenbach.** 1995. MASAS - a user friendly simulation tool for modeling the fate of anthropogenic substances in lakes. *Environmental Software*, 10: 177-198.
- van der Molen D.T., F.J. Los, L. van Ballegoijen & M.P. van der Vat.** 1994. Mathematical modelling as a tool for management in eutrophication control of shallow lakes. *Hydrobiologia*, 275/276: 479-492.
- Virtanen M., J. Koponen, K. Dahlbo & J. Sarkkula.** 1986. Three-dimensional water-quality-transport model

compared with field observations. *Ecol. Modelling*, 31: 185-199.

Vollenweider R.A. 1987. Scientific concepts and methodologies pertinent to lake research and lake restoration. *Swiss J. Hydrol.*, 49(2): 129-147.

Walker W.W.Jr. 1985. Empirical Methods for Predicting Eutrophication in Impoundments. Report 3, Phase II: Model Refinements. *Technical Report E-81-9. U.S. Army Engineer Waterways Experiment Station, Vicksburg, Mississippi.*

Wallsten M. 1978. Situation of twenty-five Swedish lakes now and 40 years ago. *Verh. Internat. Verein. Limnol.*, 20: 814-817.

Ward R.C., Loftis J.C. & G.B. McBride. 1986. The "data-rich but information-poor" syndrome in water quality monitoring. *Environmental Management*, 10: 291-298.

Ward J.V. & J.A. Stanford. 1983. The serial discontinuity concept of lotic ecosystems. In: Fontaine T.D. & S.M. Bartell (Ed.) *Dynamics of Lotic Ecosystems*. Ann Arbor Science, Ann Arbor, Michigan: 29-42.

Ward J.V., B.R. Davies, C.M. Breen, J.A. Cambray, F.M. Chutter, J.A. Day, F.C. de Moor, J. Heeg, J.H. O'Keeffe & K.F. Walker. 1984. Stream regulation. In: Hart R.C. & B.R. Allanson. (Eds) *Limnological Criteria for Management of Water Quality in the Southern Hemisphere*. South African National Scientific Programmes Report No 93: 32-63.

Welch E.B. & C.R. Patmont. 1980. Lake restoration by dilution; Moses Lake, Washington. *Water Res.*, 14: 1317-1325.

Welcomme R.L. 1988. *Intentional introductions of inland aquatic species*. FAO Fish. Tech. Pap. 294.

Wool T.A., J.L. Martin & R.W. Schottman. 1994. The Linked Watershed/Waterbody Model (LWWM): A Watershed Management Modeling System. *Lake and Reservoir Management*, 9(2): 124.

Young R.A., C.A. Onstad, D.D. Bosch & W.P. Anderson. 1989. AGNPS: a nonpoint-source pollution model for evaluating agricultural watersheds. *J. Soil Water Conservation*, 44: 168-172.

Žáková Z. 1996. Constructed wetlands in the Czech Republic - survey of the research and practical use. *Water Sci. Tech.*, 33: 303-308.

Zaret T.M. & R.T. Paine. 1973. Species introductions in a tropical lake. *Science*, 182: 449-455.

Zhadin W.I. 1958. Probleme der Bildung des biologischen Regims und der Typologie in Künstlichen Seen (Stauseen). *Verh. Internat. Verein. Limnol.*, 13: 446-454.

GLOSSARY AND MOST COMMONLY USED SYMBOLS AND ABBREVIATIONS

Entries given in *italics* are the subject of other entries in the glossary

A - Area of a reservoir

ACIDIFICATION - The decline of pH and alkalinity in waters, primarily due to emissions of sulphur oxides, nitrogen oxides and ammonia to the air as a result of industry and traffic

ACCURACY OF A METHOD - The level at which a method shows correct values. Electronic instruments have high *sensitivity* but very low accuracy if not properly calibrated

ADAPTATION - Ability of organisms to change their structure and function to better cope with their surrounding environment

ADSORPTION - The physical binding of a particular substance to the surface of another by adhesion

ADVECTION - Transport of water and its content by an imposed current. May be caused by river inflows, outflows, and wind shear at the air-water interface

AEROBIC CONDITIONS - Conditions with oxygen present

AGING of reservoirs - The period of rapid water quality changes after filling the reservoir

ALGAE - Microscopic, usually unicellular plants

ALLOCHTHONOUS - Brought to the waterbody from outside

ANAEROBIC CONDITIONS - Condition with the absence of oxygen

ANOXIA - Insufficiency of oxygen

ASSESSMENT - Process of evaluation of the physical, chemical and biological nature of water in relation to natural quality, human effects and intended uses

AUTOCHTHONOUS - Produced within the waterbody

BENTHOS - Bottom living organisms

BEST MANAGEMENT PRACTICES = *BMP*

BIOCENOSIS - The living part of an ecosystem

BIOLOGICAL DIVERSITY - Basically expressing the number of species in the environment and their numerical relations

BIOMANIPULATION - Management technique based on manipulation of fish populations and their effect on decreasing algal crops via reducing *zooplankton grazing*

BIOMASS - Quantity of living organisms expressed in units of volume or mass, generally related to the unit of volume or area of the waterbody

BIOSURVEY - The process of collecting, processing and analyzing aquatic communities to determine the community structure and function

BLUEGREENS, BLUE GREEN ALGAE = *Cyanobacteria*, *Cyanophyta* - A group of phytoplankton often producing *water blooms*

BMP = BEST MANAGEMENT PRACTICES - A management activity that eliminates or reduces an adverse environmental effect

BOD = BIOCHEMICAL OXYGEN DEMAND - The amount of oxygen required for the microbial breakdown of organic matter under aerobic conditions. Considered a measure of the easily decomposable organic matter

BOTTOM UP CONTROL - Natural control within the *ecosystem* directed from the physical- chemical conditions to *primary producers* and higher up the *trophic chain*

BUFFER ZONE - Zone around a reservoir managed in a way to protect it against pollution

CALCITROPHY - Trophic conditions in calcareous waters

CARLSON TROPHIC STATE INDEX - A numerical index for estimating reservoir trophic state

CATCHMENT = *watershed* - The area from which a surface watercourse or a groundwater system derives its water

CHA = CHLOROPHYLL-A - The photosynthetic pigment in algae and other plants essential for the process of photosynthesis. CHA is used as a measure of algal biomass
 CILIATES - Microscopic organisms belonging to the group of *Protozoa*
 CIRCULATION = *overtum* - Period of full mixing of the reservoir
 CLADOCERANS - Water flies, filtering crustaceans common in *plankton*
 CLEAN TECHNOLOGY - A technological approach directed to minimum energy, water and waste production to save the environment
 COD = CHEMICAL OXYGEN DEMAND - The amount of dissolved oxygen required for the oxidation of organic and inorganic substances in water. COD_{Mn} and COD_{Cr} are measured by oxidation in a manganese solution (incomplete oxidation) and in chromic acid (oxidations complete), respectively
 COHERENCE - The characteristic of *ecosystems* that their components match together
 CONDUCTIVITY - Measure of the total ion content of water
 CONSUMERS - All animal organisms in the ecosystem, so called because they feed on the organic matter already formed
 CONVECTION - Vertical transports induced by density instabilities. When a reservoir surface cools, the resulting denser surface water sinks, generating convective motions
 COPEPODS - Planktonic crustaceans filtering and grasping food from water
 CORRECTIVE (=curative, remedial) MANAGEMENT - Management directed to correct the degraded water quality of a reservoir
 CYANOBACTERIA = *bluegreens*
 DAM LAKE - A natural lake on which an artificial dam was constructed to raise the water level (usually for hydropower generation)
 DAM RESERVOIR - A reservoir build in a natural valley, in difference to the *impoundment*
 DECOMPOSERS - Organisms that break down organic matter and mineralize it (primarily bacteria and fungi)
 DEEP RESERVOIR (STRATIFIED) - Defined here as hydrologically deep reservoir, i.e., such that stratification can develop (in opposition to *shallow reservoir*, completely mixed by wind and *convection*)
 DENITRIFICATION - The bacterial reduction of nitrate via nitrite to ammonia
 DENSITY CURRENT - The current generated by merging the inflow and outflow current. It may flow at the surface, at the bottom = *underflow* and at intermediate layers (= *interflow*)
 DESTRAFIFICATION - The method to mix the waterbody from top to bottom. It can have both positive and negative effects on water quality
 DETECTABILITY OF A METHOD - The lowest values of the variable the method is able to recognize
 DETRITUS - Dead organic particulate matter that floats in the water or settles on the bottom
 DIATOMS - A group of algae with siliceous walls
 DIFFUSION - Mechanism reducing differences in concentration between adjacent layers. Molecular diffusion is a mechanism in which a certain property of a fluid is transferred down a concentration gradient by the random motion of molecules without any overall transport of a fluid taking place. Turbulent (or eddy) diffusion is a function of the microscopic movements of the fluid
 DIMICTIC LAKE - A lake that mixes twice a year (in the spring and fall periods)
 DISSIPATION - The process of degradation of matter from more to less organized form. Degradation of physical gradients, respiration of organisms, bacterial degradation and other are typical dissipative processes
 DISCHARGE = *runoff* - The measure of the water flow, expressed as volume per unit time, at a particular time
 DISSOLVED LOAD - The part of the total load carried in solution
 DO - Dissolved oxygen
 DOC - Dissolved organic carbon
 DSS = DECISION SUPPORT SYSTEM - The most advanced category of mathematical models for support of management decisions
 DYSTROPHIC - Water body type containing increased amounts of organic matter of natural origin (mainly from decayed vegetation). Brown water color is typical for dystrophic waters
 ECOREGION - A relatively homogeneous area defined by common ecological conditions (similar climate, landform, soil potential, natural vegetation, hydrology and other)

ECHOSOUNDER - The ultrasound instrument for detection of aquatic particulate matter (*suspended matter, plankton, fish*)

ECOSYSTEM - A discrete unit of nature containing both living and nonliving components, forming a system characterized by the interaction and recycling of matter

ECOTECHNOLOGY, ECOTECHNOLOGICAL METHODS - The use of technological means for ecosystem management based on deep understanding of principles on which natural ecosystems are built and on the transfer of such principles into ecosystem management in a way to minimize the costs of the measures and their harm to the global environment

ECOTONE - The border zone between different ecosystems, e.g., the freshwater and the terrestrial one

EIA = ENVIRONMENTAL IMPACT ASSESSMENT - The assessment of any major construction in respect to environmental degradation

END OF PIPE TECHNOLOGY - Improper technology of water purification directed to decrease pollution coming from industrial pipes

EPILIMNION - The illuminated (trophogenic) upper water layers of a reservoir

EUTROPHIC - Water body type characterized by high levels of nutrients and high productivity

EUTROPHICATION - The process of becoming eutrophic

EXPERT SYSTEM - A type of interactive mathematical models where specific answers are given based on the meaning of experts

FEEDBACK - A relation between two (or several) objects when beyond the effect of the first on the second object the second affects the first one. Feedback might be positive or negative

FOOD CHAIN - Functional linkage of organisms in a water body. The usual sequence in the chain is *primary producers, primary consumers, secondary consumers, predators, top predators*

FOOD WEB - A more complicated functional linkage of organisms in a water body when clear chain-like relations cannot be distinguished

FREE WATER REGION = *pelagic region*

FUZZY SYSTEMS - Systems with diffuse borders, not clearly bordered

GIS = GEOGRAPHICAL INFORMATION SYSTEM - The software product used for handling spatial data

GOAL FUNCTION - In *optimization* a function, specifying the goal of the system (both for management and assumed goal of the natural ecosystem)

GRAZING - Nonpredatory feeding activity of organisms

HIGHER VEGETATION - Phanerogams or true plants, in reservoirs inhabiting the *littoral zone*

HOLISTIC - The approach to the understanding and study of systems based on global characteristics. The antithesis to *atomistic*

HOMEOSTATIC CAPABILITY - Capability of a system to reduce the oscillations of the input

HOMOTHERMY = *isothermy*

HYPERTROPHIC - Extremely eutrophic waters

HYPOLIMNION - Deep (tropholytic) strata of the reservoir below the *thermocline*

IMPOUNDMENT - A reservoir built besides the river valley and then filled with river water

INDIRECT EFFECTS - The effects between several objects when the effect is not directly from the nearest object, but from remote ones (in the food chain or net)

INTEGRATED MANAGEMENT - Management considering all aspects of the problem

INTERFLOW - The lateral movement of water through the layers of the reservoir at an intermediate depth

ISOTHERM - A plane connecting same temperatures (a line in a three-dimensional depth - time graph)

ISOTHERMY = *homothermy* - Period when the reservoir is fully mixed (isothermal) with no vertical temperature differences

LACUSTRINE ZONE - Zone of the reservoir closest to the dam

LEACHING - The washing of ions out of soil and rocks by water

LIFE CYCLE EVALUATION - Evaluation of the production process in respect to environmental deterioration during the individual process phases from mining of raw materials to their decomposition after use

LIMNOLOGY - The study of physical, chemical and biological processes in reservoirs

LITTORAL ZONE - The bank zone of the reservoir usually occupied by higher plants

LOAD - The amount of material reaching a waterbody per unit of time

MACROPHYTA - Macroscopic plants (phanerogams). In water they are emergent, submerged or floating on the surface

MEI = MORPHOEDAPHIC INDEX - An index characterizing the

MESOTROPHIC - Waters with intermediate nutrient concentrations and productivity

METALIMNION - The zone intermediate between the *mixing zone* and *hypolimnion*. While *thermocline* is usually considered just a plane or very narrow zone, metalimnion is used when explicitly process in the transition zone that might be a several meters high are considered

MICROBES - The group of microscopic organisms

MICROPLANKTON - Very small plankton between 60 and 200 μm

MICROZOOPLANKTON - Zooplankton belonging to microplankton, composed mainly from *ciliates* and small *rotifers*

MIXED LAYER - The upper water layer of a reservoir mixed almost on a daily basis

MIXING - Any mechanism or process that causes parcels of water to be exchanged or diluted by others. It covers *diffusion, dispersion and convection*

MONITORING - The collection of information as set of locations and at regular intervals

MONOMICTIC RESERVOIR - The reservoir that is fully mixing only once a year (in the colder period - warm monomictic lakes, subtropical and warm temperate lakes), or in the warmer period (cold monomictic)

MORPHOEDAPHIC INDEX - The ratio of dissolved solids to mean lake depth

NANNOPLANKTON - Planktonic organisms not larger than 60 μm and larger than 5 μm

NITRIFICATION - Microbial oxidation of the ammonium via nitrite to nitrate

OFFTAKES - Specific type of reservoir *outlets* from where water is taken to waterworks or irrigation

OLIGOMICTIC RESERVOIR - A reservoir with the intervals between mixing exceeding one year

OLIGOTROPHIC - Waters poor in nutrients and with low productivity

OP = ORTHOPHOSPHATE-REACTIVE PHOSPHORUS - The mineral component of phosphorus, as opposed to organic phosphorus, both together forming *TP*

OPTIMIZATION - Mathematical procedure for finding minima or maxima of a function. For a complex system the function is quite complicated and optimization selects among limited sets of alternatives

OUTLET - The opening in the dam through which water can flow out of the reservoir. A specific type of outlet is *offtakes*

OVERTURN = *circulation*

OXYGENATION - Increasing the oxygen concentration in water

PELAGIAL = PELAGIC ZONE - The *free water region* of a water body

PERIPHYTON - A group of organisms living on *macrophytes* in the *littoral zone*

PHOSPHORUS INACTIVATION - A method to coagulate phosphorus in the reservoir

PHOSPHORUS RETENTION - Capacity of reservoirs to retain the inflowing phosphorus in the sediments and thus decreasing the outflowing amount

PHYTOPLANKTON - The algal component of *plankton*

PLANKTON - Organisms inhabiting the free water region of a reservoir

POLLUTANT - A by-product of human activities that enters or becomes concentrated in the environment, with deleterious effects

POLYMICTIC RESERVOIR - A reservoir in which mixing events occur at frequent intervals

PREDICTIVE MODELS - Models aimed to predict water quality for specified conditions

PRE-RESERVOIRS - Smaller reservoirs build at the inflows to the reservoir for *phosphorus retention* (also sediment retention)

PRIMARY PRODUCERS - The plant (phototrophic) component of the ecosystem, producing organic matter from inorganic materials. Here belongs *phytoplankton, periphyton, higher vegetation*

PREDATORS - Animals feeding on other animals

PREVENTIVE MANAGEMENT - Management directed to preventing water quality degradation

PRODUCTION - The amount of organic matter produced within the reservoir by organisms

PROTOZOA - A group of organisms with bodies consisting from a single cell. Colonies of almost identical cells also appear

PUMP STORAGE or PUMPING SCHEME - System of at least two reservoirs from one of the two the water is pumped during periods of low electricity needs into a highly located one and then released back to produce electricity during peaks during daily periods of maximum need

R = *retention time*

REDEVELOPMENT - Activities aiming at a general upgrading of the environment according to given goals for the sustainable utilization of *ecosystems*

RESERVOIR CASCADES - Systems of reservoirs on the same river closely following one another

RESERVOIR EVOLUTION - Long-term changes of the reservoir due to natural processes. Filling of the reservoir with sediments is an important component. Here distinguished from *reservoir aging*, covering the first few years of rapid water quality changes

RESERVOIR MULTISYSTEMS - Systems of reservoirs located in different watersheds

RESTORATION - Measures in the ecosystem to adjust the structure and govern the function of a specific ecosystem

RETENTION TIME (THEORETICAL) - The ratio of volume and flow of the reservoir

RIPARIAN FOREST - Forests along the river on the slopes of the valley

RISK ASSESSMENT - A process that includes hazard identification and evaluation

RIVER CONTINUUM - Hypothesis of the continuous transition of rivers and their limnological characteristics from headwaters to large rivers

RIVERINE ZONE - Zone of a reservoir closest to the river inflow

ROTIFERS - A group of animals belonging to microzooplankton

RUNOFF = *discharge*

SALINIZATION - The increase of salinity of waters

SECCHI DISC - A white or preferably black and white disc for the measurements of *transparency*

SEDIMENTATION - The process of sedimentation of organisms and abiotic matter (*detritus, seston*)

SELFOPTIMIZATION - The tendency of natural systems to optimize to best survive in the given environment

SELPURIFICATION - Capability of the ecosystem to decompose organic matter into mineral one

SELFORGANIZATION - The tendency of natural systems to organize their structure in accordance with the environmental conditions

SENSITIVITY OF A METHOD - The lowest difference that the method can distinguish

SESTON - The total suspended matter in a waterbody, including *detritus*

SHALLOW (HOLOMICTIC) RESERVOIRS - Defined on the hydrological basis (not on absolute depth) such reservoirs that can be in summer time completely mixed by wind and *convection*. Decisive is the ratio of surface area and depth - a small waterbody with a depth of a few meters can stratify, i.e., be hydrologically deep while a much larger reservoir and much deeper can be hydrologically shallow

SHEAR - The advection of a fluid at different speeds and positions. It requires a velocity gradient. It can be generated at the air-water interface by the wind, along the bottom boundary, by inflow currents and internally by *density currents*

SILTATION - Filling of reservoirs with *suspended matter*

SPATIAL VARIABILITY - Horizontal or vertical variation of water quality variables

STANDING CROP = *biomass*

STRATIFICATION - Layering of water caused by differences in water density

STREAM ORDER - Hydrologic order of a stream from the smallest creeks to largest rivers

SUSPENDED MATTER - Organic and inorganic matter suspended in water

SUSTAINABLE DEVELOPMENT - Long-term development taking the welfare of future generations into consideration

SUSTAINABLE MANAGEMENT - Management with long term horizon, in a way to enable long-term (many more years) use without secondary deterioration of the environment

TERRESTRIAL ECOSYSTEM - *Ecosystem* of the dry land

TERTIARY TREATMENT - In conjunction with (1) mechanical treatment and (2) biological treatment it is the third step constructed for removal of nutrients, dominantly phosphorus

THERMOCLINE - A horizontal layer of water with a particularly steep temperature gradient (see also *metalimnion*)

TOP DOWN CONTROL - Control within the reservoir ecosystem from top predators down to *phytoplankton* and reservoir chemistry and physics. Opposite to *bottom up control*

TOP PREDATORS - *Predators* on the top of the *food chain*, in reservoirs dominantly fish, but also alligators and others

TP = TOTAL PHOSPHORUS - All forms of phosphorus together

TRANSITIONAL ZONE - Zone of the reservoir that is transitional between the *riverine* and *lacustrine* zones

TRANSPARENCY - Water clarity measured approximately by *Secchi disc*

TROPHIC LEVEL - A group of organisms with identical ecosystem function (*primary producers, consumers, predators*)

TROPHIC STATE - The degree of trophic of the water given by the amount of critical nutrients and realized in organisms (*oligotrophy, mesotrophy, eutrophy, hypertrophy, dystrophy*)

TROPHIC UPSURGE - The short (a few years) period after the reservoir filling, characterized by high trophic, in particular by high fish production

TURBIDITY - Decrease of water transparency due to *suspended matter*

TURBULENT MIXING - Water motion in which the water particles interwave and give rise to transverse *mixing*

UNDERFLOW - *Density current* flowing along the bottom of the reservoir

ULTRAPLANKTON - Planktonic organisms smaller than $5 \mu\text{m}$

V - Volume of a reservoir

WATER BLOOMS - Accumulations of *algae* or *Cyanobacteria* at the reservoir surface

WATERSHED = *catchment*

Z_{cu} - The depth of the *epilimnion*

Z_{mix} - The *mixing depth* of a reservoir

ZOOPLANKTON -The animal component of *plankton*, consisting dominantly of *protozoans* (particularly *ciliates*), *rotifers, cladocerans* and *copepods*

INDEX

- A
- Accountable pollution certificates 196
- Accuracy 105, 112
- Acid rain 28, 53, 82, 98
- Acidification 75, 76, 77, 82-83, 84, 119, 126
- Acidification management 128
- Activated carbon 124
- Adaptability. 89
- Adaptation 86
- Adenovirus 57
- Aeration 136, 138, 140, 157
- Aeration/oxygenation at outlet 156
- Aerial photographs 112
- Agasicles* 150
- AGENDA 21 17
- Aging 14, 39, 57-59, 189
- Agricultural development 78
- Agricultural practices 127, 133
- Agriculture 27, 82
- Agro-chemicals 85
- Akosombo Reservoir 9
- Alestes* 68
- Algae 26, 54-56, 64, 65, 82, 97, 98, 99, 102, 121, 129, 136, 138, 144
- Algal blooms 91, 101, 146, 159
- Alkalinization 124
- Algicides 16, 135, 148, 151
- Alkalinity 49, 97
- Allelopathic reactions 53
- Allergens 101
- Alum precipitation 135, 151
- Aluminum 53, 82, 84, 143
- Amazonian reservoirs 58, 62, 63, 82, 84, 153, 198, 199
- Amictic waterbodies 62
- Ammonia 65, 72, 95, 98, 118, 119
- Ammonification 52
- Anabaena* 121, 187, 188
- Anaerobic conditions 99
- Annual course of temperature 44
- Anoxia 62, 96, 98, 99
- Aphanizomenon* 121, 184
- Antimon 84
- Apstein type plankton net 109, 110
- Arsenic 84
- Aquaculture 71
- Aquatic birds 163
- Aral Sea 36, 91
- Asahi Reservoir 10, 49
- Ascaris* 84
- Argyrodiaptomus* 192
- Assimilation capacity for pollutants 93
- Aswan Reservoir 9, 82, 92, 152
- Atatürk Reservoir 9
- Atmospheric pollution 28, 84
- Australian Reservoirs 154
- Automated in situ measurements 195
- Automatic monitoring 111, 112, 179, 189, 194
- Awareness campaigns 134
- B
- Bacteria. 50, 56-57, 100, 110
- Bacillariophyceae 121
- Bacterial contamination 83
- Bacteriological variables 99
- Bacterioplankton 53
- Balaton Lake 131
- Balbina Reservoir 10, 155
- Barra Bonita Reservoir 10, 61, 72, 90, 113, 186-188
- Basin morphology 33
- Bays 47, 95
- Benndorf's graphical model for
PO₄-P-elimination 173
- Benthic zone 41
- Benthos 53, 82, 99, 101, 154, 184
- Benthos feeders 56, 73
- Best Management Practices - BMP 127
- Billings Reservoir 10, 159
- Bioaccumulation 143
- Biodiversity 19, 82, 87, 90, 93, 126, 134
- Biological characteristics 96
- Biological filter 89, 132, 134
- Biomanipulation 83, 87, 92, 135, 143, 146, 150, 158, 161, 190, 194
- Biomarkers. 123
- Bioplateau 132, 133
- Biosurveys 115
- Bioturbation 53
- Black waters 52, 65, 72
- Bismuth 84
- Bitterfelder Muldestausee 84
- Blood flukes 84
- Blue-Greens 17, 55, 136, 159
- BOD 41, 52, 56, 95, 97, 99, 119
- Bottom up effects 54, 87
- Brachydanio* 122
- Bratsk Reservoir 9

Broa Reservoir	10, 163, 190-192
Brownwaters	65
Brundtland Commission	17
Buffer zones	26, 134
Bukhtarma Reservoir	9

C

Cabora Bassa Reservoir	9, 67
Cadmium	84
Calcitrophic waterbodies	65-66
Calcium	65
Calcium nitrate	142
Calculation models	171
Calibration	112
<i>Campylobacter</i>	57
Caniapiscau Bar. KA3 Reservoir	9
Canning Reservoir	10, 45, 46
Carbon dioxide	21, 62, 85, 118
Cascade reservoir	183
Census methods	73
<i>Ceratium</i>	121
<i>Cichla</i>	74, 93
Channel construction, river	
channelization	27
<i>Chaoborus</i>	56
Chemical composition	96
Chemical subsystem	49-53
Chinese lakes	93
Chironomidae	73
<i>Chlamydomonas</i>	121
Chlorides	95, 97, 119
Chlorophyll-a	55, 64, 65, 80, 95, 97, 110, 113, 118, 119, 121, 179
Chlorophyll-a vs. total phosphorus relationships	171-172
Chloroform	118
<i>Chloromonas</i>	121
Chlorophyceae	121
<i>Chromium</i>	84
<i>Chromulina</i>	121
<i>Chrysococcus</i>	121
Ciliates	56
Circulation	96
Cladocerans	56
Clarke-Bumpus zooplankton sampler	109, 110
Classification	115
based on reservoir throughflow	60
geographical	60
of lake stratification	45
of reservoirs	58
Clean	
layer technique	189
production	195, 125
technology	18
Clear water phase	189
Climate Change	196
<i>Clupeichthys</i>	68
<i>Clupeonella</i>	68
Coagulation	124
COD	40, 41, 52, 97, 99, 119
<i>Coelastrum</i>	121
Coherence	86
Coliform bacteria	56, 57, 95, 100, 119, 120
Colonial blue-greens	55
Colonization	87, 90, 93
Color	95, 97, 99
Colorado River	152
Combined classification	66
Competition	90
Complex dynamic models	174
Conductivity	49, 95, 97, 107, 191
Conflicting uses	92
Connectivity	87, 89
Consequences of destratification	136
Construction characteristics	30
Consumers	54
Control of industrial effluents	133
Control of vegetation with herbicides	150
Copepods	56
Co-precipitation	66, 172
Copper poisoning	16, 91, 135, 148, 151
<i>Coriaca</i>	68
Corrective (=curative, remedial) management	15-16, 17
Corridors for animal migration	19
Corrosion	159
<i>Cosmialosa</i>	68
Coulter counter	111
Covering sediments	135
<i>Coxsackievirus</i>	57
CO ₂	21, 79, 118, 153, 159
<i>Cryptomonas</i>	121
<i>Cryptosporidium</i>	84
Cryptophyceae	121, 189
<i>Crucigenia</i>	121
<i>Cyclotella</i>	121
Cryptomonadina	185
Critical nutrients	64
Curtains	135, 147, 148, 156
Curua Una Reservoir	10, 34, 62, 159
Cyanobacteria (=Cyanophyta)	51, 54-55, 65, 80, 96, 113, 121, 137, 184, 185, 189
Cytofluorometers	111
Czech method of oxygenation	156

D	
Dam lakes	3
Dam reservoirs	5
Dam reservoirs - comparison with lakes	4
Daniel Johnson Reservoir	9
Danish lakes	149
<i>Daphnia</i>	122
Data	
analysis	105
collection	104
storage and handling	113
transmission	112
DDT	16
Deacidification	124
De Gray Reservoir	10
Decision support systems (DSS)	170, 180-181
Declining water levels	77
Decomposers	53
Decomposition	116, 118
Deep outflow	33
Deep polymictic waterbodies	62
Deep water bodies	42
Deforestation	26, 40
DeGray Reservoir	49
Denitrification	93, 142
Density	44, 61
currents	42, 46-48, 120
gradient	44
Dependence on flow rate	113
Depth profile	108, 117
Depth profile instruments	112
Destratification	17, 135-138, 157
Detention time (=retention time)	32
Detectability	105
Detergents	160
Deterministic models	170
Detritus	153
Detritus food chain	56-57
Diatoms	55, 98, 121, 185
Differences between a lake and a reservoir	39
Diffuse sources	76, 125
Dimictic waterbodies	62
Dinobryon	121
Dinophyceae	121
Dilution	146
Discharge of sewage and wastes	26
Dissolved oxygen (DO) (see also oxygen)	52, 95, 97
Distribution of sampling	106
Diversion of effluents	130
Downstream effects	152-153
Drawdowns	144, 149

Dredging	135, 141
Drinking water	
reservoirs	158, 159
quality	158
supply	30, 95, 188, 190
Dystrophy	119

E

Echosounder	73
<i>Echovirus</i>	57
Ecological economics	195
Ecological engineering	194
Ecoregions	115
Ecosystem	37
charter for the great lakes -	
st. Lawrence basin	23
research	192
Ecotechnological	
approaches	150
management principles	90
methods	6, 126, 133
Ecotechnology	95, 194
Ecotone	90, 134
Effect of fish	189
Efficiency of pre-impoundments	172
EIA	24-25, 106
Eibenstock Reservoir	130
Eildon Dam	10, 155
El Cajon Reservoir	10, 79, 159
Emission criteria	19
End of the pipe methods	18, 91
<i>Entamoeba</i>	84
Environmental	
costs	195
education	134
effects of reservoir construction	21
impact assessment	14, 24-25, 106, 162
Epilimnetic mixing	3, 92, 112, 135, 139, 150, 151, 194
Epilimnetic pumps	156
Epilimnion	42, 44
<i>Escherichia</i>	57
<i>Etrivaza</i>	68
Erie Lake	73
Erosion	40, 81-82, 95, 98, 127, 133, 149, 162
<i>Eucalyptus</i>	40, 158
Euphotic zone	41
Eutrophic waterbodies	64, 80, 183, 186
Eutrophication	26, 28, 43, 50, 76, 77, 80, 96-97, 102, 125-126, 160
Eutrophication management	127

Evaluation	
according to individual variables	115
of bacteria	119
of heavy metals	120
of mineral composition - hardness - salinity	119
of nitrogen	118
of organic matter	119
of oxygen	116
of pH	119
of phosphorus	118
of phytoplankton composition	120
of toxic organics	120
of transparency	115
of zooplankton	122
Evapotranspiration	101, 191
EXCEL	113
Excretion	49
Exotic species	74
Expert systems	170, 180
Extinction coefficient	42, 52
Exudates by phytoplankton	56
F	
Fairmont Lake	10, 148
Fecal streptococci	100
Feedback	86, 87, 103, 105
Feeding relations of fish	73
Ferric chloride	142
Fertilizers	26, 83, 119, 127, 129
Filter-feeders	56
Filter system	26
Filtration	124
Finnish lakes and reservoirs	177
Fish	55-56, 98-99, 101, 144, 145, 150, 154
biomass	69, 189
communities	67
cultivation	30
effect	189
farming	24
introductions	74, 145
mortality	17
parazitoses	163
populations	144, 160
production	69
sensitivity	72
stock	97, 122
Fisheries	71-74
Flood protection	30
Flow and retention time	32
Flow rates	95, 97
Fluoride	95
Food chain	28, 53, 54, 85, 93, 143
Food web	57
Forcing functions	175
FRAMEWORK	114
Fulvic acid	52
<i>Fragilaria</i>	121
FORTTRAN	177, 181
Freshwater sardine	20
G	
Gas release	82
Gastroenteritis	57
Gatun Reservoir	74, 93
General Lake Water Quality Index	114
Generations of models	169
Geographical	
differences of surface temperatures	45
information systems (GIS)	169, 170, 174
location	44,45
Gersau Lake	118
<i>Giardia</i>	84
Global Changes	19, 75, 156, 198, 193
Global environmental effects	91
Global warming	75, 196
Global water partnership	19
Goal function	178
Gradients	32
Grazing	56
Great Lakes	73
Green algae	55, 121, 136
<i>Gudusia</i>	68
Guri Reservoir	9, 70
H	
Haemoglobin	98
<i>Halicore</i>	149
Hardness	49, 95
Hartbespoort Dam	10, 70
Health effects	83, 151
Heavy metal pollution	76, 84
Heavy metals	79, 82, 85, 120, 126, 128
Hepatitis	57
Herbicides	26, 52, 85, 150
Herbivores	53, 149
Heterotrophic flagellates	56
High Aswan Reservoir (=Aswan Reservoir)	9, 82
Highe plants	26
Homeostasis	86
Horizontal differences	49
Human health	98
Hume Reservoir	10, 155

Hydraulic regulation	146
Hydraulic stratification	44
Hydraulically stratified reservoirs	61
<i>Hydrocynus</i>	69
Hydroelectricity	30, 166
Hydrogen sulfide	99
Hydrology	153, 191
Hydrometeorology	97
Hygienic restrictions	159
Hypertrophic	64
Hypolimnetic	
aeration	135, 136, 138
anoxia	76, 82, 99
flushing	146
oxygen demand by reservoirs	174
phosphorus	147
siphoning	135, 147
temperatures	147
Hypolimnion	43, 44
<i>Hypophthalmichthys</i>	145, 150
Hypsographic curves	95
Hysteresis effects	103
H ₂ S	21,79,82,153,159
I	
IIASA	177
ILEC	76, 77, 175, 178, 185, 194
Illuminometers	158
Immission criteria	19
Impacts	26
Impacts on freshwater resources	25
Importance of reservoirs	3
Impoundments	5, 139
In-lake ecotechnological management	135
In-lake methods	151
Inactivation of phosphorus	143
Inadequate exploitation of biomass	28
Indian River Reservoir Complex	10, 84
Indicators	100, 112
Indicators of fecal pollution	56
Indirect effects	87, 89
Inflow rate	32
Inflow temperatures	41
Influence of fish on water quality	72
Infrastructure	24
Instruments	109
Integrated	
management	24, 165
management information and partnership system	22
samples	110
watershed management	21
Inter-calibration	109
Interconnected subsystems	91
Interflow	46-47, 61
Introduction of exotic species	28, 33, 74
Irkutsk Reservoir	9
Iron	50, 84, 96-97, 99, 118, 136, 138, 147
Irrigation	24, 27, 30, 83
Itaipu Reservoir	10, 69, 70
Itaqueri River	190
Itumbiara Reservoir	10, 34
K	
Kainji Reservoir	20, 68
Kamyk Reservoir	184
Kaptui Reservoir	10, 68
Kariba Reservoir	9, 20, 68-69, 74
Kelvin-Helmholz instabilities	42
Kis-Balaton Reservoir	131
Kleine Kinzig Reservoir	10, 130
Kličava Reservoir	10, 59
Krasnoyarsk Reservoir	9
Kuibyshev Reservoir	9
L	
La Grande 3 Reservoir	9
Lacustrine zone	47, 49
Lake Balaton	132
Lake Gatun	10
Lake Michigan	166
Lake Washington	130
Lake Yunoko	10
Lambert-Beer law	42
Landsat	113
<i>Lates</i>	69-70
Latitudinal variability of surface temperatures	44
Layer aeration	135, 140, 150
<i>Leporhinus</i>	69
<i>Leptodora</i>	56
Life cycle evaluation of products	23
Light	153
availability to the algal populations	148
regime	31
Limitation	65
Limiting factors concept	87, 88
Limnological types of reservoirs	58
Limnology	6, 191
<i>Limnotrissa</i>	69
<i>Limnothrix tanganyicae</i>	20
Litoral zone (=region)	41, 54
Lobo Reservoir (=Broa)	190
Lobo River	190

Local management council	22
London reservoirs	5, 139, 165
Long-term effects	91
Longitudinal zonation	39, 48
LOTUS	113
Low-tech, nature friendly methods	18
Lugol solution	110
Lynby Lake	175

M

Macrophytes	73, 113, 134, 191
control	135, 149-150
harvest	149
Magnesium	95
<i>Mallomonas</i>	121
Malše River	188
Man-made lakes	3
Management	
approaches innovative	19
conclusions	123
costs	14
decentralized	19
long-term measures	14
of acidification	128
of reservoir cascades	163
of reservoir inflow	129
of reservoir outflow	152, 155-158
of streamside vegetation	133
of the reservoir outflows	155
of turbid inflows	129
of watershed integrated	21
perspective	57
relation to other problems	14
rules	94
unexpected problems	14
Managers - responsibility	18
Manatee	149
Manganese	50, 96-97, 99, 118, 136, 138, 147
Manual sampling	109
Mass fish kills	113
Mathematical modeling	168, 195
Mathematical models	19, 153
<i>Melosira</i>	121
Mercury	84
Meromixis	63, 72
Mesophilic bacteria	56, 100, 119-120
Mesotrophic waterbodies	64, 80, 183, 188
Metalimnetic minima	118
Metalimnetic mixing	135
Metalimnion	43-44
Methane	62, 82, 159
Methaemoglobinemia	81

Michigan Lake	166
Microbial loop	57
Microbial food chain	189
Microbiological variables	97
<i>Microcystis</i>	121, 159, 184, 187-188
Microelements	98
Microorganisms	57
Microscopic counting and sizing	100
Mineral composition	49
Mineral oil	120
Mineralization	59
Mimimata	72
Mining	26
Mixing	39, 53, 66, 135, 141, 148
depth	179
intensity	33
processes	42
types	61-63, 136
zone	41-42, 44
Model	
AGNPS	174
AQUAMOD 3	175
AQUATOOL	181
ASTER	177
Benndorf-Uhlmann model	172
BLOOMII	176
CE-QUAL-RIV1	176
COMMAS	180
CONSTANT SEDIMENT FEEDBACK PHOSPHORUS MODEL	176
CRAM	174
DELWAG-BLOOM-SWITCH	180
DYRESM, DYRESM-WQ	177
generation	169
GEO-WAMS	170
GFMOLP	180
GIRL OLGA	180, 181
HEC-3	181
LAKE	175
LAKE NUMBER MODEL	174
LUNG PHOSPHORUS MODEL	175
LWWM	170
MASAS	181
MECHANISTIC WATER-SEDIMENT MODEL	176
MELODIA	177
MIKE	176
MINLAKE	176
REH	180
RESTEMP	174
RESQUALII	176
SALMO	176

SALMOSED	176
TETrans	174
WASP4	176
of DO and P in stratified lakes	174
of end-of summer oxygen profiles	174
of hypolimnion discharge	174
Molybdenum	84
Monitoring	14, 19, 104, 133, 179
Morphoedaphic index (MEI)	69
Morphometry	47
Moses Lake	10, 146
Multi-goal formulation	179
Multi-goal models	170
Multiparameter models	170
Multiparametric formulation	179
Multiple outlets	146, 158
Multiple use	200
Multipurpose reservoirs	14, 194

N

<i>Naegleria</i>	84
Naser Reservoir (=Aswan)	20
N:P weight ratio	65, 98
Natural structures	92
Navigation	30
Negative feedback	88
<i>Neochetina</i>	150
Nephelometric turbidity units	115
Nile River	82
Nile Delta	152
Nitrate	65
Nitrate contamination	76, 81
Nitrate/nitrite	95
Nitrates	98, 154
Nitrification	52-53, 98
Nitrites	98, 154
Nitrogen	17, 61, 81, 97-98, 113, 118, 127, 154
cycle	51
fixation	51, 53
retention by shallow reservoirs	174
supersaturation	153
Nitrosamines	98
Not-poit source pollution	76
<i>Notodiptomus</i>	192
<i>Norwalk</i>	57
Nutrient addition tests	122
Nutrients	18, 50, 96, 98, 117, 145
Nyos Lake	85

O

Odor	95
Oligomictic type	61
Oligotrophic	64
Omnivorous fish	145
<i>Oncorhynchus</i>	122
Open water	41
Operational management	194
Optimization models	170
Optimum depth	139
Organic compounds	99
Organic matter	52, 53, 56, 65, 117, 154
Organic pollution	76, 78, 125, 126, 127
Organoleptic qualities	101
Organochlorides	158
Orientation scheme	107, 108
Orlik Reservoir	184, 185
<i>Oscillatoria</i>	121
Outflow	102, 155-158
Outlet depth	30, 60, 152, 153, 155
Outlet location	33, 46, 96
Overfishing	73
Overflow	47
Owen Falls	9
Oxygen	17, 40, 52, 56, 95, 97, 99, 153, 166
concentration in the hypolimnion	117
depth profiles	114, 117
saturation equation	116
stratification	53
Oxygenation	135, 140, 157

P

PARODOX	113
Parakruma Samudra	10, 68
Paranao Reservoir	10
Parasitic protozoans	84
Parasitic worms	84
Pareloup Reservoir	177
<i>Purovirus</i>	57
Participation principle	196
Partnerships	14, 19, 22, 134, 191, 200
Pathogenic bacteria	56, 79
Pathogens	95
Paulo Afonso Reservoir	10
PCB	73, 128
<i>Pediastrum</i>	121
<i>Pellomula</i>	68
<i>Perca</i>	189
<i>Peridinium</i>	121
Periphyton	54, 122
Pesticides	16, 26, 52, 85, 120, 128, 149

Petroleum	120
pH	21, 53, 95, 96, 97, 98, 99, 107, 128, 154
Phenols	120
Phosphates in detergents	98
Phosphorus	56, 61, 64, 65, 80, 81, 97-98, 99, 118, 136, 141, 154
cycle	50
inactivation	143
retention	51, 102, 130, 174
Physical subsystem	41-47
Phytoplankton	
	32, 42, 43, 49, 50, 53, 55, 97, 98, 100, 110, 120, 154, 189, 191
biomass	43, 121, 145, 154, 160, 189
limitation	119
production and respiration	139, 154
<i>Piaractus</i>	69
Piracicaba River	186, 187
<i>Plagioscion</i>	69
<i>Planktosphaeria</i>	121
Plankton	154
Planning ahead	14
Plant feeders	73
<i>Plasmodia</i>	84
Plastic tube	110
Plumbum	84
Plunging point	46, 47
Po River	132
Point sources	125
Pollution types	75
Polychlorinated biphenyls	120
Polymictic waterbodies	63
Population displacement	27
Porto Primavera Reservoir	157
Porttipahla Reservoir	10
Positive feedback	89, 128
Power generation reservoirs	159, 183, 186, 190
Precipitation	167
Predators	53, 54, 73, 189
Predatory fish	144
Preimpoundments (=pre-reservoirs)	130, 134, 163
Prescriptive models	170, 178
Prevention	91
Preventive management	15-17
Preventive methods	194
Primary producers	54
Primary production	64, 98, 184
Primary purification of effluents	132
Principal component and cluster analysis	114
Producers	53

Profiles of selected dams	34
Propeller mixing	135, 140, 157
Protozoans	56
Psychrophilic bacteria	56, 100, 119, 120
Puget Sound	130
Pulse effects	87, 90
Pump storage	30
Pumping schemes	35, 160, 165
Purification	163

Q

Quantity of water	29
QUATRO	113

R

RAISON	177
Raritan River	165
Re-set distance	31
Recording	111
Recovery of natural wetlands	134

Recreation	30, 167, 185, 187, 190
and tourism	27
at the lake shore	161
in the watershed	161
on the lake surface	162
Recreational activities	159
Recycling of nutrients	53
Redfield ratio	65
Regional management	13
Regional models	177
Remote sensing	194
Reservoir	
aging	57
and economic development	
of regions	20
bacteria	56
cascades	34, 35, 160, 163-164
classification	60-66
construction	26, 193
construction consequences	20
definition	3
depth	33
distribution	7
ecosystem dynamics	92
evolution	57
fisheries	67
food web	53
inflow	40
mixing classes	61-63
multisystems	34, 35, 164
outflow	37

pumping schemes	34
size	33, 106
size categories of reservoirs	33
stabilization	59
suitability for drinking water supply	117
transition between rivers and lakes	5
trophic character	59
systems	34, 163-167
uses	29-30
Reset distance	155, 160
Respiration	116, 139
Resuspension of sediments	153
Residence time (retention time)	32
Retention of organic matter	174
Retention time	30, 32, 39, 41, 45, 46, 60, 66, 95, 98, 102, 130, 152, 160
Řimov Reservoir	10, 46, 188-190
Rio Declaration on Environment and Development	17
Riparian forests	127, 134
Riplox	142
River	
below a reservoir	152
channel structure	153
continuum	30
Riverine zone	47
Road and railroad construction	26
<i>Rotavirus</i>	57
Rotifers	56
Round Reservoir	10, 165
Russian reservoirs	60
Ruttner's water sampler	109
S	
Salinity	43, 50, 96
Salinization	27, 76, 83, 102, 126
Salinization management	129
<i>Salmo</i>	82
<i>Salmonella</i>	57
Salvelinus	82
Sample preservation	110
Samplers	109
Sampling	104
at the outflow	109
before the reservoir is constructed	106
instruments	109
stations	106
timing of	106
the inflow	108
the reservoir	108
Saprobic index	100
<i>Sarotherodon</i>	67, 68

Satellite imagery	112
Schindler zooplankton sampler	109, 110
<i>Schistosoma</i>	84
<i>Scirpion</i>	90
Seasonality	106
Secchi disc depth	42, 108, 115
Sediment	
aeration and oxidation	142
and benthos grab	109
injection	135
removal	141
Sedimentation	49, 81, 100
Seiches	39
Selective offtakes and withdrawals	135, 146, 150, 156
<i>Selenastrum capricornutum</i>	65, 122
Self-organization	86, 87, 89
Self-purification	90, 163
Sempachersee Lake	94
Sensitivity	105
of fish to water quality	72
to inputs	92
Sewage	26, 79, 83
Shading	135
Shallow water bodies	42
S. Francisco River Reservoirs	199
Shelbyville Lake	180
Shagawa Lake	176
<i>Shigella</i>	57
Short-ent currents	48
Side-effects	16
<i>Sierathrisa</i>	68
Silica	98
Siltation	77, 81, 126, 153
Siltation management	129
Simazine	148
Site constants	175
Site selection	106
Slapy Reservoir	10, 60, 183-185, 188
Small waterbodies	42
Sobradinho Reservoir	10, 70
Socio-economic subsystem	38
Sodium	95
Sorption - desorption	49
South American reservoirs	146
Southern Indian Reservoir	128
South-North	196
Spatial heterogeneity	47, 87, 89, 134
Speece cone	135, 140
Spill-water reactivation	156
Sport fishermen	73
Spreadsheets	113

Srinaquarind Dam	10, 84
Start of the pipe methods	18
State variables	175
Štěchovice Reservoir	34, 61
<i>Stephanodiscus</i>	121
Stochastic models	170
Stokes Law	49
Stormwater runoff prevention	160
Stratification	41, 47, 96, 97, 113, 147, 166
Stratification - effect of theoretical retention time	46
Stream order	31, 152
Streamside vegetation	133
Streptococci	119
Subsystems	37
<i>Synura</i>	121
Subsystem interactions	38, 88
Succession	87, 89
Sulphates	80, 95, 97, 119
Sulphides	97
Sulphur air pollution	128
Surface outflow	33
Surfactants	120
Suspended	
matter	113
inorganic matter	113
solids	95
Sustainability	92
Sustainable development	17
Sustainable management	15
Swedish lakes	80, 142
Swiss lake	147
Switching	175
Systematic scheme	107
Systems approach to monitoring	104
T	
Tapeworm	84
Teaching industrial managers and local community	19
Techniques for management of reservoir outflows	156
Temperature	43-45, 97
measurement	109, 179
profile	44
stratification	39, 46, 61-63
Temporal trends	113
Tennessee Valley Authority reservoir cascade	163
Tertiary treatment	127, 133
Theoretical retention time	32
Thermal structure	106
Thermistor	108, 109
Thermics	153
Thermocline	42, 43, 138
<i>Tilapia</i>	67, 68, 74, 93
Thorium	84
Tietê River	159, 186, 187
Timing of sampling	106-107
Top down effects	55, 87-88
Total dissolved solids	95, 154
Total organic carbon	95
Total phosphorus	113
Tourism and recreation	24
Toxic algae	56, 151
Toxic chemicals	77, 85
Toxic organics	77, 120
Toxicity tests	122
Toxins	85, 128, 160
Training	134
Transition zone	47, 49
Transparency	97, 113, 116, 158, 189
Trihalometanes	118
Trophic	
chain	54, 87, 88
classification	63
degree	152
state index	119
upsurge	57
Trummen Lake	142
Tucunaré	74, 93
Tucuruí Reservoir	9, 20
Turbidity	26, 31, 40, 43, 44, 64, 76, 81, 96, 97, 81, 115, 116, 129, 153
Types of wetlands	131
U	
Ukhtarma Reservoir	10
Uiboratana Reservoir	68
Underflow	47, 61
Underwater light regime	148
Untreated sewage	78
Upper Seine River	153
Upper Wainganga Reservoir	9
Upper Yarra Dam	156
Uptake	49
Upwelling	42
Uranium	84
Urban development	27
Urban reservoirs	160
Ust-Ilim Reservoir	9
V	
VanDorn water sampler	109
Variables of reservoir hydrology	30

Vegetation	40, 62, 127, 132, 133
<i>Vibrio</i>	57
Viral contamination	83
Viruses	56
Vltava Reservoir Cascade	163
Volta Reservoir	20, 68, 83
<i>Volvox</i>	110
Vltava River	183, 184
W	
W.A.C. Bennett Reservoir	9
Wahnbach Reservoir	10, 130
Wahnbach plant	125, 129, 130, 134
Warm monomictic	62
Water	
availability	14, 197
circulation	42
density	62
level fluctuations	95, 102, 179
level manipulation	150
pumps	157
quality changes during aging	57
quality criteria	60
quality definition	6
quality determination	104-106
quality evaluation	104
quality evaluation indices	114
quality management	13, 95, 168
quality variables	97
quantity	5, 101
quantity modeling	168
retention capacity	78
savings	133
storage	30
transfers and water withdrawals	28, 34, 36, 167
Waterborne diseases	76, 83
Watershed	18, 40
and inflow	37
management	125, 133
system	90
/waterbody area	39
Waterway construction and navigation.	27
Wetlands	26, 90, 102, 128, 191
destruction	27
management	131
purification capacity	131
WHO	95, 158
Willow Creek Reservoir	159
Winch	109
Wind shear	42
Winter fish kills	144
Wolfram	84
World Summit in Rio de Janeiro	17
X	
Xavantes Reservoir	10, 34
Xingó hydroelectric power plant	199
Xuanwu Reservoir	161
Y	
Yaciretá Reservoir	10
<i>Yersinia</i>	57
Yunoko Lake	176
Z	
Zeya Reservoir	9
Zink	84
Zooplankton	
	53, 56, 73, 82, 97, 98, 100, 101, 122, 137, 144, 154, 189, 191
feeders	56, 73
size structure	122