

Ecology Note

Towards a Clean, Green and Beautiful Capital City Phnom Penh City

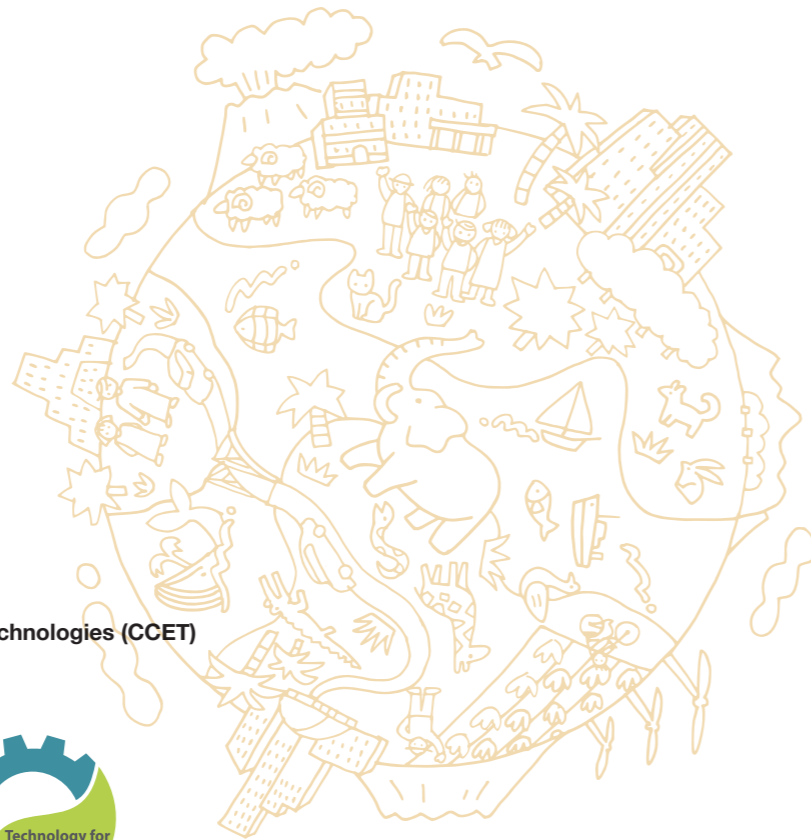

Contact Details

IGES Center Collaborating with UNEP on Environmental Technologies (CCET)

Institute for Global Environmental Strategies (IGES)
2108-11 Kamiyamaguchi, Hayama, Kanagawa 240-0115 JAPAN
Email: ccet-info@iges.or.jp Website: www.ccet.jp



In cooperation with:



Phnom Penh Capital Administration (PPCA)



Department of Education, Youth and Sports (DoEYS)



Cambodian Education and Waste Management Organization (COMPED)

Based on the original work Ecology Note of Mandalay.



City of Kitakyushu Environment Bureau Board of Education



Mandalay City Development Committee



Department of Basic Education, Ministry of Education

Copyright© 2019 Institute for Global Environmental Strategies.
All right reserved.

The contents of this publication are the opinions of the authors and do not reflect the views of IGES.



Introduction

Solid Waste Management (SWM) has become one of the most serious environmental and public health issues confronting cities in developing countries. Phnom Penh, the capital city of Cambodia is not an exception. Rapid urbanisation, economic growth and changes in lifestyles and consumption patterns have resulted in a remarkable increase of waste volume and diversity during the past few decades. According to the Phnom Penh Capital Administration (PPCA), annual waste generation has increased from 409,380 tonnes in 2012 to 808,530 tonnes in 2017. In addition, associated costs of SWM are also rising, related environmental degradation is occurring, and controversies are arising over the complete collection of waste, choice of treatment technologies, and location of new landfills. Aiming to overcome this fast growing issue, PPCA is planning to strengthen a sound solid waste management system integrating 3R practices (reduce, reuse and recycle).

In this new approach, promoting understanding on

waste issues as well as active participation of all stakeholders including school children, who are the next generation of decision-makers. This environmental learning booklet has been prepared based on the experiences of Kitakyushu City, one of the leading environmental model cities in Japan, to provide information, tools and guidelines emphasising reducing the amount of waste we produce; reusing, recycling whatever we can, before using landfills or other technologies to dispose of the rest in a more environmentally sound manner. The learning materials in this booklet also provide students with valuable lifelong skills, like critical thinking and encourages the students to be active citizens by making small changes in their everyday lives to make a difference in society. Furthermore, it gives ideas on how to incorporate waste management as environmental education into different subjects in the classrooms, including science, social studies, economic, art and maths and so on.

Table of Contents

• Introduction	2
• Making a Green Map for our Neighbourhood	4
• Let's Find Out the Present Solid Waste Management in Our City and the Challenge of the Throw-Away Society	
Our Lives and Waste	6
What Can We Do?	7
• Let's Promote Waste Separation and Recycling	8
Let's Learn How Waste Can Be Changed into Resources	10
• Let's Try Making Compost	12
How to Use Compost	14
How Compost Helps the Plants Grow	15
Ideas for Reducing Waste	16
• Let's Think About Global Warming and Climate Change	
Global Warming	18
Looking Back on Our Lives	20
• Lesson Plans	22



Landfill



River



Park and Waste bin



Phnom Penh Central Park

Making a Green Map for our Neighbourhood



Let's look around our neighbourhood

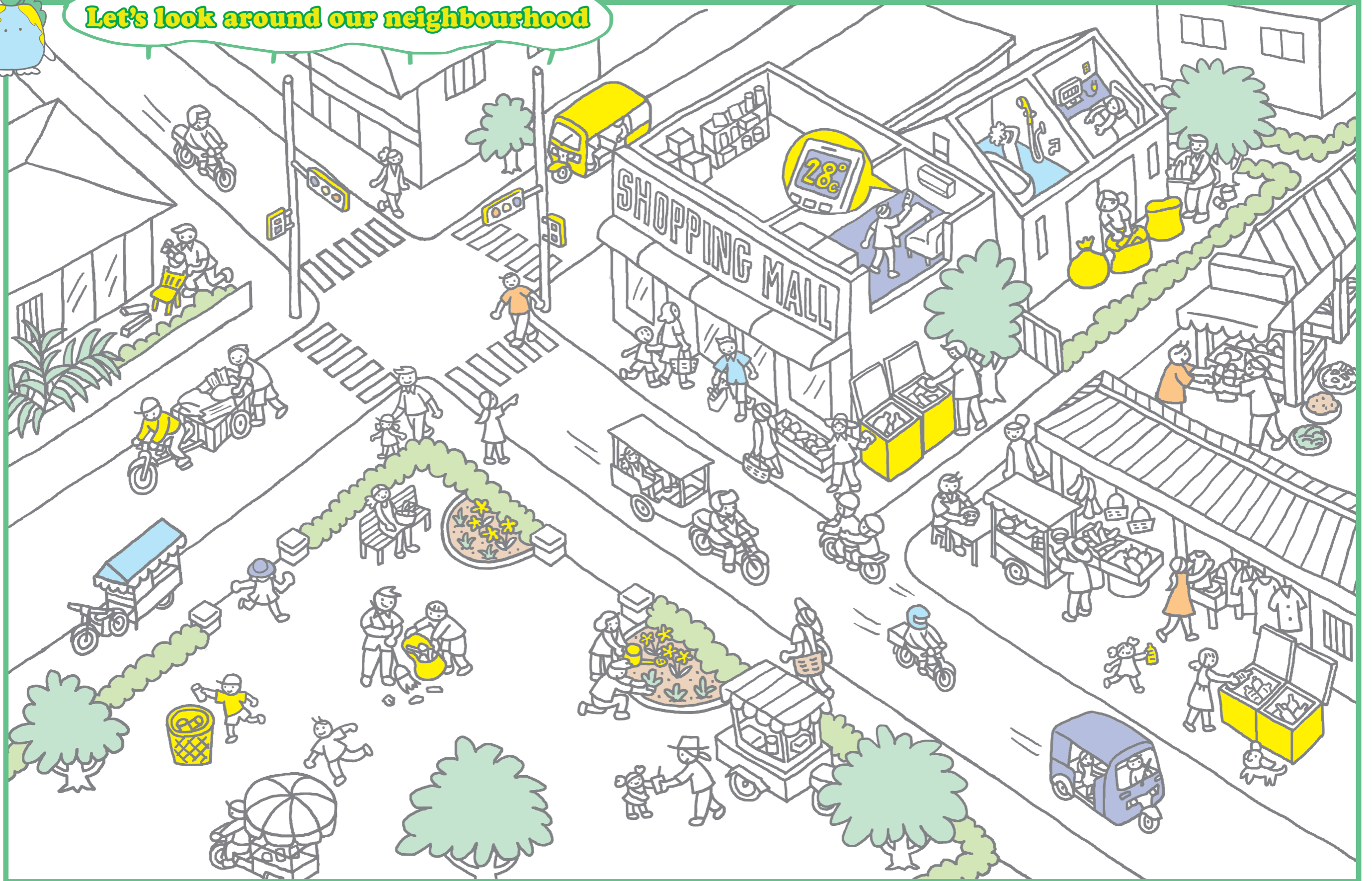

Let's Find Out the Present Solid in Our City and the Challenge of

Our lives and waste

How much waste is produced around us?



The amount of waste generated per day in the Phnom Penh City as a whole is about **2,700** tons.

This is the same as the total weight of **500** elephants!

1ton = 1,000kg

That much solid waste is generated in only one day. What do you think will happen if this situation continues?



Landfill sites will be filled with our waste.

(It is said that landfill sites in Mandalay City have already filled with waste and finding new sites is difficult due to lack of land.)



Resources on the earth may disappear.

(If we keep using oil, coal, and other resources, they will decrease fast.)

Learn More

In our society, many goods (things) are produced, used, and thrown away without being used for long time. Afterwards, they are usually collected and ends up in landfill. This type of society is sometimes called Throw-Away-Society. Every time we throw something away, we are throwing away the materials, energy, money and water that took to produce it. Find out where do your belongings come from? What kind of, and how much material it took to make them?

Waste Management the Throw-Away Society



What can we do?

Do you know about the 3Rs?

First Reduce
Reduce waste

Try not to generate waste, by using things with care as much as possible.

- Use your own shopping bag and "my bag" and try not to ask for supermarket plastic shopping bags.
- Ask for things you have bought to be wrapped as simply as possible.

Then Reuse
Use things repeatedly

Use things again and again by remaking or repairing them.

- Repair toys and clothes instead of throwing away.
- Give old clothing and toys to others when you don't need them.

Lastly Recycle
Turn waste into resources

Recycle waste into different things to use them again.

- Remake old newspaper and milk paper cartons into new newspaper and toilet paper.
- Make compost from kitchen waste in a compost treatment container.

Check your "eco" level

Tick the circles of what you are doing. How many circles can you tick?

- I eat meals without leaving anything behind.
- I separate PET bottles and cans.
- I give old clothing and toys to someone who wants them or use them differently without disposing of them.
- I use old newspaper for wrapping.
- I use my own bag and don't ask for plastic shopping bags.
- I turn off the TV when doing other things.
- I don't let the water run when washing my face or brushing my teeth.



Let's Promote Waste Separation and Recycling

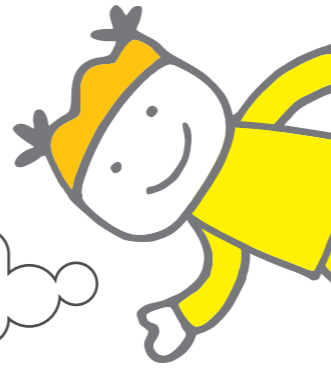

What will happen to the following materials will be changed after separation and recycling? Let's find and connect with a line.

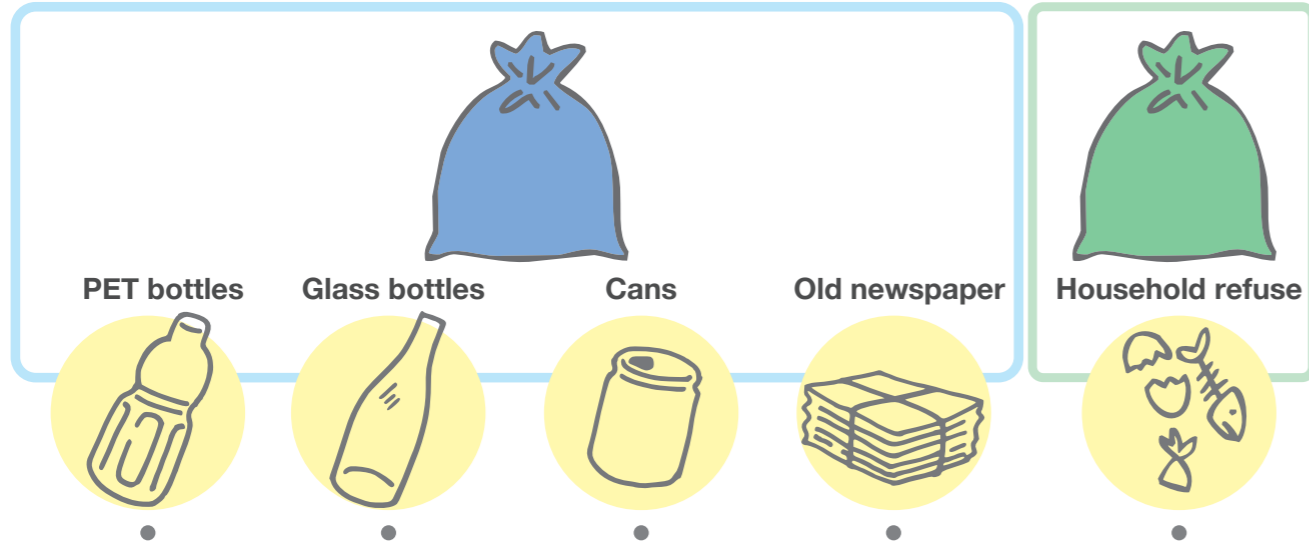

Let's start to separate waste at home with your family members.

Learn More

Our waste includes variety of things. The waste generated at households can be broadly divided into three categories:

- (i) recyclable materials (paper, plastic, glass bottles, can, etc),
- (ii) biodegradables (left-over vegetables and fruits, meat, rice, breads, fish...etc), and
- (iii) other types of waste.

Many cities often has separation rule for waste collection, so that same things can be collected, and later treated, together. Find out what kind of things are included in the waste at your home. What kind of rule does your area have?

Let's think about the waste flow and learn about what happens to the waste that we throw away.

Do you know who collects your waste?

Do you know where it goes after collection?

Do you know what happens in the end?

Let's challenge a quiz to find out how much you know about eco-friendly lives.

Please read the following sentences and mark if correct and if not correct in , and then connect with an appropriate tip on the right.

<input type="checkbox"/>	The more you use detergent, the more dirt and stains are cleaned.	<input type="radio"/>	We can use our used kitchen water for gardening rather throwing away.
<input type="checkbox"/>	It's better to use an iron by turning the switch on and off frequently.	<input type="radio"/>	Even if you use too much detergent, the way dirt or stains are cleaned is same. Please keep the proper usage amount.
<input type="checkbox"/>	If you use used water for gardening, they are not cleaned well.	<input type="radio"/>	You use a lot of electricity when turning the switch on and off.
<input type="checkbox"/>	It's better to wrap a gift for someone neatly in a layered manner.	<input type="radio"/>	If you buy because things are cheap, you may buy those that may not be used. So, buy only necessary things.
<input type="checkbox"/>	When things are on sale, you'd better also buy those things that you won't use soon.	<input type="radio"/>	Wrapping paper will become refuse after opening. So try not to increase refuse.
<input type="checkbox"/>	You'd better throw away clothes and toys after using.	<input type="radio"/>	Things made from paper can be used only once, and will become refuse after use.
<input type="checkbox"/>	It's better not to put on a lid when boiling water.	<input type="radio"/>	Try not to throw away used clothes and toys. You can give them to your family members or friends to use again.
<input type="checkbox"/>	It's good to use paper cups and paper plates rather use your own dishes.	<input type="radio"/>	You can heat water quicker if the lid is on, because heat is kept.
<input type="checkbox"/>	A piece of soap will be thrown away because It's not easy to use up.	<input type="radio"/>	Vegetables grown in organic fertiliser are the best.
<input type="checkbox"/>	Vegetables grown using chemical fertiliser are better because they look nice.	<input type="radio"/>	A small piece of soap can become large if it is joined with other small pieces.

Let's Learn How Waste Can Be Changed into Resources



Are you and your family separating waste at source?
Do you know what kinds of waste are converted into resources?
What is the right combination of waste and products made from the waste?

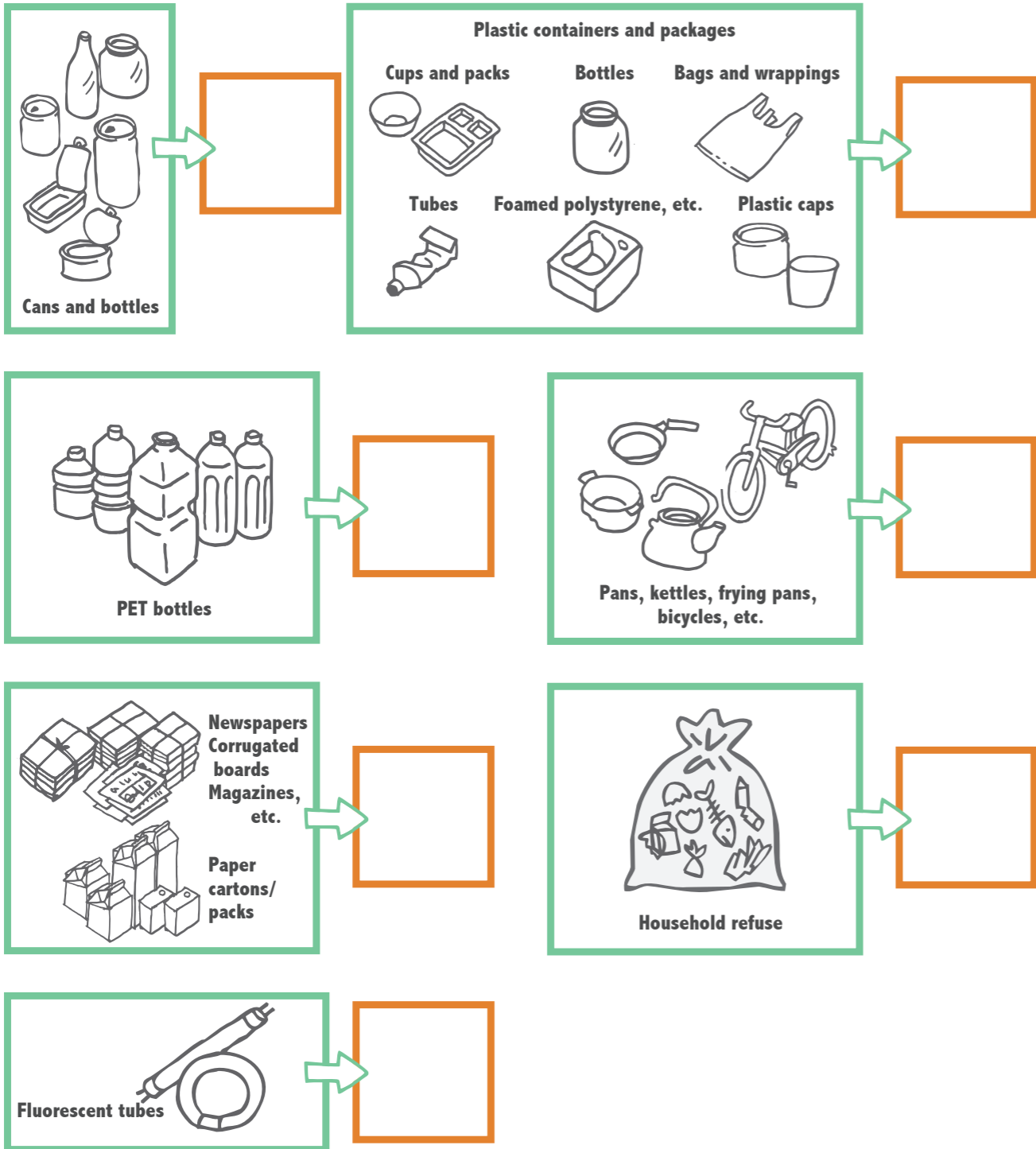

Recycled products

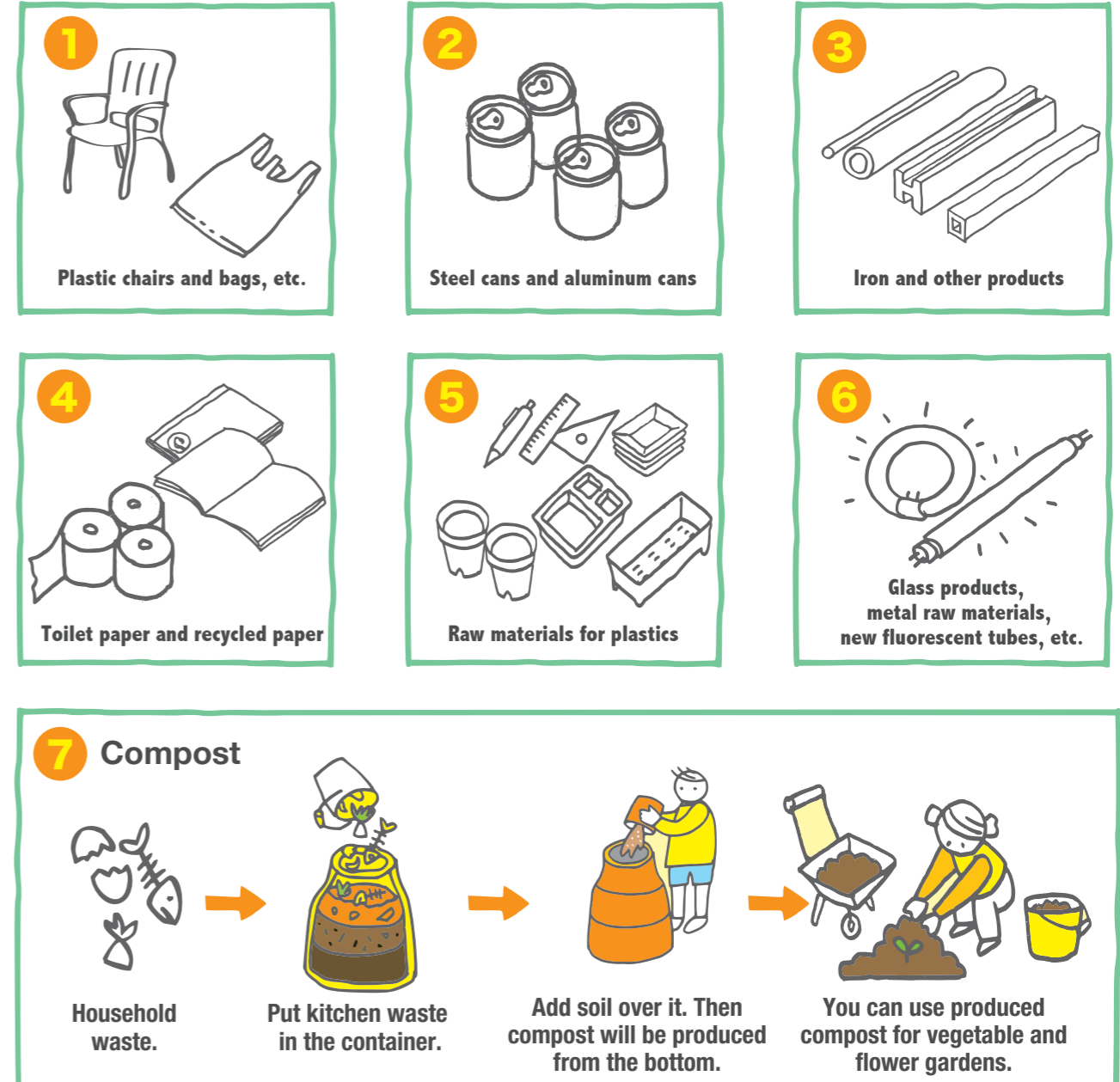

Learn More

There are different methods and companies to convert recyclable waste into resources. Find out what kind of recycling is in your city. What kind of recyclable waste do they collect, and what are they converted into? Find out what kind of other recycling methods are there in the world, which are not available in your city.

Let's Try Making Compost

Step 1 What You Need

Containers

★ Use an aerated container

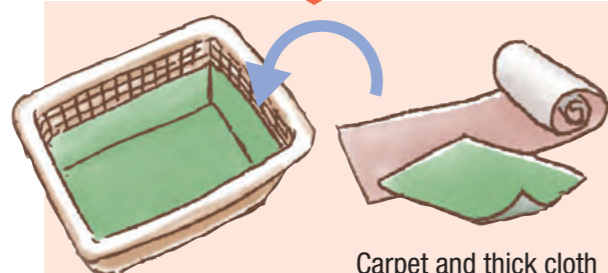
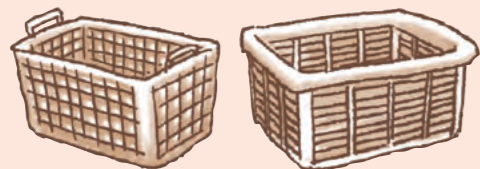

Carpet and thick cloth

Don't let insects get in!
Stop the inside getting wet!

Fermented liquid

★ Sugar

★ Water

★ Fermented foods

Yoghurt, Miso, Sake, Natto, Yeast, Kimchi, etc.



The More Fermented Foods the Better!



Put sugar, water and fermented foods into the container and mix together.

Step 2 Growing the Micro-organisms

Fill up a vinyl bag



Fermented liquid

Rice and rotten leaves soil

Squeeze into a ball shape, it's ok if there is water left in

★ Rotten Leaves Soil (15 litres)

★ Rice (2 cups)

Move all of the contents of the vinyl bag to the box. Mix it once a day. Do this for a week!



Learn More

Composting is a natural way of recycling organic waste, which turns organic materials into "compost". The insects, worms, bacteria and fungi all together help organic materials to turn into compost.

This process is called "decomposition". Find out what kind of small creatures are in the composting pile. You can do composting at your home by methods introduced here to speed up the decomposition.

Once preparations are finished, we can make the compost!

Step 3 Putting the organic waste into the box

Cut the organic waste into small pieces, put into the container and mix well.

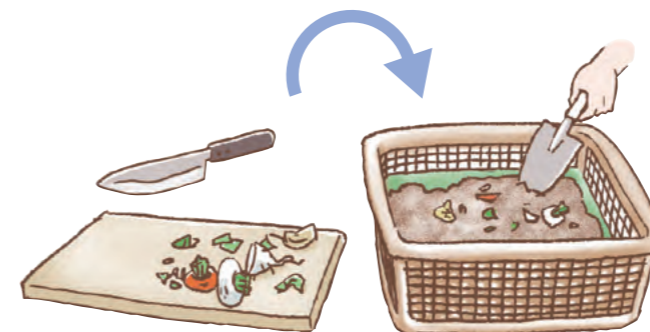

Mix it well once a day!

Make sure insects cannot get in

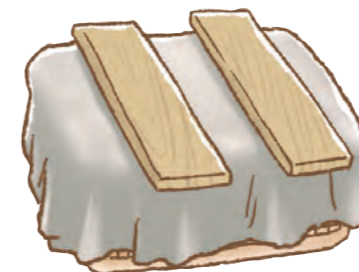

Put the cover over the basket



Step 4 Maturing the compost

Take compost out and keep it for maturing



By filling up half the box with compost and waiting 2 to 3 weeks, it can be used for flowers and vegetables.

Finished!



Wow!

※ In addition, if you keep the warm compost inside the plastic bag for several months, it will mature removing any unpleasant odours. Using it this way, vegetables and flowers can grow up healthily.

How to Use Compost

Compost is mixed with the soil

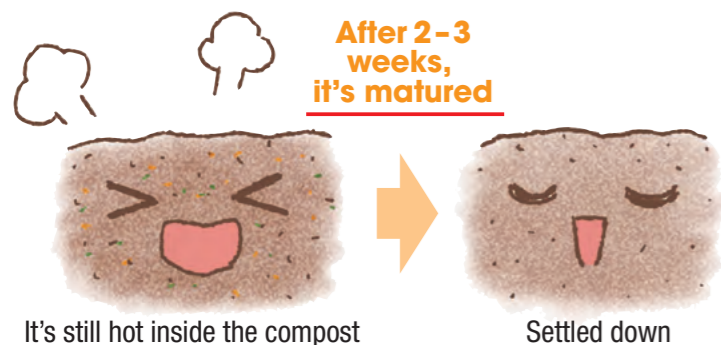

It takes 2-3 weeks for the compost to mature and be ready for planting.



Spread the compost on the whole area of a field, and plough it to a depth of about 10 cm.

※This method has the effect of improving the topsoil as well as softening the entire field.

When applying the compost in the planting area

Cover the soil with the compost after planting crops (Mulching).



Cut a 10cm deep circular furrow around the tree (ahead of its root tips) and put the compost in.

Approx. 10cm deep

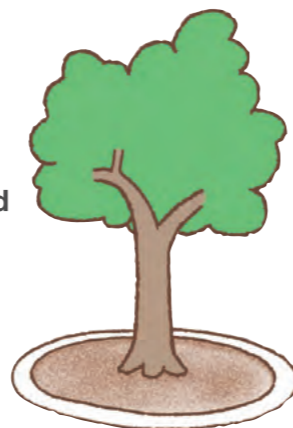

※The decomposition of the compost gets stimulated which gradually brings about the effect.



Learn More

Healthy soil makes for healthy plants and vegetables. Learn how you can grow healthy plants using compost made from organic waste.

What is the difference between the chemical fertiliser and composting? Ask experts or visit libraries to find out more about eco-friendly farming.

How Compost Helps the Plants Grow

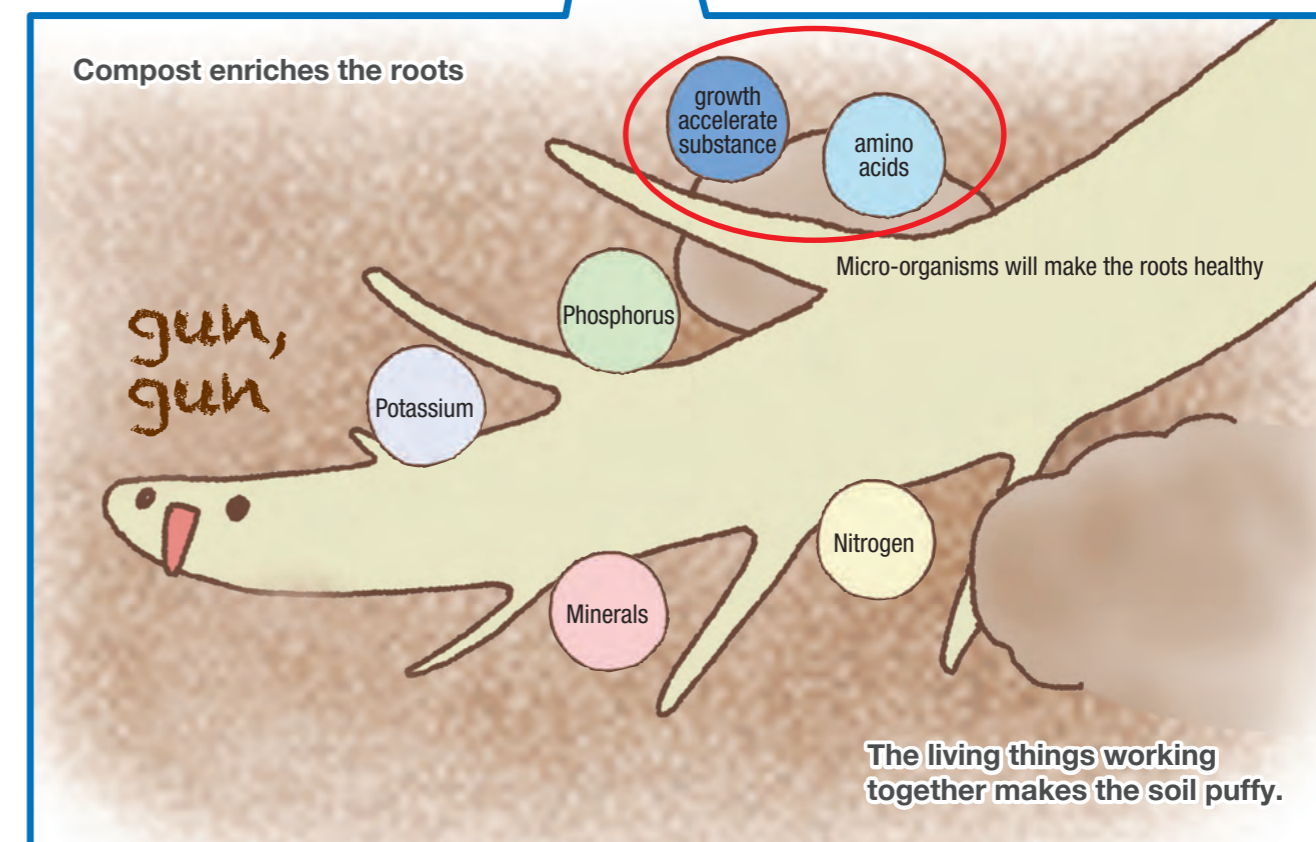
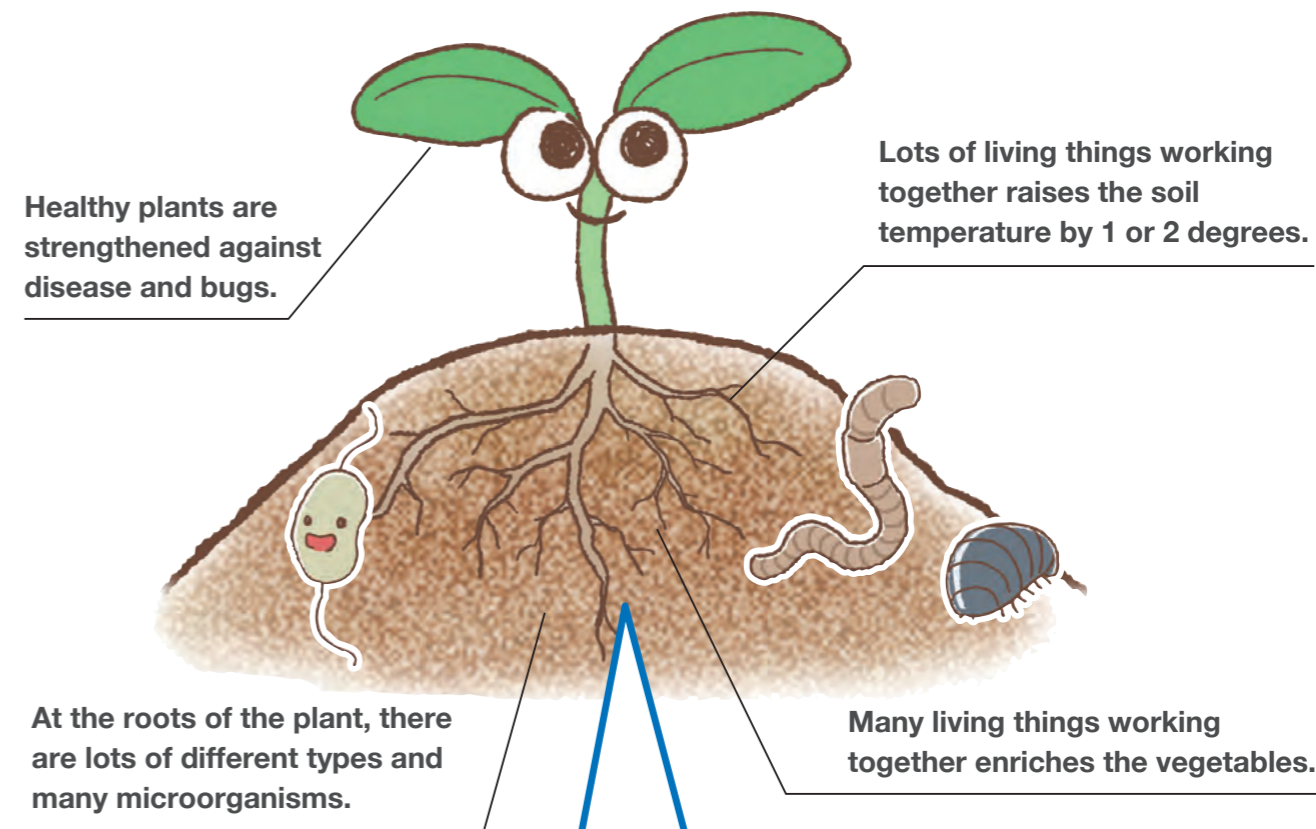

Ideas for reducing waste

You can still use them. Let's try to make new things from old materials.



Accessory case

Cut out and paste your favorite pictures/drawings to empty glass bottles.



Paint the bottles.

Use them as accessory case or flower vase.

Pen holder

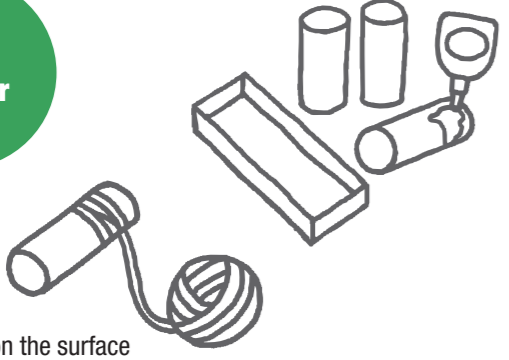

Apply glue on the surface of used toilet paper core. Decorate the core with colorful yarns.

Put the cores in a box, glue them to the base, and organize your stationaries.

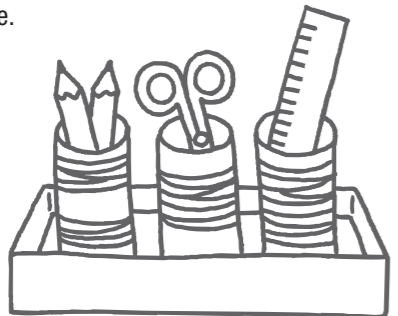

Plant pot of PET bottle

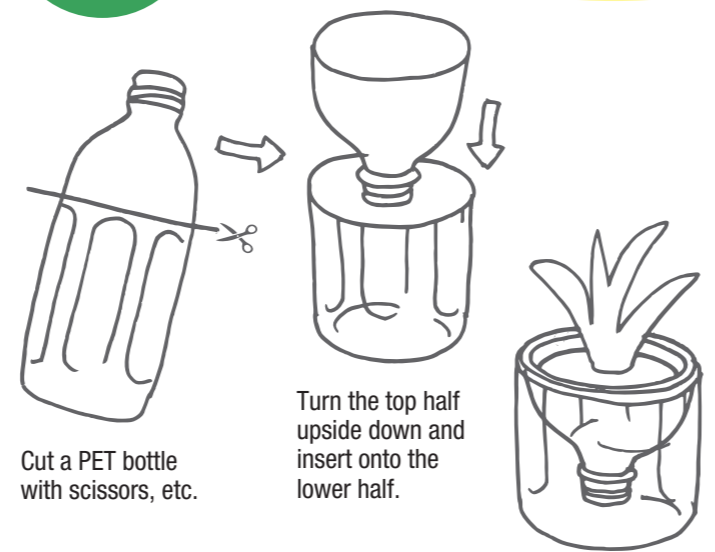

Cut a PET bottle with scissors, etc.

Turn the top half upside down and insert onto the lower half.

Water gun

Empty plastic container of mayonnaise or ketchup.

Make holes in the cap. Secure the cap with vinyl tape.

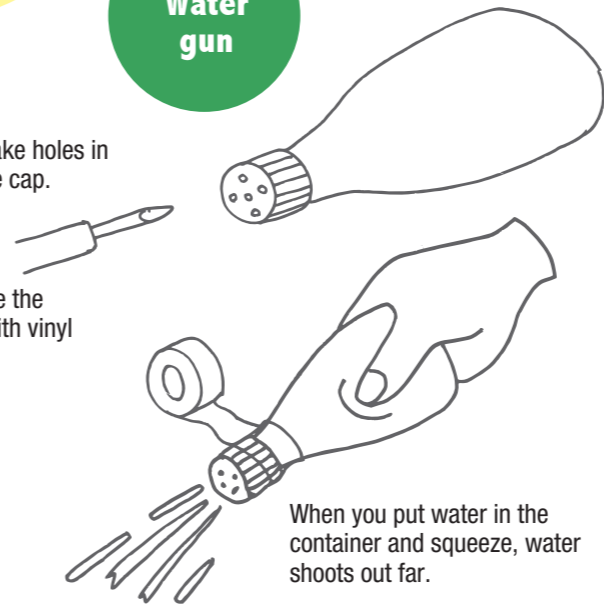

When you put water in the container and squeeze, water shoots out far.

Hand-basket

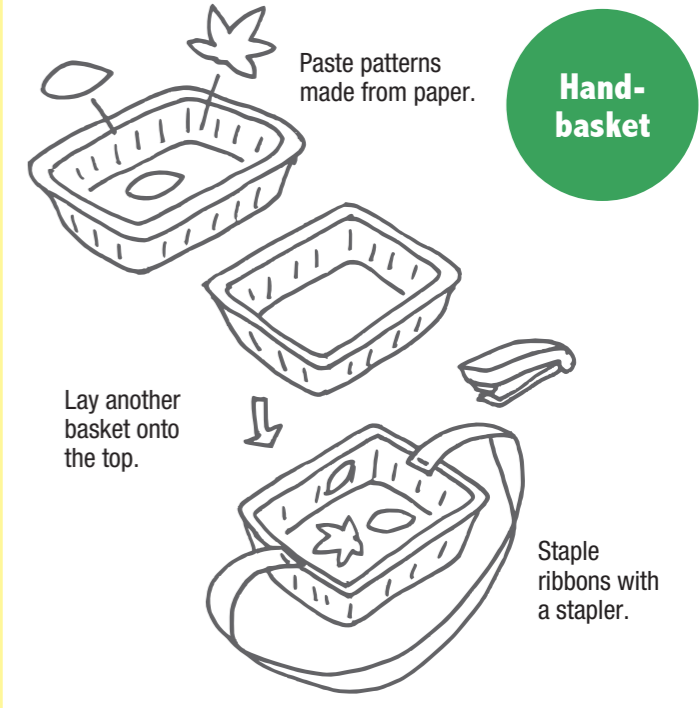

Paste patterns made from paper.

Lay another basket onto the top.

Staple ribbons with a stapler.

PET bottle sprinkler

Attach tapes around used PET bottles to make it durable.

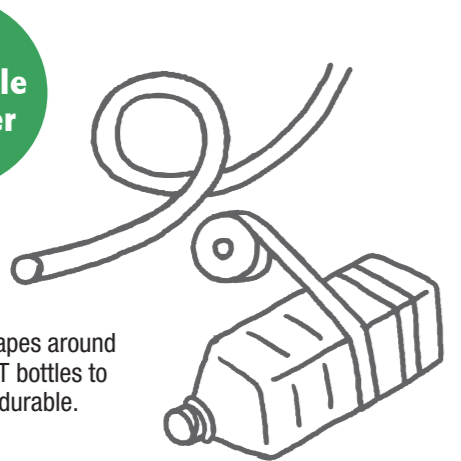

Connect a water hose on the top.

Make small holes on the tape.

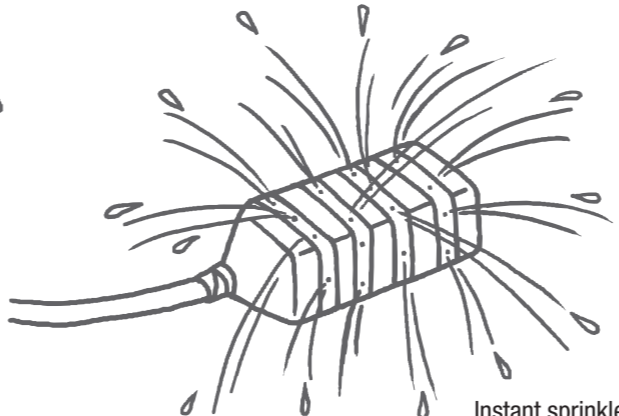
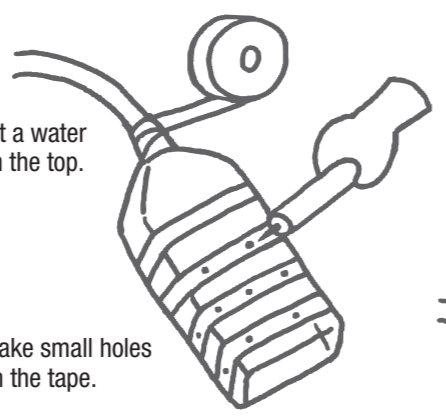

Instant sprinkler for watering plants or just for having fun.

When we reuse or recycle materials, it helps to reduce the amount of solid waste that we throw away. Be careful not to hurt yourself when cutting materials or making holes.



Let's Think About Global Warming and Climate Change

Global Warming

What is global warming?

The rise in the temperature worldwide is called "global warming." The cause of global warming is, simply put, the atmosphere surrounding the earth. The atmosphere wraps around the earth like a blanket. Thanks to the blanket, the earth catches heat given from sunlight and makes the temperature comfortable for our lives. But more isn't always better. Now, the blanket of atmosphere is getting too thick. The reason for the atmosphere getting too thick is that the gas warming the earth is increasing too much.

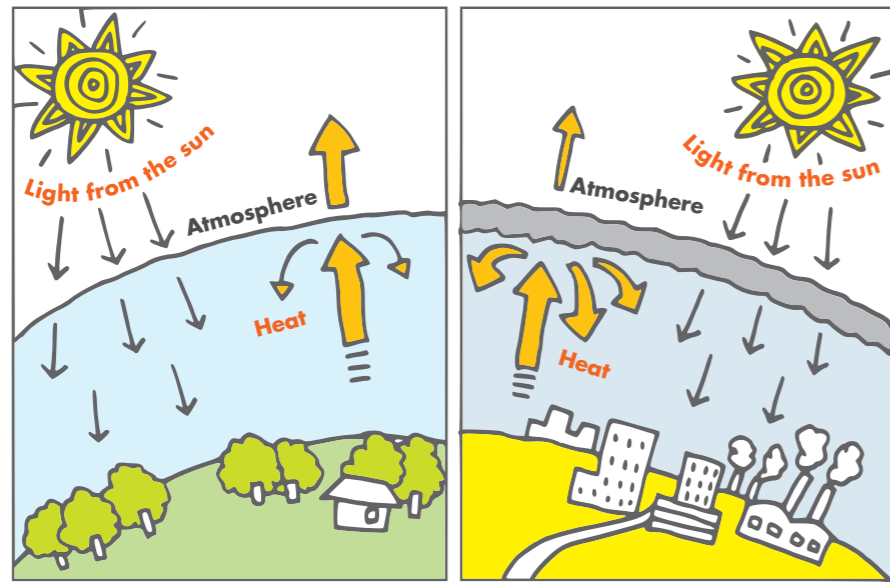

The earth maintains the proper temperature by wearing the blanket of the atmosphere (without the blanket of the atmosphere, the average temperature would become 19 degrees below zero).

Now the blanket of atmosphere becomes too thick, because the gas warming the earth has increased excessively. This causes global warming.

Looks like our daily lives are directly connected to this global environmental issue.



On what occasions is CO₂ emitted?

CO₂ (carbon dioxide) is emitted when we burn things and we exhale. What's more, we actually emit CO₂ in various ways in our lives.

We lead our lives by emitting CO₂ even when we generate electricity and heat and use them.

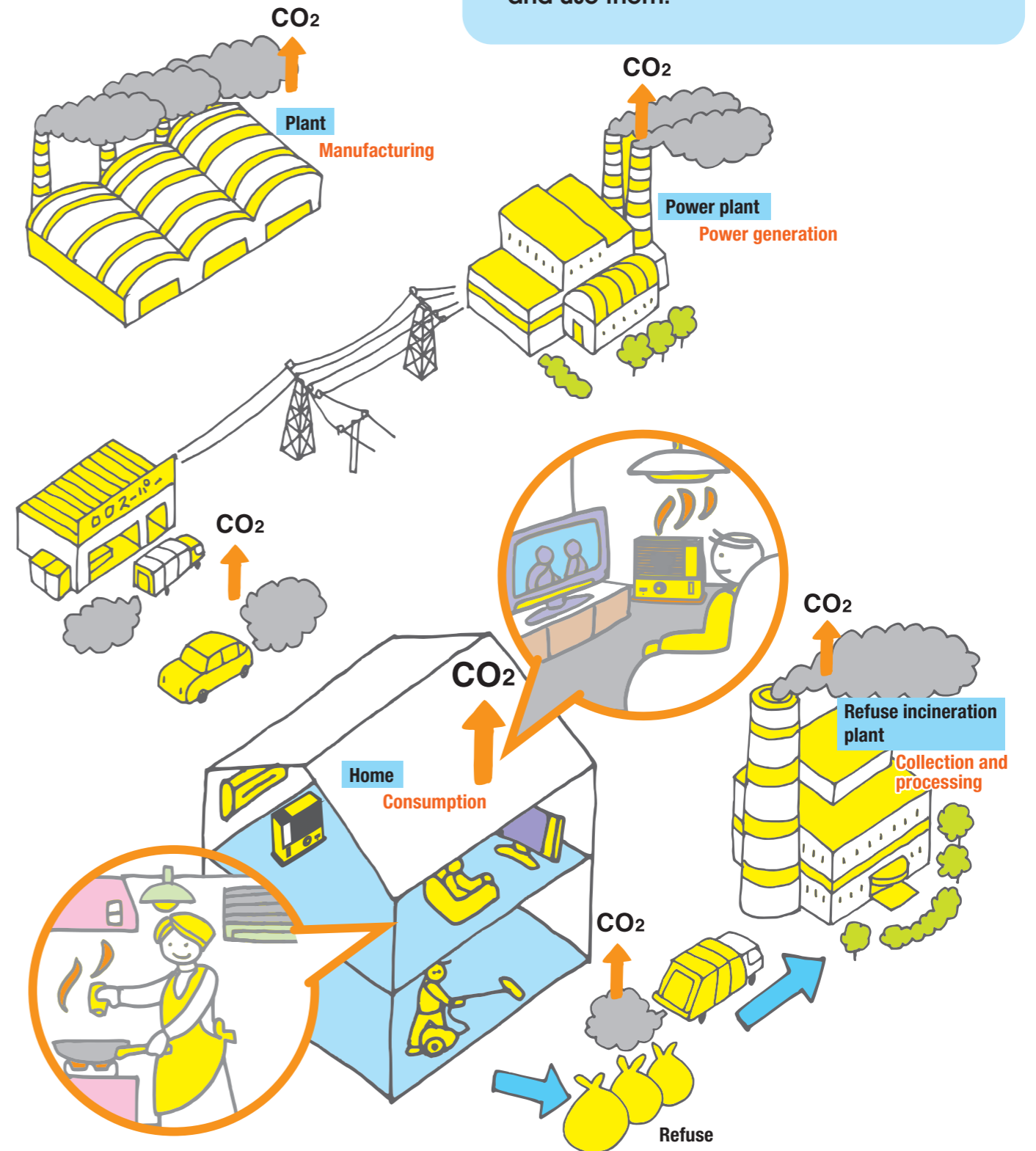

Looking Back on Our Lives

Mission: Let's reduce CO₂ by 1 kg per day per person!

In the "Until Today" column, please recall your everyday life until today, and mark a circle for the actions you are already doing.

In the "Challenge Days" column, write down the date you took the challenge and mark the circle on the item you challenged.

Eco check items	Mark the circle if you are trying to do it in your daily life. Also, mark the circle if you don't have an electric appliance mentioned in each item.	Until Today	The day you challenged		
			/	/	/
1	Turn off the TV when not watching.	80	80	80	80
2	Pull the TV or PC cord out of the wall before you go to bed.	20	20	20	20
3	Do not leave the air-conditioner or fan turned on.	60	60	60	60
4	Turn off the lights of the rooms not being used.	40	40	40	40
5	Try not to put too many things in the refrigerator and try not to overcool.	110	110	110	110
6	Put boiled water into the flask after you boiled water using an electronic pot.	110	110	110	110
7	Don't waste water when you shower.	80	80	80	80
8	Don't let water run when you wash your face or brush your teeth.	10	10	10	10
9	Bring your own bag and try not to ask for supermarket plastic shopping bags.	70	70	70	70
10	Sort out refuse in accordance with disposal rules of the City and reduce refuse.	30	30	30	30
11	Walk or use a bicycle instead of using an automobile when you go out or go to work.	170	170	170	170

If all items are marked with a circle, you can achieve CO₂ reduction by 780g per day per person!

Write down the total amount of CO₂ emissions circled.→

/780g /780g /780g /780g

* The values shown above are rough values.



How much CO₂ can you reduce from your daily life?

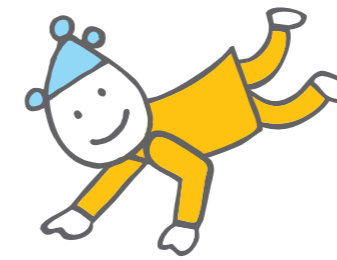

Think about the earth and ideas for reducing CO₂ in our lives

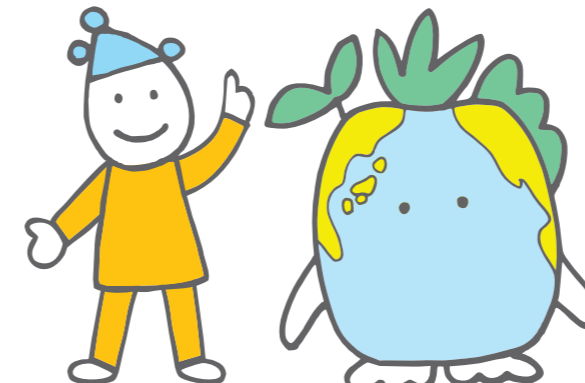

"Environmental issues, prevention of global warming, reduction of CO₂..... I do understand the global environment but the scale of issues are too large to see what I should begin with."
For such a person, the following are methods of global warming prevention you can do right now and the amount of CO₂ you can save per year.

Ideas in our lives CO₂ amount that can be saved per year

In the living room

■ Heating/cooling

- **Temperature** If cooling temperature is raised by one degree (28 degrees) and warming temperature is lowered by one degree(20 degrees) **CO₂ 29.2kg**
- If an air filter is cleaned once or twice per month **CO₂ 11.2kg**

■ Energy-saving lighting

- If lights are replaced with compact fluorescent lights **CO₂ 29.4kg**

■ TV

- If the use is reduced by one hour per day 25-inch CRT **CO₂ 5.9kg**
- If TV screen brightness is adjusted to optimum 20-inch LCD **CO₂ 19.8kg**
- 32-inch plasma **CO₂ 9.5kg**
- 5-inch CRT **CO₂ 53.2kg**

■ PC

- If the use is reduced by one hour per day Desktop **CO₂ 11.0kg**
- Laptop **CO₂ 1.9kg**

In the bathroom

■ Water heater (reheating feature)

- Taking a bath without intervals **CO₂ 87.0kg**

■ Shower

- Not letting water run unnecessarily **CO₂ 29.1kg**

In washing

■ Washing machine

- Washing clothing collectively **CO₂ 2.1kg**
Reducing washing frequencies based on the machine capacity

In the kitchen

■ Electric refrigerator

- Adjust to the optimum temperature **CO₂ 21.6kg**
If the temperature is adjusted from high to low
- Install behind the wall by allowing appropriate space **CO₂ 15.8kg**

■ Dishwasher-dryer

- Wash dishes collectively when the machine is used **CO₂ 37.6kg**
If dish washing is changed from manual washing to machine washing

■ Microwave oven

- Use microwave oven for preparing vegetables **CO₂ 15.4kg**

Teacher's Guide

About Ecology Note

Ecology Note – Towards Clean and Beautiful Cambodia – is a supplementary material for primary school teachers who wish to introduce environmental education for the first time, or for those who want to enhance the scope of educational work in addition to what is already taught in the classrooms.

The scope of environmental education is wide, including various environmental issues from climate change, bio-diversity, pollution of air, land, water, sustainable management of waste and finite resources including those exhaustible and renewable. In this note, waste/resource management and climate change issues are given special attention as environmental issues most close to students and most pressing to Phnom Penh Capital City. It is recommended that the schools and teachers would gradually expand the range of topics to be treated in the school curriculum in the future.

Also, for Ecology Note to better serve students and teachers, it is crucial that the tool is well positioned in a wider curriculum design with clear goals/direction, specific skills students are expected to learn, approaches and pedagogies employed, and annual teaching schedule...etc.

Designing an Effective Class for Effective Learning

In order to allow teachers to tailor their classroom activities to suite their needs, any component of this booklet can be photocopied and distributed in the classroom as handouts.

The underlining concept behind Ecology Note is education through active learning – an approach that values spontaneous interests of students as the foundation of learning. Going beyond a passive learning such as a unidirectional lecture primarily focusing on providing information to students, it also employs experiential learning where learning is guided by discovery from experience and reflecting on the experience. Field works, group discussions, report writing, and presentation are some of the examples of methods in this tool which encourage students to develop the skill to observe, analyze, organize, and communicate the acquired information to others.

The Ecology Note also encourage teachers to connect the educational resources around the school, teachers and students to the classroom education based on lecture. Using locally available resources and engaging experts and practitioners in the local community is an effective way to enhance students learning through social interaction. For instance, inviting waste management experts to your classroom as guest lecturers, or visiting recycling companies as a educational field trip would help enhance student's understanding on subject matters, going beyond what they have learnt in their classroom. Schools can also consider university professors, officers of local administrations, farmers, companies and community groups as resource persons to support their lecture.

Lesson 1 Making a Green Map for your Neighbourhood (2 class period)

Aim:

This exercise is intended to give students a better understanding of the community resources for preserving natural environment, through exploring their own city with fresh eyes. The activity can also help students to develop the ability to organize, analyze, and communicate the discovered information to others.

Required materials:

Map of the neighborhood (a small area around the school), drawing papers, pencils, camera (if possible).

Procedure:

1. Divide students into groups (maximum 5) / Ask them to walk their neighbourhood with the map and identify the eco resources (dustbins, recycling shops, bike lanes), people (farmers, waste collectors) and places (agriculture land, greenspace) along with cultural sites that make their neighbourhood a special place / Ask them to take notes, sketch or photo these places.
2. In the class room, they draw a map of the area / Different groups can present their maps to other

groups and discuss what they have found and their importance.

Follow-up:

Display the map on a bulletin board or similar. Write a report about their neighbourhood using these information. During/after the discussion, it is important to highlight what community resources/actions (and which aspect) are considered supportive to environmental protection.

Relevant subject areas:

Social Studies, Science, Art, Agriculture

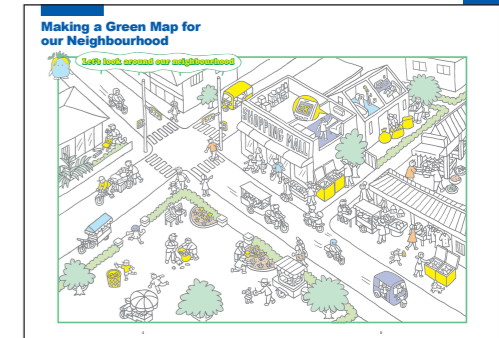

Lesson 2 Let's think about Waste Management Issues in your Neighbourhood (2 class period)

Aim:

This section encourages students to become aware of the basic facts about waste problems of the city, and the direct linkage between their daily lives, and to think about the environmental consequences of lifestyle. Highlighting the connection between environmental problems and student's personal life is one of the first steps to nurture the sense of responsibility, attitudes, and behavior for environmental protection.

Required materials:

Papers and pencils

Procedure:

1. Ask students to think about how much garbage they, their family and city produce daily, weekly, monthly or annually. (Average daily waste generation in Phnom Penh City is: (i) 640 grams per person (ii) 975 tonnes or 975,000 kilogrammes in the city as a whole).
2. Discuss what happens to our environment if we keep continuing throwing garbage using simple questions such as : if you throw one piece of paper on the ground of your classroom, would that make a big difference? Suppose everyone in the

classroom does this at once, what would it look like then? How about if you do this once a week or once a month? Why?

3. Students can be shown waste collection points in their neighbourhood or the final disposal site to show them the real situation and discuss the negative effects garbage has on their neighbourhood.

Follow-up:

Produce a bulletin board or display the results of the information from the questions / Write a report or fact sheet using this information. Take it home and share with the family.

Subject areas:

Social Studies, Science, Maths

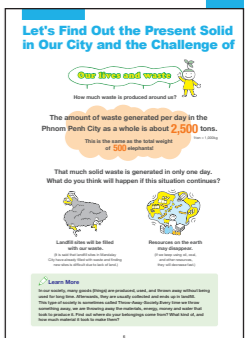

Lesson 3 Let's Discuss What Students Can Do to Reduce Waste (1 class period)

Aim:

This exercise encourages students to understand the importance of lifestyle based on 3Rs – a life style without just throwing things away - in order to reduce waste and conserve resource use.

Required materials:

Papers and pencils

Procedure:

1. Ask students to think about variety of household items that are thrown into the garbage. Discuss which of the items can be reduced, used again (reuse) or recycled.
2. Motivate students to take simple individual actions using a check list of eco-actions and discuss how these simple actions can protect our environment.

Follow-up:

Develop a checklist to motivate students to take

eco-actions at schools, homes and neighbourhoods. Ask them to present what activities they have taken. Produce a bulletin board or display the results, or organize them into a report/fact sheet.

Subject areas:

Social Studies, Science, Maths



Lesson 4 Educate Students About Waste Separation at Source (1 class period)

Aim:

Through this exercise students will learn the different categories of waste produced in their daily lives as well as the disposal methods.

Required materials:

A sample of waste collected from households or classroom

Procedure:

1. Collect samples of waste which accumulate in the classroom after one day or ask the students to bring from their houses.
2. Take 3 boxes and place them at the end of the room and ask the students to label them as recyclable, biodegradable or left-over for disposal.
3. Setup two teams and let them sort the garbage by taking one item at a time and placing it in a container.
4. After the students have sorted the garbage, go through the bins and ask why items were placed in certain boxes. Some items may appropriately fit into more than one box. The answers are not always clear, depending on options available in your community. This can also be done on paper

by drawing lines between the items and the containers on a handout called "Where Does This Trash Belong?"

Follow-up:

Discuss the idea of waste segregation and reduction. Ask (i) what items are not needed in the first place (ii) if durable products could be used rather than disposal ones (iii) if products with less packaging could be purchased. Encourage students to find out the segregation rules in their own residential area.

Subject areas:

Science, Social Studies

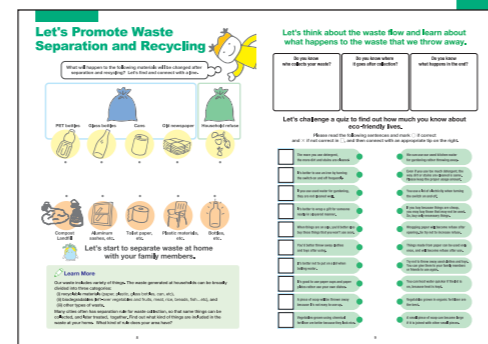

Lesson 5 Let's Understand What Happens After Collection (2 class period)

Aim:

To learn about different recycling methods and industries in Phnom Penh City. Students can also find out how their waste can still be used as a resource for producing various products.

Required materials:

Map of town/city, paper, pencil, waste management facilities (landfill site, incineration plant, recycling facility, composting center...etc.)

Procedure:

1. Identify all the waste disposal options in your community. List up and mark them on a map.
2. Decide where various types of garbage can go. Each item may have several options.
3. Find out what recycling and composting options are available in your community.

Follow-up:

Further discussions can be facilitated by asking

questions such as: "Are there any other options that would be desirable to manage your garbage? If so, make a list of recommendations". Students can also use the information gather to write a report on waste disposal or create a bulletin board or exhibit.

Subject areas:

Social Studies, Home Economics, Maths

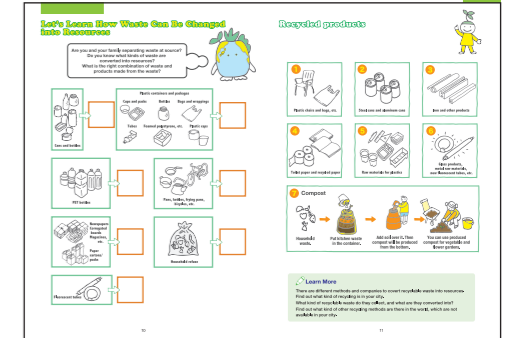

Lesson 6 Learn How to Make Compost from Bio-Waste (multiple class period)

Aim:

This exercise is aimed at advancing understanding on the basic steps of composting, and its mechanism through an experiential learning.

Required materials:

Fresh sample of kitchen waste, cardboard box (if you want to make it in a box) or safe location, glass slide or petri dish, hand lens or microscope, paper, pencil

Procedure:

1. Place kitchen or yard waste into the composting bin. Chop or shred the organic materials if you want them to compost quickly.
2. Spread seed compost or soil or pre-made compost over the compost pile. This contains the microorganisms and soil animals that do the work of making compost.
3. Adjust the moisture in your compost pile. Add dry straw or sawdust to soggy materials or add water to a pile that is too dry. The compost should be damp to touch, but not so wet that drops come out when you squeeze it.
4. Allow the pile to ferment. It should heat up quickly and reach the desired temperature of 90f to 140f or 32c to 60c in four to five days. Stir your compost as it ferments by turning it with a pitch fork or shovel if you want to speed up the process. If you mix or turn your pile every week, it should be ready to use in one to two months.
5. Your compost should look like dark crumbly soil mixed with small pieces of organic materials. it should have a sweet and earthy smell. The insects (worms, bacteria, fungi) found in your compost pile do the work of making compost. If you don't see live organisms, take a fresh sample from the compost and check with a hand lens or microscope.

Follow-up:

Develop a checklist to motivate students to take eco-actions at schools, homes and neighbourhoods. Ask them to present what activities they have taken. Produce a bulletin board or display the results, or organize them into a report/fact sheet.

Relevant subject areas:

Social Studies, Science, Maths

