



UNEP

REGIONAL SEAS

H.T. Odum:

Energy, environment and public policy

A guide to the analysis of systems

UNEP Regional Seas Reports and Studies No. 95

ENERGY, ENVIRONMENT AND PUBLIC POLICY

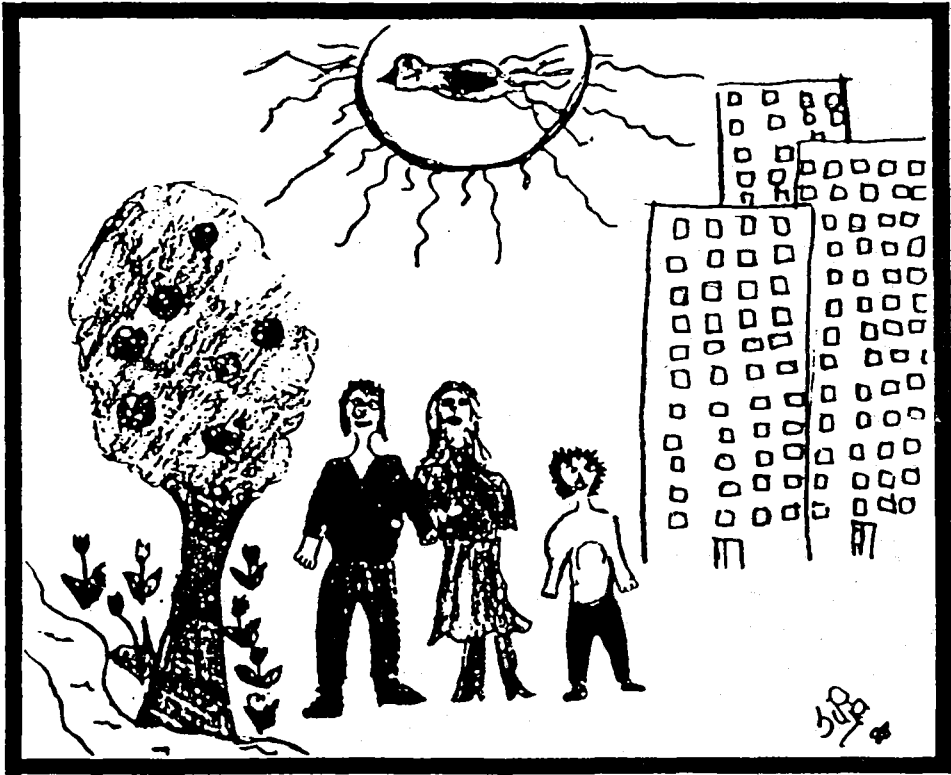

TABLE OF CONTENTS

PART I. PRINCIPLES AND SYMBOLIC LANGUAGE	3
I. SYSTEMS AND SYMBOLS	3
2. THE FLOWS OF ENERGY AND MATERIALS THROUGH ECOSYSTEMS	7
3. THE FOOD WEB OF AN ECOSYSTEM	10
4. TROPHIC LEVELS AND THE QUALITY OF ENERGY	12
5. PRODUCTION AND THE MAXIMUM POWER PRINCIPLE	15
6. GROWTH MODELS	17
7. MORE GROWTH MODELS	18
8. SIMULATING QUANTITATIVE MODELS	20
9. OSCILLATING SYSTEMS	25
PART II. BIOMES	28
10. THE OCEAN	29
11. ESTUARIES	38
12. PONDS AND STREAMS	41
13. WETLANDS	44
14. COLD BIOMES	46
15. TEMPERATE FOREST BIOMES	47
16. GRASSLANDS AND DESERT BIOMES	50
17. TROPICAL BIOMES	52
18. AGRICULTURAL SYSTEMS	53
19. FOREST PLANTATIONS	56
20. URBAN SYSTEMS	58
PART III. THE ECONOMIC SYSTEM	62
21. EARLY TRIBAL CULTURES	62
22. ENVIRONMENTAL BASIS FOR A NATIONAL ECONOMY	64
23. ENERGY AND NATIONAL ECONOMICS	74
24. ECONOMIC IMPACT ON ENVIRONMENT	78
25. FUELS AND ELECTRICITY	80
26. ALTERNATE SOURCES OF ENERGY	83
27. SIMULATING THE FUTURE	88
28. POPULATION AND CARRYING CAPACITY	91
29. INTERNATIONAL EXCHANGE AND SYMBIOSIS	92
30. A LOWER ENERGY WORLD	95
APPENDIX	97
GLOSSARY	108

Note: A disk of the computer programs presented in the text can be obtained from H.T. Odum at the Ecological Economics Program, Phelps Laboratory, University of Florida, Gainesville, Florida 32611 (USA)
A plastic template for drawing energy symbols is available from the same address.

INTRODUCTION

Even in landscapes that are dramatically altered to accommodate our agriculture, industry, housing and transportation needs, nature is constantly at work providing the energy and raw materials necessary to keep human systems operating smoothly. In coastal areas, natural processes such as sunlight, the tides, and chemical flows of nutrients and pollutants carried by freshwater sources help determine fishery yields, to name just one example. The human economy in a coastal zone clearly depends on natural processes as well as on our own actions.

It is when we overlook the importance of nature's role that conflicts arise, and these conflicts generally spring from differences in our assessment of the value of natural resources. What is the real value of a salt marsh or a swamp? How can we evaluate the difference between a river which flows freely to the sea and one that has been straightened and deepened? How much are rain, wind, waves, and tides worth to the economy?

Ask such questions of a developer, a naturalist, a farmer and a poet, and you would no doubt get widely varying answers. Economists can put dollar estimations on the market value of resources, but are these the true economic values? Naturalists can explain the biological importance of a species or an ecosystem. But how can we bring this information to bear on our public policy choices about the use of the environment?

Systems analysis seeks to develop a package of the basic principles that govern the workings of natural and human systems. These are then used to analyze the structure of systems and to predict their performance under different conditions.

Through the application of the principles of systems analysis, we will attempt in this booklet to

generate a view of the world as one complete system containing many subsystems. The systems approach will demonstrate that economic and environmental problems can be evaluated according to a common measure: the eMergy generated by the system. It will show how to put monetary values on resources, including sunlight, the most abundant of all. Conversely, we will be able to express cash flows in an even more basic form: their solar energy equivalents.

The text also provides an easy introduction to an energy symbol language which helps the mind visualize problems and solutions. The diagrams help non-mathematicians to understand how environmental systems work, their relationship to the general economy and the role of human beings in their control.

Such an endeavour should provide us not only with the opportunity to better understand our planet and our role in its life, but the possibility of making sound decisions which will ensure the best possible future. This approach has already proved extraordinarily accurate in predicting recent world trends.

Section I of this booklet introduces the basic principles and language we apply to our study of the energy systems which power our planet. Section II applies systems analysis language to the study of ecosystems -- both "natural," unmodified systems and those which have been modified by human activities. Section III then applies the same analytical techniques to human economic systems in an effort to identify key problem areas and to explore remedial strategies. Since systems modelling really comes alive when a computer is used, the text includes an introduction to the use of the microcomputer as an optional aid to systems modelling.

PART I. PRINCIPLES AND SYMBOLIC LANGUAGE

In order to communicate with one another about systems, we need a common vocabulary and an understanding of certain fundamental ecological principles. Part I introduces the methodology and language used by scientists attempting to organize our knowledge of the world's systems, and describes several of the concepts and theories which form the basis of modern systems ecology.

I. SYSTEMS AND SYMBOLS

Systems

A system is a group of parts which are connected and work together. The earth is covered with living and non-living things that interact to form systems. Systems with living and non-living parts are called ecosystems (which is short for ecological systems).

A typical ecosystem contains living things like trees and non-living things like nutrient substances and the weather.

The surface part of the earth where living things exist is called the biosphere. It contains many smaller ecosystems. Examples are forests, fields, ponds, estuaries, etc.

All the individuals of one species of organism in an ecosystem are a population. Every ecosystem contains many different populations. For example, an ecosystem may contain a population of oak trees, a population of squirrels, a population of grasshoppers, etc.

The living parts of the ecosystem are called a community. The community is made up of the populations of many species. The populations interact with each other.

Ecosystem Processes

Some of the organisms make their own food from chemicals using the energy of sunlight. This manufacturing process is photosynthesis. The plants that make the food products are called producers. The food produced is used by living cells to make more cells and to form organic

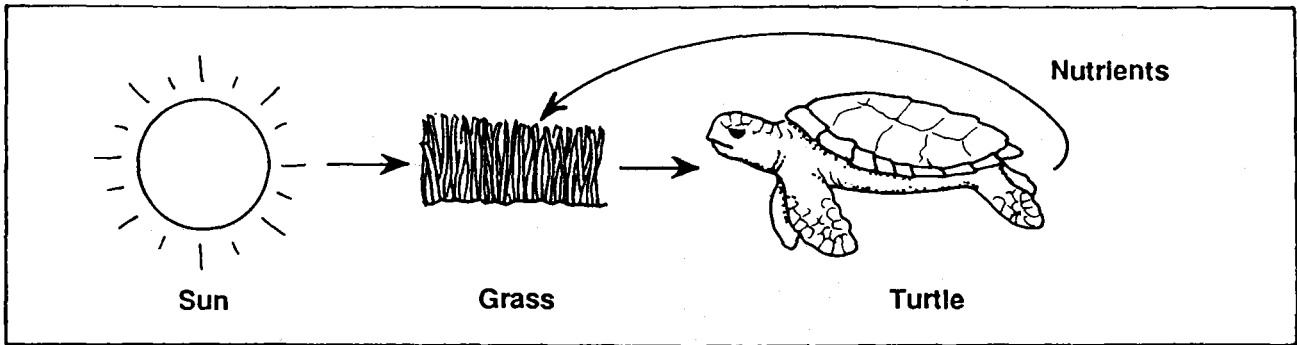

Figure 1.1. Parts of a shallow marine ecosystem.

matter such as wood and fats. The organic products of living organisms are called **biomass**.

Some organisms consume products made by producers. These organisms are called **consumers**. Consumers can be plant eaters (**herbivores**), meat eaters (**carnivores**), or digesters of dead organic matter (**decomposers**). Cows and grasshoppers are herbivores; coyotes and spiders are carnivores; and fungi and bacteria are decomposers.

After a consumer has digested and used its food, a few chemical waste products remain. Those waste products that are needed as fertilizer for plant growth are called **nutrients**. When nutrients are released by consumers and go back for reuse by the plants, we say that the nutrients have been **recycled**.

The shallow marine ecosystem is a typical example. Its plant producers use the sun's energy and nutrient chemicals to make organic products. These are eaten by the consumers which release nutrients back to the plant roots. Figure 1.1 shows these parts of a marine system, and the arrows show the way energy, food, and nutrients are flowing.

Symbols

The symbols used in this book are simple graphic representations of system components -- the "words" of our systems language. A familiarity with the symbols and their use can help us a great deal when thinking about how systems operate. The first groups of symbols which need to be learned are given in Figure 1.2.

Figure 1.3 shows a marine system drawn with these symbols. The units and pathways are the same as in Figure 1.1 except symbols were substituted for the pictures of plants, turtle, etc. The sun is represented by the symbol for energy source; the green plants are represented by the symbol for producer; and the animals are represented by the symbol for consumers. The arrows represent the passage of energy from one unit to the next. Many pathways carry materials and energy. A diagram which shows important relationships in a simple way is a **model**.

Two more symbols are given in Figure 1.4. An interaction process is represented in energy systems diagrams by an **interaction symbol**. For example, the interaction of energy and materials in photosynthesis is shown by the interaction symbol. A quantity is represented by the storage

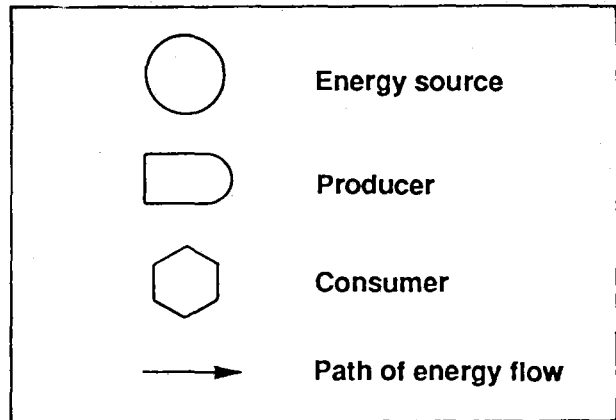

Figures 1.2. Symbols used for parts of an ecosystem.

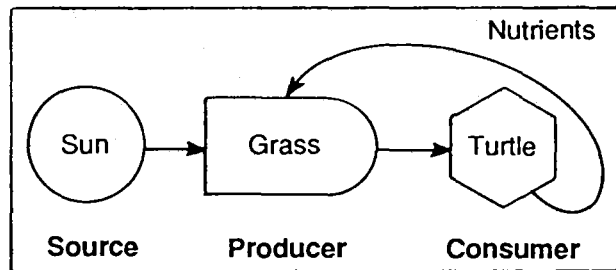

Figure 1.3. Use of symbols to represent parts of the marine ecosystem.

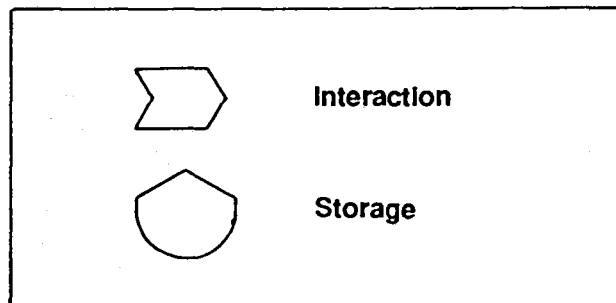

Figure 1.4. Interaction and storage symbols.

symbol in Figure 1.4. For example, a storage of nutrients may be indicated by the storage symbol.

The parts and pathways within a producer and a consumer are given in Figure 1.5. Within the producer the photosynthetic process is shown as an interaction that combines nutrients and energy. Production also requires a quantity of plants (storage of plant biomass) to do the work of photosynthesis. A consumer also has an interaction process and storage. In our example of the turtle the interaction process is the eating of

green plants. The storage is the biomass of turtle tissue. The parts and pathways within a consumer are similar to those within a producer.

In Figure 1.5 there are lines flowing from the storages back to the interaction processes. This indicates that the store of biomass is involved in producing more biomass. A line going back to the left is called a feedback.

Energy is available to do work only when it is relatively concentrated. Energy is said to be dispersed when it spreads out losing its concentration and ability to do useful work. Some energy is always being dispersed from a storage of concentrated energy and when energy is used in interaction processes. The dispersal of energy that accompanies all storages and processes is shown with the heat sink symbol in Figure 1.6. Dispersed energy cannot be used again.

For example, most of the solar energy used in the production process is dispersed by its use. It is necessary to disperse most of the input solar energy in order to make a small storage of biomass energy. When a consumer animal eats a plant, most of the food energy is dispersed to keep the animal alive and operate growth processes.

A Marine System Model

The parts of the marine system given in previous figures may be combined to show a whole marine system in a simple way, as in Figure 1.7. The box drawn around the symbols marks the boundary of the system. Only the source and the heat sink are shown outside the boundary lines. The energy source symbol is outside because the energy is provided from an external source. The heat sink is outside the box because this energy is dispersed from the system and cannot be reused.

Because some of the sunlight energy flows through the ocean without being used, the sunlight line is shown with one branch coming out again. The nutrients released by the consumers are

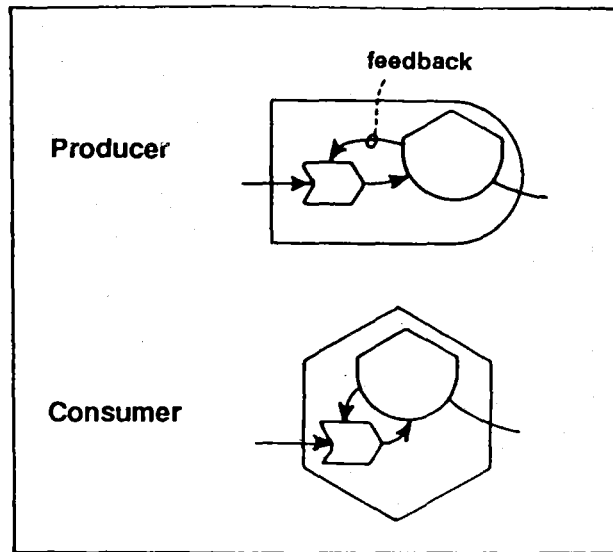

Figure 1.5. Parts within a producer and consumer.

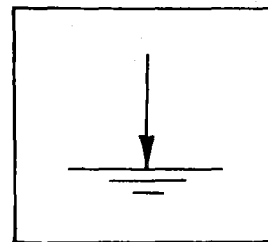

Figure 1.6. Heat sink symbol.

shown recycling back to the left into the plant production process.

In summary, the energy symbols show the way the producer and consumer parts of an ecosystem are connected, use energy, recycle materials, and use their storages to help interaction processes.

The symbols with their usual pathway connections are given in Figure 1.8. Seven are used in this chapter; the last three are used later.

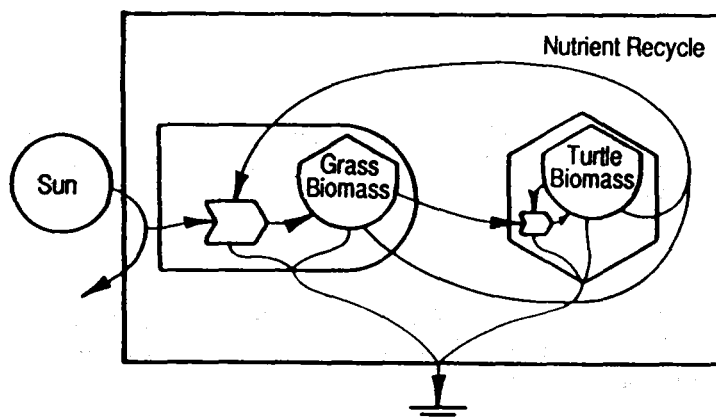
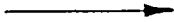
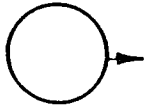

Figure 1.7. Marine system model.



ENERGY PATHWAY - a flow of energy often with a flow of materials.



ENERGY SOURCE - energy which accompanies each of the resources used by the ecosystems such as sun, winds, tidal exchanges, waves on the beaches, rains, seeds brought in by wind and birds.

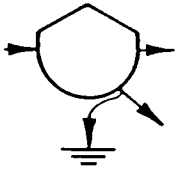

STORAGE TANK - a place where energy is stored. Examples are resources such as forest biomass, soil, organic matter, groundwater, and sands in beach dunes.



HEAT SINK - energy that is dispersed and no longer usable, such as the energy in sunlight after it is used in photosynthesis, or the metabolic heat passing out of animals. Heat sinks are attached to storage tanks, interactions, producers, consumers and switching symbols.

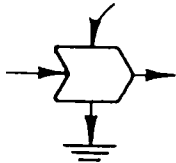

INTERACTION - process which combines different types of energy flows or flows of materials.

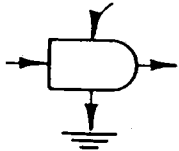

PRODUCER - unit which makes products from energy and raw materials, such as trees, grass, crops or factories.

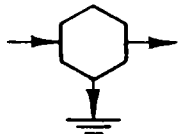

CONSUMER - unit that uses the products from producers, like insects, cattle, micro-organisms, humans and cities.



TRANSACTION - business exchange of money for energy, materials or services.

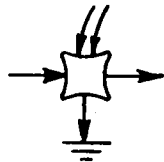

SWITCH - process which turns on and off, such as starting and stopping fire, pollination of flowers, and closing of fishing season.



BOX - miscellaneous symbol for subsystems such as soil subsystems in a diagram of a forest, or a fishing business in a diagram of an estuary.

2. THE FLOWS OF ENERGY AND MATERIALS THROUGH ECOSYSTEMS

A More Detailed Marine System Model

To survive, an ecosystem needs a continuing supply of materials. These may come from outside the system, from recycling, or from both. A system diagram can be used to trace the sources and flows of the most important materials and energy. A diagram can also be drawn for the sources and flows of each kind of material separately.

Usually, the process of photosynthetic production by green plants with help of sunlight energy (example: plant leaves) is written as follows:



The process of organic consumption by consumers is in the reverse direction (see reversed arrow):



The processes of production and consumption in a shallow marine ecosystem are diagrammed using symbols in Figure 2.1.

The bottom plants and phytoplankton use energy from the sun, kinetic energy (stirring) from winds and tides, and nutrients and carbon dioxide from the air to produce plant biomass. Some of the biomass is eaten by invertebrates while it is still green; some is consumed by microbes after it dies.

The consumers use oxygen from the water and release nutrients and carbon dioxide as byproducts.

Wind is an outside source that stirs the water and supplies oxygen and carbon dioxide that diffuses from the air into the water.

After some years, a marine ecosystem may come into balance. Water flows in and out; nutrients move from the water and sediments into living organisms and back again. Organisms grow, die, decompose, and their nutrients are returned to the system. If storages are unchanging, with inflows equal to outflows, the ecosystem is said to be in a steady state.

Quantitative Energy Flow

Energy is required for all processes. Amounts of energy can be measured by the heat released. There are two units commonly used to measure energy. The calorie is the heat required to raise the temperature of a gram of water one degree on the Celsius (centigrade) scale of temperature. A kilocalorie is a thousand calories. A human body releases about 2500 kilocalories per day which come from the energy in the food consumed.

By international agreement a different unit of energy is being used increasingly, the joule. A kilocalorie is equivalent to 4186 joules.

Energy is required for all of the processes in an ecosystem. Marine systems use energy from several sources. These sources, storages, and flows in a grass flat ecosystem are marked on the diagram in Figure 2.1. The numbers are in joules.

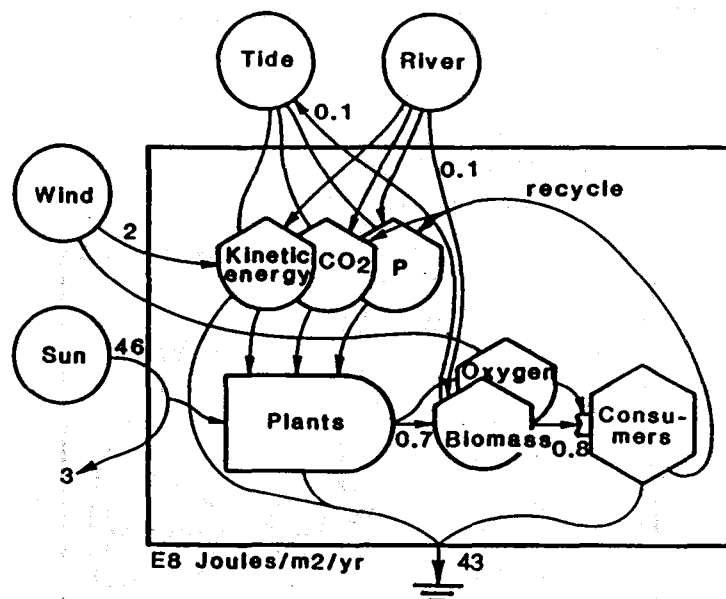

Figure 2.1. Diagram of photosynthetic production and organic consumption in a grass flat ecosystem.

The diagram includes some large numbers. Large numbers with many zeros can be represented as the product of the front part of the number multiplied by 10 for each zero. For example, 627,000 can be represented as:

$$6.27 \times 10^5$$

Or, you can use the way of writing large numbers used by microcomputers,

$$6.27 \text{ E}5$$

where E5 (meaning exponent 5) means to multiply by five 10s. This is the same as adding 5 zeros. In Figure 2.1 the latter notation is used to indicate the flows of joules.

Putting Numbers on Diagram Pathways

A good way to see how materials, energy or money are flowing in a system is to write numbers on the pathways of the diagram. For example, numbers on the flow lines in Figure 2.1 are the rates of flows of energy per year. In Figure 2.2 numbers are the grams of phosphorus flowing through the system, per square meter per year. Sometimes it is useful to show the average amounts that are stored. For example, in Figure 2.2, the average storage of phosphorus in the biomass is 10 grams per square meter per year.

Energy Laws

The marine energy diagram (Figure 2.1) illustrates two fundamental energy laws:

The first is the Law of Conservation of Energy which states that matter can neither be created nor destroyed. In our case this means energy flowing into a system equals the energy added to storage plus that flowing out. In Figure 2.1 the storages are not changing: the sum of the inflows of energy equals the sum of the outflows of energy. The joules of energy flowing in from sources in Figure

2.1 equal the joules of energy dispersing through the heat sink.

The second energy law is the Law of Energy Dispersal. It states that the availability of energy to do work is used up because of the tendency for energy to disperse. Energy also disperses from energy storages. When we introduced the heat sink symbol in the last chapter, we said heat sinks were required on all processes and storages. Heat sinks are required because of the second law. Notice the pathways of energy dispersal in the diagram in Figure 2.1. The joules of energy dispersing through the heat sink in Figure 2.1 are no longer available to do more work because the energy is too dispersed. Energy that disperses is not wasted energy, its outflow is an inherent and necessary part of all processes, biological or otherwise.

The Phosphorus Cycle

Chemicals (nutrients) are also required for the storages and processes of an ecosystem. One of the most important nutrients that are needed to build healthy organisms is phosphorus. Phosphorus is generally more scarce than other nutrients, such as nitrogen, although some marine ecosystems are limited by nitrogen. If phosphorus were not recycled by the ecosystem, it could become scarce enough to limit the growth of plants.

Flows and storages that contain phosphorus nutrients are included in Figure 2.2. However the inflows and recycling of phosphorus can be shown separately by removing the items that do not contain phosphorus from the diagram. The remaining storages and pathways are drawn in Figure 2.2 as a phosphorus cycle diagram. If drawn on transparent paper Figure 2.2 can be laid over Figure 2.1.

Phosphorus is present as inorganic phosphates which the plants use to produce organic compounds necessary for life. The phosphorus in these compounds is part of the biomass which is

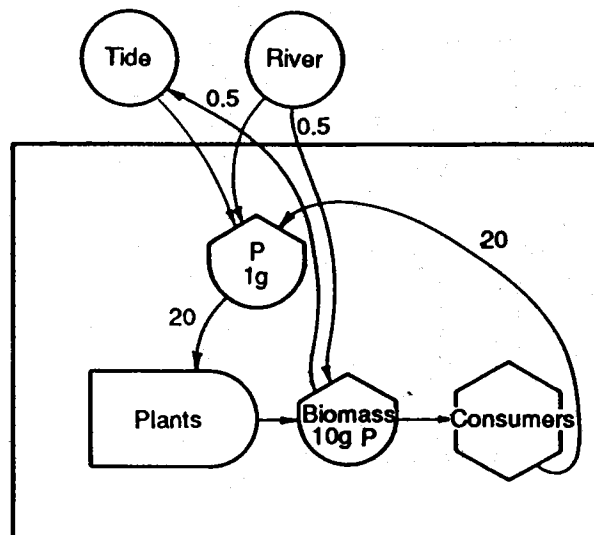

returned to inorganic form by the consumers when they use the biomass as food. The inorganic phosphorus released becomes part of the storage of nutrients in the water and soil. Thus, the phosphorus goes around in a circle as Figure 2.2 shows. Some flows out of the system with circulating waters. Phosphorus has no gaseous phase in its cycle.

The Nitrogen Cycle

The chemical element nitrogen is essential for all life and is in all living products. It is one of the elements required to make up proteins (muscle or "meat", nerves, hair, tendons, skin, feathers, silk, milk, cheese, seeds and nuts), enzymes, and genetic structures.

Of the air we breath, 78% is nitrogen gas, but most organisms cannot use it in this form. Gaseous nitrogen can be converted into usable forms (nitrates, nitrites and ammonia) by special processes which require energy. For example, industrial processes use fuels to convert nitrogen gas into nitrogen fertilizer for farms. Energy of lightning converts nitrogen to nitrates in rain. The plants, algae and bacteria that can do this are

called nitrogen-fixers. Blue-green algae can fix nitrogen using sunlight. Some herbs and trees have nodules which fix nitrogen using sugars transported from the leaves as the energy source.

Figure 2.3 shows the cycle of nitrogen in ecosystems. Starting with the nitrogen-fixing organisms, nitrogen passes into plants and then up the food chain to the animals. In plants and animals nitrogen is in the form of organic compounds such as proteins. Nitrogen returns to the soils and waters as waste products of animals and from the decomposition of plants and animals. The various nitrogen waste substances, such as urea in urine, are converted by bacteria into ammonia, nitrites, and nitrates. These are used by plants again to close the cycle. Some microbes return the nitrogen back to the atmosphere as nitrogen gas. This is called denitrification.

Similar diagrams can be drawn for each of the other required chemicals used in production and consumption, such as carbon and oxygen.

In summary, the symbol diagrams are a way to represent flows of the ecosystem including energy, water and phosphorus. The diagram with all the components shows how energy and materials interact to form one system.

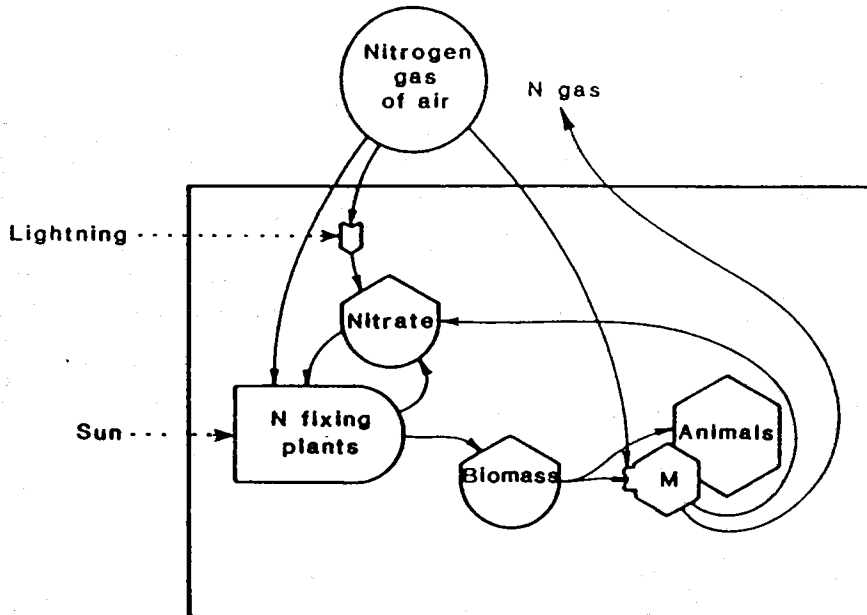

Figure 2.3. Nitrogen cycle of an ecosystem. M, micro-organisms.

3. THE FOOD WEB OF AN ECOSYSTEM

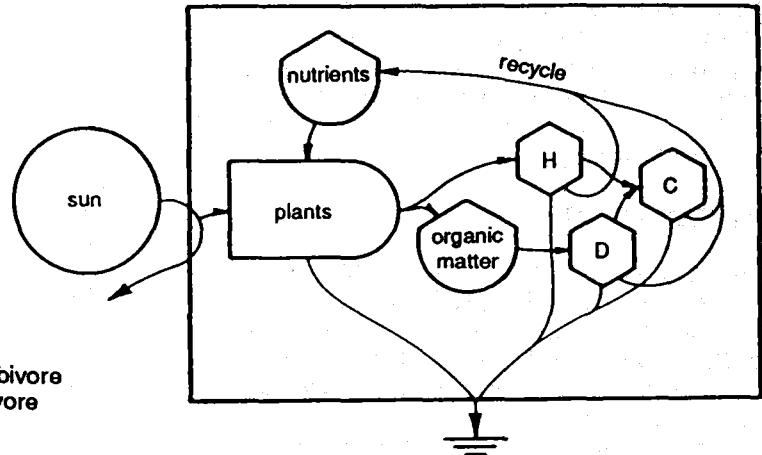

Figure 3.1. Production and consumption. H, herbivore consumers; D, decomposer consumers; C, carnivore consumers.

Flows of energy and materials in ecosystems have been examined using a shallow marine ecosystem as an example. We need now to take a closer look at the elements of the system's food web -- the plants, the decomposers, the control actions of animals and human beings (fishermen), the recycling of nutrients, and the way the ecosystem becomes organized with time.

Plant Photosynthesis and Respiration

The organic matter made by photosynthesis in plants goes to feed other organisms. Some of the plants are microscopic algal cells that are suspended in the water, called phytoplankton. Other larger plants are rooted in the bottom and wave in the water like grass on land. These are sometimes called grass beds.

Figure 3.1 shows that some of the organic matter from photosynthesis is passed to animals

that eat the plants. An even larger part of the organic matter, as dead plant matter, is consumed by micro-organisms and decomposer animals. Carnivores are secondary consumers. Even the plants are consumers at night, using stored organic matter from daytime photosynthesis. The process of consuming organic matter and recycling the nutrients and carbon dioxide is called respiration.

A More Detailed Ecosystem

In Figure 3.2 is drawn a detailed diagram of an estuary. External sources of influence are shown with circles. The parts of the ecosystem are shown inside the frame, including living and non-living components. The living plants, animals, and micro-organisms are called the ecological community. The heat sink at the bottom indicates the outflow of degraded energy that is no longer

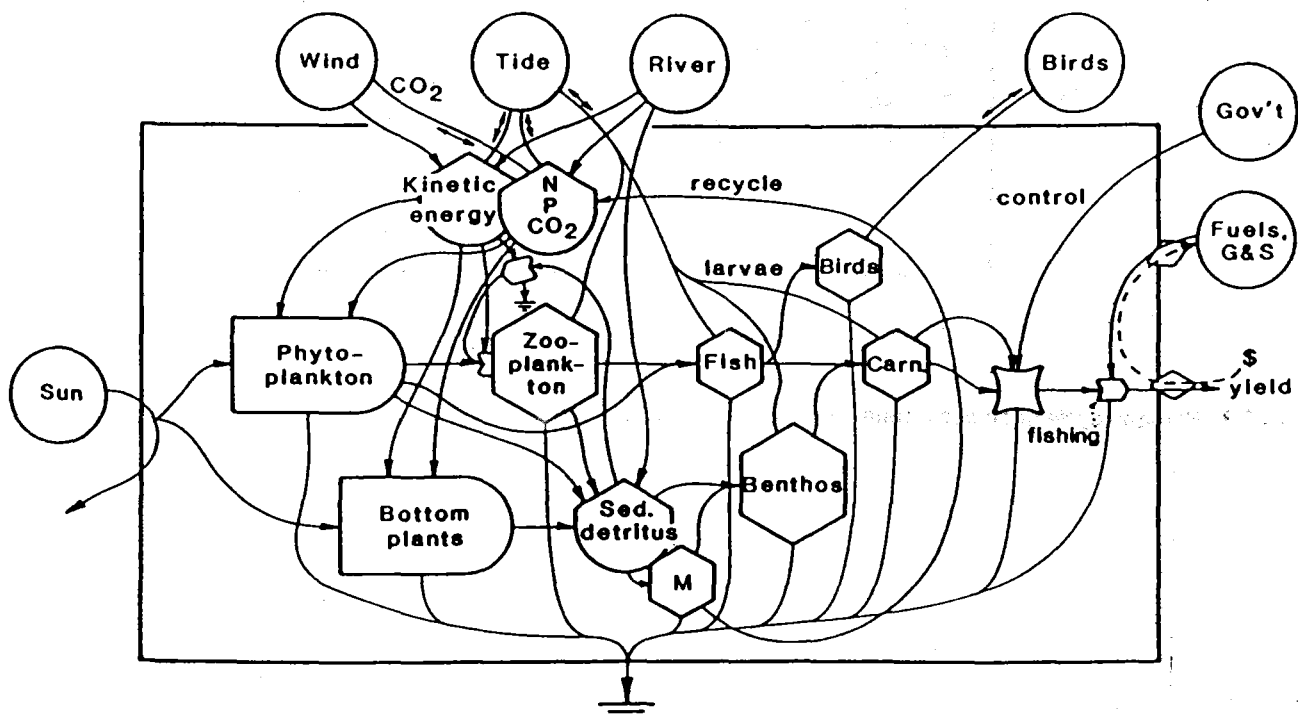

Figure 3.2. Energy diagram of an estuary. M, micro-organisms; N, nitrogen; P, phosphorus, CO₂, carbon dioxide; carn., carnivores; sed., sediment; detritus, dead organic matter and microbes; benthos, bottom animals: clams, crayfish,

concentrated enough to do useful work. This energy cannot be reused.

Starting with the outside sources (the circles), consider how these outside influences affect the ecosystem. The sun drives photosynthesis of phytoplankton and bottom plants. Wind, tide and river inflows contribute to the stirring of the water. The energy in stirring water is called kinetic energy. (Another word is turbulence.) All the organisms of the ecosystem are adapted to use this water movement.

The role of the kinetic energy in contributing to other functions is shown in Figure 3.2 where lines from kinetic energy go to other processes. The phytoplankton cells are kept suspended by the motion. The motion helps the plant photosynthesis by bringing nutrient raw materials like carbon dioxide (CO₂), nitrogen (N) nutrients, and phosphorus (P) nutrients to them. Thus the kinetic energy helps the recycling process. The stirring also keeps organic matter particles in suspension and moves them with currents so that the filter feeding animals can catch them as they go by.

The tide and river also bring into the ecosystem nutrients, carbon dioxide, organic matter, seeds of bottom plants, phytoplankton cells, eggs, and larvae of various animals. The seeding of new species from the gene pool is the means by which the ecosystem can develop more complexity. The rivers also bring in sediments such as sand and clay that form the bottom ooze in and on which much of the ecological community lives.

On the right is fishing by people. Boats are shown receiving inputs from the economy, fuels and goods and services (G & S) for their maintenance. Human services are used in the fishing process also. (In Part III of this book, money is shown as a part of the ecological-economic system, but it is omitted in Figure 3.2.)

The Figure shows the consumer food web in more detail. The tiny, pinhead-sized animals that are suspended in the water are called zooplankton. They are throughout the water at night, but tend to sink to dark lower parts of the ecosystem during the day. The zooplankton eat the phytoplankton and suspended organic matter, and in turn are eaten by small invertebrate animals (animals without backbones) and small fish. Some fishes, particularly of the herring group, eat the zooplankton and get some phytoplankton as well. These are plankton fish.

Another branch of the food web is on the bottom. Organic matter rains down from the plankton, primarily as fecal pellets from the digestive tracts of animals. Other organic matter comes from the dead bottom plants. Micro-organisms consume this matter. The mixture of dead organic matter and the microbes in the process of decomposing it is called detritus. Detritus is a rich food for other organisms. Some animals eat the bottom sediments in order to extract the organic matter. Others filter the water where the organic matter has been suspended by the turbulence. Those that live below the bottom sediment surface are infauna. Those that live on top of the bottom where they filter the passing water are epifauna. Some animals live on and under the bottom plants.

and fish which are also the choice food for harvest and sale by the fishermen.

Usually the food chain consists of branching pathways like those in Figures 3.1 and 3.2. This is sometimes called a food web. It is a network of connections. A network of relationships is called a system.

Fishing Season and a Control Symbol for Switching

In Figure 3.3 is a new symbol, which indicates a switching action. This symbol is used to indicate that a pathway turns on and off according to some controlling conditions. For example, a government control agency opens and closes a fishing season depending on its estimate of the fish stock.

The switching symbol is used in Figure 3.2. Notice the pathway where information goes from the top carnivores (commercial fish stocks) to the switching symbol: the control action is the pathway from the outside government agency to the symbol.

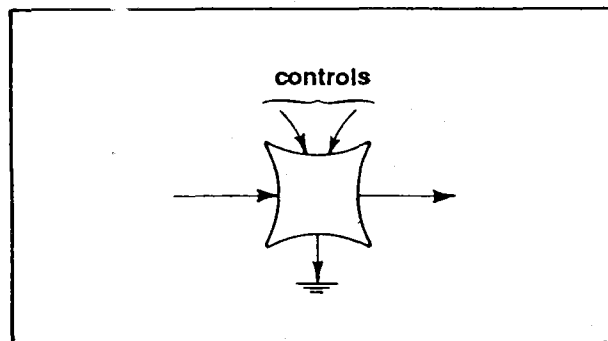

Figure 3.3. Symbol for a switching pathway that turns on and off.

Feedback Control Pathways

One population of organisms often controls another. The controlling species, such as a carnivore, may regulate the populations it consumes according to the time and place it selects food. The controlling species may affect spatial distributions, control reproduction and survival of larvae, etc.

The action of a controlling species on one lower in the food chain is shown in Figure 3.4. Whereas the food moves from left to right, the controlling

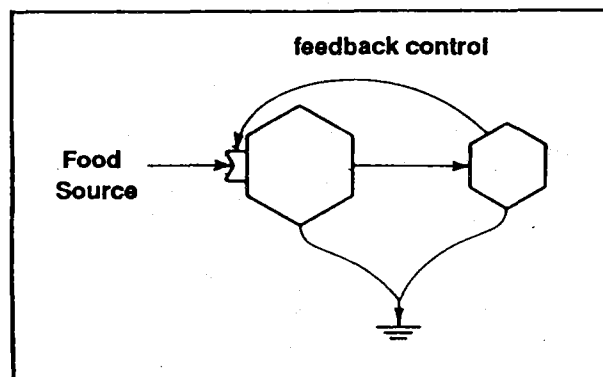

Figure 3.4. Feedback control action that makes two

action goes back from right to left and is called feedback. If the feedback is a favourable action that helps the food species on the left, it also helps the controlling species by helping both to live better. The principle is the same as the shepherd and the sheep. Although the shepherd eats the sheep, the shepherd controls them and manages the sheep for the survival of both. More and more, it is being realized that the animals are useful

managers of their own food chains.

The feedback actions like that shown in Figure 3.4 were omitted in Figure 3.2 so it would not get too complex to see relationships easily. Later, we discuss the problem of humans also feeding back constructive work to help maintain the fishes we eat. Whether there are wild species or humans at work, diversity and division of labour develops, helping make systems efficient.

4. TROPHIC LEVELS AND THE QUALITY OF ENERGY

To investigate energy exchanges within the food web, it is often convenient to reorganize the web into a single food chain. The food chain then can be divided into levels categorized by the kinds of food the organisms consume. These steps are called trophic levels.

A Quantitative Food Chain

The forests' food chain is shown in Figure 4.1. The energy relationships between the parts of the chain can easily be seen. About 1,000,000 (1 million) joules of sunlight are shown contributing to photosynthesis. Part of this is direct sunlight; part is the sun's energy that fell on the ocean to send rain to the forest. About 1% of this energy is transformed by the forest producers into plant biomass. In other words, about 10,000 joules of new trees and other plants are produced per year. 999,000 joules go down the heat sink as necessary energy used during the production process. The efficiency of this use of sunlight is, therefore, $10,000/1,000,000 = 1/100$, or 1%.

The range of efficiencies for photosynthesis in different plant species is between 0.01-2%. These efficiencies are low because sunlight is very dilute, and many successive steps and extensive chlorophyll-containing cellular machinery are necessary to concentrate it into higher quality energy. Plants have evolved the photosynthetic

process over several billion years, so it may be the most efficient way of using the sun's energy. This idea is important when sunlight is considered as an energy source for human systems.

At each succeeding level of our forest food chain, about 10% of the energy available to that level is converted to new biomass. This ratio also applies to producers, which consume 90% of their own production during respiration.

The 1,000,000 joules of sunlight that support the forest directly and indirectly in one year become:

10,000 joules of transformed energy, of which:

1000 joules is new producer biomass, which is consumed to become:

100 joules of new primary consumer biomass, which is consumed to become:

10 joules of new secondary consumer biomass, which is consumed to become:

1 joule of new tertiary consumer biomass.

This may be summarized by saying that to produce 1 joule of tertiary consumer, like a snake, it takes 1,000,000 joules of sun and rain.

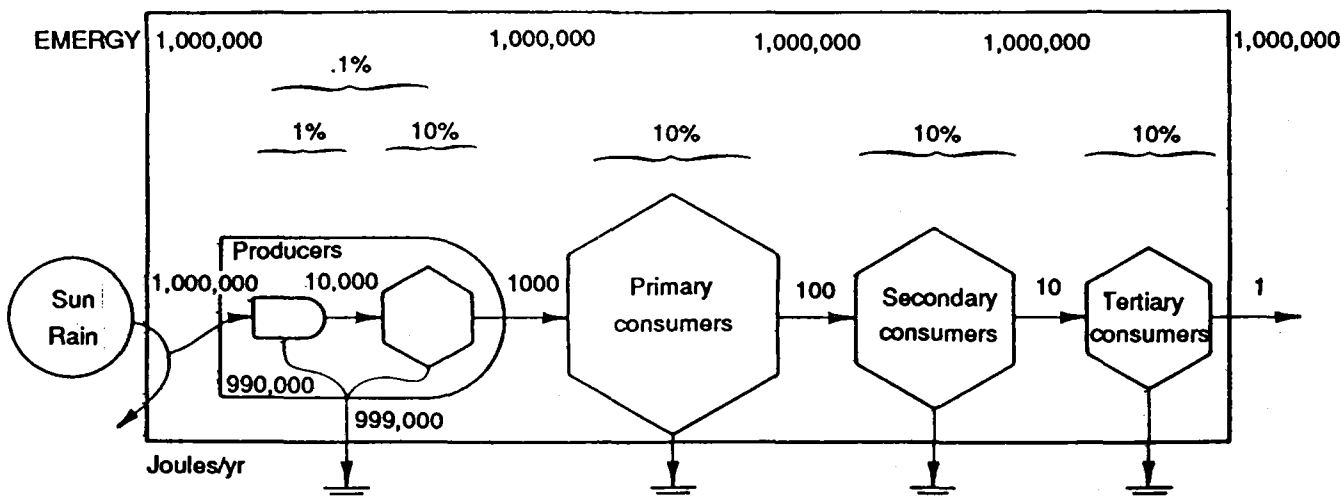

Carrying Capacity

The carrying capacity of an area is the amount of various kinds of organisms which can live in that area without harming the resource base. Generally, the more energy which flows into an area the greater its carrying capacity. With less energy, the carrying capacity is less. For example, if the amount of sunlight falling on a forest is decreased because of dust in the air, the carrying capacity of the forest will be decreased. Resources such as nutrients also contribute to carrying capacity.

The carrying capacity of an area for certain organisms depends on where they are in the food chain. Generally, an area can support more producers (at the left end of the food chain) and fewer high quality consumers (at the right). For example, the ranch in Figure 4.2 will grow more grass than cattle.

Energy Quality

Because it takes many joules at the left end of the chain to make a few joules at the right, we regard the energy at the right as being of higher quality. A gram of snake took more energy to produce than a gram of tree; therefore, the snake is higher quality energy. The energy quality is lowest at the left and rises with each step along the chain.

Energy Relationships in a Simple Farm System

Imagine a small cattle farm. The farm family grows grass, grazes cattle on the grass and uses the cattle as their only food source (they like steak). Energy expended in managing the system

comes from the family's labour. The food chain for this simple farming system is shown in Figure 4.2(a).

Notice the way the cattle are shown. Cattle really have two trophic levels within their bodies. They graze on the grasses which are first digested by microbes in their gut, then the microbes and remaining grass are digested and absorbed by the cattle. We would expect the cattle to convert about 10% of the energy available to them into new biomass, but because of these two feeding processes the cattle actually convert only about 1% of the energy of the grasses into meat and milk. In this farm system the farmer converts 10% of the energy from the cattle into his work with which he manages the system.

In the forest example it took $1 \text{ E}6$ joules of sunlight to produce 1 joule of snake activity. In the simple farming system it takes the same quantity of sunlight to produce 1 joule of farmer's labor. In other words, the snake and the farmer work at similar levels of energy quality. Both use the energy of their food chains to control their systems.

The feedbacks in Figure 4.2(b) go back up from the farmer to the cattle and to the pasture. The feedbacks from the farmer represent management in the form of breeding, herding, protecting the pasture.

The cattle also manage the pasture by eating the plants. This keeps the grass growth steady and prevents most shrub and tree seedlings from becoming established. These feedbacks, like those of the insects in the forest, seem to be necessary for the survival of all systems in the long run.

There are often suggestions that much energy could be saved by skipping the meat in the human food chain and having people eat only vegetation.

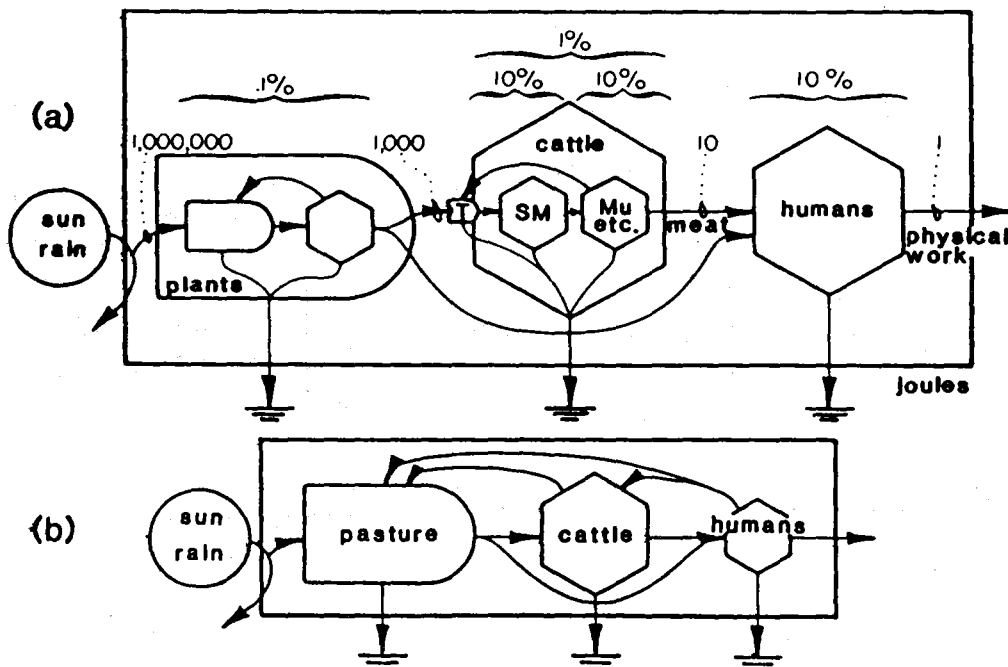

Figure 4.2. Food chain of a cattle ranch supporting humans (a) with levels of energy transformation; (b) with feedbacks of service shown. The cattle SM represent milk and meat.

When we look at the food situation in this world of hungry people, it is an appealing proposal. There is 100 times as much energy available in the grass as there is in the cattle in our simple farming example. However, as you can see from all food chains, energy is concentrated by work at each level. To get a balanced diet by eating only plants, humans have to do the work of gathering and concentrating energy which the animals now do. Growing and harvesting the cereals, vegetables, and nuts necessary for a healthy diet requires a great deal of energy. Also, cattle can digest range grass which humans cannot.

In many cultures, however, humans eat much more meat than they need. The most efficient diet may be largely vegetarian with a small regular meat contribution to ensure balanced nutrition.

Energy Relationships in Modern Society

Figure 4.2 represents a lower energy world. Human work is supported by a rural food chain based on grass and cattle. In modern industrial society humans have a longer energy chain. It converges more energy to each human. Human service has more high quality energy, making possible services of greater quality and effect. Figure 4.3 shows that the longer, modern energy chain began with green plants making organic matter. This was transformed into coal and oil, then to electricity and fuels like gasoline, supporting highly educated people. Figure 4.3 shows 20 million solar joules are required for one joule of human service, twenty times that in the simpler pattern of the farm in Figure 4.2(a).

Solar EMergy

It takes a lot of low quality energy (i.e., solar) to make higher quality energy (fossil fuels). Therefore, to compare different forms of energy, a calculation must be made. This is usually done by using joules of solar energy as your starting point to determine how many joules of solar energy it takes to make another energy source.

We use the word eMergy (spelled with an M) to express this idea - the amount of solar energy used to make a product. It is expressed in emjoules. For example, eMergy in a gram of rain is 75,000 solar emjoules.

Solar Transformity, a Measure of Quality of Energy

The solar energy required to make one joule of some type of energy is the solar transformity of that type of energy. The units are solar emjoules per joule (abbreviated sej/j).

$$\text{solar transformity of energy Type A} = \frac{\text{solar joules required}}{1 \text{ joule of energy of Type A}}$$

In Figure 4.1, one million solar joules generated 100 joules of primary consumers. Therefore, the solar transformity of the primary consumers is:

$$\frac{1,000,000 \text{ solar joules}}{100 \text{ joules of primary consumers}} = 10,000 \text{ sej/j}$$

In one sense the primary consumers' energy is 10,000 times more valuable than sunlight. The further to the right one goes in the food chains the higher the transformity.

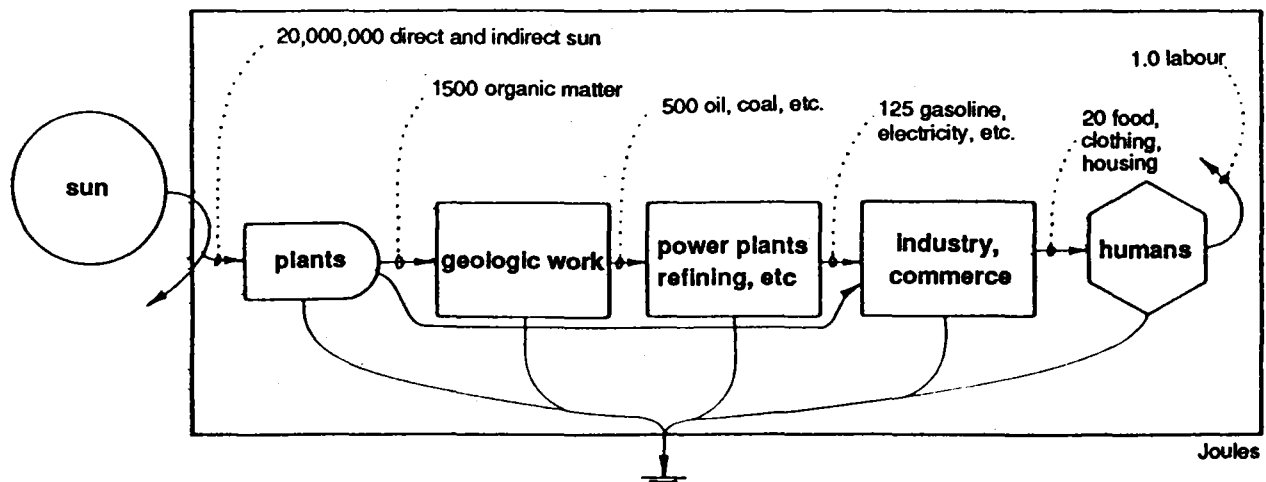

5. PRODUCTION AND THE MAXIMUM POWER PRINCIPLE

Production

Production is the process by which two or more ingredients are combined to form a new product. For example, soil nutrients, water, carbon dioxide, and sunlight are combined to form organic matter during photosynthesis. Typically, industrial production involves the use of energy, labor, capital, and raw materials to form industrial products. In Figure 5.1 the production process is illustrated. Notice the pointed interaction symbol with its inflows of ingredients and outflows of products. Whenever this symbol is used, it indicates that a production process is occurring.

During a production process, each inflowing ingredient carries energy of a different type and quality. During production, these energies are transformed to a new form. Some energy is degraded and flows out through the heat sink. Energy transformation like those occurring during production processes are referred to as work.

Gross and Net Production

Where there is a production process followed by a consumption process -- as in photosynthesis and respiration in plants -- we must distinguish between production and production minus the accompanying consumption. In Figure 5.2, gross production is the actual rate new products are made. Gross production is the flow at the point of the interaction symbol (5 grams per day, in this case). Net production is the production that is actually observed when production and some consumption are going on at the same time. In Figure 5.2, the gross production rate is 5 grams per day and the consumption rate is 3 grams per day. The net production is equal to gross production minus the accompanying consumption.

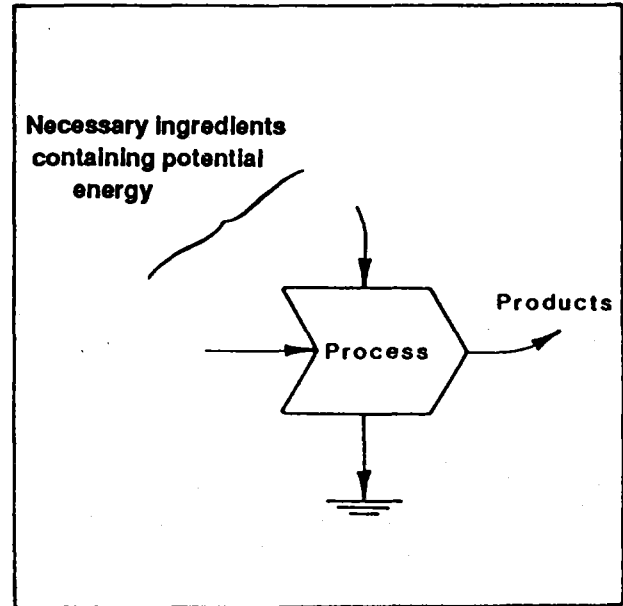

Figure 5.1. Production process with two interacting ingredients.

Therefore, net production is 2 grams per day.

In more complicated systems, such as the forest, where there are several stages of production and consumption, there is more than one kind of net production. For example, net wood production, net litter production, etc.

Net production also depends on the length of time it is measured. For example, at night most plants use up much of the production they made during the day. Their daytime net production is large, but their net production including night-time consumption is very small. If net production over a year is considered, it is often very small or even zero.

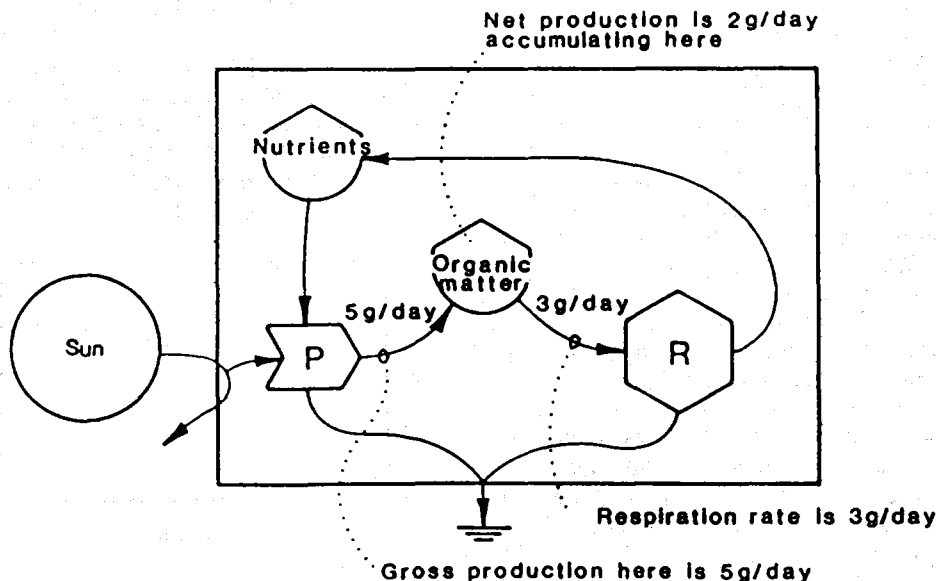
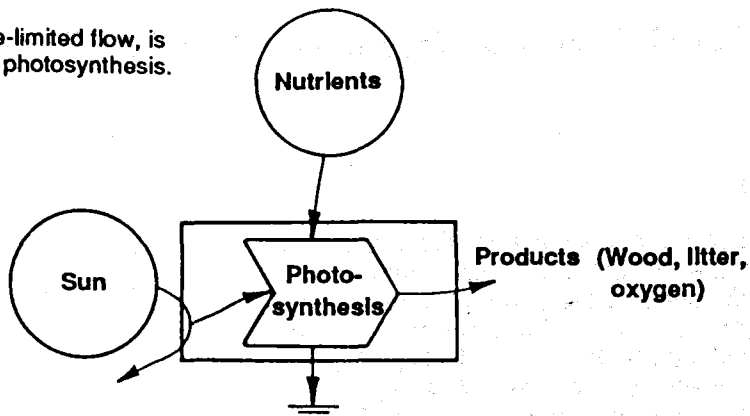

Figure 5.3. The sun, which has a source-limited flow, is often the limiting factor in the process of photosynthesis.



Limiting Factors

Most production processes go faster when the ingredients are available in larger quantities. However, a reaction can only proceed at a rate which is determined by the ingredient that is least available. This ingredient is then called a limiting factor. For example, since light is necessary for photosynthesis, the process slows down and stops at night; sunlight is the limiting factor which controls this process.

In Figure 5.3, increasing the supply of nutrients will not increase production. This is an example of an external limiting factor; it is outside the system.

In Figure 5.2, increasing light causes the nutrients to become limiting because they get tied up in the matter produced and do not recycle fast enough. This is an example of an internal limiting factor; it limits because recycling is not fast enough.

In Figure 5.4 production is graphed for various values of nutrients. As nutrients are increased rate of production increases. However, as light becomes limiting the production rate slows its increase. This graph is typical of limiting factors. This curve is called the law of diminishing returns in economics.

The computer program for this model is given in the appendix, Table A.1.

The Maximum Power Principle

The maximum power principle indicates why certain patterns of system organization survive and others do not. The principle explains why successful systems have similar networks. A successful design is one that has survived the test of time. The principle is stated as follows:

System designs which survive are organized so as to bring in energy as fast as possible, using it to feed back to bring in more energies. Another way to state the principle is as follows:

There is survival of the fittest system design; the fittest design is the one that can draw the most power, using it to meet all other needs.

System designs that maximize power are also the systems that feed back to the larger system of which they are a part. For example, species in an ecosystem are organized to contribute to the whole system's energy use. In the larger system of the forest, a tree uses the energy of the sun by growing leaves which increase in size and number to catch more of the sun's energy. This process of

building soil, making a stable micro-climate, recycling nutrients and providing food for animals. Thus, the tree maximized both its own power and that of the larger system of which it is a part.

To maximize power in an economic activity, local resources are used and traded for additional resources. For example, consider a farm on which crops are planted at the best time in relation to rain and sun. The best fertilizers are applied to make the crops grow, and crops are grown that people will buy. This farm will produce enough financial return for the farmer to live well, maintain the soil, and repeat the process year after year. He may even be able to expand his system by buying up less efficient farms. The successful farmer's way of farming will survive and will then be copied by other farmers. Because his work is helping to increase the energy use of the whole economy, this pattern is encouraged by the economy and survives.

During times of abundant energy supplies, maximizing growth maximizes power. Thus, during the early stages of succession, communities increase their biomass rapidly.

When energy supplies are steady, maximum power means less competition and an increase in diversity and efficiency. When energy resources become limiting, developing efficiency through diversity maximizes useful power. In a mature forest system each organism has its niche and there is very little competition. The organisms tend to have co-operative, rather than competitive relationships. In the mature economic system, co-operation is again more common than competition. Hopefully, therefore, when fossil fuels are less available and countries are running on renewable energies, tendencies to expand and crowd each other will be less. Relations among nations may then be more peaceful.

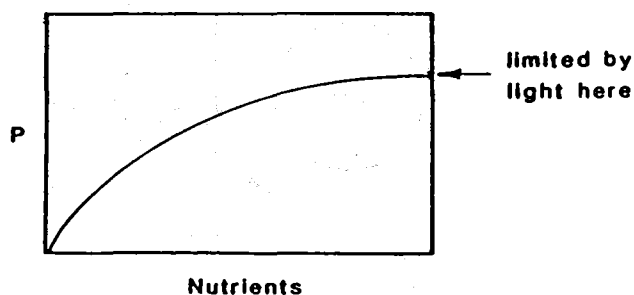

Figure 5.4. Graph of production rate (P) of the process in Figure 5.3 as nutrients are increased and light

6. GROWTH MODELS

The biosphere is made of systems that change as time passes. Both environmental systems and human systems can be described by the way they change. The way a system changes depends on the system's organization and on the kind of energy source that is available. For example, some ecosystems increase in size and complexity during succession but others stop growing. Some small towns can grow into cities whereas other towns seem to remain the same size for decades. They appear to have reached a steady state. Other towns decrease in size and complexity, factories close, and people move away.

The organization of a system can be studied by drawing a systems diagram (model). From the kinds of energy sources in the diagram we can tell how the system grows or decreases.

Model 1: Exponential Growth

The first model is shown in Figure 6.1. It represents a population growing on a constant-pressure source. A constant-pressure source can supply as much energy as is needed. As an example, think of a population of rabbits growing on a hopper of food which is replenished regardless of how fast it is eaten. Follow the flows in the diagram to see that, as the rabbit population increases, it feeds back to bring in more energy (by eating more) to make even more rabbits. If the system starts with a male and female rabbit and they produce four offspring, these pair and produce eight offspring; then at the same rate of increase the next generation will produce 16, the next 32; the next 64; and so on. As the number of rabbits increases, more of the energy source is used and the number of rabbits increases even faster.

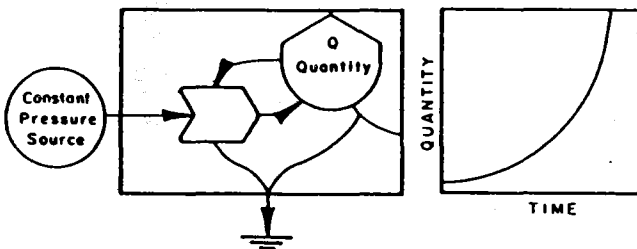

Figure 6.1. Model 1: exponential growth of a system with an energy source that maintains a constant pressure.

You can see that there is acceleration of growth of the rabbit population as long as the same concentration of food supply is maintained. The growth curve of a population under these conditions is said to be exponential. Exponential growth is a constant percent increase per time.

In practice, a constant pressure energy source cannot be maintained indefinitely, so that perpetual exponential growth is impossible. However, during the early stages of population growth, when the demand for food is small (compared to the amount available), energy may be available at constant pressure and growth may be exponential. But

eventually, food would become limiting and the situation would need to be represented by a different model.

Model 2: Logistic Growth

Populations initially growing fast on a constant pressure source may become so crowded that losses develop due to interactions among members of the population. A steady state results. This kind of growth is called logistic growth. An example is the growth of yeasts in a fermenting brew.

Logistic growth is the balance between production in proportion to population and losses in proportion to the chance of the individuals interacting.

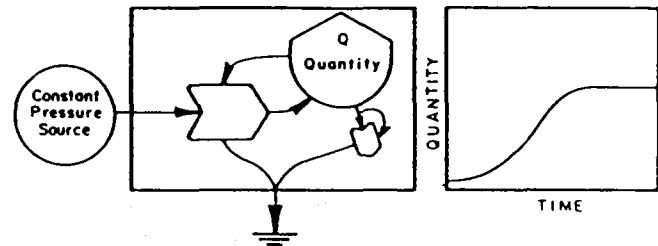

Figure 6.2. Model 2: logistic growth of a system with a constant-pressure energy source and a self-interaction on the outflow drain.

The growth process may be understood with the help of the symbol diagram of the model in Figure 6.2. First the growth of the population is almost exponential. Food availability is constant, and as the population grows it feeds back to eat more and more. However, as the yeast cells become crowded their byproducts begin to interfere with their own growth. A steady state results between production and loss of cells.

In Figure 6.2 notice that the production part of the model is the same as that in Figure 6.1. The energy supply is a constant-pressure source, and the population is drawing in energy and feeding back to draw in more. Population growth is therefore exponential – at first. However, as Figure 6.2 shows, the population, by interacting with itself, creates an accelerating energy drain which will eventually draw off enough energy to stop population growth. Thus, the graph shows exponential growth which slows and eventually levels off to a steady state. This system has a constant-pressure source and a self-interactive drain.

Notice that in Figure 6.2, the label on the storage symbol is "quantity". We will continue to use this general term for the contents of the storage. You should remember that "quantity" may refer to population numbers, biomass, energy stored or all of these.

Another example of Model 2 (Figure 6.2) is the growth of a human population and its services in a city. Growth may increase exponentially until the crowding of houses, streets, stores, and cars starts

to increase the negative factors of dirt, noise, crime and pollution and the cost of dealing with these becomes progressively greater. The more the population builds up, the greater the drain until the growth of the city levels off.

Model 3. Growth on a Constant Flow Source

Ecosystems use many sources whose flows are controlled by outside systems. Examples are sun, rain, wind, and flowing streams. Populations in the system cannot increase the outside inflows. Their growth is limited to that which can be sustained on the inflowing energy. Trees using sunlight are an example. There is nothing that the trees can do to increase or decrease the incoming sunlight.

Figure 6.3 shows the way this kind of source is drawn on symbol diagrams. A pathway from the source is shown passing into the system with some of it continuing on out of the system again. The energy use is shown as a line from the side of the inflow path. You can think of it as a pipe connected to the side of a stream to draw out water.

Now consider growth that occurs on such a source when the inflow is constant, and the pumping is in proportion to the population using the stream (Figure 6.3). The model is like the exponential growth model except there is a constant-flow source instead of a constant-pressure source. As the population grows, more and more of the inflow is diverted until almost all is being used as fast as it is flowing in. After that no more growth is possible, and the population is at steady state.

An important example in nature of Model 3 is succession. The growth of a forest is an example. When the forest is young, light energy is not

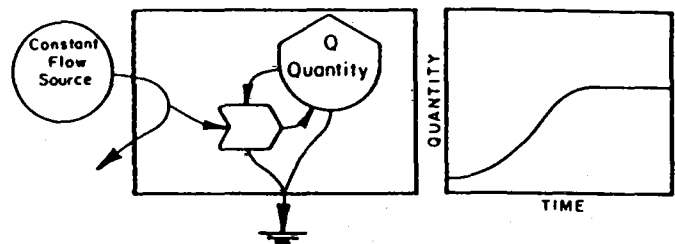

Figure 6.3. Model 3: growth of a system with a constant flow energy source.

limiting. Growth of the small trees is rapid and much of the surplus light passes by unused. As the forest grows, however, the trees use more and more energy, and less and less escapes unused. Growth slows and levels. The forest becomes a balance between growing and decomposing. Succession is discussed in the introduction to Part II and in Chapter 15.

Another example of growth on a steady-flow source is the building of towns along a river. Towns use water for drinking, farming, fishing, and disposal of treated sewage. New towns can be built until all the water is being used as fast as it is flowing in.

The graph of growth on a constant-flow source is S-shaped (Figure 6.3). It has the same shape as the logistic growth (Figure 6.2) but for a different reason. The logistic model is not limited by its source (constant-pressure sources do not limit growth) but is limited by crowding. The constant-flow source model is limited by rate of supply by its source.

Computer programs for the models in this chapter are found in appendix Tables A.2 - A.4.

7. MORE GROWTH MODELS

Model 4: Growth in a Simple Storage Tank

The fourth model is one of a storage tank with an inflow from an energy source and an outflow. As an example, think of an empty water tank high above town with a steady flow of water coming in and a drain through which water is flowing out. As the water flows in, the tank fills up. As it fills, the increasing weight of the water will cause it to flow out the drain faster. Eventually, water will be flowing in and out at the same rate, and the water level will stay the same. This situation is represented in Figure 7.1(a). The graph shows the change in quantity of the water as it increases quickly, then more slowly, and finally reaches a steady state sometimes called a dynamic equilibrium.

The outflow pathway is drawn with a branch, the material going out to the right and the dispersed energy passing down through the heat sink.

Suppose that the tank were full at the start instead of empty. What would happen then? As Figure 7.1(b) shows, if you start with the tank full, the level will decrease until the same steady state

is reached. What would happen if the water inflow is turned off? As Figure 7.1(c) shows, the level in the tank decreases quickly at first, and then more slowly, because as the amount of water decreases its pressure on the drain becomes less.

Another example in nature is a stream flowing steadily into a pond that also has a stream flowing out of it. When the stream first starts flowing, the pond fills up to a level where the flow into the pond equals the flow out (Figure 7.1(a)). Figure 7.1(b) illustrates the situation of the pond after a large rainfall. The quantity of water stored in the pond is high (because of the rain) but soon comes down to the same level as before. If the inflow stream is suddenly diverted, the water in the pond will drain away until there is none left, as is shown in Figure 7.1(c).

Another example is the buildup of leaf litter on the floor of a forest. Litter builds up a layer which continues to grow until the rate of loss from decomposition equals the rate of gain from leaf fall (Figure 7.1(a)). If a sudden gale dumps a load of leaves on the ground, the change in litter quantity would look like Figure 7.1(b). In some forests the leaves stop falling in the winter: the pile of leaves

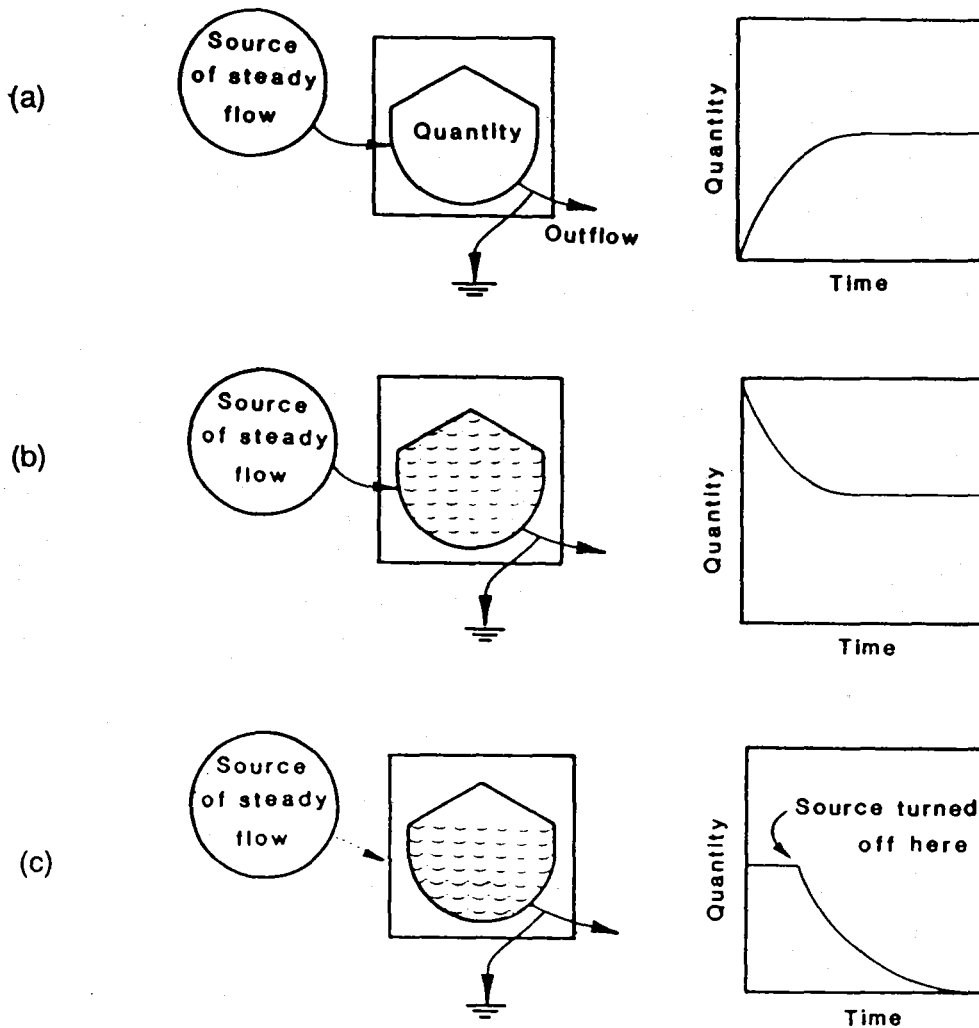

Figure 7.1. **Model 4:** growth, steady state, and decline of a system of one storage tank and an energy source with a steady flow. (a) Start with storage tank empty. (b) Start with full tank. (c) Start with steady state, then cut off energy source.

in the forest would then decrease as shown in Figure 7.1(c).

Model 5: Growth on a Nonrenewable Source

Some systems depend on resources drawn from a nonrenewable source; for example, a population of beetles growing on the energy available from a decaying log (Figure 7.2). When the beetle population is small, there is ample energy and growth is exponential. Later, as the

log begins to disappear, growth of the beetle population slows. As the log continues to get smaller, the number of beetles decreases until there is no more log – and no more beetles. On the graph, the line Q, represents the population numbers. The line N, represents the energy remaining in the log at any given time.

Another example is a mining town with a single nonrenewable economic resource such as a coal deposit.

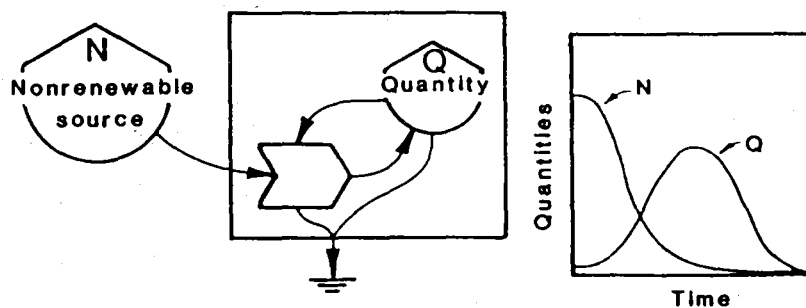
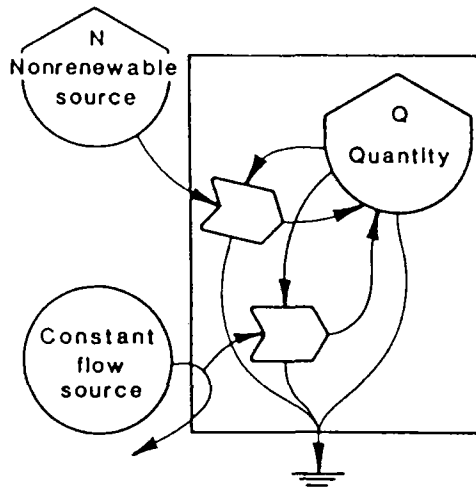

Figure 7.2. **Model 5:** Growth of a system with a nonrenewable energy source

Model 6: Growth on Two Sources

Our sixth model has two sources, one renewable and one nonrenewable (Figure 7.3). Both sources interact with the tank quantity which grows and provides feedbacks to the process. Growth thus uses both sources. As the nonrenewable source runs out, growth declines until it reaches a steady state using just the renewable source. This model is formed by the combination of the models of a nonrenewable energy source (Figure 7.2) and a renewable source (Figure 7.3).

An example of Model 6 is a population of fish living in a pond to which a batch of fish food was added. The two energy sources are the renewable



solar energy coming into the pond from the sun and the nonrenewable energy in the added fish food. The fish population will grow exponentially at first until the fish food gets scarce. Then the population will decline to a level that can be supported by the food chain based on the pond's use of sunlight for photosynthesis.

Another example of a system that may perform in this way is the economic system created by human societies (where N = nonrenewable resources, Q = quantity of economic assets). Our economic system has been growing on nonrenewable fossil fuels as well as the renewable sources such as sun, rain, and wind that support agriculture, forestry, and hydroelectric power. As the nonrenewable fuels are used up, our economic system may have to decline and settle into a steady state using only the renewable energies. However, if new sources are found, a different model would be needed.

For computer programs for models 4 - 6, see the appendix, Tables A.5 - A.7.

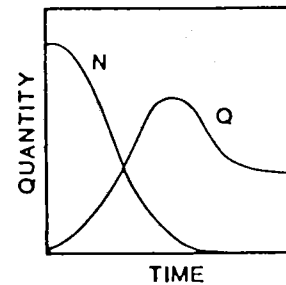

Figure 7.3. Model 6: growth of a system with two energy sources, one a nonrenewable source and the other a constant-flow renewable source.

8. SIMULATING QUANTITATIVE MODELS

The energy language diagrams are a useful way of visualizing the ways systems respond. Six models of systems with different types of energy sources and storages have been presented, along with graphs of the way each system responds through time. The energy symbol language becomes much more powerful, however, when actual numbers are used to show the way systems respond.

Energy language diagrams are really mathematical statements. With them, we have been using symbols to represent quantities and

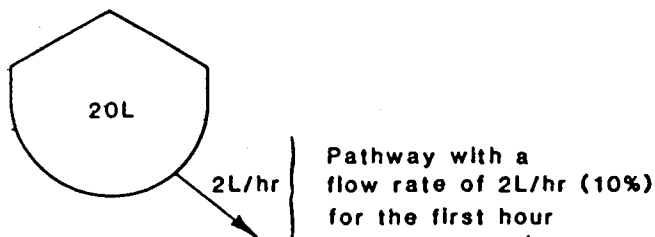

Figure 8.1 Tank drain model

relationships. They become mathematical statements by putting the amount in each storage symbol and the flow rate on each pathway. If we do this, we have a language that is very close to the language understood by computers.

If you have access to a computer, you can use it to carry out the simulation exercises in this section. If you don't have a computer available, you can do the simulations by hand calculation.

Coefficients for Simple Pathways

To represent quantitatively what is happening to a model at any one time, numbers are simply written on the diagram. Flow rates are written on the pathway lines, and storage quantities are written in the storage symbols.

Imagine a sink containing 20 litres of water. The plug leaks so that 10% of the remaining water flows out each hour. During the first hour the sink will lose 2 litres of water. Our quantitative energy language diagram for the system is shown in Figure 8.1.

This diagram is a quantitative description of the system at the start of the first hour. However at

the start of the second hour things are different. The quantity of water left in the sink is now 18l and the rate of outflow is a tenth (.1) of that or 1.8l/hr. As each hour passes and more water runs out, the values get smaller. We need an equation for making calculations.

First we can represent the quantity of water in the storage by Q (and understand that Q will change with time).

Second we can describe the outflow with a pathway coefficient, called k, that indicates the fraction of the remaining water that drains out each hour. The larger the drain pipe the larger is the coefficient. In this example our pathway coefficient is 0.1 (or 10%).

Notice that:

Outflow = pathway coefficient x amount left in storage = $k \times Q$

and:

Pathway coefficient = decimal fraction of storage flowing out per unit time.

Our model for the leaking sink now looks like this:

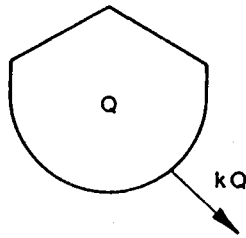

Figure 8.2. Tank model showing Q and kQ, k = 0.1.

Hand Simulation

Table 8.1 shows the calculations of tank storage and outflow by the hour.

Let's examine the calculations that were made to form Table 8.1. The process was one of repeating a series of step-by-step subtractions from the storage. The process of making repeated

calculations like this is called iteration. For example, the process in Figures 8.1 and 8.2 could be stated in words as follows: The quantity at the next time interval is the quantity at the present minus the outflow.

$$(\text{new } Q) = (\text{old } Q) - (k \times Q)$$

In other words, the above equation says:

The new Q will equal the old Q minus k times the old Q.

Let's write this equation the way it appears on a computer screen where * means to multiply; and = means "will equal".

$$Q = Q - k * Q$$

In our tank drain model (Figure 8.1) the starting value for Q is 20l and k = .1 per hour. In Table 8.1 the start is indicated by the first line when time is 0, and Q is 20 l.

For the first hour:

$$\begin{aligned} \text{Outflow} &= kQ \\ &= 0.1/\text{hr} \times 20 \text{ l} \\ &= 2 \text{ l/hr (2 liters per hour)} \end{aligned}$$

At the end of the first hour the storage of water is calculated by subtracting an hour's outflow:

$$\begin{aligned} \text{New storage} &= \text{old storage} - \text{outflow} \\ &= 20 \text{ l} - 2 \text{ l} \\ &= 18 \text{ l} \end{aligned}$$

For the second hour:

$$\begin{aligned} \text{Outflow} &= kQ \\ &= 0.1 \text{ l/hr} \times 18 \text{ l} \\ &= 1.8 \text{ l/hr} \end{aligned}$$

At the end of the second hour:

$$\begin{aligned} \text{New storage} &= \text{old storage} - \text{outflow} \\ &= 18 \text{ l} - 1.8 \text{ l} \\ &= 16.2 \text{ l} \end{aligned}$$

Table 8.1 has these hourly calculations for the first five hours. Extend this table to 20 hours. Plot the points on a graph. It should look like Figure 8.3.

Table 8.1 Hourly Calculations for the draining tank (Figure 8.2).

Time since start (hours)	Quantity Q (liters)	Outflow rate kQ (liters/hour)
0	20	2
1	18	1.8
2	16.20	1.62
3	14.58	1.46
4	13.12	1.31
5	11.81	1.18

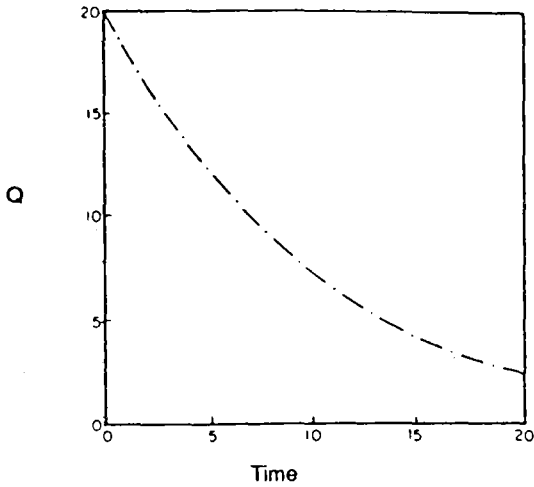
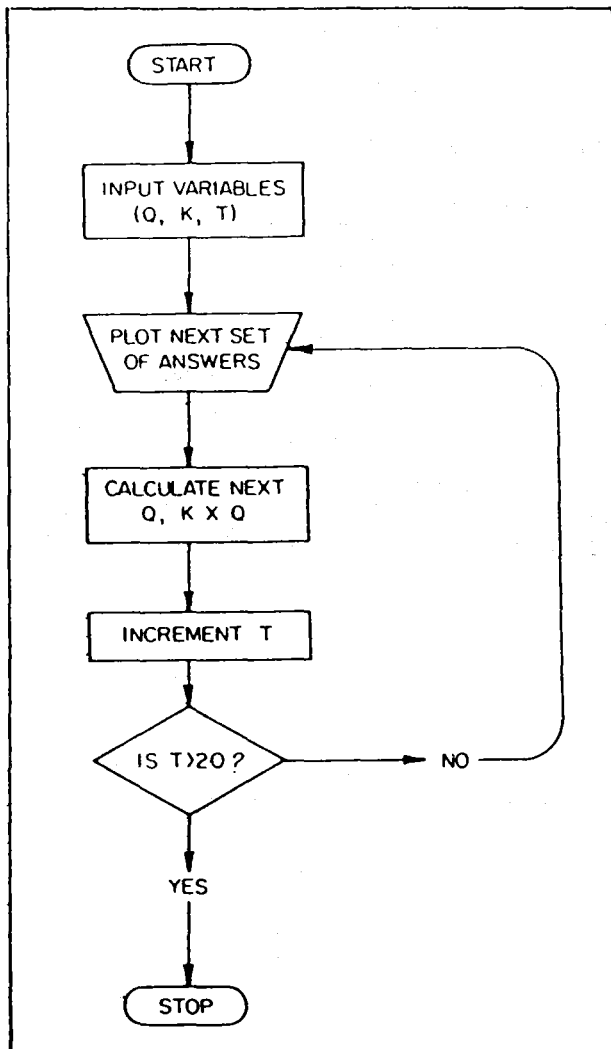

Figure 8.3. Graph of storage quantity (Q) with time as calculated in Table 8.1, simulating the model in Figure 8.2.

Flow Chart

When a series of calculations are to be made over and over, the various steps of the calculation procedure can be written as a flow chart. Figure 8.4 is the flow chart for the calculations that you made in Table 8.1. Reading from the "start" at the top, you are instructed to supply the starting numbers; plot the values on a graph, calculate the



values after the time interval, go back and plot and calculate again; continuing until the time is 20 hours. Making such a chart is sometimes helpful in getting in mind what are the steps of the calculation.

A list of steps in a procedure is called a program. The flow chart (Figure 8.4) is one way of writing a program. If a list of instructions is written for a computer it is a computer program.

Computer Simulation

(If you do not have access to a computer skip to the next section). First, we will indicate how to do simulation on an Apple II microcomputer and an IBM PC.

To make a microcomputer do the calculations, you give it a list of instructions in a language to which it is built to respond. The words and symbols you need to use in instructing a microcomputer are given in Table 8.2. They are part of the BASIC language. If you put a computer

Table 8.2. Some instructions in BASIC language to which microcomputers respond.

Command	What it does
LIST	Lists the program in the working memory
RUN	Runs the program, working through the instructions in numerical order
GO TO	Goes to a designated instruction number and performs it next
IF	Provides a condition for doing something such as going to another designated line (e.g. IF T is less than 20, GO TO ...)
PRINT	Shows on the screen the numerical value of the quantities that you list after the PRINT command
PLOT	Shows on the screen a graph of the changes in values of the quantities you list after the PLOT command (the plot command varies for each make of computer)
END	Stops running the program
=	Sets a quantity equal to what is specified.
+	Adds the next quantity
-	Subtracts the next quantity
*	Multiplies the next quantity
/	Divides by the next quantity
<	Less than

disk which has been prepared for a particular computer and turn on the power switch, the computer will then be ready for you to type in the statements of the program. The statements are given in Table 8.3. Statements are numbered 10, 20, 30, etc. After the program has been typed in and is in the working memory and on the screen, type RUN and the computer will follow the list of instructions until the calculations are completed. The numbers that you calculated by hand in Table 8.1 will be listed on the screen. To save your program on a disk, type SAVE and the program name. To get your program on the screen, type LIST.

If the computer is connected to a printer and you want to print out the program, on Apple type PR#1 and then LIST; on IBM type LLIST. To print out the calculations, on Apple type PR#1 and then RUN; on IBM type LPRINT. To get action back to the screen from printer, on Apple type PR#0; on IBM the operation is automatic.

The following is an explanation of statements in the program (Table 8.3 and Figure 8.2).

First, we tell the computer the sizes of the quantities it will be working with at the start. Thus, we have (in Table 8.3):

10 Q = 20 (quantity in storage = 20).

20 K = .1 (pathway coefficient = .1).

30 T = 0 (time = 0).

Then we tell the computer to print these numbers:

40 PRINT T, Q, K*Q

Next we tell the computer what to do with these numbers:

50 Q = Q - K*Q

which means, "new Q is equal to old Q minus k multiplied by old Q". (Note: * means multiply, to avoid confusion about what x means.)

Having done that, the computer is told to advance time by one unit:

60 T = T + 1

and then, if T is less than 20, it is told to repeat instructions 40, 50 and 60:

70 IF T < 20 GO TO 40

Table 8.3. Program in BASIC for rough simulation of model in Figure 8.1.

```

10   Q = 20
20   K = .1
30   T = 0
40   PRINT T, Q, K*Q
50   Q = Q - K*Q
60   T = T + 1
70   IF T < 20 GO TO 40
80   END

```

Notes: O is the letter O. 0 is a zero.

On most microcomputers, including the Apple, statements 30 and 80 are unnecessary.

Our faithful computer repeats the calculations for each new time interval, prints out the results and advances the time until it gets to T = 20. At that point, when it gets to instruction 70 it does not go back to 40, but goes instead to 80, which says:

80 END

The whole sequence of calculations takes a few seconds; the results are neatly listed on the screen in tabular form. Beats hand-simulating, doesn't it?

To obtain a graph instead of a table of results, we can replace the PRINT instruction in 40 by a PLOT instruction. Plot instructions vary from one type of computer to another. The plot statement tells the computer to plot a graph of successive points with T on the horizontal axis and Q on the vertical axis. We obtained Figure 8.3 by giving the computer a plot instruction on the Apple microcomputer as follows:

40 HPLOT T,160-Q

and, to put the computer in the graphics mode and set color to white another statement is necessary:

5 HGR: HCOLOR=3

On the IBM PC the statements are:

SCREEN 1,0: COLOR 0,0

and

PSET (T/0.7, 180-Q/200),3

The curve in Figure 8.3 shows that the outflow rate is decreasing as the water pressure in the tank decreases. A similar program is listed in the appendix, Table A.8.

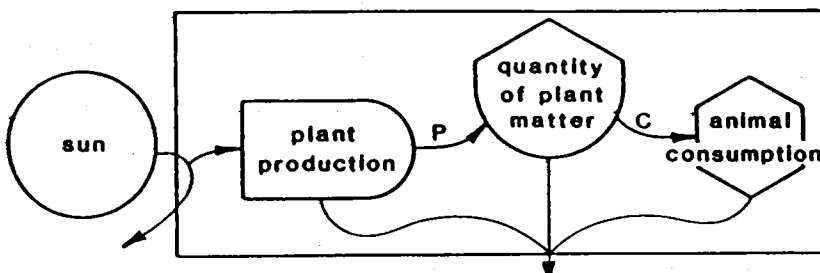

A More Complex Simulation

This model in Figure 8.5 represents an ecosystem -- any ecosystem. It indicates that sunlight falling on the producers is captured during photosynthesis and stored in plant biomass until it is consumed by animals or by the plant tissues at night. Now let's add some data. Sunlight varies during the year, and typically might provide the following quantities of energy:

Year	Season	Sunlight E3 joules/m ² /season
1	Winter	5,000
	Spring	10,000
	Summer	15,000
	Autumn	10,000

If the plants capture and store a steady 1% of the available light energy ($k^1 = .01$) and if animals consume a steady 20% of the energy stored in plant tissues ($k^2 = 0.2$), then a quantitative model looks like Figure 8.6.

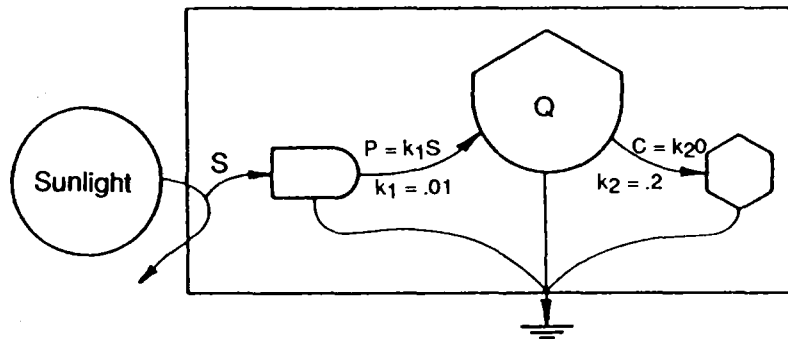

Figure 8.6. Ecosystem diagram with pathway coefficients.

Table 8.4. Calculations for hand simulation of diagram in Figure 8.6. Units are E3 joules/m²/season.

Year	Season	Sunlight S	Plant production $P = .001 \times S$	Animal consumption $C = .2 \times (\text{old } Q)$	Quantity of plant matter (new Q) = (old Q) + P - C
	Start	--	--	--	.1
1	Winter 1	5,000	5	$.2 \times .1 = .02$	$.1 + 5 - .02 = 5.1$
	Spring 2	10,000	10	$.2 \times 5.1 = 1.2$	$5 + 10 - 1 = 14$
	Summer 3	15,000	15	$.2 \times 14 = 2.8$	$14 + 15 - 3 = 26$
	Autumn 4				
2	Winter 5				

Hand simulation of the system's response would begin with $Q = .1$. Calculations in each line from left to right should generate the numbers in Table 8.4 if carried out to two significant figures.

You may wish to continue your calculations on another sheet of paper until you have five years and plot the values for sunlight and quantity of plant matter.

A graph of the calculated quantities should show growth and then steady state like Model 4 (Figure 7.1a). The sun is a steady renewable source with a controlled flow. Consequently, the production of plant matter increases rapidly at first, but since animal consumption is a steady percentage of the available plant matter, the consumers start to increase faster until production and consumption are about equal. The growth is not smooth because of the up and down variation of the sunlight. The peak of plant growth is later than the peak of sunlight because there is a lag in building up storage.

We have already seen that one example of this kind of growth is ecological succession. Rapid plant growth on an open field changes to slower net growth of shrubs and then trees, to a steady state climax forest where trees and other producers are in balance with consumers.

Computer Simulation of Production and Consumption Model

The model in Figure 8.5 which was "hand simulated" in Table 8.4 may also be written for microcomputer simulation as given in Table 8.5. The programs are listed in the appendix, Table A.9.

Table 8.5. Computer program in BASIC for the P-R model in Figure 8.6. (Multiply results by 1000.)

```

10 Q = .1
20 K1 = .001
30 K2 = .2
40 N = 1
50 IF N = 1 THEN S = 5,000
60 IF N = 2 THEN S = 10,000
70 IF N = 3 THEN S = 15,000
80 IF N = 4 THEN S = 10,000
90 N = N + 1
100 IF N = 5 THEN N = 1
110 PRINT T, S, P, C, Q
120 P = K1*S
130 C = K2*Q
140 Q = Q + P - C
150 T = T + 1
200 IF T < 20 GOTO 50
    
```

Note: For the computer to use different values of sunlight, N is used to change values each season.

9. OSCILLATING SYSTEMS

So far we have considered systems that undergo a period of natural growth, after which they level off into a steady state. Succession is often considered with such models. However, many natural systems don't develop steady states. Instead of levelling off, they develop repeated oscillations. At any one time quantities are always changing up and down.

For example, oscillations are observed in arctic populations. When the plants get abundant, the small herbivorous mammals (lemmings) become abundant and eat the vegetation until it is scarce. After this the mammal population has to decrease until the plants regrow. Then the lemmings can become abundant again. Thus, the producers and consumers go up and down, each out of phase with the other.

Similar oscillations are observed in carnivore-herbivore relationships and host-parasite relationships. Examples are spruce trees and spruce budworms in Canada and week to week oscillations of phytoplankton and zooplankton in the sea. In economics there are oscillations by merchants building up their stocks of goods and consumers buying these stocks.

A Simple Oscillating Model

A simple example of an oscillating system is the prey-predator model in Figure 9.1. Pioneer

To cause the computer to plot graphs, substitute plot statements in place of statement 110. These are slightly different for each make of computer.

For the Apple, change to the following:

```

5 HGR: HCOLOR = 3
6 HPLLOT 0.0 TO 0,160 TO 279, 160 TO 279,0 TO 0,0
110 HPLLOT T/.07, 50- S/350
115 HPLLOT T/.07,160- Q/.5
200 IF T/.07<279 GOTO 50
    
```

For the IBM PC, change to the following:

```

5 SCREEN I,0: COLOR 0,0
6 LINE (0,0)-(320,180),1,B
110 PSET (T/.07, 50-S/350)
115 PSET (T/.07, 180-Q/.5)
200 IF T/.07<320 GOTO 50
    
```

To print out the graph from screen to paper, on IBM type the SHIFT key with the PRINT SCREEN key (Prt Sc). On Apple, there are various special programs and you need to consult the instruction manual. (Examples: Printographer and Beagle Brothers TRIPLEDUMP)

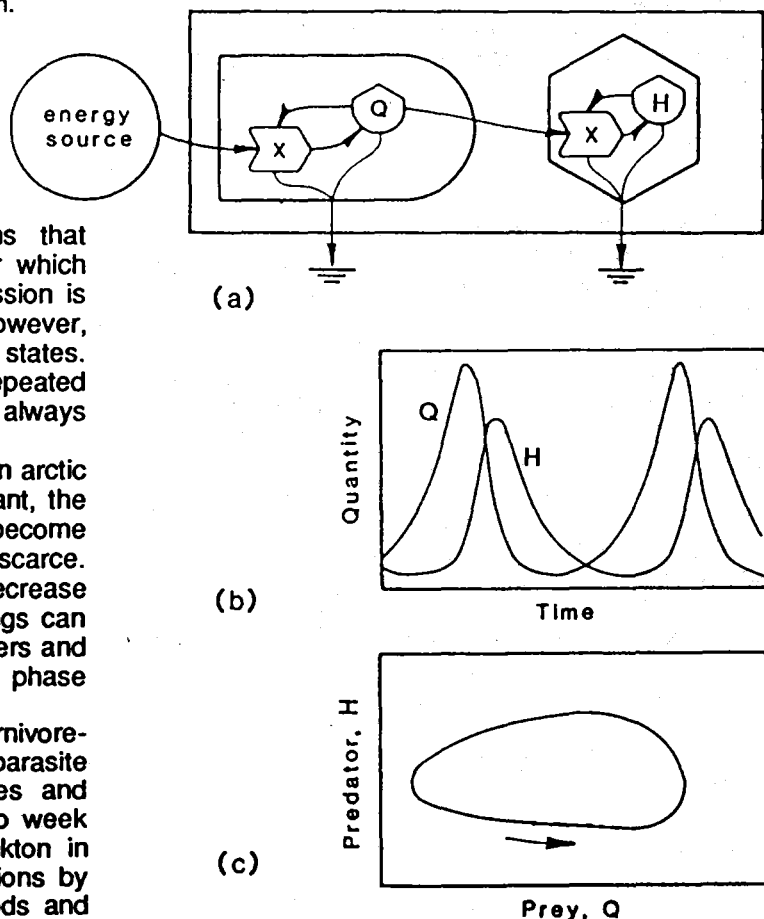

Figure 9.1. Simple oscillation model (a) model; (b) results of simulation; (c) same simulation as (b) on two population graph. (For program, see appendix, Table A.10.).

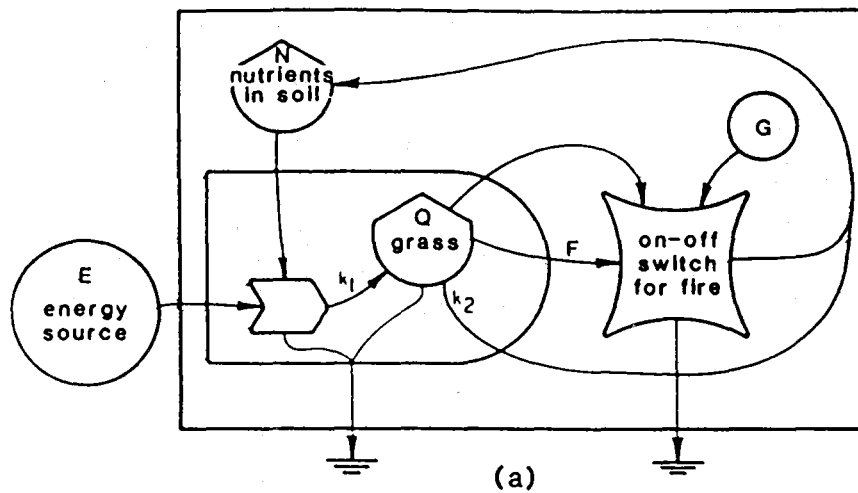
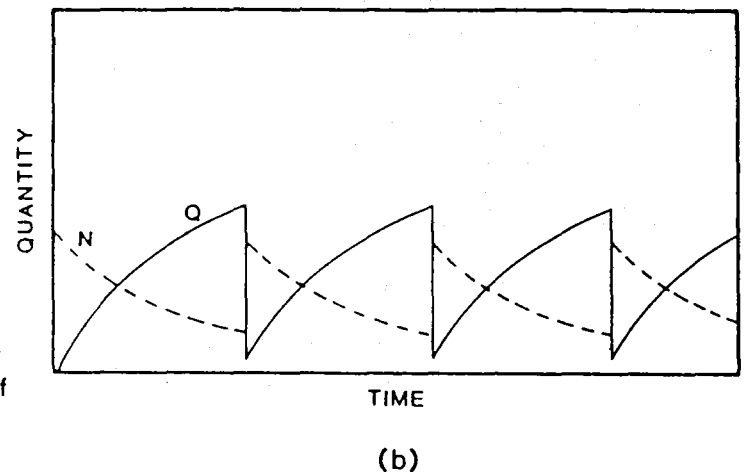

Figure 9.2. Switching model. Q, quantity of grass per m²; F, consumption by the fire; G, threshold amount of grass to turn fire on; N, nutrients in soil; P, proportion of grass that is nutrients; N₀, total nutrients in soil and in grass (N+P*Q); E, energy (for program, see appendix, Table A11).



mathematical ecologists who discovered the properties of this model suggested that these kind of relationships might account for oscillations of arctic animals.

As shown in the systems diagram Figure 9.1(a), there is a constant-pressure source available to the prey population. As the prey population starts to grow exponentially, the second population of predators grows so fast that the numbers of the prey population are reduced again. With less to eat the predator population declines again, etc. The graph of the two populations with time which this model produces is given in Figure 9.1(b).

The simple oscillating model does not have recycling. The time between oscillations changes depending on the P and C at the start -- not like real prey-predator oscillations.

The simulation program for a simple predator-prey oscillation is given in the appendix, Table A.10.

Two Population Plot

Instead of graphing the two populations with time as in Figure 9.1(b), we can plot a graph with quantity of one population on the horizontal axis and the quantity of the other population plotted on the vertical axis. The result is Figure 9.1(c). A circular line is traced as the oscillation proceeds. This way of graphing the population shows that the oscillation is periodic.

Switching Model

Another kind of oscillating model has the consumer action turned on by a switching pathway that turns on when the stock or products reaches a threshold. This model is shown in Figure 9.2(a) with a switching symbol. An example is the system of grassland and fire. When the biomass gets large enough and a flame is started by lightning or matches, consumption occurs by the fire. The organic matter is used up and many of the nutrients returned to the soil storage ready to stimulate more plant growth.

The pattern of grass and nutrients with time that results with this model is shown in Figure 9.2(b). Production is spread over a long period whereas consumption is an intense pulse for a short time.

In the simulation model of this system we represent the switching action with IF statements in BASIC to which the computer will respond:

```
80 IF Q > G THEN Q = Q - F
```

This means when the grass (Q) grows higher than the threshold (G), the fire turns on. The grass is burned down to a low biomass (Q - F). Then it starts to grow again.

The simulation program for the grass-fire model

Pulse Model

Figure 9.3 is an important model that has been found to apply to many parts of the biosphere including predators and prey. It has more than one consumer pathway. One of these operates at lower energy and one at higher energy turns on a frenzy of consumption. There is a quick pulse of consumption. Like the switching model, nutrients are recycled. Examples are the buildup of plants and epidemic consumption of locusts or forest insects which eat all the leaves suddenly. An

economic example is the buildup of a country's assets which are consumed by a conqueror.

A similar model explains the oscillating chemical reactions that generate pretty designs in the chemist's laboratory solutions. Oscillations in time have patterns in space. There is world-wide interest now in the idea that this kind of system is the way chemical reactions develop living structure.

The simulation program for the pulse model is given in the appendix, Table A.12.

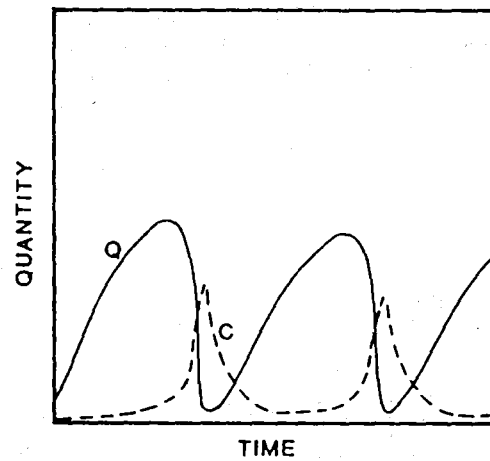
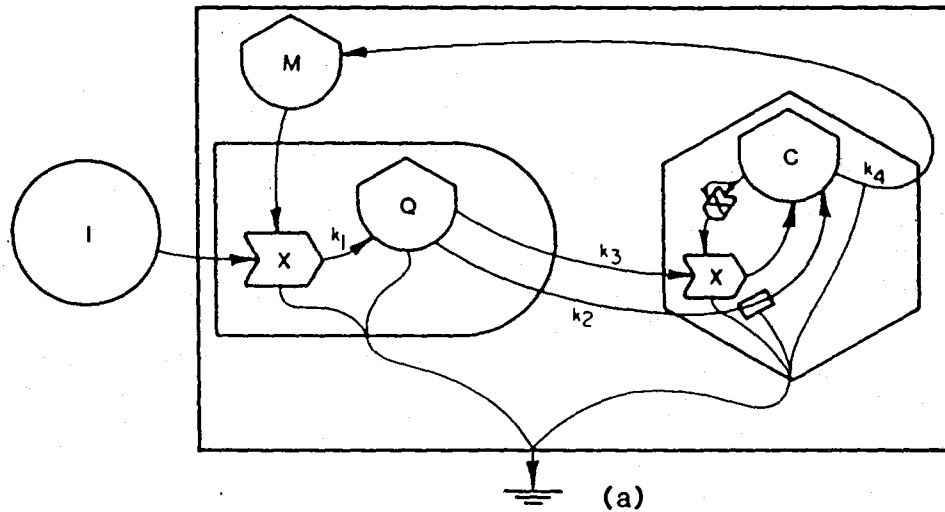

Figure 9.3. Pulse model. (a) Energy diagram; (b) simulation (for program, see appendix, Table A.12).

Spread Sheet Calculation

Another way to simulate models is to let the computer calculate iteration tables (like Table 8.4) using a "spreadsheet program" such as Lotus or Multiplan on the IBM PC, or Visicalc or Appleworks for the Apple II. These programs print out neat, labelled graphs of the results.

PART II. BIOMES

Wherever conditions are similar, ecosystems develop that are similar. A coral reef in the Indian Ocean is similar to one in the middle of the Pacific Ocean. Similar kinds of plants and animals are found even though none of the species may be exactly the same. Desert in Argentina has similarities to desert in similar climate zones of North America. A type of ecosystem is called a biome.

Figure II.1 has a simplified diagram of the main land biomes. Part (a) shows where each biome is found on a continent. Part (b) is a diagram of the main climatic zones of the earth. The climate zone determines which biome is there. Latitude and east-west position on a continent are major factors affecting rainfall and temperature.

There are always variations in local conditions within a biome. For example, within a northern coniferous forest there may be a low-lying area that fills with water to become a bog. This area will appear quite different from the forest that surrounds it. Different geological rocks affect soil formation, causing local differences. The boundaries between biomes blend together. There is usually a gradient as you move from one biome to another.

In some parts of the earth, different biomes can be found close to one another. High mountains are a good example, since different altitudes are subjected to different temperature and rainfall regimes. Going up mountains produces some of the same climate changes as going thousands of kilometres in latitude towards the poles. Consequently, in mountains, biomes from colder regions are found only a few kilometres from warmer biomes at lower altitude. You can go from

desert to taiga (coniferous forest) to tundra to polar-like conditions by simply going up the side of the mountain.

When a new ecosystem develops on bare ground or in a new pond, species move in and then are replaced by others. Usually, the ecosystem is simple at first, but becomes more complex as more organisms are added. The stages in this development are called succession. During succession there is usually growth in total biomass, growth of nutrients in storage, and an increase in the diversity of participating species.

After a time further growth stops. If the climatic conditions are little changed, the ecosystem may change very little. It tends to reproduce itself: organisms that die are replaced by ones of the same type. The ecosystem is then in a steady state. This stage is called a climax. The characteristics of mature ecosystems are diversity, a rich cycle of nutrients, large storages of organic matter, and a complex web of plant and animal life capable of using most of the sunlight and other local resources.

In many forest areas, cleared land left alone first grows weeds, then pine trees, and finally hardwoods (if fire is kept out). In many wetlands new disturbed land first grows weedy plants, new willows, and eventually climax wetland trees. By controlling available seeds and diversity, animals exert important controls on the process of succession.

During early succession, plants grow that produce much more organic matter than is consumed. Later, at climax, there are more consumers, and much of what is produced is consumed in the same year.

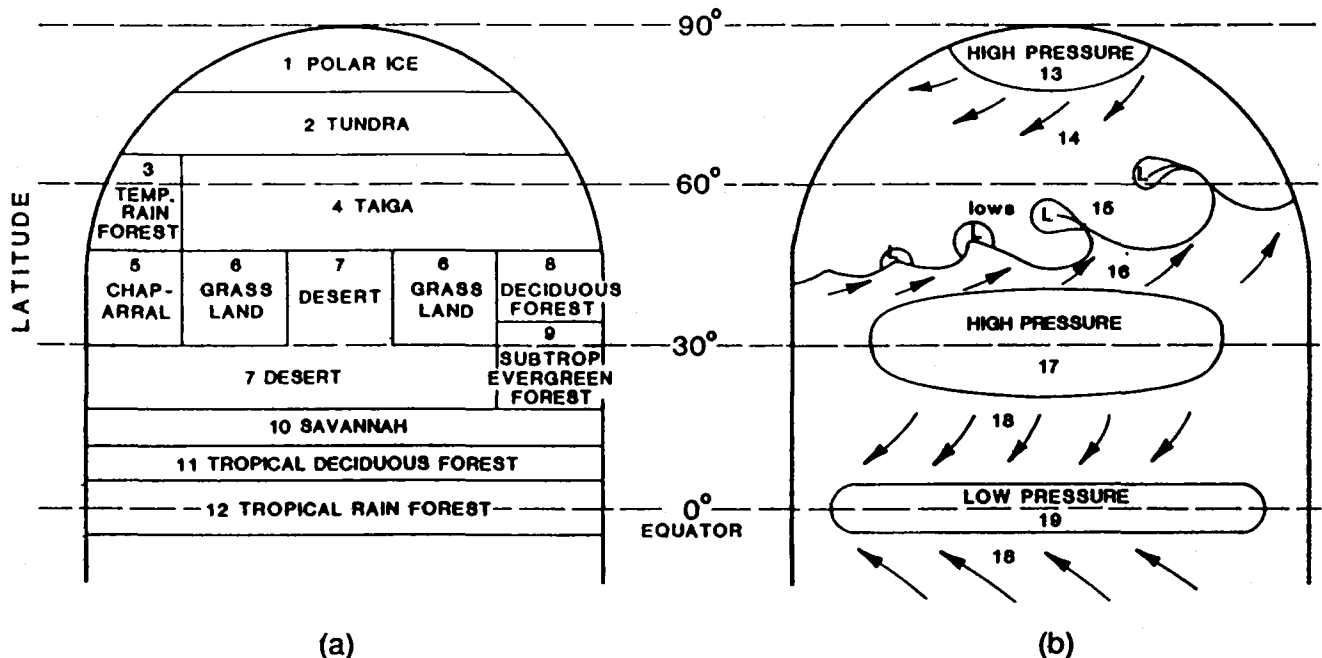

Figure II.1. (a) Distribution of biomes on a typical continent. (b) Zones of winds and rainfall in a typical hemisphere. 1. Ice; 2. Tundra; 3. Temperate Rain Forest; 4. Taiga; 5. Chaparral shrub forest; 6. Grassland; 7. Desert; 8. Deciduous forest; 9. Subtropical evergreen forest; 10. Savannah; 11. Tropical deciduous forest; 12. Tropical rain forest. 13. Polar high pressure and descending air with little snow; 14. Polar easterlies; 15. Zone of the polar front and cyclonic storms passing from west to east with heavy rains and snows; 16. Westerlies; 17. Subtropical high pressure and descending air with little rain; 18. Easterly trade winds; 19. Intertropical convergence zone, doldrum belt rains.

Each biome has characteristic stages of succession and characteristic patterns of climax. Examples and more discussion of succession and climax are given in Chapter 15.

Climax ecosystems are not permanent, because there are cycles in the climate which cause the biomes to change. For example, when ice ages come and go, the zones of climate that control the ecosystems come and go too. Also, there are cycles of renewal caused by oscillations in activity of the living organisms within the ecosystem. For example, grasslands build up vegetation stocks that are consumed by roving

herds of bison or by fire. Each biome has different patterns of oscillation (see models of oscillation in Chapter 9). After a climax is disturbed by an outside or inside factor, succession operates again.

Where conditions are similar in the oceans, similar ecosystems develop. Examples are pelagic blue waters, kelp beds, and salt marshes. Where human use of nature is similar, similar human-controlled ecosystems develop. Examples are forest plantations and agricultural systems, sometimes called agroecosystems. These are also included in Part II.

10. THE OCEAN

Seventy-one per cent of the earth's surface is ocean water. The ocean is important to the world, making rains, keeping temperatures suitable for life and supporting fisheries. Figure 10.1 shows the zones of the sea.

Figure 10.1 and 10.2 show the ocean floor. Each zone has an ecosystem with special organisms adapted to live there. Starting at the seashore on the left in Figure 10.1 going to the right there are dunes, the beach, the continental shelf, a reef, and the pelagic zone.

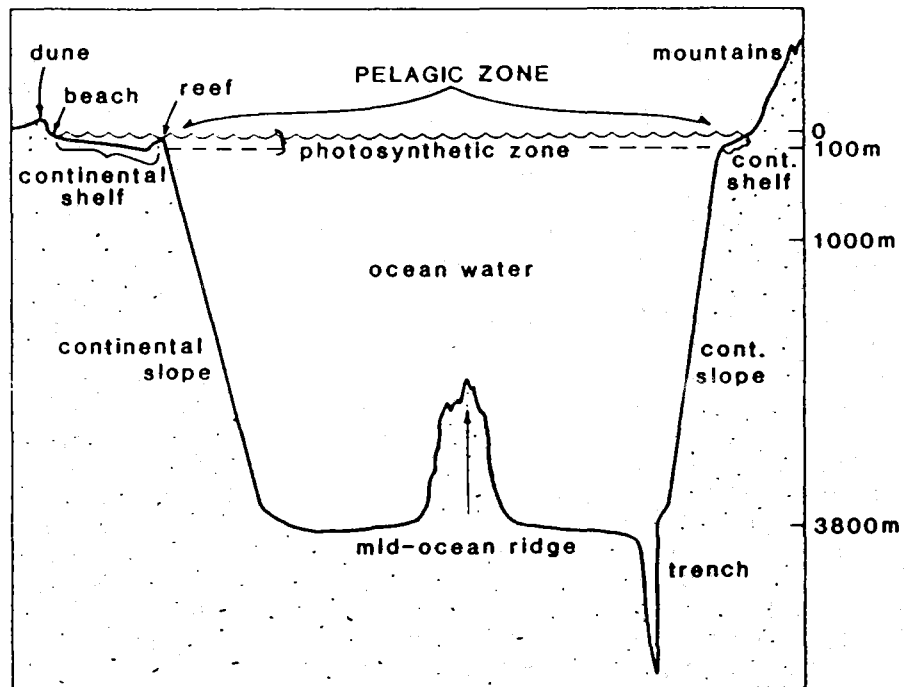
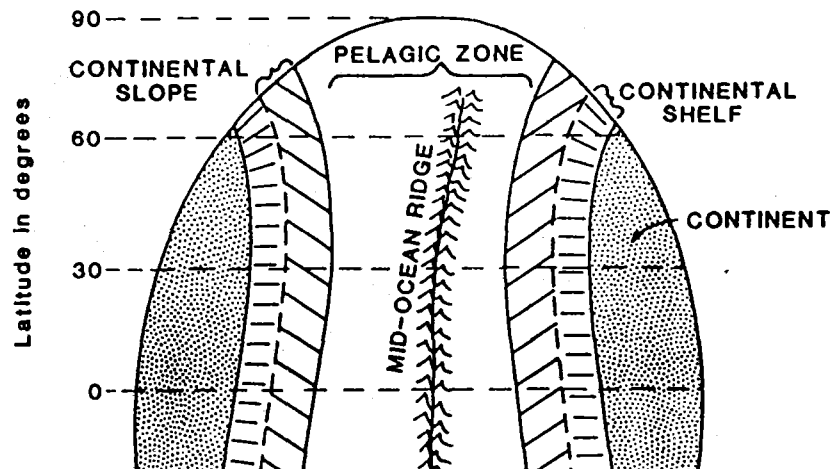

Figure 10.1. Zones in the ocean.



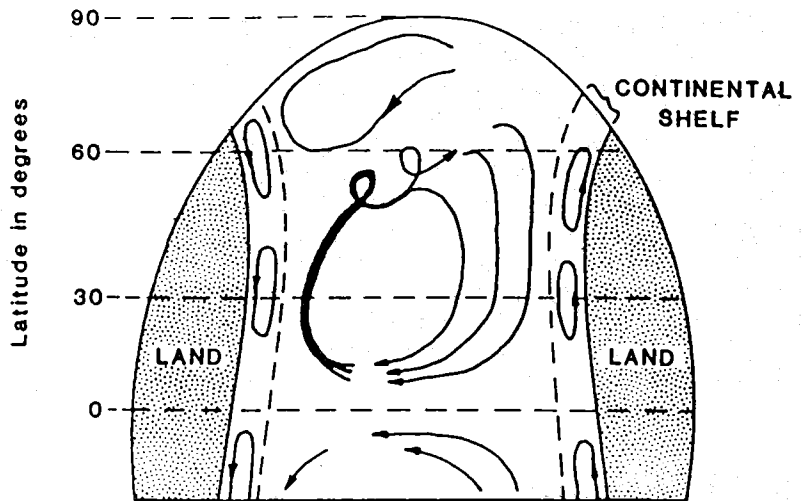

Figure 10.3. Ocean currents.

Pelagic Ecosystems

Pelagic or open ocean zone waters surround continents beyond the continental shelves where the sea bottom slopes steeply. Because of the purity of deep ocean in regard to particles, silt, and organic matter, light penetrates deeply. Plants can photosynthesize down to 100 meters. Only some blue light is scattered back to the surface. This causes the water to appear dark blue; from satellite the blue-water ocean seems almost black.

The water currents in the ocean are mainly driven by prevailing winds blowing on the water. The wind flows are shown in Figure 11.1b. The oceans' currents driven by these winds go in large circles as shown in Figure 10.3. The current on the western side of the ocean is very strong. An example is the Gulf Stream of the northwestern Atlantic, which flows 2 to 20 km per hour to the north (1-13 miles per hour).

Deeper down there is a counter-current with the deep bottom waters running backward toward the equator. These waters are very cold, near the freezing point of sea water (almost 2°C colder than the freezing point of fresh water).

The deeper waters of the blue-water ecosystem are rich in nutrients from past decomposition of organic matter. This matter was carried down by sinking, by animal migrations, and by downward water motions. Where this water moves upward, it

fertilizes surface plankton. This movement is called upwelling. Plankton are any organisms which are suspended in water and move with the currents.

Although life in the pelagic area is sparse, it is diverse and interesting. It consists of many kinds of tiny phytoplankton organisms and zooplankton that move up at night and down in the daytime. Many larger animals, including fishes, also move vertically as much as 800 meters in their daily cycle. These are aided by large turbulent eddies generated by the currents, the winds, waves, and tides.

These organisms reflect the sonar (sound waves) that boats use to show the bottom. These animals show up on sonar screens as a false bottom that goes up at night and down in daytime. See the scattering layer in Figure 10.4.

Food converges through the food chain to fast swimming fishes, including tuna and the very large game fish such as sailfishes and marlin.

The pelagic system has floating brown sargassum seaweed which forms rows parallel to the direction of the wind. Wind-driven waves cause eddies that move the floating sargassum along lines where water converges at the surface and turns downward. Many of the floating animals of this ecosystem are brilliant blue, like the man-of-war jellyfish.

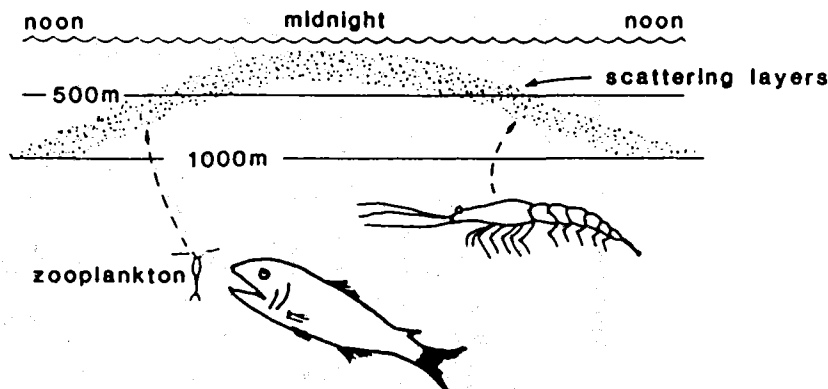

Figure 10.4. Daily migration of the scattering layer which includes plankton and larger animals.

Figure 10.5 is a diagram of an ocean ecosystem. The organization of the ecosystem has the same basic pattern as other systems. It has outside sources, producers, and consumers. However, in the ocean system turbulence is of special importance since it provides for both vertical and horizontal distribution of nutrients and gases. Turbulence is water with many circular eddies and changing currents. Winds and differences in water pressure keep the water constantly stirring. These energies are shown in the system diagram as a kinetic energy storage in the ocean system.

The diagram shows the flows from the turbulence to phytoplankton and zooplankton. Turbulence keeps the plankton in motion, helping supply their needs and bringing to the surface those that sink. Phytoplankton are the producers of the ocean system (diatoms, dinoflagellates and other microscopic algae). Zooplankton are suspended animals, most of which feed on the phytoplankton. They include many types of organisms from microscopic protozoa to jellyfish.

The ocean system diagram also illustrates the way in which circulation functions to provide nutrients. Materials lost from the ocean food web sink into deep water before decomposing. Later decomposition releases nutrients from organic matter. Upwelling sea water returns these lost nutrients to the surface where they stimulate the growth of phytoplankton, and hence, the whole

food chain. Such areas of upwelling water provide rich fishing grounds (see Figure 10.6).

Many of the small numbers of whales that now survive in our oceans depend upon swarms of tiny shrimp called krill for their food (Figure 10.7). Living off phytoplankton in fertile waters, krill develop in huge masses. Especially in arctic and antarctic waters, strong currents concentrate phytoplankton for the krill to eat. Normally, the energy passing through a good chain would require several intermediate steps to pass from organisms as small as krill to organisms as large as whales, but strong currents make fewer steps necessary.

Because of years of hunting by whaling ships, perhaps a tenth of the original whale populations remain and some species are endangered. Apparently other fishes, sea birds, and seals have been eating the unused krill. International treaties have now reduced whaling and some populations are beginning to recover.

Continental Shelf Ecosystems

The ecosystems of the continental shelves are not so deep as the blue-water ocean system. The shelf slopes from the shore down to 200 meters. The coastal waters are more influenced by the hot and cold winds from the land and by the sediments and nutrients in the runoff from shore. The deep zones of animals migrating up and down are

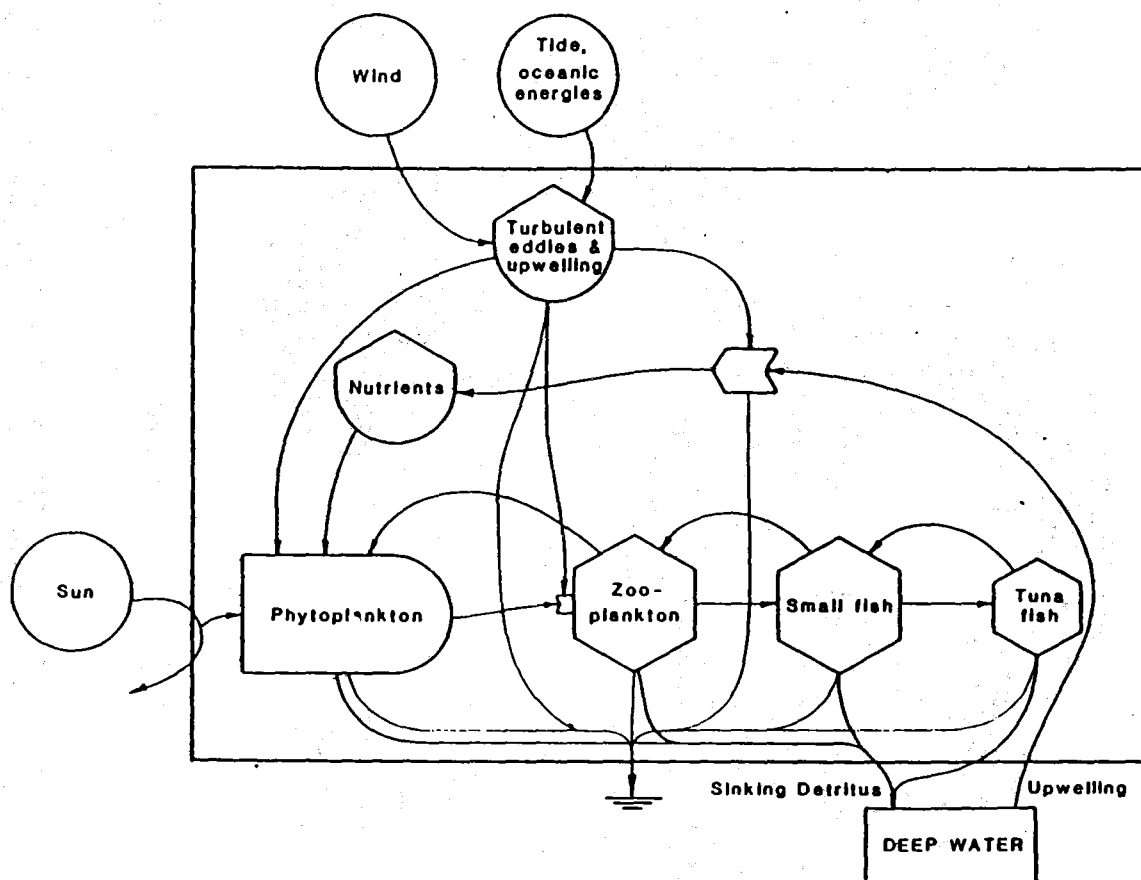

Figure 10.5

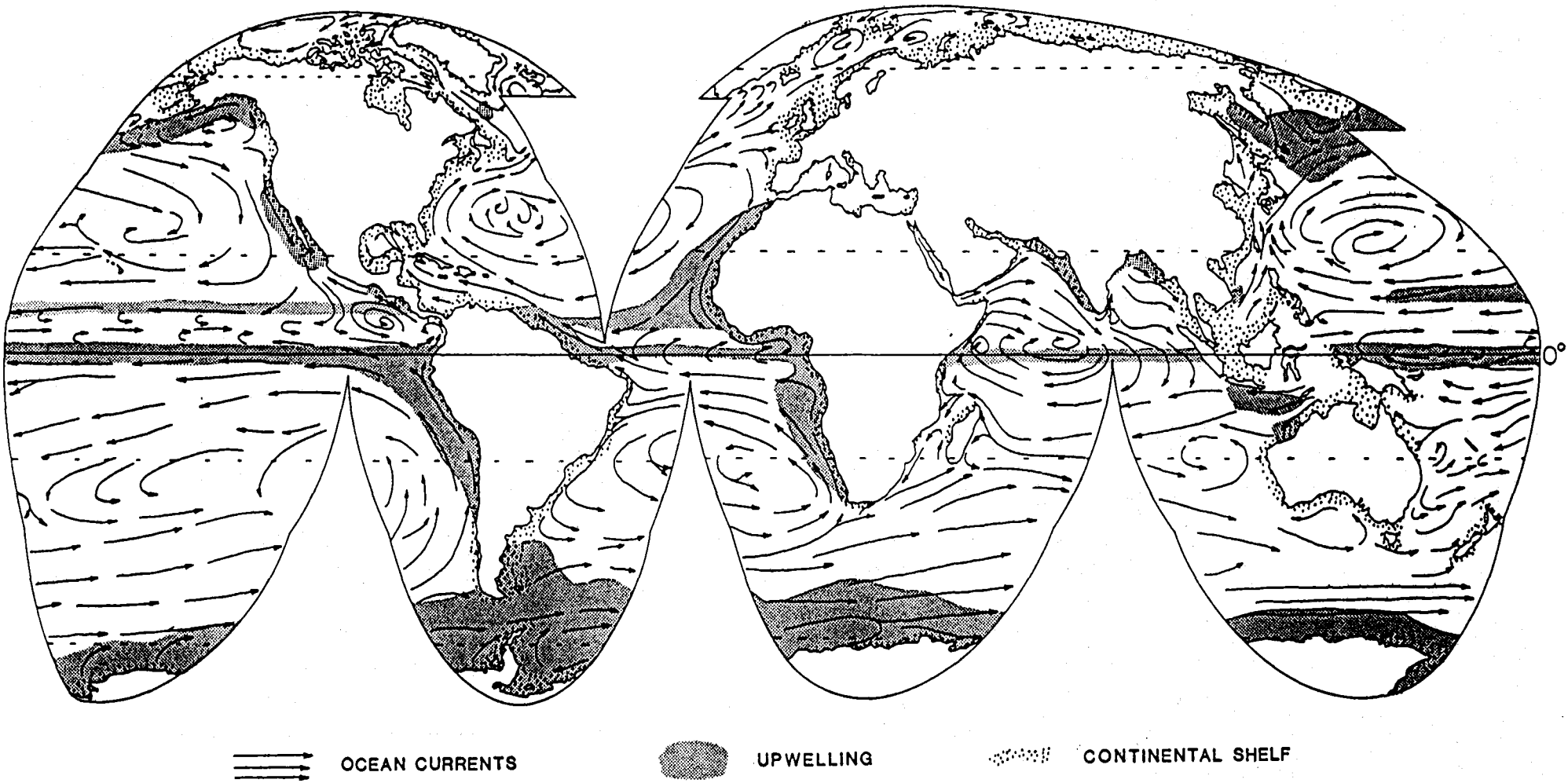

Figure 10.6. Currents, continental shelves and upwelling areas important to fisheries. Map from: Espensade, E.B., ed., *Goode's School Atlas*. (New York: Rand McNally, 1950). Ocean currents, upwellings and continental shelf summarized from: *Scientific American, Oceanography* (San Francisco: W.H. Freeman, 1971).

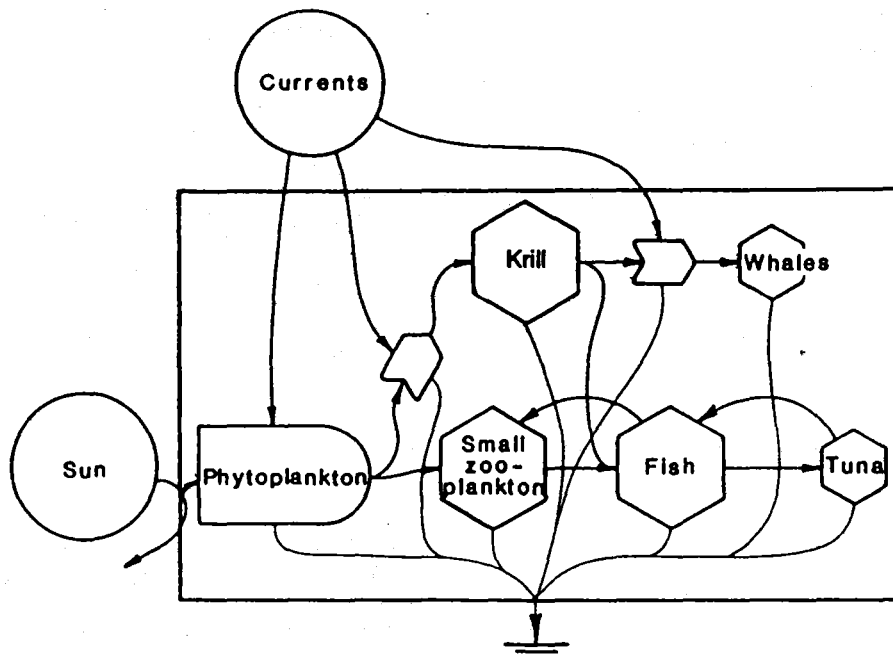

Figure 10.7. Whale and tuna food web showing the special role of currents. Where and how do people fit in this system?

replaced by many kinds of bottom animals that live within and above the muddy bottom. The continental shelf waters are more turbid and thus appear greener. They have more photosynthesis by phytoplankton.

Continental shelves also have circular currents. Partly these are driven by the rivers. As rivers flow into the sea they turn to the right because the earth is rotating in the opposite direction. This turning to the right is called the Coriolis force. In the southern hemisphere the Coriolis force is to the left because the earth's rotation of the landscape is opposite that in the northern hemisphere.

Populations of plankton, and larvae of important species (such as shrimp, crabs, and fishes) may remain in the same general area by moving in a circular pattern with the coastal waters over the shelf (see Figure 10.3)

Many of the shelf species, when they are ready to breed, migrate out to the open ocean where there are uniform conditions of salinity and temperature. Juvenile stages often move back and grow up in estuaries.

To make Figure 10.5 suitable for the shelf ecosystem, the deepwater box needs to be replaced with the bottom community or benthos. These animals receive a rain of fecal pellets, plant cells, and other organic matter from above. They filter this from the water or consume it by eating the mud. The actions of these animals and the microbes (that help consume the organic food) release the inorganic nutrients that the water eddies bring back to the surface phytoplankton.

It is sometimes suggested that if people harvested the sea more efficiently, it would produce much more food. This is exaggerated. Most of the open oceans have very few nutrients and sparse food webs.

High fertility is found in upwelling zones and on the continental shelves. Here detritus consumers

diverse food chains. Most of the world's commercial fishery products -- fish, crabs, lobsters and shellfish -- are caught on the continental shelves. These areas are heavily fished.

The tonnage of marine fish caught around the world showed a sharp rise in harvest from 1900 to 1970, after which growth was slower (Figure 10.8). Mechanical trawling devices and fish factory ships bring up so many fish that the numbers of some species have become seriously depleted. There were increased costs of fuels for boats and fewer areas that were not overfished.

Every renewable system which supplies energy needs controlling and recycling feedbacks if it is to survive. As seen in Figure 10.9, humans have been taking yield from the oceans, but have not been putting much back to replenish the system. However, even under the best management, the oceans cannot solve the food problems of our overpopulated world.

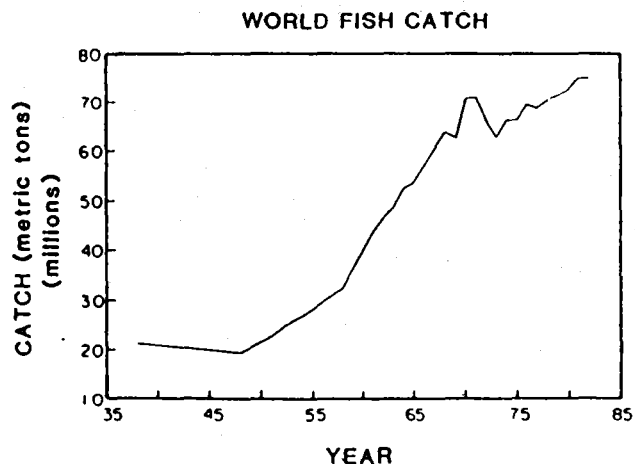

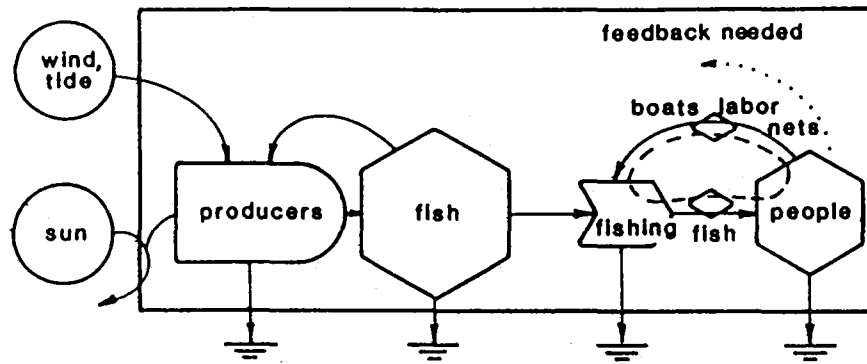

Figure 10.9. Fish yield from the sea with no feedback by people to the system.

Coral Reefs

Along shores and on the bottom of shallow warm seas above 20°C, where waves and currents are strong, coral reef ecosystems develop. A high diversity of plants and animals build platforms of limestone made of their skeletons. Most reef-building corals are colonial jellyfish that form limestone skeletons underneath their bodies. Red and green calcareous algae also form limestone skeletons which contribute to the reefs.

Corals get most of their food and energy for skeleton formation from the photosynthesis of symbiotic algae called *zooxanthellae*, which live in their tissues. They also capture small organisms with their stinging cells. After metabolism, the nutrients from the food are used by the zooxanthellae. The dense masses of life on reefs require strong currents and/or wave action to supply oxygen for respiration, nutrients for growth, carbonates for skeletons, and supplementary food.

Some of the features of the coral reef ecosystem are given in Figures 10.10 and 10.11. The main feature, the high diversity of colourful animals and plants, is hard to express on paper. There are many symbiotic relationships between reef animals. Even though there are many kinds of organisms on the reef (high diversity), there are not large populations of any one kind.

Although the temperatures and light regimes vary only slightly during the year, there are seasonal cycles in reproduction and life history. Sometimes there are surges of consumption and regrowth. For example, epidemics of the giant carnivorous starfish *Acanthaster*, consumes corals, leaving behind a reef of bare white coral heads.

The various corals, shellfishes, sponges, and algae attach to each other to form complex porous superstructures in which animals lives. On the shaded underside of the corals, the prevailing color is the dark red of the algae living there. Many coral reefs in the Atlantic Ocean, Mediterranean, and Red Sea are in small patches fringing the

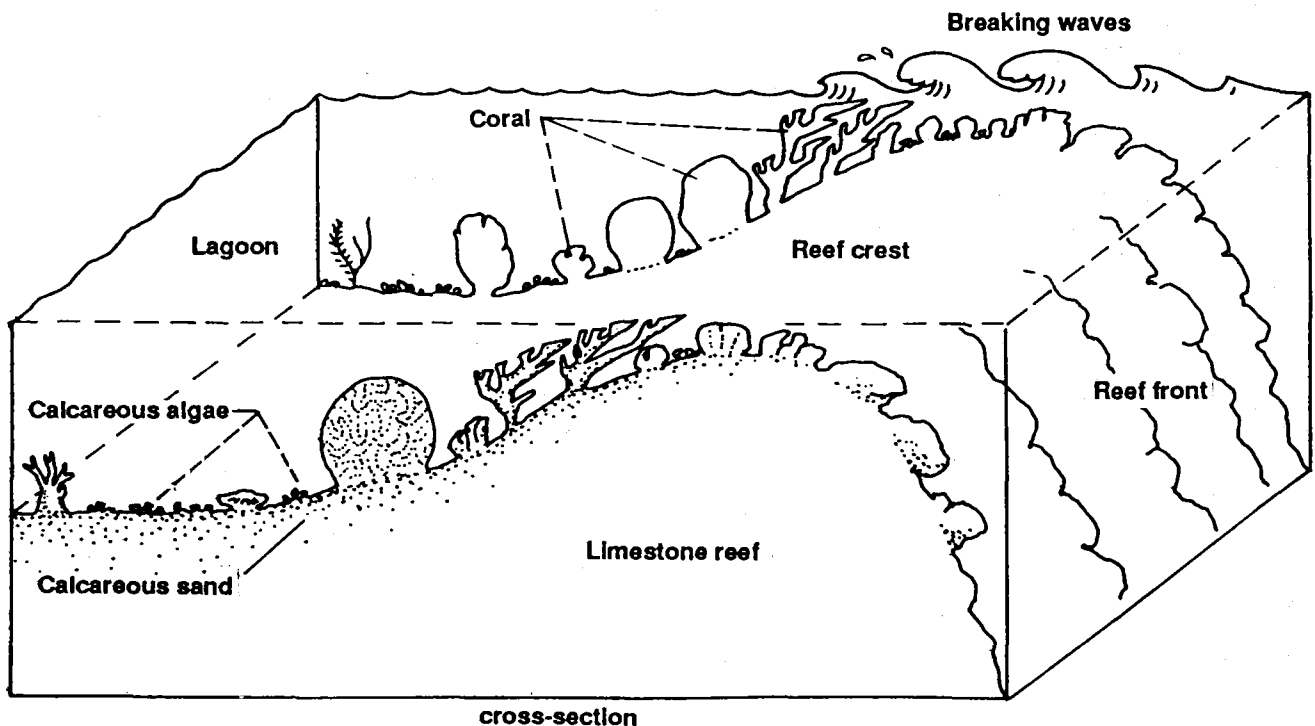

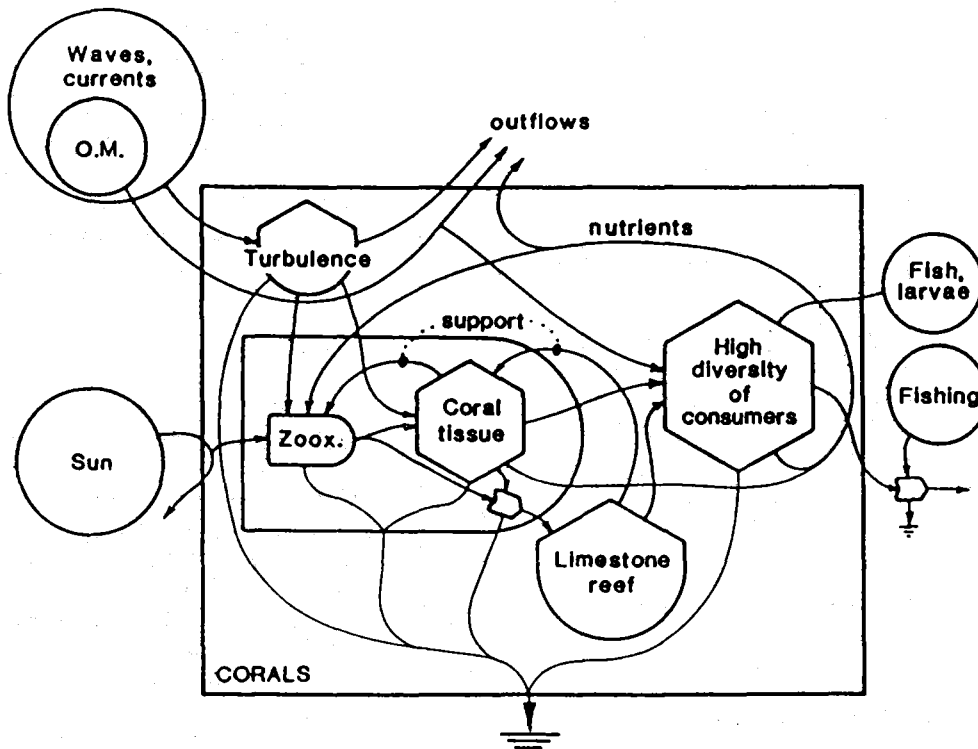

Figure 10.11. Coral reef ecosystem. O.M., organic matter.

shores. Patch reefs may be as small as 2 meters across.

In the Pacific and Indian Oceans particularly, giant massive structures, 20 km long and 0.5 km across, are built by the work of the corals over millions of years. These massive platforms form barrier reefs around land. A section of a reef platform is shown in Figure 10.10. Where the island around which the reef developed has eroded, giant ring-shaped active reef platforms remain called coral atolls.

Waves break over the coral platforms, driving water flow into the lagoon. Some water returns to the sea down the steep slope of the reef where it organizes a groove structure, with rows of the largest coral heads sheltering the largest carnivores.

When corals die, the limestone skeletons are soon invaded by free-living (non-symbiotic) algae. The reef structure is a rich source of food for consumers such as parrot fish, which scrape and swallow the living and dead coral. Sea cucumbers process reef fragments through their stomachs. Particles of organic matter (detritus) in the calcareous sands between the corals are consumed by crustaceans and small fish. Large carnivores are common on the reef, and include moray eels within the heads, and the barracuda and sharks at the edges of the reefs.

The species of fish, molluscs and crustaceans which humans find edible are vulnerable to overfishing, because although there are many kinds or organisms on the reef there are not large populations of any one kind. Many species are exposed because reefs are shallow and the water clear. For example, the spiny lobster is becoming depleted by divers and fishermen using traps. Maintaining the lobster populations depends on

water to drift many miles, and such depletion of adults can cause larval numbers to approach a critical minimum. International agreements may be necessary to keep such fisheries viable.

Kelp Beds

Along rocky shallow shores where waters are cold and there are large wave swells, kelp ecosystems develop. Kelp are giant, brown algae that are attached to the bottom, with broad fleshy blades that reach up to the surface. The kelp blades have gas-filled floats that keep the blades in the sunshine. Photosynthetic production is large. See Figures 10.12 and 10.13. There are many animals that are typical of the kelp ecosystem such as the kelp bass, abalones, and the sea otter. Sea urchins tend to cut the kelp loose causing oscillations in the system.

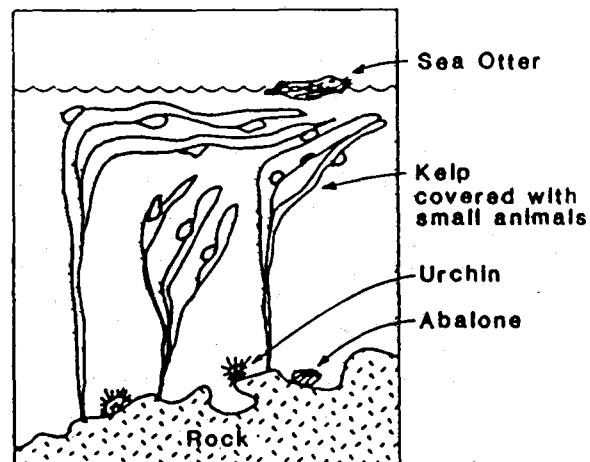

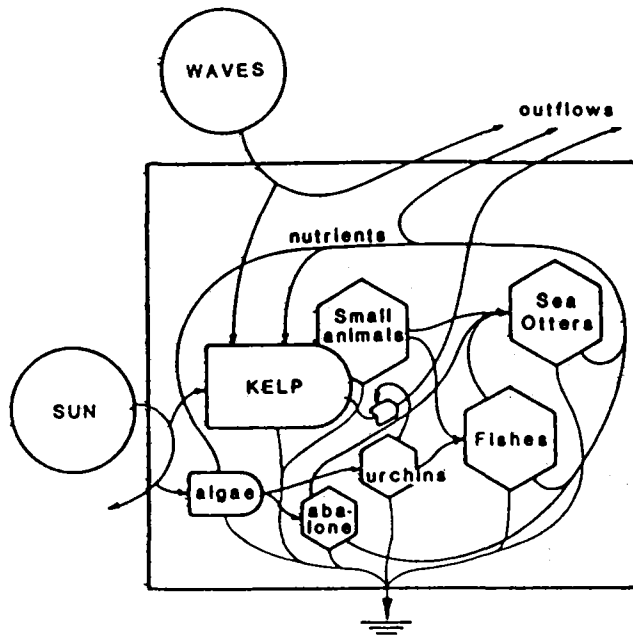

Figure 10.13. Kelp ecosystem.

Intertidal Encrusting Ecosystems on Rocks

Where rocks or other hard surfaces are found between high and low tide (the intertidal zone), a special ecosystem develops with attached organisms that can live for a few hours both in and out of water. The plants are tough, attached red and brown algae that are resistant to drying. Most of the animals have protective skeletons, such as barnacles, oysters, and mussels. The community of organisms is adapted to utilize the tidal currents and breaking waves which bring nutrients to the plants and food particles to the animals. Predatory fish are part of the system when tide is high.

Beaches

Beaches are generated and maintained when there is a supply of sand and regular wave energies to keep the beach organized and clean. Much of the sand that makes up beaches was brought along the coasts over millions of years by the longshore current. This current is generated in the surf zone by waves coming ashore at an angle. The waves send their energies in a current along the shore carrying sands in the direction of these breaking waves (see Figures 10.14 and 10.15).

The beach is an excellent filter. Each breaking wave pours water through the sand so that when it comes out it has been filtered. The beach filter is a little like the filter of gravel used in sewage plants. The spaces between the grains contain tiny animals and microbes that consume the organic matter and release nutrients to the water.

At the high-tide margins floating debris collects in drift lines. This debris includes sargassum, seaweed, sticks and logs (that have come out to sea from rivers), and all kinds of human trash. Tiny jumping crustaceans called beach hoppers live in these drift lines.

The waves maintain the beach shape according

waves make the beach coarser because the fine sands are washed away.

In this century there has been a general rise in the world sea level of 30 cm (nearly a foot). Some structures built near the sea have been threatened as the sea moved further onshore. To keep the sand, rock jetties were built. The effect is to eliminate the normal inflow of new sand from the longshore currents, causing further erosion of the beach.

Sand Dune Ecosystems

Further landward from the beaches in undisturbed areas, sand dunes occur. They are sand hills built up from the blowing beach sand. The succession of a sand dune follows the same steps as studied earlier. Pioneer plants, such as the grasses and sea oats, grow first. Their seeds are easily carried by birds and small mammals. These tall grasses catch the sand carried by the wind. Their long fibrous roots reach down to the ground water that collects from rain percolating through the very porous sand grains.

Enough fresh water collects in the dunes to support small communities of people and animals. Because fresh water is less dense than salt water, the fresh water floats on the salt water and keeps out the salt water from below. For every foot of fresh water above sea level in the dune, there are 40 feet of fresh water below sea level. When too much fresh water is pumped out, the salt water can flow up from the sides and below. This ruins the dunes as freshwater supplies.

Where the dunes have not been disturbed for many years, a maritime forest develops. The spray from sea storms tends to kill the leaves. But the forest develops a tight canopy so that the leaves underneath are protected from salt spray. This vegetation makes the coast stable and secure against storms.

If the vegetation is removed and the dunes are bulldozed level, the sand starts to move with the

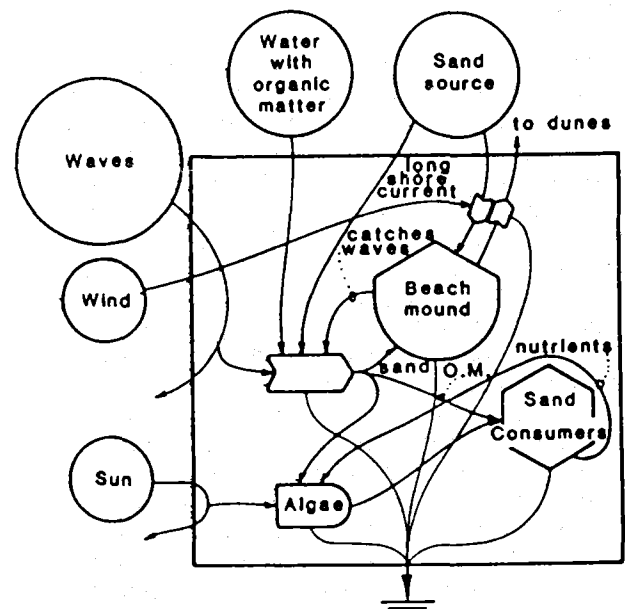

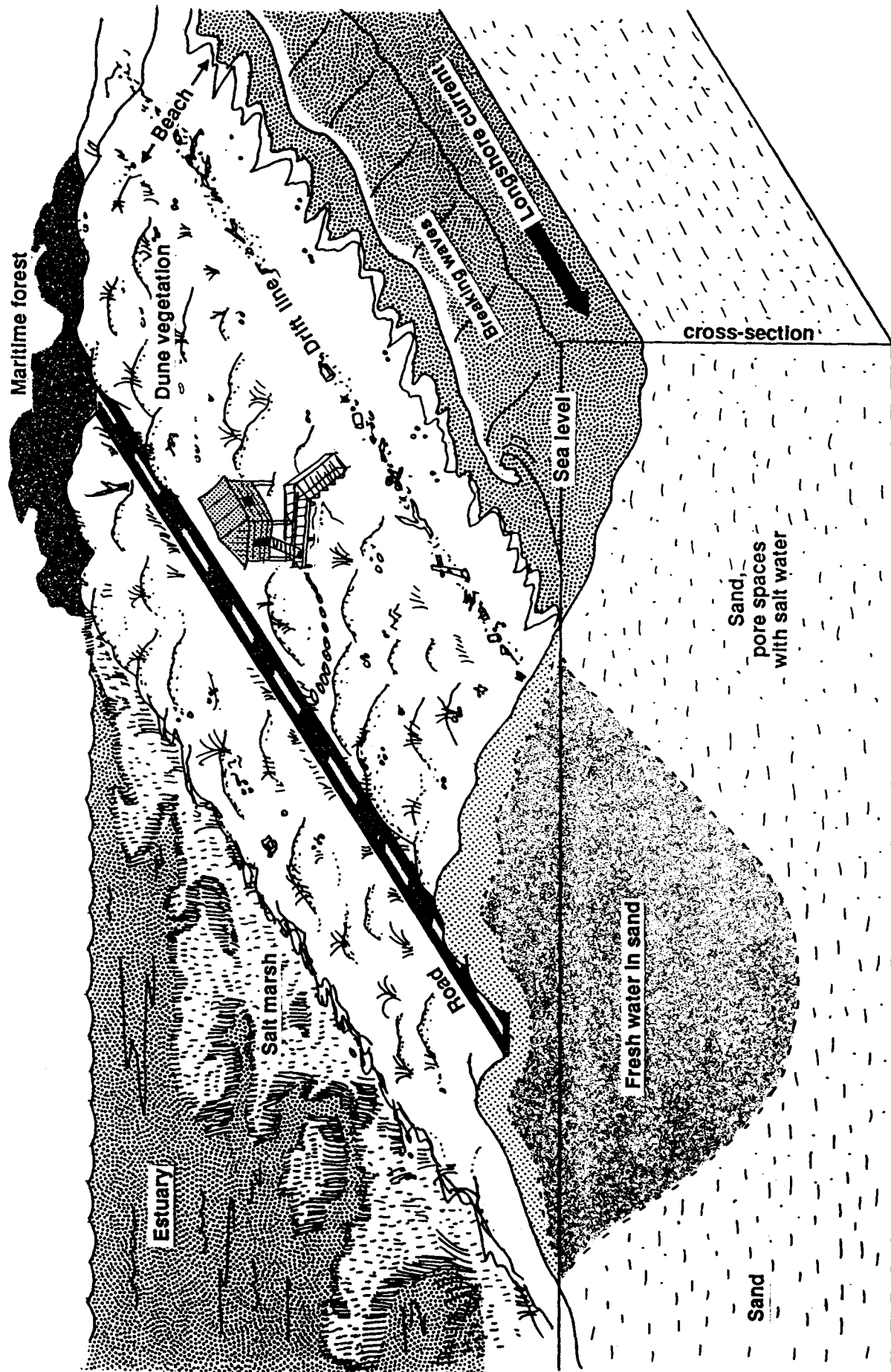

Figure 10.15. Zones in a typical beach.

wind and becomes unstable. The protection against seawater breakthrough in hurricanes is removed. The dunes and beaches must be able to adjust to the rise and fall of the sea, to storms, and to reformation that keeps the system healthy. The beach zone should be a broad one free from paving and exotic kinds of vegetation for this to

happen. Houses should be built on pilings so the sands can move under them. Since the dune plants are not very resistant to vehicles, dune buggies should be kept out. The natural vegetation makes a beautiful surrounding and it is a good habitat for many animals.

11. ESTUARIES

An estuary is the area along the coast where a river joins the sea. It is the area where fresh water and salt water mix. Estuaries are often edged with wetlands: marshes with salt-tolerant grasses or swamps with mangrove trees standing in water much of the day. The estuary is rich in energy and nutrients and has large numbers of plants and animals. This richness is due, in part, to the special inflows of fresh water from the rivers, and salt waters of the ocean. See Figure 3.2.

Typical Estuarine System

The outside energy sources of the estuarine system are the fresh waters of the rivers, and the salt waters of the ocean coming in with the tides. The estuary receives kinetic energy as the tides flow in, mix with the river waters, and flow out. Waves from the blowing wind increase the mixing of fresh and salt water. This increases the kinetic energy of the estuary. The kinetic energy increases productivity of the estuary by circulating the nutrients, food, plankton, and larvae.

Estuaries have a burst of productivity in spring and a high rate of growth in summer. Most commercial species of oysters and crabs are

primarily estuarine. Several kinds of commercially important shrimp live and spawn as adults offshore, and come into the estuaries as larvae. Shad breed in headwater streams and have young that pass through the estuary on their way to the sea, growing rapidly during their time in the estuary. Because the larvae of many marine species mature in the estuary, it is often referred to as a nursery. An estuary is usually edged with marshes, a wetland with salt-tolerant grasses standing in water part of the day. Many invertebrates live in the marsh mud. The marsh offers excellent protection for larvae and small fish which come in and out with the tides.

Figure 11.1 is a more detailed diagram. The role of kinetic energy is shown. The phytoplankton cells are kept suspended by the motion, which also helps plant photosynthesis by bringing nutrients like carbon dioxide, nitrogen and phosphorus to them. Thus, the kinetic energy helps the recycle process. The stirring also keeps particles of organic matter in suspension and moves them with currents to be captured by the filter-feeding animals on the bottom.

Tides and rivers also bring into the ecosystem nutrients, carbon dioxide, detritus, zooplankton,

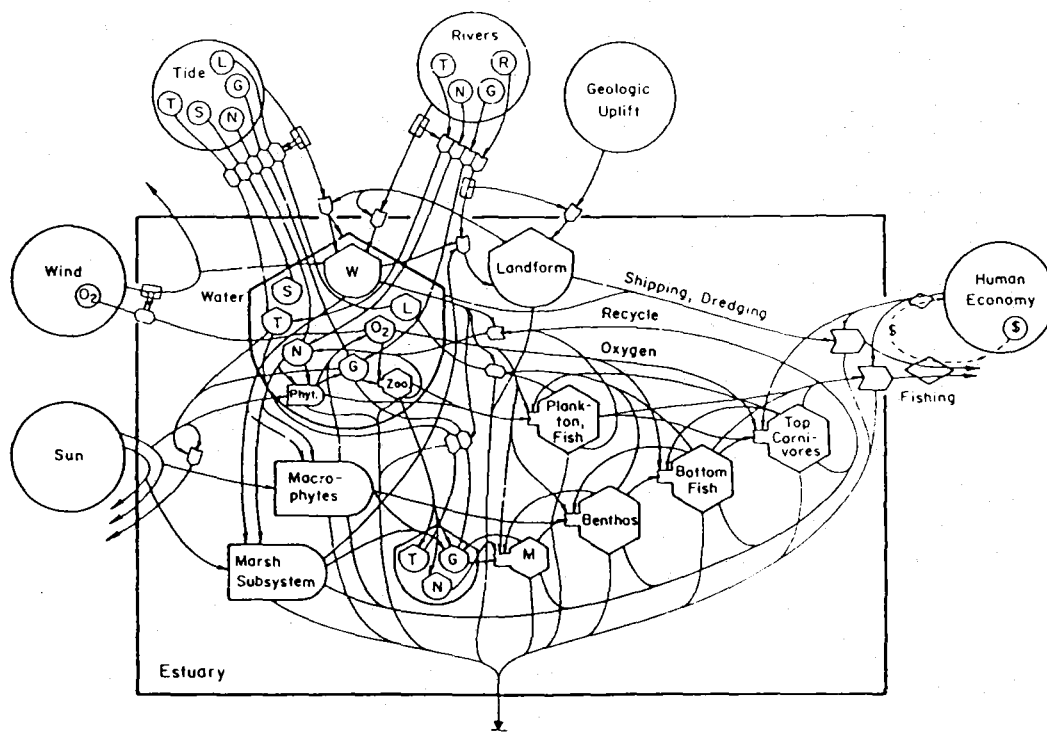

Figure 11.1. Overview model of an estuary. G, organic matter in water; L, larvae; M, microbes; N, nutrients including CO₂; O, oxygen; R, sand and gravel; S, salt; T, clay turbidity (inorganic); W, waves, current energy and turbulence.

fish, and eggs and larvae of various animals. The seeding of new species is the means by which the ecosystems can develop more complexity.

Zooplankton are found throughout the water column at night, but tend to sink to dark lower parts of the ecosystem during the day. They eat the phytoplankton and organic matter and in turn are eaten by small fish -- particularly fish of the herring group, including sardines, anchovies, shad and menhaden; these eat phytoplankton as well.

Dead organic matter and the micro-organisms which consume it form a rich detritus on which many benthic organisms feed. These include a wide variety of worms, molluscs, crustaceans and bottom fish such as flatfish, cod, and drum. Benthic carnivores, including crabs, shrimp and fish, are often harvested by humans.

The role of government is to control fishing by regulation and licenses. The rules switch fishing off and on.

Many species of birds are part of the estuarine ecosystem. Gulls feed on animals in the estuarine mud and on the beach at low tide. Wading birds, such as herons, willets, and rails, feed in the marshes, and diving birds, such as pelicans and cormorants, feed in the water.

Some estuarine organisms are specially adapted to withstand the constant variations in salinity. They must survive salinities from 0 ppt (parts per thousand) salt in the fresh water to 36 ppt salt in the ocean water, and all the salinities in between. Because energy must be used for special adaptations to varying salinities rather than for diversity, there are fewer species in an estuary than in rivers or the open sea. But because fertility is high, there is high production in the few species present.

On the right of the diagram is fishing by people. Boats are shown receiving inputs from the economy, in the form of fuels, goods and services

for their maintenance. Human services are used in the fishing process also. Money is part of this ecologic-economic system, brought in from the sale of fish and used to buy fuels, goods and services.

Oyster Reefs

Oysters attach to each other, building up mounds of shells. As bottom oysters die, larvae attach to old shells, increasing the size of the reef. As the mounds build up, the oysters have increased access to currents which bring in food and carry away wastes. Industries which harvest oysters help maintain the size of the reefs by putting the empty shells back into the reef environment. This is an example of one part of the fishing industry feeding back to the natural system.

Figure 11.2 shows how the tides and rivers cause currents and bring in inorganic nutrients and organic matter. The interaction of the currents and the organic matter produces a flow of food to the adult oysters. The adult oysters make the shell reef, where the larvae attach and grow to adult oysters. The oyster populations are kept down by predation, disease and harvesting. Drills are snails that drill through the shell of the oyster, eating the insides. Drills increase in numbers when the salinity of the reef is fairly constant. When the fresh water flow causes great variations in salinity, drill populations are reduced.

Commercial oyster reefs have high productivity. Diversity and competition are kept low by the constantly fluctuating salinities. Other commercial habitats are in the intertidal zone where the alternating exposure to air keeps other species out. However, intertidal oyster reefs cannot filter-feed when the tide is low. This prevents these types of reefs from growing as rapidly as estuarine reefs in deeper water.

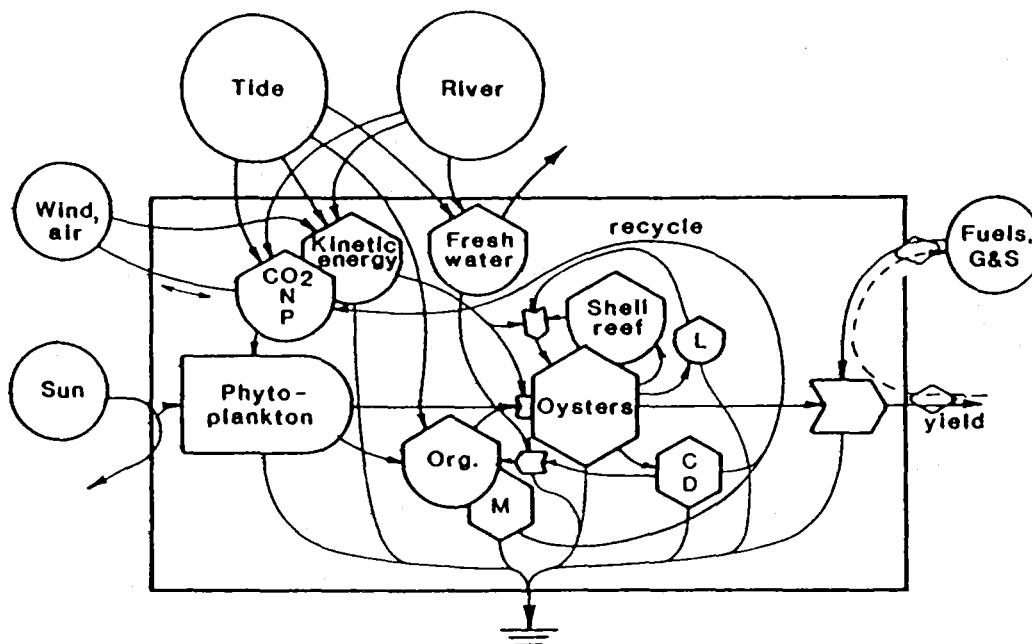

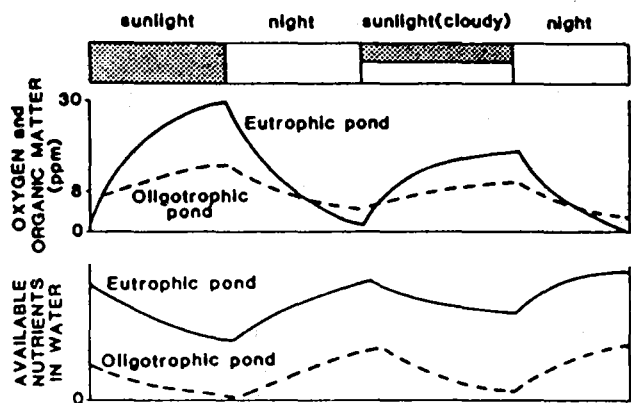

Figure 12.3. Changes in oxygen, organic matter and nutrients in an oligotrophic pond (dashed lines) and an eutrophic pond (solid lines) through day and night. Data for oxygen variation from 0 ppm to 30 ppm.

and Asiatic milfoil, spread wherever the nutrient conditions are extreme. These have been regarded as pests. They block the movements of boats and interfere with fishing and other recreational uses. In deeper water the organic matter accumulations get so heavy that in cloudy weather too much oxygen is used up and there are fish kills.

Attempts to remove the plants have not been very successful. Adding herbicides puts decomposing plant matter in the bottom of the pond. The decomposers release nutrients and stimulate the regrowth of the same plants. Poisoning also disrupts many other aspects of the ecosystem. Adding plant-eating fish also accelerates the cycle to regenerate the nutrients and plants again.

The best solution is "simple" -- keep the extra nutrients out of navigational and recreational waters. As fertilizer gets more and more expensive, there will be more efficient use and less waste. More efforts will be made to conserve and recycle nutrients. Eventually most of the sewage and agricultural waste waters will be recycled to fertilize forests, crops, and pastures.

A method of catching these nutrients has been developed using natural wetlands such as marshes and swamps. By arranging these wetlands between the wastewaters and lakes and rivers, the nutrients can be filtered out to grow swamp trees or maintain greenbelts and wildlife areas.

Oligotrophic ponds still exist where the drainage of water includes only rain water or runoff from nutrient-poor sandy soils. Although their fertility is not so great and their growth rates are low, the variety and diversity of life is large. These lakes are surrounded with grass and rushes and tend to be clear. They make excellent recreational areas.

Streams

In the flowing water of streams, the food web starts with the algae and with debris (sticks, leaves, dead insects, etc.) from the land. Nutrients

also used directly by microbes. Many streams draining rocky or sandy areas are oligotrophic. They can become eutrophic if they receive enough nutrients from mineral deposits, sewage, or pasture runoff. Organic debris from the land is an important source of stream detritus. Some detritus is decomposed by microbes, and some flows on downstream. The land debris contribution is especially important in small, woodland streams where the water surface is shaded and algal populations are small. In these streams, organic detritus is the primary support for the rest of the food chain.

Freshwater insects spend most of their lives in the water as larvae. For example, when mayflies mature, they fly in a large swarm over the water. After mating, the females lay their eggs in the water. Insect larvae feed on the organic slime of detritus and microbes, and may be eaten by carnivorous fish.

Some fish, like mullet, tarpon, and eels, reproduce in the sea and move into the freshwater streams. Other fish like shad and salmon travel in the reverse direction. They reproduce upstream and their young then move to the sea where they live most of their lives before returning upstream for reproduction.

There are many kinds of streams: Blackwater swamp streams drain bogs (wetlands receiving mainly rainwater), bays (bay tree bogs), and upland swamp regions. These waters contain rainwater plus the decomposing organic matter from peaty swamps. Generally these have soft water (they are acidic and do not have much calcium carbonate that comes from limestone). The organic matter from swamps is the product of leaves and wood which decompose very slowly. Although the stream may be brown or black, it does not have life-threatening losses of oxygen because the decomposition is so slow. The oxygen in these streams remains at about half-saturation. It is a balance between the amount used in decomposition and the amount diffusing in from the air. This oxygen level is quite adequate for food chains of tropical areas where animals are adapted to live in water with more than about 2 parts per million dissolved oxygen.

In mountain streams turbulence and rocks are very important. See Figure 12.4. Geological uplift forms mountains from which rocks fall and are worked into the streams. The rocks interact with the flowing water. The force of rushing water erodes rocks down into fine sediment.

Animals and plants are adapted so that they can either withstand or avoid turbulence. Thus, the principal producers in the stream are algae which grow in a slime on the surface of the rocks. Mountain streams are too swift and rocky for many rooted plants. Insect larvae live under the stream's rocks for protection from predators and from the turbulence. The rocks and banks channel the flowing water downstream. Carbon dioxide, oxygen, and nutrients mix in with the water and are used by the aquatic organisms.

Small fish live in calm sections of the stream where they live on microbes and insect larvae. Small trout use the mountain streams as nurseries before migrating to rivers. Eels live near the

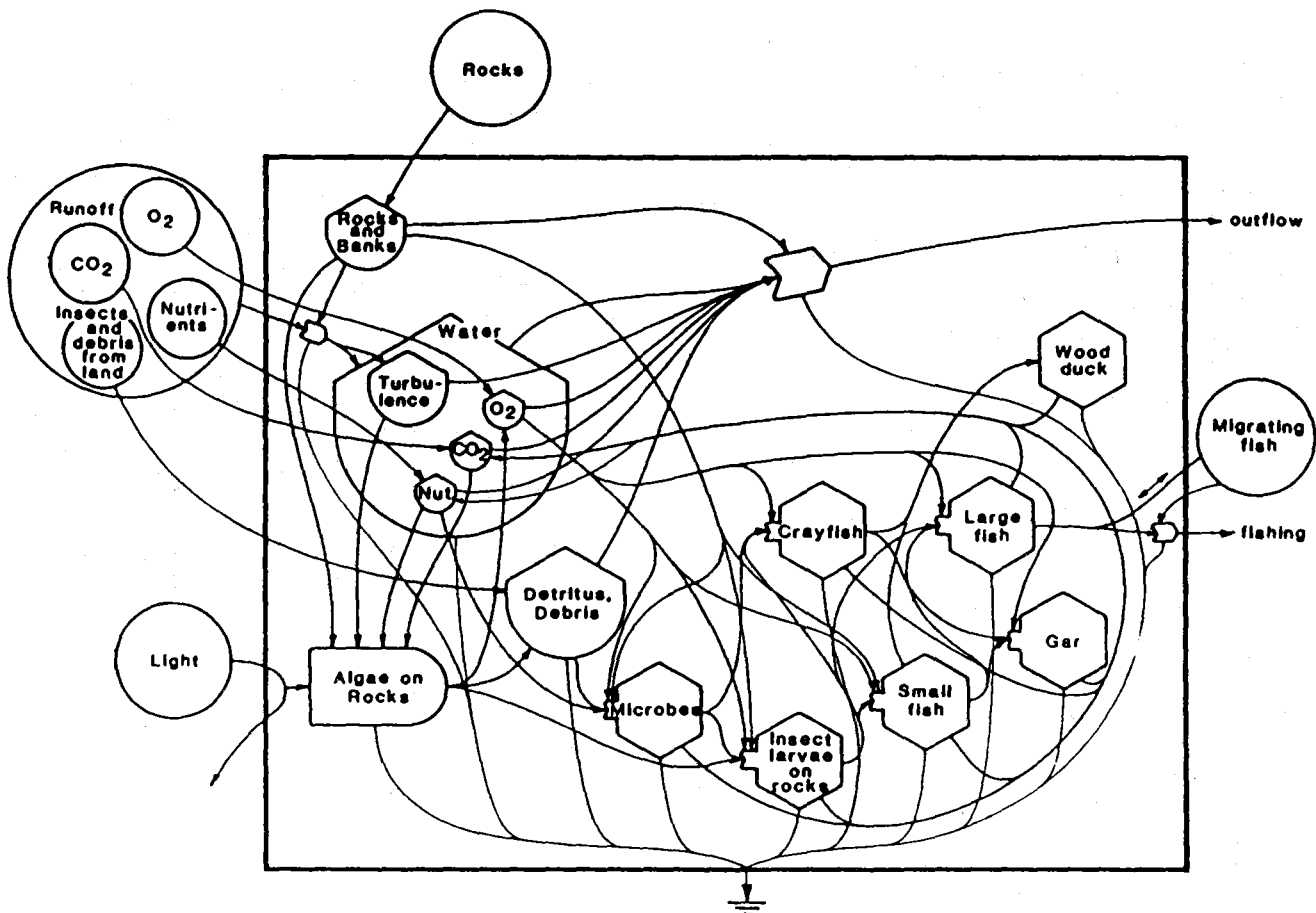

Figure 12.4. Diagram of a rock-filled mountain stream.

competing with trout for insect larvae.

When waters reach the lowlands their velocity decreases and sediments are deposited. A flood plain develops which can grow wetland plants.

Turbid sediment-loaded streams occur where rivers drain areas of clay soils. The rivers tend to become turbid with suspended clay, often yellow at times of high runoff. Generally the fishes of these rivers are adapted to the turbidity. Where the river waters slow down the sediment deposits add to the fertility of local soils.

Tidal rivers flow into the sea and receive the effects of the tide in their lower reaches. The salt water from the sea does not go very far up the river but does form a layer of salty bottom water for several miles over which the river flows. These rivers flow with a rhythmic pulse, slowing their flow when the tide at the mouth is high and then rushing out when the tide is low.

Springs

Some rivers receive a preponderance of spring waters and are very clear and favorite places for scuba diving and other aquatic-based recreation.

Some of the water that percolates through porous sandy, limestone or basalt rock areas goes into the ground water. It may emerge as large-volume, clear hardwater springs. These flowing waters have moderate levels of nitrates and phosphates. Since the water is clear, light penetration is good, and very productive streams develop with algae, rooted plants, insect larvae, and fishes. As the streams flow several miles, they pick up detritus and dissolved organic matter, eventually becoming like other streams. These streams are important as water supplies, recreation spots, and tourist attractions.

Other springs have different chemical components. Some come out of the ground without oxygen and support ecosystems of interesting blue-green algae and white sulfur bacteria. These springs have small populations of fish that can gulp air from the surface, keeping bubbles in their throats.

13. WETLANDS

Wetlands are areas intermittently flooded. The vegetation which predominates is different from that in unflooded areas. When soils become water-logged, the access to atmospheric oxygen is restricted and ordinary roots are no longer adapted.

Wetland plants have evolved special adaptations. Some such as mangroves, transmit air down to their roots through special tubes in their stems. Others, such as black gum, carry out their respiratory process in the soils which are anaerobic (without air). They make an unoxidized byproduct that is transported up the trunk to be oxidized there as oxygen enters. Cypress trees grow special roots above ground, called knees, through which some carbon dioxide and oxygen are exchanged.

Characteristics of Wetlands

Grassy wetlands are called marshes and those with trees and shrubs are called swamps. There are many kinds of wetlands with many kinds of vegetation. The time of flooding (called the hydroperiod), the depth of flooding, and the nutrients available determine the type of vegetation.

There are many controversies about land use and whether to keep swamps and marshes.

Surprisingly, many swamps conserve water, especially those which are on flat uplands receiving mainly rainwaters. Although wetland

plants must transpire water vapor from their tissues into the wind, some transpire less than others. Therefore, less water is lost from these swamps than from open lake surfaces. Adaptations of these plants help keep their areas wet and conserve water. More of the water may percolate down into the ground waters or go downstream. Efforts to drain swamps to save water are misguided.

Because wetlands receive water from higher ground, they act as natural filters that absorb nutrients, turbidities, and pathological microbes. Recent studies show that waste waters may be added to marshes and swamps so that they will provide natural water treatment. Growth of useful products such as wood and peat are fostered, and millions of dollars in technological treatment costs are saved. Some areas have had this type of wastewater disposal for 40 years or more, but we are only now understanding how well this system works.

Because energies must go into various special adaptations for life in wetlands, the diversity of wetland plant species is less than in ordinary forests. The variety of insects, birds, and other animals may be higher.

Freshwater Swamps

Figure 13.1 shows the main features of a swamp ecosystem. Compare it with Figure 15.1, the diagram for an upland forest. Some features

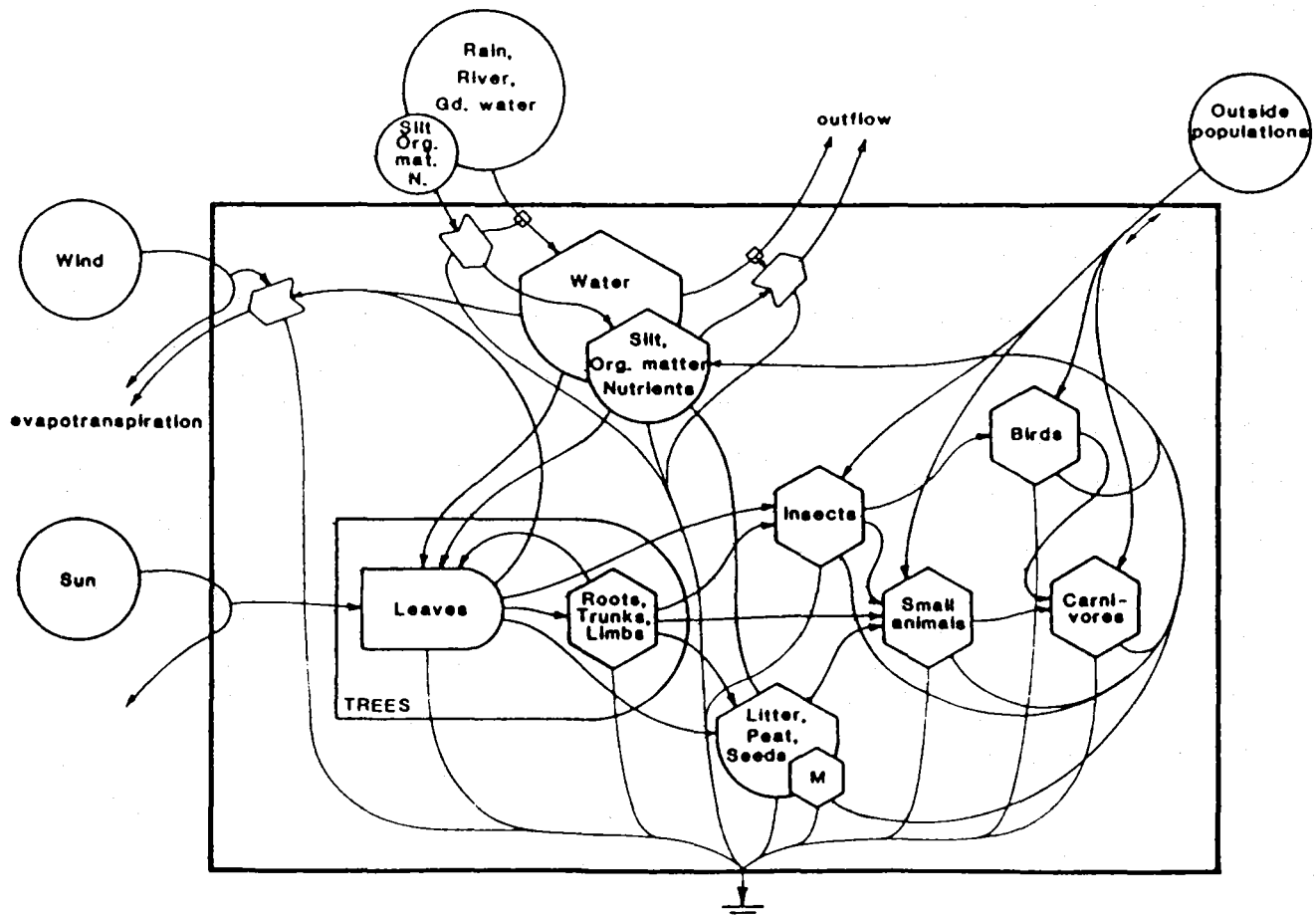

are similar such as leaves, stems, roots, litter, gas exchanges with the wind-driven air, and insects and birds. The role of water is different in the swamp where it causes sediments and peat to store nutrients and other substances.

Saltmarshes and Mangrove Swamps

Coastal wetlands that are covered with salt water part of the time have characteristic vegetation. In areas that have freezing in winter, salt marsh plants predominate. In more tropical areas without frost, saltwater wetlands develop mangrove swamps.

Figure 13.2 shows the main features of a saltwater wetland. Water runs in from rivers and tides move salt water in and out. The tidal exchange also exchanges fish, plankton, and larval stages of animals with open waters. The tide tends to carry organic matter, pollutants, and sediments. Tidal energy interacting with the plants makes a network of channels for the water flow.

Marsh plants and mangrove trees have special ways to obtain fresh water from the salt water that bathes their roots. Some use the sun's energy to transpire water, and the pull within the stems draws water into the roots, leaving some salt behind. Other plants use their photosynthetic products as energy to secrete salt from the leaves. Such plants have leaves that taste salty. With energy going into salt adaptations, there is less diversity.

The evaporation of the water and transpiration

by the plants leaves salt behind in the soil, where it is washed out by the exchange of tide and river water. However, if salt accumulates, plants are dwarfed or die. In Figure 13.2 the stress of the salt is shown killing plants to produce dead grass and a buildup of peat. Small particles of dead plants plus organic matter which flows in with the river and tides are food for the filter-feeding clams and oysters. Larger particles are food for crabs, snails, and worms

Saltwater marshes, with various species of grasses, are found along all coasts where there is quiet water without rough waves. Below about 30 degrees latitude where there is no killing frost, mangrove swamps also grow. Mangrove trees have prop roots to hold the trees up in the water and wet soil. New plants developing from seeds float until they attach to soil.

Where marshes and mangrove swamps receive mineral nutrients, they tend to grow faster and lose organic matter to the estuaries. In other situations they may receive water containing organic matter from land runoff. Consumption of the organic matter returns mineral nutrients to the estuaries. In these ways the plants and trees serve as a buffer, tending to keep a balance of nutrients and organic matter in the waters around them.

Coastal wetland vegetation helps reduce erosion during floods and hurricane tides. Plants and trees act as barriers, helping reduce the damage done by high winds. Wetlands are also important as greenbelts and wildlife refuges. They provide nesting areas for mammals and birds.

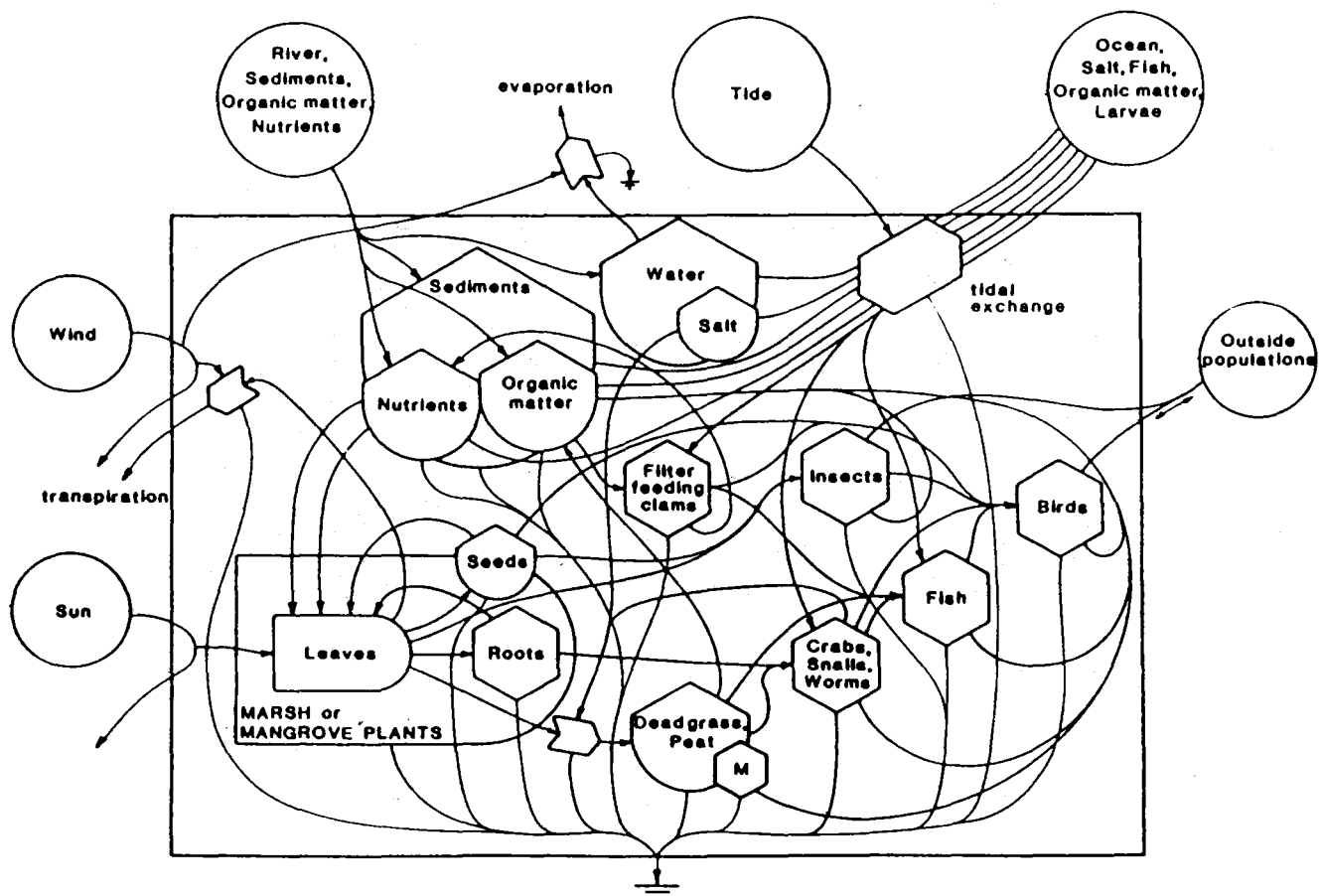

Figure 13.2. Salt water wetland ecosystem where tidal exchanges play an important role.

14. COLD BIOMES

Each biome has developed as an adaptation to one of the climatic zones; climates, in turn, result from the way the world's wind and ocean current systems are organized. Figure 14.1 (left) shows the locations of the main terrestrial biomes of the world and (right) the main weather zones that produce these climates.

High pressure zones at the poles are accompanied by sinking air that heats by compression, dissolving clouds. As a result, skies are often clear and outgoing heat radiation makes the ground very cold. Over the North Pole, the ocean stays frozen, but the ice packs move around. Over the South Pole, there is enough snow to maintain a permanent snow-ice cover. In places like Greenland, Iceland, and the mountains of Alaska and Chile, there are permanent glaciers: although these areas are some distance from the poles, the polar front brings them large amounts of snow.

At the cold polar ends of the continents are several distinctive biomes. There is polar ice on both poles. Toward the equator, summers are just long enough that the upper soils melt and develop some ground vegetation. This is the tundra biome. Less tundra is found in the southern hemisphere because there is less land mass at that latitude.

Still further from the poles, the ground remains unfrozen and the polar front produces rain and snow seasonally, resulting in development of a forest biome of scattered trees. The forest closest to the north pole is an evergreen forest of conifer trees, such as spruce and fir, called taiga. Similar

kinds of ecosystems are found in regions of the earth where mountains are high enough to have the low temperatures and conditions of ice and snow.

Polar Ice

Simple ecosystems are found on permanent ice fields. Algae develop on top of old snow where nutrients tend to concentrate as snow and ice evaporate. Some of these are brilliant red.

There are active marine ecosystems in the waters below the ice. A diverse ecosystem of algae and small consumers lives on the underside of the ice. This system uses the light that penetrates the ice in the summer season for energy. The waters flowing under the ice also carry organic matter which is produced elsewhere. This supplies food for large populations of fishes. Many marine mammals live on the fish. Seals, killer whales and polar bears are at the top of the polar ice food chain.

Tundra

Just south of the polar ice, where the surface briefly melts, the tundra develops. This ecosystem is characterized by a carpet of mosses and lichens interspersed with herbs and low shrubs. During the summer about 10-15 cm of the ground thaws. The soil below the thaw-level stays frozen and is called permafrost. The alternate freezing and thawing of the surface soil makes a slow cycle

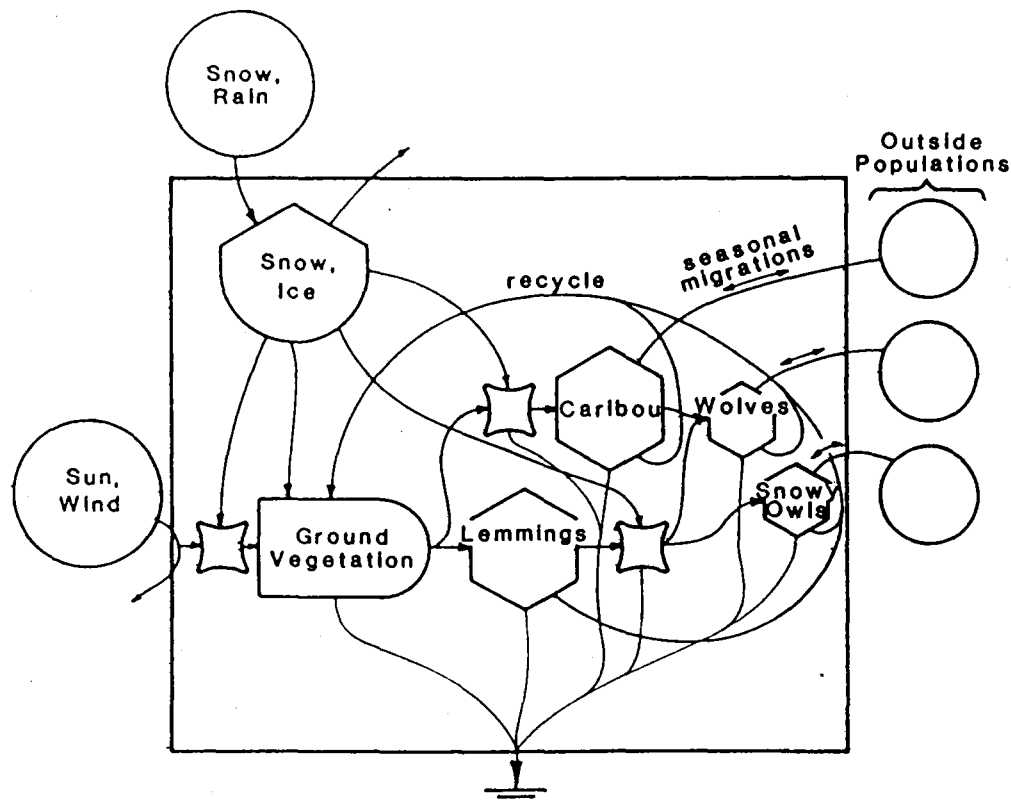

Figure 14.1. Tundra ecosystem. Snow cover has a switching action which turns off access of vegetation to sun, caribou

during which the soil is pushed up and pulled back down again. This movement of the soil helps cycle nutrients.

During the short summer the sun is in the sky almost 24 hours each day. This means that plants can carry on photosynthesis most of the time. Large amounts of photosynthetic products are produced and stored during the short growing season. Large quantities of organic materials accumulate and are able to support consumers.

The lemming, a small rodent, is able to thrive in this harsh environment by burrowing under the snow and eating this accumulated plant material. The lemming supports higher order consumers such as snowy owls, foxes, and wolves. See Figure 14.1.

Before the snow covers the ground plants, the caribou migrate south followed by the wolves. The snowy owls and many other birds also migrate. In years when their food is scarce, carnivores migrate further south.

This ecosystem exhibits the oscillations discussed in Chapter 9. As the vegetation increases the number of lemmings also increases. The number of consumers which eat them also increases. Then the lemming population rapidly decreases as their food source is reduced. However, the rate at which they are preyed upon remains the same. With fewer lemmings, the food available for each lemming is greater and the population starts to increase again. This particular cycle takes seven to ten years.

Taiga

South of the tundra in the northern hemisphere is a cold forest biome. This area has longer summers and more species of plants and animals than the tundra. While the tundra has only low

lying plants as producers, the taiga is an evergreen forest. Evergreen conifers are adapted to this area and can continue to photosynthesize even when the temperature drops below freezing. This forest is able to support populations of larger animals. Rabbits, deer, elk and rodents are able to use the products of the forest and to maintain large populations. These populations are able to support a wide variety of carnivores. Common in these areas are lynx, puma, wolverines, bears and a variety of raptors, such as falcons and eagles. Interspersed within the taiga forest are numerous ponds in low-lying areas left by retreating glaciers thousands of years ago. The aquatic weeds in these lakes and ponds are important in supporting the abundant waterfowl which migrate here in the summer. These ponds also support the largest member of the deer family, the moose.

In the southern hemisphere there is a cold forest, mainly evergreen, that resembles the northern taiga. Here, beech trees with tiny leaves substitute for the spruce and fir trees of the northern forests.

High Mountain Ecosystems

Below the ice fields, on the top of high mountains, the Alpine tundra is found. Below the Alpine tundra is the timberline and a forest similar to the taiga forest. The ice, tundra, and first forest below the timberline on high mountains are comparable to the polar ecosystems, but there are important differences. These high mountain ecosystems usually have a longer summer and smaller extremes in temperature. The plants above the timberline are small and adapted to freezing during the night and thawing during the day. In the tropics this zone of beautiful plants is called paramo.

15. TEMPERATE FOREST BIOMES

Several types of forests develop in the middle latitudes when these regions receive adequate rain. These forests may be either deciduous or evergreen. The type of forest that develops depends upon the amount of rainfall and the climate of the area.

Temperate Deciduous Forest

A temperate deciduous forest develops in areas that have cold winters and a long growing season in the summer. There are four distinct seasons in these areas. The plants and animals found there are adapted to these changes. In deciduous forests the dominant trees drop their leaves in the fall of the year. In these forests there is a great diversity of understory plants (woody shrubs, herbaceous plants, and seedlings) as well as many types of broadleaved trees. See Figure 15.1.

Deciduous forests produce an abundance of leaves, fruits, nuts, and seeds which provide food for a great variety of animals in the summer. When the days become shorter and the

temperatures drop in autumn the leaves of deciduous trees change color. This color change is caused by the plants reabsorbing the chlorophyll from the leaves so that the leaves now appear red, yellow, and orange. In winter the dead leaves become litter under the snow and the trees stand barren. Many of the birds migrate to warmer climates. Many small animals hibernate and others develop heavy coats to withstand the cold. The forest in the spring responds to the longer days and the milder temperatures. The trees use nutrients stored the previous summer to produce new leaves and flowers. Migrating birds return to nest, and the insect population becomes active and increases rapidly.

Temperate deciduous forests develop in areas where the average annual rainfall is 75-150 cm (30-60 inches) a year and is evenly distributed. This distribution of rainfall allows a complete decomposition of organic matter and gradual return of nutrients to the soil. The soils of these forests are rich in humus that forms from the decayed leaves. The rich brown soil formed by

these forests causes them to be excellent regions for human habitation. Much of Europe was once covered by deciduous forests. It is now covered by farms and cities. Deciduous forests were also found all over the eastern United States and in parts of Japan and Australia.

The trees of the deciduous forest show the differences in their seasonal photosynthetic rate in the annual rings they form. These trees are able to maximize the use of the sunlight available during the spring and summer, to store food in their roots and underground stems, and to conserve water during the winter. The trees of these forests grow in layers or strata. Beech, maple, oak, sycamore, and hickory are very common in the canopy of deciduous forests. These are generally the tallest trees and are the ones able to reseed themselves. A diverse understory also develops that contains herbs and shrubs, as well as shorter trees like dogwoods. On the forest floor there are often ferns, mosses, herbs and seedlings.

Forest animals must be adapted to the seasonal change in temperature and in food supply. Deciduous forests support a large number of herbivores because they provide many leaves, buds, and seeds. Some common mammals found in a northern deciduous forest are deer, squirrels, mice, and foxes. Before human intervention there were also lynx, bears, and wolves. Many varieties of insects and spiders are also found in great numbers.

Chapparal

The temperate shrubland called chaparral or maquis, develops in the middle latitudes on the

west side of continents. These areas have winter rains and dry summers. This type of climate is found along the coast of the Mediterranean Sea and in South America, Australia, and the western U.S.

The characteristic long dry periods that occur every summer make the area subject to fire. Fire is a very important factor in keeping the chaparral as shrubs rather than tall trees. The trees that are found in these regions have leathery leaves and are generally less than 3 metres tall. Scrub and trees are found in the California chaparral. Eucalyptus is native to the Australian chaparral. Trees and plants are adapted to minimize their water losses in the summer.

Many animals found in the chaparral are migratory and live in the area only during the winter and rainy season. Most of the animals found in the area are not bright in color and blend with the brownish appearance of the landscape. Brush rabbits, wood rats, and several types of lizards are all permanent inhabitants of these short forests.

The Subtropical Evergreen Forest

On the east coast of continents at middle latitudes there are two rainy seasons with occasional long dry periods. This area can develop a complex high-diversity forest. The evergreen trees have small moisture-conserving leaves that are adapted to the occasional long dry periods. Some trees are deciduous.

The subtropical evergreen forest includes several levels of plants from top to bottom. Plants that grow on other plants are called epiphytes. These include mosses, lichens and orchids.

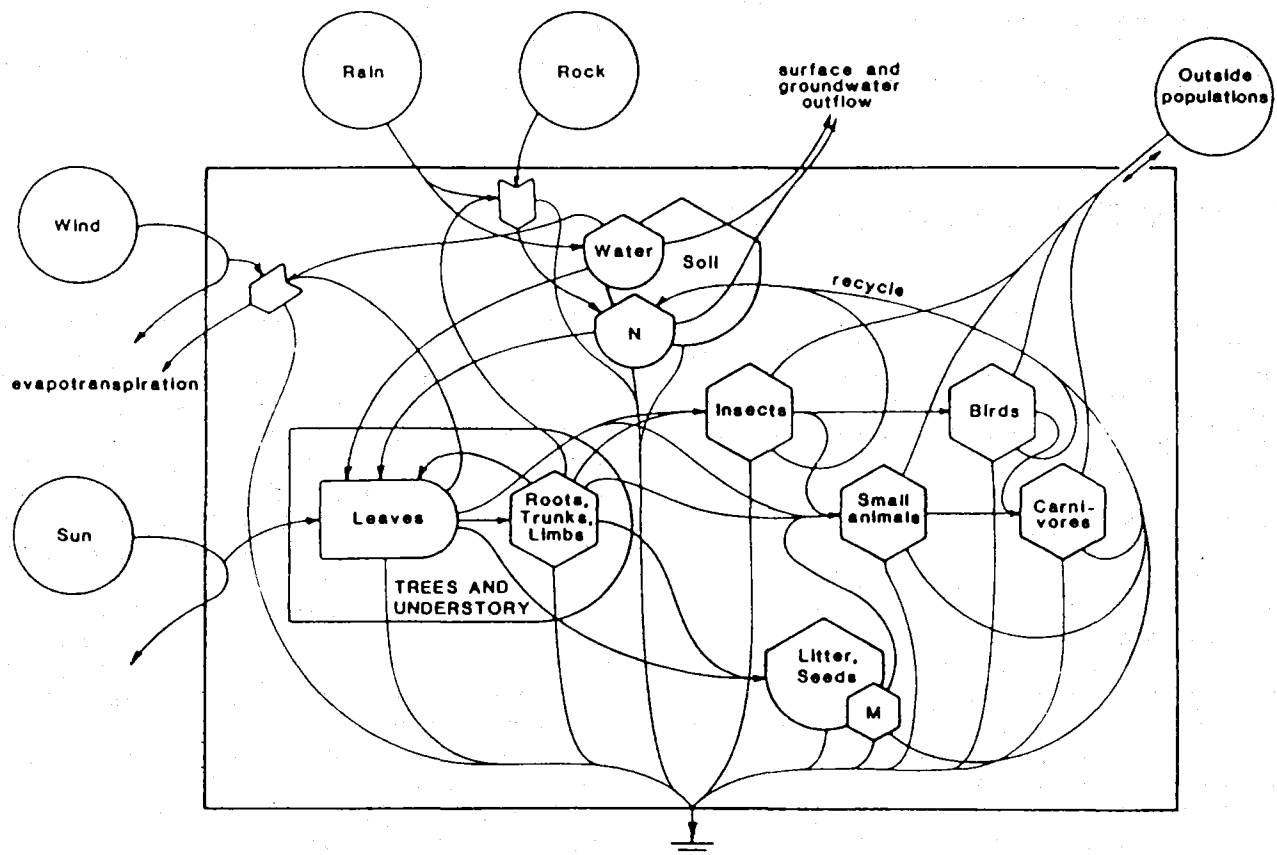

Figure 15.1. Deciduous forest ecosystem. Life is dominated by the seasonal cycle of leaf fall in autumn and regrowth of leaves in spring. M, microbes; N, nutrients.

There is a leaf fall, as much in spring as in fall. The litter builds up a storage of organic matter that includes seeds capable of germination to repair the forest if an opening develops. In addition to the steady leaf fall (two grams of leaf matter per square meter per day), there is also a constant rain of dead stems, leaves and twigs. An elaborate system of animals and microbes works to recycle this biomass.

In the forest there is a complex web of insects, including herbivores, sucking insects, carnivorous insects, bees that facilitate pollination, and decomposers like ants which consume detritus and break it down. Birds help regulate insect populations and transport seeds, as do mice and squirrels.

Different insects feed on different parts of each kind of tree and plant. Insects are adapted to the role of eating back anything in excess. If any plant increases to excess, its consumer insects or disease organisms will increase until the species is again in stable balance with the other species. Since most insects and diseases are specific to certain species, their numbers also decrease when the plant species is back to normal density. In a diverse forest, even if one kind of tree succumbs to disease or an insect infestation, the ecosystem is not destroyed. When forests are cut for timber, succession must start again. (These are examples of oscillating systems simulated in Chapter 9).

Temperate Rain Forest

Where the westerly winds and cyclonic storms move from the ocean to the mountainous west coasts of continents, temperate rain forests develop. These areas receive large amounts of rain and the temperatures are moderated by maritime winds. Giant trees develop. The surfaces of the trees are covered with moss and other lush vegetation responding to the wet conditions. Examples of this type of biome are the temperate rain forests found along the west coasts of British Columbia, Chile, New Zealand and the U.S.

Temperate Forest Succession

The sequence of stages which develops after disturbances when sources of seeds and animals are nearby is forest succession. If the initial condition is bare ground, succession consists of accumulating soil storages, growing populations of organisms, and developing the properties found in mature ecosystems -- high diversity, recycle of nutrients, buildup of organic matter reserves in the soil, and plants and animals which use most of the sunlight and other resources. The characteristic mature ecosystem in an area is called the climax.

At temperate latitudes, when cleared land is subjected to moderate rainfall, succession starts with fast-growing weeds, such as herbs and grasses. A weed is a plant which has a very high rate of net production but grows structure which does not last long. The first weeds cover the ground quickly, help catch sun and rain with nutrients, and start accumulating organic matter in the soil as they die and decay. In a year or two

these early weeds are replaced by longer-lasting grassy and shrubby plants, such as broomsedge and blackberry.

If seed sources are nearby, pines come in after several years, soon overtopping the grassy vegetation and shading it out. The species of pine depends on the type of soil and moisture in the area. As the pine forest becomes more shady, hardwood seedlings come in.

Fire Subclimax

Lightning and humans often start fires. Hardwood seedlings are very sensitive to fire. Many pines are fire-resistant because of the thick bark of the mature trees and the long needles on the young seedlings and saplings. Fire that is not too hot, such as slowly moving ground fire when vegetation is not very dry, eliminates the hardwood seedlings which are competing with the pines.

If fire is regular every few years, the ecosystem remains in the pine stage. Hardwood seedlings that come up are killed by the fire, whereas pine seedlings and trees are fire-resistant. Pine needle litter is very flammable, making the pine forest more susceptible to fire. This kind of pine forest is called a fire subclimax. When the undergrowth burns, phosphorus and potash are released to the soil, but nitrogen goes off as a gas. To replace this nitrogen in the soil fire climax forests develop nitrogen-fixing herbs and shrubs.

If fire is kept out for ten or twenty years, the underbrush of shrubs and seedlings may become very thick. Then, if a fire gets started in a dry windy period, a very destructive crown fire results that may kill pines as well as the understory. In some countries, air pollution regulations make it hard to control-burn deliberately, even during damp, non-windy times. Destructive crown fires can destroy all trees in areas where formerly frequent burning prevented damaging fire. In recent years, such fires have caused enormous damage in areas of Australia, Southern France and the western U.S.

Climax

If fire is kept out for longer periods, the understory of mixed hardwoods begins to take over the canopy as well. Pines do not reproduce under these shaded conditions. Thus, a complex high-diversity forest emerges. It maintains a moist micro-climate which discourages fire. The shaded conditions remain suitable for hardwood species, so the system tends to reproduce itself. This is then called a climax.

The weeds and pioneer species are available in a climax forest to repeat succession if a tree falls and leaves an opening, if a natural disaster like a hurricane occurs, or if the forest is cut by humans.

Each climate and soil area has its own particular stages of succession. In the temperate zone the deciduous forest, the subtropical evergreen forest and the rain forest are climax forests. The chaparral and the pine are fire subclimax forests.

16. GRASSLANDS AND DESERT BIOMES

South of the temperate forests in the northern hemisphere, lie the desert and grassland biomes. These biomes are characterized by a climate where the evapotranspiration is often equal to or greater than the amount of rainfall. This means that there is insufficient water available to support a forest biome.

Temperate Grasslands

In the latitudes of the westerly winds and cyclonic storms as one travels from the west coasts of the continents eastward, the rainfall decreases and the forest gives way to grasslands. These were originally dominated by large herds of grazing herbivores. The grassland ecosystem is diagrammed in Figure 16.1

The last Ice Age played an important role in the formation of the soil on which the grasslands grow. As the glaciers advanced, they pushed huge amounts of soil in front of them. The difference in temperature between the front of the glacier and the air around it caused high winds that blew the soil into thick accumulations called loess.

The grassland ecosystem owes its character in part to periodic fires. Figure 16.1 has two switches for the two conditions necessary for fire. The first is that the grasses have grown up, and turned into dry, dead biomass. The second is lightning to start the fire.

During the winter, water falls as snow. In the spring, as the snow melts, the grasses are able to grow green and lush due to all the water available.

But water is not readily available the rest of the year. As summer arrives and passes, the grasses shrivel and die, becoming organic matter by autumn. This dry organic matter is easily set on fire in autumn storms. The fires race across the plains returning the nutrients to the soil in the form of ash which is then available for the growth of the next spring's grasses. Frequent fires favor the formation of grasslands. The grasses are not killed by the fires because their growing parts are underground. Other forms of vegetation such as trees and shrubs are killed by the passing fires. For this reason, the fires tend to sustain the grassland ecosystems.

Where conditions for growth are best, tallgrass prairies develop. This grassland vegetation builds a heavy turf of peaty organic matter because of the dense network of roots the grasses send down into the soil. When the plants die they are not entirely consumed. The combination of deep loess from the glaciers and the peaty matter from the roots of grasses combine to form soils rich for agriculture. The Great Plains of the United States are prime examples of this accumulation. These plains are sometimes called "the breadbasket of the world" due to the rich growths they will support. Their richness has also resulted in the present lack of grasslands in the United States. So much of the original grasslands of North America are now under cultivation, that there is now a drive to name the few remaining natural grasslands in the U.S. a National Park to ensure that we do not lose these ecosystems completely.

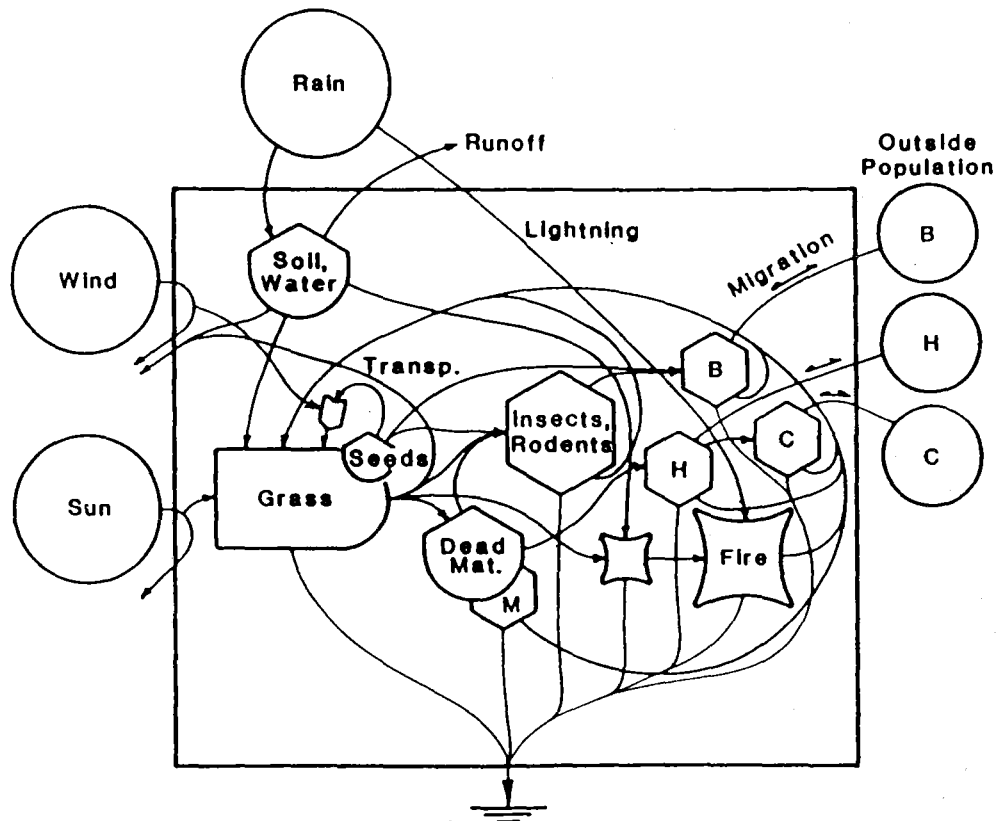

Figure 16.1. Grassland ecosystem. H, herds of large herbivores such as bison; M, decomposer micro-organisms; B,

Although the grasslands may look monotonous to the casual observer, this is not the case. Before agriculture, the grasslands were continually mowed by great herds of herbivores. The fecal droppings of the herds added to the richness of the soil and allowed the development of a wide diversity of animals to take advantage of the grasslands. Most of the small animals of the plains are adapted for life underground where the conditions throughout the year are relatively stable.

The western side of the continents is dominated by tussock grasslands or steppes. These areas have clumps of grasses separated by relatively bare areas. Each clump of grass is a little microecosystem with its own producers, consumers, decomposers and nutrient cycles. The tussocks catch dew from damp winds. Many are over one hundred years old.

Another type of grassland ecosystem is the shortgrass plain. These tend to be at higher elevations and colder areas where the annual rainfall is less than 50 cm per year. The grasses in these areas tend to be uniformly distributed.

Deserts

Where rainfall is too little to support grasses, desert ecosystems develop. Deserts vary depending on the rainfall patterns, temperatures and the soils.

Temperate latitude deserts occur far from the oceanic sources of moisture. These are cold and freeze in the winter, but are hot and dry in the summer. Vegetation occurs in clumps and is adapted in a variety of ways to conserve what little moisture is available. Many desert plants, like acacia trees, store water in fleshy stems covered with spines to prevent animals from eating them. Others, like cacti, have no leaves but concentrate chlorophyll in the stems. This prevents water loss by decreasing the surface area exposed to drying winds.

Other plants have evolved a reproductive strategy that eliminates their exposure to the harsh conditions throughout most of the year. When infrequent rain falls, these plants grow quickly, go to seed, then die. The seeds are then dispersed until the next rain begins the cycle again. A good example of this is the tumbleweed of the southwestern U.S.. The tumbleweed is actually the skeleton of the dead plant. As it rolls along with the wind, its seeds break loose from the skeleton. This spreads the seeds around a larger area and increases its chance of encountering rain.

Animals, too, use this strategy to survive the harsh conditions of the desert. When rains fall on the desert, temporary ponds of water develop. Small crustaceans called brine shrimp quickly appear in these ponds. They grow rapidly due to the accumulated organic matter that may have been sitting in these depressions for a long time. The shrimp develop, mate and lay eggs before the ponds dry out. The eggs are resistant to drying and may sit for years before they are once again exposed to water and the cycle repeated. These eggs are very light and are blown about by the wind. This aids in the dispersal of the population. In some places in the desert, the eggs of the brine

shrimp collect in depressions or against permanent objects, called windrows. These eggs are often collected by humans and used to provide live food for aquarium fishes. By simply putting the eggs in water, they hatch, providing an instant food source.

Sub-tropical deserts are hotter, drier, and often have little vegetation. But there is still life. Soil algae live in the crevices in the sand, small insects feed on them and support an entire food chain. In the Sahara Desert of Africa, the top predator is a small mammal called the golden star-nosed mole which is no bigger than a mouse. This mole gets all its nourishment and moisture from the insects that it eats as it burrows around in the sand. At certain places in these deserts, the deep lying water breaks the surface to form oases. These oases support luxuriant vegetation in the middle of the deserts. They are so widely dispersed that each oasis has its own species of plants and animals.

Deserts vary in their appearance. On the side of the desert from which the prevailing winds come, the sand is picked up and blown away. This side of the desert is nothing but bare rock and supports little life since there is no soil. On the other side of the desert, the sand is deposited to form great drifting dunes. There is not much large vegetation here because it would be quickly buried in the sand.

Thorn Forest

Where rainfall is slight but regular and there are grazing animals, thorn forest ecosystems develop. The presence of the grazing animals acts as a natural selection process to keep edible vegetation trimmed back and prevents it from developing. This allows the thorny and inedible vegetation to become the dominant species. This is an increasing problem in highly populated areas where people keep sheep and goats, such as the dry islands of the Caribbean, and parts of Mexico, Venezuela, and the Mediterranean. Since this overgrazing results in a decrease in the overall productivity of the ecosystem, it is an open question as to whether or not it is a good use of land.

17. TROPICAL BIOMES

Tropical ecosystems are found at low altitudes within 22 degrees north and south of the equator. The predominant ecosystems in most tropical areas are tropical forests and savannas.

Tropical Rain Forests

Tropical rain forests occur extensively in broad lowland areas of the Amazon Basin of South America, the East Indies, and the Congo Basin of West Africa. The climate is warm and humid all year round. Rainfall is greater than 7 centimeters in every month and temperatures vary little. No other terrestrial biome has such a uniform climate.

A few of the many aspects of the rain forest ecosystem are given in Figure 17.1. Lush vegetation covers the landscape of the rain forest. Below the taller trees (canopy) is the understory: shorter trees that are tolerant to shade. Below are shade-tolerant herbs and seedlings. Weaving in and out of the branches of the trees are lianas (tropical woody vines). The branches of the trees and the lianas serve as supports for the epiphytes. These plants grow attached to the trees, but draw their nutrients from the water dripping through the tree. Epiphytes common in the rain forest include orchids, bromeliads, and ferns. The dense layers of the evergreen trees absorb most of the light, so few plants grow on the forest floor. Generally, it is uncluttered. Only along rivers or at the edges of clearings does a thick wall of vegetation extend down to the ground.

A major part of the forest production goes to support intricate networks of roots such as prop roots and buttresses. The buttresses support the heavy trees in soggy soils. At these high temperatures, and with so many kinds of insects, molds, and bacteria, leaves decompose as rapidly as they fall. There is only a thin layer of litter at any time.

Animal life in the canopy is abundant. These treetop dwellers include tree snakes, tree frogs, tree lizards, birds, mammals, and large numbers of insects.

Tropical rain forests produce many valuable and beautiful hardwoods including ebony, mahogany, and rosewood. Hundreds of other useful products also come from rain forest species -- rubber, cocoa, and curare (a resinous extract used as a muscle relaxant or arrow poison).

The tropical rain forests contain the world's pool of valuable genes not yet used in human society. The explosive growth of human populations in tropical regions is causing the rapid clearing of the rain forests. Most of the rain forest species cannot live separated from the complex of other species. They become extinct when their habitat is removed. What is our future if we destroy life which took nature millions of years to produce?

Main categories of species are shown in Figure 17.1, but each symbol represents hundreds of species. Notice some of the following pathways: rain hits epiphytes and crown canopy flowers and fruits first before soaking the soil. Animals control pollination and

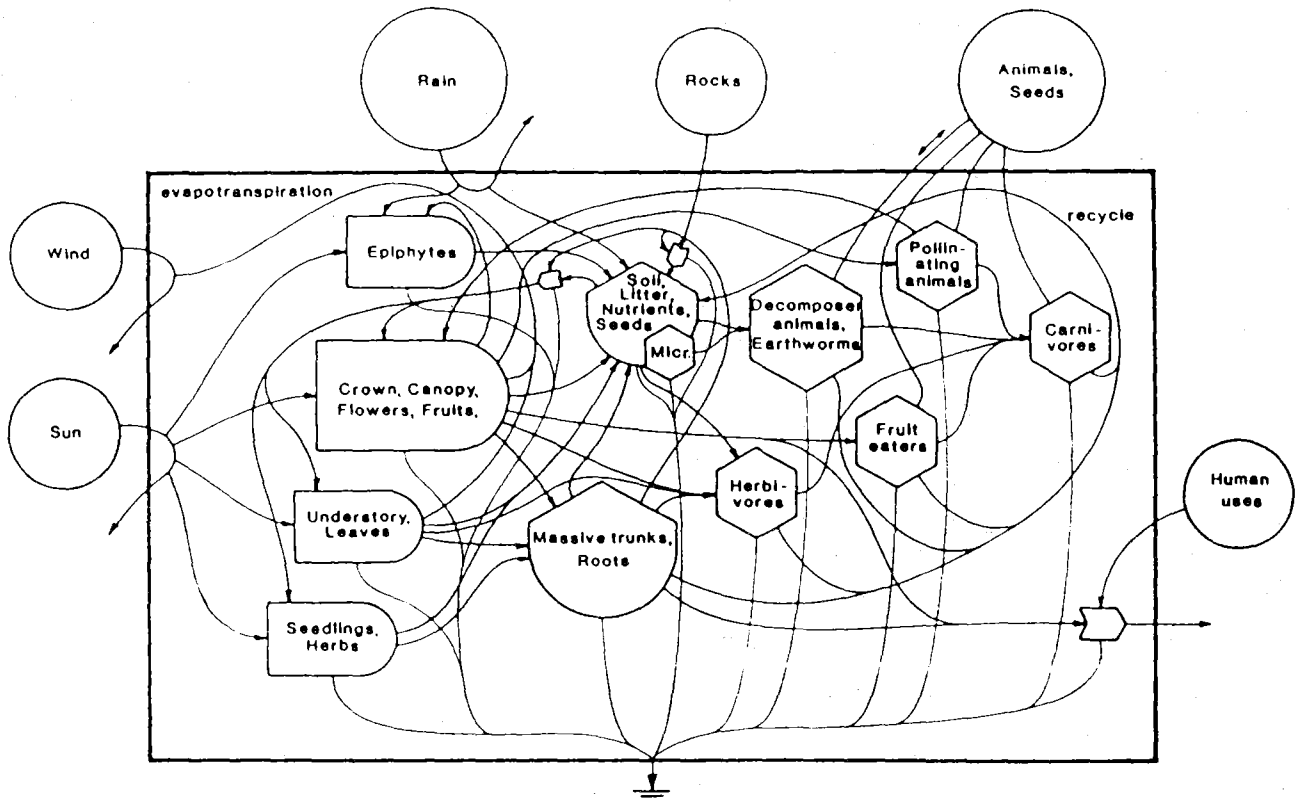

fruit distribution. Seeds distributed by animals make seedlings, which grow to be understory trees; the understory trees grow to be crown trees. Animals help the decomposition process which recycles nutrients that are taken into trees by their roots.

Cloud Forests

As one moves up tropical mountains to the cloud levels (about 1000 to 1500 meters), the humidity increases until 100% relative humidity is reached. Evapotranspiration becomes minimal. The forests on these mountains are called cloud forests. They are short forests, dripping wet and loaded with epiphytes, even when the rainfall is not large. Since little evapotranspiration occurs, 90% of the rain runs off and becomes available for use by lowland populations. These cloud forests provide excellent protection against erosion of mountain watersheds.

Tropical Deciduous (Monsoon) Forests

In India and southeast Asia, there is an annual reversal of winds. This occurs with the seasonal heating and cooling of the Tibetan land masses. This reversal of winds is called the monsoon. The summer monsoon brings the moist tropical air to India. Rain forests form on the mountains. In winter the winds reverse and bring heated air down the mountains from central Asia. This hot air dries out the forests in winter, and by spring, the landscape becomes hot and parched. Animals, such as pythons and cobras, burrow and become inactive until the winds reverse and the rains come again. Since many trees shed their leaves in the dry season, the biome can be described as tropical deciduous forest.

Typical deciduous forests occur in southern Asia. Related forests also occur in Africa and South America. These forests are found in a belt between the rain forest and the savanna. These areas have enough rainfall to support tropical

forests but also have sharp dry seasons.

Trees exposed to seasonal changes store food reserves which are used to support their leafing out again. Many of these trees can survive herbicide defoliation. This was observed in the massive herbiciding of the tropical forests during the Vietnam War. The evergreen mangroves did not survive the spraying. These trees had to regrow from seedlings.

In most tropical biomes ground-level vegetation is sparse enough that a person can walk about easily. However, after a forest has been cut, the rapid regrowth produces dense vegetation that is difficult to penetrate, creating what is sometimes called "jungle". Later, it is shaded out by canopy growth.

Tropical Savannas

Savannas are areas of tall grasses with a few scattered trees or shrubs. They develop in regions of high temperature that have distinct wet and dry seasons. Growth is rapid in the wet season, but the plants become dry and low in quality in the dry season. Tropical savannas are extensive in South America, Africa, India, southeast Asia, and northern Australia.

In Africa the savanna is the home of large hoofed mammals (zebra, wildebeasts, antelope, elephants). These herbivores are controlled by the large carnivores such as lions, leopards, and cheetahs. The kills of these predators are cleaned up by the hyenas and vultures. Fire is an important part of the system. An ecosystem diagram would resemble that in Figure 16.1.

Plant and animal growth in the tropical savanna is dependent upon distinct seasonal changes. Large animals migrate in search of water and their reproductive cycles correspond to the availability of tender new plant growths. The animals are very abundant, but many times are not seen. It takes a large area of photosynthetic production to support these large, high quality animals.

18. AGRICULTURAL SYSTEMS

Agricultural systems are the world's principal means of providing food for its populations. Agricultural systems, sometimes called agroecosystems, usually consist of several parts and processes. These include a farm area (with soils formed by previous geological and ecological processes), a producing crop plant, and farm equipment for planting, weeding and harvesting. A market is necessary to buy the produce and provide the money that is required for the fuels, fertilizers, goods, and services needed to keep the system working.

An agroecosystem is a system in which humans operate as managers and consumers. In wild ecosystems animals operate as consumers and managers. Wild organisms constantly scatter seeds and invade the territory of the agroecosystems. If farmers did not control these by pesticides, weeding, plowing and other

itself. Farms are able to prosper because of the valuable work done previously by the wild ecosystems in developing the soil. Most farming gradually depletes the soil even when it is fertilized. Rotation of the land back to natural succession is sometimes called a fallow cycle and is one way to restore soil.

Primitive, low-energy agriculture used labor of humans and farm animals without fuel or electrically run machinery. Modern intensive agriculture involves large inputs of fuel and electricity-using machinery. It takes a lot of energy to produce all the goods and services used in modern agriculture as well as to process and transport the products. Intensive agriculture displaces the more primitive agriculture if there is a constant, cheap supply of energy. Intensive agriculture needs more resources to get more yields (products produced) per person per area

our time is, whether the intensive agriculture will be displaced by a system that uses less energy. It is predicted that this may happen when fuels and other resources get so scarce and require so much work to obtain that they are very expensive.

Two centuries ago, most farms were highly self-sufficient family operations. A farmer produced according to the needs of his own family and only sold a few items for cash. Now most people in urban countries derive their foods from highly diversified (spread out and varied) markets. These markets obtain food from many different intensive farms, each of which specializes and mass-produces only a few cash products for sale.

Today there is increasing interest in going back to less intensive farming methods used earlier. If this trend continues, use of purchased inputs (fertilizer, services, etc.) will decrease. Farming will alternate uses of the land so that it can replenish its soil nutrients.

The world's most important food products are divided into three main classes:

- a) root crops (potatoes, cassava, yams, etc.) which are the staple in many tropical latitudes;
- b) grain crops (wheat, oats, barley, rye, rice) used as a main staple in temperate latitudes and in monsoon climates; and
- c) meat production (cattle, sheep, poultry, etc.) which are used by highly developed economies.

The root crops are mostly carbohydrates. These supply the fuel needs of people but not the protein, vitamins, etc. required for a balanced diet. Grain crops have some proteins. Meat diets (such as in Europe and the United States) provide more proteins than are necessary for normal needs and are sometimes described as luxury diets.

Cattle Pastures

Look at Figure 18.1 to follow how the pasture system operates. The renewable energy sources necessary for the system are the sun, wind, and rain. Fertilizer is added.

The resulting grass and clover is used for direct consumption by the cattle and for producing hay to store for food in winter and dry periods. Goods and services are used in all the farm processes. Cattle are shown with their cycles of breeding and calving. Yield is also shown.

At the right of the diagram are the flows to and from the economy. Inputs of equipment, fertilizer, pesticides, salt blocks, etc. are paid for by the money obtained from sales of milk and meat. You can see the money from the sale of milk and meat going into the farmer's money storage and from there to buy inputs.

Effective management of pasture land is required to produce the greatest weight of healthy cattle or milk in the shortest time. Two particular limiting factors require careful management.

1. The nutrient levels of many soils are low, especially nitrate and phosphate levels.
2. Grass does not grow at the same rate throughout the entire year. This means that the carrying capacity of the pasture varies seasonally.

Carrying capacity refers to how many cattle a pasture can support with all of the animals remaining relatively healthy and obtaining enough to eat.

Additional phosphate is provided by applying superphosphate fertilizer which is manufactured from rock phosphate. Nitrate levels are supplemented with nitrogen fertilizer and by

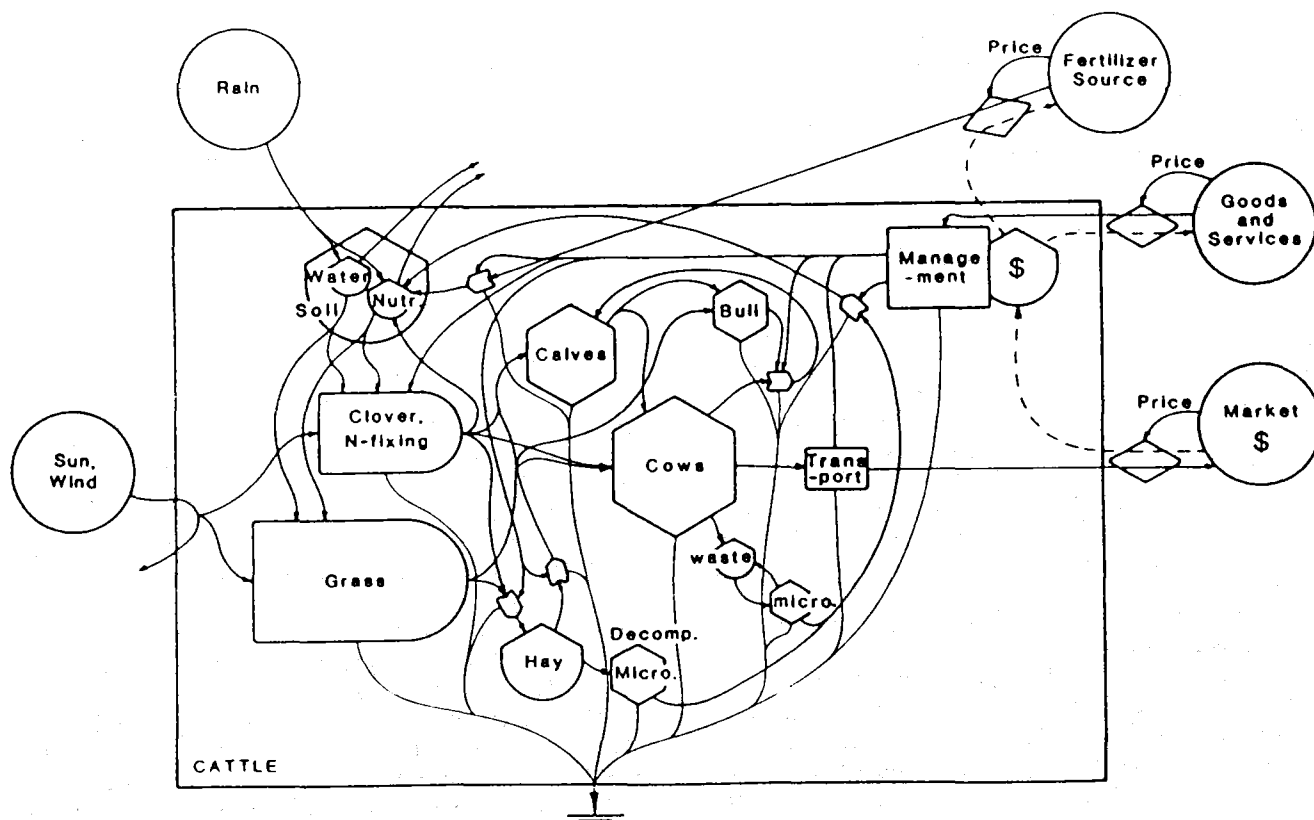

growing nitrogen-fixing clover with the pasture grass. In some areas the trace elements cobalt and molybdenum must be provided also to prevent certain nutritional diseases of cattle.

Grass production is limited in the winter due to low temperatures and in the spring due to a lack of rainfall. Farmers are able to increase their cattle production more than the winter grass production would normally support. They do this by harvesting surplus summer and autumn grass and feeding it to their stock in the winter. Also, some areas are irrigated in the spring. Such management practices as adding fertilizers and harvesting hay are highly mechanized and require an investment of fossil fuel energy.

As the cost of fossil fuel energy increases, some farmers are finding that it is more economical to employ a low-energy management strategy. This involves doing away with hay-making almost entirely and raising only as many cattle as can be supported by the natural carrying capacity of the pasture. Soil nutrient levels and winter feed levels are monitored very carefully. This way the cattle receive only a survival-level diet in the winter. The yield from such strategies is lower. However, the investment in production is also lower. Investment refers to the time, effort, or money spent to gain future benefit for profit. The financial return may be the same or better than the high-energy management strategy. More human labor is involved with the low-energy strategy.

Self-Sufficient Agriculture

Economic survival in present-day societies probably requires that some outside economic energies be used. Figure 18.2 is a model of a rural agroecosystem in India that is more self-sufficient than the cattle pasture system. But even this system needs some input from the main economy, in the form of some feed for the bullocks and a few goods for the family. There is no need for fertilizers since dung from livestock is recycled to the crops. The Indian farmers use no tractors, instead they rely on bullocks for cultivation and plowing. They have no need for expensive machinery and the fossil fuels that power them. Their farm produces almost all the food needed by the family. They export some food to feed other people, and trade for some extra goods.

In the past, industrial farms have gotten larger and required a high energy input. The farm of the future may be small and diversified. The inhabitants may produce mostly for their own needs and export a few products for cash. In this way, a subsistence farm model -- although of a system which is incorporated into the money economy to some degree -- may become more common everywhere as energy becomes more scarce.

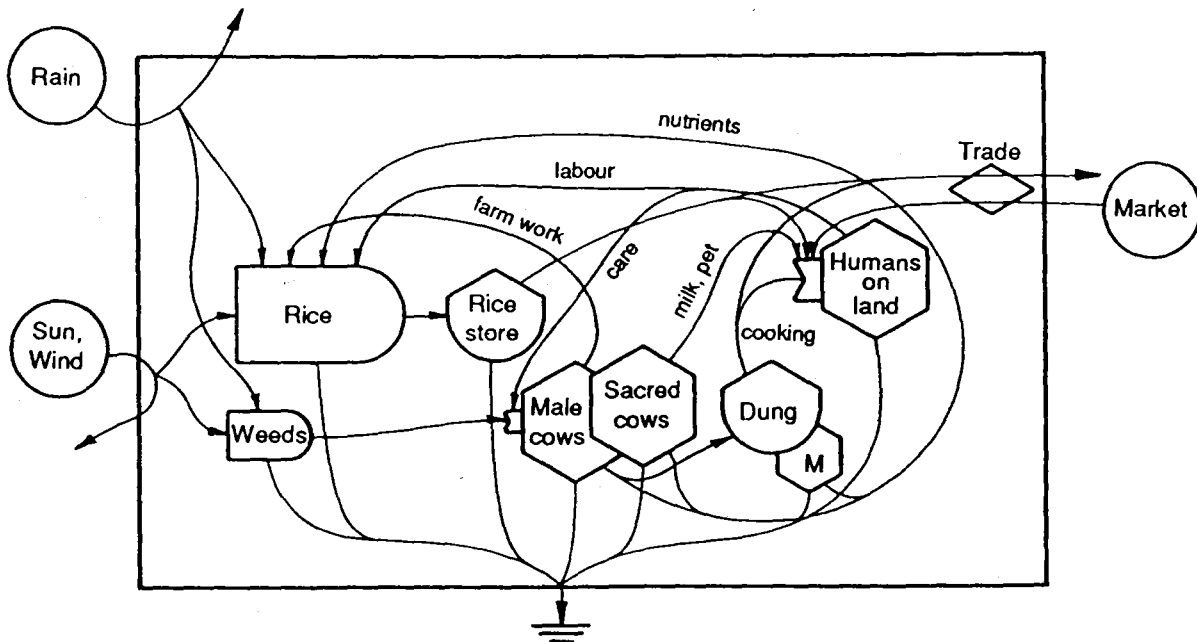

Figure 18.2. Diagram of a relatively self-sufficient rice and cattle agro-ecosystem in India. M, micro-organisms.

19. FOREST PLANTATIONS

To maximize the production of forest products for commercial yield, plantations of trees are developed with the same principles as agriculture. The ground is prepared, fertilizer may be added, seedlings are planted, and often weeding is done until the trees get above the competing plants. In a few years trees are harvested as a crop. Plantation trees include pines and eucalyptus.

Silviculture is the commercial planting and harvesting of trees. Plantation forests require more management than natural forests, and thus more direct and indirect energy, but they also yield more.

Plantations provide the raw materials for the paper and packaging industries as well as lumber for construction. Plantations yield small boards, but this wood is glued together to form plywood and larger beams.

Pine Plantation

Figure 19.1 diagrams the main features of a pine plantation. Notice that the work is shared between the environmental inputs and the feedbacks from the economy in planting, thinning, cutting and applying chemicals.

To maximize height, trees are initially planted close together so the tops will shade out the lower limbs. Later, they may be thinned to give faster growth per tree. The trees are cut when they are large enough to be used for paper-making, poles,

or lumber. Plots of several acres are cut at one time, a practice which reduces cost. The plantation system is somewhat like the natural pattern of pine succession except that human management makes more of a monoculture and much denser stands than the more diverse natural pattern. Large areas with just one species are called monocultures.

Many monocultures eventually develop epidemics of insect pests. In many areas of the world extensive spraying with insecticides has generated chemical-resistant varieties of pests which have made agriculture and forestry more difficult. Management practices which enhance diversity may provide better protection against insect epidemics. In many plantations the main trees are the species planted, but the understory is natural, with a high diversity of species.

Since unmanaged forests provide useful products with almost no cost, it is important to encourage natural succession wherever there is not a plantation or other agriculture. This means keeping plots of natural forest as seed sources and gene pools (reservoirs of diverse life with storage of genetic information). Sometimes the legitimate needs of simplifying the plantations and keeping complex gene pool reservoirs are in conflict.

Arguments arise where pesticides are used for weeding or killing insects. Management techniques that use pesticides, herbicides, and fertilizers are energy-intensive and sometimes destructive. For example, there is concern that chemicals used in forest management not be

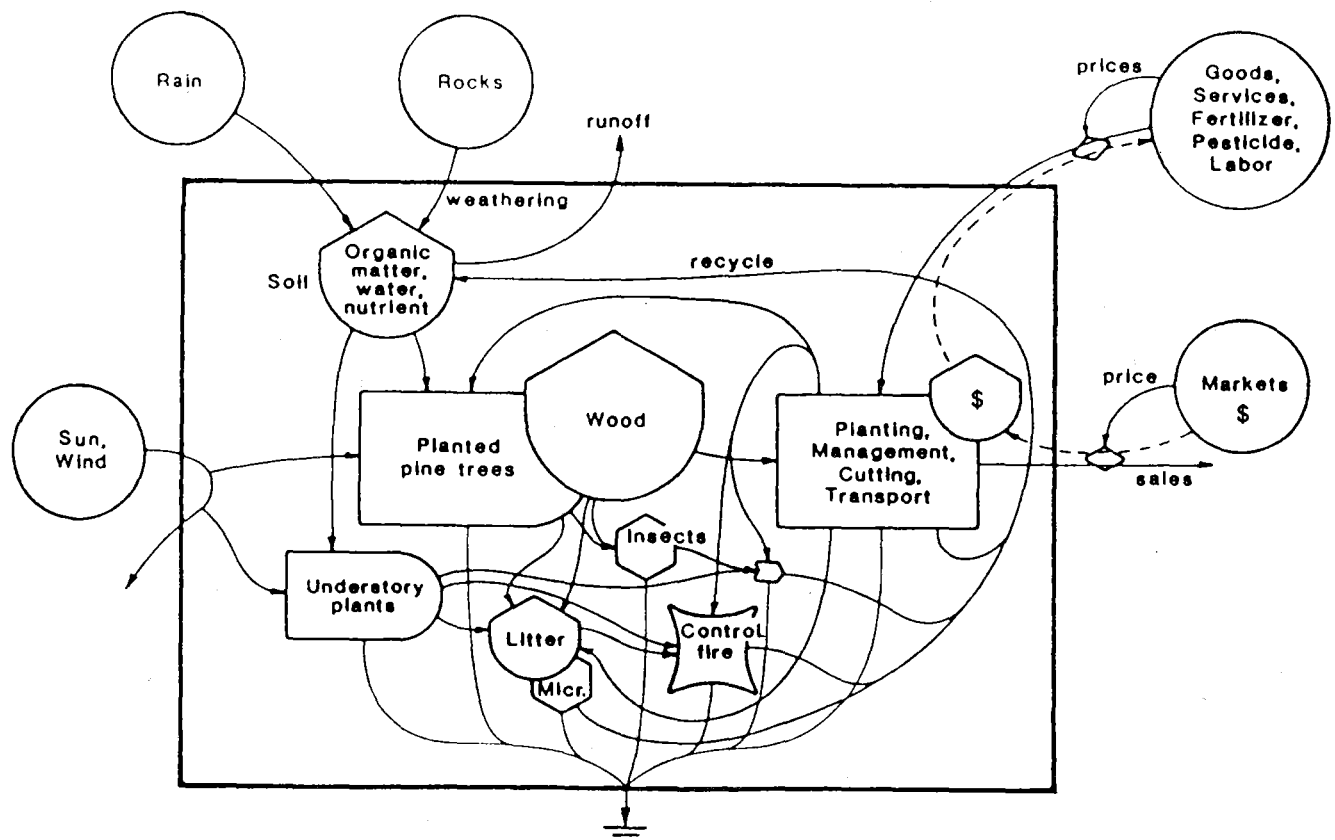

Figure 19.1. Pine plantation system.

harmful to humans when they drain into water supplies.

To avoid these problems, biological ways to control pests and replenish nutrients are being researched. For example, legumes, which are nitrogen fixers, can be planted before seedlings are put in. Since legume seeds will survive in the soil during forest growth, the nitrogen-fixing plants may reappear after the forest is harvested. Thus, they become a permanent, useful part of the system. Nursery-grown seedlings, already inoculated with mycorrhizae, can be planted. Mycorrhizae are fungi attached to roots which increase the seedlings' capacity to absorb nutrients from the soil, reducing the need for fertilizers. To reduce the need for herbicides, trees can be planted very close together. The close planting shades out competing plants and allows the weaker disease-prone and pest-prone plants to be thinned out later.

Comparison of a Pine Plantation and an Unmanaged, Mature Forest

A comparison between a mature forest and a pine plantation is shown in Figure 19.2. The natural, self-maintaining forest has five times more gross photosynthesis (510 E3 joules/m²/day) than the plantation (100 E3 joules/m²/day), but less than half the net yield (42 E3 joules/m²/day) from the plantation compared to the natural forest (22 E3 joules/m²/day). In the natural forest almost all

the production goes into work that favors gross production, such as diversity and recycling. All the nutrients needed are obtained by microbial action on the litter. Planting is done by natural reseeding. Diversity of trees and other organisms protects against epidemics of disease, insects, or overpopulation by any one species. Except for protection, natural forest management costs almost nothing. Therefore, the yields of a natural forest are very high in terms of money spent. Long periods are required for regrowth after cutting.

Figure 19.2 shows that the plantation forest needs inputs of fertilizer, planting, cutting and other work: a total of about 22 E3 solar emjoules/m²/day investment. In return for this investment, the managed forest produces about 42 E3 joules/m²/day. Thus, more than twice as much energy is produced from the system than has to be put in from the economy by forest managers. This calculation is a way of showing that pine plantations are a good contribution to the economy. Calculations done on an energy basis will still be valid as prices vary and as fossil fuels become expensive. However, yield per dollar cost of energy used will be less as fertilizer becomes more expensive.

The mature forest is more self-managing and yields less. It provides many services that don't always get recognized even though they contribute indirectly to the economy. These services include rebuilding soils, concentrating nutrients, protecting watersheds, reducing erosion, providing aesthetic

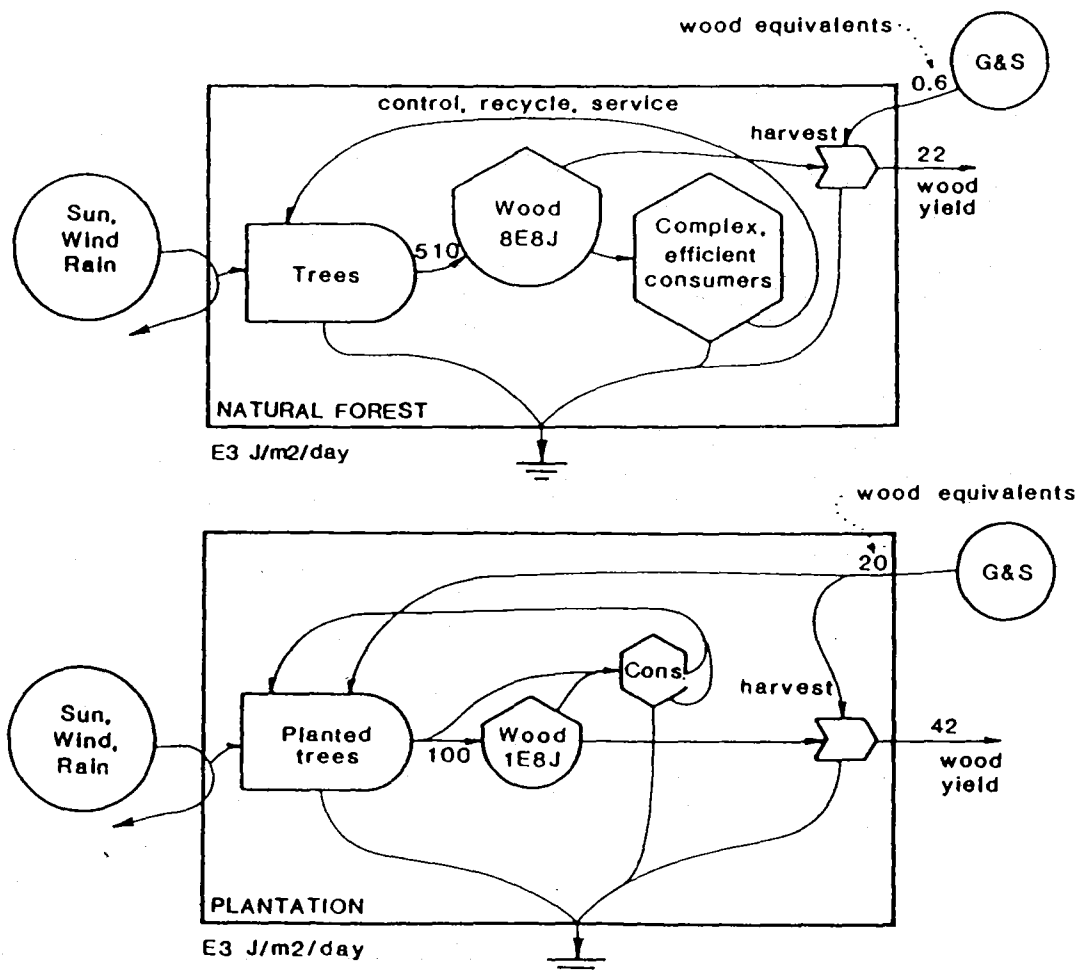

Figure 19.2. Comparison between a natural forest (a) and a plantation forest (b). Numbers are energy units. The feedbacks from the economy (G&S) for harvest are expressed in wood equivalents for comparison with wood yield.

diversity, making habitat for wildlife, providing recreation areas, cleaning the air and storing gene pools for succession and future uses.

Natural forests are sometimes harvested by selective logging, the removal of only small numbers of mature trees. The forest always remains in its climax stage. However, removing

cut timber from mature forests without damaging other components of the forest system is very difficult. Often, selective logging takes the best trees, leaving the inferior genetic stock for seed production. This means the next growth of trees will be inferior.

20. URBAN SYSTEMS

Cities are not usually thought of as ecosystems by most people. However, with a systems view, cities are seen to exhibit most of the same characteristics that are observed with other ecosystems like forests and prairies. Only the intensity of activity is much greater.

Some of the characteristics and activities that occur in urban systems that also occur in other ecosystems include: production, consumption, decomposition, nutrient cycling, and energy convergence. By far, consumption of goods, energy, and raw materials is greatest in cities, while the production of food and fiber is found more in the surrounding rural areas. Industrial production of consumer goods is centered in urban areas.

Urban Development

The development of urban areas is similar around the world. The early cities were small settlements surrounded by agricultural lands. The simple diagram in Figure 20.1 shows the relationship of the surrounding agricultural lands to the early city. Food and other products grown in the surrounding lands were taken to the city to support the people who lived there. The city in return provided simple tools and other products to the farms.

Notice the other pathway in the diagram that shows the recycling of nutrients from the city back to the agricultural lands. This pathway was very important during early times before fertilizers were available. In many cultures around the world, human wastes were picked up at night by the farmers and returned to the farm to be used as fertilizer. In this way the farms and cities were in a closed loop cycle and nutrients were recycled to maintain the productivity of agricultural lands. With the advent of fertilizers this practice has been

almost completely discontinued throughout the world.

As populations and energy use increased, the early cities grew, and surrounding agricultural lands were often converted to urban uses. The recycling of nutrients was discontinued. These are two of the most serious problems associated with urban development; the loss of prime agricultural lands as they are covered by streets, parking lots, and buildings and the pollution of rivers, streams, and lakes as wastes are discarded instead of recycled for productive purposes.

Cities in the Landscape Mosaic

Located at strategic places in the landscape for the convergence of goods, services, and energy, present day cities are where most of the world's population now live. The early cities were often located at the coasts of land masses where good port facilities could be developed, or at the crossroads of major land routes. As populations grew, and surrounding regions became more developed, new roads and small towns were constructed. The present day landscape of rural lands, roads, and cities is a result of the past patterns of growth of populations and energy use.

The spatial organization of cities in the landscape is sometimes described as a hierarchy. A hierarchy is the organization of objects or elements in a graduated series. Some researchers and scientists have noticed for many years that the cities of a given region seem to be organized in this matter. There are many small cities scattered throughout the region, fewer medium sized cities, and only one or two very large cities. Given in Figure 20.2 is a map showing different sizes of cities. Notice the number of small, medium, and large cities and how the numbers seem to support the idea of hierarchy.

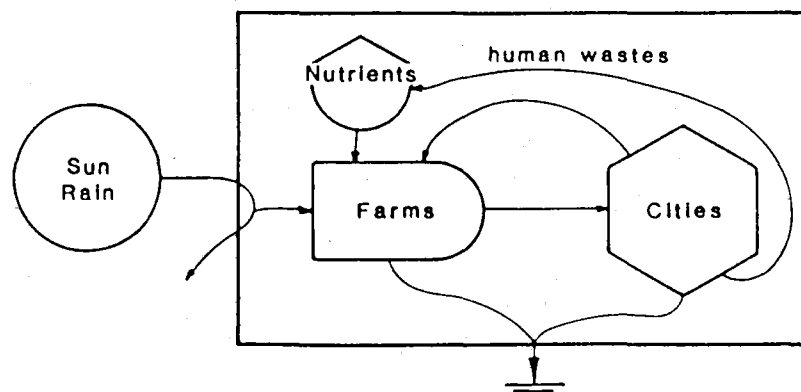

Figure 20.1. Diagram of the relation of cities to the supporting landscape. Early cities were small and depended on surrounding agricultural lands for food. Wastes were recycled to provide nutrients for agriculture.

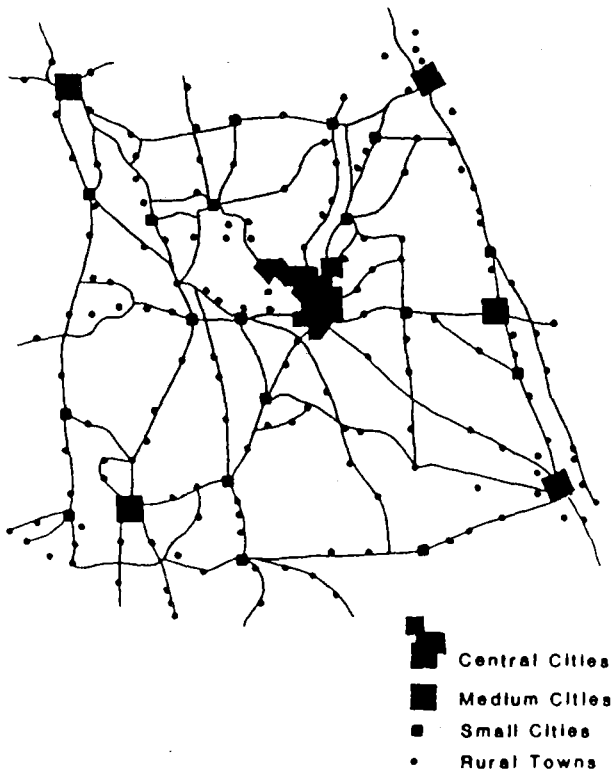
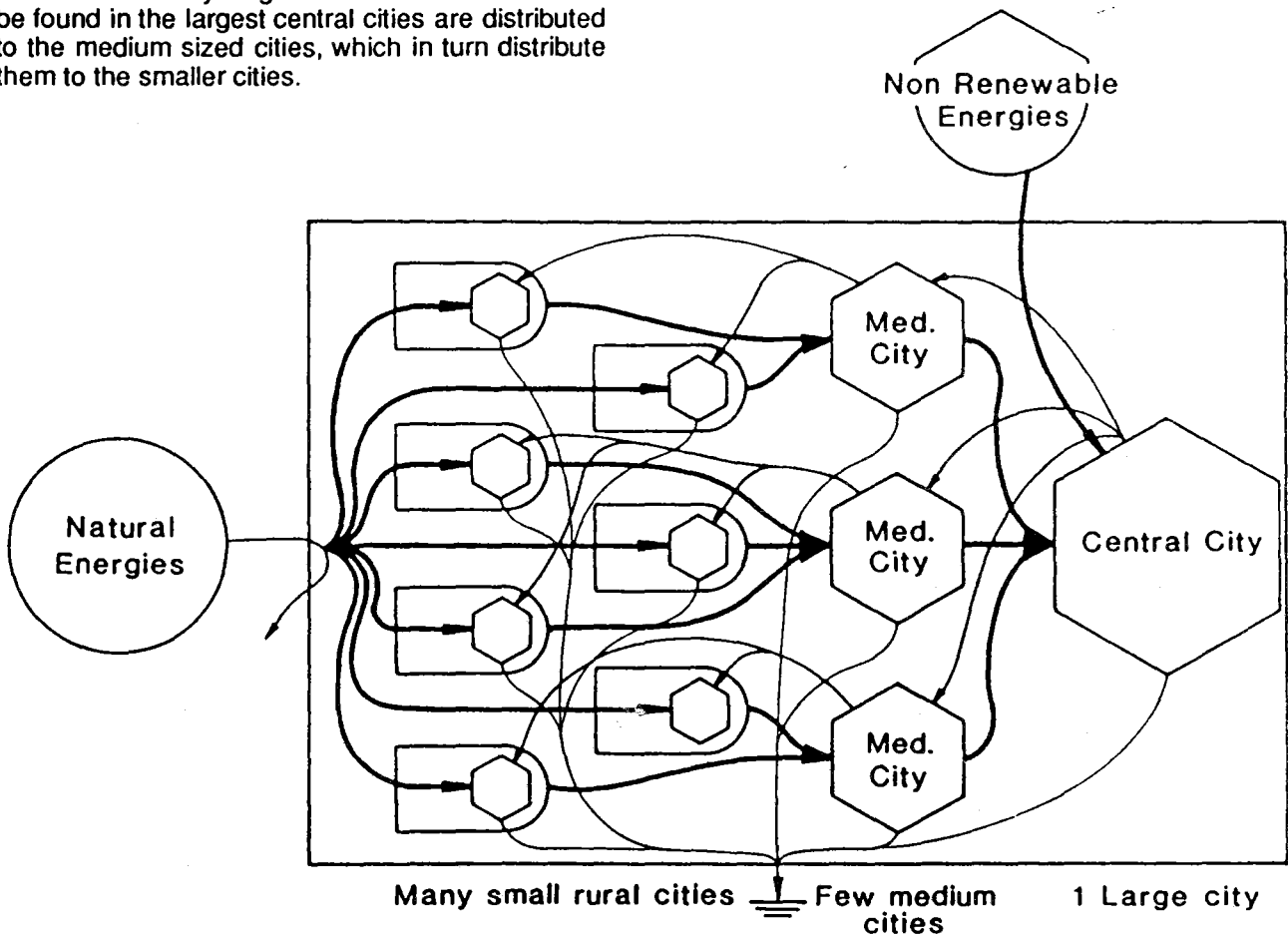

Figure 20.2. Map of a region showing the size and location of cities.

One reason for hierarchical organization of cities in the landscape is for distribution of goods and services. The largest cities import and manufacture goods, and act as distribution points. The wide diversity of goods and services that can be found in the largest central cities are distributed to the medium sized cities, which in turn distribute them to the smaller cities.

Another reason for the hierarchy of cities in the landscape is the convergence of energy. In Figure 20.3 energy is converged from the small rural cities to the medium sized cities and then to the large city. In other words, the hierarchy results from the convergence of energy. It takes many small cities to support one large city; just as it takes many small rodents and insects to support one bird of prey. In fact one can visualize the landscape hierarchy of cities as an ecosystem food web. The feedbacks from the larger cities to smaller ones are the necessary feedbacks of services that help control the entire web.

Not only are cities in the landscape organized in hierarchies, but each city in itself is arranged in a spatial hierarchy. The center of the city is most concentrated, having the largest buildings, highest density of people, and greatest energy flows. Surrounding the central city are rings of less and less concentrated activity going away from the center. There are intense areas of activity in these rings, like shopping malls and industrial parks, but they get fewer and farther apart. Streets that radiate out into the less concentrated rings from the central cities get smaller and less traveled as they extend into the surrounding city. They often connect points of intense activity with each other and the central city. This arrangement is very noticeable from the air at night. The lights of the city resemble the shape of a star with the central city at the apex and the brightly lit heavily traveled streets, the arms.



Energy Diagram of a City

A diagram of a city is given in figure 20.4. The industrial production of the city is processed by the commercial sector, some products being sold to the people living within the city, some consumed by the governmental sector, and some exported to markets elsewhere. The people supply the labor for industry, commerce, and governmental services. The different departments of government such as health, education, and police, have a controlling influence on the other sectors of the city. To pay for these services, government levies taxes from the people, commerce, and industry. All cities have connections to the government. People pay taxes and may receive payments such as state pensions or health care. Local governments also levy taxes to pay for services like police, courts, welfare, and schools.

Much of the money received from the sale of exported goods is used to purchase goods, services and fuels. The term "circulation of money" is often heard; and that is exactly what money does. It circulates through the local city's economy, flowing in from the sale of exported products, and from government sources, circulating around and around within the economy, and eventually flowing back out again either to purchase goods, services, and fuels, or in the form of taxes.

The renewable energies of sun, wind, and rain (and tides, and waves, if the city is located on the coast) are important to industry as well as to the people directly. We all appreciate the vegetation and wildlife in the parks and lawns of residential areas, but perhaps are not aware that the renewable energies do much more for the city.

The winds blow away industrial smoke, and the water in streams, wetlands, and tides is used to carry off solid and liquid wastes from industry and housing. In cities sewage is first processed in sewage treatment plants and then released into the environment. This is shown in Figure 20.4 at the bottom right, where the storage of wastes is processed and released, leaving the city.

Another inflow to the city that has a large effect is the inflow or migration of people from elsewhere. Many cities have increasing populations. This puts pressure on all parts of the city. Government must provide more police protection, roads, libraries, and schools. Remaining areas of open land are often paved or built upon to meet the increased needs of housing or parking. To pay for the additional services required by the growing population, government must often raise taxes since the taxes collected do not keep up with the growing demand for services. When the city becomes too intense, people begin to look elsewhere and move out in search of lower taxes and a "higher quality of life."

As fuels become harder to get and more expensive, there is a trend for people to move out, first to the suburbs and then into rural areas. As city budgets are decreased, services will decrease and the cities will have to decentralize. People who are left may plant gardens, have their own compost piles, and walk or bike to work. There will be much less hustle and bustle, and far less crime. Some industries are already leaving the central city. Many are moving to areas where there are more natural energies to use, more open space, cheaper housing, and generally a better lifestyle for their employees.

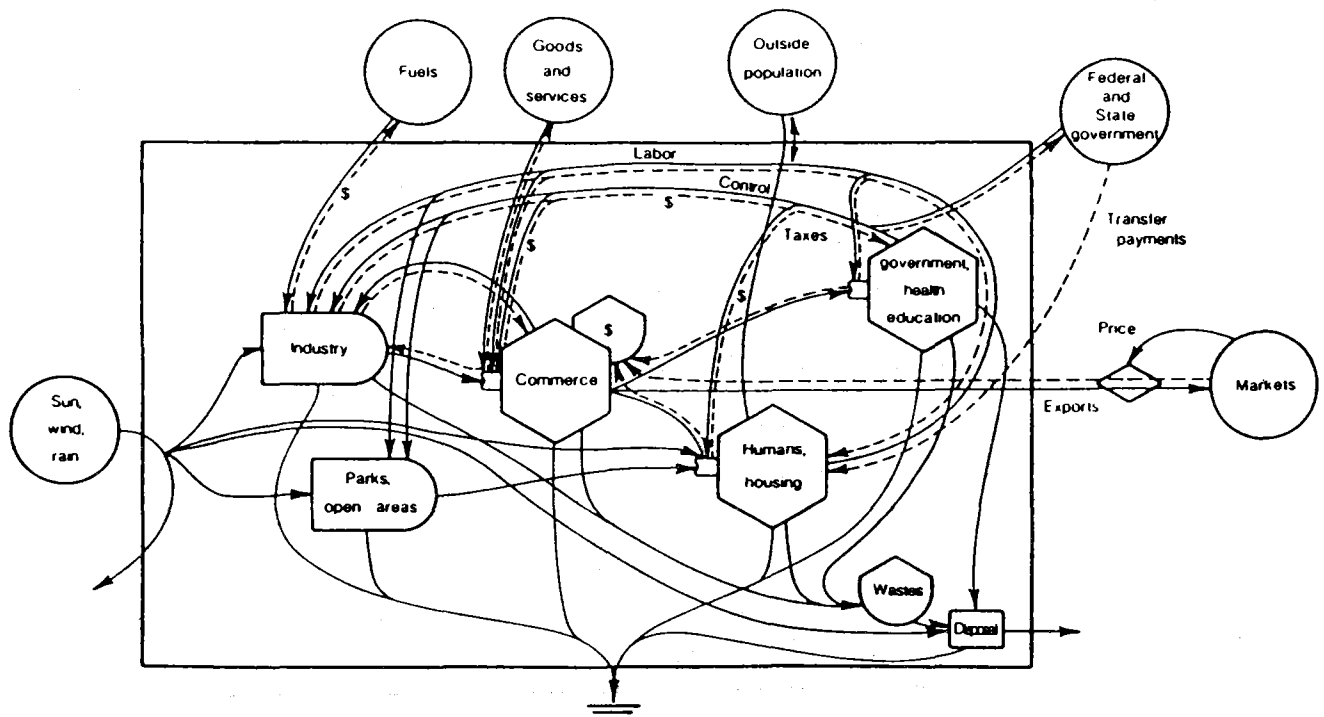

Figure 20.4. Energy diagram of a city.

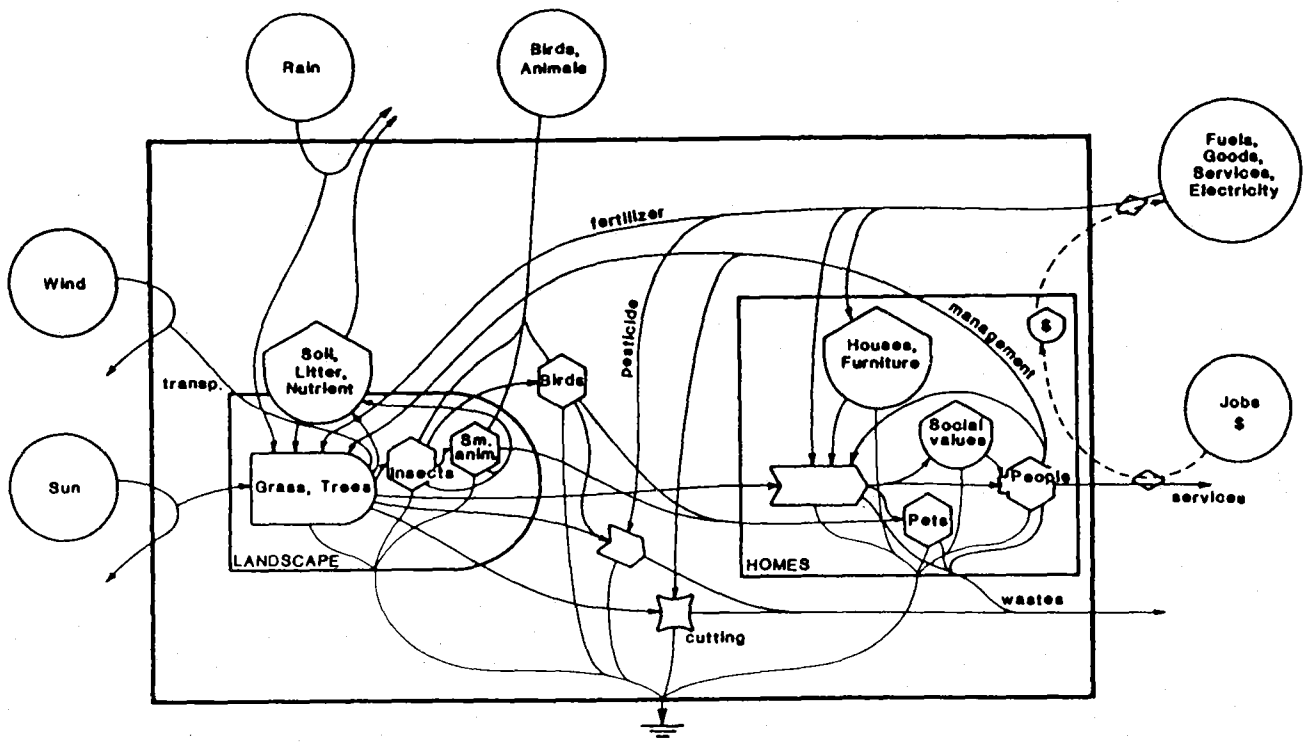

Figure 20.5 Residential neighbourhood system with house and landscape.

Residential Neighborhood: Primarily a Consumer System

The diagram in Figure 20.5 shows a typical residential neighborhood. Sunlight and rain are utilized by the lawns and landscaping. Some of the energy in sunlight increases the temperature of the surrounding environment (sometimes called the micro-climate). The breezes that are characteristic of so many parts of the world have the effect of cooling the micro-climate as they carry off some of the heat by transpiration of water from the plants in the landscape.

Soil nutrients are also necessary for production of lawns, bushes and trees. As the lawn is cut and the cuttings removed, the nutrients lost must be replaced by fertilizer. Human time and energy go into managing the lawn in planning, planting, and weeding.

Many insects are considered pests, both those that eat the vegetation and those which bother people. When they are treated with pesticides, there are effects on the birds, squirrels, and other small animals in the system. Not only is some of their insect food destroyed, but the poisons often affect them directly. In the diagram the interaction with the pesticide going down into wastes from the insects and bird consumers show their deaths.

Obviously, the most important component of the residential neighborhood is people. They are the top consumers of the whole system in Figure 20.5. The people work and interact in the local economy, and are paid for many of their interactions. The money earned is used to purchase electricity,

water, and goods and services; thus the money flow is circular.

These residential areas that surround central cities are primarily consumer systems. They consume electricity, water, and goods and services. Their main product is service. Every day, at least one member -- and in some cases several members -- of each household labours in industry, commerce, or government. So the residential neighborhood provides the labour for other productive processes of the modern economic system.

Other "products" are sewage, urban runoff, and garbage. For the most part these products are considered a problem. Sewage, when too concentrated and put in the wrong place, is considered pollution and can be detrimental to the environment. Urban runoff usually carries with it concentrations of pesticides, fertilizers, and other chemicals that cause stress in some surrounding ecosystems. And garbage, when collected and deposited in central locations like dumps and landfills, presents problems because of the concentrations of chemicals and other toxic substances that seep into ground waters.

Many residential areas of developed countries have lawns and formal gardens. These may not be necessary to the economy, and are sometimes maintained in response to social pressure from neighbors. As resources become more expensive, luxury and ornamental management of such landscapes may be replaced by more utilitarian household vegetable gardens already characteristic of many parts of the world.

PART III. THE ECONOMIC SYSTEM

An economy is the total system of resources and energy of a culture. Most often, the economy of a region or country is thought of as its money. In reality, the economy of an area is the way in which its resources and energies are managed. Modern economies are quite complex, having a very wide variety of resources and energy to draw from. The earliest human cultures, on the other hand, had economies that were quite simple, and

by studying them we may gain a better understanding of the relationships of energy and resources to the more complex modern economy of humanity.

In Part III we explore the economies of pre-industrial and modern societies and the energies that drive them. Then we examine alternative energy sources for the future, and what the economy and lifestyles of the future might be like.

21. EARLY TRIBAL CULTURES

The Hunting and Gathering Economy

The simplest economies were those of early cultures that depended on hunting and gathering. In these economies there was little need for money since food, clothing and tools were obtained directly from the environment.

We will use the North American Indians as an example to represent similar early cultures around the world.

During Pleistocene times (about 1 million to 9 thousand years ago) the climate was much different and North America was the habitat for many large animals like mammoths, mastodons, sloths and camels. The earliest Native Americans were hunters and gatherers. They hunted animals, consuming the meat and utilizing other parts like bones and fur for tools and clothing. Plant materials such as roots, fruits, and nuts were gathered from the surrounding landscape and added to their diet. The economy of these early cultures was based solely on the renewable energy flows that were concentrated in animals and wild plant material.

The diagram in Figure 21.1 shows the relationship of these early peoples to their environment. The economy is based on energy from the sun, growing plants and supporting the food chain of animals that the North American Indians relied on. Their economy was a solar energy economy, and could not support a large population. These early Americans occupied the top of a solar energy based food chain. Just as we have seen with the food web of the forest (Chapter 3) and the energy transformation in trophic levels (Chapter 4) the amount of top carnivore that can be supported by solar based food chains is limited by the productivity of the landscape.

In areas where the landscape was productive, North American Indians probably stayed in one place in small settlements scattered widely across the land. Many such cultures had territories that were well guarded to insure that there was enough game and other foodstuffs to support the population. Where the environment was not so productive they adopted a nomadic way of life and moved from place to place in search of game and other foods.

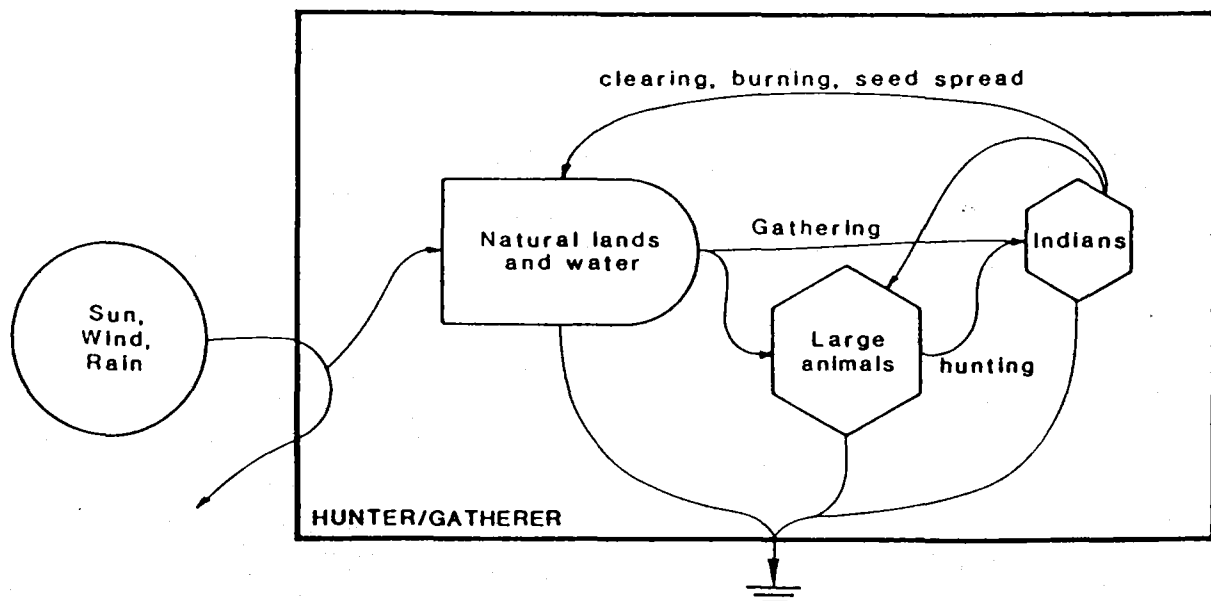

Figure 21.1. Relationship of early North American Indians to their environment

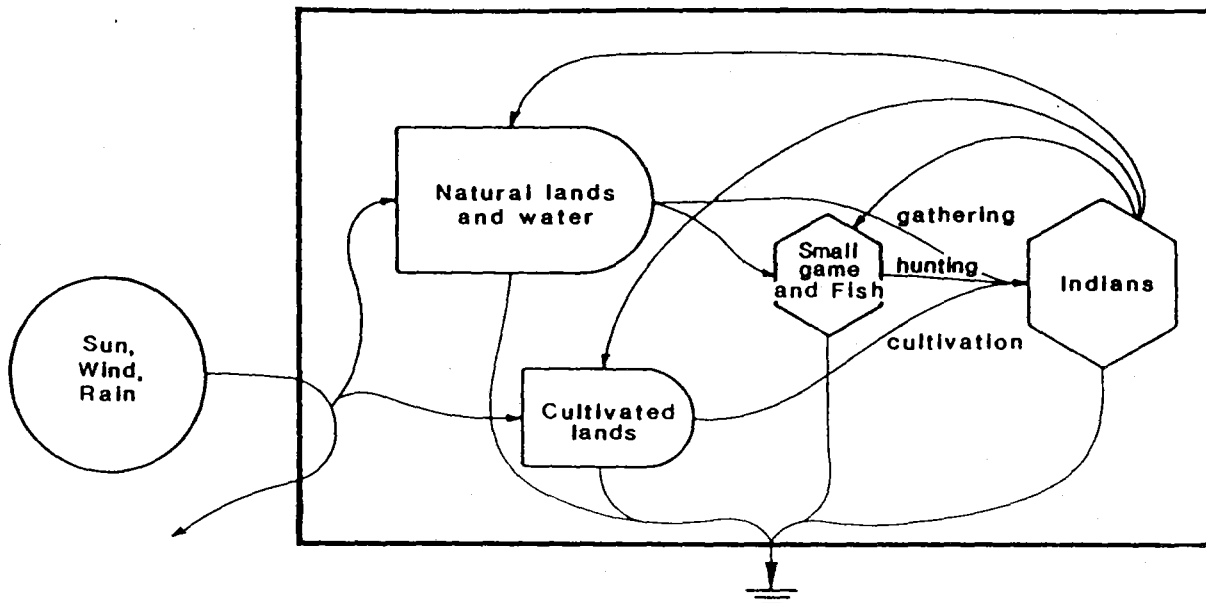

Figure 21.2. New relationship between the American Indians and the environment that developed after agriculture became important.

Early Agricultural Economies

The domestication of grain and other foodstuffs led to a more permanent settlement pattern. North American Indian populations grew as a result of the ability to cultivate crops and increase the productivity of the landscape. The diagram in Figure 21.2 illustrates the new relationship between the North American Indians and their environment that developed after agriculture became important.

Now, not only did the native Americans harvest wild foods like roots, nuts, and game, but they also grew food. As a result of the growing populations of Indians that began to stay in one area, game animals were over-hunted. One theory for the demise of many large animals of Europe and America and large birds in New Zealand is the rise in agriculture and the over-hunting caused by larger more permanent populations.

After the domestication of agricultural crops, American Indian cultures became more complex. Their economy was still a solar based one, but they were able to increase the energy flow into their economy by manipulating their immediate environment. Instead of gathering grain and roots, they cultivated them, increasing yields. There is fairly strong evidence that the various Indian cultures throughout North America began to trade with one another. Most often, they traded food in abundant supply, tools, and information. Some cultures even had a simple form of money in the form of rare shells and stones that were used in trading.

European Contact

By the time of European colonization of North America, the native Indian cultures had developed fairly complex social systems adapted to their environments. Many of these systems were

while others lived off the abundance of the landscape without the need for cultivation of crops. As the influence of Europeans increased, native cultures were displaced and a new cultural system dominated the landscape. This new culture, introduced from abroad, had greater eMergy and was able to exploit the environment more rapidly than the indigenous peoples could.

The diagram in Figure 21.3 shows the relationships between these two cultures in conflict for the same resources. While the North American Indian cultures were based primarily on the flow of solar energy, the invading culture was based on energies and information imported from the "old country", flows of solar energy, and the stored energy in wildlife, wood, and soils. The new inhabitants were not much concerned with maintaining resources because they shifted to new ones when older ones were used up -- a process only now reaching a point of exhaustion.

The more energy intensive culture, that is, the one using more eMergy, displaced the lower energy culture. There were many direct conflicts for the resources of the landscape. North American Indians saw the new inhabitants consuming the game that was once plentiful, cutting the forests to make homes and clearing the land to cultivate crops. With guns, and other technologies brought from the old world, the new culture could manipulate its environment to a far greater degree than the native culture had.

Disease played a large part in the demise of native Americans as they were exposed to numerous diseases for which they had no immunity. In a comparatively short period of time, all but a very few of them were displaced from the landscape. It took only about 100 years for the new colonists to spread across the North American continent from coast to coast establishing settlements and exploiting the resources at a rate

The solar energy based economy of the North American Indians was replaced with an economy that exploited resources exporting much back to the old country in exchange for tools and information. The export and import of goods, information and technology and the immigration of people from the old country shown in Figure 21.3 are what made the new economy more energy intensive and able to replace the native economy.

This diagram illustrates the beginnings of modern economies where money plays an important role and where trade with other nations is an important energy source.

Learning from the Past

In Chapter 4 we introduced the principle of the feedback provided by the higher quality consumer to sustain the pattern of basic productivity in the system. Examples were given of farmers fertilizing their crops and seed-eating birds spreading seeds.

In a similar way, the native North American Indian pattern of humanity and nature may have involved human actions with a cultural basis that resulted in stability for the human consumer. The consumer in return, may have performed special work for the environment -- work that required intelligence, ability to travel, and persistence over long periods of time. Developing diversity through clearing, patch-burning, spreading of seeds and shifting agriculture are examples of tribal roles in organizing the landscape.

The principles involved in modern relationships between humanity and nature are basically similar. Men and women return services to the landscape in order to maintain productivity, diversity, stability and a pattern of long-range survival. In many ways we can learn from past cultures and their relationship to the landscape and develop a steady-state relationship of humanity and nature when needed.

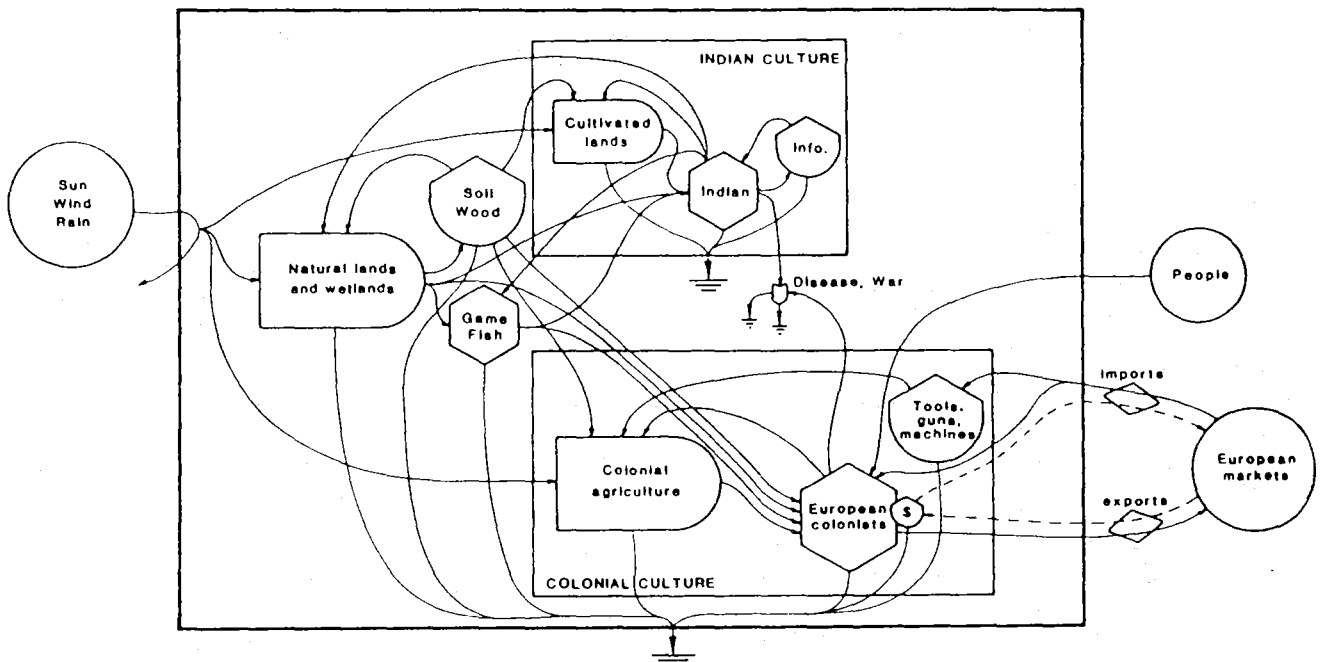

Figure 21.3. Relationships between two cultures in conflict for the same resources.

22. ENVIRONMENTAL BASIS FOR A NATIONAL ECONOMY

The environmental basis for the economy of a nation consists of the various resources inflowing across the boundary such as sun, wind, rain, tide, migrating animals, etc., plus the stored resources within the boundary such as mineral deposits, wood, fishery stocks, soils, etc. The eMergy concept can be used to evaluate these resources and estimate their contribution to the economy of a nation.

Diagram of a Country

The way environmental resources support a national economy can be shown with an energy diagram, such as that for New Zealand in Figure 22.1. Notice how the environmental sources are

transformed by environmental sectors whose products are used by the economy. Dashed lines (money flows) indicate the economic pathways.

The overview diagram contains, from left to right, the environmental areas and rural farms, business and industrial sectors, household consumers, governments, and information centres. The environmental and rural systems receive the energy inflows of sun, wind, rain, and geologic processes. These systems are the areas of plant photosynthesis, where growing vegetation adds to the storage in forests and wild environments, or is harvested and consumed. Coastal areas receive wave and tides which generate valuable services for both the environment and the economic system.

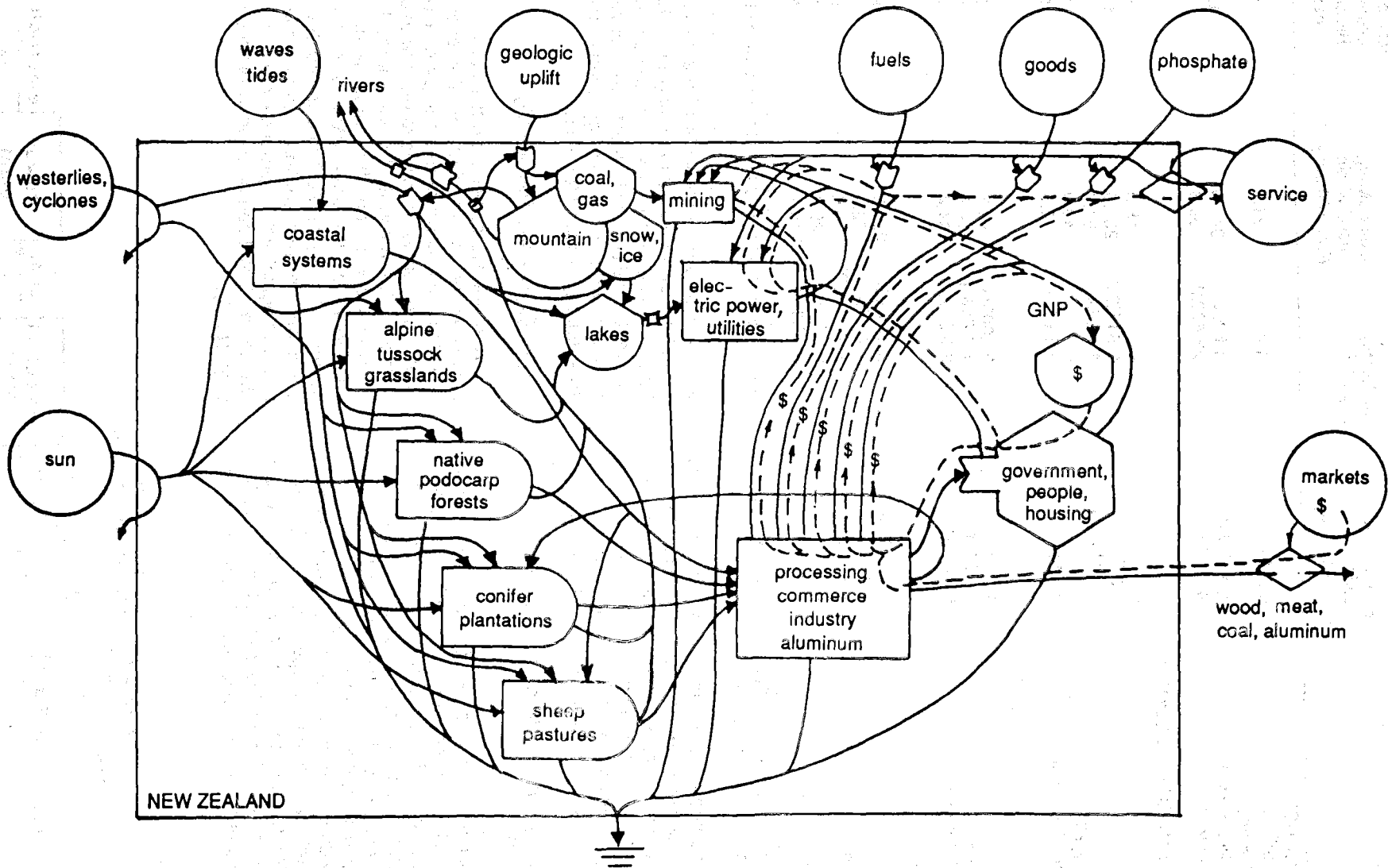

Figure 22.1. Overview energy diagram for New Zealand.

Table 22.1. Characteristics of New Zealand's use of energy sources in 1980.

Source	Energy flow used within N.Z. J,T, or \$	Transformity sej/J,T,\$	Solar eMergy used within N.Z., E20 sej/y	Macroeconomic value ^a in 1980 Billion dollars per year
FREE SOURCES				
Direct sunlight	23.7 E20 J	1/J	21.2	0.81
Oceanic energy (wind, rain, waves)	22.1 E17 J	1.6 E4	341.0	13.1
Tide absorbed	4.1 E17 J	23,600/J	96.6	3.7
USE OF INTERNAL RESOURCES				
Wood	--	--	15.9	0.61
Wool	7.5 E15 J	3.84 E6/J	287.0	11.0
Meat	3.05 E15 J	1.7 E6/J	51.8	1.99
Coal, gas, oil	--	--	40.0	1.53
Geothermal electricity	3.77 E15 J	1.6 E5/J	6.0	0.23
IMPORTS				
Fuel oil	1.78 E17 J	53,000/J	94.3	3.6
Phosphate	1.2 E6 T	1.4 E16 T	170.0	6.5
Services in imports	5.17 E9\$	2.6 E12/\$	134.4	5.2
EXPORTS				
Wool	5.96 E15 J	3.84 E6/J	229.0	8.8
Meat	3.05 E15 J	1.71 E6/J	52.0	2.0
Aluminium	1.2 E5T	1.63 E16/T	19.6	0.75
Iron ore	3.5 E6 T	9.5 E14/T	29.7	1.14
Services in exports	5.15 E9 \$	3.4 E12/\$	175.1	6.73

^a Macroeconomic value, in 1980 \$, obtained by dividing the solar eMergy in column 3 by the eMergy/\$ ratio of the international U.S.\$, 2.6 E12 sej/\$.

The components to the right are consumer sectors, mainly located in cities and towns. Energy and resources are exported in exchange for money that flows into the storage of money within the local economy. This money, in turn, is used to purchase goods, services, and fuels from outside sources.

Evaluating a Nation's Resource Basis in Solar eMergy Units

As shown in the New Zealand example in Figure 22.1, each country has a different set of resources which affects the culture and determines the occupations of its population. In general, the set of resources and their long-term effect on the culture give the nation its unique character.

To evaluate the total contributions of resources to economic wealth, an eMergy analysis table may be constructed, like that for New Zealand in Table 22.1. Each line of the table evaluates one of the resource inputs to the economy. Some, like wind

and waves, are by-products of the same process and may not be added in getting the total eMergy input. Since each type of resource input is of different quality, each must be converted into common units, solar eMergy (solar equivalents, solar energy required for a flow).

Energy Quality and Transformity

When we are considering the ability of different energy forms to contribute to the economy, we must take into account the energy quality of each form. One way to do this is to replace each energy source by the amount of solar energy that would be necessary to do the same work. This is referred to as the solar eMergy of that energy source. As Figure 22.2 shows, 40,000 joules of direct and indirect sunlight acting through plants and geological action produce one joule of coal. One joule of coal can be used to produce 1/4 joule of electricity.

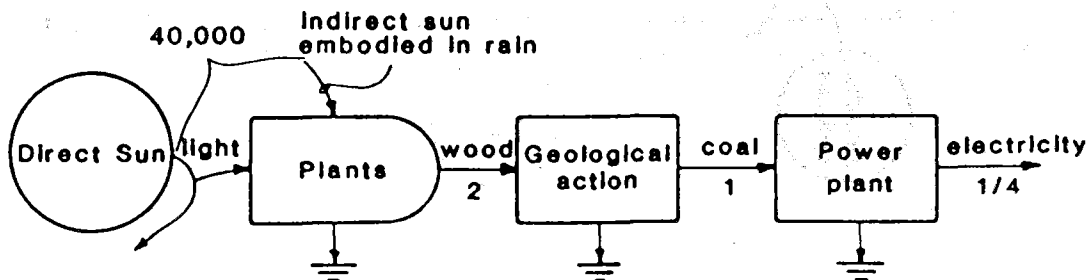

Figure 22.2. Energy quality chain used to calculate solar eMergies processed to generate one joule of coal and 1/4 joule

Table 22.2. Energy evaluation of resource reserves of New Zealand.

Type of energy	Stored energy E18 J	Transformity sej/J or sej/g	Solar emergy stored E20 sej	Macroeconomic value ^a in 1980 Billion dollars
Coal	57.0	4.0 E4	22,800.0	876.9
Natural Gas	6.9	5.3 E4	3,657.0	140.6
Native wood	82.6	3.23 E4	26,680.0	1,026.1
Plantation wood	7.8	6.22 E3	485.0	18.6
Topsoil	142.0	2.5 E6	3,550,000.0	13,653.8
Iron sands, 856.0 E12 g	--	8.6 E8/g	7,361.0	283.1
Lignite	61.0	3.8 E4	23,180.0	891.5
Geothermal heat				
700 - 1800C	47.0	6.1 E3	2,867.0	110.2
<1800	31.0	1.5 E4	4,650	178.8

^a See footnote in Table 22.1.

The solar emergy required per unit energy is the solar transformity of that type of energy. In Figure 22.2, the solar transformity of wood is 20,000 sej/J (40,000 sej/2J wood). The solar transformity of coal is 40,000 sej/J (40,000 sej/1J coal). The solar transformity of electricity is 160,000 sej/J (40,000 sej/0.25J electricity). Transformities like these, calculated from data on environmental energy flows, are used in emergy analysis tables like Table 22.1.

Transformity is a measure of the quality of energy. As in Figure 22.2, low quality energies with low transformities are drawn on the left side of systems diagrams and higher ones on the right.

EMergy Sources for New Zealand

Table 22.1 summarizes the emergy analysis of the annual inputs to the economy of New Zealand. Table 22.2 summarizes the emergy analysis of the stored resource reserves in New Zealand. In column #1 data on energy, materials, and services are given as obtained from various statistical abstracts. In column #2 are the transformities of these items. Column #3 contains the solar emergy flows obtained by multiplying the data of column #1 by the transformities in column #2. Results of the calculations of solar emergy inflow to the economy are also shown diagrammatically in Figure 22.3.

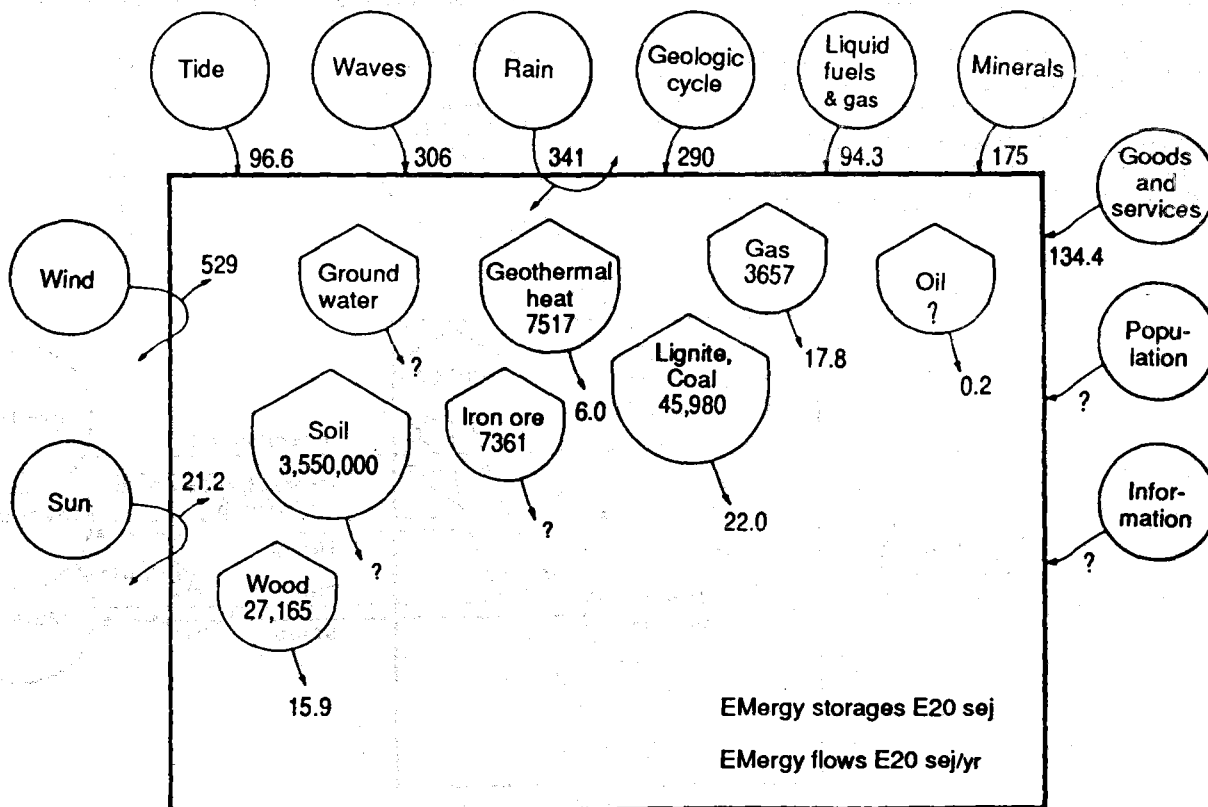

Figure 22.3. New Zealand sources in 1980. The various kinds of energy have...

For New Zealand the major inflows of eMergy are wind, rain, liquid fuels, and phosphate fertilizer. The greatest use from stored resource reserves within the country is coal. The renewable resources, sun, rain, wind, waves, geological work, and tides give a large contribution to economic value, but not enough to run the nation at its present level of economic activity alone.

Finally, the last column of the tables gives the macroeconomic value of the inputs to the economy in dollar units, by dividing the solar eMergy values from column #3 by the solar eMergy/dollar ratio of the international US\$ for that year (see Chapter 23).

National eMergy Summary

An overview of the resource basis for a nation is provided by a summarizing diagram like that for New Zealand in Figure 22.4. Solar eMergy flows evaluated in Table 22.1, Table 22.2 and Figure 22.3 are combined in a simpler diagram, Figure 22.4. Because several environmental inputs are by-products of the same coupled geologic, oceanic, and atmospheric process, we can avoid double counting the solar eMergy contribution by using only the largest of these in our totals for the country. Shown in Figure 22.4, the annual solar eMergy budget for the country was 87.6 E21 sej/yr, which is the sum of the renewable input (43.8 E21 sej/yr), the fuels used (30.4 E21 sej/yr), and the imported goods and services, 13.4 E21 sej/yr. New Zealand is more self-sufficient than many countries and has a higher proportion of its economic basis from renewable sources. The largest resource reserve appears to be the soils (Table 22.2), some of which are being lost in intensive agriculture.

Using Local Resources to Gain Outside Resources

The role that environmental resources play in a country's economy is shown in Figure 22.5. Exports of goods, services, and attractions are generated first from local environmental resources. The money from these is used to purchase additional imports such as fuels, goods, and

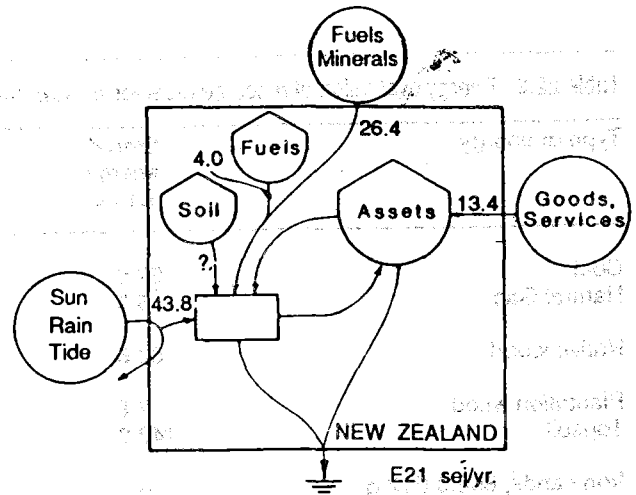

Figure 22.4. eMergy sources for New Zealand in 1980.

services. Careful use of the environment is important to gaining additional outside resources.

People from outside have a mental picture of what a country is like. These mental pictures are the country's image. A favourable image attracts investments, tourists, immigrants, and other sources of money and eMergy. Image is an information storage that takes time to build and doesn't change until people die, forget, or receive new information. In Figure 22.5, image is shown as part of the mechanism of attracting outside resources.

Differences Among National Systems

Different countries have various combinations of resources. Notice similarities and differences in national diagrams for Brazil, Dominica, Liberia, India and Spain (Figures 22.6-22.10). Some comparisons are discussed in Chapters 28 and 29.

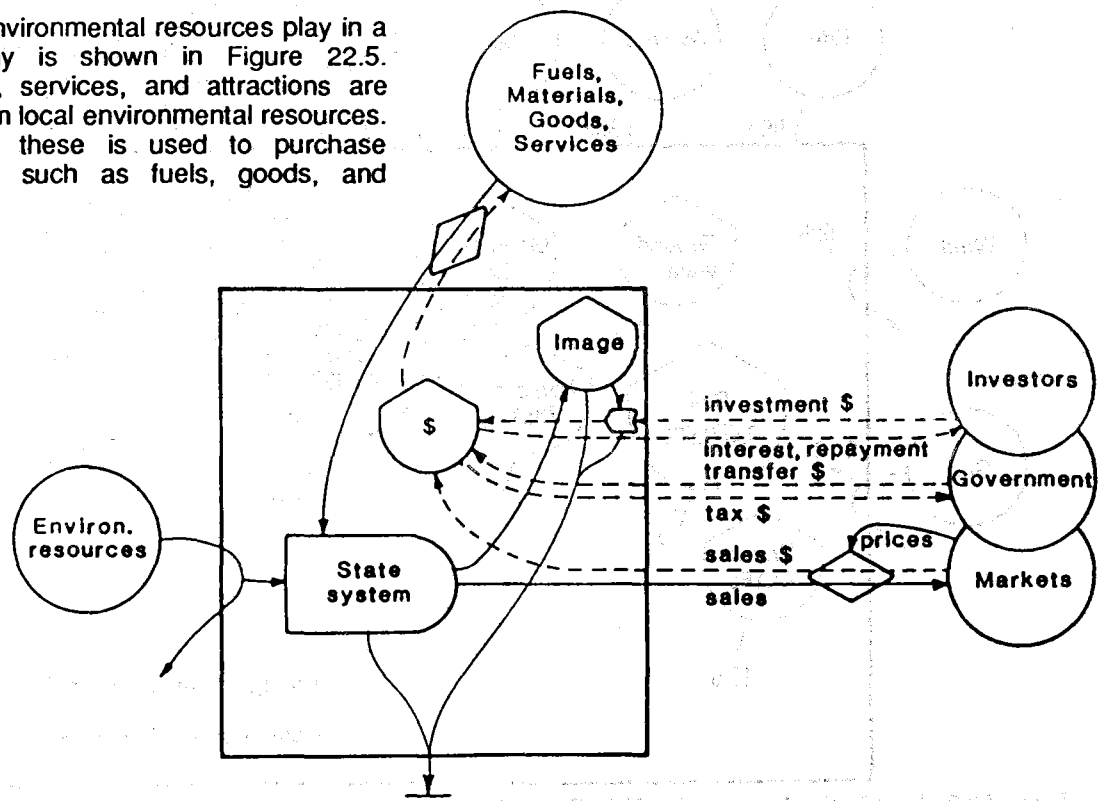

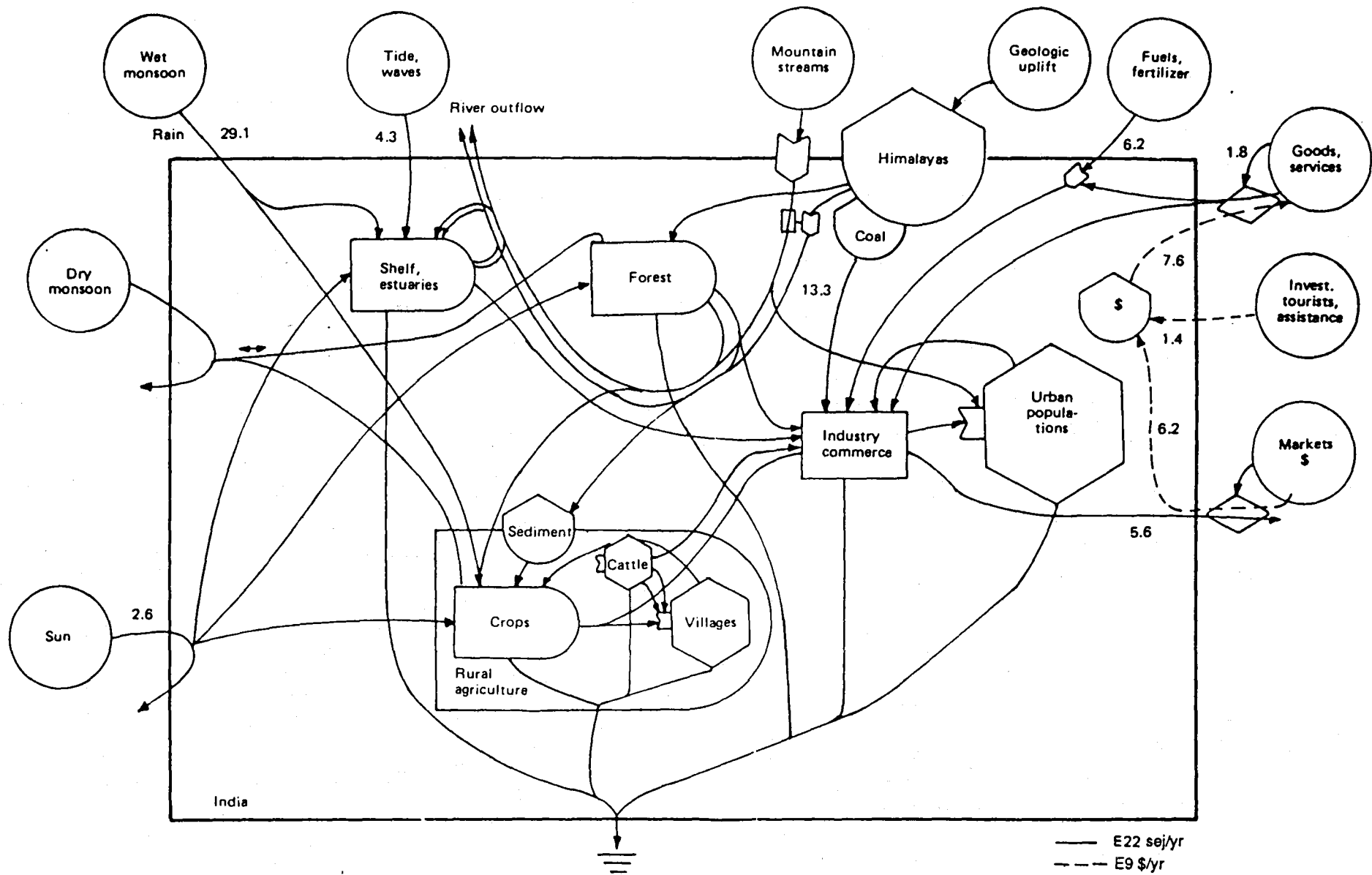

Figure 22.8. Energy diagram for India

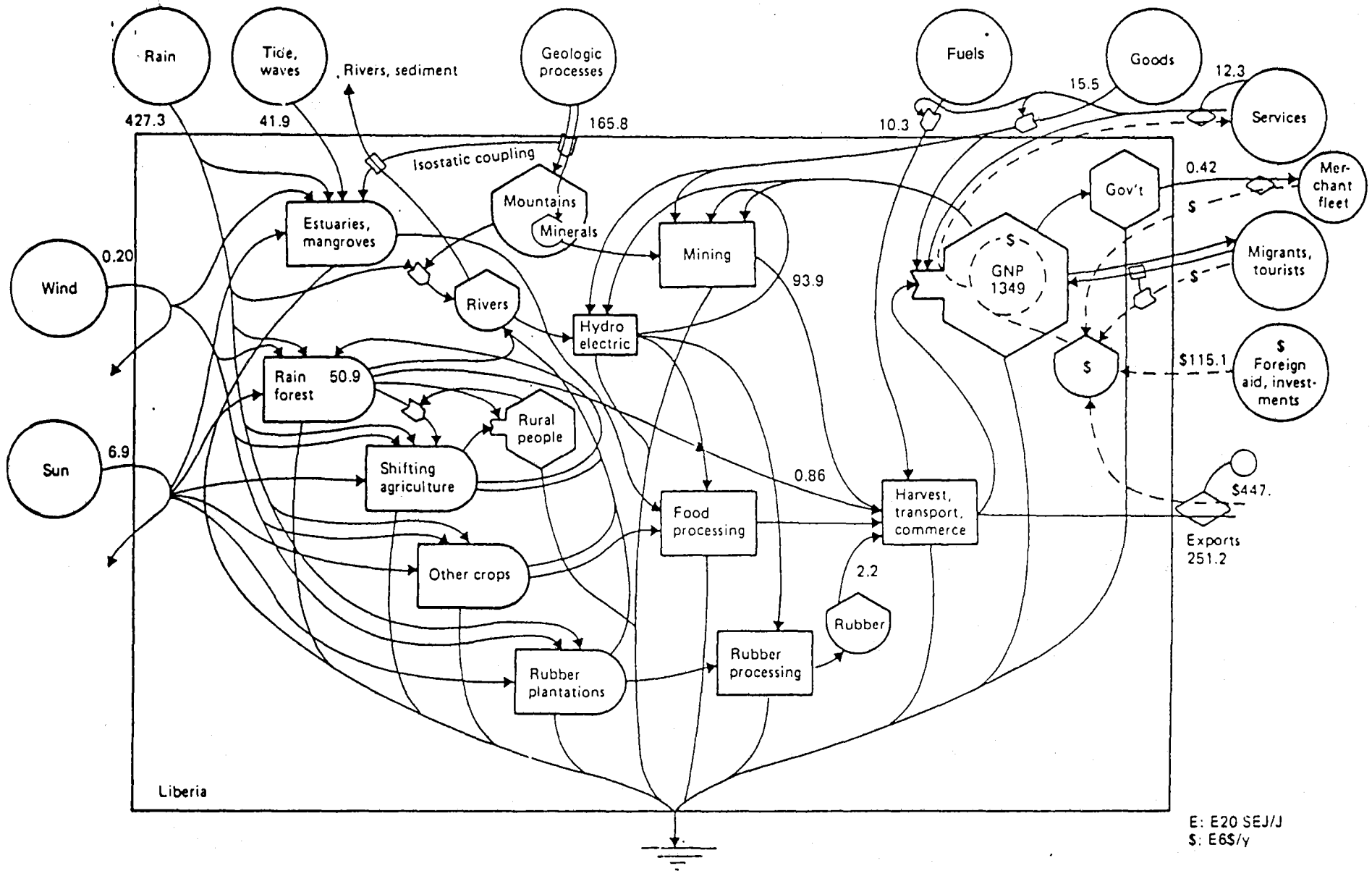

Figure 22.9. Energy diagram for Liberia.

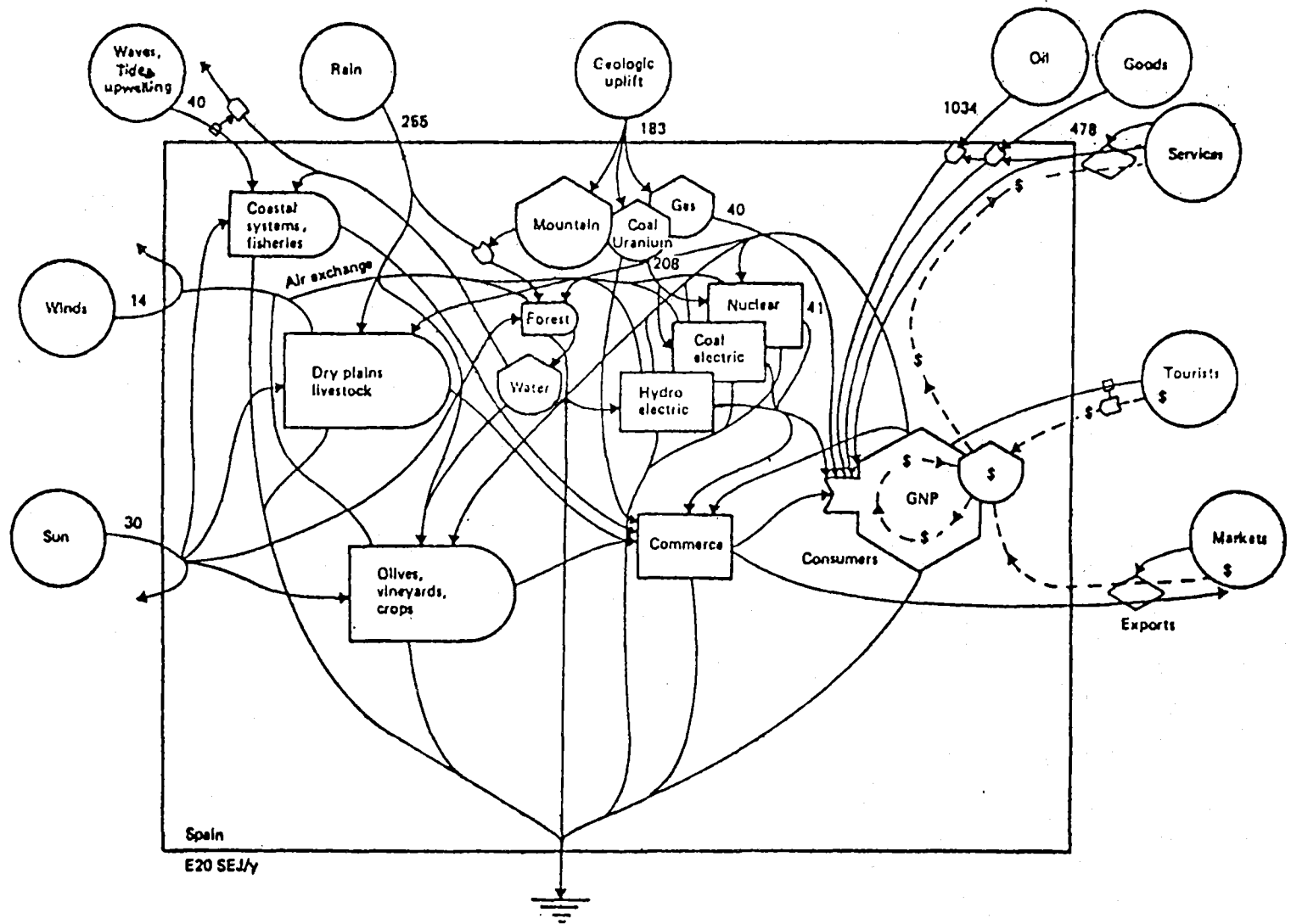

Figure 22.10. Energy diagram for Spain.

23. EMERGY AND NATIONAL ECONOMICS

The economic system of a country uses the flows of energy, materials and services from environmental resources to generate products which are used by consumers, who in turn provide human labour. The real wealth from use of energy, materials, and services can be evaluated with the eMergy measure, and this was done for the New Zealand economy in Chapter 22 by summing the solar eMergy of the resources used.

Money circulates between people for their services in processing materials, energy, and goods. Market prices of an item measures its value to humans at that time and place. Because prices go up when items are scarce, more money goes to those processing scarce items. More money attracts more services which helps eliminate the scarcity. Thus, money circulating among people helps eliminate bottlenecks, making the economy more productive.

Without high eMergy resources, products, and services to buy, money is worth nothing. Without money, an economy is primitive and inefficient, and resources are not used effectively.

Relationships Between EMergy and Money

When flows of eMergy and money are shown on the same diagram, as in Figure 23.1, we see that money and energy flow in opposite directions. The diagram shows a system aggregated into two economic sectors (farm and city) and operating on sun, rain, and fuels. In this simple economic system, the meat products and crops from the farm flow into the city for which the farmer is paid money -- shown as a dashed line flowing in the opposite direction back to the farm.

The money circulates in a closed loop. The energy from environmental sources is transformed in production and leaves the system through the heat sink. The used energy cannot be reused to do work.

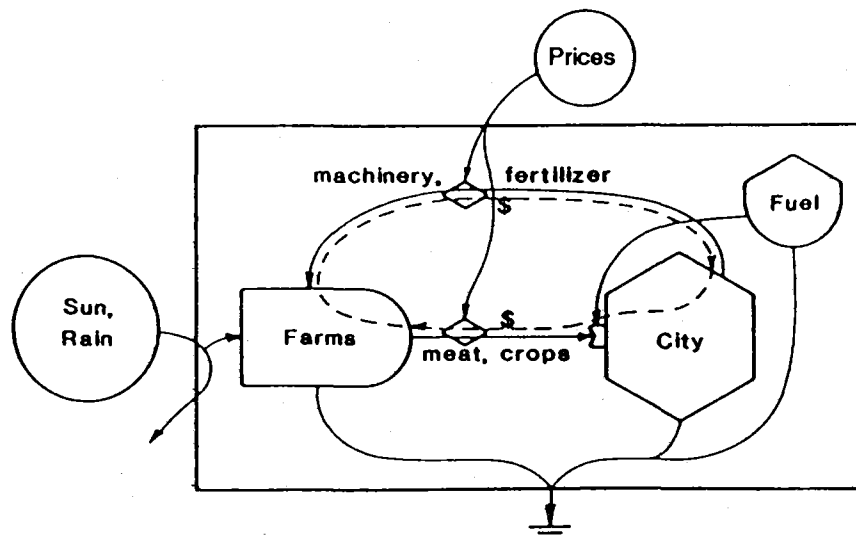

Figure 23.1. The basic pattern of a national economy, showing how money and energy flow in opposite directions.

National EMergy Sources and Circulating Money

In Figure 23.2 circulating money has been added to the diagram of eMergy sources operating the New Zealand economy previously given as Figure 22.4. Notice its circulation in the opposite direction from the real wealth.

A National EMergy-Dollar Ratio

The eMergy used per dollar circulated in a nation may be calculated by dividing the annual eMergy budget for a country by the circulating dollars for that year. For New Zealand in 1980, in Figure 23.2, the eMergy/dollar ratio is 3.4 E12 sej/\$ (obtained by dividing 87.6 E21 sej/yr by 26 E9 \$/yr). Rural nations with many people using free environmental products have a high eMergy/dollar ratio. Money buys more real value in these countries.

Using the eMergy/dollar ratio, it is possible to evaluate human services. If a person is paid \$14,000 per year when the eMergy/dollar ratio is 3.4 E12 sej/\$, this represents an eMergy contribution of 4.8 E16 sej/yr.

EMergy and Inflation

The buying power of money is the amount of goods and services you can buy with a unit of currency. The eMergy/dollar ratio expresses this buying power. In 1980, when one New Zealand dollar was being exchanged with the international U.S.dollar one-for-one, a dollar purchased 3.4 E12 sej of goods and services. Now look at Figure 23.2 and imagine what will happen if the eMergy flowing into the economy decreases while the circulating money is unchanged. The eMergy/dollar ratio will be less. A dollar now buys less eMergy. The loss of buying power is inflation.

The ratio can also be decreased by circulating more money. Many nations encourage some

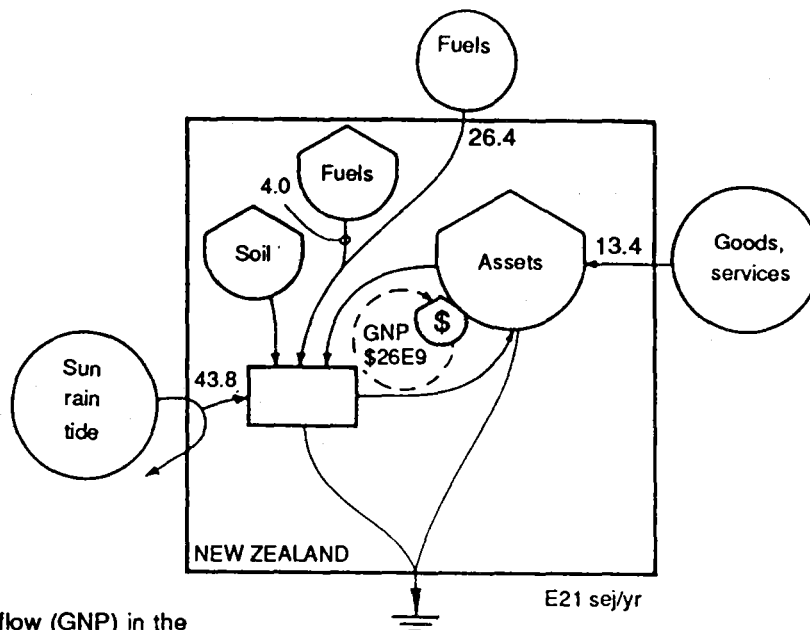

Figure 23.2. Total eMergy and dollar flow (GNP) in the New Zealand economy in 1980. The total eMergy budget is 87.6 E21 sej/yr.

inflation on purpose, because circulating more money is believed to stimulate economic growth. The declining value of the U.S. dollar due to inflation is shown in Figure 23.3. The U.S. dollar is often used as a currency for international transactions. For example, oil transactions are usually made in U.S. dollars.

A National Summary Diagram that Includes Foreign Trade

In Figure 23.4 is a three sector diagram of a national economy that also includes imports and exports. The first sector of the economy on the left is the work of nature without people, and it receives no money. However, this natural sector does receive wastes from the economy and management actions as diagrammed. Money circulates between the economic production sector and the final consumer sector and goes out in exchange for imports and is received in exchange for exports.

Input-Output Table

The circular pathways of money (dashed lines) in Figure 23.4 may be represented in another way in an input-output table. Table 23.1 is an input-

output table for the flows of money in New Zealand diagrammed in Figure 23.4. Each item in the table represents the dollar flow of one of the pathways in the diagram. The sum of the columns added down is the money paid for items consumed. The sum of the rows added across is the money paid for goods produced by that sector.

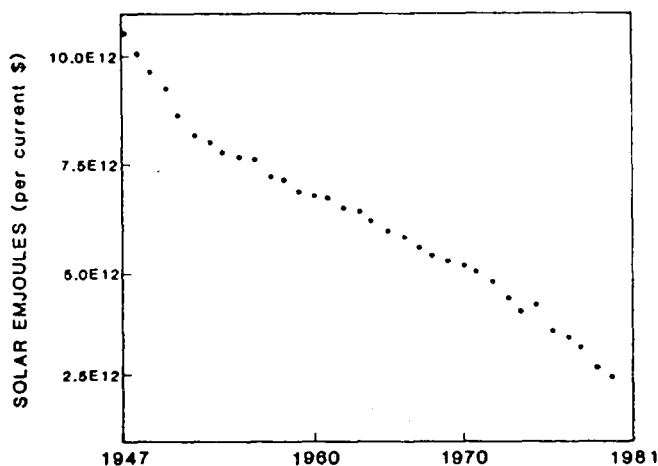

Figure 23.3. Ratio of eMergy flow (sej/yr) to U.S. dollar flow (GNP) in recent years (Odum and Odum, 1983). Included is the eMergy in rain and the eMergy of fuels, hydroelectricity, and nuclear power, all in solar emjoules.

Table 23.1. Simplified input-output table for New Zealand. Units are billion dollars in 1980.

From:	To:			Totals
	Producers	Consumers	Exports	
Producers	--	24.0	5.2	29.2
Consumers	26.0	--	--	26.0
Imports	3.2	2.0	--	5.2
Totals	29.2	26.0	5.2	

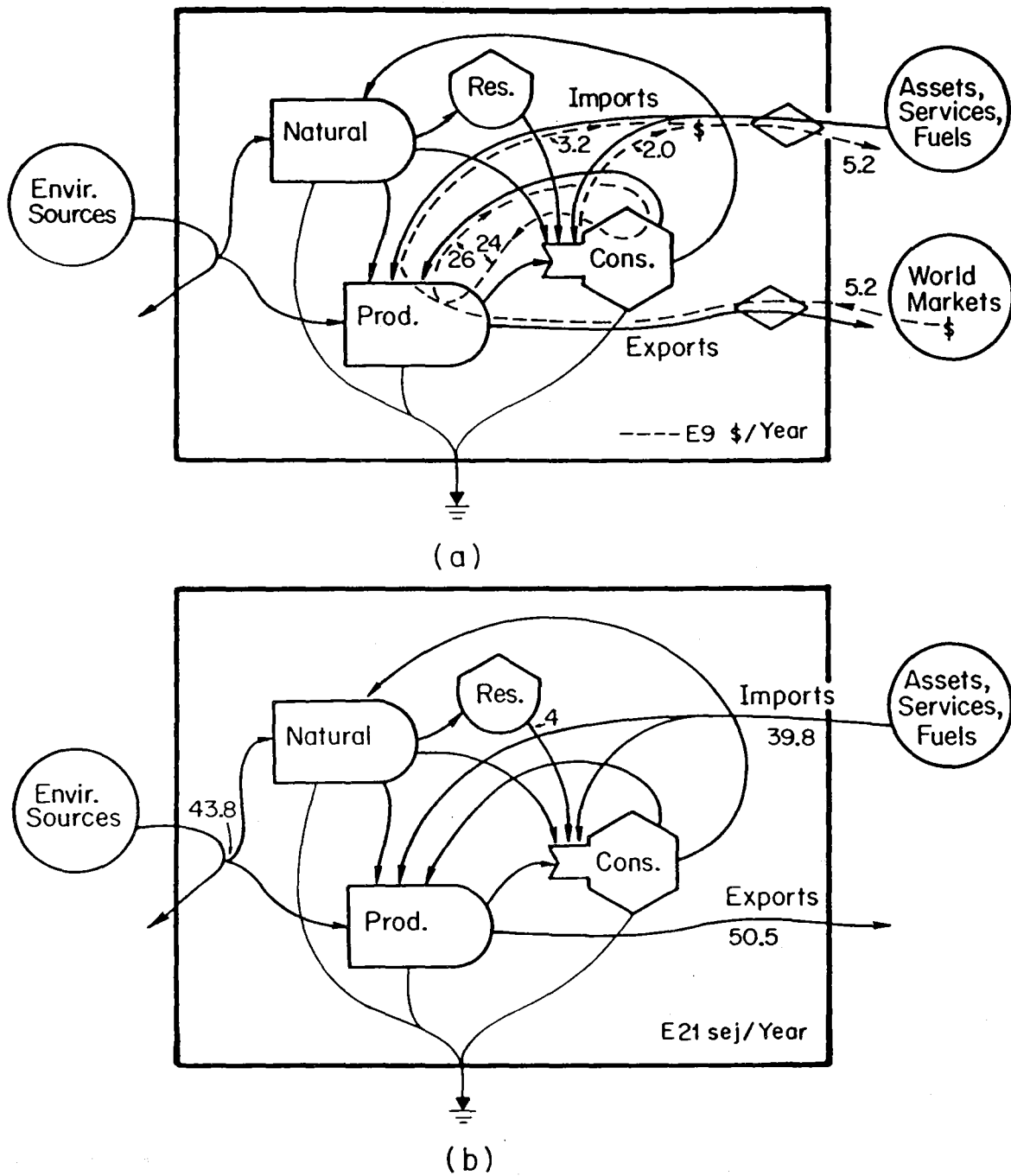

Figure 23.4. National economy of New Zealand drawn as three sectors including imports and exports. Res, resource reserves; Prod., economic production sector; Cons., final demand consumers and government. (a) Money flows in billion dollars per year. See also Table 23.1. (b) Inflows of solar eMergy supporting the economy.

Gross National Product

The money circulating between producers and final consumers is called the gross national product, abbreviated GNP*. Final consumers are the people and government. Notice the money circulating in Figures 23.2 and 23.4. GNP is a measure of all the products generated for consumer use and includes those obtained from imports as shown in Figure 23.4. The GNP is used as a measure of the size of an economy. For New Zealand in 1980 the GNP was 26 billion dollars (26 E9 \$).

However, since money does not measure nature's contributions, and since inflation may change the value of money from year to year, a better measure of a nation's economy is the total solar eMergy used by the economy to generate wealth. For New Zealand in 1980 this was 87.6 E21 sej/yr as given in Figure 23.2.

Circulation with Resource Use

Figure 23.5 shows the way money circulates when an environmental resource (flow, storage) is used. Wood generated by forest growth on the left is first processed and sold at A, passing to the right in exchange for money (dashed lines). The money received in payment goes back to the right to buy goods and services needed to process the wood. For example, forest trees gathered by a forester may be sold to a sawmill. The forester uses the money to buy machines, fuels, and labour of others to help in the cutting and gathering. Money is paid only to people in the economy on the right, not to nature for its part of the work on the left.

*The exact definition of GNP includes money flow to households and government, plus increases in the economy due to growth. Money circulating among households and government is not included.

From B through F the wood goes to others in sequence for transportation and further processing, until it is used by final consumers. For example, the sawmill in turn sells finished lumber to a lumber yard using the money received to buy electricity, sawmill machinery, services, etc. At each step along the way to becoming a finished product, more services are added, and the price increases to cover each additional input.

As shown on the left in Figure 23.5, part of the energy driving the entire process comes from the sun, wind, rain, and soil nutrients. The rest of the energy comes from sources driving the main economy from which inputs are bought. These are shown coming from the right.

Economic Values of a Resource

As a resource is used there are several economic values, each expressed in money units. In the case of wood processing in Figure 23.5, the money used to pay the first processor at A is much less than that paid by the final consumer at F. Sometimes we think of the price paid to the first person, the forester, as the value of the wood. This is one value, to be sure, but the value of the wood to the public economy is all the money that circulates as a result of the resources being processed and used.

eMergy and Macroeconomic Value

The contribution of the wood to the economy may be calculated in eMergy units. For New Zealand in 1980, wood contributed 1.6 E21 sej/yr. This is 1.8% of New Zealand's total annual eMergy budget.

The dollar circulation calculated from eMergy is defined here as macroeconomic value. To evaluate the macroeconomic value of the New Zealand wood, multiply 1.8% times the GNP. The result is 468 million dollars per year (0.018 * 26E9 \$/yr).

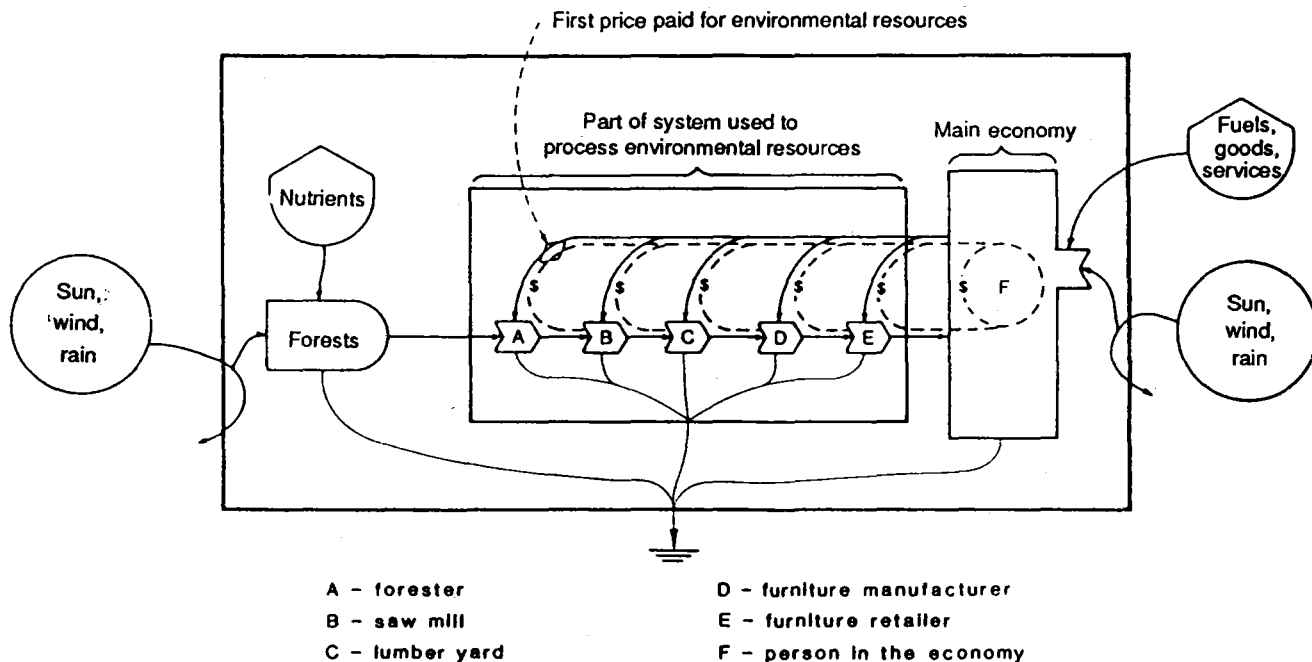

Figure 23.5. Diagram of the way storages of environmental products are processed in steps each of which circulates additional dollars.

24. ECONOMIC IMPACT ON ENVIRONMENT

The economy not only receives its energy and raw materials from the environment, but it acts on the environment by releasing wastes, developing new land uses, adding chemicals to agriculture, and controlling the organization of the landscape with roads, railroads, power lines, and communication networks. In other words, the economy and the environment are in a symbiotic partnership, as shown in Figure 24.1. Many problems with environmental impact can be solved by recognizing the natural geological/environmental cycles and the way to draw useful materials from them and return materials to the cycles without wastes accumulating.

By-products or Wastes?

A good system, whether it is an ecosystem or an economy, uses all its by-products to improve its efficiency. Whenever there is a by-product in an ecosystem, the great diversity of organisms that are part of the earth's special pool usually has some that can use and benefit from the product and then become important parts of that system.

Similarly, an economy that does not use by-products for useful purpose is less efficient and does not compete well economically. For example, putting wastes in dumps and landfills is poor practice. Reusing glass, plastic, wood, metals, etc., within the economy saves costs of replacing the items and the costs of waste reprocessing and storage.

Those by-products that are not easily reusable should be returned to the environmental cycle in a form that can benefit their service to the biosphere. Examples of this are recycling treated sewage waters to wetlands where water is conserved, tree and wildlife growth stimulated, and treatment costs reduced.

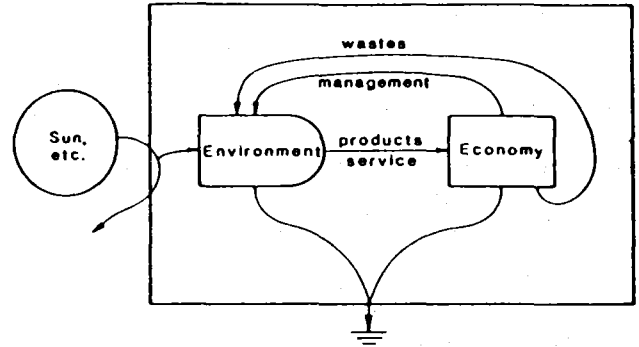

Figure 24.1. Diagram of environment and the economy.

Unused wastes are "pollutants", but by-products that are reused or recycled are a benefit.

The Sulfur Cycle

Sulfur is an element required in tiny amounts for life. As sulfate it is one of the abundant salts of the sea. Sulfur is rarely limiting to plants except in very poor soils or swamps far from the ocean. Plants use sulfur to make organic matter, and it is passed up the food chain and released in wastes and decomposed to return as sulfates to the water. This part of the cycle, in Figure 24.2, is like the phosphorus cycle in Figure 2.2.

Some of the organic matter from plant production, with its sulfur, goes into peat and into aquatic sediments which eventually become coal and oil. When water percolates through organic deposits, the sulfates in water are changed to

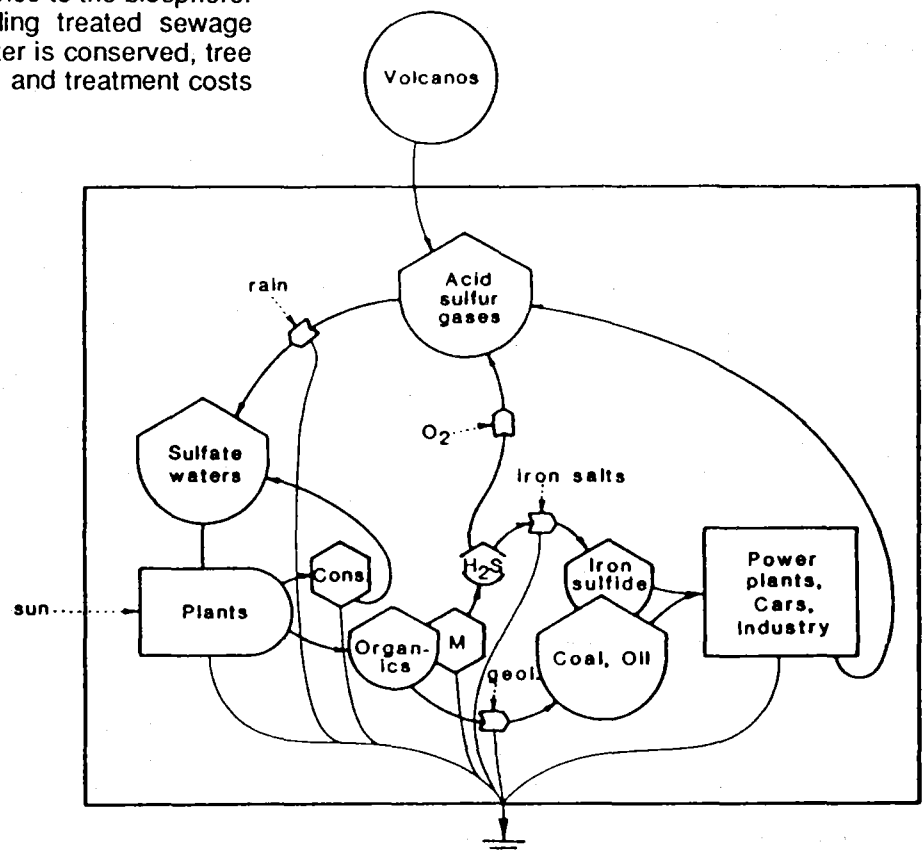

hydrogen sulfide. Some of this reacts with oxygen in the air to become acid sulfate again. Some reacts with iron salts to form particles of iron sulfides (yellow mineral, called "fools' gold"). This is how coal and oil become enriched with sulfur.

Acid Rain

Then, when coal and oil are burned, the sulfide minerals combine with oxygen to form sulfur gases (SO_2 and SO_3). When these gases mix with rain, sulfur acids form. The rain becomes acid. Some nitrogen acids are also contributed by similar processes.

When acid rain falls in mountain lakes, the acid dissolves aluminum that later clogs up fish gills. Acid rain also leaches nutrients out of soils. Many trees are being killed by acid rain. Countries which are down-wind from the industrial areas of the world are being damaged by acid rain.

If acid rain falls on limestone (calcium carbonate) rock, or soils with limestone particles, the acid is neutralized. These areas are less affected by acid rain than areas without limestone.

Smog

The combination of smoke and fog is called smog. It is an especially serious problem in areas which have atmospheric inversions (a layer of warm air over a colder layer at the ground), causing the smoke from local industries to settle over the city. Inversions prevent air near the ground from mixing upward. Smog causes respiratory problems and damage to plant and tree growth. London, Los Angeles, Madrid and Mexico City are examples of cities that have enough smog to cause difficulties.

Carbon Dioxide Accumulation and the Greenhouse Effect

Modern industry is putting out carbon dioxide (CO_2) faster than the world's trees and other plants are using it. Also, the area of green plants is less now than before because humans keep more of the ground bare. The percentage of CO_2 in the air has increased about 20% over the last century. This extra layer of CO_2 in the atmosphere acts like the glass of a greenhouse to keep heat in. The effect this extra heat has on the world's atmosphere and climate is the subject of much scientific study and controversy.

One theory states that the rise in temperature caused by the increase in atmospheric CO_2 will cause increased heating around the earth, and that this will melt the polar ice caps and cause higher sea levels.

Another theory says that the extra heat causes temperatures of the tropical seas to rise, causing more evaporation of water, which causes more clouds, rain and snow away from the tropics. At the poles, this precipitation is in the form of snow. Extra snow and ice reflect more light, which causes the polar areas to become colder and build up even more snow and ice. When there is more snow and ice during the winter than can melt in the summer, permanent snow fields and glaciers like

up water in ice over land causes sea levels to go down around the world. With colder poles and warmer seas, the temperature contrast is greater. Since the weather system is a heat engine running on the contrast in temperature between tropics and poles, a greater temperature contrast makes winds and storms stronger.

Whether sea level is falling or rising now is not clear. The annual world fuel use is only increasing slightly now. Soon, because of unavailability of fuels, the rate of total fuel consumption of the world will start decreasing. The present higher levels of CO_2 cause the existing plants to photosynthesize more. With less fuels to rely on, more of the earth will be managed in green cover again. The CO_2 content should start to decrease again.

Ozone

The layer of ozone (O_3) in the upper atmosphere absorbs most of the ultraviolet (UV) light from the sun. Too much ultraviolet light can cause damage, like sunburns and cancer, in people. Another controversy is whether some chemicals like chlorofluorocarbons and freon are causing destruction of the ozone layer.

Ozone is also formed in smog when sunlight acts on chemicals from industry. High concentrations cause damage to trees and respiratory problems in humans. Putting too much industry in one area where winds are light and inversions occur delays the normal air purification process of the oceans and atmosphere.

Excess Nutrient Eutrophication of Waters

Too much enrichment of water is caused by runoff of fertilizers from agriculture, storm runoff from cities, detergents, wastes from mining, and human sewage. When these wastes add nutrients (phosphorus, nitrates and potash) to rivers or lakes, they may cause too much eutrophication and too irregular input. The nutrients stimulate growth of algae and plants which interferes with uses of water for drinking or recreation. Erratic inputs cause surges in growth followed by periods of excess consumption that uses all the oxygen and kills the fishes.

Toxic Chemical Wastes

A major problem now wherever there are industries is toxic chemical wastes. Storing in dumps is only a temporary solution, and seepages can poison water supplies. Some compounds that nature cannot detoxify should never be manufactured. Others that nature can handle have to be put back into appropriate ecosystems in low concentrations and away from people.

Recycling is the solution to most pollution. Waste waters should be run through wetlands, but with a volume within the natural range. The wetland trees and grasses can use the nutrients to increase their growth and can absorb heavy metals into their biomass. The excess water, after being cleansed by the plant life, can percolate through the soil into the ground water. Even the acids in the waste waters from mining can be reused by

Solid Wastes

Solid wastes include materials such as household trash, old cars and machinery. Waste disposal in cities is very expensive. The usual method of landfill has two other serious problems: it takes valuable space and toxic wastes often leak out to poison ground water. Recent studies have shown that recycling is not only cheaper but can be a positive contribution to the economy. The process is to first separate out reusable glass and metals, and then shred the remaining paper and plastics to be used as mulch for soil rebuilding in forests.

Channelization and Dredging

Dredging channels for shipping and flood control has rerouted and disturbed many rivers and estuaries. Whereas an economic value is increased by developing water transportation, much of the dredging has unnecessarily lost other values important to the economy. For example, draining and diking wetlands removes the many services of wetlands such as the purifying of water, the receiving of sediments that enrich soils, and the nourishment of rich wetland forests.

In many areas, like the Netherlands and the deltas of the Nile and Mississippi rivers, constant engineering of dikes is necessary, working against the energies of nature. As fossil fuels become harder to get and more expensive, some of this work will stop and the lands and waters will revert to their natural states. Planning human settlements so as to be in harmony and use natural works is better than spending scarce resources working against a potential source of benefit.

25. FUELS AND ELECTRICITY

We have seen how energy sources drive an economy and that the renewable energy of nature makes an important contribution to the economy. Most people think of such energy in terms of fuels and electricity. These are the rich forms of energy which have been exploited in this century and form the basis for our complex civilization. The conventional fuels include oil, natural gas, coal, and nuclear. These are generally converted to, and used as, electricity. In addition, the energy in rivers is harnessed to generate hydroelectric energy.

Generating Electricity

Because electricity is so easily used for many purposes and is easily transported, fuels are converted into electrical energy. Electrical energy is extremely flexible. It is easily used to make very high quality light, to run machinery, to power

Forest Lands Turned into Grasslands and Cities

As human beings have become civilized, we have cut down forests, turning them first into farm lands and then into cities. Although some reforestation is happening both deliberately and naturally, most of the world is still losing forests. In Europe, cutting and regrowing are about even, and in a few areas like the eastern U.S. and western U.S.S.R. there is net forest regrowth.

Soil Rotation

The impact of modern agriculture on soils has been to deplete them of their nutrients and their structure. Rotating crops can help this as when a corn crop, which uses up soil nitrates, is alternated with a soybean crop, which puts nitrate back into the soil. After many years of use, the soil must be left fallow to build back its structure and content by allowing the vegetation native to the area to grow back. Soil regenerates fastest from the growth of its native plants and trees. Sometimes, when the seeds of the native plants are not available to reseed naturally, they can be brought in or other exotic plants can be substituted.

Less Impact in the Future

As mining for fuels and minerals has to go farther out to sea and deeper into the ground, more of the economy is used to get and process them. When the mining and processing become so expensive that the fuels and minerals no longer have a positive net eMergy (see Chapter 26), it will not be worth mining them except for very special purposes. The time is coming when fossil fuels will not be available to produce fertilizers, pesticides, heavy metals, and large machinery. As that time approaches when the economy will have less impact on the environment, the environment will begin to come back to its lower energy state.

4 joules of energy are used for each joule of electricity that is produced. Three joules generate heat, and a fourth is used indirectly to provide the goods, services, and equipment necessary to generate electricity. In Figure 25.1 the heat energy is shown as not being used by any sector of the economy, but flowing out of the system through the heat sink at the bottom.

Sometimes this heat energy is described as wasted energy. This is not correct – it is energy use that is necessary in order to convert one type of energy to another type. The diagram of a power plant in Figure 25.1 shows the use of fuel energy and the eMergy in goods and services to generate one joule of electricity.

Some uses of electricity are luxuries, and are mainly for convenience. Using electricity where direct use of fuels is possible is a waste of 3/4 of the energy. For instance, since about 3/4 of the energy used in producing electricity goes to heat, the use of electricity to generate heat is a waste of

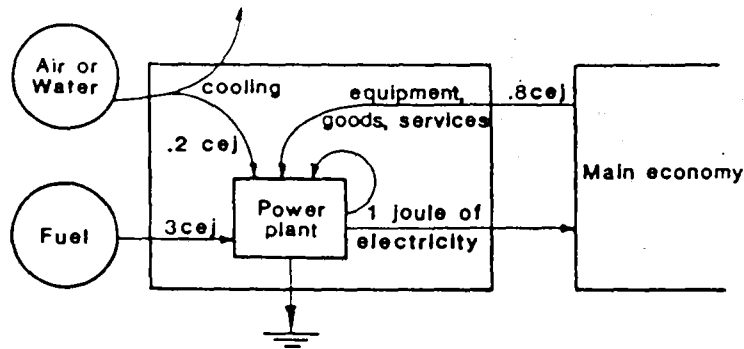

Figure 25.1 Energy diagram of the main features of a power plant converting fossil fuel or nuclear fuel into electricity. The power plant requires some environmental cooling and the feedback of goods, services and equipment from the main economy. As the numbers of the diagram show, 4 coal joules (CE) converge to generate 1 electrical joule (EE). The transformity is 4 coal emjoules per joule of electricity (or 160,000 solar emjoules per joule of electricity) (Figure 22.2).

houses wastes a great deal of energy. However, where electric heaters are used to direct heat locally, so that general house heating is reduced, electric spot heating can be economical.

Early in this century, when fuels were very inexpensive, the price of electricity was low. Many houses in developed countries were built as "all electric" homes. Everything was done with electricity. Indoor comfort was maintained by air conditioning and electric heating strips. Meals were cooked and hot water heated using electricity. Now, as the price of fuels has risen, more and more such homes are using other fuels like natural gas for cooking, and heating. In the long run the demand for electricity by the residential sector may decline as more people switch, where possible, to direct use of fuels.

Net EMergy

The net eMergy from an energy source is the amount that is left after the eMergy that was used to obtain and process it is subtracted. In Figure 25.2 the net yield from an oil well located in the Gulf of Mexico is shown. The yield is shown going to the right, while the eMergy used from the main

economy to obtain and process the oil is shown going to the left. Since the flow to the right is greater than that used from the main economy, there is net eMergy. The flow back from the economy is called the feedback.

When calculating net eMergy, both the yield and the feedback must be expressed in eMergy. To estimate the net eMergy, first the actual energy flows are estimated. Then each is multiplied by the solar transformity to get each value in solar emjoules (see Chapter 4 and Table 22.1).

If, as in the example in Figure 25.2, the feedback is mostly goods and services for which there is a dollar cost figure, the dollar cost is multiplied by the eMergy-dollar ratio (Figure 23.3) to get the feedback in solar eMergy unit.

Net EMergy Ratio

To evaluate the contribution of an energy source to the economy, it is not enough to calculate the net eMergy. The effect that an energy source has on stimulating the economy is related to how "rich" the source is. This may be estimated by calculating how much yield is obtained from the source for the feedback efforts:

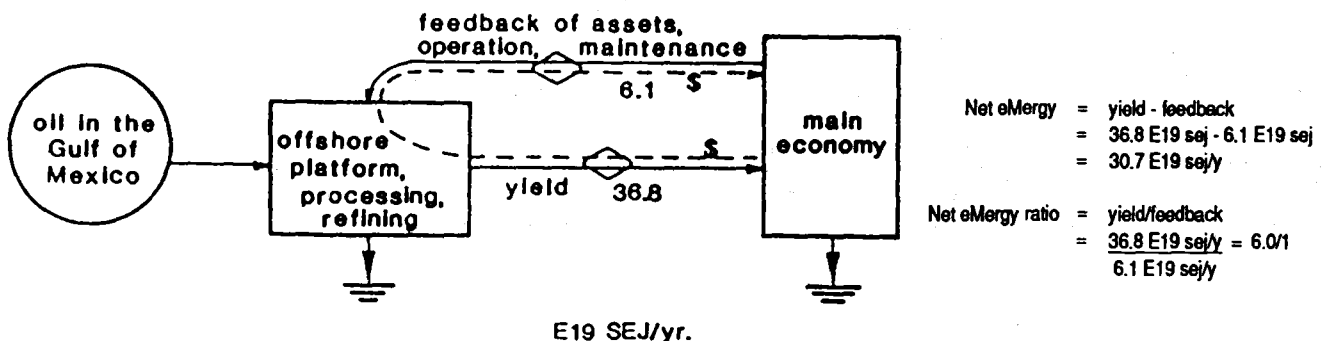

Figure 25.2. Diagram of the net energy of a cluster of oil wells in the Gulf of Mexico in 100 feet of water

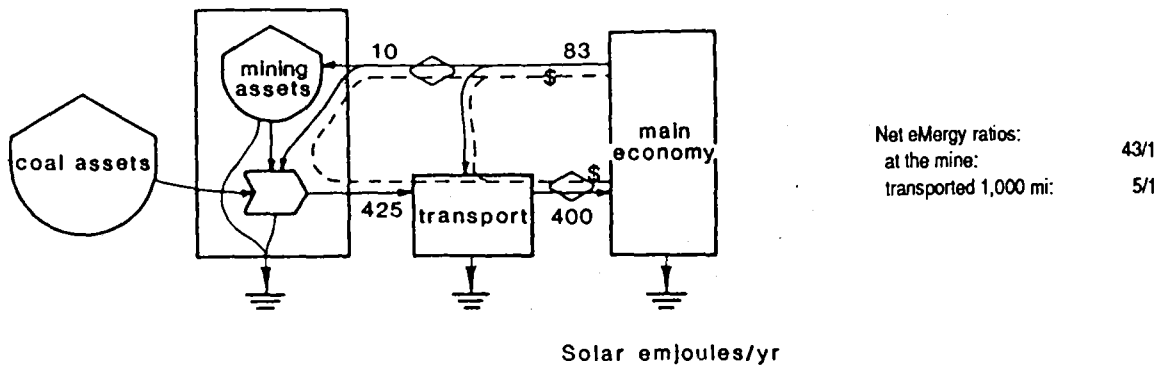

Figure 25.3. Diagram of the net energy of coal at a strip mine, and net energy of the transport to cities 1,000 miles away.

in other words, by making a ratio of the yield to feedback. This ratio is the net eMergy ratio.

The economies of developed countries such as Japan, the Netherlands, the U.S., the U.K., and West Germany were greatly stimulated in the 1950s and 1960s when 40 emjoules were obtained from each one emjoule expended in the efforts to find and process the energy. As energy has gotten harder to find, the net eMergies have declined as more and more energy is expended in finding, transporting, and processing.

The net eMergy ratio of one oil location is calculated in Figure 25.2 and shown to be 6/1. This is considerably less than the 40/1 of energy sources in the 50s and 60s, but is typical of energy sources today.

By comparing net eMergy ratios one can better see which energy sources are likely to compete with others and stimulate the economy. If an energy source has a much lower yield per effort than others with which it may compete, it is costing more, both in energy terms and in dollars. It will not compete successfully until the richer one with the higher net eMergy ratio is used up.

Effect of Transportation on Net eMergy

Many fuels which have good yield ratios when used near their source, have much lower net eMergy ratios at distant points of end use because of the transportation energies used and losses in transport. For example, Figure 25.3 is a diagram

showing the energy costs and yield of coal mining in the midwestern U.S..

The yield ratio at the mine site is greater than 40/1. However, the transportation to bring it to eastern cities adds about eight times the original feedback energy used. The coals of the state of West Virginia are much closer, so should compete better for eastern U.S. markets than those from the midwest.

Net eMergy of Purchased Foreign Oil

Figure 25.4 is a diagram of dollar and energy flows for the purchase of foreign oil by the U.S. in 1980. The amount of energy in a barrel of oil is about 6.3 E9 joules. Translating this to solar emjoules by multiplying by the transformity gives approximately 3.3 E14 solar emjoules in a barrel of oil. This is a constant value. As inflation and world wide prices change, so does the price of a barrel of oil. Before 1973 the net eMergy ratio of a barrel of oil was 40/1. Due to the increasing prices on the world market, the net eMergy ratio of that same barrel of oil in 1980 was about 4.5/1. Although this was a dramatic change in the net eMergy value of the oil, foreign oil was still a good source.

Shipment of oil from overseas uses about 10% of its energy content, and refining another 10%.

The net eMergy of oil on the international market is a good reference in comparing other sources since oil has to compete economically in world markets.

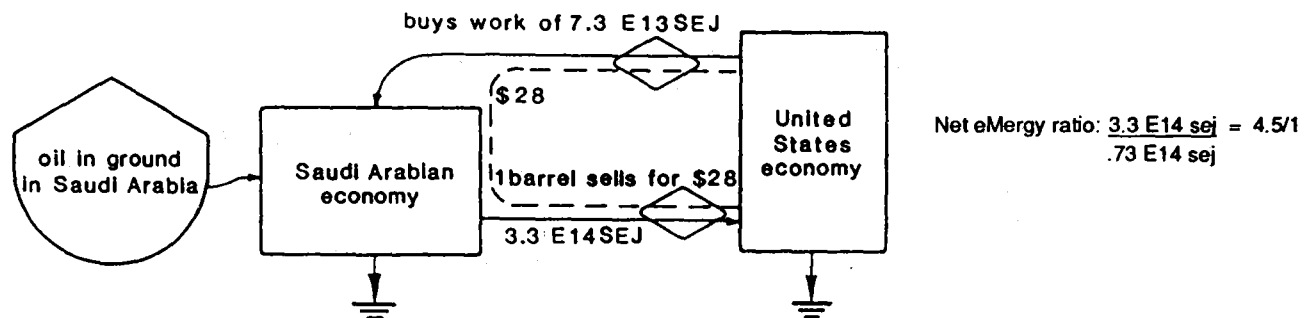

Figure 25.4. Diagram of net energy of the U.S. buying oil from Saudi Arabia in 1980. Not included is the 10% used in refining and another 10% used in long distance transport.

26. ALTERNATE SOURCES OF ENERGY

As the nonrenewable sources of energy that support the world economy begin to dwindle, a search is being made for alternative sources. It is most important, however, to make sure that they will support and stimulate the economy and not take more energy from the economy than they give back. Evaluating the net eMergy of alternative energy sources helps to identify which ones will not contribute.

Net eMergy of Sources

In order for a proposed new energy source to actually be a source of energy, its net eMergy ratio must be greater than 1. In order for it to be competitive and economic, its ratio should be greater than current energy sources. Some alternative energy sources that are proposed for the future have net eMergy ratios that are less than 1. Others have ratios that are much less than current sources of energy that support our economy.

If an energy source has a net eMergy ratio that is less than 1, it consumes more energy than it produces, and is therefore not a source, but a consumer. Sources like these can exist only when there are rich supplies of other energies with which to subsidize them. Solar hot water heaters are like this, since they do not produce more energy than they consume.

Comparison of Net eMergy of Energy Sources

The graph in Figure 26.1 summarizes the net eMergy of various kinds of energy sources. The horizontal axis is the concentration of the energy: from dilute to concentrated. The vertical axis is the net eMergy ratio as defined in Chapter 25.

Sources that have positive net eMergy yields are above the horizontal line. One of the best sources of energy is native forests because they do not require much feedback from the economy in order for them to be utilized. Sources below the line on the left are so dilute that more energy is required to concentrate them than they will yield.

On the right side of the graph are the nuclear energies that are so concentrated and hot that their energies are not easily used on earth. Since they are so hot, much of the energy of these sources is used in cooling and lowering the concentration to acceptable levels. In other words, a nuclear fission power plant that operates at about 5000°C must disperse a greater percent of its energy in cooling waters than a coal power plant operating at 1000°C.

Starting with solar energy, each of the alternative energies will be discussed. Since solar energy is the main driving energy of the biosphere, there are many ways that it is being thought of as an alternative energy source.

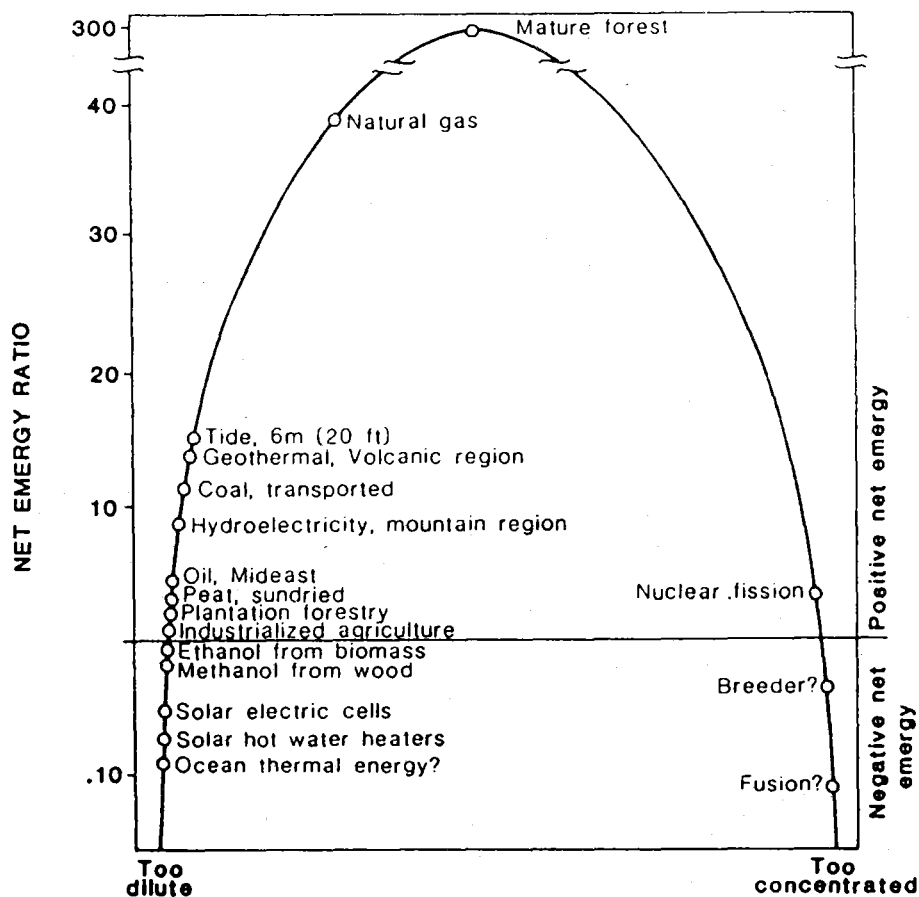

Figure 26.1. Net eMergy ratios for energy types of different concentration.

Solar Energy

It has been suggested that the economy of an industrialized country could be operated on sunlight. Although the quantity of actual joules of sunlight that falls on any country in a day is quite large, solar energy is very dilute (low quality). In order for it to be used to operate a high energy economy, it must be concentrated and much of its energy would be used up in the process.

Natural processes of the biosphere concentrate solar energy into higher quality energies at considerable cost. For example, to make a fuel such as wood, sunlight must be caught by leaves, transformed many times, converged, and accumulated in the plant as wood. Efficiency of conversion is the amount of actual energy resulting from transforming one type to another. The efficiency of converting sunlight to wood is about 0.1%. It is believed by many that this efficiency is the best that can be done to convert sunlight energy into higher quality more concentrated energies.

As Table 26.1 shows, it required about 40,000 joules of global solar energy to produce about one joule of coal. This is another way of saying that it takes about 40,000 joules of sunlight to do the work of one joule of coal. Coal is a lot more concentrated than solar energy and can support and stimulate a lot more work. Industrial economies are supported by energies that are similar in concentration to coal, such as gas, and oil. In addition, these economies utilize much energy in the form of electricity, which is even more concentrated than coal.

Coal is concentrated solar energy. The costs of concentration were paid long ago, so that when it is used now, the only costs associated with its use are extraction and transportation. Therefore, net energies are high. On the other hand, to utilize sunlight to support an economy requires that it be concentrated and much of its energy used in the process. Net energies are low.

Solar energy helps the economies of most countries and is essential to them through support of plant production, heating and generating winds,

evaporating water, and in turn, driving the hydrological cycle. However, its ability to run economies directly is very limited.

Solar Energy Heaters

Solar energy can be used in sunny climates to heat panels of pipes in which water gets hot because of the blackened surfaces absorbing the sun. This hot water is then stored in a tank from which it is used directly as hot water or circulated to help heat the house. These solar hot water heaters are expensive because they are made of costly glass, plastics, and metals.

Solar water heaters are not energy sources, but are consumer devices; all of them use more energy than they produce. However, solar water heaters use less energy than electric or gas heaters, so they are a way of saving energy. Figure 26.2 compares two water heaters used in Miami, Florida (U.S.A.), one solar, the other gas. Both systems use fossil fuel indirectly to supply and maintain the equipment. The solar heater takes more initial investment in equipment but uses no fuel directly. The gas heater takes less equipment but requires the continual direct purchase of fuel.

The uses of sources like solar hot water heaters that are not net energy yielders but do contribute energy and help save more valuable types of energy are said to be energy conservation measures. Whether people choose to save energy may depend on whether they have the capital money in hand to pay for the high cost of the equipment, and whether this will save more money than some other use of their capital.

Solar Voltaic Cells

Solar voltaic cells generate electricity from sunlight. The green chloroplasts in plants are solar voltaic cells that start the photosynthesis process by first generating electricity in the biochemical systems of the plant cells. Much of the landscape of the world is already covered with green solar voltaic cells.

Table 26.1. Transformities

	Solar emjoules per joule
Sunlight	1
Plant production*	4,300
Wood*	30,000
Coal*	40,000
Oil*	53,000
Electricity*	160,000

* Includes indirect solar energy of rain.

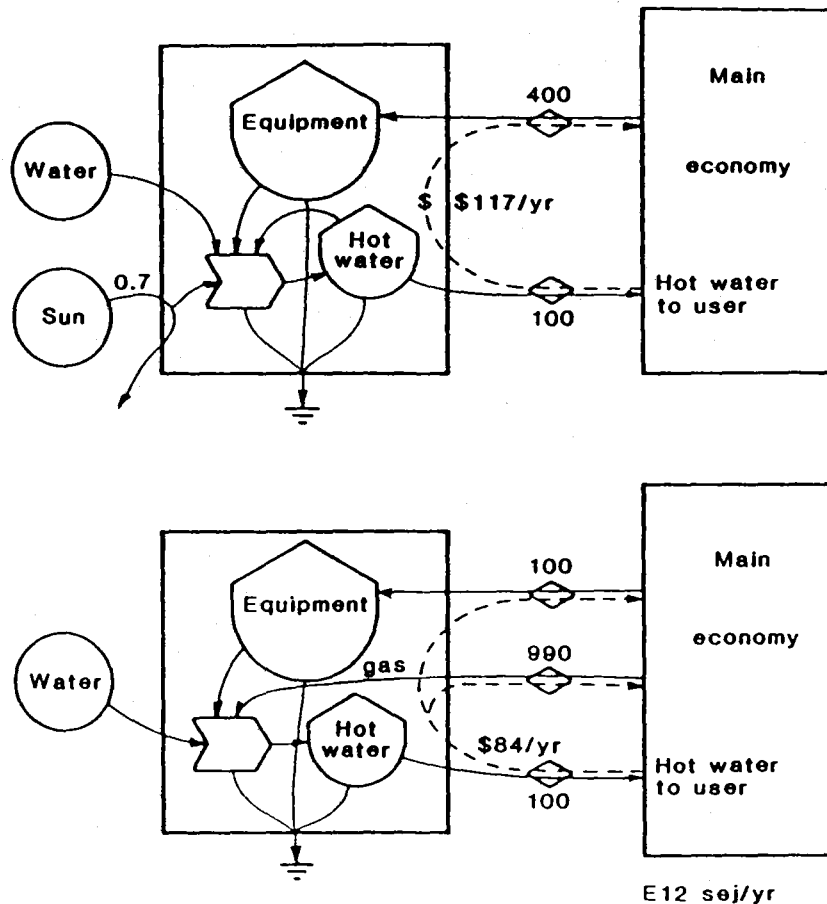

Figure 26.2. Comparison of a solar water heater (a) and a fossil fuel (gas) water heater (b). (Zucchetto and Brown, 1977).

Many seek to harness the solar voltaic process by using metal cells of silicon that have about the same efficiencies and power output as the green ones. When all the indirect solar eMergy in goods and services is considered, there is little if any net eMergy from the hardware versions. Plant cells may have already achieved the maximum that is possible.

Solar Energy Through Biomass

Biomass is the total mass of living and dead organic matter. Human societies have always used various kinds of biomass for food, fuels, clothing, and housing.

Using solar energy to grow wood and agricultural products (foods, fodder corn, hay, etc.) is the main way that solar energy is brought into our economy. Using these products to generate liquid fuels, gas, or electricity is feasible. But, because so much concentration is required, large areas of land are needed.

The net eMergy of biomass production depends on how intensively it is managed. The net eMergy declines as the intensity of management increases. Wood by-products, agriculture residue, and even corn and sugar cane are considered "energy crops." Wood and agriculture residues like corn stalks can be burned to generate electricity. Corn, sugar cane and the other organic materials can be processed further to manufacture methanol and ethanol, on which automobiles can be run. At

and electricity requirements for this manufacture, the yield ratios are less than one. This means that fuels can be made from agricultural and forestry production, but the processes would have to be subsidized by the rest of the economy.

At present, more fuel can be obtained per unit of energy used from coal, natural gas and oil, whether from Iran, Libya or Mexico. In the future, when these sources are unavailable, fuels made from the organic produce may be the only kind. However, there may be strong demands on the same land to produce food, clothing, housing, and household fuels, as well as gasoline.

Peat

Very substantial reserves of peat are found in most areas of the world. Peat is partially decomposed plant matter in marshes and swamps. Its energy is intermediate in concentration between green plants and wood. To yield net eMergy, it has to be naturally dried in dry winds and sunlight. Some of the energy gained may have to go back into restoring the land after mining the peat. Also, many deposits are in valuable wetlands that now yield special products and services in other ways.

Hydroelectricity

In areas of mountains and high rainfall, the yield ratio of hydroelectric power can be up to 10 to 1.

considered in calculating the yield ratio. The yield is lower if one considers the solar eMergy of the river's work before it was diverted by dams.

Wind

Wind is another natural renewable energy source that has been used for various purposes in some parts of the world. With a strong steady wind, windmills can grind grain, pump water, and generate electricity. In many areas with winds less than 15 km per hour, there is little net eMergy yielded. Small windmills may be used to pump water for stock watering or irrigation in some areas. Simple windmills, if built from low energy materials, and sailboats, if large sail areas are used, may yield net eMergy.

Geothermal Power and Ocean Thermal Electrical Conversion (OTEC)

Wherever there is a difference in temperature, there is a source of energy that can be converted into work or electricity. For example, train steam engines convert heat differences into the power of running wheels.

The percent of heat flow that can be converted to mechanical work is the percent that the temperature difference is of the temperature of the hot source. Temperatures for this purpose have to be given in degrees Kelvin.

The Kelvin temperature scale is a scale that has zero when there is no heat at all, and 273 at the boiling point of water. The Kelvin temperature is the Celsius temperature plus 273.

For example, if the hot source is 1170° Celsius and the cold environment is 170° Celsius, then the hot source is 4000° Kelvin and the cold environment is 3000° Kelvin. The difference is 1000° K. The percent the difference is of the hot source is $(100/400) \times 100 = 25\%$. This is the available mechanical energy (1/4 of the heat flowing). Since systems are usually operated at that speed which maximizes power, this tends to adjust operations to about half of the theoretical efficiency calculated above. This procedure for the calculation of work obtainable from hot sources applies to most industrial processes for converting fuels into work, as in power plants.

Small natural temperature differences are used in many of the earth's processes, like production of wind from differential heating of the earth and atmosphere. Tapping the heat of the earth for man's industrial processes has been economically successful only in the vicinity of volcanoes (in Iceland, New Zealand and the western U.S.), where temperatures are high near the surface.

One proposed source of energy is the gradient between the hot surface water (270C) of the tropical seas and the cold bottom water a thousand meters below (20C). Because of the cost of anchoring and maintaining ships and pipes in the deep sea with hurricanes passing, this plan may not yield net eMergy.

Waves and Tides

Wave energy coming ashore along coasts of

much daily work forming beaches and making sediment from rock. However, it is hard to use to operate industries because it is spread out along a great length of coastline. Also, it is variable, with large energy one day and nearly none the next.

The rise and fall of water levels due to tides have been used to make electricity with net eMergy in several places in the world where tides are 6 m (20 ft) or greater. There are few areas with such great tides.

Mixing of Fresh Water and Sea Water

There is considerable chemical potential energy available in the presence of sea water (salt water) and fresh water together. When fresh waters run into estuaries, this energy (chemical potential energy) goes into currents, geologic work, and biological work. Proposals to harness this energy would divert it from making estuaries fertile sectors of the life-support system.

Nuclear Power

Nuclear power plants, converting nuclear fission fuels (enriched uranium) into concentrated heat and then into electricity, are important in some countries. The net eMergy yield ratio of these nuclear plants is about 2.7 to 1, not counting the long-range costs of waste storage, decommissioning, and accidents (Figure 26.3a). When these are included the net yield is less than from biomass.

When the production of electricity from nuclear power plants is compared to production of electricity from coal power plants, the net eMergy yield ratios are almost the same. This is only true if one does not count accidents, processing and storage of wastes, and cleaning up after a plant that is too old to use. (As shown in Figure 26.3 the nuclear-electricity yield ratio is 2.7/1; coal-electricity is 3.1/1.) However, if the nuclear-electricity is used in sectors of the economy which could use fuels (gas, oil, coal) directly, it does not have as good a net eMergy yield as the fuels (2.7/1 compared to 6/1). Since there is a limit to the amount of electricity which is necessary for the economy, there is a limit to the demand for nuclear power plants, even when hazards are not considered.

Many planners assume increasing energy availability. They expect nuclear fusion and nuclear breeder reactors will provide plenty of energy. However, fusion has a temperature of 50 million degrees and may require too much energy to contain and cool down. (See its position in Figure 26.1.)

In the breeder reactor the processing of uranium produces plutonium as a by-product. Since plutonium itself is a nuclear fuel, its production makes the original uranium go further. However, plutonium is extremely dangerous. It is toxic, causing cancers of the bone. Plutonium is easily made into atomic bombs; guerilla groups could build them from stolen nuclear wastes. The great costs of processing the intensively radioactive breeder wastes so as to use plutonium safely, make the net eMergy yield of the breeder

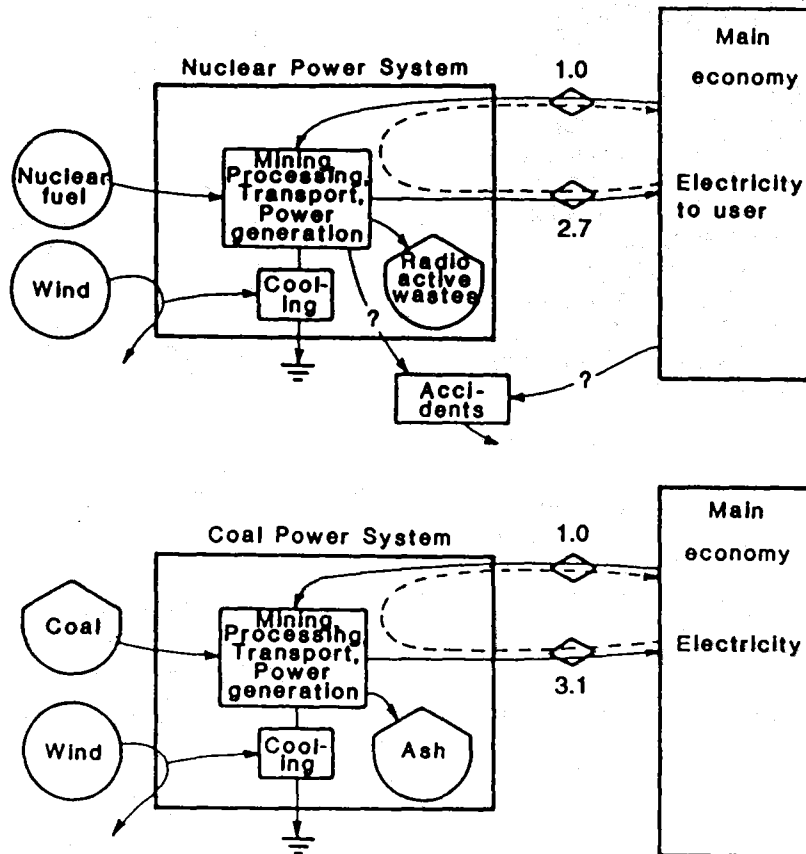

Figure 26.3. Comparison of electricity from (a) nuclear with electricity from (b) coal power plants. Numbers are eMergy units.

breeder system, and we will have to await the practical results and costs to learn if it is effective. The U.S. stopped its breeder program and then resumed it. However, few see the breeder as a very important source of energy in the near future.

Importance of New Energy Sources

As part of the world economy, any country may prosper when energy sources are found in other countries. The discovery of new oil fields or new coal beds has the effect of lowering prices and increasing net eMergy yield ratios for foreign imported energy. However, coal may not have net eMergy yield ratios above 1 if transported great distances.

Some proposed sources of energy once discussed with high hopes -- and in some countries even subsidized with government money -- appear not to yield net eMergy. One of these, oil shale, was thought to have the potential of yielding great quantities of oil. The oil is contained in the shale rocks, and many techniques were tried to release the oil, but all used more energy than was yielded by the process.

Converting One Fuel to Another

When one kind of fuel such as gasoline is in short supply, it can be made from another, such as coal, but about half the energy is used up in the

wasteful and ultimately more economic to use the coal elsewhere in the economic system and buy the gasoline.

Many discussions are held about a hydrogen economy. This is another example of converting one kind of energy into another at considerable energy loss. Electricity from nuclear power plants can be converted into hydrogen gas, which is versatile and can be used directly for transportation. Hydrogen, like natural gas, is easily piped but potentially explosive. At a time of little expansion of the economy there is not likely to be demand for very high quality gas that natural gas cannot supply.

Future Sources

An examination of alternative sources possible in the world does not show any new sources likely to increase the net eMergy of our energy base. This means that economic growth is not to be expected unless rich new sources are found that are not now known.

As mentioned earlier, many people do not agree that resources are essential and think an economy can be run with people serving each other with intelligence and computers. This point of view seems to be in violation of scientific fact. The view that energy is not needed to run an economy is contrary to the second law of thermodynamics.

27. SIMULATING THE FUTURE

When an economy expands, when it crests, or when it declines depends on the way the renewable and nonrenewable resources within and outside the country become available. Simulation models can help us to visualize the way the future may be affected by available energy sources. We will first consider a model of world trends, followed by a model of a single country or region as it responds to the world influences. Such models may be too simple to show the detailed ups and downs, but they suggest long-range trends.

A Model of World Trends

The model in Figure 27.1 relates total world assets and the global economy to the availability of renewable and nonrenewable resources. The renewable resources are soils and wood that are "renewed" by the steady inflow of global solar energy. The nonrenewables are the reserves of fuels like coal, oil, and natural gas. The economic assets are all the buildings, roads, machines and goods produced by the world economic systems. They are stored and fed back as needed to increase production.

Further discussion of the diagrams and programs in this chapter are found in the appendix.

Simulation Results of the Model of World Trends

Simulation results of the program are given in Figure 27.2. The program begins over 300 years ago with high storages of fuels, soils, and wood, but with low economic assets. A steady state pattern of resource use and economic assets is soon developed and lasts until there is a great

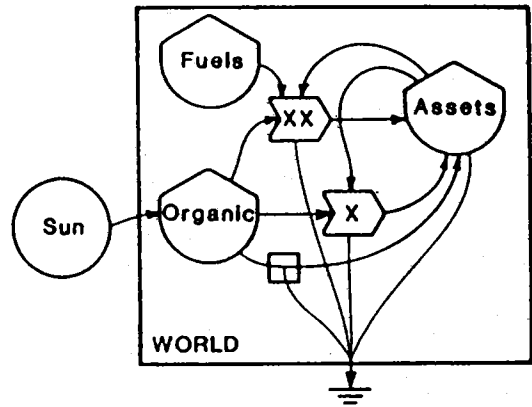
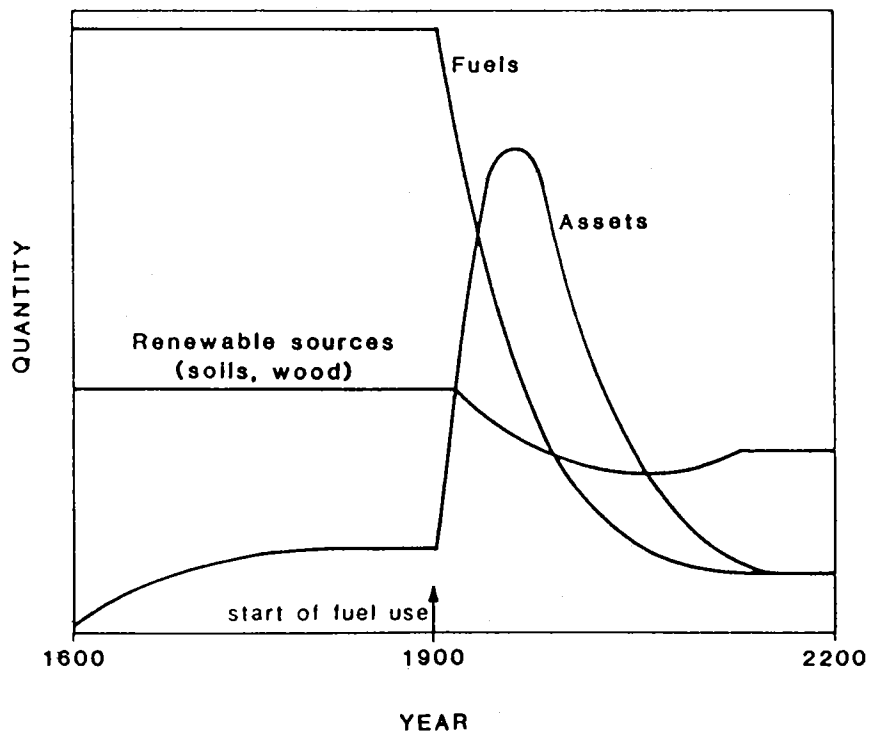

Figure 27.1. A simplified model of world trends.

pulse of world economic development using fuels, which draws down the levels of environmental resources until fuels are used up.

The graph in Figure 27.2 shows the rapid rise of world economic assets followed by a decline to a lower level that can be maintained on renewable resources. The leveling and decline may have already begun in some countries, and may be the general trend for most countries by the year 2000, as the net eMergy of available fuels and minerals declines worldwide.

It is difficult to visualize the real world economy doing anything very different in the long run. However, the exact shape and timing of the curves in Figure 27.2 are beyond the scope of "macro-minimodels" such as this. Small scale models do not have enough detail to produce the small scale up and down changes that may dominate a given decade. Just when the crest of the world's assets



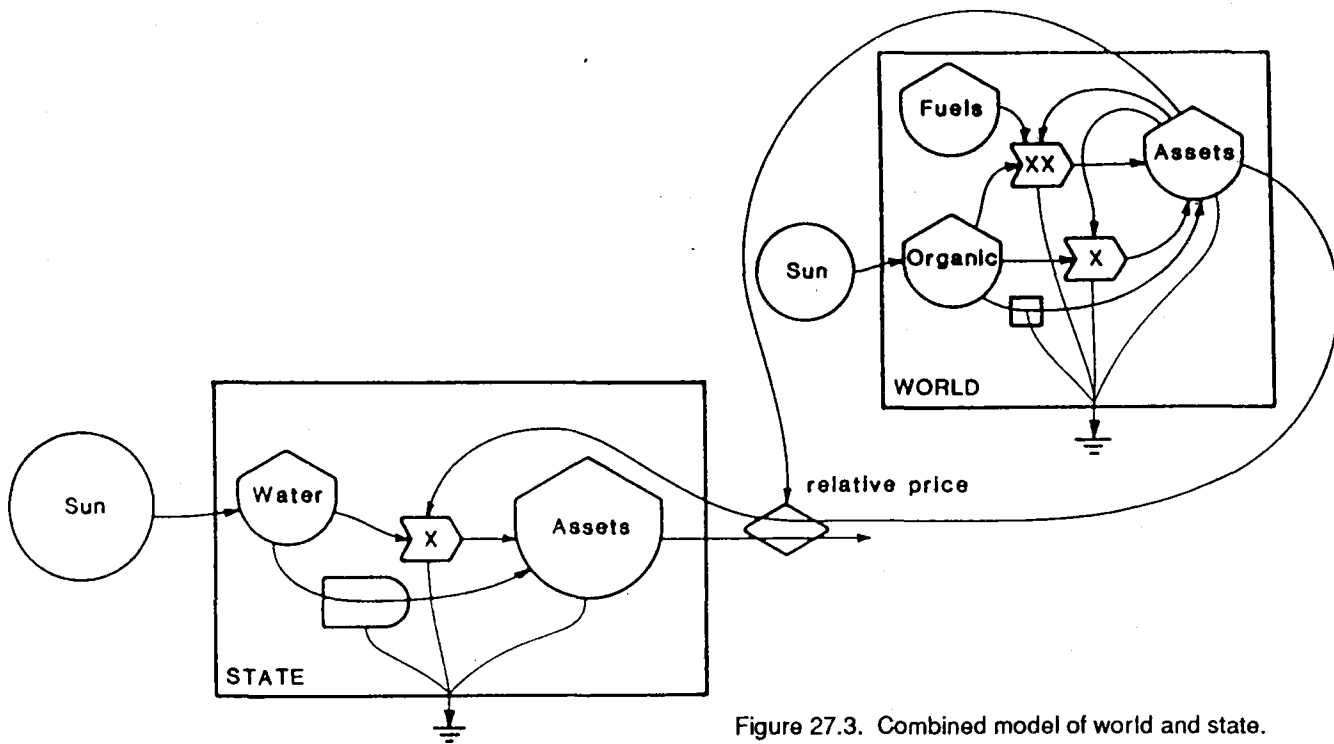

Figure 27.3. Combined model of world and state.

will occur remains to be seen. World fuel consumption has not increased in the last two years.

Simulating a Country or State

A model of a country, including its natural and human-operated economies was given in Figure 23.4. Notice that its resources include both those within the country and those it can buy from outside

Figure 22.5 also shows inside resources used to get outside resources. A STATE model on the left side of Figure 27.3 has water representing

environmental resources helping generate assets which are traded for outside assets (goods, services, fuels, etc).

Simulation of Country Growth Driven by Growth of World Assets

The country trend model and the world model are combined in Figure 27.3 and the combined computer programs are given in Figure A.2 and Table A.16 of the appendix.

The simulation results of the combined models are given in Figure 27.4. Here the resources imported by the country in exchange for exports

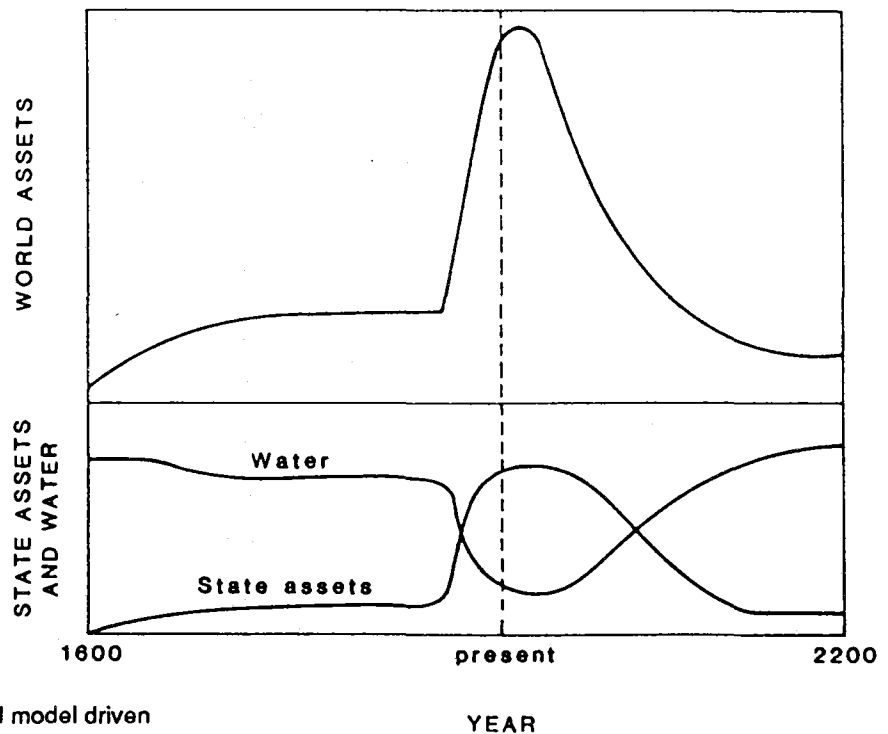

Figure 27.4. Simulation of the state trend model driven by the world model (Figure 27.3).

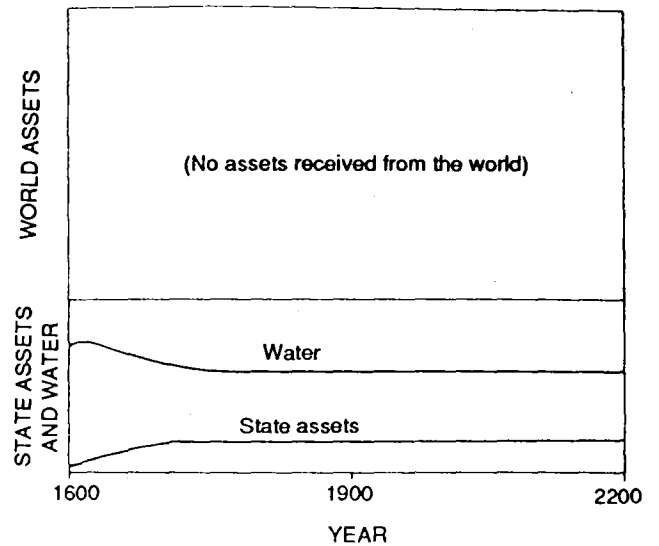

Figure 27.5 Simulation of the state trend model (figure 27.3) without connection to the world model.

are programmed to be in proportion to the world assets. In this way the world model is made to drive the country model.

In the top part of the graph in Figure 27.4 the world assets grow and decline as in the simulation in Figure 27.2. The growth of world assets makes available increased supplies of resources to the country's economy after 1900 when fuels are switched on. The country's assets (the bottom half of the graphs in Figure 27.4) grow rather sharply after 1900 in response to the increased availability of resources from the world market.

As world growth crests and declines, the availability of outside resources decreases and the country's growth levels off and declines to a steady state sustainable by the renewable sources. Water is restored to a level that was characteristic of earlier steady state times before the pulse of growth.

Simulation of Country Growth When There Are No Outside Resources

If the country developed without any resources obtained by trade with the rest of the world, it would not grow much. In Figure 27.5 the simulation shows the country economy builds up to

a moderate level based on local environment resources. This development of state assets pulls down the environmental resources (water) to a slightly lower level than before development.

Simulation of Country Growth with Steady Increases in Availability of Outside Resources

Many people believe that the growth of world assets will continue for a long time into the future. In this third simulation, (Figure 27.6), the world resources received in exchange for exports are anticipated as increasing steadily throughout the time of simulation.

As shown in Figure 27.6, the growth of state assets do not continue indefinitely even though more and more investments of fuels and goods and services are received from outside. With such a favorable availability of outside resources, one would expect much growth in the economy of the country. However, the environmental resources (in this simulation they are represented by water) are drawn down to such low levels that they limit further growth of the economy. This corresponds to some conditions that have been observed in parts of the world at the present time.

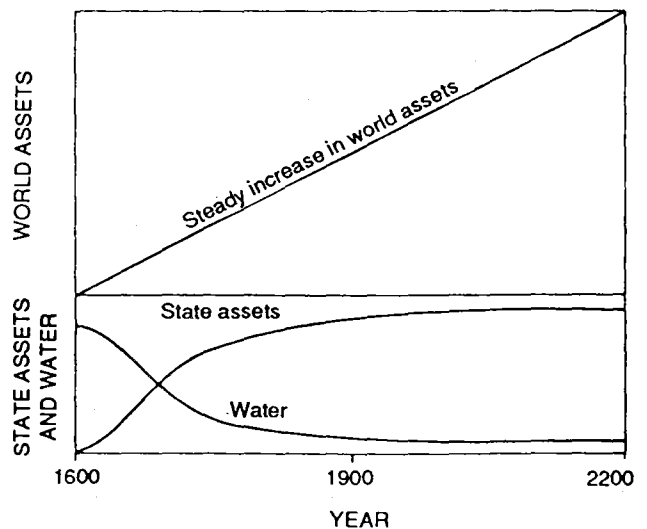

Figure 27.6. Simulation of state trend model (Figure 27.3) with a constant increase in world assets.

28. POPULATION AND CARRYING CAPACITY

As the population of the world continues to increase, growth seems to be concentrating in a few countries. The natural increase in the population is a result of birth rates being greater than death rates. As we move into the last decade of this century, and the limits to economic growth are felt more and more, two serious questions face us all: how can the populations move within the world in their search for some reasonable combination of environmental quality and economic development? Once economic development has reached its maximum, will the population continue to grow, or will it start to decline?

Standard of Living

If population increases and resources do not, then resources per person decrease. A person will have less resources to meet his or her needs and those of society. Sometimes we call the resource portion per person the standard of living. One measure of this is the eMergy use per person. This is a better measure of individual resources than income since it includes those natural resources used directly from the environment (fishing, hunting, air, water) or from other people (bartering) without paying money.

Table 28.1 shows some comparisons among countries. Notice the differences in total eMergy use per year, total population, and the ratio of the eMergy per person (a measure of the standard of living). Australia, with a combination of rich resources and relatively low population, has a very high eMergy use per person; whereas countries like India with enormous populations and moderate resources have a much lower standard of living.

Carrying Capacity

The carrying capacity is the number of individuals that any area can support on the available resources. In a human system it is the

Table 28.1. Standards of living for different countries in 1980.

	Emergy per year E22 sej*	Population E6 people	Emergy per person E16 sej
Australia	109.0	14.5	7.6
Brazil	178.0	121.0	1.6
Dominica	0.7	0.1	0.8
India	61.0	626.0	0.1
Liberia	5.0	1.8	2.8
Netherlands	37.0	14.0	2.6
New Zealand	8.8	3.1	2.8
Poland	33.0	34.5	1.0
Spain	21.0	34.6	0.6
U.S.S.R.	383.0	260.0	1.5
U.S.	660.0	240.0	2.8
West Germany	175.0	61.6	2.8
WORLD	1870.0	4300.0	0.4

* This includes environmental energies and fuels all expressed in solar emjoules.

number of people that can be supported at a specified standard of living (eMergy per person per year) with its available resources. Predicting the carrying capacity requires predicting the eMergy resources that will be available. The carrying capacity depends on the amount of natural resources and purchased or imported eMergy.

The Effect of Declining Resources on Population

There is much controversy among population scientists about what the response of birth rates, death rates, and migration trends will be as economies begin to contract. In the future, the ability of any country or region to support people at current standards of living is expected to decline as the resources available decline. In other words, the carrying capacity will decline. The effect of declining carrying capacity on populations is open to some question; one answer is given by the simulation model in Figure 28.1.

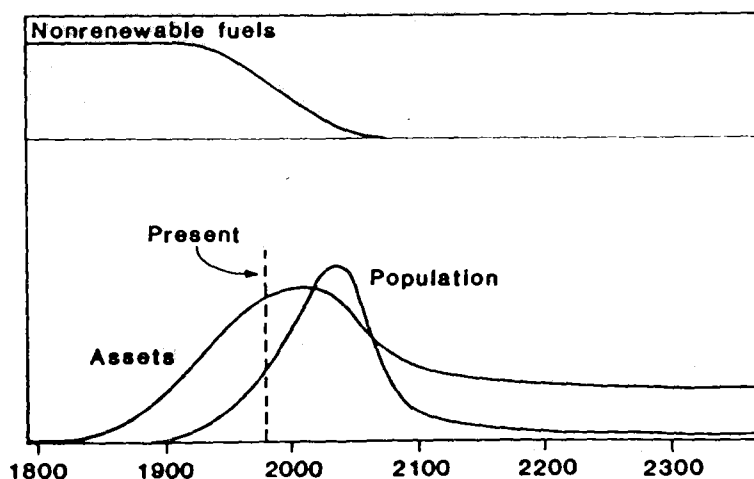

Figure 28.1. Changes in world population based on changes in economic assets. The model diagram

In this model economic assets control public health (births, deaths, epidemics), and public health controls population. In Figure 28.1, world assets increase which in turn increases population growth and the demand for nonrenewable energy resources. Since the nonrenewable resources are being used but not replaced, the assets begin to decrease. Population rapidly follows the downfall of the assets. Whether this model is an accurate picture of the future remains to be seen.

The Investment Matching Principle

Economic growth and development involve attracting outside high quality goods, services and fuels which interact with the environmental resources of sun, wind, rain, soils, etc. This is a matching of high quality eMergy with lower quality eMergy. Those inflows that have high eMergy achieve their effects by amplifying lower quality

flows. In Figure 28.2 the eMergy in high quality fuels, goods, services and soil used is 10.7 E24 sej/y. It interacts with 8 E24 sej/y of free renewable resources. The ratio of high quality eMergy to renewable environmental eMergy is called investment ratio. The average ratio for the world is 1.3.

Whether an investor is attracted to a country or region may depend on the investment ratio within the country compared to alternatives elsewhere. Many less developed countries have lower ratios than the developed countries. This means they have more unmatched resources to develop than the countries with higher ratios. For example, the investment ratio for India is 2.4, for Liberia it is 0.1, and for Spain and the the U.S. it is 7. In fact, recent trends indicate there is movement of population and industry away from the more developed and crowded areas to rural areas having a good environmental base.

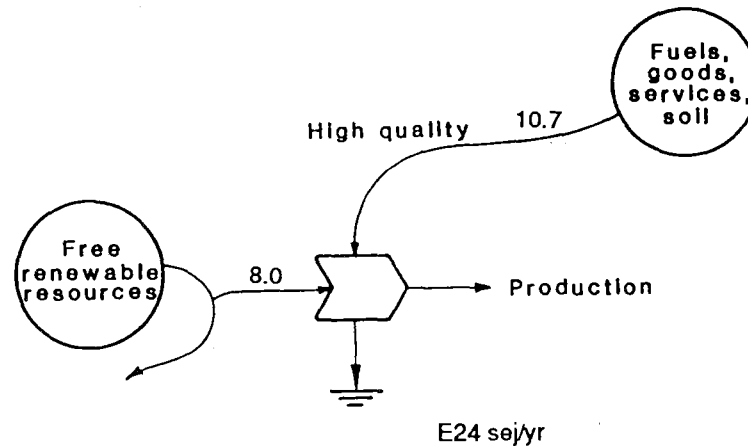

Figure 28.2. Investment ratio of the world. ($10.7/8.0 = 1.3$).

29. INTERNATIONAL EXCHANGE AND SYMBIOSIS

Systems that are connected to others by exchange of commodities, goods, services, information, and people do better than those that are isolated. By exchange, every system gets additional resources. By exchange, a system gets things that would otherwise be scarce and limiting to its economy. The principle that exchange increases a system's useful performance applies to ecological systems and to whole countries. In many of the diagrams in previous chapters, the exchanges with other systems have been shown with lines going in and out of the right side of the system boundary.

In larger systems, such as national systems, exchanges are usually arranged by people. Some exchanges are commercial with products bought and sold or exchanged by barter. Other exchanges, often arranged by governments, include arrangements for exchanging students, sharing educational facilities, or arranging mutually beneficial defense treaties. FMerav measures can

Diagram of International Exchange

Figure 29.1 shows the main pathways by which one nation (country #1) exchanges with another (country #2). Commodities and products are imported and exported. Some people migrate temporarily and others permanently. Ideas and know-how are carried back and forth by student exchange, by contractors, by lecture tours, and especially by world-wide television.

Money that is paid for exports or imports is shown in dashed lines. Money passes between countries in payment for products, as foreign aid, as military support, as loans and repayments, and as expenditures of tourists and immigrants.

Balance of Money Exchanges

The money going out of a country may be compared to the money coming into a country. This is sometimes referred to as balance of

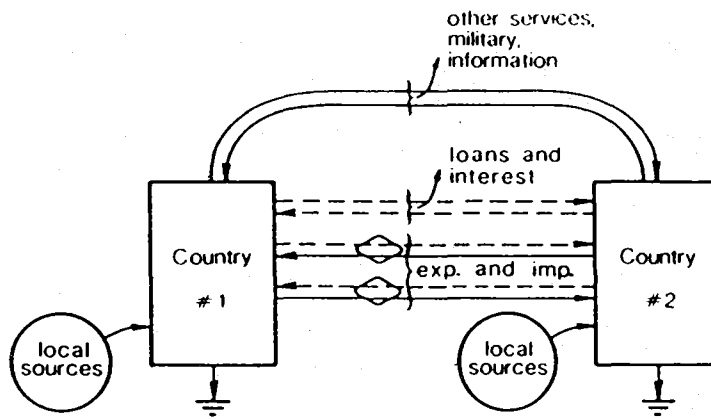

Figure 29.1 Exchanges between two countries. The flow of money is represented by the broken line (---). Exp., exports.; imp., imports.

is some imbalance in the money exchange. Many governments have a policy of trying to increase the money received compared to that sent out. If they succeed and have a positive money balance, they can buy items they regard as high priority such as fuels and military defenses.

Exchanging Money

When money passes from one country to another the currency of one country has to be converted to the currency of the other country. Or both countries have to convert their money to the market value in a common currency, such as the U.S. dollar or Swiss Franc. The exchange rates of currencies change every day, because the world markets change their preference for one currency or another. Everyone is familiar with the process of changing his money to its equivalent in the currency of the country he or she is visiting.

When one country sends out more of its money than it is getting back, then its money accumulates abroad and loses some market value. Money traders then can make some profit by selling it back to the original country. When a country's money is worth less in currency exchange markets, it cannot buy as much abroad. However, other countries can buy more products from the original country when they convert their currency.

EMergy Evaluation of Exchange

The eMergy of minerals, agricultural products, forestry products and fuels is much higher than the eMergy in the money paid for them in the market place (Chapter 23). This is because the money is paid for the human services at labor market prices, but not for the large previous work of nature.

Thus, a country selling raw minerals, agricultural products, forestry products, and fuels at market prices provides much more stimulus to the economy of the country that is buying than the selling country receives in payment. Table 29.1 has examples of the higher macroeconomic values of raw products when evaluated according to their eMergy. For instance, while the market value of corn is \$200 per ton, the macroeconomic value is \$540 per ton.

Some of the imbalances in standards of living of different countries are due to the use of the wrong value for determining what is fair trade. Countries that export raw material send out more eMergy in the products than they can purchase with the money received from the sale.

Using EMergy for Financial Transactions

The people in rural countries use more services of the environment directly, without money

Table 29.1. Comparison of macroeconomic value and market value of raw products.

Item	Unit	1978 market value per unit	macroeconomic value per unit
Corn ton	\$200	\$540	
Fuel oil	barrel	23	138
Wood	kilogram	2.20	33
Plantation wood	ton	5.70	42.75
Honey	kilogram	1.17	4.10

payments, than the people in urban countries. Rural people have their own farms, fruits, waters, woods, minerals, places for waste disposal, and places for recreation and do not pay anything for them. On the other hand, in the city, nearly everything is produced through services of people and has to be paid for, including food, fuel, housing, recreation, and waste disposal. Therefore, urban countries circulate more money for the same standard of living. Rural countries, by contributing more eMergy directly to people, have higher eMergy per unit of money.

In other words, the buying power of money is higher in a rural country than in an urban developed country. The ratio of eMergy/dollar, introduced in Chapter 23, measures this greater value of the money in rural countries. In comparing the eMergy/dollar ratios for different countries, their local currencies are given in U.S. dollars. Table 29.2 compares ratios of eMergy/dollar for countries with large rural areas with countries like Switzerland with smaller rural areas. There is little wonder that those with money seek to buy products and invest in the less developed regions, since their money buys more than it does at home.

Balance of eMergy

If the eMergy of all the exchanges between two countries are evaluated, the "balance of eMergy" may be calculated. For two countries to be mutually benefited, there should be an equal balance of eMergy.

For example, if a rural country is supplying an urban country with raw products at market prices, more macroeconomic value goes to the urban

Table 29.2. eMergy per international dollar of money of various countries, 1980.

Country	eMergy-dollar ratio E12 sej/\$
Dominica	14.9
Australia	12.1
Brazil	6.9
New Zealand	3.4
U.S.S.R.	3.4
U.S.A.	2.6
Switzerland	0.7

country. To make the exchange symbiotic (equally helpful to both countries), the urban country should return the eMergy difference in some form such as information, education, foreign aid, military protection, or something that the rural country may need.

Using eMergy to Determine Rates of Money Exchange

Another way to make trading more equitable is to determine the prices of the products bought and sold according to their eMergy content. This would return much more to rural countries, generate a better balance of economies in the world, and make countries better partners.

eMergy Evaluation of Loans

When a country with a high eMergy/\$ ratio borrows from one with a low eMergy/\$ ratio it pays back much more than it borrows. If it agrees to a 5% interest as expressed in international dollars, it really is paying back several times higher interest in real buying power. It is no surprise that many international loans have thrown the borrowing countries into economic depression. To avoid this, loan repayments and interest should be set on an eMergy basis.

eMergy Evaluation of Military Power

Wars sometimes come about through miscalculations of military power. One country may try to control an area which it does not really have the means to control easily in the face of opposition. eMergy evaluation can show in advance what the relative resource potentials for exerting power really are. With such evaluations, those in diplomatic conferences can better predict what the outcome of a war would be, and thus make realistic agreements without war.

Symbiosis and Peace

One of the ideals of the world is that if good mutual exchange relationships can be developed between all countries, they become so symbiotic and connected as partners in a common system that many conflicts and wars are avoided. Having exchange relationships on a fair eMergy basis would go far to solve international problems.

30. A LOWER ENERGY WORLD

One of the things that scientists do is make predictions. Their predictions are based on the best information that can be gathered.

In the biological and physical sciences, predictions that are based on patterns are expected to come true. In social sciences, however, making an unpleasant prediction often causes its outcome to change. Predictions about societies may serve as warnings. Humanity, however, may be able to control its own destiny. If people listen to the warnings, and if they act responsibly, the outcome may not have to be what is predicted. The value of a prediction can lie in its ability to cause its own alteration.

Since the pattern of society and nature depends on the pattern of resources, it is possible to predict some of the features of the lower energy world that could follow the present period of rich fossil fuels. If we can anticipate the future pattern, we can do a better job of planning the transition.

The Year 2100

Let us consider the situation which could exist in the industrialized countries when the available nonrenewable sources are used up.

If by 2100 the main fuel and mineral resources have been depleted, economies will have contracted and populations will have declined. National energy budgets will have declined. The U.S. energy budget will average about 26% of the 1980 level. The estimate for Brazil is 86%, Liberia 92%, and Spain 24%.

Since more energies would be in the rural areas than in the towns, more of the population would be in the country and the towns smaller. Markets would sell more goods grown and processed in their local area. The export of cash crops and industrial goods would be less because of the absence of cheap transportation.

By then much of the world's mineral and fuel resources will have been mined so that the landscapes of many countries may be undergoing a gradual new reorganization. There will be natural and planned rebuilding of the pattern of soils, stream drainages, and diversity of vegetation. With less fertilizer available, there should be land use practices that keep the ground covered and in rotation. Fisheries may use smaller boats and draw their catch from waters closer inshore.

Features which Deteriorate

Already some of the structures of the industrialized world's economic system are deteriorating faster than they can be maintained. As available energies decline, many other aspects of the system may also decline. Examples are highways, bridges, railroads, power plants (especially giant nuclear plants), some of the most complex communications, and television facilities. When less energies are available these operations must use less of some of the high energy services. Space exploration and satellite networks may not

be sustainable. Defense bases may be less elaborate with less sophisticated aircraft and tanks as military services become more dependent on people. The intensive buildup in coastal areas related to luxury, tourists, and rich retirees may be gone, hastened by natural disasters for which there may be no subsidies remaining for rebuilding.

When we examine the great structures of earlier civilizations in Europe and Asia, we often find that the materials of a great pyramid or temple are used by later people to operate less elaborate functions. After useful materials are taken, the remnant becomes a ruin, overgrown and covered by dust to form new land. The really long-enduring structures are those which are continuously used for fundamentals, such as for essential housing and for the processing and use of waters to maintain agricultural production. Which of our structures will endure?

New Features

For generations we have been accustomed to thinking of progress as more, larger, more complex, and more technological. The anticipation of a lower energy world which is smaller, simpler, and less technological may seem like antiprogress. However, humans have been in lower energy societies for much of their history. We may be better adapted to the lower energy regime than to the intense urban world of the present.

Ways of living which involve more dispersed populations, more rural patterns of life, and less differences between the richest and poorest may come to be regarded as progressive. Conditions for individuals may be good if the energy per person is kept large by the decline of population as energy use decreases.

Some aspects of today's technological society may be retained if the energy cost of maintenance is not large. Perhaps this will be true of many vaccines, drugs, smaller computers, radios, television, bicycles, and books.

The agroecosystems may tend to be those of an earlier era which required less special fossil fuel and technological support, and are more net yielding. The struggle to maintain natural environments may continue to be necessary because of the increasing demand for land for agricultural and forestry production, rather than the present pressure of urban growth. Agricultural practice may require more diversity of crops. More crop rotation may be necessary, with fallow stages to reduce weeds and insects and to allow successional vegetation to extract fertilizer elements from rocks and rains. Birds and other insect predators may be used in place of pesticides to offset the high costs of chemicals.

Social and political activities may move to smaller centers.

Inability to understand the forces that affect our lives can cause confusion and fear. Those of us who can anticipate these changes need to explain them to others. Planning for and surviving in the low energy world can be an exciting challenge.

Differences in local conditions may be expressed as different customs and cultures.

Human Society Alternating Between a Production and Consumption Regime

When considered on a larger scale of time and space, the current world consumption culture that uses up more than is produced may be a stage in a longer period of oscillation of the kind described in Chapter 9. The present consumer economy is like a fire or an epidemic of grasshoppers consuming storages, after which the system shifts to a long period in which production exceeds consumption. No doubt the flexible adaptability of human culture will shift to a culture that manages the world for net production if that is what is required for survival in those times. According to the oscillation concept, when enough resources have accumulated again, the consumer pulse culture can come again for another period. The

challenge is to retain the best knowledge between high and low energy periods, making it available for use again.

The Transition

The time between now and that of a lower energy state may be a time of great changes. This transition from a high energy to a low energy may cause disruption and anxiety if people do not understand what is happening.

If we anticipate the new directions, we can prepare ourselves for the changes. We can educate ourselves to be flexible in our choice of jobs; be ready to specialize in technological jobs and also prepare to work in a number of fields as generalists. We can be ready to garden or farm, build and repair our own houses, make our own entertainment, reduce our transportation, help our neighbors and communities, and become involved in local political decisions.

APPENDIX

Table A.1. Programs for limiting factors discussed in chapter 5.

<pre> 10 REM APPLE: FACTORS (LIMITING FACTORS) 20 HGR : HCOLOR= 3 30 H PLOT 0,0 TO 0,159 TO 279,15 9 TO 279,0 TO 0,0 40 HCOLOR= 5 50 J = 15 60 I = 1 70 Z = 2 80 K1 = .08 90 K2 = .05 100 K3 = .01 110 DI = 2 120 N = J / (1 + K3 * I) 130 P = K1 * I * N 140 I = I + DI 150 H PLOT I / Z,160 - P 160 IF (I / Z) < 279 GOTO 120 </pre>	<pre> 10 REM IBM: FACTORS (model of limiting factors) 20 CLS 30 SCREEN 1,0: COLOR 0,1 40 LINE (0,0)-(320,180),2,B 50 J = 5 60 I = 1 70 Z = 2 80 K1 = .08 90 K2 = .05 100 K3 = .01 110 DI = 2 120 N = J / (1 + K3 * I) 130 P = K1 * I * N 140 I = I + DI 150 PSET (I / Z,180 - P),1 160 IF (I / Z) < 320 GOTO 120 170 J = J + 5 180 I = 0 190 IF J < 25 GOTO 120 </pre>
---	--

Table A.2. Programs for exponential growth discussed in chapter 6.

<pre> 10 REM APPLE: EXPO (EXPONENTIAL GROWTH) 20 HGR : HCOLOR= 3 30 H PLOT 0,0 TO 0,159 TO 279,15 9 TO 279,0 TO 0,0 40 E = 1 50 Q = 10 60 K = .07 70 K2 = .05 80 HCOLOR= 5 90 H PLOT T,160 - Q 100 Q = Q + K * E * Q - K2 * Q 110 T = T + 1 120 IF Q > 159 GOTO 140 130 IF T < 279 GOTO 80 140 END </pre>	<pre> 10 REM IBM: EXPO (model of exponential growth) 20 CLS 30 SCREEN 1,0:COLOR 0,0 40 LINE (0,0)-(320,180),1,B 50 Q = 10 60 E = 1 70 K = .07 80 K2 = .05 90 Q = Q + K * E * Q - K2 * Q 100 T = T + 1 110 PSET (T,180 - Q),2 120 IF Q > 180 GOTO 140 130 IF T < 320 GOTO 90 140 END </pre>
---	--

Table A.3. Programs for logistic growth discussed in chapter 6.

<pre> 10 REM APPLE:LOGISTIC (LOGISTIC GROWTH) 20 HGR : HCOLOR= 3 30 H PLOT 0,0 TO 0,159 TO 279,15 9 TO 279,0 TO 0,0 40 Q = 4 50 K = .04 60 K3 = .0008 70 E = 1.7 80 HCOLOR= 5 90 H PLOT T,160 - Q 100 Q = Q + K * E * Q - K3 * Q * Q 110 T = T + 1 120 IF T < 279 GOTO 80 </pre>	<pre> 10 REM IBM: LOGISTIC (model of logistic growth) 20 CLS 30 SCREEN 1,0:COLOR 0,0 40 LINE (0,0)-(320,180),3,B 50 Q = 4 60 K = .04 70 K3 = .0008 80 E = .2 90 PSET (T,180-Q),1 100 Q = Q + K * E * Q - K3 * Q * Q 110 T = T + 1 120 IF T < 320 GOTO 90 130 E = E + .5 140 T = 0 150 Q = 4 160 IF E < 3.7 GOTO 90 </pre>
---	---

Table A.4. Programs for growth on a renewable constant-flow source discussed in chapter 6.

```

10 REM APPLE: RENEW (GROWTH ON
  A RENEWABLE CONSTANT-FLOW
  SOURCE)
20 HGR : HCOLOR= 3
30 HPLOT 0,0 TO 0,159 TO 279,15
  9 TO 279,0 TO 0,0
40 J0 = 45
50 Q = .1
60 K0 = .1
70 K = .008
80 K3 = .03
90 HCOLOR= 5
100 HPLOT T,160 - Q
110 J = J0 / (1 + K0 * Q)
120 Q = Q + K * J * Q - K3 * Q
130 T = T + 1
140 IF T < 279 GOTO 90

2 REM RENEW:IBM
3 REM (Growth on a constant renewable source)
4 CLS
5 SCREEN 1,0:COLOR 0,0
6 LINE (0,0)-(320,190),1,B
7 HCOLOR= 5
10 Q = .1
20 K0 = .1
30 K = 8.000001E-03
40 J3 = .03
50 J0 = 45
60 J = J0 / (1 + K0 * Q)
70 Q = Q + K * J * Q - K3 * Q
80 T = T + 1
90 PSET(T,180-Q),2
100 IF T < 320 GOTO 60

```

Table A.5. Programs for growth in a storage tank discussed in chapter 7.

```

10 REM APPLE:TANK(STORAGE TANK
  WITH SOURCE OF STEADY FLOW)
20 HGR : HCOLOR= 3
30 HPLOT 0,0 TO 0,159 TO 279,15
  9 TO 279,0 TO 0,0
40 E = 40
50 Q = 1
60 K1 = .1
70 K2 = .05
80 HCOLOR= 5
90 HPLOT T,160 - Q
100 Q = Q + K1 * E - K2 * Q
110 T = T + 1
120 IF T < 279 GOTO 80

10 REM IBM: TANK
15 REM (Storage tank with source of steady flow)
20 CLS
30 SCREEN 1,0:COLOR 0,0
40 LINE (0,0)-(320,180),1,B
50 Q = 1
60 E = 40
70 K1 = .1
80 K2 = .05
90 Q = Q + K1 * E - K2 * Q
100 T = T + 1
110 PSET (T,180-Q),2
120 IF T < 279 GOTO 90

```

Table A.6. Programs for growth on a nonrenewable source discussed in chapter 7.

```

10 REM APPLE: NONRENEW (GROWTH
  ON A NONRENEWABLE SOURCE)
20 HGR : HCOLOR= 3
30 HPLOT 0,0 TO 0,159 TO 279,15
  9 TO 279,0 TO 0,0
40 E = 160
50 Q = .1
60 K0 = .001
70 K = .001
80 K3 = .03
90 HCOLOR= 1
100 HPLOT T,160 - Q
110 HCOLOR= 5
120 HPLOT T,160 - E
130 Q = Q + E * K * Q - K3 * Q
140 E = E - K0 * E * Q
150 T = T + 1
160 IF T < 279 GOTO 90

10 REM IBM: NONRENEW
20 REM (Growth on a nonrenewable source)
30 CLS
40 SCREEN 1,0:COLOR 0,1
50 LINE(0,0)-(320,180),3,B
60 Q = .1
70 K0 = .001
80 K = .001
90 K3 = .03
100 E = 159
110 PSET(T,180-Q),2
120 PSET(T,180-E),1
130 Q = Q + E * K * Q - K3 * Q
140 E = E - K0 * E * Q
150 T = T + 1
160 IF T < 320 GOTO 110

```

Table A.7. Programs for growth on two sources discussed in chapter 7.

<pre> 10 REM APPLE:TWO-SOURCE (GROWTH WITH RENEWABLE AND NONRENEW ABLE SOURCES) 20 HGR : HCOLOR= 3 30 H PLOT 0,0 TO 0,159 TO 279,15 9 TO 279,0 TO 0,0 40 I = 80 50 N = 150 60 Q = 1 70 K0 = .1 80 K = .002 90 K4 = .0007 100 K7 = .0008 110 K8 = .03 120 HCOLOR= 1 130 H PLOT T,160 - Q 140 HCOLOR= 5 150 H PLOT T,160 - N 160 R = I / (1 + K0 * Q) 170 Q = Q + K7 * N * Q + K * R * Q - K8 * Q 180 N = N - K4 * N * Q 190 T = T + 1 200 IF T < 279 GOTO 120 </pre>	<pre> 10 REM IBM: 2SOURCE 20 REM (Growth with nonrenewable & constant sources) 30 CLS 40 SCREEN 1,0:COLOR 0,0 50 LINE (0,0)-(320,180),3,B 60 Q = 1 70 K0 = .1 80 I = 80 90 K = .002 100 K4 = .0007 110 K8 = .03 120 K7 = .0008 130 N = 160 140 PSET (T,180-Q),1 150 PSET (T,180-N),2 160 R = I / (1 + K0 * Q) 170 Q = Q + K7 * N * Q + K * R * Q - K8 * Q 180 N = N - K4 * N * Q 190 T = T + 1 200 IF T < 320 GOTO 140 </pre>
--	--

Table A.8. Programs for draining tank discussed in chapter 8.

<pre> 10 REM APPLE: DRAIN (DRAINING TANK) 20 HGR : HCOLOR= 3 30 H PLOT 0,0 TO 0,159 TO 279,15 9 TO 279,0 TO 0,0 40 Q = 160 50 K = .01 60 H PLOT T,160 - Q 70 Q = Q - K * Q 80 T = T + 1 90 IF T < 279 GOTO 60 </pre>	<pre> 10 REM IBM; DRAIN (model of draining tank) 20 CLS 30 SCREEN 1,0: COLOR 0,0 40 LINE (0,0)-(320,180),1,B 50 Q = 160 60 K = .01 70 T = 0 80 PSET (T,160 - Q),2 90 Q = Q - K * Q 100 T = T + 1 110 IF T < 320 GOTO 80 </pre>
---	---

Table A.9. Programs for production-consumption discussed in chapter 8.

<pre> 10 REM APPLE: P-C (PRODUCTION- CONSUMPTION) 20 HGR : HCOLOR= 3 30 H PLOT 0,0 TO 0,159 TO 279,15 9 TO 279,0 TO 0,0 40 Q = .1 50 K1 = .01 60 K2 = .2 70 N = 1 80 IF N = 1 THEN S = 200000 90 IF N = 2 THEN S = 350000 100 IF N = 3 THEN S = 450000 110 IF N = 4 THEN S = 350000 120 N = N + 1 130 IF N = 5 THEN N = 1 140 H PLOT T / .07,50 - S / 1000 0 150 H PLOT T / .07,160 - Q / 200 160 P = K1 * S 170 C = K2 * Q 180 Q = Q + P - C 190 T = T + 1 200 IF T / .07 < 279 GOTO 80 </pre>	<pre> 10 REM IBM: P-C (model of production-consumption) 20 CLS 30 SCREEN 1,0: COLOR 0,0 40 LINE (0,0)-(320,180),2,B 50 Q = .1 60 K1 = .01 70 K2 = .2 80 N = 1 90 IF N = 1 THEN S = 200000! 100 IF N = 2 THEN S = 350000! 110 IF N = 3 THEN S = 450000! 120 IF N = 4 THEN S = 350000! 130 N = N + 1 140 IF N = 5 THEN N = 1 150 PSET (T / .07,50 - S / 10000),3 160 PSET (T / .07,180 - Q / 200),1 170 P = K1 * S 180 C = K2 * Q 190 Q = Q + P - C 200 T = T + 1 210 IF T / .07 < 279 GOTO 90 </pre>
---	--

Table A.10. Programs for simple predator-prey oscillation in Figure 9.1.

```

10 REM APPLE: PREDPREY (PREDATOR
  -PREY OSCILLATION)
20 HGR : HCOLOR= 3
30 HPLOT 0,0 TO 0,159 TO 279,15
  9 TO 279,0 TO 0,0
40 E = 1
50 Q = 10
60 H = 5
70 K1 = .1
80 K2 = .005
90 K3 = .004
100 K4 = .1
110 HCOLOR= 1
120 HPLOT T,160 - Q
130 HCOLOR= 5
140 HPLOT T,160 - H
150 Q = Q + K1 * E * Q - K2 * Q *
  H
160 H = H + K3 * Q * H - K4 * H
170 T = T + 1
180 IF T < 279 GOTO 110

```

```

10 REM IBM: PREDPREY (model of predator-prey oscillation)
20 CLS
30 SCREEN 1,0:COLOR 0,0
40 LINE (0,0)-(320,180),3,B
50 E = 1
60 Q = 10
70 H = 5
80 K1 = .1
90 K2 = .005
100 K3 = .004
110 K4 = .1
120 PSET (T,180-Q),1
130 PSET (T,180-H),2
140 Q = Q + K1 * E * Q - K2 * Q * H
150 H = H + K3 * Q * H - K4 * H
160 T = T + 1
170 IF T < 320 GOTO 120

```

Table A.11. Programs for fire in Figure 9.2.

```

10 REM APPLE: FIRE (FIRE WITH
  RECYCLED NUTRIENTS)
20 HGR : HCOLOR= 3
30 HPLOT 0,0 TO 0,159 TO 279,15
  9 TO 279,0 TO 0,0
40 G1 = 18000
50 N0 = 25
60 Q = 1000
70 E = 25
80 K2 = .005
90 F = 16000
100 P = .001
110 HCOLOR= 5
120 IF Q > G1 THEN X = 1
130 IF Q > G1 THEN Q = Q - F:N =
  N0: HPLOT T - 2,160 - G1 / 3
  00 TO T + 2,160 - Q / 300
140 HCOLOR= 6
150 HPLOT T,160 - N * 2
160 HCOLOR= 1
170 HPLOT T,160 - Q / 300
180 Q = Q + N * E - K2 * Q
190 N = N0 - P * Q
200 T = T + 1
210 IF T < 279 GOTO 110

```

```

10 REM IBM: FIRE (model of fire with recycled nutrients)
20 CLS
30 SCREEN 1,0:COLOR 0,1
40 LINE (0,0)-(320,180),4,B
50 G1 = 18000
60 N0 = 25
70 Q = 1000
80 E = 25
90 K2 = .005
100 F = 16000
110 P = .001
125 IF Q > G1 THEN LINE (T,180-G1/300)-(T,180-6.667),2
130 IF Q > G1 THEN Q = Q - F:N = N0
150 PSET(T,180-N*2),3
170 PSET (T,180-Q/300),1
180 Q = Q + N * E - K2 * Q
190 N = N0 - P * Q
200 T = T + 1
210 IF T < 320 GOTO 125

```

Table A.12. Programs for pulse in Figure 9.3.

```

10 REM APPLE: PULSE (PULSING)
20 HGR : HCOLOR= 3
30 HPLOT 0,0 TO 0,159 TO 279,15
   9 TO 279,0 TO 0,0
40 E = 200
50 Q = 2
60 I = .5
70 C = 2
80 K1 = .02
90 K2 = .01
100 K3 = .0003
110 K4 = .2
120 T0 = .5
130 Q0 = 1
140 C0 = 1
150 M = E - Q - C
160 DQ = K1 * M - K2 * Q - K3 *
   C * C * Q
170 DC = K2 * Q + K3 * Q * C * C
   - K4 * C
180 Q = Q + DQ * I
190 C = C + DC * I
200 T = T + I
210 HCOLOR= 1
220 HPLOT T / T0,160 - Q / Q0
230 HCOLOR= 5
240 HPLOT T / T0,160 - C / C0
250 IF T / T0 < 279 GOTO 150

```

```

10 REM IBM: PULSE (pulse model)
20 CLS
30 SCREEN 1,0: COLOR 0,0
40 LINE (0,0)-(320,180),3,B
50 E = 200
60 Q = 2
70 I = .5
80 C = 2
90 K1 = .02
100 K2 = .01
110 K3 = .0003
120 K4 = .2
130 T0 = .5
140 Q0 = 1
150 C0 = 1
160 M = E - Q - C
170 DQ = + K1 * M - K2 * Q - K3 * C * C * Q
180 DC = K2 * Q + K3 * Q * C * C - K4 * C
190 Q = Q + DQ * I
200 C = C + DC * I
210 T = T + I
220 PSET (T / T0,180 - Q / Q0),1
230 PSET (T / T0,180 - C / C0),2
240 IF T / T0 < 320 GOTO 160

```

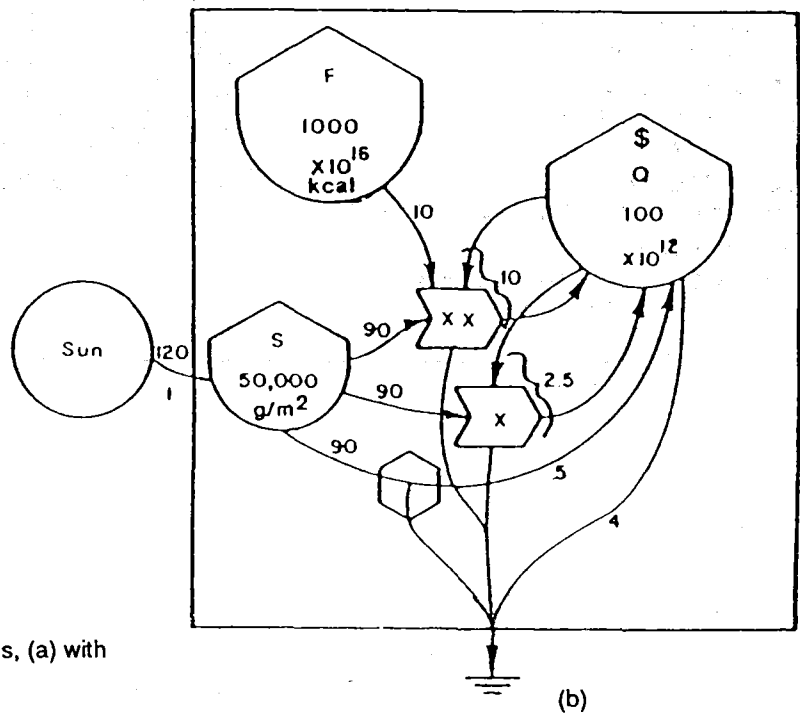
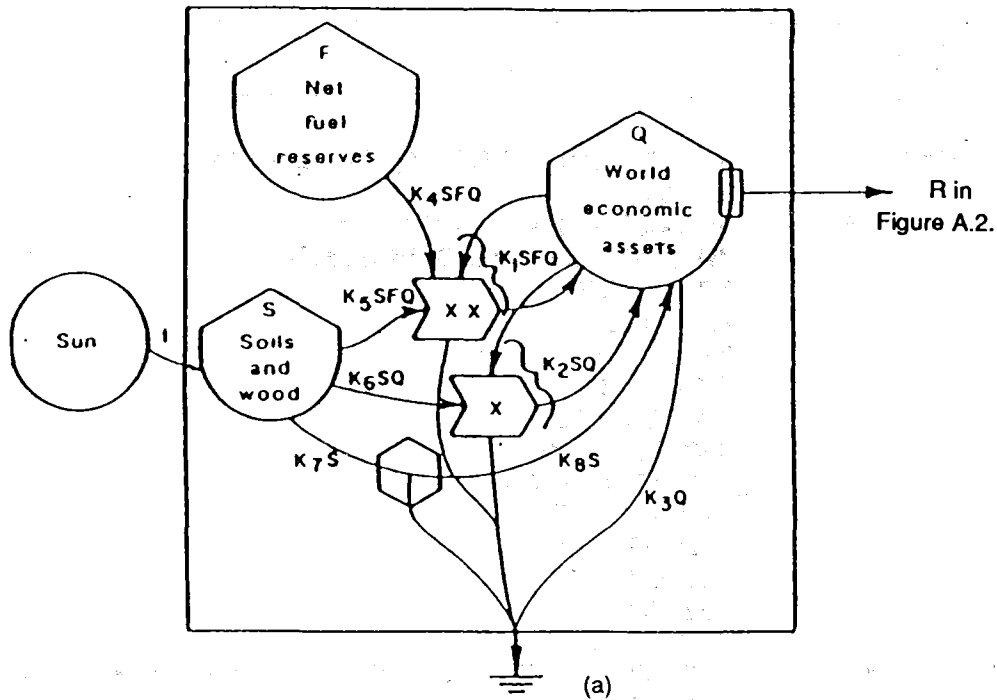

Figure A.1. A simplified model of world trends, (a) with equations, (b) with data for 1978.

Explanation and program for World Trends in chapter 27.

The model has the world economic assets drawing inputs from the reserves of fuels and minerals and from the renewable storages of soils and wood. There are three pathways of resource use that generate economic assets; each is slightly different.

The lower pathway (K_8S) is a linear pathway where the storage of soils and wood are incorporated into world assets based on the amount of the storage. The middle pathway (K_2SQ) is an autocatalytic pathway where world assets are used in an interactive way to process more stored resources. And the top pathway (K_1SFQ) is

Each pathway represents different stages of economic development. The linear pathway represents the very earliest stages of development (undeveloped economies) where there is little work by populations to increase production through co-operation and mechanical means. The middle autocatalytic pathway represents developing economies that utilize some of their assets (tools, machines, information) in feedback actions to increase production. The top pathway represents developed economies that have tapped vast storages of mineral and fuel reserves to power their

A brief explanation of each of the storages and pathways follows:

Q is the dollar value of the assets of the world.

S is the storages of soils and wood (g/m² organic matter).

F is the net reserve of fuels available to economic development (fuel kilocalories).

I is the utilization of solar energy.

K₁SFQ and K₂SQ are rates of production of economic assets.

K₃Q is the rate of depreciation of economic assets.

K₄SFQ, K₅SFQ, K₆SQ, and K₇S are the rates of utilization of fuels and soils/wood.

K₈S is the production of assets from rural areas including wilderness.

R is a sensor of Q; it will be used in the following country trend model.

Simulating the World Trend Model

To simulate the model in Figure 27.1, a computer program was written (like those in Chapter 8) using the equations in Table A.13. The equations were derived from the relationships given by the pathways and symbols in the model. Values used to calibrate the model are shown in Figure A.1b.

Next, values of storages and flows were estimated from 1978 data. These are given in Table A.14. From the values of storages and flows, the coefficients for each pathway were calculated and are also given in Table A.14. The simulation program is given in Table A.15.

Table A.13. Table of equations for the world trend model in Figure 27.1.*

$$D1 = + K1 \cdot S \cdot F \cdot Q + K2 \cdot S \cdot Q + K8 \cdot S - K3 \cdot Q$$

$$D2 = + I - K5 \cdot S \cdot F \cdot Q - K6 \cdot S \cdot Q - K7 \cdot S$$

$$D3 = - K4 \cdot S \cdot F \cdot Q$$

* Use these equations in the computer program, Table A.15.

Table A.14 Values of storages and flows coefficients.*

Storage or flow	Value	Pathway coefficient
S	5E4	
Q	100	
F	1E3	
I	120	
K ₁ SFQ	10	K ₁ = 2E-9
K ₂ SQ	2.5	K ₂ = 5E-7
K ₃ Q	4	K ₃ = .04
K ₄ SFQ	10	K ₄ = 2E-9
K ₅ SFQ	90	K ₅ = 1.8 E-8
K ₆ SK6Q	90	K ₆ = 1.8 E-5
K ₇ S	90	K ₇ = 1.8 E-3
K ₈ S	.5	K ₈ = 1 E-5

* Example calculation of a coefficient is as follows:

$$K_1 \text{SFQ} = 10$$

$$K_1 = \frac{10}{5E4 \times 1E3 \times 100} = \frac{10}{5E9} = 2E-9$$

Table A.15. Programs for world model in Figures 27.1, 27.2, and A.1.

```

10 REM APPLE: WORLD (WORLD
   TRENDS)
20 HGR : HCOLOR= 3
30 HPLLOT 0,0 TO 0,159 TO 279,15
   9 TO 279,0 TO 0,0
40 S = 6E4
50 S0 = 800
60 Q = 1
70 Q0 = 1.9
80 F = 0
90 F0 = 6.25
100 I = 120
110 T0 = 2.2
120 K1 = 1E - 9
130 K2 = .5E - 6
140 K3 = .04
150 K4 = 2E - 9
160 K5 = 1.8E - 8
170 K6 = 1.8E - 5
180 K7 = 1.8E - 4
190 K8 = 1E - 5

```

```

200 HCOLOR= 5: REM WORLD ASSETS
   ARE RED
210 IF T = 230 THEN F = 1000
220 HPLLOT T / T0,160 - Q / Q0
230 HCOLOR= 1: REM WORLD SOIL
   & WOOD ARE GREEN
240 HPLLOT T / T0,160 - S / S0
250 HCOLOR= 7: REM WORLD FUEL
   IS WHITE
260 HPLLOT T / T0,160 - F / F0
270 D1 = K1 * S * F * Q + K2 * S
   * Q - K3 * Q + K8 * S
280 D2 = I - K7 * S - K5 * S * F
   * Q - K6 * S * Q
290 D3 = - K4 * S * F * Q
300 Q = Q + D1
310 S = S + D2
320 F = F + D3
330 T = T + 1
340 IF T < 279 * T0 60TO 200

```

Table A.16. Programs of state model driven by world model in Figures 27.3 and A.2.

```

10 REM APPLE:ST-WORLD (STATE
MODEL DRIVEN BY WORLD MODEL)

20 HGR : HCOLOR= 3
30 HPLOT 0,0 TO 0,159 TO 279,15
9 TO 279,0 TO 0,0
40 HPLOT 0,80 TO 279,80
50 S = 6E4
60 S0 = 1E3
70 Q = 31
80 Q0 = 3.5
90 F = 0
100 F0 = 13
110 I = 120
120 T0 = 2.2
130 K1 = 1E - 9
140 K2 = .5E - 6
150 K3 = .04
160 K4 = 2E - 9
170 K5 = 1.8E - 8
180 K6 = 1.8E - 5
190 K7 = 18E - 4
200 K8 = 1E - 5
210 W = 11
220 U = 1.6
230 Q1 = 50
240 REM WORLD IS TOP OF SCREEN
250 HCOLOR= 5: REM WORLD ASSET
S ARE RED
260 IF T = 230 THEN F = 1000
270 HPLOT T / T0,80 - Q / Q0
280 HCOLOR= 1: REM WORLD SOIL
& WOOD ARE GREEN
290 HPLOT T / T0,80 - S / S0
300 HCOLOR= 7: REM WORLD FUEL
IS WHITE
310 HPLOT T / T0,80 - F / F0
320 D1 = K1 * S * F * Q + K2 * S
* Q - K3 * Q + K8 * S
330 D2 = I - K7 * S - K5 * S * F
* Q - K6 * S * Q
340 D3 = - K4 * S * F * Q
350 Q = Q + D1
360 S = S + D2
370 F = F + D3
380 J = 2
390 L = .1
400 L1 = .08
410 L2 = .133
420 L3 = .17
430 L4 = .01
440 L5 = .006
450 L6 = .04666
460 U0 = .3
470 W0 = .3
480 Q1 = 50
490 PSET (T / T0,160 - W / W0),1
500 PSET (T / T0,160 - U / U0),2
510 E = L * U
520 R = Q / Q1
530 D4 = J - L3 * W - L1 * R * E * W - L5 * W
540 D5 = L2 * E * R * W + L4 * W - E - L6 * U
550 W = W + D4
560 IF W < .1 THEN W = .1
570 U = U + D5
580 T = T + 1
590 IF T < 320 * T0 GOTO 240

10 REM IBM: ST-WORLD (state model driven by world model)
20 CLS
30 SCREEN 1,0: COLOR 0,1
40 LINE (0,0)-(320,180),3,B
50 LINE (0,80)-(320,80)
60 S = 60000!
70 S0 = 1000!
80 Q = 1
90 Q0 = 3
100 F = 0
110 F0 = 13
120 I = 120
130 T0 = 2.2
140 K1 = 1E-09
150 K2 = .00000005
160 K3 = .04
170 K4 = 2E-09
180 K5 = 1.8E-08
190 K6 = .000018
200 K7 = .0018
210 K8 = .00001
220 W = 10
230 U = .1
240 REM WORLD IS TOP OF SCREEN
250 IF T = 300 THEN F = 1000
260 REM ASSETS ARE PURPLE
270 PSET (T / T0,80 - Q / Q0),2
280 REM SOIL & WOOD ARE BLUE
290 PSET (T / T0,80 - S / S0),1
300 REM FUEL IS WHITE
310 PSET (T / T0,80 - F / F0),3
320 D1 = K1 * S * F * Q + K2 * S * Q - K3 * Q + K8 * S
330 D2 = I - K7 * S - K5 * S * F * Q - K6 * S * Q
340 D3 = - K4 * S * F * Q
350 Q = Q + D1
360 S = S + D2
370 F = F + D3
380 J = 2
390 L = .1
400 L1 = .08
410 L2 = .133
420 L3 = .17
430 L4 = .01
440 L5 = .006
450 L6 = .04666
460 U0 = .3
470 W0 = .3
480 Q1 = 50
490 PSET (T / T0,160 - W / W0),1
500 PSET (T / T0,160 - U / U0),2
510 E = L * U
520 R = Q / Q1
530 D4 = J - L3 * W - L1 * R * E * W - L5 * W
540 D5 = L2 * E * R * W + L4 * W - E - L6 * U
550 W = W + D4
560 IF W < .1 THEN W = .1
570 U = U + D5
580 T = T + 1
590 IF T < 320 * T0 GOTO 240

```

Explanation and Program for World Population Simulated in Figure 28.2.

A model which makes population dependent on overall production of economic assets is given in Figure A.3a. The diagram shows the mathematical relationships. They are also given below the diagram as equations. Verbal explanations for the model relationships follow:

On the left, production of economic assets is generated by interaction of the flow of renewable resources remaining unused R , nonrenewable resource reserves F , feedback inputs from economic assets A , and feedback input from population N . The nonrenewable resources available are the remainder R of the inflow J not yet in use. (See Figure 6.3 for more explanation of limitations of constant, nonrenewable sources.) One production flow $K_3 \cdot R \cdot F \cdot N \cdot A$ operates only when there are still nonrenewable fuels available; another $K_4 \cdot R \cdot A$ becomes important only when they are gone. The quantity of economic assets A is a balance between the productive flows and the outflows. The outflows include depreciation $K_5 \cdot A$, the economic assets used to develop populations $K_6 \cdot (A/N) \cdot N$, the economic assets used for regular health and medicine $L_0 \cdot (1 - K_9 \cdot A)$ and those used for epidemic disease ($L_0 \cdot N^2 \cdot (1 - K_9 \cdot A)$).

The number of people N in the world is given as the balance between reproduction and mortality. Reproduction per person is made the product of economic assets per person A/N and the number of people N , where economic assets are evaluated in eMergy units which includes environmental as well as urban assets. As countries develop economically, the eMergy per person gradually declines as do birth rates.

In other words, this model has built into it the hypothesis that population reproduction in one way or another is diminished as people become crowded relative to their resources.

Two pathways of mortality are included, regular deaths and deaths from epidemic disease. Regular mortality $k_7 \cdot N \cdot (1 - k_9 \cdot A)$ is in proportion to the population N but diminished in proportion to the economic assets used in health care ($1 - k_9 \cdot A$). Epidemic mortality is in proportion to the square of the population N^2 but also diminished by the economic assets available for health and medicine ($1 - k_9 \cdot A$). A square of population is appropriate because epidemics spread in proportion to population interactions, which is mathematically the square of the number.

The program was calibrated with values for 1980. The program is listed in appendix Table A.17. When run, it generates the graphs shown in Figure 28.2. As the nonrenewable fuels are used up, economic assets pass through a maximum and start to decrease. Not many years later the population crests and decreases rapidly, a result of declining birth rates and higher mortalities.

The population simulation shows that the assets per person during growth are higher than those during the decline period. However, later with lower populations, the assets per person are reasonably good. In one sense this model is an optimistic one, implying that a reasonable standard of living is possible in lower energy times, providing population levels are adjusted to be in proportion to resources available for use.

1 Odum, H.T. and G. Scott, 1983. A Resource-based Model of World Population. Unpublished manuscript.

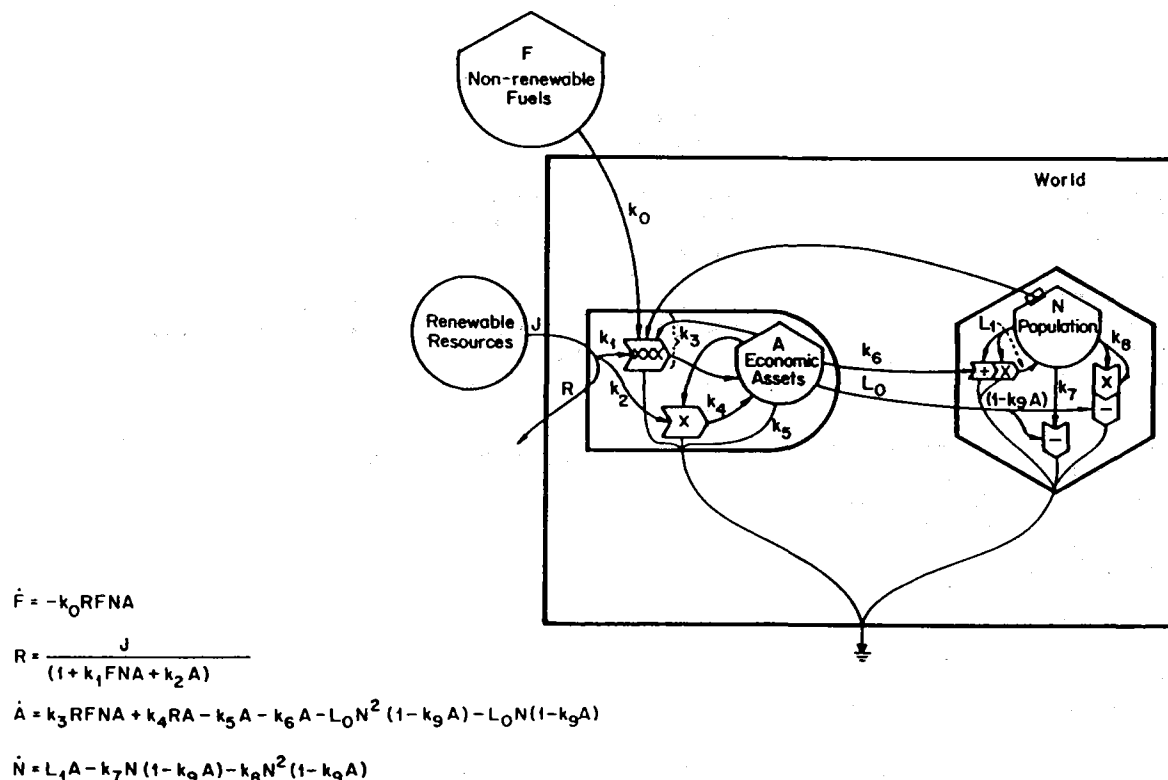

Table A.17. Programs for population model in Figure 28.2.

```

10 REM APPLE: PEOPLE (WORLD POP
ULATION GROWTH)
20 HGR : HCOLOR= 3
30 HPLLOT 0,0 TO 0,159 TO 279,15
9 TO 279,0 TO 0,0
40 HPLLOT 0,30 TO 279,30
50 J = 8.56
60 I = 5
70 N = .5
80 A = 1
90 R = 12.5
100 F = 1000
110 K0 = 3E - 5
120 K1 = 1.76E - 5
130 K2 = .01
140 K3 = 1.76E - 5
150 K4 = .01
160 K5 = .05
170 K6 = .0135
180 K7 = .126
190 K8 = 4.116E - 3
200 K9 = .009
210 L1 = 1.054E - 3
220 L0 = .0433
230 T0 = 2.8
240 N0 = .111
250 F0 = 33.333
260 A0 = 2.22
270 X = 1
280 REM
290 R = J / (1 + K1 * F * N * A +
K2 * A)
300 DF = - K0 * R * F * N * A
310 DA = K3 * R * F * N * A + K4
* R * A - K5 * A - K6 * A -
L0 * N * N * (1 - K9 * A)
320 B = L1 * A
330 D = K7 * N * (1 - K9 * A) +
K8 * N * N * (1 - K9 * A)
340 IF D < 0 THEN D = 0
350 F = F + DF * I * X
360 N = N + (B - D) * I
370 IF N < .01 THEN N = .01
380 A = A + DA * I
390 IF A < 1 THEN A = 1
400 BR = B * 100 / N
410 DR = D * 100 / N
420 HCOLOR= 3: REM PEOPLE ARE
WHITE
430 HPLLOT T / T0,160 - N / N0
440 HCOLOR= 5: REM ASSETS ARE
RED
450 HPLLOT T / T0,160 - A / A0
460 HCOLOR= 2: REM FUEL RESERV
ES ARE VIOLET
470 HPLLOT T / T0,30 - F / F0
480 IF F < 1 THEN F = 1
490 T = T + I
500 IF T / T0 < 279 GOTO 280

```

```

10 REM IBM: PEOPLE
20 REM (World population model)
30 CLS
40 SCREEN 1,0: COLOR 0,1
50 LINE (0,0)-(320,180),3,B
60 LINE (0,30)-(320,30)
70 J = 8.560001
80 I = 5
90 N = .5
100 A = 1
110 R = 12.5
120 F = 1000
130 K0 = .00003
140 K1 = .0000176
150 K2 = .01
160 K3 = .0000176
170 K4 = .01
180 K5 = .05
190 K6 = .0135
200 K7 = .126
210 K8 = .004116
220 K9 = 8.999999E-03
230 L1 = .001054
240 L0 = .0433
250 T0 = 2.8
260 N0 = .111
270 F0 = 33.333
280 A0 = 2.22
290 X = 1
300 REM
310 R = J / (1 + K1 * F * N * A + K2 * A)
320 DF = - K0 * R * F * N * A
330 DA = K3 * R * F * N * A + K4 * R * A -
K5 * A - K6 * A -
L0 * N * N * (1 - K9 * A)
340 B = L1 * A
350 D = K7 * N * (1 - K9 * A) +
K8 * N * N * (1 - K9 * A)
360 IF D < 0 THEN D = 0
370 F = F + DF * I * X
380 N = N + (B - D) * I
390 IF N < .01 THEN N = .01
400 A = A + DA * I
410 IF A < 1 THEN A = 1
420 BR = B * 100 / N
430 DR = D * 100 / N
440 REM PEOPLE ARE WHITE
450 PSET (T / T0,180 - N / N0),3
460 REM ASSETS ARE BLUE
470 PSET (T / T0,180 - A / A0),1
480 REM FUEL RESERVES ARE VIOLET
490 PSET (T / T0,30 - F / F0),2
500 IF F < 1 THEN F = 1
510 T = T + I
520 IF T / T0 < 320 GOTO 300
530 END

```

- Aerobic** - containing oxygen or requiring oxygen for respiration
- Agricultural** - having to do with farming; cultivation of ground to raise food
- Amplifier** - a means of multiplying an effect
- Amplitude** - the distance from the crest to the trough of a wave
- Anaerobic** - without oxygen
- Archeology** - the study of past cultures, based on relics and remains
- BASIC** - Beginner's All-purpose Symbolic Instructional Code; one of several languages that computers use
- Benthic** - the sediment water interface at the bottom of aquatic systems
- Benthos** - community living in or on the sediment water interface
- Biomass** - the total mass of all organisms and dead organic matter in a given area
- Bog** - wetland community characterized by peat accumulation
- Boreal** - northern forest of conifers and alders
- Calorie** - heat energy required to raise the temperature of a milliliter of water one degree Celsius
- Carrying capacity** - amount of animal life, human life, or industry that can be supported on available resources
- Chaparral** - a thorny scrub forest with semi-arid climate
- Climax** - the final stage of succession in which the dominant species are able to maintain the system
- Coefficient** - a numerical factor that relates one system flow to another
- Colonial** - organisms of the same type (species) living together in groups or colonies
- Community** - an interacting group of organisms
- Conifers** - evergreen trees that bear cones as reproductive organs
- Constant-pressure source** - an energy source that is so large it is considered to supply constant pressure to a system
- Consumer** - an organism that derives its energy from other organisms
- Continental shelf** - gently sloping land extending from the shoreline outward into the oceans from each of the continents
- Control burn** - planned burn of a forest to eliminate underbrush
- Controlled-flow renewable source** - source that runs a system with a flow that cannot be controlled by the system itself
- Coriolis Force** - a force resulting from the earth's rotation that causes motions in the Northern Hemisphere to be bent to the right
- Deciduous** - trees that shed leaves seasonally (in the fall of in dry seasons)
- Decomposer** - organism that breaks down dead matter and returns nutrients to the system
- Decomposition** - the process of breaking down organic matter to simpler nutrients
- Defoliation** - the dropping off of leaves
- Detritus** - organic matter that is in the process of being decomposed
- Difference equation** - an equation which calculates the differences in states at two different times.
- Dinoflagellates** - solitary plant-like plankton that are important to ocean systems; one-celled swimmers
- Drift line** - high tide margin where floating debris collects
- Dynamic equilibrium** - a steady-state balanced system
- Economic web** - the relationship of producers and consumers in an economic system which involves the exchange of money
- Ecosystem** - a community of organisms in interaction
- eMergy** - the energy that was used to make a product; its embodied energy
- Emjoules** - unit of measurement of eMergy
- Energy** - the ability to generate heat
- eMergy-dollar ratio** - the ratio of eMergy use to gross national product
- Epidemic** - extensive spread of disease through a community
- Epiphytes** - non-parasitic plants found growing on other plants
- Erosion** - the wearing away of land surface by water or wind
- Estuary** - partially enclosed coastal waters characterized by a mixing of fresh and saltwaters
- Eutrophic** - high in nutrients
- Evapotranspiration** - the loss of water from a system through the process of evaporation and transpiration
- Evergreen** - trees and shrubs that do not shed their leaves seasonally; are always green
- Exotic** - introduced; not native
- Exponential** - rapid growth or decline, based on an autocatalytic function
- Feedback loop** - flow from the product of one interaction back to interact with another
- Filter feeder** - organism that gets its food by filtering the water that surrounds it
- Final demand** - the ultimate or final consumer in an economic web
- Fire sub-climax** - an ecosystem that is maintained by fire to prevent the growth of climax vegetation
- Flow chart** - game plan for a program (as for a computer)
- Food chain** - a description of a series of energy transfers in a living system, in which the organisms obtain their energy by eating others
- Food web** - feeding relationships between organisms in a community; includes a network of food chains
- Gene pool** - total genetic variety within a community
- Glacier** - slowly moving mass of ice and snow
- Grasslands** - flat or rolling terrain with low rainfall and covered by grasses and herbaceous growth
- Gross National Product (GNP)** - flow of money through the household and government sectors of an economy
- Gross production** - total amount of product that results from a production process
- Hard water** - water that is high in mineral (calcium and magnesium) content
- Hardwood** - broad-leaved tree, like oak or hickory
- Herbaceous** - a non-woody plant
- Herbivore** - an animal that gets its energy from eating plants
- Hibernate** - to spend time in a resting stage
- High quality energy** - energy that is concentrated, which can do greater amounts of work by its interactions
- Holocene** - geologic epoch from 10,000 years ago until the present time
- Humus** - dark material found beneath the litter of a forest floor, formed by the partial decomposition of organic matter
- Hydroperiod** - the length of time that a wetland area is flooded by water
- Inflation** - the decrease of buying power, or worth, of money
- Inorganic** - non-living; not part of a living thing, nor a product of life
- Input-output table** - pathways of money as shown in a matrix
- Intensive agriculture** - farming that uses large inputs of fuels, machinery, labor

Jungle - an impenetrable thicket of tropical vegetation
Kilocalorie - 1000 calories
Land rotation - alternating use of land for agriculture to allow ecological succession to rebuild soils
Latitude - angular distance north and south from the equator
Legume - a plant of the pea and bean family whose roots contain nitrogen-fixing bacteria
Lianas - climbing woody plants that root in the ground and are typically found in tropical rain forests
Lichens - a complex plant that develops from the symbiotic relationship between algae and a fungus
Limiting factor - a factor, such as temperature, light, or nutrients, that limits the growth, abundance, or distribution of an organism
Loess - thick layers of wind-blown soil that were deposited during the ice ages
Low energy agriculture - a simple farming system that uses the labor of humans and farm animals rather than fuels and machinery
Low quality energy - dilute energy; energy with little ability to amplify or control
Macroeconomic value - the value of a product to the entire economy of a society
Macrophytes - plants large enough to be seen without a microscope; usually refers to aquatic or wetland plants
Maize - a type of primitive corn grown by Indians
Marsh - a wetland area covered mainly by grasses
Megafauna - large animals
Megajoule - one million joules
Microeconomic value - the value of a product to one individual or business
Micro-climate - selected area where climate conditions are different from the surrounding area, such as within a dense forest
Monoculture - growing only one type of crop over a large area
Monsoon - periodic reversal of winds of the Indian Ocean, Southern Asia, and the Western Pacific
Native - having its origin in a particular region and found living there
Net eMergy - amount of eMergy remaining after using up and losing some energy in the production process
Net eMergy ratio - ratio of yield to eMergy feedback
Net production - gross production minus consumption over a certain time period
Nitrogen fixation - conversion of atmospheric nitrogen to nitrates by bacteria
Nonrenewable resource - resource that is found in a definite amount and cannot be replaced in a given time period
Nursery - place where animals spend early part of life, grow rapidly, and mature
Nutrient - substance required by living things for basic life processes, as inorganic mineral chemicals
Oasis - localized region in desert where water table is found near the surface and supports plant life
Oligotrophic - low in nutrients
Organic - material that is living or once was living
Oscillation - regular pattern of moving back and forth between two extremes
Oxidize - a process in which another substance chemically combines with oxygen
Peat - solid matter that results from the partial decomposition of plants in water
Percolate - to move or trickle down through a permeable substance
Periphyton - algae and small animals that grow attached to underwater surfaces, such as rocks and sticks in lakes and streams
Permafrost - soil that remains always frozen
Photosynthesis - process in green plants that uses light energy to produce organic matter

Phytoplankton - microscopic plant life suspended in waters
Pioneer - the first species to move in and colonize an area
Pleistocene - the geologic epoch from two million years ago until ten thousand years ago
Predator - animal that gets its food from the killing and eating of other animals
Prey - animal that is eaten by a predator
Primary consumer - herbivore; the first consumer in a food chain
Producer - organism (green plant) that produces its own food from raw ingredients; manufacturing industry
Program - a sequence of instructions
Quantitative - dealing with numbers and measurements
Respiration - process in an organism that releases energy from chemical storages
Renewable - a resource that can be replenished or renewed
Salinity - measurement of concentration of salt in a body of water
Sargassum - floating brown seaweed that forms large mats; often floating
Savannah - tropical or sub-tropical grassland with scattered trees and drought-resistant undergrowth
Secondary consumer - animal that eats a primary consumer
Sediment - the matter that settles to the bottom of oceans, rivers, and lakes
Simulation - imitation of what will happen without actually doing a particular event
Silviculture - the commercial production of trees
Steppes - arid grassland characterized by scattered compact tufts of grasses
Sublime - to change from a solid to a gas state without becoming liquid
Succession - the change of a system over time, resulting in a mature stage
Swamp - wetland area covered mainly by trees (at least 35% tree cover)
Symbiotic - relationship between two organisms that benefits both
System - set of items that operate together to form a unified whole
Temperate rain forest - area of large rainfall and moderate temperatures that supports lush and large vegetation
Timberline - the elevation above which trees will not grow
Transaction - an exchange of energy and money
Transformation - a change from one form to another
Transformity - the ratio of energy of one type required to produce a unit of energy of another type
Transpiration - loss of water from leaves of green plants into the air
Trophic level - position within a food chain
Tundra - treeless plain of the arctic region or high mountains above the timberline
Turbid - not clear; muddy
Turbulence - mixing action of a body of water or air
Understory - small trees, shrubs, and seedlings found above the ground cover and beneath the canopy of a forest
Upwelling - movement of deep, cold, nutrient-rich water to the surface of oceans
Wetland - land area that is periodically covered with water and contains specialized wetland plants
Work - the use of energy for a production process
Yield - output resulting from a production process
Zooplankton - microscopic animal life suspended in waters