



UNITED
NATIONS

EP

UNEP/MED WG.509/30



**Mediterranean
Action Plan**
Barcelona
Convention

30 August 2021
Original: English

Meeting of the MED POL Focal Points

Teleconference, 27-28 May and 6-7 October 2021

Agenda item 12: Harmonization and standardization of IMAP Pollution Cluster Monitoring

Monitoring Guidelines/Protocols for Sampling and Sample Preservation of Sea Food for IMAP Common Indicator 20: Heavy and Trace Elements and Organic Contaminants

For environmental and cost-saving reasons, this document is printed in a limited number. Delegates are kindly requested to bring their copies to meetings and not to request additional copies.

Table of Contents

1	Introduction	1
2	Technical note for the sampling of seafood for the analysis of heavy metals and organic contaminants	3
2.1	Protocol for the collection of fish, crustaceans, cephalopods and bivalves for heavy metal and organic contaminants analysis.....	3
3	Technical Note for the dissection of seafood for the analysis of heavy metals and organic contaminants	6
3.1	Protocol for dissection of fish to collect the edible part for analysis.....	6
3.2	Protocol for dissection of bivalves to collect the edible part for analysis (whole body)	8
3.3	Protocol for dissection of crustaceans to collect the edible part for analysis	9
3.4	Protocol for dissection of cephalopods to collect the edible part for analysis (mantle and head)	10
4	Technical note for the sample preservation of seafood for the analysis of heavy metals and organic contaminants	10
4.1	Protocol for the treatment of seafood samples prior to heavy metal analysis.....	10
4.2	Protocol for the treatment of seafood samples prior to analysis for organic contaminants	11

Annexes

Annex I: Indicative Tables of most consumed species of fish and seafood for different (sub) regions. JRC Technical Report 2010. (1.1.1.);

Annex II: EU Commission Regulation (EC) No 1881/2006, setting maximum levels for certain contaminants in seafood (1.1.2.);

Annex III: EU Commission Regulation (EC) No 333/2007, laying down the methods of sampling and analysis for the official control of the levels of lead, cadmium, mercury, inorganic tin, 3-MCPD and benzo(a)pyrene in foodstuffs (1.1.3.);

Annex IV: EU Commission Regulation (EC) No 836/2011 amending (EC) No 333/2007 laying down the methods of sampling and analysis for the official control of the levels of lead, cadmium, mercury, inorganic tin, 3-MCPD and benzo(a)pyrene in foodstuffs(1.1.10)

Annex V: EU Commission Regulation (EC) No 644/2017, laying down methods of sampling and analysis for the official control of levels of dioxins and dioxin-like PCBs in certain foodstuffs (1.1.4.);

Annex VI: UNEP/FAO/IOC/IAEA (1987). Reference methods No 6 (Rev. 1): Guidelines for monitoring chemical contaminants in marine organisms (1.1.5.);

Annex VII: UNEP/FAO/IOC/IAEA (1988). Reference methods No 7 (Rev. 2): Sampling of selected marine organisms and sample preparation for trace metal analysis (1.1.6);

Annex VIII: HELCOM (2012). Annex B-12, Appendix 1. Technical note on biological material sampling and sample handling for the analysis of persistent organic pollutants (PAHs, PCBs and OCPs) and metallic trace elements (1.1.7);

Annex IX: US EPA (2000). Guidance for Assessing Chemical Contaminant Data for Use in Fish Advisories Volume 1 Fish Sampling and Analysis. Third Edition (1.1.8.);

Annex X: References.

Note by the Secretariat

In line with the Programme of Work 2020-2021 adopted by COP21 the MED POL Programme has prepared the Monitoring Guidelines related to IMAP Common Indicators 13, 14, 17 and 20 for consideration of the Integrated Meeting of the Ecosystem Approach Correspondence Groups on Monitoring (December 2020), whilst the Monitoring Guidelines for Common Indicator 18, along with the Monitoring Guidelines related to data quality assurance and reporting are under finalization for consideration of the Meeting on CorMon on Pollution Monitoring planned to be held in April 2021.

These Monitoring Guidelines present coherent manuals to guide technical personnel of IMAP competent laboratories of the Contracting Parties for the implementation of the standardized and harmonized monitoring practices related to a specific IMAP Common Indicator (i.e. sampling, sample preservation and transportation, sample preparation and analysis, along with quality assurance and reporting of monitoring data). For the first time, these guidelines present a summary of the best available known practices employed in marine monitoring by bringing integrated comprehensive analytical practices that can be applied in order to ensure the representativeness and accuracy of the analytical results needed for generation of quality assured monitoring data.

The Monitoring Guidelines/Protocols build upon the knowledge and practices obtained over 40 years of MED POL monitoring implementation and recent publications, highlighting the current practices of the Contracting Parties' marine laboratories, as well as other Regional Seas Conventions and the EU. A thorough analysis of presently available practices of UNEP/MAP, UNEP and IAEA, as well the HELCOM, OSPAR and European Commission Joint Research Centre was undertaken to assist an innovative approach for preparation of the IMAP Monitoring Guidelines/Protocols.

The Monitoring Guidelines/Protocols also address the problems identified during realization of the Proficiency testing being organized by UNEP/MAP-MEDPOL and IAEA for two decades now, given that many unsatisfactory results within inter-laboratory testing may be connected to inadequate laboratory practices of the IMAP/MEDPOL competent laboratories.

In order to support national efforts, this Monitoring Guidelines provides the three Technical Notes: a) Technical Note for the sampling of seafood for the analysis of heavy metals and organic contaminants that includes Protocol for the collection of fish, crustaceans, cephalopods and bivalves for heavy metal and organic contaminants analysis; b) Technical Note for the dissection of seafood for the analysis of heavy metals and organic contaminants that includes the following four Protocols: i) Protocol for dissection of fish to collect the edible part for analysis; ii). Protocol for dissection of bivalves to collect the edible part for analysis; iii) Protocol for dissection of crustaceans to collect the edible part for analysis; iv) Protocol for dissection of cephalopods to collect the edible part for analysis; c) Technical note for the sample preservation of seafood for the analysis of heavy metals and organic contaminants that includes the following two Protocols: i) Protocol for the treatment of seafood samples prior to heavy metal analysis; ii) Protocol for the treatment of biota samples prior to analysis for organic contaminants.

The Monitoring Guidelines/Protocols, including the one related to sampling and sample preservation of sea food for IMAP Common Indicator 20 establish a sound ground for further regular update of monitoring practice for the purpose of successful IMAP implementation.

In accordance with the Conclusions and Recommendations of the Integrated Meetings of the Ecosystem Approach Correspondence Groups on IMAP Implementation (CORMONs) (Videoconference, 1-3 Dec. 2020), and in particular paragraph 22, this Meeting requested the Secretariat to amend this Monitoring Guideline by addressing agreed technical proposals that were described in the Report of the Meeting in line with its agreement to proceed with submission of this document to the Meeting of MEDPOL Focal Points. Requested amendments included technical written suggestions that were provided by several Contracting Parties up to 10 days after the Integrated Meeting of CORMONs. The amended document was shared by the Secretariat on 19 February 2021 for a period of 2 weeks for the non-objection by the Integrated Meetings of CORMONs

on the introduced changes. Further to no objection from the Integrated Meeting of CORMONs, this Monitoring Guideline is submitted for consideration of present Meeting of MEDPOL Focal Points.

List of Abbreviations / Acronyms

CI	Common Indicator
COP	Conference of the Parties
CORMON	Correspondence Group on Monitoring
EcAp	Ecosystem Approach
EEA	European Environmental Agency
EC	European Commission
EU	European Union
FAO	Food and Agriculture Organization of the United Nation
HELCOM	Baltic Marine Environment Protection Commission - Helsinki Commission
IAEA	International Atomic Energy Agency
IOC	International Oceanographic Commission
IMAP	Integrated Monitoring and Assessment Programme of the Mediterranean Sea and Coast and Related Assessment Criteria
MAP	Mediterranean Action Plan
MED POL	Programme for the Assessment and Control of Marine Pollution in the Mediterranean Sea
MED QSR	Mediterranean Quality Status Report
OSPAR	Convention for the Protection of the Marine Environment for the North-East Atlantic
PoW	Programme of Work
QA/QC	Quality Assurance/Quality Control
QSR	Quality Status Report
US EPA	United States Environmental Protection Agency

1 Introduction

1. Monitoring seafood (fish, bivalves, cephalopods and crustaceans) for compliance with levels of contaminants set for public health protection is very different from monitoring marine organisms for environmental purposes. Ongoing seafood monitoring programmes for public health reasons generally focus on estimating consumer exposure rather than assessing environmental status.

Therefore, in the framework of UNEP/MAP Integrated Monitoring and Assessment Programme Common Indicator 20(CI20), as well as for the Descriptor 9 of the Marine Strategy Framework Directive (MSFD), sampling plans and procedures, selected tissues analysis and traceability to the location of catching or harvesting of seafood should be redesigned in order to provide required information (JRC, 2010¹).

2. Sampling of seafood includes collection of organisms from fishing vessels but also from fish landing harbors and fish markets. This is an important difference from CI17 and CI18 sampling, where sampling site's geographical coordinates are precisely known and recorded. The sampling location of seafood on land is not enough to trace the organism's provenance and it is therefore of paramount importance to also record the original location of the collection of the organisms at sea. The list of seafood to be collected for CI20 extends beyond the sentinel organisms used for CI17 and CI18 (*Mullus barbatus* and *Mytilus galloprovincialis* or *Donax trunculus*). Therefore, each Contracting Party to the Barcelona Convention needs to select the organisms to be sampled and analyzed, based on the commercial importance of species in each country. However, in order to attempt providing a comparison between CI20 and CIs 17 and 18, it is advisable to include the above mentioned sentinel species in the monitoring programme for CI20.

3. Sample preservation during transportation to the laboratory for further analysis follows the same procedures described in the relevant Protocols of CI17, with the addition of guidelines for the preservation during transport of cephalopods and crustaceans. In all procedures the important element is to ensure the integrity of the initial sample, avoiding decay and cross contamination during transport. Ice preservation is suggested for a transport of less than 24 hours, while refrigeration (-20 °C) is the method to follow in case of a transportation period more than 24 hours. Also, sample container's materials should be adequate in order to avoid cross contamination of the samples by metals or organic contaminants.

4. The aim of monitoring for CI20 is the protection of consumers' health, therefore during dissection, only edible tissues of seafood are to be selected for analysis (the flesh of fish, the whole body of bivalves, the mantle and tentacles of cephalopods and the tail meat without the cehalothorax of crustaceans). Dissection should be carried out by trained personnel in clean conditions and using appropriate tools in order to avoid cross contamination during the process.

5. The Protocols prepared in the framework of Monitoring Guidance for Sampling and Sample Preservation of Sea Food for IMAP Common Indicator 20, as provided here-below, describe appropriate methodologies for sampling, processing and storage of seafood samples under controlled conditions to ensure the representativeness and the integrity of the biota samples. They are not intended to be analytical training manuals, but guidelines for Mediterranean laboratories, which should be tested and modified in order to validate their final results.

6. These Protocols aim at streamlining sampling, dissecting and processing of marine organisms in view of assuring comparable quality assurance of the data, as well as comparability between sampling areas and different national monitoring programmes. They provide a step-by-step guidance on the methods to be applied in the Mediterranean area for sampling, sample handling to avoid cross-contamination, as well as the storage conditions in a view of maintaining the sample's integrity during the transfer from the sampling site to the analytical laboratory to ensure the representativeness and the integrity of the samples for analysis. Furthermore, protocols provide guidance on the procedures to dissect the organisms (fish, bivalves, crustaceans and cephalopods) in order to collect the appropriate

¹ JRC (2010). Marine Strategy Framework Directive. Technical Report of Task Group 9: Contaminants in fish and other seafood

tissue for analysis, taking care to avoid cross-contamination by metals or organic contaminants, depending on the foreseen analysis.

7. In order to avoid unnecessary repetitions, reference is also made to the protocols already published and publicly accessible, which can also be used by the Contracting Parties' competent laboratories participating in IMAP implementation. Namely, the here-below elaborated IMAP Protocols build upon previous UNEP/MAP - IAEA Recommended Methods, such as Reference Methods No 6 on sampling of selected marine organisms and sample preparation for trace metal analysis (UNEP/FAO/IOC/IAEA, (1987²), (Annex VI) and Reference Methods No 7 (Rev. 2) on sampling and dissecting marine organisms (UNEP/FAO/IOC/IAEA, (1988³) (Annex VII), which were prepared in the framework of the MED POL monitoring programme. They are also streamlined with similar Guidelines for marine biota sampling, sample processing and preservation, which were developed by other Regional Seas Organisations, as follows: HELCOM (2012, Annex VII: Technical note on biological material sampling and sample handling for the analysis of persistent organic pollutants and metallic trace elements); EC relevant Regulations on marine biota sampling and sample preparation for seafood analysis (Annex II: EU Commission Regulation (EC) No 1881/2006⁴; Annex III: EU Commission Regulation (EC) No 333/2007⁵; Annex IV: EU Commission Regulation (EC) No 836/2011 amending (EC) No 333/2007⁶ laying down the methods of sampling and analysis for the official control of the levels of lead, cadmium, mercury, inorganic tin, 3-MCPD and benzo(a)pyrene in foodstuffs; Annex V: EU Commission Regulation (EC) No 644/2017⁷). Given the suitability of any of these Guidelines in the context of IMAP, they could be further used by interested IMAP competent Mediterranean laboratories for developing their laboratory specific sampling and sample processing methodologies. The Contracting Parties' laboratories should accommodate and always test and modify each step of the procedures to validate their results.

8. The below flow diagram informs on the category of this Monitoring Guideline related to sampling and sample preservation of sea food for IMAP Common Indicator 20 within the structure of all Monitoring Guidelines prepared for IMAP Common Indicators 13, 14, 17, 18 and 20.

² UNEP/FAO/IOC/IAEA (1987). Reference methods No 6 (Rev. 1): Guidelines for monitoring chemical contaminants in marine organisms.

³ UNEP/FAO/IOC/IAEA (1988). Reference methods No 7 (Rev. 2): Sampling of selected marine organisms and sample preparation for trace metal analysis

⁴ EU Commission Regulation (EC) No 1881/2006, setting maximum levels for certain contaminants in seafood (Annex II)

⁵ EU Commission Regulation (EC) No 333/2007, laying down the methods of sampling and analysis for the official control of the levels of lead, cadmium, mercury, inorganic tin, 3-MCPD and benzo(a)pyrene in foodstuffs

⁶ EU Commission Regulation (EC) No 836/2011 amending (EC) No 333/2007 laying down the methods of sampling and analysis for the official control of the levels of lead, cadmium, mercury, inorganic tin, 3-MCPD and benzo(a)pyrene in foodstuffs

⁷ EU Commission Regulation (EC) No 644/2017, laying down methods of sampling and analysis for the official control of levels of dioxins and dioxin-like PCBs in certain foodstuffs

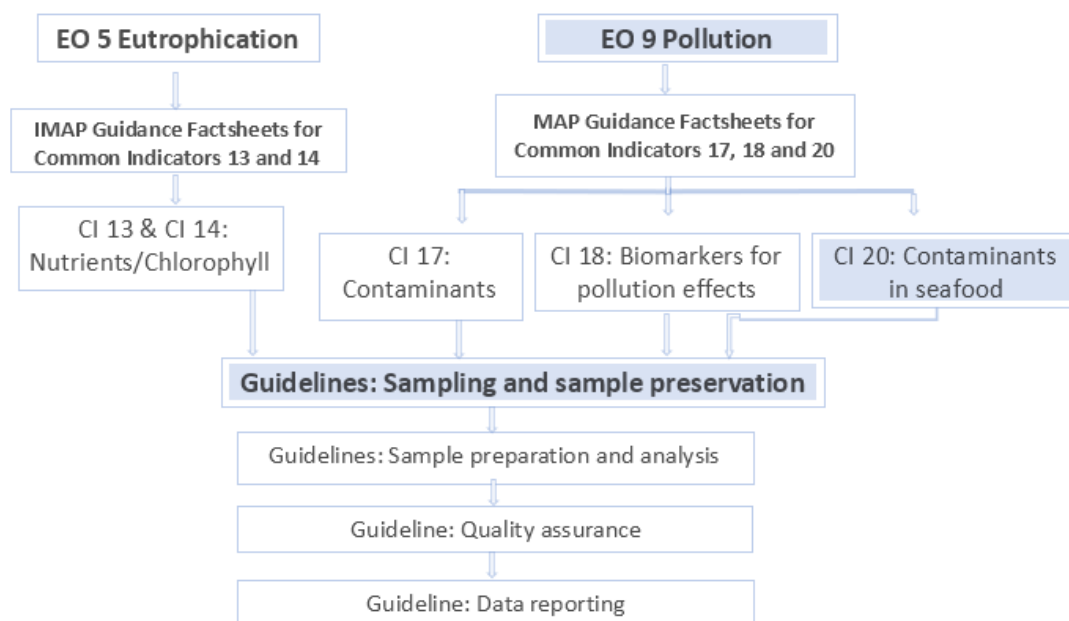

Flow Diagram: Monitoring Guidelines for IMAP Ecological Objectives 5 and 9

2 Technical note for the sampling of seafood for the analysis of heavy metals and organic contaminants

9. Monitoring seafood (fish, bivalves, cephalopods and crustaceans) for compliance with levels of contaminants set for public health protection is very different from monitoring of marine biota for assessing the quality of the marine environment. Also, ongoing seafood monitoring programmes for the purpose of public health protection generally focus on estimating consumer exposure rather than assessing environmental status. Therefore, in the framework of UNEP/MAP IMAP CI20, as well as for the Descriptor 9 of the MSFD, sampling plans and procedures, selected tissues analysis and traceability to the location of catching or harvesting of seafood should be redesigned in order to provide required information (JRC, 2010).

10. Under this Technical note on sampling of seafood for the analysis of heavy metals and organic contaminants, this Guidelines provides the Protocol for the collection of fish, crustaceans, cephalopods and bivalves for heavy metal and organic contaminants analysis.

2.1 Protocol for the collection of fish, crustaceans, cephalopods and bivalves for heavy metal and organic contaminants analysis

11. According to IMAP (UNEP, 2019a⁸, UNEP, 2019b⁹) it is proposed “to collect marine organisms mainly commercial species, and similarly to CI17 (where the whole soft tissues or dissected parts are processed to perform analytical measurements of chemical contaminants)”. It also underlined that “The sample collection for CI20 could be easily integrated with CI17 in terms of sample monitoring (e.g. from dedicated fishing vessels or from artisanal fleets at port). To be noticed, that in any case, the origin (i.e. area) of the fish captures should be exactly known, including detailed field information (e.g. coordinates)” (UNEP 2019b). Therefore, the FAO fishing area code (origFishAreaCode) should be noted and included in the Reporting Template for CI20.

12. The sample species for such analysis depends on the commercial marine organisms that are captured in the different Mediterranean areas (locations). Therefore, it is not relevant to propose a specific list of species but rather each Contracting Party will have to define its own list, which may be different from one sub-region to another. A tentative list of commercial species in the Mediterranean

⁸ UNEP/MAP (2019a). UNEP/MED WG.467/5. IMAP Guidance Factsheets: Update for Common Indicators 13, 14, 17, 18, 20 and 21: New proposal for candidate indicators 26 and 27.;

⁹ UNEP (2019b). UNEP/MED WG.463/6. Monitoring Protocols for IMAP Common Indicators related to pollution;

basin was prepared by JRC (2010) and is presented in Annex I¹⁰. Also, a list of available reference species (Code list) for Data Dictionaries and Data Standards related to E09 (CI17 and CI20) within the IMAP (Pilot) Info System is provided in UNEP/MED WG.467/8 (UNEP, 2019b¹¹). In order to make monitoring results more comparable between Mediterranean (sub) regions, the Contracting Parties could select a relatively limited number of common target species from the most consumed species of fish and other seafood in the Mediterranean basin, to be monitored during the initial implementation phase of the IMAP programme. It is therefore reasonable to include species that are sampled for biomarkers and general contaminants (such as *Mullus barbatus* and bivalves – *Mytilus galloprovincialis*) in biota analysis as additional information will exist.

13. Ongoing monitoring programmes aiming at the protection of human health, often rely on retail sampling, at the market. However, in order to use these results for the purpose of CI20 monitoring, the recording of the exact location of seafood harvesting is of paramount importance. JRC (2010) underlines that “Traceability in the food chain is focused on risk management: unless specific provisions for further traceability exist, the requirement for traceability is limited to ensuring that food business operators are at least able to identify the immediate supplier of the product in question and the immediate subsequent recipient, with the exemption of retailers to final consumers (“one step back – one step forward”).” The aim of traceability is to make sure that a direct link is established between the fresh seafood and the specific regions of its capture, in as much detail as possible.

14. Furthermore, since seafood samples for the protection of human health are often collected at the market, it must be ensured that measured contaminants concentrations in seafood are directly related to the existing environmental conditions at the capture location and that they are not cross-contaminated during treatment, transport and storage. A close cooperation between the samples’ providers at the market and the authorities responsible for sampling seafood should be established in order to minimize such cross-contamination.

15. For contaminants for which regulatory levels have been set provisions regarding sampling procedures are presented in Commission Regulations: (EC) No 1881/2006 related to setting maximum levels of contaminants in foodstuffs, (Annex II), which was amended by (EC) No 835/2011¹² in relation to PAHs maximum levels; (EC) No 333/2007 related to sampling and analysis for lead, cadmium, mercury, inorganic tin, 3-MCPD and benzo(a)pyrene in foodstuffs, (Annex III.), which was amended by (EC) No 386/2011¹³ in relation to PAHs methods for sampling and analysis (Annex IV); (EC) No 644/2017 related to sampling and analysis for dioxins and dioxin-like PCBs in foodstuffs; (Annex V). .. These Regulations, which include sampling plans, sample preparation and analysis may be used as a guidance for seafood sampling and analysis of relevance for UNEP/MAP IMAP mandatory list of contaminants (UNEP/MAP, 2019a), for which regulatory concentrations in seafood have been set by EC. From the list of EC regulated contaminants (EC) No 1881/2006 and (EC) 835/2011, Cd, Hg, Pb, PAHs (Benzo(a)Pyrene, benz(a)anthracene, benzo(b)fluoranthene and chrysene) and non dioxine-like PCBs are also designated as mandatory contaminants for CI20 monitoring (IMAP Guidance Fact Sheets, UNEP, 2019). Dioxins and dioxin-like PCBs, which are included in the list of EC regulated contaminants for seafood monitoring, are not yet included in the list of IMAP mandatory contaminants for CI20, however the Contracting Parties are encouraged to include all EU regulated contaminants in their monitoring programme for CI20, if possible.

16. The number of individual organisms to be samples depends on the weight of the “lot” and “sublot”. According to the definitions of the Commission Regulations (EC) No 333/2007:

¹⁰ Annex I: Indicative Tables of most consumed species of fish and seafood for different (sub) regions. JRC Technical Report 2010.

¹¹ UNEP (2019b) UNEP/MED WG.467/8. Data Standards and Data Dictionaries for Common Indicators related to pollution and marine litter.

¹² Commission Regulation (EU) No 835/2011 amending Regulation (EC) No 1881/2006 as regards maximum levels for polycyclic aromatic hydrocarbons in foodstuffs.

¹³ Commission Regulation (EU) No 386/2011 amending Regulation (EC) No 333/2006 laying down the methods of sampling and analysis for the official control of the levels of lead, cadmium, mercury, inorganic tin, 3-MCPD and benzo(a)pyrene in foodstuffs.

- i) "lot" is an identifiable quantity of food delivered at one time and determined by the official to have common characteristics, (such as origin, variety, and in the case of fish (or other biota), also a comparable size;
- ii) "sublot" is the designated part of a large lot in order to apply the sampling method on that designated part;
- iii) "incremental sample" is a quantity of material taken from a single place in the lot or sublot;
- iv) "aggregate sample" is the combined total of all the incremental samples taken from the lot or sublot; aggregate samples shall be considered as representative of the lots or sublots from which they are taken; sublot must be physically separated and identifiable.

17. Using these definitions, Regulations (EC) No 333/2007 and (EC) 836/2011 suggest the following sampling plans for individual marine organisms (fish, molluscs, cephalopods and crustaceans):

Table 1. Number of packages or units (incremental samples) which shall be taken to form the aggregate sample if the lot or sublot consists of individual packages or units

Number of packages or units in the lot/ sublot	Number of packages or units to be taken
≤ 25	at least 1 package or unit
26-100	about 5 %, at least 2 packages or units
> 100	about 5 %, at maximum 10 packages or units

18. The aggregate sample shall be at least 1 kg except where it is not possible e.g. when the sample consists of 1 package or unit."

19. In relation to packaging and transport of samples, Regulation (EC) No 333/2007 underlines that "each sample shall be placed in a clean, inert container offering adequate protection from contamination, from loss of analytes by adsorption to the internal wall of the container and against damage in transit. All necessary precautions shall be taken to avoid any change in composition of the sample which might arise during transportation or storage." Also, "Each sample taken for official use shall be sealed at the place of sampling and identified following the rules of the Member States. A record shall be kept of each sampling, permitting each lot or sublot to be identified unambiguously (reference to the lot number shall be given) and giving the date and place of sampling together with any additional information likely to be of assistance to the analyst."

20. During marine organisms sampling it is important to take into consideration (and record) all biological factors that can influence concentrations of contaminants in fish and other seafood, such as seasonal variation, age, sex. Since the aim of the monitoring is the protection of human health, only the edible portion of the organisms will be analyzed.

21. Seafood samples should be protected from contamination, which may occur during sampling, sample handling, storage and transfer to the laboratory for further analysis. Seafood samples have to be handled with care to avoid any contact with metals (for heavy metal analysis) or possible sources of organic contaminants (for chlorinated hydrocarbons and PAHs analysis). When seafood transport to the laboratory is done in less than 24 hours, samples can be stored on ice. In case of a transfer longer than 24 hours, samples have to be frozen in -20 °C and transported frozen to the laboratory for further processing and analysis. Each sample should be labelled with the sample's identification number, the type of tissue, and the date and location of sampling.

22. Guidelines for marine organism collection, preservation and transportation to the laboratory are developed by UNEP/FAO/IOC/IAEA (1987) (Annex VI), UNEP/FAO/IOC/IAEA (1988) (Annex VII), HELCOM (2012) (Annex VIII) and US EPA (2000¹⁴) (Annex IX).

3 Technical Note for the dissection of seafood for the analysis of heavy metals and organic contaminants

23. To collect the edible tissues of seafood for subsequent analysis, the organisms have to be dissected, taking care to avoid any contamination from the dissecting tools and the working environment. Also, dissection has to be undertaken by trained personnel to ensure the removal of the representative undamaged tissues.

24. For metal analysis, the dissection of marine organisms should be made on a metal-free bench, using plastic knives and tweezers for holding tissues during dissection. After each sample has been prepared, all tools and equipment (such as homogenizers) should be cleaned with a tissue and rinsed with clean water.

25. For organic contaminants analysis, the dissection of marine organisms should be made on a metallic (stainless steel or aluminum) bench, using stainless steel knives and tweezers for holding tissues during dissection. After each sample has been prepared, all tools and equipment (such as homogenizers) should be cleaned with tissue and rinsed with solvent

26. After the removal of a tissue sample from the organism, the tools have to be cleaned before being used to remove another organ of the same individual or being used on a different individual

27. For analysis of heavy metals, tools should be:

- i) Washed in acetone or alcohol and high purity water.
- ii) Washed in HNO₃ diluted (1+1) with high purity water. Tweezers and haemostates in are washed in diluted (1+6) acid.
- iii) Rinsed with high purity water.

28. For analysis of organic contaminants, tools should be:

- i) Washed in acetone or alcohol and rinsed in high purity water.

29. The glass/metal/plastic plate used during dissection should be cleaned in the same manner. The tools must be stored dust-free when not in use. Also, the dissection room should be kept clean and the air should be free from particles. If clean benches are not available on board the ship, the dissection of fish should be carried out in the land-based laboratory under conditions of maximum protection against contamination (HELCOM, 2012).

30. Under this Technical note on sampling of seafood for the analysis of heavy metals and organic contaminants, this Guidelines provides the following four Protocols:

- Protocol for dissection of fish to collect the edible part for analysis;
- Protocol for dissection of bivalves to collect the edible part for analysis;
- Protocol for dissection of crustaceans to collect the edible part for analysis;
- Protocol for dissection of cephalopods to collect the edible part for analysis.

3.1 Protocol for dissection of fish to collect the edible part for analysis

Recording biological factors of fish

¹⁴ US EPA (2000). Guidance for Assessing Chemical Contaminant Data for Use in Fish Advisories Volume 1 Fish Sampling and Analysis. Third Edition (Annex VIII)

31. Guidelines for recording length, weight and sex of fish are presented in UNEP/FAO/IOC/IAEA (1987) (Annex VI), UNEP/FAO/IOC/IAEA (1988) (Annex VII), and US EPA (2000) (Annex IX).

Dissection of fish

32. Muscle tissues of fish have to be dissected while they are in good condition, otherwise the decay of the tissues will affect the concentration of contaminants. Therefore, it is preferable to dissect collected fish the soonest possible, by experienced personnel able to perform the dissection and remove the muscle tissue to be analyzed. Dissection should be done in a clean area free from possible contamination of the sample by metals (for heavy metal analysis) or organic contaminants (for PCBs and PAHs analysis).

33. According to IMAP requirements, UNEP (2019), the fish tissue to be collected is muscle. Detailed guidelines for the dissection of fish and collection of samples for further analysis is presented in UNEP/FAO/IOC/IAEA (1987) (Annex VI), UNEP/FAO/IOC/IAEA (1988) (Annex VII.), HELCOM (2012) (Annex VIII) and US EPA (2000) (Annex IX).

34. In all procedures, the method requires the removal of the epidermis and the collection of a sample from the dorso-lateral muscle in order to ensure uniformity of samples (Figure 1). It is also suggested to take the entire right dorsal lateral filet as a uniform sample, from which subsamples can be taken after homogenizing for replicate dry weight and contaminant determinations. If the amount of material obtained by this procedure is too large to be easily handled, a specific portion of the dorsal musculature should be chosen for the sample. It is recommended that the portion of the muscle lying directly under the first dorsal fin should be utilized in this case. It is important to obtain the same portion of the muscle tissue for each sample, because both fat and water content vary significantly in the muscle tissue from the anterior to the caudal muscle of the fish (HELCOM, 2012).

35. In case fish samples are frozen for their transfer from the field to the laboratory, they have to rest until thawed. It is often suggested that the dissection of fish is easiest when the material, at least the surface layers of the muscle tissue, is half frozen. However, for the dissection of other organs, the thawing must proceed further. Extreme care has to be demonstrated during dissection because any loss of liquid or fat due to improper cutting or handling of the tissue makes the determinations of dry weight and fat content less accurate, which is also affecting the accuracy of the reported contaminants' concentrations.

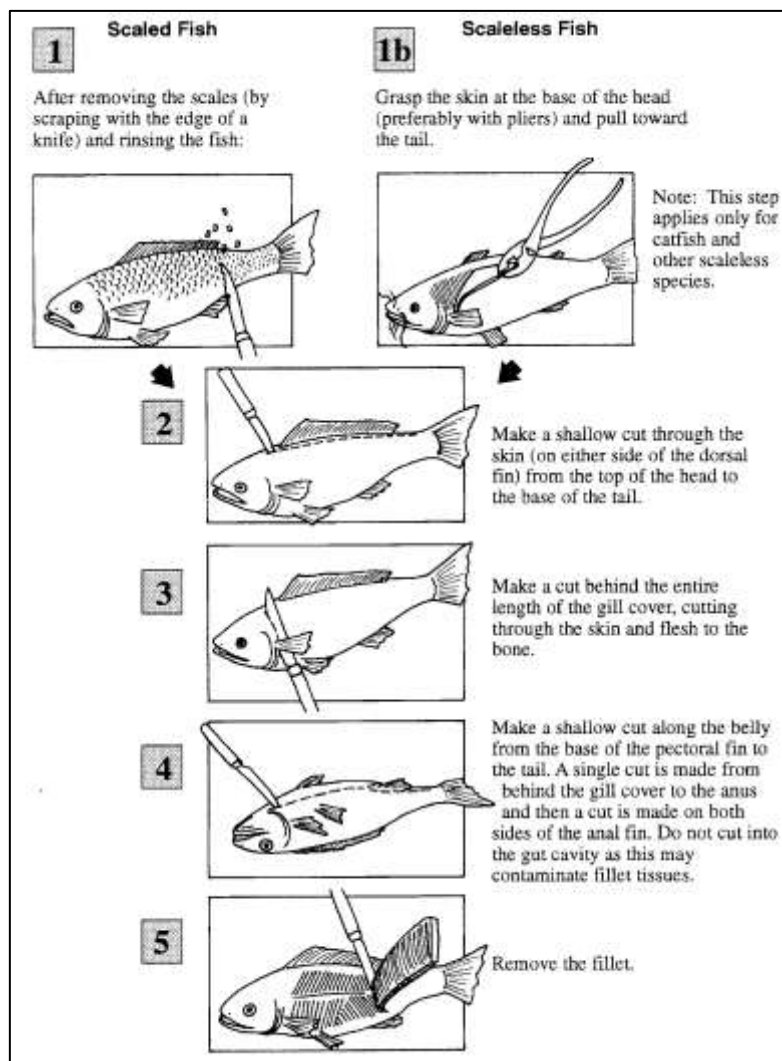

Figure 1. Fish filleting procedure (from US EPA, 2000)

3.2 Protocol for dissection of bivalves to collect the edible part for analysis (whole body)

Depuration

36. Collected bivalves that are alive should be left to void the gut contents and any associated contaminants before dissecting and sample preparation, because gut contents may contain significant quantities of contaminants associated with food and sediment particles which are not truly assimilated into the tissues of the mussels (HELCOM, 2012). Bivalve's depuration over a period of 24 hours is usually sufficient and should be undertaken under controlled conditions and in filtered sea water in the laboratory. The aquarium should be aerated and the temperature and salinity of the water should be similar to that from which the animals were removed.

Recording biological factors of bivalves

37. Guidelines for recording length and weight of bivalves are presented in UNEP/FAO/IOC/IAEA (1987) (Annex VI), UNEP/FAO/IOC/IAEA (1988) (Annex VII), and US EPA (2000) (Annex IX).

Bivalves' dissection

38. The whole soft tissue of bivalves is edible therefore, it has to be collected for analysis. Detailed guidelines for the dissection of bivalves and collection of samples for further analysis is presented in UNEP/FAO/IOC/IAEA (1987) (Annex VI), UNEP/FAO/IOC/IAEA (1988) (Annex VII), HELCOM (2012) (Annex VIII) and US EPA (2000) (Annex IX).

39. In general, foreign materials attached to the outer surface of the shell have to be removed using a clean plastic/stainless steel knife with a strong plastic/metal brush. Handle the mussels as little as possible. For removing the soft tissue for analysis, bivalves should be shucked live and opened with minimal tissue damage by detaching the adductor muscles from the interior of at least one valve (Figure 2). The soft tissues should be removed and homogenized as soon as possible, frozen and kept in plastic containers (for metal analysis) or in metal containers (for organic contaminants' analysis) at -20°C until analysis. Homogenization can be done using stainless steel blades (for organic contaminants analysis) or using an agate mortar, following the drying of the sample.

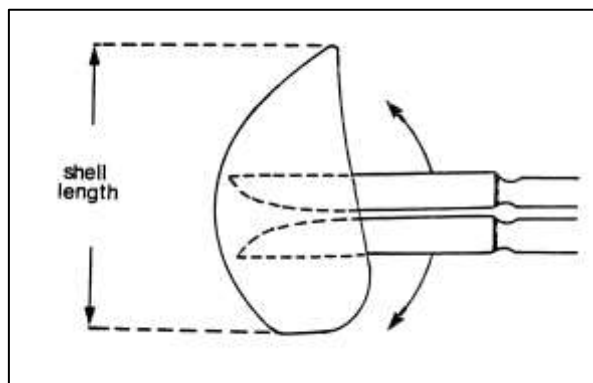

Figure 2. Cutting the abductor muscle

3.3 Protocol for dissection of crustaceans to collect the edible part for analysis

Recording biological factors of crustaceans

40. Guidelines for recording length, weight and sex of crustaceans are presented in UNEP/FAO/IOC/IAEA (1987) (Annex VI), UNEP/FAO/IOC/IAEA (1988) (Annex VII), and US EPA (2000) (Annex IX).

41. The length of the shrimp is measured from rostrum to uropod (Figure 3) using an appropriate length-measuring device. Weigh the shrimp after placing a clean weighing container (plastic or aluminum foil depending on the analysis to be made) on the balance and note its length and fresh weight.

Crustaceans' dissection

42. To collect the edible part of shrimps and crayfish the cephalothorax is removed and the tail meat with the section of intestine passing through the tail muscle is retained for analysis (Figure 3). The vein is then removed using a sharp knife. The edible tissue of lobsters typically includes the tail and claw meat. Guidelines for dissection of crustaceans are prepared by UNEP/FAO/IOC/IAEA (1987) (Annex VI), UNEP/FAO/IOC/IAEA (1988) (Annex VII), and US EPA (2000) (Annex IX).

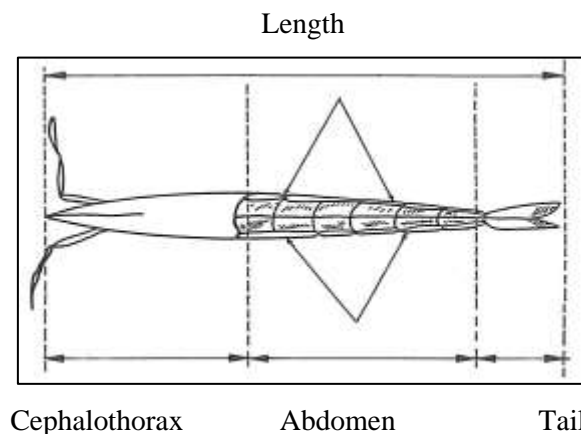

Figure 3. Shrimp

3.4 Protocol for dissection of cephalopods to collect the edible part for analysis (mantle and head)

Recording biological factors of cephalopods

43. For octopus and squid, total length is measured from end of longest arm to posterior end of mantle. Mantle length is measured from midpoint between eyes to the posterior end of mantle.

Dissection of cephalopods

44. The digestive gland and the internal organs (gills, ink sack, branchial hearts and their appendages, systemic heart and brain) of each cephalopod are totally removed using appropriate tools to avoid contamination. The edible parts of the cephalopod (mantle, head with tentacles) (Figure 4) are stored in clean containers for further analysis (Bustamante et al, 1998¹⁵).

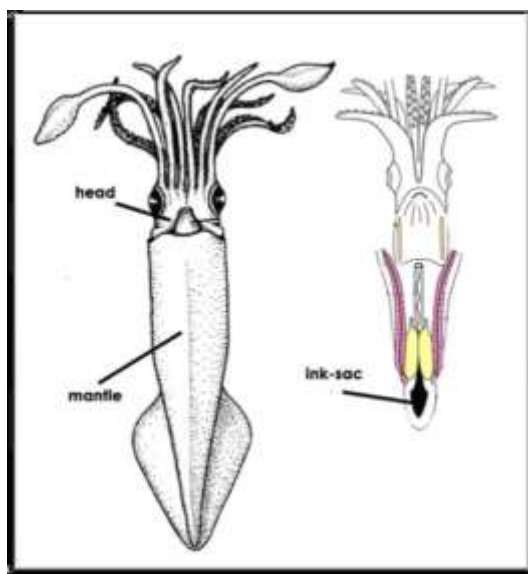

Figure 4. Squid

4 Technical note for the sample preservation of seafood for the analysis of heavy metals and organic contaminants

45. Under this Technical note on processing and preservation of marine biota for the analysis of heavy metals and organic contaminants, this Guidelines provides the following two Protocols:

- Protocol for the treatment of seafood samples prior to heavy metal analysis;
- Protocol for the treatment of biota samples prior to analysis for organic contaminants.

46. The Protocols under this Technical Note are similar to the relevant Protocols related to sampling and sample preservation of marine biota samples presented in the framework of CI17 Guideline for biota sampling and samples preservation, for the analysis of heavy metals and organic contaminants.

4.1 Protocol for the treatment of seafood samples prior to heavy metal analysis

47. For contaminants for which regulatory levels have been set, certain provisions regarding sampling procedures and sample preservation are presented in Commission Regulations (EC) No 333/2007 of the European Union (Annex III.). These methods could be used when determining levels of contaminants in fish and seafood for human consumption in view of monitoring Good Environmental Status of the marine environment. Guidelines for treatment of marine biota samples prior to analysis are proposed by UNEP/FAO/IOC/IAEA (1987) (Annex VI), UNEP/FAO/IOC/IAEA (1988) (Annex VII) and HELCOM (2012) (Annex VIII).

¹⁵ Bustamante P, Caurant F, Fowler SW, Miramand P. Cephalopods as a vector for the transfer of cadmium to top marine predators in the north-east Atlantic Ocean. *Sci. Total Environ.* 1998; 220: 71–80.

a) Storage of wet samples on board/market

48. Upon collection wet samples have to be stored in such a way as to preserve them from deterioration that will affect the subsequent analysis of contaminants. When the fish transport to the laboratory is done in less 24 hours, samples can be stored on ice. However, for longer periods, fish samples have to be frozen (-20 °C) and transported frozen to the laboratory for further processing. Each sample should be labelled with the sample's identification number, the type of tissue, and the date and location of sampling.

b) Drying of biota tissues

49. Drying biota tissues is a procedure to establish the wet/dry ratio of the tissues, in order to express metal concentrations accordingly enabling comparisons between different data sets. Dried biota tissues can then be digested for heavy metal analysis, although biota tissues can also be digested wet, without prior drying (HELCOM, 2012).

50. For metal (except volatile mercury) analysis, sediments freeze-drying is the preferable procedure. Alternatively, the biota tissues may be dried at any temperature below 105°C until constant weight. For mercury analysis, to minimise losses due to evaporation, a sediment sub sample could be air dried at temperature <50°C (EC, 2010). Frozen biota samples are placed in clean wide-mouth glass or plastic containers suitable for freeze-drying and are freeze-dried for 24 hours taking care to protect them from cross-contamination from particles and vapours. A possible way to protect samples from contamination is to cover the sample containers with a filter paper perforated with a small hole (HELCOM, 2012). Then the containers with the samples are weighted and freeze-dried again for another 24 hours and weighted. If the difference between the 2 weighing is less than 0.5%, drying is completed and the dw/ww ratio can be calculated. Otherwise the drying cycle can be repeated (24 hours) until the difference between successive weighing is less than 0.5%.

51. Freeze dried biota tissues are then grinded and homogenized using a metal-free ball mill. Guidelines for processing biota samples for metal analysis are provided by ICES/OSPAR (2018¹⁶) and HELCOM (2012) (Annex VII).

c) Storage of dried biota tissues

52. Freeze-dried tissue samples can be stored in pre-cleaned wide-mouth bottles with a screw cap. Samples intended for the analysis of metals can be stored in plastic or glass containers. For mercury analysis, samples must be stored in acid-washed borosilicate glass or quartz containers, as mercury can move through the walls of plastic containers (EC, 2010¹⁷).

53. Containers with biota tissue samples should be archived and kept in storage after the completion of the analysis, in order to be used as a replicate sample in case crosschecking of the results is required or additional determinations are needed in the future. Freeze-dried biota tissues remaining after analyses could be stored in the original sample bottle, closed with an airtight lid to protect against moisture and stored in a cool, dark place. Under these conditions, samples may be archived and stored for 10-15 years. (EC, 2010).

4.2 Protocol for the treatment of seafood samples prior to analysis for organic contaminants

54. For organic contaminants for which regulatory levels have been set, certain provisions regarding sampling procedures and sample preservation are presented in Commission Regulations (EC) No 333/2007 (PAHs) and (EC) No 644/2017 (PCBs and dioxins) of the European Union. (Annexes III. and IV.). These methods could be used when determining levels of contaminants in fish and seafood for human consumption in view of monitoring Good Environmental Status of the marine environment. Guidelines for treatment of marine biota samples prior to analysis are proposed by

¹⁶ ICES/OSPAR (2018). CEMP Guidelines for Monitoring Contaminants in Biota. Technical Annexes: 1) organic contaminants; 2) metals; 3) parent and alkylated PAHs; 8) chlorobiphenyls

¹⁷ EC (2010). Guidance Document No: 25 Guidance on chemical monitoring of sediment and biota under the Water Framework Directive

UNEP/FAO/IOC/IAEA (1987) (Annex VI), UNEP/FAO/IOC/IAEA (1988) (Annex VII.) and HELCOM (2012) (Annex VIII)

a) Storage of wet samples on board/market

55. Upon collection wet samples have to be stored in such a way as to preserve them from deterioration that will affect the subsequent analysis of contaminants. When the fish transport to the laboratory is done in less 24 hours, samples can be stored on ice. However, for longer periods, fish samples have to be frozen (-20 °C) and transported frozen to the laboratory for further processing. Each sample should be labelled with the sample's identification number, the type of tissue, and the date and location of sampling.

b) Drying of biota tissues

56. For organic contaminants analysis drying procedures depends on the compounds to be analysed. For chlorinated hydrocarbons sediments can be freeze-dried taking care to avoid determinant loss through evaporation by keeping the temperature in the evaporation chamber below 0°C (ICES/OSPAR, 2018). For PAH determination, freeze-drying sediment samples may be a source of contamination due to the back-streaming of oil vapours from the rotary vacuum pumps. Furthermore, drying the samples may result in losses of the lower molecular weight, more volatile PAHs through evaporation. To protect biota samples from cross-contamination from particles and vapours during freeze drying, the sample containers could be covered with a lid or filter paper perforated with a small hole (HELCOM, 2012).

57.. c) Storage of dried biota tissues

58. Freeze-dried tissue samples can be stored in pre-cleaned wide-mouth bottles with a screw cap. Samples intended for the analysis of organic contaminants should be stored in glass containers.

59. Containers with biota tissue samples should be archived and kept in storage after the completion of the analysis, in order to be used as a replicate sample in case crosschecking of the results are required or additional determinations are needed in the future. Freeze-dried biota tissues remaining after analyses could be stored in the original sample bottle, closed with an airtight lid to protect against moisture and stored in a cool, dark place. Under these conditions, samples may be archived and stored for 10-15 years (EC, 2010).

Annex I:

Joint Research Centre Scientific and Technical Reports

MARINE STRATEGY FRAMEWORK DIRECTIVE

Task Group 9 Contaminants in fish and other seafood

APRIL 2010

**ANNEX II: INDICATIVE TABLES OF MOST CONSUMED SPECIES OF FISH AND
SEAFOOD
FOR THE DIFFERENT (SUB) REGIONS**

Joint Research Centre Scientific and Technical Reports

MARINE STRATEGY FRAMEWORK DIRECTIVE

Task Group 9 Contaminants in fish and other seafood

APRIL 2010

ANNEX II: INDICATIVE TABLES OF MOST CONSUMED SPECIES OF FISH AND SEAFOOD

FOR THE DIFFERENT (SUB) REGIONS

3. Region: Mediterranean Sea

3.1. Subregion: Western Mediterranean Sea

Common name	Scientific name	Importance
Sardine	<i>Sardina pilchardus</i>	+++
Horse Mackerel	<i>Trachurus trachurus</i>	+++
Hake	<i>Merluccius merluccius</i>	+++
Anchovy	<i>Engraulis encrasicolus</i>	+++
Blue Whiting	<i>Micromesistius poutassou</i>	++
Gilt sardine, Spanish sardine	<i>Sardinella aurita</i>	++
Mediterranean horse mackerel	<i>Trachurus mediterraneus</i>	++
Bullet tuna	<i>Auxis rochei</i>	++
Atlantic mackerel	<i>Scomber scombrus</i>	++
Swordfish	<i>Xiphias gladius</i>	++
Octopus	<i>Octopus vulgaris</i>	++
Mackerels	<i>Scomber spp</i>	++
Red shrimp	<i>Aristeus antennatus</i>	++
Atlantic blue fin tuna	<i>Thunnus thynnus</i>	++
Angler	<i>Lophius piscatorius</i>	++
Red mullet	<i>Mullus barbatus</i>	++
Mackerel	<i>Trachurus spp</i>	++
Gilthead sea bream	<i>Sparus aurata</i>	++
Menhaden	<i>Brevoortia pectinata</i>	+
Cuttlefish	<i>Sepia officinalis</i>	+
Atlantic saury	<i>Scorpaenopsis scorpaena</i>	+
Common Pandora	<i>Pagellus erythrinus</i>	+
Blackspot sea bream	<i>Pagellus bogaraveo</i>	+

Other seafood

Common name	Scientific name	Importance
Spot tail mantis shrimp	<i>Squilla mantis</i>	++
Mediterranean mussel	<i>Mytilus galloprovincialis</i>	++
Norway lobster	<i>Nephrops norvegicus</i>	+

3.2. Subregion: Adriatic Sea**Fish**

Common name	Scientific name	Importance
European anchovy	<i>Engraulis encrasicolus</i>	+++
Hake	<i>Merluccius merluccius</i>	+++
European Squid	<i>Loligo vulgaris</i>	+++
Atlantic bonito	<i>Sarda sarda</i>	++
Horse mackerel	<i>Trachurus trachurus</i>	++
Red striped mullet	<i>Mullus surmuletus</i>	++
Atlantic mackerel	<i>Scomber scombrus</i>	++

Other seafood

Common name	Scientific name	Importance
Mediterranean mussel	<i>Mytilus galloprovincialis</i>	+++
Clams	<i>Ruditapes decussates/ philippinarum</i>	+++
Norway lobster	<i>Nephrops norvegicus</i>	++

3.3. Subregion: Ionian Sea and Central Mediterranean Sea**Fish**

Common name	Scientific name	Importance
European anchovy	<i>Engraulis encrasicolus</i>	+++
Hake	<i>Merluccius merluccius</i>	+++
Atlantic blue fin tuna	<i>Thunnus thynnus</i>	+++
Atlantic bonito	<i>Sarda sarda</i>	++
Red striped mullet	<i>Mullus surmuletus</i>	++
Swordfish	<i>Xiphias gladius</i>	++
Bullet tuna	<i>Auxis rokei</i>	++
Sardine	<i>Sardina pilchardus</i>	+
Atlantic mackerel	<i>Scomber scombrus</i>	+
Horse mackerel	<i>Trachurus trachurus</i>	+

Other seafood

Common name	Scientific name	Importance
Deep-water rose shrimp	<i>Parapenaeus longirostris</i>	++
Norway lobster	<i>Nephrops norvegicus</i>	+

3.5. Subregion: Aegean-Levantine Sea

Fish

Common name	Scientific name	Importance
European anchovy	<i>Engraulis encrasicolus</i>	
Sardine	<i>Sardina pilchardus</i>	
Gilt sardine, Spanish sardine	<i>Sardinella spp</i>	
Cuttlefish	<i>Sepia officinalis</i>	
Bogue	<i>Boops boops</i>	
Octopus	<i>Octopus vulgaris</i>	
Chub mackerel	<i>Scomber japonicus</i>	
Mediterranean horse mackerel	<i>Trachurus mediterraneus</i>	
Hake	<i>Merluccius merluccius</i>	
Shad	<i>Alosa spp</i>	
Blue Whiting	<i>Micromesistius poutassou</i>	
Picarels	<i>Spicara spp</i>	
Goatfishes	<i>Mullus spp.</i>	
Horse mackerel	<i>Trachurus trachurus</i>	
Flathead Mullet (Striped Mullet)	<i>Mugil cephalus</i>	
Common sea bream	<i>Pagrus pagrus</i>	
Meagre, shade-fish, salmon bass or Stone Bass	<i>Argyrosomus regius</i>	
Gilthead sea bream	<i>Sparus aurata</i>	
Barracuda	<i>Sphyraena spp</i>	
European sea bass	<i>Dicentrarchus labrax</i>	
Grouper	<i>Epinephelus spp</i>	

Other seafood

Common name	Scientific name	Importance
Mediterranean mussel	<i>Mytilus galloprovincialis</i>	
Caramote prawn	<i>Penaeus kerathurus</i>	

Annex II:

Official Journal of the European Union

**COMMISSION REGULATION (EC) No 1881/2006
of 19 December 2006
setting maximum levels for certain contaminants in foodstuffs**

COMMISSION REGULATION (EC) No 1881/2006
of 19 December 2006
setting maximum levels for certain contaminants in foodstuffs
 (Text with EEA relevance)

THE COMMISSION OF THE EUROPEAN COMMUNITIES,

Having regard to the Treaty establishing the European Community,

Having regard to Council Regulation (EEC) No 315/93 of 8 February 1993 laying down Community procedures for contaminants in food ⁽¹⁾, and in particular Article 2(3) thereof,

Whereas:

- (1) Commission Regulation (EC) No 466/2001 of 8 March 2001 setting maximum levels for certain contaminants in foodstuffs ⁽²⁾ has been amended substantially many times. It is necessary to amend again maximum levels for certain contaminants to take into account new information and developments in Codex Alimentarius. At the same time, the text should, where appropriate, be clarified. Regulation (EC) No 466/2001 should therefore be replaced.
- (2) It is essential, in order to protect public health, to keep contaminants at levels which are toxicologically acceptable.
- (3) In view of disparities between the laws of Member States and the consequent risk of distortion of competition, for some contaminants Community measures are necessary in order to ensure market unity while abiding by the principle of proportionality.
- (4) Maximum levels should be set at a strict level which is reasonably achievable by following good agricultural, fishery and manufacturing practices and taking into account the risk related to the consumption of the

food. In the case of contaminants which are considered to be genotoxic carcinogens or in cases where current exposure of the population or of vulnerable groups in the population is close to or exceeds the tolerable intake, maximum levels should be set at a level which is as low as reasonably achievable (ALARA). Such approaches ensure that food business operators apply measures to prevent and reduce the contamination as far as possible in order to protect public health. It is furthermore appropriate for the health protection of infants and young children, a vulnerable group, to establish the lowest maximum levels, which are achievable through a strict selection of the raw materials used for the manufacturing of foods for infants and young children. This strict selection of the raw materials is also appropriate for the production of some specific foodstuffs such as bran for direct human consumption.

- (5) To allow maximum levels to be applied to dried, diluted, processed and compound foodstuffs, where no specific Community maximum levels have been established, food business operators should provide the specific concentration and dilution factors accompanied by the appropriate experimental data justifying the factor proposed.
- (6) To ensure an efficient protection of public health, products containing contaminants exceeding the maximum levels should not be placed on the market either as such, after mixture with other foodstuffs or used as an ingredient in other foods.
- (7) It is recognised that sorting or other physical treatments make it possible to reduce the aflatoxin content of consignments of groundnuts, nuts, dried fruit and maize. In order to minimise the effects on trade, it is appropriate to allow higher aflatoxin contents for those products which are not intended for direct human consumption or as an ingredient in foodstuffs. In these cases, the maximum levels for aflatoxins should be fixed taking into consideration the effectiveness of the above-mentioned treatments to reduce the aflatoxin content in groundnuts, nuts, dried fruit and maize to levels below the maximum limits fixed for those products intended for direct human consumption or use as an ingredient in foodstuffs.
- (8) To enable effective enforcement of the maximum levels for certain contaminants in certain foodstuffs, it is appropriate to provide for suitable labelling provisions for these cases.

⁽¹⁾ OJ L 37, 13.2.1993, p. 1. Regulation as amended by Regulation (EC) No 1882/2003 of the European Parliament and of the Council (OJ L 284, 31.10.2003, p. 1).

⁽²⁾ OJ L 77, 16.3.2001, p. 1. Regulation as last amended by Regulation (EC) No 199/2006 (OJ L 32, 4.2.2006, p. 32).

- (9) Because of the climatic conditions in some Member States, it is difficult to ensure that the maximum levels are not exceeded for fresh lettuce and fresh spinach. These Member States should be allowed for a temporary period to continue to authorise the marketing of fresh lettuce and fresh spinach grown and intended for consumption in their territory with nitrate contents exceeding the maximum levels. Lettuce and spinach producers established in the Member States which have given the aforementioned authorisations should progressively modify their farming methods by applying the good agricultural practices recommended at national level.
- (10) Certain fish species originating from the Baltic region may contain high levels of dioxins and dioxin-like PCBs. A significant proportion of these fish species from the Baltic region will not comply with the maximum levels and would therefore be excluded from the diet. There are indications that the exclusion of fish from the diet may have a negative health impact in the Baltic region.
- (11) Sweden and Finland have a system in place which has the capacity to ensure that consumers are fully informed of the dietary recommendations concerning restrictions on consumption of fish from the Baltic region by identified vulnerable groups of the population in order to avoid potential health risks. Therefore, it is appropriate to grant a derogation to Finland and Sweden to place on the market for a temporary period certain fish species originating in the Baltic region and intended for consumption in their territory with levels of dioxins and dioxin-like PCBs higher than those set in this Regulation. The necessary measures must be implemented to ensure that fish and fish products not complying with the maximum levels are not marketed in other Member States. Finland and Sweden report every year to the Commission the results of their monitoring of the levels of dioxins and dioxin-like PCBs in fish from the Baltic region and the measures to reduce human exposure to dioxins and dioxin-like PCBs from the Baltic region.
- (12) To ensure that the maximum levels are enforced in a uniform way, the same sampling criteria and the same analysis performance criteria should be applied by the competent authorities throughout the Community. It is furthermore important that analytical results are reported and interpreted in a uniform way. The measures as regards sampling and analysis specified in this Regulation provide for uniform rules on reporting and interpretation.
- (13) For certain contaminants, Member States and interested parties should monitor and report levels, as well report on the progress with regard to application of preventative measures, to allow the Commission to assess the need to modify existing measures or to adopt additional measures.
- (14) Any maximum level adopted at Community level can be subject to a review to take account of the advance of scientific and technical knowledge and improvements in good agricultural, fishery and manufacturing practices.
- (15) Bran and germ can be marketed for direct human consumption and it is therefore appropriate to establish a maximum level for deoxynivalenol and zearalenone in these commodities.
- (16) Codex Alimentarius has recently set a maximum level for lead in fish which the Community accepted. It is therefore appropriate to modify the current provision for lead in fish accordingly.
- (17) Regulation (EC) No 853/2004 of the European Parliament and Council of 29 April 2004 laying down specific hygiene rules for food of animal origin ⁽³⁾ defines foodstuffs of animal origin, and consequently the entries as regards foodstuffs of animal origin should be amended in some cases according to the terminology used in that Regulation.
- (18) It is necessary to provide that the maximum levels for contaminants do not apply to the foodstuffs which have been lawfully placed on the Community market before the date of application of these maximum levels.
- (19) As regards nitrate, vegetables are the major source for the human intake of nitrate. The Scientific Committee on Food (SCF) stated in its opinion of 22 September 1995 ⁽⁴⁾ that the total intake of nitrate is normally well below the acceptable daily intake (ADI) of 3,65 mg/kg body weight (bw). It recommended, however, continuation of efforts to reduce exposure to nitrate via food and water.
- (20) Since climatic conditions have a major influence on the levels of nitrate in certain vegetables such as lettuce and spinach, different maximum nitrate levels should therefore be fixed depending on the season.
- (13) For certain contaminants, Member States and interested parties should monitor and report levels, as well report on the progress with regard to application of pre-

⁽³⁾ OJ L 139, 30.4.2004, p. 55, as corrected by OJ L 226, 25.6.2004, p. 22. Regulation as last amended by Regulation (EC) No 1662/2006 (OJ L 320, 18.11.2006, p. 1).

⁽⁴⁾ Reports of the Scientific Committee for Food, 38th series, Opinion of the Scientific Committee for Food on nitrates and nitrite, p. 1, http://ec.europa.eu/food/fs/sc/scf/reports/scf_reports_38.pdf

- (21) As regards aflatoxins, the SCF expressed in its opinion of 23 September 1994 that aflatoxins are genotoxic carcinogens⁽⁵⁾. Based on that opinion, it is appropriate to limit the total aflatoxin content of food (sum of aflatoxins B₁, B₂, G₁ and G₂) as well as the aflatoxin B₁ content alone, aflatoxin B₁ being by far the most toxic compound. For aflatoxin M₁ in foods for infants and young children, a possible reduction of the current maximum level should be considered in the light of developments in analytical procedures.
- (22) As regards ochratoxin A (OTA), the SCF adopted a scientific opinion on 17 September 1998⁽⁶⁾. An assessment of the dietary intake of OTA by the population of the Community has been performed⁽⁷⁾ in the framework of Council Directive 93/5/EEC of 25 February 1993 on assistance to the Commission and cooperation by the Member States in the scientific examination of questions relating to food⁽⁸⁾ (SCOOP). The European Food Safety Authority (EFSA) has, on a request from the Commission, adopted an updated scientific opinion relating to ochratoxin A in food on 4 April 2006⁽⁹⁾, taking into account new scientific information and derived a tolerable weekly intake (TWI) of 120 ng/kg bw.
- (23) Based on these opinions, it is appropriate to set maximum levels for cereals, cereal products, dried vine fruit, roasted coffee, wine, grape juice and foods for infants and young children, all of which contribute significantly to general human exposure to OTA or to the exposure of vulnerable groups of consumers such as children.
- (24) The appropriateness of setting a maximum level for OTA in foodstuffs such as dried fruit other than dried vine fruit, cocoa and cocoa products, spices, meat products, green coffee, beer and liquorice, as well as a review of the existing maximum levels, in particular for OTA in dried vine fruit and grape juice, will be considered in the light of the recent EFSA scientific opinion.
- (25) As regards patulin, the SCF endorsed in its meeting on 8 March 2000 the provisional maximum tolerable daily intake (PMTDI) of 0,4 µg/kg bw for patulin⁽¹⁰⁾.
- (26) In 2001, a SCOOP-task 'Assessment of the dietary intake of patulin by the population of EU Member States' in the framework of Directive 93/5/EEC was performed⁽¹¹⁾.
- (27) Based on that assessment and taking into account the PMTDI, maximum levels should be set for patulin in certain foodstuffs to protect consumers from unacceptable contamination. These maximum levels should be reviewed and, if necessary, reduced taking into account the progress in scientific and technological knowledge and the implementation of Commission Recommendation 2003/598/EC of 11 August 2003 on the prevention and reduction of patulin contamination in apple juice and apple juice ingredients in other beverages⁽¹²⁾.
- (28) As regards Fusarium toxins, the SCF has adopted several opinions evaluating deoxynivalenol in December 1999⁽¹³⁾ establishing a tolerable daily intake (TDI) of 1 µg/kg bw, zearalenone in June 2000⁽¹⁴⁾ establishing a temporary TDI of 0,2 µg/kg bw, fumonisins in October 2000⁽¹⁵⁾ (updated in April 2003)⁽¹⁶⁾ establishing a TDI of 2 µg/kg bw, nivalenol in October 2000⁽¹⁷⁾ establishing a temporary TDI of 0,7 µg/kg bw, T-2 and HT-2 toxin in May 2001⁽¹⁸⁾ establishing a combined temporary TDI of 0,06 µg/kg bw and the trichothecenes as group in February 2002⁽¹⁹⁾.
-
- ⁽⁵⁾ Reports of the Scientific Committee for Food, 35th series, Opinion of the Scientific Committee for Food on aflatoxins, ochratoxin A and patulin, p. 45.
http://ec.europa.eu/food/fs/sc/scf/reports/scf_reports_35.pdf
- ⁽⁶⁾ Opinion of the Scientific Committee on Food on Ochratoxin A (expressed on 17 September 1998)
http://ec.europa.eu/food/fs/sc/scf/out14_en.html
- ⁽⁷⁾ Reports on tasks for scientific cooperation, Task 3.2.7 'Assessment of dietary intake of Ochratoxin A by the population of EU Member States'.
http://ec.europa.eu/food/food/chemicalsafety/contaminants/task_3-2-7_en.pdf
- ⁽⁸⁾ OJ L 52, 4.3.1993, p. 18.
- ⁽⁹⁾ Opinion of the Scientific Panel on contaminants in the Food Chain of the EFSA on a request from the Commission related to ochratoxin A in food. http://www.efsa.europa.eu/etc/medialib/efsa/science/contam/contam_opinions/1521.Par.0001.File.dat/contam_op_ej365_ochratoxin_a_food_en1.pdf
- ⁽¹⁰⁾ Minutes of the 120th Meeting of the Scientific Committee on Food held on 8 and 9 March 2000 in Brussels, Minute statement on patulin. http://ec.europa.eu/food/fs/sc/scf/out55_en.pdf
- ⁽¹¹⁾ Reports on tasks for scientific cooperation, Task 3.2.8, 'Assessment of dietary intake of Patulin by the population of EU Member States'.
http://ec.europa.eu/food/food/chemicalsafety/contaminants/3.2.8_en.pdf
- ⁽¹²⁾ OJ L 203, 12.8.2003, p. 34.
- ⁽¹³⁾ Opinion of the Scientific Committee on Food on Fusarium-toxins Part 1: Deoxynivalenol (DON), (expressed on 2 December 1999)
http://ec.europa.eu/food/fs/sc/scf/out44_en.pdf
- ⁽¹⁴⁾ Opinion of the Scientific Committee on Food on Fusarium-toxins Part 2: Zearalenone (ZEA), (expressed on 22 June 2000)
http://ec.europa.eu/food/fs/sc/scf/out65_en.pdf
- ⁽¹⁵⁾ Opinion of the Scientific Committee on Food on Fusarium-toxins Part 3: Fumonisin B₁ (FB₁) (expressed on 17 October 2000)
http://ec.europa.eu/food/fs/sc/scf/out73_en.pdf
- ⁽¹⁶⁾ Updated opinion of the Scientific Committee on Food on Fumonisin B₁, B₂ and B₃ (expressed on 4 April 2003)
http://ec.europa.eu/food/fs/sc/scf/out185_en.pdf
- ⁽¹⁷⁾ Opinion of the Scientific Committee on Food on Fusarium-toxins Part 4: Nivalenol (expressed on 19 October 2000)
http://ec.europa.eu/food/fs/sc/scf/out74_en.pdf
- ⁽¹⁸⁾ Opinion of the Scientific Committee on Food on Fusarium-toxins Part 5: T-2 toxin and HT-2 toxin (adopted on 30 May 2001)
http://ec.europa.eu/food/fs/sc/scf/out88_en.pdf
- ⁽¹⁹⁾ Opinion of the Scientific Committee on Food on Fusarium-toxins Part 6: Group evaluation of T-2 toxin, HT-2toxin, nivalenol and deoxynivalenol. (adopted on 26 February 2002)
http://ec.europa.eu/food/fs/sc/scf/out123_en.pdf

- (29) In the framework of Directive 93/5/EEC the SCOOP-task 'Collection of occurrence data on Fusarium toxins in food and assessment of dietary intake by the population of EU Member States' was performed and finalised in September 2003 ⁽²⁰⁾.
- (30) Based on the scientific opinions and the assessment of the dietary intake, it is appropriate to set maximum levels for deoxynivalenol, zearalenone and fumonisins. As regards fumonisins, monitoring control results of the recent harvests indicate that maize and maize products can be very highly contaminated by fumonisins and it is appropriate that measures are taken to avoid such unacceptably highly contaminated maize and maize products can enter the food chain.
- (31) Intake estimates indicate that the presence of T-2 and HT-2 toxin can be of concern for public health. Therefore, the development of a reliable and sensitive method, collection of more occurrence data and more investigations/research in the factors involved in the presence of T-2 and HT-2 toxin in cereals and cereal products, in particular in oats and oat products, is necessary and of high priority.
- (32) It is not necessary due to co-occurrence to consider specific measures for 3-acetyl deoxynivalenol, 15-acetyl deoxynivalenol and fumonisin B₃, as measures with regard to in particular deoxynivalenol and fumonisin B₁ and B₂ would also protect the human population from an unacceptable exposure from 3-acetyl deoxynivalenol, 15-acetyl deoxynivalenol and fumonisin B₃. The same applies to nivalenol for which to a certain degree co-occurrence with deoxynivalenol can be observed. Furthermore, human exposure to nivalenol is estimated to be significantly below the t-TDI. As regards other trichothecenes considered in the abovementioned SCOOP-task, such as 3-acetyldeoxynivalenol, 15-acetyldeoxynivalenol, fusarenon-X, T2-triol, diacetoxyscirpenol, neosolaniol, monoacetoxyscirpenol and verrucol, the limited information available indicates that they do not occur widely and the levels found are generally low.
- (33) Climatic conditions during the growth, in particular at flowering, have a major influence on the Fusarium toxin content. However, good agricultural practices, whereby the risk factors are reduced to a minimum, can prevent to a certain degree the contamination by *Fusarium* fungi. Commission Recommendation 2006/583/EC of 17 August 2006 on the prevention and reduction of Fusarium toxins in cereals and cereal products ⁽²¹⁾ contains general principles for the prevention and reduction of Fusarium toxin contamination (zearalenone, fumonisins and trichothecenes) in cereals to be implemented by the development of national codes of practice based on these principles.
- (34) Maximum levels of Fusarium toxins should be set for unprocessed cereals placed on the market for first-stage processing. Cleaning, sorting and drying procedures are not considered as first-stage processing insofar as no physical action is exerted on the grain kernel itself. Scouring is to be considered as first-stage processing.
- (35) Since the degree to which Fusarium toxins in unprocessed cereals are removed by cleaning and processing may vary, it is appropriate to set maximum levels for final consumer cereal products as well as for major food ingredients derived from cereals to have enforceable legislation in the interest of ensuring public health protection.
- (36) For maize, not all factors involved in the formation of Fusarium toxins, in particular zearalenone and fumonisins B₁ and B₂, are yet precisely known. Therefore, a time period is granted to enable food business operators in the cereal chain to perform investigations on the sources of the formation of these mycotoxins and on the identification of the management measures to be taken to prevent their presence as far as reasonably possible. Maximum levels based on currently available occurrence data are proposed to apply from 2007 in case no specific maximum levels based on new information on occurrence and formation are set before that time.
- (37) Given the low contamination levels of Fusarium toxins found in rice, no maximum levels are proposed for rice or rice products.
- (38) A review of the maximum levels for deoxynivalenol, zearalenone, fumonisin B₁ and B₂ as well as the appropriateness of setting a maximum level for T-2 and HT-2 toxin in cereals and cereal products should be considered by 1 July 2008, taking into account the progress in scientific and technological knowledge on these toxins in food.
- (39) As regards lead, the SCF adopted an opinion on 19 June 1992 ⁽²²⁾ endorsing the provisional tolerable weekly intake (PTWI) of 25 µg/kg bw proposed by the WHO in 1986. The SCF concluded in its opinion that the mean level in foodstuffs does not seem to be a cause of immediate concern.

⁽²⁰⁾ Reports on tasks for scientific cooperation, Task 3.2.10 'Collection of occurrence data of Fusarium toxins in food and assessment of dietary intake by the population of EU Member States'. <http://ec.europa.eu/food/fs/scoop/task3210.pdf>

⁽²¹⁾ OJ L 234, 29.8.2006, p. 35.

⁽²²⁾ Reports of the Scientific Committee for Food, 32nd series, Opinion of the Scientific Committee for Food on 'The potential risk to health presented by lead in food and drink', p. 7, http://ec.europa.eu/food/fs/sc/scf/reports/scf_reports_32.pdf

- (40) In the framework of Directive 93/5/EEC 2004 the SCOOP-task 3.2.11 'Assessment of the dietary exposure to arsenic, cadmium, lead and mercury of the population of the EU Member States' was performed in 2004⁽²³⁾. In view of this assessment and the opinion delivered by the SCF, it is appropriate to take measures to reduce the presence of lead in food as much as possible
- (41) As regards cadmium, the SCF endorsed in its opinion of 2 June 1995⁽²⁴⁾ the PTWI of 7 µg/kg bw and recommended greater efforts to reduce dietary exposure to cadmium since foodstuffs are the main source of human intake of cadmium. A dietary exposure assessment was performed in the SCOOP-task 3.2.11. In view of this assessment and the opinion delivered by the SCF, it is appropriate to take measures to reduce the presence of cadmium in food as much as possible.
- (42) As regards mercury EFSA adopted on 24 February 2004 an opinion related to mercury and methylmercury in food⁽²⁵⁾ and endorsed the provisional tolerable weekly intake of 1,6 µg/kg bw. Methylmercury is the chemical form of most concern and can make up more than 90 % of the total mercury in fish and seafood. Taking into account the outcome of the SCOOP-task 3.2.11, EFSA concluded that the levels of mercury found in foods, other than fish and seafood, were of lower concern. The forms of mercury present in these other foods are mainly not methylmercury and they are therefore considered to be of lower risk.
- (43) In addition to the setting of maximum levels, targeted consumer advice is an appropriate approach in the case of methylmercury for protecting vulnerable groups of the population. An information note on methylmercury in fish and fishery products responding to this need has therefore been made available on the website of the Health and Consumer Protection Directorate-General of the European Commission⁽²⁶⁾. Several Member States have also issued advice on this issue that is relevant to their population.
- (44) As regards inorganic tin, the SCF concluded in its opinion of 12 December 2001⁽²⁷⁾ that levels of inorganic tin of 150 mg/kg in canned beverages and 250 mg/kg in other canned foods may cause gastric irritation in some individuals.
- (45) To protect public health from this health risk it is necessary to set maximum levels for inorganic tin in canned foods and canned beverages. Until data becomes available on the sensitivity of infants and young children to inorganic tin in foods, it is necessary on a precautionary basis to protect the health of this vulnerable population group and to establish lower maximum levels.
- (46) As regards 3-monochloropropane-1,2-diol (3-MCPD) the SCF adopted on 30 May 2001 a scientific opinion as regards 3-MCPD in food⁽²⁸⁾, updating its opinion of 16 December 1994⁽²⁹⁾ on the basis of new scientific information and established a tolerable daily intake (TDI) of 2 µg/kg bw for 3-MCPD.
- (47) In the framework of Directive 93/5/EEC the SCOOP-task 'Collection and collation of data on levels of 3-MCPD and related substances in foodstuffs' was performed and finalised in June 2004⁽³⁰⁾. The main contributors of 3-MCPD to dietary intake were soy sauce and soy-sauce based products. Some other foods eaten in large quantities, such as bread and noodles, also contributed significantly to intake in some countries because of high consumption rather than high levels of 3-MCPD present in these foods.
- (48) Accordingly maximum levels should be set for 3-MCPD in hydrolysed vegetable protein (HVP) and soy sauce taking into account the risk related to the consumption of these foods. Member States are requested to examine other foodstuffs for the occurrence of 3-MCPD in order to consider the need to set maximum levels for additional foodstuffs.

⁽²³⁾ Reports on tasks for scientific co-operation, Task 3.2.11 'Assessment of dietary exposure to arsenic, cadmium, lead and mercury of the population of the EU Member States'. http://ec.europa.eu/food/food/chemicalsafety/contaminants/scoop_3-2-11_heavy_metals_report_en.pdf

⁽²⁴⁾ Reports of the Scientific Committee for Food, 36th series, Opinion of the Scientific Committee for Food on cadmium, p. 67, http://ec.europa.eu/food/fs/sc/scf/reports/scf_reports_36.pdf

⁽²⁵⁾ Opinion of the Scientific Panel on contaminants in the Food Chain of the European Food Safety Authority (EFSA) on a request from the Commission related to mercury and methylmercury in food (adopted on 24 February 2004) http://www.efsa.eu.int/science/contam/contam_opinions/259/opinion_contam_01_en1.pdf

⁽²⁶⁾ http://ec.europa.eu/food/food/chemicalsafety/contaminants/information_note_mercury-fish_12-05-04.pdf

⁽²⁷⁾ Opinion of the Scientific Committee on Food on acute risks posed by tin in canned foods (adopted on 12 December 2001) http://ec.europa.eu/food/fs/sc/scf/out110_en.pdf

⁽²⁸⁾ Opinion of the Scientific Committee on Food on 3-monochloropropane-1,2-diol (3-MCPD) updating the SCF opinion of 1994 (adopted on 30 May 2001) http://ec.europa.eu/food/fs/sc/scf/out91_en.pdf

⁽²⁹⁾ Reports of the Scientific Committee for Food, 36th series, Opinion of the Scientific Committee for Food on 3-monochloropropane-1,2-diol 3-MCPD, p. 31, http://ec.europa.eu/food/fs/sc/scf/reports/scf_reports_36.pdf

⁽³⁰⁾ Reports on tasks for scientific cooperation, Task 3.2.9 'Collection and collation of data on levels of 3-monochloropropanediol (3-MCPD) and related substances in foodstuffs'. http://ec.europa.eu/food/food/chemicalsafety/contaminants/scoop_3-2-9_final_report_chloropropanols_en.pdf

- (49) As regards dioxins and PCBs, the SCF adopted on 30 May 2001 an opinion on dioxins and dioxin-like PCBs in food ⁽³¹⁾, updating its opinion of 22 November 2000 ⁽³²⁾ fixing a tolerable weekly intake (TWI) of 14 pg World Health Organisation toxic equivalent (WHO-TEQ)/kg bw for dioxins and dioxin-like PCBs.
- (50) Dioxins as referred to in this Regulation cover a group of 75 polychlorinated dibenzo-p-dioxin (PCDD) congeners and 135 polychlorinated dibenzofuran (PCDF) congeners, of which 17 are of toxicological concern. Polychlorinated biphenyls (PCBs) are a group of 209 different congeners which can be divided into two groups according to their toxicological properties: 12 congeners exhibit toxicological properties similar to dioxins and are therefore often termed dioxin-like PCBs. The other PCBs do not exhibit dioxin-like toxicity but have a different toxicological profile.
- (51) Each congener of dioxins or dioxin-like PCBs exhibits a different level of toxicity. In order to be able to sum up the toxicity of these different congeners, the concept of toxic equivalency factors (TEFs) has been introduced to facilitate risk assessment and regulatory control. This means that the analytical results relating to all the individual dioxin and dioxin-like PCB congeners of toxicological concern are expressed in terms of a quantifiable unit, namely the TCDD toxic equivalent (TEQ).
- (52) Exposure estimates taking into account the SCOOP-task 'Assessment of dietary intake of dioxins and related PCBs by the population of EU Member States' finalised in June 2000 ⁽³³⁾ indicate that a considerable proportion of the Community population has a dietary intake in excess of the TWI.
- (53) From a toxicological point of view, any level set should apply to both dioxins and dioxin-like PCBs, but in 2001 maximum levels were set on Community level only for dioxins and not for dioxin-like PCBs, given the very limited data available at that time on the prevalence of dioxin-like PCBs. Since 2001, however, more data on the presence of dioxin-like PCBs have become available, therefore, maximum levels for the sum of dioxins and dioxin-like PCBs have been set in 2006 as this is the most appropriate approach from a toxicological point of view. In order to ensure a smooth transition, the levels for dioxins should continue to apply for a transitional period in addition to the levels for the sum of dioxins and dioxin-like PCBs. Foodstuffs must comply during that transitional period with the maximum levels for dioxins and with the maximum levels for the sum of dioxins and dioxin-like PCBs. Consideration will be given by 31 December 2008 to dispensing with the separate maximum levels for dioxins.
- (54) In order to encourage a proactive approach to reducing the dioxins and dioxin-like PCBs present in food and feed, action levels were set by Commission Recommendation 2006/88/EC of 6 February 2006 on the reduction of the presence of dioxins, furans and PCBs in feeding-stuffs and foodstuffs ⁽³⁴⁾. These action levels are a tool for competent authorities and operators to highlight those cases where it is appropriate to identify a source of contamination and to take measures to reduce or eliminate it. Since the sources of dioxins and dioxin-like PCBs are different, separate action levels are determined for dioxins on the one hand and for dioxin-like PCBs on the other hand. This proactive approach to actively reduce the dioxins and dioxin-like PCBs in feed and food and consequently, the maximum levels applicable should be reviewed within a defined period of time with the objective to set lower levels. Therefore, consideration will be given by 31 December 2008 to significantly reducing the maximum levels for the sum of dioxins and dioxin-like PCBs.
- (55) Operators need to make efforts to step up their capacity to remove dioxins, furans and dioxin-like PCBs from marine oil. The significant lower level, to which consideration shall be given by 31 December 2008, shall be based on the technical possibilities of the most effective decontamination procedure.
- (56) As regards the establishment of maximum levels for other foodstuffs by 31 December 2008, particular attention shall be paid to the need to set specific lower maximum levels for dioxins and dioxin-like PCBs in foods for infants and young children in the light of the monitoring data obtained through the 2005, 2006 and 2007 programmes for monitoring dioxins and dioxin-like PCBs in foods for infants and young children.

⁽³¹⁾ Opinion of the Scientific Committee on Food on the risk assessment of dioxins and dioxin-like PCBs in food. Update based on new scientific information available since the adoption of the SCF opinion of 22nd November 2000 (adopted on 30 May 2001) http://ec.europa.eu/food/fs/sc/scf/out90_en.pdf

⁽³²⁾ Opinion of the Scientific Committee on Food on the risk assessment of dioxins and dioxin-like PCBs in food. (adopted on 22 November 2000) http://ec.europa.eu/food/fs/sc/scf/out78_en.pdf

⁽³³⁾ Reports on tasks for scientific cooperation, Task 3.2.5 'Assessment of dietary intake of dioxins and related PCBs by the population of EU Member States'. http://ec.europa.eu/dgs/health_consumer/library/pub/pub08_en.pdf

⁽³⁴⁾ OJ L 42, 14.2.2006, p. 26.

- (57) As regards polycyclic aromatic hydrocarbons, the SCF concluded in its opinion of 4 December 2002⁽³⁵⁾ that a number of polycyclic aromatic hydrocarbons (PAH) are genotoxic carcinogens. The Joint FAO/WHO Expert Committee on Food Additives (JECFA) performed in 2005 a risk assessment on PAHs and estimated margins of exposure (MOE) for PAH as a basis for advice on compounds that are both genotoxic and carcinogenic⁽³⁶⁾.
- (58) According to the SCF, benzo(a)pyrene can be used as a marker for the occurrence and effect of carcinogenic PAH in food, including also benz(a)anthracene, benzo(b)fluoranthene, benzo(j)fluoranthene, benzo(k)fluoranthene, benzo(g,h,i)perylene, chrysene, cyclopenta(c,d)pyrene, dibenz(a,h)anthracene, dibenzo(a,e)pyrene, dibenzo(a,h)pyrene, dibenzo(a,i)pyrene, dibenzo(a,l)pyrene, indeno(1,2,3-cd)pyrene and 5-methylchrysene. Further analyses of the relative proportions of these PAH in foods would be necessary to inform a future review of the suitability of maintaining benzo(a)pyrene as a marker. In addition benzo(c)fluorene should be analysed, following a recommendation of JECFA.
- (59) PAH can contaminate foods during smoking processes and heating and drying processes that allow combustion products to come into direct contact with food. In addition, environmental pollution may cause contamination with PAH, in particular in fish and fishery products.
- (60) In the framework of Directive 93/5/EEC, a specific SCOOP-task 'Collection of occurrence data on PAH in food' has been performed in 2004⁽³⁷⁾. High levels were found in dried fruits, olive pomace oil, smoked fish, grape seed oil, smoked meat products, fresh molluscs, spices/sauces and condiments.
- (61) In order to protect public health, maximum levels are necessary for benzo(a)pyrene in certain foods containing fats and oils and in foods where smoking or drying processes might cause high levels of contamination. Maximum levels are also necessary in foods where environmental pollution may cause high levels of contamination, in particular in fish and fishery products, for example resulting from oil spills caused by shipping.
- (62) In some foods, such as dried fruit and food supplements, benzo(a)pyrene has been found, but available data are inconclusive on what levels are reasonably achievable. Further investigation is needed to clarify the levels that are reasonably achievable in these foods. In the meantime, maximum levels for benzo(a)pyrene in relevant ingredients should apply, such as in oils and fats used in food supplements.
- (63) The maximum levels for PAH and the appropriateness of setting a maximum level for PAH in cocoa butter should be reviewed by 1 April 2007, taking into account the progress in scientific and technological knowledge on the occurrence of benzo(a)pyrene and other carcinogenic PAH in food.
- (64) The measures provided for in this Regulation are in accordance with the opinion of the Standing Committee on the Food Chain and Animal Health,

HAS ADOPTED THIS REGULATION:

Article 1

General rules

1. The foodstuffs listed in the Annex shall not be placed on the market where they contain a contaminant listed in the Annex at a level exceeding the maximum level set out in the Annex.
2. The maximum levels specified in the Annex shall apply to the edible part of the foodstuffs concerned, unless otherwise specified in the Annex.

Article 2

Dried, diluted, processed and compound foodstuffs

1. When applying the maximum levels set out in the Annex to foodstuffs which are dried, diluted, processed or composed of more than one ingredient, the following shall be taken into account:
 - (a) changes of the concentration of the contaminant caused by drying or dilution processes;
 - (b) changes of the concentration of the contaminant caused by processing;
 - (c) the relative proportions of the ingredients in the product;
 - (d) the analytical limit of quantification.

⁽³⁵⁾ Opinion of the Scientific Committee on Food on the risks to human health of Polycyclic Aromatic Hydrocarbons in food (expressed on 4 December 2002)

http://ec.europa.eu/food/fs/sc/scf/out153_en.pdf

⁽³⁶⁾ Evaluation of certain food contaminants — Report of the Joint FAO/WHO Expert Committee on Food Additives, 64th meeting, Rome, 8 to 17 February 2005, p. 1 and p. 61.

WHO Technical Report Series, No. 930, 2006 — http://whqlibdoc.who.int/trs/WHO_TRS_930_eng.pdf

⁽³⁷⁾ Reports on tasks for scientific co-operation, Task 3.2.12 'Collection of occurrence data on polycyclic aromatic hydrocarbons in food'. http://ec.europa.eu/food/food/chemicalsafety/contaminants/scoop_3-2-12_final_report_pah_en.pdf

2. The specific concentration or dilution factors for the drying, dilution, processing and/or mixing operations concerned or for the dried, diluted, processed and/or compound foodstuffs concerned shall be provided and justified by the food business operator, when the competent authority carries out an official control.

If the food business operator does not provide the necessary concentration or dilution factor or if the competent authority deems that factor inappropriate in view of the justification given, the authority shall itself define that factor, based on the available information and with the objective of maximum protection of human health.

3. Paragraphs 1 and 2 shall apply in so far as no specific Community maximum levels are fixed for these dried, diluted, processed or compound foodstuffs.

4. As far as Community legislation does not provide for specific maximum levels for foods for infants and young children, Member States may provide for stricter levels.

Article 3

Prohibitions on use, mixing and detoxification

1. Foodstuffs not complying with the maximum levels set out in the Annex shall not be used as food ingredients.

2. Foodstuffs complying with the maximum levels set out in the Annex shall not be mixed with foodstuffs which exceed these maximum levels.

3. Foodstuffs to be subjected to sorting or other physical treatment to reduce contamination levels shall not be mixed with foodstuffs intended for direct human consumption or with foodstuffs intended for use as a food ingredient.

4. Foodstuffs containing contaminants listed in section 2 of the Annex (Mycotoxins) shall not be deliberately detoxified by chemical treatments.

Article 4

Specific provisions for groundnuts, nuts, dried fruit and maize

Groundnuts, nuts, dried fruit and maize not complying with the appropriate maximum levels of aflatoxins laid down in points 2.1.3, 2.1.5 and 2.1.6 of the Annex can be placed on the market provided that these foodstuffs:

- (a) are not intended for direct human consumption or use as an ingredient in foodstuffs;
- (b) comply with the appropriate maximum levels laid down in points 2.1.1, 2.1.2, 2.1.4 and 2.1.7 of the Annex;
- (c) are subjected to a treatment involving sorting or other physical treatment and that after this treatment the maximum levels laid down in points 2.1.3, 2.1.5 and 2.1.6 of the Annex are not exceeded, and this treatment does not result in other harmful residues;
- (d) are labelled clearly showing their use, and bearing the indication 'product shall be subjected to sorting or other physical treatment to reduce aflatoxin contamination before human consumption or use as an ingredient in foodstuffs'. The indication shall be included on the label of each individual bag, box etc. or on the original accompanying document. The consignment/batch identification code shall be indelibly marked on each individual bag, box etc. of the consignment and on the original accompanying document.

Article 5

Specific provisions for groundnuts, derived products thereof and cereals

A clear indication of the intended use must appear on the label of each individual bag, box, etc. or on the original accompanying document. This accompanying document must have a clear link with the consignment by means of mentioning the consignment identification code, which is on each individual bag, box, etc. of the consignment. In addition the business activity of the consignee of the consignment given on the accompanying document must be compatible with the intended use.

In the absence of a clear indication that their intended use is not for human consumption, the maximum levels laid down in points 2.1.3 and 2.1.6 of the Annex shall apply to all groundnuts, derived products thereof and cereals placed on the market.

Article 6

Specific provisions for lettuce

Unless lettuce grown under cover (protected lettuce) is labelled as such, maximum levels set in the Annex for lettuce grown in the open air (open-grown lettuce) shall apply.

*Article 7***Temporary derogations**

1. By way of derogation from Article 1, Belgium, Ireland, the Netherlands and the United Kingdom may authorise until 31 December 2008 the placing on the market of fresh spinach grown and intended for consumption in their territory with nitrate levels higher than the maximum levels set out in point 1.1 of the Annex.

2. By way of derogation from Article 1, Ireland and the United Kingdom may authorise until 31 December 2008 the placing on the market of fresh lettuce grown and intended for consumption in their territory and harvested throughout the year with nitrate levels higher than the maximum levels set out in point 1.3 of the Annex.

3. By way of derogation from Article 1, France may authorise until 31 December 2008 the placing on the market of fresh lettuce grown and intended for consumption in its territory and harvested from 1 October to 31 March with nitrate levels higher than the maximum levels set out in point 1.3 of the Annex.

4. By way of derogation from Article 1, Finland and Sweden may authorise until 31 December 2011 the placing on their market of salmon (*Salmo salar*), herring (*Clupea harengus*), river lamprey (*Lampetra fluviatilis*), trout (*Salmo trutta*), char (*Salvelinus* spp.) and roe of vendace (*Coregonus albula*) originating in the Baltic region and intended for consumption in their territory with levels of dioxins and/or levels of the sum of dioxins and dioxin-like PCBs higher than those set out in point 5.3 of the Annex, provided that a system is in place to ensure that consumers are fully informed of the dietary recommendations with regard to the restrictions on the consumption of these fish species from the Baltic region by identified vulnerable sections of the population in order to avoid potential health risks. By 31 March each year, Finland and Sweden shall communicate to the Commission the results of their monitoring of the levels of dioxins and dioxin-like PCBs in fish from the Baltic region obtained in the preceding year and shall report on the measures taken to reduce human exposure to dioxins and dioxin-like PCBs from fish from the Baltic region.

Finland and Sweden shall continue to apply the necessary measures to ensure that fish and fish products not complying with point 5.3 of the Annex are not marketed in other Member States.

*Article 8***Sampling and analysis**

The sampling and the analysis for the official control of the maximum levels specified in the Annex shall be performed in accordance with Commission Regulations (EC) No

1882/2006⁽³⁸⁾, No 401/2006⁽³⁹⁾, No 1883/2006⁽⁴⁰⁾ and Commission Directives 2001/22/EC⁽⁴¹⁾, 2004/16/EC⁽⁴²⁾ and 2005/10/EC⁽⁴³⁾.

*Article 9***Monitoring and reporting**

1. Member States shall monitor nitrate levels in vegetables which may contain significant levels, in particular green leaf vegetables, and communicate the results to the Commission by 30 June each year. The Commission will make these results available to the Member States.

2. Member States and interested parties shall communicate each year to the Commission the results of investigations undertaken including occurrence data and the progress with regard to the application of prevention measures to avoid contamination by ochratoxin A, deoxynivalenol, zearalenone, fumonisin B₁ and B₂, T-2 and HT-2 toxin. The Commission will make these results available to the Member States.

3. Member States should report to the Commission findings on aflatoxins, dioxins, dioxin-like PCBs, non-dioxin-like PCBs and polycyclic aromatic hydrocarbons as specified in Commission Decision 2006/504/EC⁽⁴⁴⁾, Commission Recommendation 2006/794/EC⁽⁴⁵⁾ and Commission Recommendation 2005/108/EC⁽⁴⁶⁾.

*Article 10***Repeal**

Regulation (EC) No 466/2001 is repealed.

References to the repealed Regulation shall be construed as references to this Regulation.

*Article 11***Transitional measures**

This Regulation shall not apply to products that were placed on the market before the dates referred to in points (a) to (d) in conformity with the provisions applicable at the respective date:

- (a) 1 July 2006 as regards the maximum levels for deoxynivalenol and zearalenone laid down in points 2.4.1, 2.4.2, 2.4.4, 2.4.5, 2.4.6, 2.4.7, 2.5.1, 2.5.3, 2.5.5 and 2.5.7 of the Annex;

⁽³⁸⁾ See page 25 of this Official Journal.

⁽³⁹⁾ OJ L 70, 9.3.2006, p. 12.

⁽⁴⁰⁾ See page 32 of this Official Journal.

⁽⁴¹⁾ OJ L 77, 16.3.2001, p. 14. Directive as amended by Directive 2005/4/EC (OJ L 19, 21.1.2005, p. 50).

⁽⁴²⁾ OJ L 42, 13.2.2004, p. 16.

⁽⁴³⁾ OJ L 34, 8.2.2005, p. 15.

⁽⁴⁴⁾ OJ L 199, 21.7.2006, p. 21.

⁽⁴⁵⁾ OJ L 322, 22.11.2006, p. 24.

⁽⁴⁶⁾ OJ L 34, 8.2.2005, p. 43.

(b) 1 July 2007 as regards the maximum levels for deoxyvalenol and zearalenone laid down in points 2.4.3, 2.5.2, 2.5.4, 2.5.6 and 2.5.8 of the Annex;

(c) 1 October 2007 as regards the maximum levels for fumonisins B₁ and B₂ laid down in point 2.6 of the Annex;

(d) 4 November 2006 as regards the maximum levels for the sum of dioxins and dioxin-like PCBs laid down in section 5 of the Annex.

The burden of proving when the products were placed on the market shall be borne by the food business operator.

Article 12

Entry into force and application

This Regulation shall enter into force on the 20th day following its publication in the *Official Journal of the European Union*.

It shall apply from 1 March 2007.

This Regulation shall be binding in its entirety and directly applicable in all Member States.

Done at Brussels, 19 December 2006.

For the Commission

Markos KYPRIANOU

Member of the Commission

ANNEX

Maximum levels for certain contaminants in foodstuffs ⁽¹⁾

Section 1: Nitrate

Foodstuffs ⁽¹⁾		Maximum levels (mg NO ₃ /kg)	
1.1	Fresh spinach (<i>Spinacia oleracea</i>) ⁽²⁾	Harvested 1 October to 31 March	3 000
		Harvested 1 April to 30 September	2 500
1.2	Preserved, deep-frozen or frozen spinach		2 000
1.3	Fresh Lettuce (<i>Lactuca sativa</i> L.) (protected and open-grown lettuce) excluding lettuce listed in point 1.4	Harvested 1 October to 31 March:	
		lettuce grown under cover	4 500
		lettuce grown in the open air	4 000
		Harvested 1 April to 30 September:	
	lettuce grown under cover	3 500	
	lettuce grown in the open air	2 500	
1.4	Iceberg-type lettuce	Lettuce grown under cover	2 500
		Lettuce grown in the open air	2 000
1.5	Processed cereal-based foods and baby foods for infants and young children ⁽³⁾ ⁽⁴⁾		200

Section 2: Mycotoxins

Foodstuffs ⁽¹⁾		Maximum levels (µg/kg)		
2.1	Aflatoxins	B ₁	Sum of B ₁ , B ₂ , G ₁ and G ₂	M ₁
2.1.1	Groundnuts to be subjected to sorting, or other physical treatment, before human consumption or use as an ingredient in foodstuffs	8,0 ⁽⁵⁾	15,0 ⁽⁵⁾	—
2.1.2	Nuts to be subjected to sorting, or other physical treatment, before human consumption or use as an ingredient in foodstuffs	5,0 ⁽⁵⁾	10,0 ⁽⁵⁾	—
2.1.3	Groundnuts and nuts and processed products thereof, intended for direct human consumption or use as an ingredient in foodstuffs	2,0 ⁽⁵⁾	4,0 ⁽⁵⁾	—
2.1.4	Dried fruit to be subjected to sorting, or other physical treatment, before human consumption or use as an ingredient in foodstuffs	5,0	10,0	—
2.1.5	Dried fruit and processed products thereof, intended for direct human consumption or use as an ingredient in foodstuffs	2,0	4,0	—
2.1.6	All cereals and all products derived from cereals, including processed cereal products, with the exception of foodstuffs listed in 2.1.7, 2.1.10 and 2.1.12	2,0	4,0	—
2.1.7	Maize to be subjected to sorting or other physical treatment before human consumption or use as an ingredient in foodstuffs	5,0	10,0	—
2.1.8	Raw milk ⁽⁶⁾ , heat-treated milk and milk for the manufacture of milk-based products	—	—	0,050

Foodstuffs ⁽¹⁾		Maximum levels (µg/kg)		
2.1.9	Following species of spices: <i>Capsicum</i> spp. (dried fruits thereof, whole or ground, including chillies, chilli powder, cayenne and paprika) <i>Piper</i> spp. (fruits thereof, including white and black pepper) <i>Myristica fragrans</i> (nutmeg) <i>Zingiber officinale</i> (ginger) <i>Curcuma longa</i> (turmeric)	5,0	10,0	—
2.1.10	Processed cereal-based foods and baby foods for infants and young children ⁽³⁾ ⁽⁷⁾	0,10	—	—
2.1.11	Infant formulae and follow-on formulae, including infant milk and follow-on milk ⁽⁴⁾ ⁽⁸⁾	—	—	0,025
2.1.12	Dietary foods for special medical purposes ⁽⁹⁾ ⁽¹⁰⁾ intended specifically for infants	0,10	—	0,025
2.2	Ochratoxin A			
2.2.1	Unprocessed cereals	5,0		
2.2.2	All products derived from unprocessed cereals, including processed cereal products and cereals intended for direct human consumption with the exception of foodstuffs listed in 2.2.9 and 2.2.10	3,0		
2.2.3	Dried vine fruit (currants, raisins and sultanas)	10,0		
2.2.4	Roasted coffee beans and ground roasted coffee, excluding soluble coffee	5,0		
2.2.5	Soluble coffee (instant coffee)	10,0		
2.2.6	Wine (including sparkling wine, excluding liqueur wine and wine with an alcoholic strength of not less than 15 % vol) and fruit wine ⁽¹¹⁾	2,0 ⁽¹²⁾		
2.2.7	Aromatised wine, aromatised wine-based drinks and aromatised wine-product cocktails ⁽¹³⁾	2,0 ⁽¹²⁾		
2.2.8	Grape juice, concentrated grape juice as reconstituted, grape nectar, grape must and concentrated grape must as reconstituted, intended for direct human consumption ⁽¹⁴⁾	2,0 ⁽¹²⁾		
2.2.9	Processed cereal-based foods and baby foods for infants and young children ⁽³⁾ ⁽⁷⁾	0,50		
2.2.10	Dietary foods for special medical purposes ⁽⁹⁾ ⁽¹⁰⁾ intended specifically for infants	0,50		
2.2.11	Green coffee, dried fruit other than dried vine fruit, beer, cocoa and cocoa products, liqueur wines, meat products, spices and liquorice	—		
2.3	Patulin			
2.3.1	Fruit juices, concentrated fruit juices as reconstituted and fruit nectars ⁽¹⁴⁾	50		

	Foodstuffs ⁽¹⁾	Maximum levels (µg/kg)
2.3.2	Spirit drinks ⁽¹⁵⁾ , cider and other fermented drinks derived from apples or containing apple juice	50
2.3.3	Solid apple products, including apple compote, apple puree intended for direct consumption with the exception of foodstuffs listed in 2.3.4 and 2.3.5	25
2.3.4	Apple juice and solid apple products, including apple compote and apple puree, for infants and young children ⁽¹⁶⁾ and labelled and sold as such ⁽⁴⁾	10,0
2.3.5	Baby foods other than processed cereal-based foods for infants and young children ⁽³⁾ ⁽⁴⁾	10,0
2.4	Deoxynivalenol ⁽¹⁷⁾	
2.4.1	Unprocessed cereals ⁽¹⁸⁾ ⁽¹⁹⁾ other than durum wheat, oats and maize	1 250
2.4.2	Unprocessed durum wheat and oats ⁽¹⁸⁾ ⁽¹⁹⁾	1 750
2.4.3	Unprocessed maize ⁽¹⁸⁾	1 750 ⁽²⁰⁾
2.4.4	Cereals intended for direct human consumption, cereal flour (including maize flour, maize meal and maize grits ⁽²¹⁾), bran as end product marketed for direct human consumption and germ, with the exception of foodstuffs listed in 2.4.7	750
2.4.5	Pasta (dry) ⁽²²⁾	750
2.4.6	Bread (including small bakery wares), pastries, biscuits, cereal snacks and breakfast cereals	500
2.4.7	Processed cereal-based foods and baby foods for infants and young children ⁽³⁾ ⁽⁷⁾	200
2.5	Zearalenone ⁽¹⁷⁾	
2.5.1	Unprocessed cereals ⁽¹⁸⁾ ⁽¹⁹⁾ other than maize	100
2.5.2	Unprocessed maize ⁽¹⁸⁾	200 ⁽²⁰⁾
2.5.3	Cereals intended for direct human consumption, cereal flour, bran as end product marketed for direct human consumption and germ, with the exception of foodstuffs listed in 2.5.4, 2.5.7 and 2.5.8	75
2.5.4	Maize intended for direct human consumption, maize flour, maize meal, maize grits, maize germ and refined maize oil ⁽²¹⁾	200 ⁽²⁰⁾
2.5.5	Bread (including small bakery wares), pastries, biscuits, cereal snacks and breakfast cereals, excluding maize snacks and maize based breakfast cereals	50
2.5.6	Maize snacks and maize based breakfast cereals	50 ⁽²⁰⁾

Foodstuffs ⁽¹⁾		Maximum levels (µg/kg)
2.5.7	Processed cereal-based foods (excluding processed maize-based foods) and baby foods for infants and young children ⁽³⁾ ⁽⁷⁾	20
2.5.8	Processed maize-based foods for infants and young children ⁽³⁾ ⁽⁷⁾	20 ⁽²⁰⁾
2.6	Fumonisin	Sum of B ₁ and B ₂
2.6.1	Unprocessed maize ⁽¹⁸⁾	2 000 ⁽²³⁾
2.6.2	Maize flour, maize meal, maize grits, maize germ and refined maize oil ⁽²¹⁾	1 000 ⁽²³⁾
2.6.3	Maize based foods for direct human consumption, excluding foods listed in 2.6.2 and 2.6.4	400 ⁽²³⁾
2.6.4	Processed maize-based foods and baby foods for infants and young children ⁽³⁾ ⁽⁷⁾	200 ⁽²³⁾
2.7	T-2 and HT-2 toxin ⁽¹⁷⁾	Sum of T-2 and HT-2 toxin
2.7.1	Unprocessed cereals ⁽¹⁸⁾ and cereal products	

Section 3: Metals

Foodstuffs ⁽¹⁾		Maximum levels (mg/kg wet weight)
3.1	Lead	
3.1.1	Raw milk ⁽⁶⁾ , heat-treated milk and milk for the manufacture of milk-based products	0,020
3.1.2	Infant formulae and follow-on formulae ⁽⁴⁾ ⁽⁸⁾	0,020
3.1.3	Meat (excluding offal) of bovine animals, sheep, pig and poultry ⁽⁶⁾	0,10
3.1.4	Offal of bovine animals, sheep, pig and poultry ⁽⁶⁾	0,50
3.1.5	Muscle meat of fish ⁽²⁴⁾ ⁽²⁵⁾	0,30
3.1.6	Crustaceans, excluding brown meat of crab and excluding head and thorax meat of lobster and similar large crustaceans (<i>Nephropidae</i> and <i>Palinuridae</i>) ⁽²⁶⁾	0,50
3.1.7	Bivalve molluscs ⁽²⁶⁾	1,5
3.1.8	Cephalopods (without viscera) ⁽²⁶⁾	1,0
3.1.9	Cereals, legumes and pulses	0,20
3.1.10	Vegetables, excluding brassica vegetables, leaf vegetables, fresh herbs and fungi ⁽²⁷⁾ . For potatoes the maximum level applies to peeled potatoes	0,10

	Foodstuffs ⁽¹⁾	Maximum levels (mg/kg wet weight)
3.1.11	Brassica vegetables, leaf vegetables and cultivated fungi ⁽²⁷⁾	0,30
3.1.12	Fruit, excluding berries and small fruit ⁽²⁷⁾	0,10
3.1.13	Berries and small fruit ⁽²⁷⁾	0,20
3.1.14	Fats and oils, including milk fat	0,10
3.1.15	Fruit juices, concentrated fruit juices as reconstituted and fruit nectars ⁽¹⁴⁾	0,050
3.1.16	Wine (including sparkling wine, excluding liqueur wine), cider, perry and fruit wine ⁽¹¹⁾	0,20 ⁽²⁸⁾
3.1.17	Aromatized wine, aromatized wine-based drinks and aromatized wine-product cocktails ⁽¹³⁾	0,20 ⁽²⁸⁾
3.2	Cadmium	
3.2.1	Meat (excluding offal) of bovine animals, sheep, pig and poultry ⁽⁶⁾	0,050
3.2.2	Horsemeat, excluding offal ⁽⁶⁾	0,20
3.2.3	Liver of bovine animals, sheep, pig, poultry and horse ⁽⁶⁾	0,50
3.2.4	Kidney of bovine animals, sheep, pig, poultry and horse ⁽⁶⁾	1,0
3.2.5	Muscle meat of fish ⁽²⁴⁾ ⁽²⁵⁾ , excluding species listed in 3.2.6 and 3.2.7	0,050
3.2.6	Muscle meat of the following fish ⁽²⁴⁾ ⁽²⁵⁾ : anchovy (<i>Engraulis species</i>) bonito (<i>Sarda sarda</i>) common two-banded seabream (<i>Diplodus vulgaris</i>) eel (<i>Anguilla anguilla</i>) grey mullet (<i>Mugil labrosus labrosus</i>) horse mackerel or scad (<i>Trachurus species</i>) louvar or luvar (<i>Luvarus imperialis</i>) sardine (<i>Sardina pilchardus</i>) sardinops (<i>Sardinops species</i>) tuna (<i>Thunnus species</i> , <i>Euthynnus species</i> , <i>Katsuwonus pelamis</i>) wedge sole (<i>Dicologlossa cuneata</i>)	0,10
3.2.7	Muscle meat of swordfish (<i>Xiphias gladius</i>) ⁽²⁴⁾ ⁽²⁵⁾	0,30
3.2.8	Crustaceans, excluding brown meat of crab and excluding head and thorax meat of lobster and similar large crustaceans (<i>Nephropidae</i> and <i>Palinuridae</i>) ⁽²⁶⁾	0,50
3.2.9	Bivalve molluscs ⁽²⁶⁾	1,0
3.2.10	Cephalopods (without viscera) ⁽²⁶⁾	1,0

	Foodstuffs ⁽¹⁾	Maximum levels (mg/kg wet weight)
3.2.11	Cereals excluding bran, germ, wheat and rice	0,10
3.2.12	Bran, germ, wheat and rice	0,20
3.2.13	Soybeans	0,20
3.2.14	Vegetables and fruit, excluding leaf vegetables, fresh herbs, fungi, stem vegetables, pine nuts, root vegetables and potatoes ⁽²⁷⁾	0,050
3.2.15	Leaf vegetables, fresh herbs, cultivated fungi and celeriac ⁽²⁷⁾	0,20
3.2.16	Stem vegetables, root vegetables and potatoes, excluding celeriac ⁽²⁷⁾ . For potatoes the maximum level applies to peeled potatoes	0,10
3.3	Mercury	
3.3.1	Fishery products ⁽²⁶⁾ and muscle meat of fish ⁽²⁴⁾ ⁽²⁵⁾ , excluding species listed in 3.3.2. The maximum level applies to crustaceans, excluding the brown meat of crab and excluding head and thorax meat of lobster and similar large crustaceans (<i>Nephropidae</i> and <i>Palinuridae</i>)	0,50
3.3.2	Muscle meat of the following fish ⁽²⁴⁾ ⁽²⁵⁾ : anglerfish (<i>Lophius species</i>) atlantic catfish (<i>Anarhichas lupus</i>) bonito (<i>Sarda sarda</i>) eel (<i>Anguilla species</i>) emperor, orange roughy, rosy soldierfish (<i>Hoplostethus species</i>) grenadier (<i>Coryphaenoides rupestris</i>) halibut (<i>Hippoglossus hippoglossus</i>) marlin (<i>Makaira species</i>) megrin (<i>Lepidorhombus species</i>) mullet (<i>Mullus species</i>) pike (<i>Esox lucius</i>) plain bonito (<i>Orcynopsis unicolor</i>) poor cod (<i>Tricopterus minutes</i>) portuguese dogfish (<i>Centroscyrnus coelolepis</i>) rays (<i>Raja species</i>) redfish (<i>Sebastes marinus</i> , <i>S. mentella</i> , <i>S. viviparus</i>) sail fish (<i>Istiophorus platypterus</i>) scabbard fish (<i>Lepidopus caudatus</i> , <i>Aphanopus carbo</i>) seabream, pandora (<i>Pagellus species</i>) shark (all species) snake mackerel or butterfish (<i>Lepidocybium flavobrunneum</i> , <i>Ruvettus pretiosus</i> , <i>Gempylus serpens</i>) sturgeon (<i>Acipenser species</i>) swordfish (<i>Xiphias gladius</i>) tuna (<i>Thunnus species</i> , <i>Euthynnus species</i> , <i>Katsuwonus pelamis</i>)	1,0
3.4	Tin (inorganic)	
3.4.1	Canned foods other than beverages	200
3.4.2	Canned beverages, including fruit juices and vegetable juices	100

Foodstuffs ⁽¹⁾		Maximum levels (mg/kg wet weight)
3.4.3	Canned baby foods and processed cereal-based foods for infants and young children, excluding dried and powdered products ⁽³⁾ ⁽²⁹⁾	50
3.4.4	Canned infant formulae and follow-on formulae (including infant milk and follow-on milk), excluding dried and powdered products ⁽⁸⁾ ⁽²⁹⁾	50
3.4.5	Canned dietary foods for special medical purposes ⁽⁹⁾ ⁽²⁹⁾ intended specifically for infants, excluding dried and powdered products	50

Section 4: 3-monochloropropane-1,2-diol (3-MCPD)

Foodstuffs ⁽¹⁾		Maximum levels (µg/kg)
4.1	Hydrolysed vegetable protein ⁽³⁰⁾	20
4.2	Soy sauce ⁽³⁰⁾	20

Section 5: Dioxins and PCBs ⁽³¹⁾

Foodstuffs		Maximum levels	
		Sum of dioxins (WHO-PCDD/F-TEQ) ⁽³²⁾	Sum of dioxins and dioxin-like PCBs (WHO-PCDD/F-PCB-TEQ) ⁽³²⁾
5.1	Meat and meat products (excluding edible offal) of the following animals ⁽⁶⁾		
	— bovine animals and sheep	3,0 pg/g fat ⁽³³⁾	4,5 pg/g fat ⁽³³⁾
	— poultry	2,0 pg/g fat ⁽³³⁾	4,0 pg/g fat ⁽³³⁾
	— pigs	1,0 pg/g fat ⁽³³⁾	1,5 pg/g fat ⁽³³⁾
5.2	Liver of terrestrial animals referred to in 5.1 ⁽⁶⁾ , and derived products thereof	6,0 pg/g fat ⁽³³⁾	12,0 pg/g fat ⁽³³⁾
5.3	Muscle meat of fish and fishery products and products thereof, excluding eel ⁽²⁵⁾ ⁽³⁴⁾ . The maximum level applies to crustaceans, excluding the brown meat of crab and excluding head and thorax meat of lobster and similar large crustaceans (<i>Nephropidae</i> and <i>Palinuridae</i>)	4,0 pg/g wet weight	8,0 pg/g wet weight
5.4	Muscle meat of eel (<i>Anguilla anguilla</i>) and products thereof	4,0 pg/g wet weight	12,0 pg/g wet weight
5.5	Raw milk ⁽⁶⁾ and dairy products ⁽⁶⁾ , including butterfat	3,0 pg/g fat ⁽³³⁾	6,0 pg/g fat ⁽³³⁾

Foodstuffs		Maximum levels	
		Sum of dioxins (WHO-PCDD/F-TEQ) ⁽³²⁾	Sum of dioxins and dioxin-like PCBs (WHO-PCDD/F-PCB-TEQ) ⁽³²⁾
5.6	Hen eggs and egg products ⁽⁶⁾	3,0 pg/g fat ⁽³³⁾	6,0 pg/g fat ⁽³³⁾
5.7	Fat of the following animals:		
	— bovine animals and sheep	3,0 pg/g fat	4,5 pg/g fat
	— poultry	2,0 pg/g fat	4,0 pg/g fat
	— pigs	1,0 pg/g fat	1,5 pg/g fat
5.8	Mixed animal fats	2,0 pg/g fat	3,0 pg/g fat
5.9	Vegetable oils and fats	0,75 pg/g fat	1,5 pg/g fat
5.10	Marine oils (fish body oil, fish liver oil and oils of other marine organisms intended for human consumption)	2,0 pg/g fat	10,0 pg/g fat

Section 6: Polycyclic aromatic hydrocarbons

Foodstuffs		Maximum levels (µg/kg wet weight)
6.1	Benzo(a)pyrene ⁽³⁵⁾	
6.1.1	Oils and fats (excluding cocoa butter) intended for direct human consumption or use as an ingredient in foods	2,0
6.1.2	Smoked meats and smoked meat products	5,0
6.1.3	Muscle meat of smoked fish and smoked fishery products ⁽²⁵⁾ ⁽³⁶⁾ , excluding bivalve molluscs. The maximum level applies to smoked crustaceans, excluding the brown meat of crab and excluding head and thorax meat of lobster and similar large crustaceans (<i>Nephropidae</i> and <i>Palinuridae</i>)	5,0
6.1.4	Muscle meat of fish ⁽²⁴⁾ ⁽²⁵⁾ , other than smoked fish	2,0
6.1.5	Crustaceans, cephalopods, other than smoked ⁽²⁶⁾ . The maximum level applies to crustaceans, excluding the brown meat of crab and excluding head and thorax meat of lobster and similar large crustaceans (<i>Nephropidae</i> and <i>Palinuridae</i>)	5,0
6.1.6	Bivalve molluscs ⁽²⁶⁾	10,0
6.1.7	Processed cereal-based foods and baby foods for infants and young children ⁽³⁾ ⁽²⁹⁾	1,0
6.1.8	Infant formulae and follow-on formulae, including infant milk and follow-on milk ⁽⁸⁾ ⁽²⁹⁾	1,0
6.1.9	Dietary foods for special medical purposes ⁽⁹⁾ ⁽²⁹⁾ intended specifically for infants	1,0

- (¹) As regards fruits, vegetables and cereals, reference is made to the foodstuffs listed in the relevant category as defined in Regulation (EC) No 396/2005 of the European Parliament and of the Council of 23 February 2005 on maximum residue levels of pesticides in or on food and feed of plant and animal origin and amending Council Directive 91/414/EEC (OJ L 70, 16.3.2005, p. 1) as last amended by Regulation (EC) No 178/2006 (OJ L 29, 2.2.2006, p. 3). This means, *inter alia*, that buckwheat (*Fagopyrum* sp) is included in 'cereals' and buckwheat products are included in 'cereal products'.
- (²) The maximum levels do not apply for fresh spinach to be subjected to processing and which is directly transported in bulk from field to processing plant.
- (³) Foodstuffs listed in this category as defined in Commission Directive 96/5/EC of 16 February 1996 on processed cereal-based foods and baby foods for infants and young children (OJ L 49, 28.2.1996, p. 17) as last amended by Directive 2003/13/EC (OJ L 41, 14.2.2003, p. 33).
- (⁴) The maximum level refers to the products ready to use (marketed as such or after reconstitution as instructed by the manufacturer).
- (⁵) The maximum levels refer to the edible part of groundnuts and nuts. If groundnuts and nuts 'in shell' are analysed, it is assumed when calculating the aflatoxin content all the contamination is on the edible part.
- (⁶) Foodstuffs listed in this category as defined in Regulation (EC) No 853/2004 of the European Parliament and of the Council of 29 April 2004 laying down specific hygiene rules for food of animal origin (OJ L 226, 25.6.2004, p. 22).
- (⁷) The maximum level refers to the dry matter. The dry matter is determined in accordance with Regulation (EC) No 401/2006.
- (⁸) Foodstuffs listed in this category as defined in Commission Directive 91/321/EEC of 14 May 1991 on infant formulae and follow-on formulae (OJ L 175, 4.7.1991, p. 35) as last amended by Directive 2003/14/EC (OJ L 41, 14.2.2003, p. 37).
- (⁹) Foodstuffs listed in this category as defined in Commission Directive 1999/21/EC of 25 March 1999 on dietary foods for special medical purposes (OJ L 91, 7.4.1999, p. 29).
- (¹⁰) The maximum level refers in the case of milk and milk products, to the products ready for use (marketed as such or reconstituted as instructed by the manufacturer) and in the case of products other than milk and milk products, to the dry matter. The dry matter is determined in accordance with Regulation (EC) No 401/2006.
- (¹¹) Foodstuffs listed in this category as defined in Council Regulation (EC) No 1493/1999 of 17 May 1999 on the common organisation of the market in wine (OJ L 179, 14.7.1999, p. 1) as last amended by the Protocol concerning the conditions and arrangements for admission of the Republic of Bulgaria and Romania to the European Union (OJ L 157, 21.6.2005, p. 29).
- (¹²) The maximum level applies to products produced from the 2005 harvest onwards.
- (¹³) Foodstuffs listed in this category as defined in Council Regulation (EEC) No 1601/91 of 10 June 1991 laying down general rules on the definition, description and presentation of aromatised wines, aromatised wine-based drinks and aromatised wine-product cocktails (OJ L 149, 14.6.1991, p. 1) as last amended by the Protocol concerning the conditions and arrangements for admission of the Republic of Bulgaria and Romania to the European Union. The maximum level for OTA applicable to these beverages is function of the proportion of wine and/or grape must present in the finished product.
- (¹⁴) Foodstuffs listed in this category as defined in Council Directive 2001/112/EC of 20 December 2001 relating to fruit juices and certain similar products intended for human consumption (OJ L 10, 12.1.2002, p. 58).
- (¹⁵) Foodstuffs listed in this category as defined in Council Regulation (EEC) No 1576/89 of 29 May 1989 laying down general rules on the definition, description and presentation of spirit drinks (OJ L 160, 12.6.1989, p. 1), as last amended by the Protocol concerning the conditions and arrangements for admission of the Republic of Bulgaria and Romania to the European Union.
- (¹⁶) Infants and young children as defined in Directive 91/321/EEC and Directive 96/5/EC.
- (¹⁷) For the purpose of the application of maximum levels for deoxynivalenol, zearalenone, T-2 and HT-2 toxin established in points 2.4, 2.5 and 2.7 rice is not included in 'cereals' and rice products are not included in 'cereal products'.
- (¹⁸) The maximum level applies to unprocessed cereals placed on the market for first-stage processing. 'First-stage processing' shall mean any physical or thermal treatment, other than drying, of or on the grain. Cleaning, sorting and drying procedures are not considered to be 'first-stage processing' insofar no physical action is exerted on the grain kernel itself and the whole grain remains intact after cleaning and sorting. In integrated production and processing systems, the maximum level applies to the unprocessed cereals in case they are intended for first-stage processing.
- (¹⁹) The maximum level applies to cereals harvested and taken over, as from the 2005/06 marketing year, in accordance with Commission Regulation (EC) No 824/2000 of 19 April 2000 establishing procedures for the taking-over of cereals by intervention agencies and laying down methods of analysis for determining the quality of cereals (OJ L 100, 20.4.2000, p. 31), as last amended by Regulation (EC) No 1068/2005 (OJ L 174, 7.7.2005, p. 65).
- (²⁰) Maximum level shall apply from 1 July 2007.
- (²¹) This category includes also similar products otherwise denominated such as semolina.
- (²²) Pasta (dry) means pasta with a water content of approximately 12 %.

- (23) Maximum level shall apply from 1 October 2007.
- (24) Fish listed in this category as defined in category (a), with the exclusion of fish liver falling under code CN 0302 70 00, of the list in Article 1 of Council Regulation (EC) No 104/2000 (OJ L 17, 21.1.2000, p. 22) as last amended by the Act concerning the conditions of accession of the Czech Republic, the Republic of Estonia, the Republic of Cyprus, the Republic of Latvia, the Republic of Lithuania, the Republic of Hungary, the Republic of Malta, the Republic of Poland, the Republic of Slovenia and the Slovak Republic and the adjustments to the Treaties on which the European Union is founded (OJ L 236, 23.9.2003, p. 33). In case of dried, diluted, processed and/or compound foodstuffs Article 2(1) and 2(2) apply.
- (25) Where fish are intended to be eaten whole, the maximum level shall apply to the whole fish.
- (26) Foodstuffs falling within category (c) and (f) of the list in Article 1 of Regulation (EC) No 104/2000, as appropriate (species as listed in the relevant entry). In case of dried, diluted, processed and/or compound foodstuffs Article 2(1) and 2(2) apply.
- (27) The maximum level applies after washing of the fruit or vegetables and separating the edible part.
- (28) The maximum level applies to products produced from the 2001 fruit harvest onwards.
- (29) The maximum level refers to the product as sold.
- (30) The maximum level is given for the liquid product containing 40 % dry matter, corresponding to a maximum level of 50 µg/kg in the dry matter. The level needs to be adjusted proportionally according to the dry matter content of the products.
- (31) Dioxins (sum of polychlorinated dibenzo-para-dioxins (PCDDs) and polychlorinated dibenzofurans (PCDFs), expressed as World Health Organisation (WHO) toxic equivalent using the WHO-toxic equivalency factors (WHO-TEFs)) and sum of dioxins and dioxin-like PCBs (sum of PCDDs, PCDFs and polychlorinated biphenyls (PCBs), expressed as WHO toxic equivalent using the WHO-TEFs). WHO-TEFs for human risk assessment based on the conclusions of the WHO meeting in Stockholm, Sweden, 15 to 18 June 1997 (Van den Berg et al., (1998) Toxic Equivalency Factors (TEFs) for PCBs, PCDDs, PCDFs for Humans and for Wildlife. Environmental Health Perspectives, 106 (12), 775).

Congener	TEF value	Congener	TEF value
Dibenzo-p-dioxins (PCDDs)		Dioxin-like PCBs: Non-ortho PCBs + Mono-ortho PCBs	
2,3,7,8-TCDD	1	<i>Non-ortho PCBs</i>	
1,2,3,7,8-PeCDD	1	PCB 77	0,0001
1,2,3,4,7,8-HxCDD	0,1	PCB 81	0,0001
1,2,3,6,7,8-HxCDD	0,1	PCB 126	0,1
1,2,3,7,8,9-HxCDD	0,1	PCB 169	0,01
1,2,3,4,6,7,8-HpCDD	0,01		
OCDD	0,0001	<i>Mono-ortho PCBs</i>	
Dibenzofurans (PCDFs)		PCB 105	0,0001
2,3,7,8-TCDF	0,1	PCB 114	0,0005
1,2,3,7,8-PeCDF	0,05	PCB 118	0,0001
2,3,4,7,8-PeCDF	0,5	PCB 123	0,0001
1,2,3,4,7,8-HxCDF	0,1	PCB 156	0,0005
1,2,3,6,7,8-HxCDF	0,1	PCB 157	0,0005
1,2,3,7,8,9-HxCDF	0,1	PCB 167	0,00001
2,3,4,6,7,8-HxCDF	0,1	PCB 189	0,0001
1,2,3,4,6,7,8-HpCDF	0,01		
1,2,3,4,7,8,9-HpCDF	0,01		
OCDF	0,0001		

Abbreviations used: 'T' = tetra; 'Pe' = penta; 'Hx' = hexa; 'Hp' = hepta; 'O' = octa; 'CDD' = chlorodibenzodioxin; 'CDF' = chlorodibenzofuran; 'CB' = chlorobiphenyl.

- (32) Upperbound concentrations: Upperbound concentrations are calculated on the assumption that all the values of the different congeners below the limit of quantification are equal to the limit of quantification.
- (33) The maximum level is not applicable for foods containing < 1 % fat.
- (34) Foodstuffs listed in this category as defined in categories (a), (b), (c), (e) and (f) of the list in Article 1 of Regulation (EC) No 104/2000 with the exclusion of fish liver falling under code CN 0302 70 00.
- (35) Benzo(a)pyrene, for which maximum levels are listed, is used as a marker for the occurrence and effect of carcinogenic polycyclic aromatic hydrocarbons. These measures therefore provide full harmonisation on polycyclic aromatic hydrocarbons in the listed foods across the Member States.
- (36) Foodstuffs listed in this category as defined in categories (b), (c), and (f) of the list in Article 1 of Regulation (EC) No 104/2000.

Annex III:

Official Journal of the European Union

**COMMISSION REGULATION (EC) No 333/2007
of 28 March 2007**

**laying down the methods of sampling and analysis for the official control of the levels of lead,
cadmium, mercury, inorganic tin, 3-MCPD and benzo(a)pyrene in foodstuffs**

COMMISSION REGULATION (EC) No 333/2007**of 28 March 2007****laying down the methods of sampling and analysis for the official control of the levels of lead, cadmium, mercury, inorganic tin, 3-MCPD and benzo(a)pyrene in foodstuffs****(Text with EEA relevance)**

THE COMMISSION OF THE EUROPEAN COMMUNITIES,

Having regard to the Treaty establishing the European Community,

Having regard to Regulation (EC) No 882/2004 of the European Parliament and of the Council of 29 April 2004 on official controls performed to ensure the verification of compliance with feed and food law, animal health and animal welfare rules ⁽¹⁾, in particular Article 11(4) thereof,

Whereas:

(1) Council Regulation (EEC) No 315/93 of 8 February 1993 laying down Community procedures for contaminants in food ⁽²⁾ provides that maximum levels must be set for certain contaminants in foodstuffs in order to protect public health.

(2) Commission Regulation (EC) No 1881/2006 of 19 December 2006 setting maximum levels for certain contaminants in foodstuffs ⁽³⁾ establishes maximum levels for lead, cadmium, mercury, inorganic tin, 3-MCPD and benzo(a)pyrene in certain foodstuffs.

(3) Regulation (EC) No 882/2004 lays down general principles for the official control of foodstuffs. However, in certain cases more specific provisions are necessary to ensure that official controls are performed in a harmonised manner in the Community.

(4) The methods of sampling and analysis to be used for the official control of levels of lead, cadmium, mercury, 3-MCPD, inorganic tin and benzo(a)pyrene in certain foodstuffs are established in Commission Directive 2001/22/EC of 8 March 2001 laying down the sampling methods and the methods of analysis for the

official control of the levels of lead, cadmium, mercury and 3-MCPD in foodstuffs ⁽⁴⁾, Commission Directive 2004/16/EC of 12 February 2004 laying down the sampling methods and the methods of analysis for the official control of the levels of tin in canned foods ⁽⁵⁾ and Commission Directive 2005/10/EC of 4 February 2005 laying down the sampling methods and the methods of analysis for the official control of the levels of benzo(a)pyrene in foodstuffs ⁽⁶⁾, respectively.

(5) Numerous provisions on sampling and analysis for the official control of the levels of lead, cadmium, mercury, inorganic tin, 3-MCPD and benzo(a)pyrene in foodstuffs are similar. Therefore, in the interest of clarity of legislation, it is appropriate to merge those provisions in one single legislative act.

(6) Directives 2001/22/EC, 2004/16/EC and 2005/10/EC should therefore be repealed and replaced by a new Regulation.

(7) The measures provided for in this Regulation are in accordance with the opinion of the Standing Committee for the Food Chain and Animal Health,

HAS ADOPTED THIS REGULATION:

Article 1

1. Sampling and analysis for the official control of the levels of lead, cadmium, mercury, inorganic tin, 3-MCPD and benzo(a)pyrene listed in sections 3, 4 and 6 of the Annex to Regulation (EC) No 1881/2006 shall be carried out in accordance with the Annex to this Regulation.

2. Paragraph 1 shall apply without prejudice to the provisions of Regulation (EC) No 882/2004.

⁽¹⁾ OJ L 165, 30.4.2004, p. 1, corrected by OJ L 191, 28.5.2004, p. 1. Regulation as amended by Commission Regulation (EC) No 1791/2006 (OJ L 363, 20.12.2006, p. 1).

⁽²⁾ OJ L 37, 13.2.1993, p. 1. Regulation as amended by Regulation (EC) No 1882/2003 of the European Parliament and of the Council (OJ L 284, 31.10.2003, p. 1).

⁽³⁾ OJ L 364, 20.12.2006, p. 5.

⁽⁴⁾ OJ L 77, 16.3.2001, p. 14. Directive as last amended by Directive 2005/4/EC (OJ L 19, 21.1.2005, p. 50).

⁽⁵⁾ OJ L 42, 13.2.2004, p. 16.

⁽⁶⁾ OJ L 34, 8.2.2005, p. 15.

Article 2

Directives 2001/22/EC, 2004/16/EC and 2005/10/EC are hereby repealed.

References to the repealed Directives shall be construed as references to this Regulation.

Article 3

This Regulation shall enter into force on the 20th day following its publication in the *Official Journal of the European Union*.

It shall apply from 1 June 2007.

This Regulation shall be binding in its entirety and directly applicable in all Member States.

Done at Brussels, 28 March 2007.

For the Commission
Markos KYPRIANOU
Member of the Commission

ANNEX

PART A

DEFINITIONS

For the purposes of this Annex, the following definitions shall apply:

- 'lot': an identifiable quantity of food delivered at one time and determined by the official to have common characteristics, (such as origin, variety, type of packing, packer, consignor or markings). In the case of fish, also the size of fish shall be comparable;
- 'sublot': designated part of a large lot in order to apply the sampling method on that designated part. Each sublot must be physically separated and identifiable;
- 'incremental sample': a quantity of material taken from a single place in the lot or sublot;
- 'aggregate sample': the combined total of all the incremental samples taken from the lot or sublot; aggregate samples shall be considered as representative of the lots or sublots from which they are taken;
- 'laboratory sample': a sample intended for the laboratory.

PART B

SAMPLING METHODS**B.1. GENERAL PROVISIONS****B.1.1. Personnel**

Sampling shall be performed by an authorised person as designated by the Member State.

B.1.2. Material to be sampled

Each lot or sublot which is to be examined shall be sampled separately.

B.1.3. Precautions to be taken

In the course of sampling, precautions shall be taken to avoid any changes which would affect the levels of contaminants, adversely affect the analytical determination or make the aggregate samples unrepresentative.

B.1.4. Incremental samples

As far as possible, incremental samples shall be taken at various places distributed throughout the lot or sublot. Departure from such procedure shall be recorded in the record provided for under point B.1.8. of this Annex.

B.1.5. Preparation of the aggregate sample

The aggregate sample shall be made up by combining the incremental samples.

B.1.6. Samples for enforcement, defence and referee purposes

The samples for enforcement, defence and referee purposes shall be taken from the homogenised aggregate sample unless this conflicts with the rules of the Member States as regards the rights of the food business operator.

B.1.7. Packaging and transmission of samples

Each sample shall be placed in a clean, inert container offering adequate protection from contamination, from loss of analytes by adsorption to the internal wall of the container and against damage in transit. All necessary precautions shall be taken to avoid any change in composition of the sample which might arise during transportation or storage.

B.1.8. Sealing and labelling of samples

Each sample taken for official use shall be sealed at the place of sampling and identified following the rules of the Member States.

A record shall be kept of each sampling, permitting each lot or subplot to be identified unambiguously (reference to the lot number shall be given) and giving the date and place of sampling together with any additional information likely to be of assistance to the analyst.

B.2. SAMPLING PLANS

Large lots shall be divided into sublots on condition that the subplot may be separated physically. For products traded in bulk consignments (e.g. cereals), Table 1 shall apply. For other products Table 2 shall apply. Taking into account that the weight of the lot is not always an exact multiple of the weight of the sublots, the weight of the subplot may exceed the mentioned weight by a maximum of 20 %.

The aggregate sample shall be at least 1 kg or 1 litre except where it is not possible e.g. when the sample consists of 1 package or unit.

The minimum number of incremental samples to be taken from the lot or subplot shall be as given in Table 3.

In the case of bulk liquid products the lot or subplot shall be thoroughly mixed in so far as possible and in so far it does not affect the quality of the product, by either manual or mechanical means immediately prior to sampling. In this case, a homogeneous distribution of contaminants is assumed within a given lot or subplot. It is therefore sufficient to take three incremental samples from a lot or subplot to form the aggregate sample.

The incremental samples shall be of similar weight. The weight of an incremental sample shall be at least 100 grams or 100 millilitres, resulting in an aggregate sample of at least about 1 kg or 1 litre. Departure from this method shall be recorded in the record provided for under point B.1.8. of this Annex.

Table 1

Subdivision of lots into sublots for products traded in bulk consignments

Lot weight (ton)	Weight or number of sublots
≥ 1 500	500 tonnes
> 300 and < 1 500	3 sublots
≥ 100 and ≤ 300	100 tonnes
< 100	—

Table 2

Subdivision of lots into sublots for other products

Lot weight (ton)	Weight or number of sublots
≥ 15	15 to 30 tonnes
< 15	—

Table 3

Minimum number of incremental samples to be taken from the lot or subplot

Weight or volume of lot/sublot (in kg or litre)	Minimum number of incremental samples to be taken
< 50	3
≥ 50 and ≤ 500	5
> 500	10

If the lot or subplot consists of individual packages or units, then the number of packages or units which shall be taken to form the aggregate sample is given in Table 4.

Table 4

Number of packages or units (incremental samples) which shall be taken to form the aggregate sample if the lot or subplot consists of individual packages or units

Number of packages or units in the lot/sublot	Number of packages or units to be taken
≤ 25	at least one package or unit
26 to 100	about 5 %, at least two packages or units
> 100	about 5 %, at maximum 10 packages or units

The maximum levels for inorganic tin apply to the contents of each can, but for practical reasons it is necessary to use an aggregate sampling approach. If the result of the test for an aggregate sample of cans is less than, but close to, the maximum level of inorganic tin and if it is suspected that individual cans might exceed the maximum level, then it might be necessary to conduct further investigations.

B.3. SAMPLING AT RETAIL STAGE

Sampling of foodstuffs at retail stage shall be done where possible in accordance with the sampling provisions set out in points B.1. and B.2. of this Annex.

Where this is not possible, an alternative method of sampling at retail stage may be used provided that it ensures sufficient representativeness for the sampled lot or subplot.

PART C**SAMPLE PREPARATION AND ANALYSIS****C.1. LABORATORY QUALITY STANDARDS**

Laboratories shall comply with the provisions of Article 12 of Regulation (EC) No 882/2004 ⁽¹⁾.

Laboratories shall participate in appropriate proficiency testing schemes which comply with the 'International Harmonised Protocol for the Proficiency Testing of (Chemical) Analytical Laboratories' ⁽²⁾ developed under the auspices of IUPAC/ISO/AOAC.

Laboratories shall be able to demonstrate that they have internal quality control procedures in place. Examples of these are the 'ISO/AOAC/IUPAC Guidelines on Internal Quality Control in Analytical Chemistry Laboratories' ⁽³⁾.

⁽¹⁾ As amended by Article 18 of Commission Regulation (EC) No 2076/2005 (OJ L 338, 22.12.2005, p. 83).

⁽²⁾ The international harmonized protocol for the proficiency testing of analytical chemistry laboratories' by M. Thompson, S.L.R. Ellison and R. Wood, Pure Appl. Chem., 2006, 78, 145-96.

⁽³⁾ Edited by M. Thompson and R. Wood, Pure Appl. Chem., 1995, 67, 649-666.

Wherever possible the trueness of analysis shall be estimated by including suitable certified reference materials in the analysis.

C.2. SAMPLE PREPARATION

C.2.1. Precautions and general considerations

The basic requirement is to obtain a representative and homogeneous laboratory sample without introducing secondary contamination.

All of the sample material received by the laboratory shall be used for the preparation of the laboratory sample.

Compliance with maximum levels laid down in Regulation (EC) No 1881/2006 shall be established on the basis of the levels determined in the laboratory samples.

C.2.2. Specific sample preparation procedures

C.2.2.1. Specific procedures for lead, cadmium, mercury and inorganic tin

The analyst shall ensure that samples do not become contaminated during sample preparation. Wherever possible, apparatus and equipment coming into contact with the sample shall not contain those metals to be determined and be made of inert materials e.g. plastics such as polypropylene, polytetrafluoroethylene (PTFE) etc. These should be acid cleaned to minimise the risk of contamination. High quality stainless steel may be used for cutting edges.

There are many satisfactory specific sample preparation procedures which may be used for the products under consideration. Those described in the CEN Standard 'Foodstuffs — Determination of trace elements — Performance criteria, general considerations and sample preparation' ⁽¹⁾ have been found to be satisfactory but others may be equally valid.

In the case of inorganic tin, care shall be taken to ensure that all the material is taken into solution as losses are known to occur readily, particularly because of hydrolysis to insoluble hydrated Sn(IV) oxide species.

C.2.2.2. Specific procedures for benzo(a)pyrene

The analyst shall ensure that samples do not become contaminated during sample preparation. Containers shall be rinsed with high purity acetone or hexane before use to minimise the risk of contamination. Wherever possible, apparatus and equipment coming into contact with the sample shall be made of inert materials such as aluminium, glass or polished stainless steel. Plastics such as polypropylene or PTFE shall be avoided because the analyte can adsorb onto these materials.

C.2.3. Treatment of the sample as received in the laboratory

The complete aggregate sample shall be finely ground (where relevant) and thoroughly mixed using a process that has been demonstrated to achieve complete homogenisation.

C.2.4. Samples for enforcement, defence and referee purposes

The samples for enforcement, defence and referee purposes shall be taken from the homogenised material unless this conflicts with the rules of the Member States on sampling as regards the rights of the food business operator.

⁽¹⁾ Standard EN 13804:2002, 'Foodstuffs — Determination of trace elements — Performance criteria, general considerations and sample preparation', CEN, Rue de Stassart 36, B-1050 Brussels.

C.3. METHODS OF ANALYSIS

C.3.1. Definitions

The following definitions shall apply:

- 'r' = Repeatability the value below which the absolute difference between single test results obtained under repeatability conditions (i.e., same sample, same operator, same apparatus, same laboratory, and short interval of time) may be expected to lie within a specific probability (typically 95 %) and hence $r = 2,8 \times s_r$.
- 's_r' = Standard deviation calculated from results generated under repeatability conditions.
- 'RSD_r' = Relative standard deviation calculated from results generated under repeatability conditions $[(s_r/\bar{x}) \times 100]$.
- 'R' = Reproducibility the value below which the absolute difference between single test results obtained under reproducibility conditions (i.e., on identical material obtained by operators in different laboratories, using the standardised test method), may be expected to lie within a certain probability (typically 95 %); $R = 2,8 \times s_R$.
- 's_R' = Standard deviation, calculated from results under reproducibility conditions.
- 'RSD_R' = Relative standard deviation calculated from results generated under reproducibility conditions $[(s_R/\bar{x}) \times 100]$.
- 'LOD' = Limit of detection, smallest measured content, from which it is possible to deduce the presence of the analyte with reasonable statistical certainty. The limit of detection is numerically equal to three times the standard deviation of the mean of blank determinations ($n > 20$).
- 'LOQ' = Limit of quantification, lowest content of the analyte which can be measured with reasonable statistical certainty. If both accuracy and precision are constant over a concentration range around the limit of detection, then the limit of quantification is numerically equal to six or 10 times the standard deviation of the mean of blank determinations ($n > 20$).
- 'HORRAT_r' = The observed RSD_r divided by the RSD_r value estimated from the Horwitz equation ⁽¹⁾ using the assumption $r = 0,66R$.
- 'HORRAT_R' = The observed RSD_R value divided by the RSD_R value calculated from the Horwitz equation.
- 'u' = Standard measurement uncertainty.
- 'U' = The expanded measurement uncertainty, using a coverage factor of 2 which gives a level of confidence of approximately 95 % ($U = 2u$).
- 'U_f' = Maximum standard measurement uncertainty.

C.3.2. General requirements

Methods of analysis used for food control purposes shall comply with the provisions of points 1 and 2 of Annex III to Regulation (EC) No 882/2004.

Methods of analysis for total tin are appropriate for official control on inorganic tin levels.

For the analysis of lead in wine, Commission Regulation (EEC) No 2676/90 ⁽²⁾ lays down the method to be used in chapter 35 of its Annex.

C.3.3. Specific requirements

C.3.3.1. Performance criteria

Where no specific methods for the determination of contaminants in foodstuffs are prescribed at Community level, laboratories may select any validated method of analysis (where possible, the validation shall include a certified reference material) provided the selected method meets the specific performance criteria set out in Tables 5 to 7.

⁽¹⁾ M. Thompson, Analyst, 2000, 125, 385-386.

⁽²⁾ OJ L 272, 3.10.1990, p. 1. Regulation as last amended by Regulation (EC) No 1293/2005 (OJ L 205, 6.8.2005, p. 12).

Table 5

Performance criteria for methods of analysis for lead, cadmium, mercury and inorganic tin

Parameter	Value/Comment
Applicability	Foods specified in Regulation (EC) No 1881/2006
LOD	For inorganic tin less than 5 mg/kg. For other elements less than one tenth of the maximum level in Regulation (EC) No 1881/2006, except if the maximum level for lead is less than 100 µg/kg. For the latter, less than one fifth of the maximum level
LOQ	For inorganic tin less than 10 mg/kg. For other elements less than one fifth of the maximum level in Regulation (EC) No 1881/2006, except if the maximum level for lead is less than 100 µg/kg. For the latter, less than two fifth of the maximum level
Precision	HORRAT _r or HORRAT _R values of less than 2
Recovery	The provisions of point D.1.2. apply
Specificity	Free from matrix or spectral interferences

Table 6

Performance criteria for methods of analysis for 3-MCPD

Criterion	Recommended Value	Concentration
Field blanks	Less than the LOD	—
Recovery	75 to 110 %	all
LOD	5 µg/kg (or less) on a dry matter basis	
LOQ	10 µg/kg (or less) on a dry matter basis	—
Precision	< 4 µg/kg	20 µg/kg
	< 6 µg/kg	30 µg/kg
	< 7 µg/kg	40 µg/kg
	< 8 µg/kg	50 µg/kg
	< 15 µg/kg	100 µg/kg

Table 7

Performance criteria for methods of analysis for benzo(a)pyrene

Parameter	Value/Comment
Applicability	Foods specified in Regulation (EC) No 1881/2006
LOD	Less than 0,3 µg/kg
LOQ	Less than 0,9 µg/kg
Precision	HORRAT _r or HORRAT _R values of less than 2
Recovery	50 to 120 %
Specificity	Free from matrix or spectral interferences, verification of positive detection

C.3.3.2. 'Fitness-for-purpose' approach

Where a limited number of fully validated methods of analysis exist, alternatively, a 'fitness-for-purpose' approach may be used to assess the suitability of the method of analysis. Methods suitable for official control must produce results with standard measurement uncertainties less than the maximum standard measurement uncertainty calculated using the formula below:

$$U_f = \sqrt{(\text{LOD}/2)^2 + (\alpha C)^2}$$

where:

U_f is the maximum standard measurement uncertainty ($\mu\text{g}/\text{kg}$);

LOD is the limit of detection of the method ($\mu\text{g}/\text{kg}$);

C is the concentration of interest ($\mu\text{g}/\text{kg}$);

α is a numeric factor to be used depending on the value of C . The values to be used are given in Table 8.

Table 8

Numeric values to be used for α as constant in formula set out in this point, depending on the concentration of interest

C ($\mu\text{g}/\text{kg}$)	α
≤ 50	0,2
51 to 500	0,18
501 to 1 000	0,15
1 001 to 10 000	0,12
$> 10\ 000$	0,1

PART D

REPORTING AND INTERPRETATION OF RESULTS

D.1. REPORTING

D.1.1. Expression of results

The results shall be expressed in the same units and with the same number of significant figures as the maximum levels laid down in Regulation (EC) No 1881/2006.

D.1.2. Recovery calculations

If an extraction step is applied in the analytical method, the analytical result shall be corrected for recovery. In this case the level of recovery must be reported.

In case no extraction step is applied in the analytical method (e.g. in case of metals), the result may be reported uncorrected for recovery if evidence is provided by ideally making use of suitable certified reference material that the certified concentration allowing for the measurement uncertainty is achieved (i.e. high accuracy of the measurement). In case the result is reported uncorrected for recovery this shall be mentioned.

D.1.3. Measurement uncertainty

The analytical result shall be reported as $x \pm U$ whereby x is the analytical result and U is the expanded measurement uncertainty, using a coverage factor of 2 which gives a level of confidence of approximately 95 % ($U = 2u$).

The analyst shall note the 'Report on the relationship between analytical results, measurement uncertainty, recovery factors and the provisions in EU food and feed legislation' ⁽¹⁾.

D.2. INTERPRETATION OF RESULTS**D.2.1. Acceptance of a lot/sublot**

The lot or subplot is accepted if the analytical result of the laboratory sample does not exceed the respective maximum level as laid down in Regulation (EC) No 1881/2006 taking into account the expanded measurement uncertainty and correction of the result for recovery if an extraction step has been applied in the analytical method used.

D.2.2. Rejection of a lot/sublot

The lot or subplot is rejected if the analytical result of the laboratory sample exceeds beyond reasonable doubt the respective maximum level as laid down in Regulation (EC) No 1881/2006 taking into account the expanded measurement uncertainty and correction of the result for recovery if an extraction step has been applied in the analytical method used.

D.2.3. Applicability

The present interpretation rules shall apply for the analytical result obtained on the sample for enforcement. In case of analysis for defence or reference purposes, the national rules shall apply.

⁽¹⁾ http://europa.eu.int/comm/food/food/chemicalsafety/contaminants/sampling_en.htm

Annex IV:

Official Journal of the European Union

**COMMISSION REGULATION (EU) No 836/2011
of 19 August 2011**

**amending Regulation (EC) No 333/2007 laying down the methods of sampling and analysis for
the official control of the levels of lead, cadmium, mercury, inorganic tin, 3-MCPD and
benzo(a)pyrene in foodstuffs**

COMMISSION REGULATION (EU) No 836/2011

of 19 August 2011

amending Regulation (EC) No 333/2007 laying down the methods of sampling and analysis for the official control of the levels of lead, cadmium, mercury, inorganic tin, 3-MCPD and benzo(a)pyrene in foodstuffs

(Text with EEA relevance)

THE EUROPEAN COMMISSION,

Having regard to the Treaty on the Functioning of the European Union,

Having regard to Regulation (EC) No 882/2004 of the European Parliament and of the Council of 29 April 2004 on official controls performed to ensure the verification of compliance with feed and food law, animal health and animal welfare rules ⁽¹⁾, in particular Article 11(4) thereof,

Whereas:

(1) Commission Regulation (EC) No 1881/2006 of 19 December 2006 setting maximum levels for certain contaminants in foodstuffs ⁽²⁾ established, inter alia, maximum levels for the contaminant benzo(a)pyrene.

(2) The Scientific Panel on Contaminants in the Food Chain of the European Food Safety Authority (EFSA) adopted an opinion on Polycyclic Aromatic Hydrocarbons in Food on 9 June 2008 ⁽³⁾. The EFSA concluded that benzo(a)pyrene is not a suitable marker for the occurrence of polycyclic aromatic hydrocarbons (PAH) in food and that a system of four specific substances or eight specific substances would be the most suitable markers of PAH in food. The EFSA also concluded that a system of eight substances would not provide much added value compared to a system of four substances.

(3) As a consequence Commission Regulation (EU) No 835/2011 ⁽⁴⁾ amended Regulation (EC) No 1881/2006 in order to set maximum levels for the sum of four polycyclic aromatic hydrocarbons (benzo(a)pyrene, benz(a)anthracene, benzo(b)fluoranthene and chrysene).

(4) Commission Regulation (EC) No 333/2007 ⁽⁵⁾ lays down analytical performance criteria only for benzo(a)pyrene. It is therefore necessary to lay down analytical performance criteria for the other three substances for which maximum levels are now set out in Regulation (EC) No 1881/2006.

(5) The European Union Reference Laboratory for Polycyclic Aromatic Hydrocarbons (EU-RL PAH) in collaboration with the national reference laboratories carried out a survey among official control laboratories to assess which analytical performance criteria would be achievable for benzo(a)pyrene, benz(a)anthracene, benzo(b)fluoranthene and chrysene in relevant food matrices. The outcome of this survey was summarised by the EU-RL PAH in the Report on 'Performance characteristics of analysis methods for the determination of 4 polycyclic aromatic hydrocarbons in food' ⁽⁶⁾. The results of the survey show that the analytical performance criteria currently applicable to benzo(a)pyrene are also suitable for the other three substances.

(6) Experience acquired while implementing Regulation (EC) No 333/2007 revealed that in some cases the current sampling provisions may be impracticable or may lead to unacceptable economic damage to the sampled lot. For such cases, departure from the sampling procedures should be allowed, provided that sampling remains sufficiently representative of the sampled lot or subplot and that the procedure used is fully documented. For sampling at the retail stage, flexibility to depart from the sampling procedures existed already. The provisions for sampling at retail stage should be aligned with the general sampling procedures.

(7) More detailed provisions are needed as regards the material of sampling containers when samples are taken for PAH analysis. Plastic containers are widely used by enforcement authorities, but they are not suitable when sampling is carried out for PAH analysis, as the PAH content of the sample can be altered by these materials.

(8) Clarification is needed for some aspects of the specific requirements for analytical methods, in particular the requirements regarding the use of the performance criteria and the 'fitness-for-purpose' approach. Furthermore, the presentation of the tables with the performance criteria should be modified to appear more uniform across all analytes.

(9) Regulation (EC) No 333/2007 should therefore be amended accordingly. Since Regulation (EU) No 835/2011 and this Regulation are inter-linked, both Regulations should become applicable on the same date.

⁽¹⁾ OJ L 165, 30.4.2004, p. 1.

⁽²⁾ OJ L 364, 20.12.2006, p. 5.

⁽³⁾ The EFSA Journal (2008) 724, p. 1.

⁽⁴⁾ See page 4 of this Official Journal.

⁽⁵⁾ OJ L 88, 29.3.2007, p. 29.

⁽⁶⁾ JRC Report 59046, 2010.

(10) The measures provided for in this Regulation are in accordance with the opinion of the Standing Committee on the Food Chain and Animal Health and neither the European Parliament nor the Council have opposed them,

HAS ADOPTED THIS REGULATION:

Article 1

Regulation (EC) No 333/2007 is amended as follows:

(1) the title is replaced by the following:

'Commission Regulation (EC) No 333/2007 of 28 March 2007 laying down the methods of sampling and analysis for the official control of the levels of lead, cadmium, mercury, inorganic tin, 3-MCPD and polycyclic aromatic hydrocarbons in foodstuffs';

(2) in Article 1, paragraph 1 is replaced by the following:

'1. Sampling and analysis for the official control of the levels of lead, cadmium, mercury, inorganic tin, 3-MCPD and polycyclic aromatic hydrocarbons ("PAH") listed in Sections 3, 4 and 6 of the Annex to Regulation (EC) No 1881/2006 shall be carried out in accordance with the Annex to this Regulation.;

(3) the Annex is amended in accordance with the Annex to this Regulation.

Article 2

This Regulation shall enter into force on the 20th day following its publication in the *Official Journal of the European Union*.

It shall apply from 1 September 2012.

This Regulation shall be binding in its entirety and directly applicable in all Member States.

Done at Brussels, 19 August 2011.

For the Commission

The President

José Manuel BARROSO

ANNEX

The Annex to Regulation (EC) No 333/2007 is amended as follows:

- (1) in point B.1.7 'Packaging and transmission of samples', the following second paragraph is added:

'In case of sampling for PAH analysis plastic containers shall be avoided if possible as they could alter the PAH content of the sample. Inert, PAH-free glass containers, adequately protecting the sample from light, shall be used wherever possible. Where this is practically impossible, at least direct contact of the sample with plastics shall be avoided, e.g. in case of solid samples by wrapping the sample in aluminium foil before placing it in the sampling container.';

- (2) points B.2 and B.3 are replaced by the following:

B.2. SAMPLING PLANS

B.2.1. Division of lots into sublots

Large lots shall be divided into sublots on condition that the subplot may be separated physically. For products traded in bulk consignments (e.g. cereals) Table 1 shall apply. For other products Table 2 shall apply. Taking into account that the weight of the lot is not always an exact multiple of the weight of the sublots, the weight of the subplot may exceed the mentioned weight by a maximum of 20 %.

B.2.2. Number of incremental samples

The aggregate sample shall be at least 1 kg or 1 litre except where it is not possible, e.g. when the sample consists of 1 package or unit.

The minimum number of incremental samples to be taken from the lot or subplot shall be as given in Table 3.

In the case of bulk liquid products the lot or subplot shall be thoroughly mixed in so far as possible and in so far it does not affect the quality of the product, by either manual or mechanical means immediately prior to sampling. In this case, a homogeneous distribution of contaminants is assumed within a given lot or subplot. It is therefore sufficient to take three incremental samples from a lot or subplot to form the aggregate sample.

The incremental samples shall be of similar weight/volume. The weight/volume of an incremental sample shall be at least 100 grams or 100 millilitres, resulting in an aggregate sample of at least about 1 kg or 1 litre. Departure from this method shall be recorded in the record provided for under point B.1.8 of this Annex.

Table 1

Subdivision of lots into sublots for products traded in bulk consignments

Lot weight (ton)	Weight or number of sublots
≥ 1 500	500 tonnes
> 300 and < 1 500	3 sublots
≥ 100 and ≤ 300	100 tonnes
< 100	—

Table 2

Subdivision of lots into sublots for other products

Lot weight (ton)	Weight or number of sublots
≥ 15	15-30 tonnes
< 15	—

Table 3

Minimum number of incremental samples to be taken from the lot or subplot

Weight or volume of lot/sublot (in kg or litre)	Minimum number of incremental samples to be taken
< 50	3
≥ 50 and ≤ 500	5
> 500	10

If the lot or subplot consists of individual packages or units, then the number of packages or units which shall be taken to form the aggregate sample is given in Table 4.

Table 4

Number of packages or units (incremental samples) which shall be taken to form the aggregate sample if the lot or subplot consists of individual packages or units

Number of packages or units in the lot/sublot	Number of packages or units to be taken
≤ 25	at least 1 package or unit
26-100	about 5 %, at least 2 packages or units
> 100	about 5 %, at maximum 10 packages or units

The maximum levels for inorganic tin apply to the contents of each can, but for practical reasons it is necessary to use an aggregate sampling approach. If the result of the test for an aggregate sample of cans is less than but close to the maximum level of inorganic tin and if it is suspected that individual cans might exceed the maximum level, then it might be necessary to conduct further investigations.

Where it is not possible to carry out the method of sampling set out in this chapter because of the unacceptable commercial consequences (e.g. because of packaging forms, damage to the lot, etc.) or where it is practically impossible to apply the abovementioned method of sampling, an alternative method of sampling may be applied provided that it is sufficiently representative for the sampled lot or subplot and is fully documented.

B.2.3. Specific provisions for the sampling of large fish arriving in large lots

In case the lot or subplot to be sampled contains large fishes (individual fishes weighing more than about 1 kg) and the lot or subplot weighs more than 500 kg, the incremental sample shall consist of the middle part of the fish. Each incremental sample shall weigh at least 100 g.

B.3. SAMPLING AT RETAIL STAGE

Sampling of foodstuffs at retail stage shall be done where possible in accordance with the sampling provisions set out in point B.2.2 of this Annex.

Where it is not possible to carry out the method of sampling set out in point B.2.2 because of the unacceptable commercial consequences (e.g. because of packaging forms, damage to the lot, etc.) or where it is practically impossible to apply the abovementioned method of sampling, an alternative method of sampling may be applied provided that it is sufficiently representative for the sampled lot or subplot and is fully documented.;

- (3) in the first paragraph of point C.1 'Laboratory Quality Standards', footnote 1 is deleted;
- (4) in point C.2.2.1 'Specific procedures for lead, cadmium, mercury and inorganic tin', the second paragraph is replaced by the following:

There are many satisfactory specific sample preparation procedures which may be used for the products under consideration. For those aspects not specifically covered by this Regulation, the CEN Standard "Foodstuffs - Determination of trace elements – Performance criteria, general considerations and sample preparation"⁽¹⁾ has been found to be satisfactory but other sample preparation methods may be equally valid.;

- (5) point C.2.2.2 is replaced by the following:

'C.2.2.2. Specific procedures for polycyclic aromatic hydrocarbons

The analyst shall ensure that samples do not become contaminated during sample preparation. Containers shall be rinsed with high purity acetone or hexane before use to minimise the risk of contamination. Wherever possible, apparatus and equipment coming into contact with the sample shall be made of inert materials such as aluminium, glass or polished stainless steel. Plastics such as polypropylene or PTFE shall be avoided because the analytes can adsorb onto these materials.;

(6) point C.3.1 'Definitions' is amended as follows:

(a) the definition for 'HORRAT_r' is replaced by the following:

'HORRAT (*)_r = The observed RSD_r divided by the RSD_r value estimated from the (modified) Horwitz equation (**) (cf. point C.3.3.1 ("Notes to the performance criteria")) using the assumption $r = 0,66 R$.

(*) Horwitz W. and Albert, R., 2006, The Horwitz Ratio (HorRat): A useful Index of Method Performance with respect to Precision, Journal of AOAC International, Vol. 89, 1095-1109.

(**) M. Thompson, Analyst, 2000, p. 125 and 385-386.'

(b) the definition for 'HORRAT_R' is replaced by the following:

'HORRAT (*)_R = The observed RSD_R divided by the RSD_R value estimated from the (modified) Horwitz equation (**) (cf. point C.3.3.1 ("Notes to the performance criteria")).

(*) Horwitz W. and Albert, R., 2006, The Horwitz Ratio (HorRat): A useful Index of Method Performance with respect to Precision, Journal of AOAC International, Vol. 89, 1095-1109.

(**) M. Thompson, Analyst, 2000, p. 125 and 385-386.'

(c) the definition for 'u' is replaced by the following:

'u = Combined standard measurement uncertainty obtained using the individual standard measurement uncertainties associated with the input quantities in a measurement model (*)

(*) International vocabulary of metrology – Basic and general concepts and associated terms (VIM), JCGM 200:2008.;

(7) point C.3.2 is replaced by the following:

'C.3.2 General requirements

Methods of analysis used for food control purposes shall comply with the provisions of Annex III to Regulation (EC) No 882/2004.

Methods for analysis for total tin are appropriate for official control on inorganic tin levels.

For the analysis of lead in wine, the methods and rules established by the OIV (*) apply in accordance with Article 31 of Council Regulation (EC) No 479/2008 (**).

(*) Organisation internationale de la vigne et du vin.

(**) Council Regulation (EC) No 479/2008 of 29 April 2008 on the common organisation of the market in wine amending Regulations (EC) No 1493/1999, (EC) No 1782/2003, (EC) No 1290/2005, (EC) No 3/2008 and repealing Regulations (EEC) No 2392/86 and (EC) No 1493/1999 (OJ L 148, 6.6.2008, p. 1).;

(8) point C.3.3.1 is replaced by the following:

'C.3.3.1. Performance criteria

Where no specific methods for the determination of contaminants in foodstuffs are prescribed at European Union level, laboratories may select any validated method of analysis for the respective matrix provided that the selected method meets the specific performance criteria set out in Tables 5, 6 and 7.

It is recommended that fully validated methods (i.e. methods validated by collaborative trial for the respective matrix) are used where appropriate and available. Other suitable validated methods (e.g. in-house validated methods for the respective matrix) may also be used provided that they fulfil the performance criteria set out in Tables 5, 6 and 7.

Where possible, the validation of in-house validated methods shall include a certified reference material.

- (a) Performance criteria for methods of analysis for lead, cadmium, mercury and inorganic tin:

Table 5

Parameter	Criterion		
Applicability	Foods specified in Regulation (EC) No 1881/2006		
Specificity	Free from matrix or spectral interferences		
Repeatability (RSD _r)	HORRAT _r less than 2		
Reproducibility (RSD _R)	HORRAT _R less than 2		
Recovery	The provisions of point D.1.2 apply		
	Inorganic tin	Lead, cadmium, mercury	
		ML is < 0,100 mg/kg	ML is ≥ 0,100 mg/kg
LOD	≤ 5 mg/kg	≤ one fifth of the ML	≤ one tenth of the ML
LOQ	≤ 10 mg/kg	≤ two fifths of the ML	≤ one fifth of the ML

- (b) Performance criteria for methods of analysis for 3-MCPD:

Table 6

Parameter	Criterion
Applicability	Foods specified in Regulation (EC) No 1881/2006
Specificity	Free from matrix or spectral interferences
Field blanks	Less than LOD
Repeatability (RSD _r)	0,66 times RSD _R as derived from (modified) Horwitz equation
Reproducibility (RSD _R)	as derived from (modified) Horwitz equation
Recovery	75-110 %
LOD	≤ 5 µg/kg (on dry matter basis)
LOQ	≤ 10 µg/kg (on dry matter basis)

- (c) Performance criteria for methods of analysis for polycyclic aromatic hydrocarbons:

The four polycyclic aromatic hydrocarbons to which these criteria apply are benzo(a)pyrene, benz(a)anthracene, benzo(b)fluoranthene and chrysene.

Table 7

Parameter	Criterion
Applicability	Foods specified in Regulation (EC) No 1881/2006
Specificity	Free from matrix or spectral interferences, verification of positive detection
Repeatability (RSD _r)	HORRAT _r less than 2
Reproducibility (RSD _R)	HORRAT _R less than 2

Parameter	Criterion
Recovery	50-120 %
LOD	≤ 0,30 µg/kg for each of the four substances
LOQ	≤ 0,90 µg/kg for each of the four substances

(d) Notes to the performance criteria:

The Horwitz equation (*) (for concentrations $1,2 \times 10^{-7} \leq C \leq 0,138$) and the modified Horwitz equation (**) (for concentrations $C < 1,2 \times 10^{-7}$) are generalised precision equations which are independent of analyte and matrix but solely dependent on concentration for most routine methods of analysis.

Modified Horwitz equation for concentrations $C < 1,2 \times 10^{-7}$:

$$RSD_R = 22 \%$$

where:

- RSD_R is the relative standard deviation calculated from results generated under reproducibility conditions $[(s_R / \bar{x}) \times 100]$
- C is the concentration ratio (i.e. 1 = 100 g/100 g, 0,001 = 1 000 mg/kg). The modified Horwitz equation applies to concentrations $C < 1,2 \times 10^{-7}$.

Horwitz equation for concentrations $1,2 \times 10^{-7} \leq C \leq 0,138$:

$$RSD_R = 2C^{(-0,15)}$$

where:

- RSD_R is the relative standard deviation calculated from results generated under reproducibility conditions $[(s_R / \bar{x}) \times 100]$
- C is the concentration ratio (i.e. 1 = 100 g/100 g, 0,001 = 1 000 mg/kg). The Horwitz equation applies to concentrations $1,2 \times 10^{-7} \leq C \leq 0,138$.

(*) W. Horwitz, L.R. Kamps, K.W. Boyer, J.Assoc.Off.Analy.Chem.,1980, 63, 1344.

(**) M. Thompson, Analyst, 2000, p. 125 and 385-386.;

(9) point C.3.3.2 is replaced by the following:

'C.3.3.2. "Fitness-for-purpose" approach

For in-house validated methods, as an alternative a "fitness-for-purpose" approach (*) may be used to assess their suitability for official control. Methods suitable for official control must produce results with a combined standard measurement uncertainty (u) less than the maximum standard measurement uncertainty calculated using the formula below:

$$U_f = \sqrt{(LOD/2)^2 + (\alpha C)^2}$$

where:

- U_f is the maximum standard measurement uncertainty (µg/kg).
- LOD is the limit of detection of the method (µg/kg). The LOD must meet the performance criteria set in point C.3.3.1 for the concentration of interest.
- C is the concentration of interest (µg/kg);
- α is a numeric factor to be used depending on the value of C . The values to be used are given in Table 8.

Table 8

Numeric values to be used for α as constant in formula set out in this point, depending on the concentration of interest

C (µg/kg)	α
≤ 50	0,2
51-500	0,18

C (µg/kg)	α
501-1 000	0,15
1 001-10 000	0,12
> 10 000	0,1

The analyst shall note the "Report on the relationship between analytical results, measurement uncertainty, recovery factors and the provisions of EU food and feed legislation" (**).

(*) M. Thompson and R. Wood, Accred. Qual. Assur., 2006, p. 10 and 471-478.

(**) http://ec.europa.eu/food/food/chemicalsafety/contaminants/report-sampling_analysis_2004_en.pdf;

(10) in point D.1.2 'Recovery calculations', the second paragraph is replaced by the following:

'In case no extraction step is applied in the analytical method (e.g. in case of metals), the result may be reported uncorrected for recovery if evidence is provided by ideally making use of suitable certified reference material that the certified concentration allowing for the measurement uncertainty is achieved (i.e. high accuracy of the measurement), and thus that the method is not biased. In case the result is reported uncorrected for recovery this shall be mentioned.';

(11) in point D.1.3 'Measurement uncertainty', the second paragraph is replaced by the following:

'The analyst shall note the "Report on the relationship between analytical results, measurement uncertainty, recovery factors and the provisions of EU food and feed legislation" (*).

(*) http://ec.europa.eu/food/food/chemicalsafety/contaminants/report-sampling_analysis_2004_en.pdf.

Annex V:

Official Journal of the European Union

COMMISSION REGULATION (EU) No 2017/644

of 5 April 2017

laying down methods of sampling and analysis for the control of levels of dioxins, dioxin-like PCBs and non-dioxin-like PCBs in certain foodstuffs and repealing Regulation (EU)

No 589/2014

COMMISSION REGULATION (EU) 2017/644

of 5 April 2017

laying down methods of sampling and analysis for the control of levels of dioxins, dioxin-like PCBs and non-dioxin-like PCBs in certain foodstuffs and repealing Regulation (EU) No 589/2014

(Text with EEA relevance)

THE EUROPEAN COMMISSION,

Having regard to the Treaty on the Functioning of the European Union,

Having regard to Regulation (EC) No 882/2004 of the European Parliament and of the Council of 29 April 2004 on official controls performed to ensure the verification of compliance with feed and food law, animal health and animal welfare rules ⁽¹⁾, and in particular Article 11(4) thereof,

Whereas:

- (1) Commission Regulation (EC) No 1881/2006 ⁽²⁾ sets out the maximum levels for non-dioxin-like polychlorinated biphenyls (PCBs) dioxins and furans and for the sum of dioxins, furans and dioxin-like PCBs in certain foodstuffs.
- (2) Commission Recommendation 2013/711/EU ⁽³⁾ sets out action levels in order to stimulate a proactive approach to reduce the presence of polychlorinated dibenzo-para-dioxins and polychlorinated dibenzofurans (PCDD/Fs) and dioxin-like PCBs in food. Those action levels are a tool used by competent authorities and operators to highlight those cases where it is appropriate to identify a source of contamination and to take the necessary measures in order to reduce or eliminate it.
- (3) Commission Regulation (EC) No 589/2014 ⁽⁴⁾ establishes specific provisions concerning the sampling procedure and the methods of analysis to be applied for the official control of levels of dioxins, dioxin-like PCBs and non-dioxin-like PCBs.
- (4) The provisions laid down in this Regulation relate only to the sampling and analysis of dioxins, dioxin-like PCBs and non-dioxin-like PCBs for the implementation of Regulation (EC) No 1881/2006 and Recommendation 2013/711/EU. They do not affect the sampling strategy, sampling levels and frequency as set out in Annexes III and IV to Council Directive 96/23/EC ⁽⁵⁾. They do not affect the targeting criteria for sampling as laid down in Commission Decision 98/179/EC ⁽⁶⁾.
- (5) It is appropriate to ensure that food business operators applying the controls performed within the framework of Article 4 of Regulation (EC) No 852/2004 of the European Parliament and of the Council ⁽⁷⁾ apply sampling procedures equivalent to the sampling procedures provided for by this Regulation in order to ensure that samples taken for those controls are representative samples. Furthermore, the European Union Reference Laboratory for Dioxins and PCBs has provided evidence that analytical results in certain cases are not reliable when the performance criteria as provided in this Regulation are not applied by laboratories performing the analysis of samples taken by food business operators within the framework of Article 4 of Regulation (EC) No 852/2004. It is therefore appropriate to make the application of the performance criteria also obligatory for the analysis of those samples.

⁽¹⁾ OJ L 165, 30.4.2004, p. 1.

⁽²⁾ Commission Regulation (EC) No 1881/2006 of 19 December 2006 setting maximum levels for certain contaminants in foodstuffs (OJ L 364, 20.12.2006, p. 5).

⁽³⁾ Commission Recommendation 2013/711/EU of 3 December 2013 on the reduction of the presence of dioxins, furans and PCBs in feed and food (OJ L 323, 4.12.2013, p. 37).

⁽⁴⁾ Commission Regulation (EU) No 589/2014 of 2 June 2014 laying down methods of sampling and analysis for the official control of levels of dioxins, dioxin-like PCBs and non-dioxin-like PCBs in certain foodstuffs and repealing Regulation (EU) No 252/2012 (OJ L 164, 3.6.2014, p. 18).

⁽⁵⁾ Council Directive 96/23/EC of 29 April 1996 on measures to monitor certain substances and residues thereof in live animals and animal products and repealing Directives 85/358/EEC and 86/469/EEC and Decisions 89/187/EEC and 91/664/EEC (OJ L 125, 23.5.1996, p. 10).

⁽⁶⁾ Commission Decision 98/179/EC of 23 February 1998 laying down detailed rules on official sampling for the monitoring of certain substances and residues thereof in live animals and animal products (OJ L 65, 5.3.1998, p. 31).

⁽⁷⁾ Regulation (EC) No 852/2004 of the European Parliament and of the Council of 29 April 2004 on the hygiene of foodstuffs (OJ L 139, 30.4.2004, p. 1).

- (6) Given that the approach of the use of a decision limit to ensure that an analytical result is above the maximum level with a certain probability, as provided for in Commission Decision 2002/657/EC ⁽¹⁾, is no longer applied for the analysis of dioxins and PCBs in food, it is appropriate to delete this approach and to keep only the approach of the expanded uncertainty using the coverage factor of 2, giving a level confidence of approximately 95 %.
- (7) In line with the reporting requirements for bioanalytical screening methods, it is appropriate to also provide for physico-chemical methods used for screening specific reporting requirements.
- (8) Given that the analysis of dioxins, dioxin-like PCBs and non-dioxin-like PCBs are in most cases determined together it is appropriate to align the performance criteria for the non-dioxin-like PCBs to the performance criteria for dioxins and dioxin-like PCBs. This is a simplification, without substantial changes in practice as in the case of non-dioxin-like PCBs the relative intensity of qualifier ions compared to target ions is > 50 %.
- (9) Furthermore there are several other minor modifications proposed to the current provisions, requiring the repeal of Regulation (EU) No 589/2014 and its replacing by a new Regulation to maintain the readability of the text.
- (10) The measures provided for in this Regulation are in accordance with the opinion of the Standing Committee on Plants, Animals, Food and Feed,

HAS ADOPTED THIS REGULATION:

Article 1

For the purposes of this Regulation, the definitions and abbreviations set out in Annex I shall apply.

Article 2

Sampling for the official control of the levels of dioxins, furans, dioxin-like PCBs and non-dioxin-like PCBs in foodstuffs listed in Section 5 of the Annex to Regulation (EC) No 1881/2006 shall be carried out in accordance with the methods set out in Annex II to this Regulation.

Article 3

Sample preparation and analyses for the control of the levels of dioxins, furans and dioxin-like PCBs in foodstuffs listed in Section 5 of the Annex to Regulation (EC) No 1881/2006 shall be carried out in accordance with the methods set out in Annex III to this Regulation.

Article 4

Analyses for the control of the levels of non-dioxin-like PCBs in foodstuffs listed in Section 5 of the Annex to Regulation (EC) No 1881/2006 shall be carried out in accordance with the requirements for analytical procedures set out in Annex IV to this Regulation.

Article 5

Regulation (EU) No 589/2014 is repealed.

References to the repealed Regulation shall be construed as references to this Regulation.

⁽¹⁾ Commission Decision 2002/657/EC of 14 August 2002 implementing Council Directive 96/23/EC concerning the performance of analytical methods and the interpretation of results (OJ L 221, 17.8.2002, p. 8).

Article 6

This Regulation shall enter into force on the twentieth day following that of its publication in the *Official Journal of the European Union*.

This Regulation shall be binding in its entirety and directly applicable in all Member States.

Done at Brussels, 5 April 2017.

For the Commission
The President
Jean-Claude JUNCKER

ANNEX I

DEFINITIONS AND ABBREVIATIONS

I. DEFINITIONS

For the purposes of this Regulation the definitions laid down in Annex I to Decision 2002/657/EC shall apply.

Further to those definitions, the following definitions shall apply for the purposes of this Regulation:

- 1.1. 'Action level' means the level of a given substance, as laid down in the Annex to Recommendation 2013/711/EU, which triggers investigations to identify the source of that substance in cases where increased levels of the substance are detected.
- 1.2. 'Screening methods' means methods used for the selection of those samples with levels of PCDD/Fs and dioxin-like PCBs that exceed the maximum levels or the action levels. They shall allow for a cost-effective high sample-throughput, thus increasing the chance of discovering new cases where high exposure may lead to health risks for consumers. Screening methods shall be based on bioanalytical or GC-MS methods. Results from samples exceeding the cut-off value established to check compliance with the maximum level shall be verified by a full re-analysis from the original sample using a confirmatory method.
- 1.3. 'Confirmatory methods' means methods that provide full or complementary information enabling the PCDD/Fs and dioxin-like PCBs to be identified and quantified unequivocally at the maximum or, in case of need, at the action level. Such methods utilise gas chromatography/high resolution mass spectrometry (GC-HRMS) or gas chromatography/tandem mass spectrometry (GC-MS/MS).
- 1.4. 'Bioanalytical methods' means methods based on the use of biological principles such as cell-based assays, receptor-assays or immunoassays. They do not give results at the congener level but merely an indication ⁽¹⁾ of the TEQ level, expressed in Bioanalytical Equivalents (BEQ) to acknowledge the fact that not all compounds present in a sample extract that produce a response in the test may meet all requirements of the TEQ-principle.
- 1.5. 'Bioassay apparent recovery' means the BEQ level calculated from the TCDD or PCB 126 calibration curve corrected for the blank and then divided by the TEQ level determined by the confirmatory method. It attempts to correct factors like the loss of PCDD/Fs and dioxin-like compounds during the extraction and clean-up steps, co-extracted compounds increasing or decreasing the response (agonistic and antagonistic effects), the quality of the curve fit, or differences between the TEF and the REP values. The bioassay apparent recovery is calculated from suitable reference samples with representative congener patterns around the maximum or action level.
- 1.6. 'Duplicate analysis' means separate analysis of the analytes of interest using a second aliquot of the same homogenised sample.
- 1.7. 'Accepted specific limit of quantification ⁽²⁾ of an individual congener in a sample' means the lowest content of the analyte that can be measured with reasonable statistical certainty, fulfilling the identification criteria as described in internationally recognised standards, for example, in standard EN 16215:2012 ('Animal feed — Determination of dioxins and dioxin-like PCBs by GC/HRMS and of indicator PCBs by GC/HRMS') and/or in EPA methods 1613 and 1668 as revised.

The limit of quantification of an individual congener may be identified as

- (a) the concentration of an analyte in the extract of a sample which produces an instrumental response at two different ions to be monitored with a S/N (signal/noise) ratio of 3:1 for the less intensive raw data signal;

⁽¹⁾ Bioanalytical methods are not specific to those congeners included in the TEF-scheme. Other structurally related AhR-active compounds may be present in the sample extract which contribute to the overall response. Therefore, bioanalytical results cannot be an estimate but rather an indication of the TEQ level in the sample.

⁽²⁾ The principles as described in the 'Guidance Document on the Estimation of LOD and LOQ for Measurements in the Field of Contaminants in Feed and Food' [[link to website](#)] shall be followed when applicable.

or, if for technical reasons the signal-to-noise calculation does not provide reliable results,

(b) the lowest concentration point on a calibration curve that gives an acceptable ($\leq 30\%$) and consistent (measured at least at the start and at the end of an analytical series of samples) deviation to the average relative response factor calculated for all points on the calibration curve in each series of samples⁽¹⁾.

- 1.8. 'Upper-bound' means the concept which requires using the limit of quantification for the contribution of each non-quantified congener.
- 1.9. 'Lower-bound' means the concept which requires using zero for the contribution of each non-quantified congener.
- 1.10. 'Medium-bound' means the concept which requires using half of the limit of quantification calculating the contribution of each non-quantified congener.
- 1.11. 'Lot' means an identifiable quantity of food delivered at one time and determined by the official to have common characteristics, such as origin, variety, type of packing, packer, consignor or markings. In the case of fish and fishery products, also the size of fish shall be comparable. In case the size and/or weight of the fish is not comparable within a consignment, the consignment may still be considered as a lot but a specific sampling procedure has to be applied.
- 1.12. 'Sublot' means designated part of a large lot in order to apply the sampling method on that designated part. Each sublot must be physically separated and identifiable.
- 1.13. 'Incremental sample' means a quantity of material taken from a single place in the lot or sublot.
- 1.14. 'Aggregate sample' means the combined total of all the incremental samples taken from the lot or sublot.
- 1.15. 'Laboratory sample' means a representative part/quantity of the aggregate sample intended for the laboratory.

II. ABBREVIATIONS USED

BEQ	Bioanalytical Equivalents
GC	Gas chromatography
HRMS	High resolution mass spectrometry
LRMS	Low resolution mass spectrometry
MS/MS	Tandem mass spectrometry
PCB	Polychlorinated biphenyl
Non-dioxin-like PCBs	PCB 28, PCB 52, PCB 101, PCB 138, PCB 153 and PCB 180
PCDD	Polychlorinated dibenzo-p-dioxins
PCDF	Polychlorinated dibenzofurans
QC	Quality control
REP	Relative potency
TEF	Toxic Equivalency Factor
TEQ	Toxic Equivalents
TCDD	2,3,7,8-Tetrachlorodibenzo-p-dioxin
U	Expanded measurement uncertainty

⁽¹⁾ The LOQ is calculated from the lowest concentration point taking into account the recovery of internal standards and sample intake.

ANNEX II

METHODS OF SAMPLING FOR OFFICIAL CONTROL OF LEVELS OF DIOXINS (PCDD/PCDF), DIOXIN-LIKE PCBs AND NON-DIOXIN-LIKE PCBs IN CERTAIN FOODSTUFFS**I. SCOPE**

Samples intended for the official control of the levels of dioxins (PCDD/Fs), dioxin-like PCBs and non-dioxin-like PCBs in foodstuffs shall be taken according to the methods described in this Annex. Aggregate samples thus obtained shall be considered as representative of the lots or sublots from which they are taken. Compliance with maximum levels laid down in Regulation (EC) No 1881/2006 shall be established on the basis of the levels determined in the laboratory samples.

To ensure compliance with the provisions in Article 4 of Regulation (EC) No 852/2004, food business operator shall, when samples are taken to control the levels of dioxins (PCDD/Fs), dioxin-like PCBs and non-dioxin-like PCBs, take the samples according to the methods described in Chapter III of this Annex or apply an equivalent sampling procedure which is demonstrated to have a same level of representation as the sampling procedure described in Chapter III of this Annex.

II. GENERAL PROVISIONS**1. Personnel**

Official sampling shall be performed by an authorised person as designated by the Member State.

2. Material to be sampled

Each lot or subplot which is to be examined shall be sampled separately.

3. Precautions to be taken

In the course of sampling and the preparation of the samples, precautions shall be taken to avoid any changes which would affect the content of dioxins and PCBs, adversely affect the analytical determination or make the aggregate samples unrepresentative.

4. Incremental samples

As far as possible, incremental samples shall be taken at various places distributed throughout the lot or subplot. Departure from such a procedure shall be recorded in the record provided for under point II.8.

5. Preparation of the aggregate sample

The aggregate sample shall be made up by combining the incremental samples. It shall be at least 1 kg unless not practical, e.g. when a single package has been sampled or when the product has a very high commercial value.

6. Replicate samples

The replicate samples for enforcement, defence and reference purposes shall be taken from the homogenised aggregate sample, unless such procedure conflicts with a Member State's rules as regard the rights of the food business operator. The size of the laboratory samples for enforcement shall be sufficient to allow at least for duplicate analyses.

7. Packaging and transmission of samples

Each sample shall be placed in a clean, inert container offering adequate protection from contamination, from loss of analytes by adsorption to the internal wall of the container and against damage in transit. All necessary precautions shall be taken to avoid any change in composition of the sample which might arise during transportation or storage.

8. Sealing and labelling of samples

Each sample taken for official use shall be sealed at the place of sampling and identified in accordance with the rules of the Member States.

A record shall be kept of each sampling, permitting each lot to be identified unambiguously and giving the date and place of sampling together with any additional information likely to be of assistance to the analyst.

III. SAMPLING PLAN

The sampling method applied shall ensure that the aggregate sample is representative of the (sub)lot that is to be controlled.

1. Division of lots into sublots

Large lots shall be divided into sublots on condition that the subplot can be separated physically. For products traded in large bulk consignments (e.g. vegetable oils) Table 1 shall apply. For other products Table 2 shall apply. Taking into account that the weight of the lot is not always an exact multiple of the weight of the sublots, the weight of the subplot may exceed the mentioned weight by a maximum of 20 %.

Table 1

Subdivision of lots into sublots for products traded in bulk consignments

Lot weight (ton)	Weight or number of sublots
≥ 1 500	500 tonnes
> 300 and < 1 500	3 sublots
≥ 50 and ≤ 300	100 tonnes
< 50	—

Table 2

Subdivision of lots into sublots for other products

Lot weight (ton)	Weight or number of sublots
≥ 15	15-30 tonnes
< 15	—

2. Number of incremental samples

The aggregate sample uniting all incremental samples shall be at least 1 kg (see point II.5).

The minimum number of incremental samples to be taken from the lot or subplot shall be as given in Tables 3 and 4.

In the case of bulk liquid products, the lot or subplot shall be thoroughly mixed insofar as possible and insofar as it does not affect the quality of the product by either manual or mechanical means immediately prior to sampling. In that case, a homogeneous distribution of contaminants is assumed within a given lot or subplot. It is therefore sufficient to take three incremental samples from a lot or subplot to form the aggregate sample.

The incremental samples shall be of similar weight. The weight of an incremental sample shall be at least 100 grams.

Departure from this procedure must be recorded in the record provided for under point II.8 of this Annex. In accordance with the provisions of Commission Decision 97/747/EC⁽¹⁾, the aggregate sample size for hens' eggs is at least 12 eggs (for bulk lots as well as for lots consisting of individual packages, Tables 3 and 4 shall apply).

Table 3

Minimum number of incremental samples to be taken from the lot or subplot

Weight or volume of lot/sublot (in kg or litre)	Minimum number of incremental samples to be taken
< 50	3
50 to 500	5
> 500	10

If the lot or subplot consists of individual packages or units, then the number of packages or units which shall be taken to form the aggregate sample is given in Table 4.

Table 4

Number of packages or units (incremental samples) which shall be taken to form the aggregate sample if the lot or subplot consists of individual packages or units

Number of packages or units in the lot/sublot	Number of packages or units to be taken
1 to 25	at least 1 package or unit
26 to 100	about 5 %, at least 2 packages or units
> 100	about 5 %, at maximum 10 packages or units

3. Specific provisions for the sampling of lots containing whole fishes of comparable size and weight

Fishes are considered to be of comparable size and weight where the difference in size and weight does not exceed about 50 %.

The number of incremental samples to be taken from the lot are defined in Table 3. The aggregate sample uniting all incremental samples shall be at least 1 kg (see point II.5).

- Where the lot to be sampled contains small fishes (individual fishes weighing < about 1 kg), the whole fish is taken as incremental sample to form the aggregate sample. Where the resulting aggregate sample weighs more than 3 kg, the incremental samples may consist of the middle part, weighing each at least 100 grams, of the fishes forming the aggregate sample. The whole part to which the maximum level is applicable is used for homogenisation of the sample.

The middle part of the fish is where the centre of gravity is. This is located in most cases at the dorsal fin (in case the fish has a dorsal fin) or halfway between the gill opening and the anus.

- Where the lot to be sampled contains larger fishes (individual fishes weighing more than about 1 kg), the incremental sample consists of the middle part of the fish. Each incremental sample weighs at least 100 grams.

For fishes of intermediate size (about 1-6 kg) the incremental sample is taken as a slice of the fish from backbone to belly in the middle part of the fish.

⁽¹⁾ Commission Decision 97/747/EC of 27 October 1997 fixing the levels and frequencies of sampling provided for by Council Directive 96/23/EC for the monitoring of certain substances and residues thereof in certain animal products (OJ L 303, 6.11.1997, p. 12).

For very large fishes (e.g. > about 6 kg), the incremental part is taken from the right side (frontal view) dorso-lateral muscle meat in the middle part of the fish. Where the taking of such a piece of the middle part of the fish would result in significant economic damage, the taking of three incremental samples of at least 350 grams each may be considered as being sufficient independent of the size of the lot or alternatively an equal part of the muscled meat close to the tail part and the muscle meat close to the head part of one fish may be taken to form the incremental sample being representative for the level of dioxins in the whole fish.

4. Sampling of lots of fish containing whole fishes of different size and/or weight

- The provisions of point III.3 as regards sample constitution shall apply.
- Where a size or weight class/category is predominant (about 80 % or more of the lot), the sample is taken from fishes with the predominant size or weight. This sample is to be considered as being representative for the whole lot.
- Where no particular size or weight class/category predominates, then it must be ensured that the fishes selected for the sample are representative for the lot. Specific guidance for such cases is provided in 'Guidance document on sampling of whole fishes of different size and/or weight' ⁽²⁾.

5. Sampling at retail stage

Sampling of foodstuffs at the retail stage shall be done where possible in accordance with the sampling provisions set out in point III.2.

Where this is not possible, an alternative method of sampling at retail stage may be used provided that it ensures sufficient representativeness for the sampled lot or subplot.

IV. COMPLIANCE OF THE LOT WITH SPECIFICATION

1. As regards non-dioxin-like PCBs

The lot is compliant if the analytical result for the sum of non-dioxin-like PCBs does not exceed the respective maximum level, as laid down in Regulation (EC) No 1881/2006 taking into account the expanded measurement uncertainty ⁽³⁾.

The lot is non-compliant with the maximum level as laid down in Regulation (EC) No 1881/2006 if the mean of two upperbound analytical results obtained from duplicate analysis ⁽⁴⁾, taking into account the expanded measurement uncertainty, exceeds the maximum level beyond reasonable doubt.

The expanded measurement uncertainty is calculated using a coverage factor of 2 which gives a level of confidence of approximately 95 %. A lot is non-compliant if the mean of the measured values minus the expanded uncertainty of the mean is above the established maximum level.

The rules, mentioned in the paragraphs above under this point, shall apply for the analytical result obtained on the sample for official control. In case of analysis for defence or reference purposes, the national rules apply.

2. As regards dioxins (PCDD/Fs) and dioxin-like PCBs

The lot is compliant if the result of a single analysis

- performed by a screening method with a false-compliant rate below 5 % indicates that the level does not exceed the respective maximum level of PCDD/Fs and the sum of PCDD/Fs and dioxin-like PCBs as laid down in Regulation (EC) No 1881/2006,

⁽²⁾ https://ec.europa.eu/food/sites/food/files/safety/docs/cs_contaminants_catalogue_dioxins_guidance-sampling_exemples-dec2006_en.pdf

⁽³⁾ The principles as described in the 'Guidance Document on Measurement Uncertainty for Laboratories performing PCDD/F and PCB Analysis using Isotope Dilution Mass Spectrometry' [link to website] shall be followed when applicable.

⁽⁴⁾ The duplicate analysis is necessary if the result of the first determination is non-compliant. The duplicate analysis is necessary to exclude the possibility of internal cross-contamination or an accidental mix-up of samples. In case the analysis is performed in the course of a contamination incident, confirmation by duplicate analysis might be omitted in case the samples selected for analysis are through traceability linked to the contamination incident and the level found is significantly above the maximum level.

- performed by a confirmatory method does not exceed the respective maximum level of PCDD/Fs and the sum of PCDD/Fs and dioxin-like PCBs as laid down in Regulation (EC) No 1881/2006 taking into account the expanded measurement uncertainty ⁽⁷⁾.

For screening assays a cut-off value shall be established for the decision on the compliance with the respective maximum levels set for either PCDD/Fs or for the sum of PCDD/Fs and dioxin-like PCBs.

The lot is non-compliant with the maximum level as laid down in Regulation (EC) No 1881/2006 if the mean of two upperbound analytical results (duplicate analysis ⁽⁸⁾) obtained using a confirmatory method, taking into account the expanded measurement uncertainty, exceeds the maximum level beyond reasonable doubt.

The expanded measurement uncertainty is calculated using a coverage factor of 2 which gives a level of confidence of approximately 95 %. A lot is non-compliant if the mean of the measured values minus the expanded uncertainty of the mean is above the established maximum level.

The sum of the estimated expanded uncertainties of the separate analytical results of PCDD/Fs and dioxin-like PCBs has to be used for the estimated expanded uncertainty of the sum of PCDD/Fs and dioxin-like PCBs.

The rules, mentioned in the paragraphs above under this point, shall apply for the analytical result obtained on the sample for official control. In case of analysis for defence or reference purposes, the national rules apply.

V. EXCEEDANCE OF ACTION LEVELS

Action levels serve as a tool for the selection of samples in those cases where it is appropriate to identify a source of contamination and to take measures for its reduction or elimination. Screening methods shall establish the appropriate cut-off values for selection of those samples. Where significant efforts are necessary to identify a source and to reduce or eliminate the contamination, it might be appropriate to confirm exceedance of the action level by duplicate analysis using a confirmatory method and taking into account the expanded measurement uncertainty ⁽⁷⁾.

⁽⁷⁾ Guidance Document on Measurement Uncertainty for Laboratories performing PCDD/F and PCB Analysis using Isotope Dilution Mass Spectrometry [[link to website](#)], Guidance Document on the Estimation of LOD and LOQ for Measurements in the Field of Contaminants in Feed and Food [[link to website](#)].

⁽⁸⁾ The duplicate analysis is necessary if the result of the first determination applying confirmatory methods with the use of ¹³C-labelled internal standard for the relevant analytes is non-compliant. The duplicate analysis is necessary to exclude the possibility of internal cross-contamination or an accidental mix-up of samples. In case the analysis is performed in the course of a contamination incident, confirmation by duplicate analysis might be omitted in case the samples selected for analysis are through traceability linked to the contamination incident and the level found is significantly above the maximum level.

⁽⁷⁾ Identical explanation and requirements for duplicate analysis for control of action levels as in footnote 6 for maximum levels.

ANNEX III

SAMPLE PREPARATION AND REQUIREMENTS FOR METHODS OF ANALYSIS USED IN CONTROL OF THE LEVELS OF DIOXINS (PCDD/Fs) AND DIOXIN-LIKE PCBs IN CERTAIN FOODSTUFFS

1. FIELD OF APPLICATION

The requirements set out in this Annex shall be applied where foodstuffs are analysed for the official control of the levels of 2,3,7,8-substituted polychlorinated dibenzo-p-dioxins and polychlorinated dibenzofurans (PCDD/Fs) and dioxin-like polychlorinated biphenyls (dioxin-like PCBs) and as regards sample preparation and analytical requirements for other regulatory purposes, including the controls performed by the food business operator to ensure compliance with provisions in Article 4 of Regulation (EC) No 852/2004.

Monitoring for the presence of PCDD/Fs and dioxin-like PCBs in foodstuffs may be performed with two different types of analytical methods:

(a) *Screening methods*

The goal of screening methods is to select those samples with levels of PCDD/Fs and dioxin-like PCBs that exceed the maximum levels or the action levels. Screening methods shall ensure cost-effective high sample-throughput, thus increasing the chance to discover new incidents where high exposure may lead to health risks for consumers. Their application shall aim to avoid false-compliant results. They may comprise bioanalytical and GC/MS methods.

Screening methods compare the analytical result with a cut-off value, providing a yes/no-decision over the possible exceedance of the maximum or action level. The concentration of PCDD/Fs and the sum of PCDD/Fs and dioxin-like PCBs in samples suspected to be non-compliant with the maximum level must be determined or confirmed by a confirmatory method.

In addition, screening methods may give an indication of the levels of PCDD/Fs and dioxin-like-PCBs present in the sample. In case of application of bioanalytical screening methods the result is expressed as Bioanalytical Equivalents (BEQ), whereas in case of application of physico-chemical GC-MS methods it is expressed as Toxic Equivalents (TEQ). The numerically indicated results of screening methods are suitable for demonstrating compliance or suspected non-compliance or exceedance of action levels and give an indication of the range of levels in case of follow-up by confirmatory methods. They are not suitable for purposes such as evaluation of background levels, estimation of intake, following of time trends in levels or re-evaluation of action and maximum levels.

(b) *Confirmatory methods*

Confirmatory methods allow the unequivocal identification and quantification of PCDD/Fs and dioxin-like PCBs present in a sample and provide full information on congener basis. Therefore, those methods allow the control of maximum and action levels, including the confirmation of results obtained by screening methods. Furthermore, results may be used for other purposes such as determination of low background levels in food monitoring, following of time trends, exposure assessment of the population and building of a database for possible re-evaluation of action and maximum levels. They are also important for establishing congener patterns in order to identify the source of a possible contamination. Such methods utilise GC-HRMS. For confirming compliance or non-compliance with the maximum level, also GC-MS/MS can be used.

2. BACKGROUND

For calculation of TEQ concentrations, the concentrations of the individual substances in a given sample shall be multiplied by their respective TEF, as established by the World Health Organisation and listed in the Appendix to this Annex, and subsequently summed to give the total concentration of dioxin-like compounds expressed as TEQs.

Screening and confirmatory methods may only be applied for control of a certain matrix if the methods are sensitive enough to detect levels reliably at the maximum or action level.

3. QUALITY ASSURANCE REQUIREMENTS

- Measures must be taken to avoid cross-contamination at each stage of the sampling and analysis procedure.
- The samples must be stored and transported in glass, aluminum, polypropylene or polyethylene containers suitable for storage without any influence on the levels of PCDD/Fs and dioxin-like PCBs in the samples. Traces of paper dust must be removed from the sample container.
- The sample storage and transportation has to be performed in a way that maintains the integrity of the foodstuff sample.
- Insofar as relevant, finely grind and mix thoroughly each laboratory sample using a process that has been demonstrated to achieve complete homogenisation (e.g. ground to pass a 1 mm sieve); samples have to be dried before grinding if moisture content is too high.
- Control of reagents, glassware and equipment for possible influence of TEQ- or BEQ-based results is of general importance.
- A blank analysis shall be performed by carrying out the entire analytical procedure omitting only the sample.
- For bioanalytical methods, it is of great importance that all glassware and solvents used in analysis shall be tested to be free of compounds that interfere with the detection of target compounds in the working range. Glassware shall be rinsed with solvents or/and heated at temperatures suitable to remove traces of PCDD/Fs, dioxin-like compounds and interfering compounds from its surface.
- Sample quantity used for the extraction must be sufficient to fulfill the requirements with respect to a sufficiently low working range including the concentrations of maximum or action levels.
- The specific sample preparation procedures used for the products under consideration shall follow internationally accepted guidelines.
- In the case of fish, the skin has to be removed as the maximum level applies to muscle meat without skin. However it is necessary that all remaining muscle meat and fat tissue on the inner side of the skin are carefully and completely scraped off from the skin and added to the sample to be analysed.

4. REQUIREMENTS FOR LABORATORIES

- In accordance with the provisions of Regulation (EC) No 882/2004, laboratories shall be accredited by a recognised body operating in accordance with ISO Guide 58 to ensure that they are applying analytical quality assurance. Laboratories shall be accredited following the EN ISO/IEC 17025 standard. The principles as described in the Technical Guidelines for the estimation of measurement uncertainty and limits of quantification for PCDD/F and PCB analysis shall be followed when applicable ⁽¹⁾.
- Laboratory proficiency shall be proven by the continuous successful participation in interlaboratory studies for the determination of PCDD/Fs and dioxin-like PCBs in relevant food matrices and concentration ranges.
- Laboratories applying screening methods for routine control of samples shall establish a close cooperation with laboratories applying the confirmatory method, both for quality control and confirmation of the analytical result of suspected samples.

5. BASIC REQUIREMENTS TO BE MET BY ANALYTICAL PROCEDURE FOR DIOXINS (PCDD/Fs) AND DIOXIN-LIKE PCBs

5.1. Low working range and limits of quantification

- For PCDD/Fs, detectable quantities have to be in the upper femtogram (10^{-15} g) range because of extreme toxicity of some of these compounds. For most PCB congeners limit of quantification in the nanogram (10^{-9} g) range is already sufficient. However, for the measurement of the more toxic dioxin-like PCB congeners (in particular non-ortho-substituted congeners) the lower end of the working range must reach the low picogram (10^{-12} g) levels.

⁽¹⁾ Guidance Document on Measurement Uncertainty for Laboratories performing PCDD/F and PCB Analysis using Isotope Dilution Mass Spectrometry [link to website], Guidance Document on the Estimation of LOD and LOQ for Measurements in the Field of Contaminants in Feed and Food [link to website].

5.2. High selectivity (specificity)

- A distinction is required between PCDD/Fs and dioxin-like PCBs and a multitude of other, coextracted and possibly interfering compounds present at concentrations up to several orders of magnitude higher than those of the analytes of interest. For gas chromatography/mass spectrometry (GC-MS) methods, a differentiation among various congeners is necessary, such as between toxic (e.g. the seventeen 2,3,7,8-substituted PCDD/Fs, and twelve dioxin-like PCBs) and other congeners.
- Bioanalytical methods shall be able to detect the target compounds as the sum of PCDD/Fs, and/or dioxin-like PCBs. Sample clean-up shall aim at removing compounds causing false non-compliant results or compounds that may decrease the response, causing false-compliant results.

5.3. High accuracy (trueness and precision, bioassay apparent recovery)

- For GC-MS methods, the determination shall provide a valid estimate of the true concentration in a sample. High accuracy (accuracy of the measurement: the closeness of the agreement between the result of a measurement with the true or assigned value of the measurand) is necessary to avoid the rejection of a sample analysis result on the basis of poor reliability of the determined TEQ level. Accuracy is expressed as trueness (difference between the mean value measured for an analyte in a certified material and its certified value, expressed as percentage of this value) and precision (RSD_R relative standard deviation calculated from results generated under reproducibility conditions).
- For bioanalytical methods, the bioassay apparent recovery shall be determined.

5.4. Validation in the range of maximum level and general quality control measures

- Laboratories shall demonstrate the performance of a method in the range of the maximum level, e.g. 0,5×, 1× and 2× the maximum level with an acceptable coefficient of variation for repeated analysis, during the validation procedure and/or during routine analysis.
- Regular blank controls and spiking experiments or analysis of control samples (preferably, if available, certified reference material) shall be performed as internal quality control measures. Quality control (QC) charts for blank controls, spiking experiments or analysis of control samples shall be recorded and checked to make sure the analytical performance is in accordance with the requirements.

5.5. Limit of quantification

- For a bioanalytical screening method, establishment of the LOQ is not an indispensable requirement but the method shall prove that it can differentiate between the blank and the cut-off value. When providing a BEQ-level, a reporting level shall be established to deal with samples showing a response below this level. The reporting level shall be demonstrated to be different from procedure blank samples at least by a factor of three, with a response below the working range. It shall therefore be calculated from samples containing the target compounds around the required minimum level, and not from a S/N ratio or an assay blank.
- Limit of quantification (LOQ) for a confirmatory method shall be about one fifth of the maximum level.

5.6. Analytical criteria

- For reliable results from confirmatory or screening methods, the following criteria must be met in the range of the maximum level for the TEQ value respectively the BEQ value, whether determined as total TEQ or total BEQ (as sum of PCDD/F and dioxin-like PCBs) or separately for PCDD/Fs and dioxin-like PCBs.

	Screening with bioanalytical or physico-chemical methods	Confirmatory methods
False-compliant rate (*)	< 5 %	
Trueness		- 20 % to + 20 %

	Screening with bioanalytical or physico-chemical methods	Confirmatory methods
Repeatability (RSD _r)	< 20 %	
Intermediate precision (RSD _R)	< 25 %	< 15 %

(*) With respect to the maximum levels

5.7. Specific requirements for screening methods

- Both GC-MS and bioanalytical methods may be used for screening. For GC-MS methods the requirements as laid down in point 6 are to be used. For cell-based bioanalytical methods specific requirements are laid down in point 7.
- Laboratories applying screening methods for routine control of samples shall establish a close cooperation with laboratories applying the confirmatory method.
- Performance verification of the screening method is required during routine analysis, by analytical quality control and ongoing method validation. There must be a continuous programme for control of compliant results.
- Check on possible suppression of the cell response and cytotoxicity.

20 % of the sample extracts shall be measured in routine screening without and with TCDD added corresponding to the maximum or action level, to check if the response is possibly suppressed by interfering substances present in the sample extract. The measured concentration of the spiked sample is compared to the sum of the concentration of the unspiked extract plus the spiking concentration. If this measured concentration is more than 25 % lower than the calculated (sum) concentration, this is an indication of a potential signal suppression and the respective sample must be submitted to confirmatory analysis. Results shall be monitored in quality control charts.

- Quality control on compliant samples

Approximately 2 % to 10 % of the compliant samples, depending on sample matrix and laboratory experience, shall be confirmed.

- Determination of false-compliant rates from QC data

The rate of false-compliant results from screening of samples below and above the maximum level or the action level shall be determined. Actual false-compliant rates shall be below 5 %.

After a minimum of 20 confirmed results per matrix/matrix group is available from the quality control of compliant samples, conclusions on the false-compliant rate shall be drawn from this database. The results from samples analysed in ring trials or during contamination incidents, covering a concentration range up to, e.g. 2× the maximum level (ML), may also be included in the minimum of 20 results for evaluation of the false-compliant rate. The samples shall cover most frequent congener patterns, representing various sources.

Although screening assays shall preferentially aim to detect samples exceeding the action level, the criterion for determining false-compliant rates is the maximum level, taking into account the expanded measurement uncertainty of the confirmatory method.

- Potential non-compliant results from screening shall always be verified by a full re-analysis of the original sample by a confirmatory method. These samples may also be used to evaluate the rate of false non-compliant results. For screening methods, the rate of false non-compliant results is the fraction of results confirmed to be compliant from confirmatory analysis, while in previous screening the sample had been declared to be suspected to be non-compliant. However, evaluation of the advantageousness of the screening method shall be based on comparison of false non-compliant samples with the total number of samples checked. This rate shall be low enough to make the use of a screening tool advantageous.

- At least under validation conditions, bioanalytical methods shall provide a valid indication of the TEQ level, calculated and expressed as BEQ.
 - Also for bioanalytical methods carried out under repeatability conditions, the intra-laboratory RSD_r would typically be smaller than the reproducibility RSD_R.
6. SPECIFIC REQUIREMENTS FOR GC-MS METHODS TO BE COMPLIED WITH FOR SCREENING OR CONFIRMATORY PURPOSES
- 6.1. **Acceptable differences between upperbound and lowerbound WHO-TEQ levels**
- The difference between upperbound level and lowerbound level shall not exceed 20 % for confirmation of the exceedance of maximum or in case of need of action levels.
- 6.2. **Control of recoveries**
- Addition of ¹³C-labelled 2,3,7,8-chlorine-substituted internal PCDD/F standards and of ¹³C-labelled internal dioxin-like PCB standards must be carried out at the very beginning of the analytical method, e.g. prior to extraction, in order to validate the analytical procedure. At least one congener for each of the tetra- to octa-chlorinated homologous groups for PCDD/Fs and at least one congener for each of the homologous groups for dioxin-like PCBs must be added (alternatively, at least one congener for each mass spectrometric selected ion recording function used for monitoring PCDD/Fs and dioxin-like PCBs). In case of confirmatory methods, all seventeen ¹³C-labelled 2,3,7,8-substituted internal PCDD/F standards and all twelve ¹³C-labelled internal dioxin-like PCB standards shall be used.
 - Relative response factors shall also be determined for those congeners for which no ¹³C-labelled analogue is added by using appropriate calibration solutions.
 - For foodstuffs of plant origin and foodstuffs of animal origin containing less than 10 % fat, the addition of the internal standards is mandatory prior to extraction. For foodstuffs of animal origin containing more than 10 % fat, the internal standards may be added either before or after fat extraction. An appropriate validation of the extraction efficiency shall be carried out, depending on the stage at which internal standards are introduced and on whether results are reported on product or fat basis.
 - Prior to GC-MS analysis, one or two recovery (surrogate) standard(s) must be added.
 - Control of recovery is necessary. For confirmatory methods, the recoveries of the individual internal standards shall be in the range of 60 to 120 %. Lower or higher recoveries for individual congeners, in particular for some hepta- and octa- chlorinated dibenzo-p-dioxins and dibenzofurans, are acceptable on the condition that their contribution to the TEQ value does not exceed 10 % of the total TEQ value (based on sum of PCDD/F and dioxin-like PCBs). For GC-MS screening methods, the recoveries shall be in the range of 30 to 140 %.
- 6.3. **Removal of interfering substances**
- Separation of PCDD/Fs from interfering chlorinated compounds such as non-dioxin-like PCBs and chlorinated diphenyl ethers shall be carried out by suitable chromatographic techniques (preferably with a florisil, alumina and/or carbon column).
 - Gas-chromatographic separation of isomers shall be sufficient (< 25 % peak to peak between 1,2,3,4,7,8-HxCDF and 1,2,3,6,7,8-HxCDF).
- 6.4. **Calibration with standard curve**
- The range of the calibration curve shall cover the relevant range of maximum or action levels.
- 6.5. **Specific criteria for confirmatory methods**
- For GC-HRMS:

In HRMS, the resolution shall typically be greater than or equal to 10 000 for the entire mass range at 10 % valley.

Fulfilment of further identification and confirmation criteria as described in internationally recognised standards, for example, in standard EN 16215:2012 (Animal feed — Determination of dioxins and dioxin-like PCBs by GC/HRMS and of indicator PCBs by GC/HRMS) and/or in EPA methods 1613 and 1668 as revised.

— For GC-MS/MS:

Monitoring of at least two specific precursor ions, each with one specific corresponding transition product ion for all labelled and unlabelled analytes in the scope of analysis.

Maximum permitted tolerance of relative ion intensities of $\pm 15\%$ for selected transition product ions in comparison to calculated or measured values (average from calibration standards), applying identical MS/MS conditions, in particular collision energy and collision gas pressure, for each transition of an analyte.

Resolution for each quadrupole to be set equal to or better than unit mass resolution (unit mass resolution: sufficient resolution to separate two peaks one mass unit apart) in order to minimise possible interferences on the analytes of interest.

Fulfilment of the further criteria as described in internationally recognised standards, for example, in standard EN 16215:2012 (Animal feed — Determination of dioxins and dioxin-like PCBs by GC/HRMS and of indicator PCBs by GC/HRMS) and/or in EPA methods 1613 and 1668 as revised, except the obligation to use GC-HRMS.

7. SPECIFIC REQUIREMENTS FOR BIOANALYTICAL METHODS

Bioanalytical methods are methods based on the use of biological principles like cell-based assays, receptor-assays or immunoassays. This point establishes requirements for bioanalytical methods in general.

A screening method in principle classifies a sample as compliant or suspected to be non-compliant. For this, the calculated BEQ level is compared to the cut-off value (see point 7.3). Samples below the cut-off value are declared compliant, samples equal or above the cut-off value as suspected to be non-compliant, requiring analysis by a confirmatory method. In practice, a BEQ level corresponding to two-thirds of the maximum level may serve as cut-off value provided that a false-compliant rate below 5 % and an acceptable rate for false non-compliant results are ensured. With separate maximum levels for PCDD/Fs and for the sum of PCDD/Fs and dioxin-like PCBs, checking compliance of samples without fractionation requires appropriate bioassay cut-off values for PCDD/Fs. For checking of samples exceeding the action levels, an appropriate percentage of the respective action level would suit as cut-off value.

If an indicative level is expressed in BEQs, the results from the the sample must be given in the working range and exceeding the reporting limit (see points 7.1.1 and 7.1.6).

7.1. Evaluation of the test response

7.1.1. General requirements

— When calculating the concentrations from a TCDD calibration curve, values at the higher end of the curve will show a high variation (high coefficient of variation (CV)). The working range is the area where this CV is smaller than 15 %. The lower end of the working range (reporting limit) must further be set significantly (at least by a factor of three) above the procedure blanks. The upper end of the working range is usually represented by the EC_{70} value (70 % of maximal effective concentration), but lower if the CV is higher than 15 % in this range. The working range shall be established during validation. Cut-off values (see point 7.3) must be within the working range.

— Standard solutions and sample extracts shall be tested in triplicate or at least in duplicate. When using duplicates, a standard solution or a control extract tested in four to six wells divided over the plate shall produce a response or concentration (only possible in the working range) based on a $CV < 15\%$.

7.1.2. Calibration

7.1.2.1. Calibration with standard curve

- Levels in samples may be estimated by comparison of the test response with a calibration curve of TCDD (or PCB 126 or a PCDD/F/dioxin-like PCB standard mixture) to calculate the BEQ level in the extract and subsequently in the sample.
- Calibration curves shall contain 8 to 12 concentrations (at least in duplicates), with enough concentrations in the lower part of the curve (working range). Special attention shall be paid to the quality of the curve-fit in the working range. As such, the R^2 value is of little or no value in estimating the goodness of fit in nonlinear regression. A better fit will be achieved by minimising the difference between calculated and observed levels in the working range of the curve (e.g. by minimising the sum of squared residuals).
- The estimated level in the sample extract is subsequently corrected for the BEQ level calculated for a matrix or solvent blank sample (to account for impurities from solvents and chemicals used), and the apparent recovery (calculated from the BEQ level of suitable reference samples with representative congener patterns around the maximum or action level). For performing a recovery correction, the apparent recovery must always be within the required range (see point 7.1.4). Reference samples used for recovery correction must comply with requirements as given in point 7.2.

7.1.2.2. Calibration with reference samples

Alternatively, a calibration curve prepared from at least four reference samples (see point 7.2: one matrix blank, plus three reference samples at 0,5×, 1,0× and 2,0× the maximum or action level) may be used, eliminating the need to correct for blank and recovery if matrix properties of the reference samples match those of the unknown samples. In this case, the test response corresponding to two-thirds of the maximum level (see point 7.3) may be calculated directly from these samples and used as cut-off value. For checking of samples exceeding the action levels, an appropriate percentage of these action levels would suit as cut-off value.

7.1.3. Separate determination of PCDD/Fs and dioxin-like PCBs

Extracts may be split into fractions containing PCDD/Fs and dioxin-like PCBs, allowing a separate indication of PCDD/Fs and dioxin-like PCB TEQ levels (in BEQs). A PCB 126 standard calibration curve shall preferentially be used to evaluate results for the fraction containing dioxin-like PCBs.

7.1.4. Bioassay apparent recoveries

The 'bioassay apparent recovery' shall be calculated from suitable reference samples with representative congener patterns around the maximum or action level and expressed as percentage of the BEQ level in comparison to the TEQ level. Depending on the type of assay and TEFs⁽¹⁾ used, the differences between TEF and REP factors for dioxin-like PCBs may cause low apparent recoveries for dioxin-like PCBs in comparison to PCDD/Fs. Therefore, if a separate determination of PCDD/Fs and dioxin-like PCBs is performed, bioassay apparent recoveries shall be: for dioxin-like PCBs 20 % to 60 %, for PCDD/Fs 50 % to 130 % (ranges apply for TCDD calibration curve). As the contribution of dioxin-like PCBs to the sum of PCDD/Fs and dioxin-like PCBs may vary between different matrices and samples, bioassay apparent recoveries for the sum parameter reflect these ranges and shall be between 30 % to 130 %.

7.1.5. Control of recoveries for clean-up

The loss of compounds during the clean-up shall be checked during validation. A blank sample spiked with a mixture of the different congeners shall be submitted to clean-up (at least $n = 3$) and the recovery and variability checked by a confirmatory method. The recovery shall be within 60 to 120 % especially for congeners contributing more than 10 % to the TEQ-level in various mixtures.

⁽¹⁾ Current requirements are based on the TEFs published in: M. Van den Berg et al, Toxicol Sci 93 (2), 223-241 (2006).

7.1.6. Reporting Limit

When reporting BEQ levels, a reporting limit shall be determined from relevant matrix samples involving typical congener patterns, but not from the calibration curve of the standards due to low precision in the lower range of the curve. Effects from extraction and clean-up must be taken into account. The reporting limit must be set significantly (at least by a factor of three) above the procedure blanks.

7.2. Use of reference samples

- Reference samples shall represent sample matrix, congener patterns and concentration ranges for PCDD/Fs and dioxin-like PCBs around the maximum or action level.
- A procedure blank, or preferably a matrix blank, and a reference sample at the maximum or action level have to be included in each test series. These samples must be extracted and tested at the same time under identical conditions. The reference sample must show a clearly elevated response in comparison to the blank sample, thus ensuring the suitability of the test. Those samples may be used for blank and recovery corrections.
- Reference samples chosen for performing a recovery correction shall be representative for the test samples, meaning that congener patterns shall not lead to an underestimation of levels.
- Extra reference samples at, e.g. 0,5× and 2× the maximum or action level may be included to demonstrate the proper performance of the test in the range of interest for the control of the maximum or action level. Combined, these samples may be used for calculating the BEQ-levels in test samples (see point 7.1.2.2).

7.3. Determination of cut-off values

The relationship between bioanalytical results in BEQ and results from confirmatory methods in TEQ shall be established (e.g. by matrix-matched calibration experiments, involving reference samples spiked at 0, 0,5×, 1× and 2× the maximum level (ML), with six repetitions on each level (n = 24)). Correction factors (blank and recovery) may be estimated from this relationship but shall be checked in each test series by including procedure/matrix blanks and recovery samples (see point 7.2).

Cut-off values shall be established for decision over sample compliance with maximum levels or for control of action levels, if of interest, with the respective maximum or action levels set for either PCDD/Fs and dioxin-like PCBs alone, or for the sum of PCDD/Fs and dioxin-like PCBs. They are represented by the lower endpoint of the distribution of bioanalytical results (corrected for blank and recovery) corresponding to the decision limit of the confirmatory method based on a 95 % level of confidence, implying a false-compliant rate < 5 %, and on a $RSD_R < 25$ %. The decision limit of the confirmatory method is the maximum level, taking into account the expanded measurement uncertainty.

In practice, the cut-off value (in BEQ) may be calculated from the following approaches (see Figure 1):

7.3.1. Use of the lower band of the 95 % prediction interval at the decision limit of the confirmatory method

$$\text{Cut-off value} = \text{BEQ}_{\text{DL}} - s_{y,x} \times t_{\alpha, f = m - 2} \sqrt{1/n + 1/m + (x_i - \bar{x})^2 / Q_{xx}}$$

with:

BEQ_{DL}	BEQ corresponding to the decision limit of the confirmatory method, being the ML taking into account the expanded measurement uncertainty
$s_{y,x}$	residual standard deviation
$t_{\alpha, f = m - 2}$	student factor ($\alpha = 5$ %, $f =$ degrees of freedom, single-sided)
m	total number of calibration points (index j)
n	number of repetitions on each level

x_i sample concentration (in TEQ) of calibration point i determined by a confirmatory method

\bar{x} mean of the concentrations (in TEQ) of all calibration samples

$$Q_{xx} = \sum_{j=1}^m (x_j - \bar{x})^2 \text{ square sum parameter}$$

i = index for calibration point i

7.3.2. Calculation from bioanalytical results (corrected for blank and recovery) of multiple analyses of samples ($n \geq 6$) contaminated at the decision limit of the confirmatory method, as the lower endpoint of the data distribution at the corresponding mean BEQ value:

$$\text{Cut-off value} = \text{BEQ}_{\text{DL}} - 1,64 \times \text{SD}_R$$

with

SD_R standard deviation of bioassay results at BEQ_{DL} , measured under within-laboratory reproducibility conditions

7.3.3. Calculation as mean value of bioanalytical results (in BEQ, corrected for blank and recovery) from multiple analysis of samples ($n \geq 6$) contaminated at two-thirds of the maximum or action level. This is based on the observation that this level will be around the cut-off determined under point 7.3.1 or 7.3.2.

Calculation of cut-off values based on a 95 % level of confidence implying a false-compliant rate $< 5 \%$, and a $\text{RSD}_R < 25 \%$:

1. from the lower band of the 95 % prediction interval at the decision limit of the confirmatory method,
2. from multiple analysis of samples ($n \geq 6$) contaminated at the decision limit of the confirmatory method as the lower endpoint of the data distribution (represented in the figure by a bell-shaped curve) at the corresponding mean BEQ value.

Figure 1

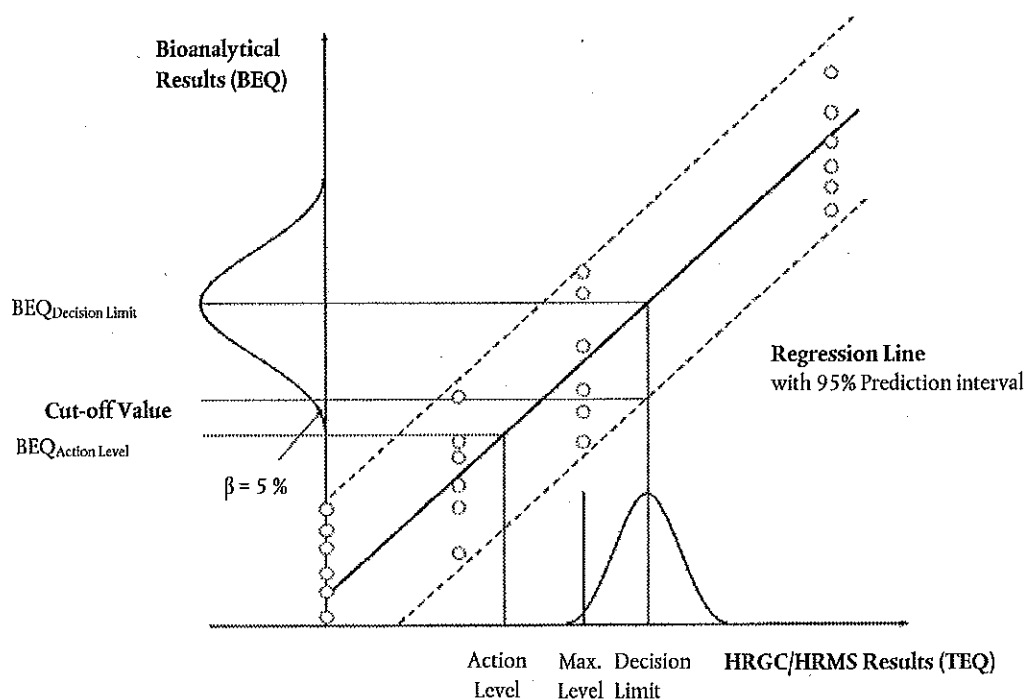

7.3.4. Restrictions to cut-off values

BEQ-based cut-off values calculated from the RSD_r achieved during validation using a limited number of samples with different matrix/congener patterns may be higher than the TEQ-based maximum or action levels due to a better precision than attainable in routine when an unknown spectrum of possible congener patterns has to be controlled. In such cases, cut-off values shall be calculated from an $RSD_r = 25\%$, or two-thirds of the maximum or action level shall be preferred.

7.4. Performance characteristics

- Since no internal standards can be used in bioanalytical methods, tests on repeatability shall be carried out to obtain information on the standard deviation within and between test series. Repeatability shall be below 20 % and intra-laboratory reproducibility shall be below 25 %. This shall be based on the calculated levels in BEQs after blank and recovery correction.
- As part of the validation process, the test must be shown to discriminate between a blank sample and a level at the cut-off value, allowing the identification of samples above the corresponding cut-off value (see point 7.1.2).
- Target compounds, possible interferences and maximum tolerable blank levels shall be defined.
- The per cent standard deviation in the response or concentration calculated from the response (only possible in working range) of a triplicate determination of a sample extract shall not be above 15 %.
- The uncorrected results of the reference sample(s) expressed in BEQs (blank and at the maximum or action level) shall be used for evaluation of the performance of the bioanalytical method over a constant time period.
- QCcharts for procedure blanks and each type of reference sample shall be recorded and checked to make sure the analytical performance is in accordance with the requirements, in particular for the procedure blanks with regard to the requested minimum difference to the lower end of the working range and for the reference samples with regard to within-laboratory reproducibility. Procedure blanks must be well controlled in order to avoid false-compliant results when subtracted.
- The results from the confirmatory methods of suspected samples and 2 to 10 % of the compliant samples (minimum of 20 samples per matrix) shall be collected and used to evaluate the performance of the screening method and the relationship between BEQs and TEQs. This database might be used for re-evaluation of cut-off values applicable to routine samples for the validated matrices.
- Successful method performance may also be demonstrated by participation in ring trials. The results from samples analysed in ring trials, covering a concentration range up to, e.g. $2 \times ML$, may also be included in the evaluation of the false-compliant rate, if a laboratory is able to demonstrate its successful performance. The samples shall cover most frequent congener patterns, representing various sources.
- During incidents, the cut-off values may be re-evaluated, reflecting the specific matrix and congener patterns of this single incident.

8. REPORTING OF THE RESULT

Confirmatory methods

- The analytical results shall contain the levels of the individual PCDD/F and dioxin-like PCB congeners and TEQ-values shall be reported as lower-bound, upper-bound and medium-bound in order to include a maximum of information in the reporting of the results and thereby enabling the interpretation of the results according to specific requirements.
- The report shall also include the method used for extraction of PCDD/Fs, dioxin-like PCBs and lipids. The lipid content of the sample shall be determined and reported for food matrices with maximum levels expressed on fat basis and with an expected fat concentration in the range of 0-2 % (in correspondence to existing legislation). For other samples, the determination of the lipid content is optional.

- The recoveries of the individual internal standards must be made available in case the recoveries are outside the range mentioned in point 6.2 where the maximum level is exceeded (in this case, the recoveries for one of the two duplicate analysis) and in other cases upon request.
- As the expanded measurement uncertainty is to be taken into account when deciding about the compliance of a sample, this parameter shall also be made available. Thus, analytical results shall be reported as $x \pm U$ whereby x is the analytical result and U is the expanded measurement uncertainty using a coverage factor of 2 which gives a level of confidence of approximately 95 %. In case of a separate determination of PCDD/Fs and dioxin-like-PCBs the sum of the estimated expanded uncertainty of the separate analytical results of PCDD/Fs and dioxin-like PCBs has to be used for the sum of PCDD/Fs and dioxin-like PCBs.
- The results shall be expressed in the same units and with the same number of significant figures as the maximum levels laid down in Regulation (EC) No 1881/2006.

Bioanalytical screening methods

- The result of the screening shall be expressed as compliant or suspected to be non-compliant ('suspected').
- In addition, an indicative result for PCDD/F and/or dioxin-like PCBs expressed in BEQ (not TEQ) may be given (see point 1). Samples with a response below the reporting limit shall be expressed as lower than the reporting limit. Samples with a response above the working range shall be reported as exceeding the working range and the level corresponding to the upper end of the working range shall be given in BEQ.
- For each type of sample matrix, the report shall mention the maximum or action level on which the evaluation is based.
- The report shall mention the type of test applied, the basic test principle and kind of calibration.
- The report shall also include the method used for extraction of PCDD/Fs, dioxin-like PCBs and lipids. The lipid content of the sample shall be determined and reported for food matrices with maximum levels expressed on fat basis and with an expected fat concentration in the range of 0-2 % (in correspondence to existing legislation). For other samples, the determination of the lipid content is optional.
- In the case of samples suspected to be non-compliant, the report needs to include a note on the action to be taken. The concentration of PCDD/Fs and the sum of PCDD/Fs and dioxin-like PCBs in those samples with elevated levels has to be determined/confirmed by a confirmatory method.
- Non-compliant results shall only be reported from confirmatory analysis.

Physico-chemical screening methods

- The result of the screening shall be expressed as compliant or suspected to be non-compliant ('suspected').
- For each type of sample matrix, the report shall mention the maximum or action level on which the evaluation is based.
- In addition, levels for individual PCDD/F and/or dioxin-like PCB congeners and TEQ-values reported as lower-bound, upper-bound and medium-bound may be given. The results shall be expressed in the same units and with (at least) the same number of significant figures as the maximum levels laid down in Regulation (EC) No 1881/2006.
- The recoveries of the individual internal standards must be made available in case the recoveries are outside the range mentioned in point 6.2 and in other cases upon request.
- The report shall mention the GC-MS method applied.
- The report shall also include the method used for extraction of PCDD/Fs, dioxin-like PCBs and lipids. The lipid content of the sample shall be determined and reported for food matrices with maximum levels expressed on fat basis and with an expected fat concentration in the range of 0-2 % (in correspondence to existing legislation). For other samples, the determination of the lipid content is optional.

-
- In case of samples suspected to be non-compliant, the report needs to include a note on the action to be taken. The concentration of PCDD/Fs and the sum of PCDD/Fs and dioxin-like PCBs in those samples with elevated levels has to be determined/confirmed by a confirmatory method.
 - Non-compliance can only be decided after confirmatory analysis.

Appendix

WHO-TEFs for human risk assessment based on the conclusions of the World Health Organisation (WHO) 0151 International Programme on Chemical Safety (IPCS) expert meeting which was held in Geneva in June 2005 ⁽¹⁾

Congener	TEF value	Congener	TEF value
Dibenzo-p-dioxins ('PCDDs')		'Dioxin-like' PCBs	
		Non-ortho PCBs + Mono-ortho PCBs	
2,3,7,8-TCDD	1		
1,2,3,7,8-PeCDD	1	Non-ortho PCBs	
1,2,3,4,7,8-HxCDD	0,1	PCB 77	0,0001
1,2,3,6,7,8-HxCDD	0,1	PCB 81	0,0003
1,2,3,7,8,9-HxCDD	0,1	PCB 126	0,1
1,2,3,4,6,7,8-HpCDD	0,01	PCB 169	0,03
OCDD	0,0003		
Dibenzofurans ('PCDFs')		Mono-ortho PCBs	
2,3,7,8-TCDF	0,1	PCB 105	0,00003
1,2,3,7,8-PeCDF	0,03	PCB 114	0,00003
2,3,4,7,8-PeCDF	0,3	PCB 118	0,00003
1,2,3,4,7,8-HxCDF	0,1	PCB 123	0,00003
1,2,3,6,7,8-HxCDF	0,1	PCB 156	0,00003
1,2,3,7,8,9-HxCDF	0,1	PCB 157	0,00003
2,3,4,6,7,8-HxCDF	0,1	PCB 167	0,00003
1,2,3,4,6,7,8-HpCDF	0,01	PCB 189	0,00003
1,2,3,4,7,8,9-HpCDF	0,01		
OCDF	0,0003		

Abbreviations used: 'T' = tetra; 'Pe' = penta; 'Hx' = hexa; 'Hp' = hepta; 'O' = octa; 'CDD' = chlorodibenzodioxin; 'CDF' = chlorodibenzofuran; 'CB' = chlorobiphenyl.

⁽¹⁾ Martin van den Berg et al., The 2005 World Health Organisation Re-evaluation of Human and Mammalian Toxic Equivalency Factors for Dioxins and Dioxin-like Compounds. Toxicological Sciences 93(2), 223-241 (2006).

ANNEX IV

SAMPLE PREPARATION AND REQUIREMENTS FOR METHODS OF ANALYSIS USED IN CONTROL OF THE LEVELS OF NON-DIOXIN-LIKE PCBs IN CERTAIN FOODSTUFFS

The requirements set out in this Annex shall be applied where foodstuffs are analysed for the official control of the levels of non-dioxin-like PCBs and as regards sample preparation and analytical requirements for other regulatory purposes, including the controls performed by the food business operator to ensure compliance with the provisions in Article 4 of Regulation (EC) No 852/2004.

The provisions on sample preparation provided for in point 3 of Annex III of this Regulation shall also be applicable for the control of the levels of non-dioxin-like PCBs in food.

1. Applicable detection methods

Gas Chromatography/Electron Capture Detection (GC-ECD), GC-LRMS, GC-MS/MS, GC-HRMS or equivalent methods.

2. Identification and confirmation of analytes of interest:

- Relative retention time in relation to internal standards or reference standards (acceptable deviation of $\pm 0,25$ %).
- Gas chromatographic separation of the non-dioxin-like PCBs (from interfering substances, especially co-eluting PCBs, in particular if levels of samples are in the range of legal limits and non-compliance is to be confirmed ⁽¹⁾).
- For GC-MS techniques:
 - Monitoring of at least the following number of molecular ions or characteristic ions from the molecular cluster:
 - two specific ions for HRMS,
 - three specific ions for LRMS,
 - two specific precursor ions, each with one specific corresponding transition product ion for MS-MS.
 - Maximum permitted tolerances for abundance ratios for selected mass fragments:
Relative deviation of abundance ratio of selected mass fragments from theoretical abundance or calibration standard for target ion (most abundant ion monitored) and qualifier ion(s): ± 15 %.
- For GC-ECD:
Confirmation of results exceeding the maximum level with two GC columns with stationary phases of different polarity.

3. Demonstration of performance of method:

Validation in the range of the maximum level (0,5 to 2 times the maximum level) with an acceptable coefficient of variation for repeated analysis (see requirements for intermediate precision in point 8).

4. Limit of quantification:

The sum of the LOQs ⁽²⁾ of non-dioxin-like PCBs shall not be higher than one-third of the maximum level ⁽³⁾.

5. Quality control:

Regular blank controls, analysis of spiked samples, quality control samples, participation in interlaboratory studies on relevant matrices.

⁽¹⁾ Congeners often found to co-elute are, e.g. PCB 28/31, PCB 52/69 and PCB 138/163/164. For GC-MS also possible interferences from fragments of higher chlorinated congeners have to be considered.

⁽²⁾ The principles as described in the 'Guidance Document on the Estimation of LOD and LOQ for Measurements in the Field of Contaminants in Feed and Food' [link to website] shall be followed when applicable.

⁽³⁾ It is highly recommendable to have a lower contribution of the reagent blank level to the level of a contaminant in a sample. It is in the responsibility of the laboratory to control the variation of blank levels, in particular, if the blank levels are subtracted.

6. Control of recoveries:

- Use of suitable internal standards with physico-chemical properties comparable to analytes of interest.
- Addition of internal standards:
 - Addition to products (before extraction and clean-up process),
 - Addition also possible to extracted fat (before clean-up process), if maximum level is expressed on fat basis.
- Requirements for methods using all six isotope-labelled non-dioxin-like PCB congeners:
 - Correction of results for recoveries of internal standards,
 - Generally acceptable recoveries of isotope-labelled internal standards are between 60 and 120 %,
 - Lower or higher recoveries for individual congeners with a contribution to the sum of non-dioxin-like PCBs below 10 % are acceptable.
- Requirements for methods using not all six isotope-labelled internal standards or other internal standards:
 - Control of recovery of internal standard(s) for every sample,
 - Acceptable recoveries of internal standard(s) between 60 and 120 %,
 - Correction of results for recoveries of internal standards.
- The recoveries of unlabelled congeners shall be checked by spiked samples or quality control samples with concentrations in the range of the maximum level. Acceptable recoveries for these congeners are between 60 and 120 %.

7. Requirements for laboratories

In accordance with the provisions of Regulation (EC) No 882/2004, laboratories shall be accredited by a recognised body operating in accordance with ISO Guide 58 to ensure that they are applying analytical quality assurance. Laboratories shall be accredited following the EN ISO/IEC 17025 standard. In addition, the principles as described in Technical Guidelines for the estimation of measurement uncertainty and limits of quantification for PCB analysis shall be followed when applicable ⁽¹⁾.

8. Performance characteristics: Criteria for the sum of non-dioxin-like PCBs at the maximum level

	Isotope dilution mass spectrometry ^(*)	Other techniques
Trueness	- 20 to + 20 %	- 30 to + 30 %
Intermediate precision (RSD _R)	≤ 15 %	≤ 20 %
Difference between upper and lower bound calculation	≤ 20 %	≤ 20 %

^(*) Use of all six ¹³C-labelled analogues as internal standards required

9. Reporting of results

- The analytical results shall contain the levels of the individual non-dioxin-like PCB congeners and the sum of non-dioxin-like PCBs, reported as lower-bound, upper-bound and medium-bound, in order to include a maximum of information in the reporting of the results and thereby enabling the interpretation of the results according to specific requirements.

⁽¹⁾ 'Guidance Document on Measurement Uncertainty for Laboratories performing PCDD/F and PCB Analysis using Isotope Dilution Mass Spectrometry' [link to website], 'Guidance Document on the Estimation of LOD and LOQ for Measurements in the Field of Contaminants in Feed and Food' [link to website].

- The report shall also include the method used for the extraction of PCBs and lipids. The lipid content of the sample shall be determined and reported for food matrices with maximum levels expressed on fat basis and with an expected fat concentration in the range of 0-2 % (in correspondence to existing legislation). For other samples, the determination of the lipid content is optional.
 - The recoveries of the individual internal standards must be made available in case the recoveries are outside the range mentioned in point 6, in case the maximum level is exceeded and in other cases upon request.
 - As the expanded measurement uncertainty is to be taken into account when deciding about the compliance of a sample, that parameter shall also be made available. Thus, analytical results shall be reported as $x \pm U$ whereby x is the analytical result and U is the expanded measurement uncertainty using a coverage factor of 2 which gives a level of confidence of approximately 95 %.
 - The results shall be expressed in the same units and with the same number of significant figures as the maximum levels laid down in Regulation (EC) No 1881/2006.
-

Annex VI:

Guidelines for monitoring chemical contaminants in the sea using marine organisms



UNITED NATIONS ENVIRONMENT PROGRAMME

SEPTEMBER 1992

*Guidelines for monitoring
chemical contaminants in
the sea using marine organisms*

Reference Methods For Marine Pollution Studies No. 6

Prepared in co-operation with



FAO



IOC



IAEA

UNEP 1992

NOTE: This document has been prepared in co-operation between the United Nations Environment Programme (UNEP), The Food and Agriculture Organization of the United Nations (FAO), the International Atomic Energy Agency (IAEA) and the Intergovernmental Oceanographic Commission (IOC) under project FP/S102-88-03 (2849).

For bibliographic purposes this document may be cited as:

UNEP/FAO/IOC/IAEA: Guidelines for monitoring chemical contaminants in the sea using marine organisms. Reference Methods for Marine Pollution Studies No. 6, UNEP 1992.

PREFACE

The Regional Seas Programme was initiated by UNEP in 1974. Since then the Governing Council of UNEP has repeatedly endorsed a regional approach to the control of marine pollution and the management of marine and coastal resources and has requested the development of regional action plans. The Regional Seas Programme at present includes ten regions and has over 120 coastal States participating in it (1),(2).

One of the basic components of the action plans sponsored by UNEP in the framework of the Regional Seas Programme is the assessment of the state of the marine environment and of its resources, and of the sources and trends of the pollution, and the impact of pollution on human health, marine ecosystems and amenities. In order to assist those participating in this activity and to ensure that the data obtained through this assessment can be compared on a world-wide basis and thus contribute to the Global Environment Monitoring System (GEMS) of UNEP, a set of Reference Methods and Guidelines for marine pollution studies are being developed as part of a programme of comprehensive technical support which includes the provision of expert advice, reference methods and materials, training and data quality assurance (3). The Methods are recommended to be adopted by Governments participating in the Regional Seas Programme.

The methods and guidelines are prepared in co-operation with the relevant specialized bodies of the United Nations system as well as other organizations and are tested by a number of experts competent in the field relevant to the methods described.

In the description of the methods and guidelines the style used by the International Organization for Standardization (ISO) is followed as closely as possible.

The methods and guidelines, as published in UNEP's series of Reference Methods for Marine Pollution Studies, are not considered as final. They are planned to be periodically revised taking into account the development of our understanding of the problems, of analytical instrumentation and the actual need of the users. In order to facilitate these revisions the users are invited to convey their comments and suggestions to:

Marine Environmental Studies Laboratory
IAEA Marine Environment Laboratory
19, Avenue des Castellans
MC 98000 MONACO

which is responsible for the technical co-ordination of the development, testing and intercalibration of Reference Methods.

-
- | | | |
|-----|----------------|--|
| (1) | UNEP: | Achievements and planned development of the UNEP's Regional Seas Programme and comparable programmes sponsored by other bodies. UNEP Regional Seas Reports and Studies No. 1 UNEP, 1982. |
| (2) | P. HULM: | A Strategy for the Seas. The Regional Seas Programme: Past and Future, UNEP 1983. |
| (3) | UNEP/IAEA/IOC: | Reference Methods and Materials: A Programme of comprehensive support for regional and global marine pollution assessments. UNEP 1990. |

- ii -

The present document was prepared at the initiative of FAO, the Food and Agriculture Organization of the United Nations as part of its contribution to the Regional Seas Programme and in particular the Mediterranean Action Plan. The assistance of Dr. G. Topping with this work is particularly appreciated. The document was subsequently edited at IAEA's Marine Environmental Laboratory and reviewed by GEMSI, the IOC/UNEP Group of Experts on Methods, Standards and Intercalibration. The assistance of all those who participated in this work is gratefully acknowledge.

CONTENTS

	<u>Page</u>
1. Scope and field of application	1
2. References	1
3. Introduction	2
4. Definitions	3
5. Aims of monitoring programmes	4
6. Pilot study	5
7. Designing a monitoring programme	6
8. Selection of contaminants	7
9. Selection of organisms	8
10. Location of sampling sites	10
11. Period and frequency of sampling	11
12. Size of sample	12
13. Selection of tissue	13
14. Appendix 1: Guidance on the planning of a pilot study	14
15. Appendix 2: Documentation of data	17
16. Appendix 3: Examples of chemical substances measured in marine organisms from monitoring purposes	18
17. Appendix 4: A) List of MED-POL species B) List of possible organisms for the assessment of contamination in the North Atlantic Region	19
18. Appendix 5: Detection of differences in levels of contaminants in marine organisms in relation to spatial; and trend monitoring programmes	21

1. SCOPE AND FIELD OF APPLICATION

This publication provides guidelines for monitoring chemical contaminants in the sea using measurements in marine organisms. It describes strategies for applying such measurements to the protection of public health, the assessment of the geographical distribution of contaminants and the evaluation of time trends in contamination which in turn can demonstrate the effectiveness of measures designed to control potential sources of pollution.

2. REFERENCES

The following are useful publications to consult in relation to the design, planning and conduct of marine pollution monitoring programmes using marine organisms:

- BRYAN, G.W., LANGSTONE, W.J. and HUMMERSTONE, L.G. (1980). The use of biological indicators of heavy metal contamination in estuaries. Marine Biological Association of the United Kingdom, Occasional publication Number 1, June 1980, 73 p.
- BURNS, K.A. and SMITH, J.L. (1981). Biological monitoring of ambient water quality: the case for using sentinel organisms for monitoring petroleum pollution in coastal waters. *Estuar. Coastal Shelf Sci.*, 13: 433-443.
- DAVIES, I.M. and PIRIE, J.M. (1980). Evaluation of a "Mussel Watch" project for heavy metals in Scottish Coastal waters. *Mar.Biol.*, 57: 87-93.
- GOLDBERG, E.D., BOWEN, V.T., FARRINGTON, J.W., HARVEY, G., MARTIN, J.H., PARKER, P.L., RISEBOROUGH, R.W., ROBERTSON, W., SCHNEIDER, E. and GANBLE, E. (1978). The "Mussel Watch". *Environ.Conserv.*, 5: 101-125.
- GORDON, M., KNAUER, G.A. and MARTIN, J.H. (1980). *Mytilus californianus* as a bio-indicator of trace metal pollution: variability and statistical considerations. *Mar.Pollut.Bull.*, 11: 195-198.
- PHILLIPS, D.J.H., (1980). Quantitative aquatic biological indicators: Their use to monitor trace metal and organochlorine pollution. Pollution Monitoring Series, London, Applied Science Publishers Ltd, 488 p.
- PHILLIPS, D.J.H. and SEGAR, D.A. (1986). Use of bio-indicators in monitoring conservative contaminants: Programme design imperatives. *Mar.Pollut.Bull.*, 17(1): 10-17.
- SEGAR, D.A. and STAMMAN, E. (1986). Fundamentals of marine pollution monitoring programme design. *Mar.Pollut.Bull.*, 17(5): 194-200.
- TOPPING, G. (1983). Guidelines for the use of biological material in the first order pollution assessment and trend monitoring. Dept. of Agriculture and Fisheries for Scotland, Marine Laboratory, Scottish Fisheries Research Report No 28. ISSN 0308 8022, 28 p.

3. INTRODUCTION

Marine organisms can accumulate contaminants from seawater, suspended particulate matter, sediments and their food. It has also been demonstrated, through field observations and experimental studies, that the concentration of some contaminants in tissues are related to the concentrations in the surrounding environment. This process, termed bio-accumulation, has been used by scientists to assess the marine contamination which has been caused by man's activities (eg. marine disposal of wastes by pipeline discharges and dumping from ships).

There are however certain difficulties in using bio-accumulators, or bio-indicators as they are sometimes known, for this purpose. For example, individuals of the same species exposed to the same concentration of contaminants for the same period of time will not accumulate the substances at the same rate. This is related to such factors as age, sex, size and physiological state of the individual. Similarly, different species do not bio-accumulate to the same level when they are exposed to the same concentration of contaminant in sea water, and often have different rates of contaminant elimination.

Therefore, careful consideration must be given to the above factors when a monitoring programme is designed in order to reduce (or allow for) the effects of natural variability.

This document provides guidance on the design of such programmes and is intended for scientists who are responsible for marine pollution monitoring programmes. It is particularly aimed at programmes which fall under the auspices of the UNEP, IOC and FAO.

The guidelines presented in this report cover the following aspects of marine pollution monitoring programmes:

- aims
- pilot studies
- criteria for the selection of contaminants, organisms and locations to be studied
- size of sample
- frequency of sampling operations
- tissue selection.

Although an important component of these programmes is the analysis of contaminants in samples, this matter will not be addressed in detail in this document since other UNEP Reference Methods For Marine Pollution Studies cover this topic. Readers of this document are therefore advised to have the relevant analytical documents to hand (see UNEP/IOC/IAEA 1990); particularly "Contaminant monitoring programmes using marine organisms: Quality Assurance and Good Laboratory Practice" Reference Method No 57, since this deals with all aspects of work which influence the quality of data.

4. DEFINITIONS

Before discussing the programmes for which these guidelines may be used, it is necessary to define some of the more important terms which are used in this report.

Term	Definition
Accuracy, precision limit of detection	See definitions in Appendix 2 of Reference Method No 57.
Anthropogenic	Derived from human activity
Contamination	in the context of the marine environment this term describes a situation where either the concentrations of some natural substances (eg. metals) are clearly above normal values, or the concentrations of man-made substances (eg. DDT) is detectable but which do not necessarily cause deleterious effects (referred to as pollution, see definition below).
Bio-indicator	A species which accumulates a contaminant in its tissue in amounts that are proportional to the levels of the contaminant in the local environment (ie. water, sediment and food).
Hot spot	An area of the sea where there is a significantly high level of contamination
Pollution	The Group of Experts on Scientific Aspects of Marine Pollution defines pollution as "the introduction by man, directly or indirectly, of substances or energy into the marine environment (including estuaries) which results in such deleterious effects as harm to living resources, hazards to human health, hindrance to marine activities including fishing, impairment of quality for use of seawater and reduction of amenities."
Monitoring	A programme of repeated measurements of contaminants in marine samples which is carried out for a specific purpose eg. annual measurements of mercury in the edible tissue of fish to provide information on the potential annual intake of mercury by consumers. A study of mercury in fish which examines levels in different species would not be classed as monitoring. If, however, this study was repeated in subsequent years these sets of data would be classed as 'monitoring data'.

Pilot study	Measurements of contaminants in marine samples, in an area not previously studied, to investigate the current levels of contamination. This work is a prerequisite to a monitoring programme since the information collected in this study enables the investigator to design the sampling programme suited to the specific aims of the monitoring work. Without such information the investigator may be unable to judge which contaminants, organisms and locations to select for the monitoring programme.
Quality Assurance	All procedures that are carried out by a laboratory to ensure that it produces data of the appropriate quality to meet the defined aims of its monitoring programme. Quality Assurance essentially consists of two elements - quality control and quality assessment. Definitions of these latter terms are given in UNEP Reference Method No 57.

5. AIMS OF MONITORING PROGRAMMES

There are three principal aims of monitoring programmes which involve the collection and analysis of marine organisms; they are:

- to compare contaminant levels in the edible tissues of marine organisms against national limits and to provide data to calculate the potential amount of contaminant taken in by consumers (ie Public Health monitoring).
- to compare the levels of contamination in different geographical areas (Spatial Monitoring). Such measurements are often made to assess whether the current discharges of wastes are producing unacceptable levels of contamination ie they are causing, or likely to cause, marine pollution problems.
- to measure the levels of contaminants over time at particular locations to judge whether they are changing in relation to the inputs of contaminants (ie Trend Monitoring). Such measurements are made to assess the efficiency of measures taken to reduce pollution.

Investigators should write down the specific aims of each monitoring programme before commencing any field measurements. These aims are needed to narrow the list of parameters, species and sites to be investigated). There are two distinct aspects of aims:

Environmental management - Are standards complied with? What is the spatial extent of contamination? What are the changes of levels with time in relation to changes in inputs of contaminants?

Environmental science - Statistical significance of differences in levels of contaminants - representative sampling of the population - selection of analytical methods with the required accuracy and precision.

6. PILOT STUDY

This assists the investigator in the design of an efficient monitoring programme for each specific aim. Provided a pilot study is carefully planned (see Appendix 1 for guidance), it can provide the following information:

- a) In relation to public health studies, it can identify the relevant edible species, particularly the ones which contain elevated levels of regulated contaminants and therefore merit further investigation to determine the need for additional regulatory action, such as input controls or restriction on the harvesting or consumption of fish/shellfish.
- b) It can identify which areas of the marine environment are sufficiently contaminated to warrant monitoring.
- c) It can provide an indication of the variability of contaminant levels in individuals of the same species from the same population and location. This information is essential to an investigator wishing to establish a programme of trend monitoring. Without it, he may not be able to judge whether his sampling and analytical work will be sufficiently detailed to detect changes in contaminant levels with time against the natural fluctuations that may exist in any population of organisms.
- d) It can identify which tissues of organisms, particularly fish and large shellfish, are the most appropriate ones to use in specific monitoring programmes since not all tissues reflect changes in the levels of contaminants in the environment to which the organism is exposed.
- e) It can identify, and sometimes quantify, inputs of contaminants to the study area. This will help the investigator to select which contaminants should be given priority, if the resources for monitoring are limited, and in which areas contaminated organisms are likely to be found.

A pilot study can easily be expanded in order to accommodate measurements of biological effects. These effects may include changes in community structure and populations or adverse changes in the biochemistry of organisms (for example, acetyl cholinesterase depression by organophosphorus pesticides). Linkage of "levels" with "effects" is an important step in a complete pollution assessment. When effects are noted on a pilot scale, associated with specific contaminants or groups of contaminants, a strong case can be made for incorporating such contaminants in a full-scale monitoring programme and for taking immediate measures for their control and abatement. Details of some biological effects measurements are included in the Reference Method Series (see UNEP/IOC/IAEA, 1990).

Once a pilot study has been successfully completed, and the results evaluated, the investigator should prepare a protocol for each specific monitoring programme for the collection and analysis of samples. This protocol will specify what information is required to meet the specific aims, and the criteria to obtain the required quantity and quality of data. Time spent on the planning of a statistically significant sampling and analytical programme, will inevitably produce a more efficient programme which makes the best use of the laboratory's most important resource (ie staff time). Initially, it is generally sensible to conduct a programme which satisfies essential, rather than very ambitious, aims. It is relatively easy to expand this basic programme if extra resources become available. Finally, it is necessary to review the monitoring programme on a regular basis, to assess how well the aims are being met. This review may result in a reduction of effort on sampling and analyses, and the time gained can be usefully employed on other aspects of marine pollution studies. However, it might identify the need to put in more effort.

7. DESIGNING A MONITORING PROGRAMME

There are a number of factors to be considered in the planning of a monitoring programme which is to meet specific aims:

- a) Which contaminants should be measured?
- b) Which organism(s) should be selected?
- c) Where should the samples be collected?
- d) When should the sampling be done and how frequently should it be carried out?
- e) How many individual organisms should be collected on each sampling occasion and which size(s) should be included in each sample?
- f) Which tissue(s) of the organism(s) should be selected for analysis?

It is the principal investigator, together with a knowledgeable statistician and biologist, who will have to do this evaluation, design and plan the sampling work, prepare the necessary instruction sheets for the field staff, discuss with the analysts the precautions to be taken by staff in the storage and processing of samples prior to their analysis.

Specifically, the investigator will have to do the following:

- (i) Design a sampling programme for the organisms of interest; selecting sufficient numbers, and sizes, of individuals at each site at appropriate intervals of time to take into account the inherent variability of contaminant levels in the organisms. This work will be done on the basis of the results obtained from the pilot study and any relevant information from other similar studies. Sampling must be designed to provide a statistically sound basis on which to judge changes in contaminant levels. Once this sampling programme has been designed, instruction sheets should be prepared and issued to the field staff.
- (ii) Ensure that samples are collected, stored and transported to the laboratory in a way which minimizes losses and gains of contaminants prior to analysis. Guidance on this can be obtained by consulting the relevant documents in the UNEP Reference Methods series. Again it will be necessary to prepare instruction sheets for field and laboratory staff.
- (iii) Arrange for the processed samples to be analyzed using methods which have the required accuracy and precision. Experience has shown that close collaboration between the principal investigator and the analysts is essential if this work is to be successful. The investigator and the principal analyst should consult the UNEP Reference Method No 57 which gives guidelines on Quality Assurance, if they are in any doubt about how to achieve and maintain the required quality of analytical data.
- (iv) Ensure that there is an adequate system of documentation to allow samples to be traced from the time of collection to the recording of analytical data. The investigator should ensure that all relevant staff are aware of, and comply with, the system of documentation (see Appendix 2 for more details on this matter).

Each of the factors a - f will now be considered in more detail.

8. SELECTION OF CONTAMINANTS

The selection of substances to be monitored will be determined by a) the aims of the monitoring programme, b) the findings of the pilot study (ie which contaminants, present at significant levels above the background values, justify further study), and c) the ability of the analyst to measure these substances with the required accuracy and precision. In practice the last factor will often determine whether a particular contaminant or group of contaminants can be included in the monitoring programme.

It is essential that the principal investigator and the principal analyst agree to the required accuracy, precision and limit of detection for the measurements to ensure that the necessary standards of analysis are achieved eg. it would be inappropriate to consider measurements of specific changes in contaminant levels using an analytical method which had an inadequate level of precision.

If the analytical method used in the pilot study does not meet the required standard for the specific monitoring purposes, the analyst must select another method which meets the required standard. If for any reason this is not possible (eg. there is a statutory requirement to use a particular method) the investigator should abandon the proposed monitoring programme. Any other action will merely result in wasted effort, since the aims will not be met using an inadequate analytical method. However, it must be stressed that the use of an analytical method which, in theory, has the required performance characteristics to meet the aims does not necessarily guarantee success. Other factors have to be taken into account in obtaining the required quality of analytical data. These are discussed in some detail in "Quality Assurance and Good Laboratory Practice in relation to Marine Pollution Monitoring Programmes", UNEP Reference Method No 57. Investigators are strongly advised to obtain a copy of this document for analysts at the outset of the work.

In addition to selecting contaminants to meet the aims of the laboratory's marine pollution programme, it may be appropriate to include other contaminants which meet regional and international needs. This should only be considered if the additional data is useful to the laboratory, or if it is part of the laboratory's commitment to Regional Studies, and does not jeopardize the main aims of the laboratory's monitoring programme. A list of contaminants, identified by some organizations (International Council for the Exploration of the Seas, Oslo and Paris Commission's Joint Monitoring Group) for monitoring work in the North Sea and adjacent waters as well as those recommended (category I and II substances) for the MED POL programme are given, for information, in Appendix 3.

The final selection of contaminants should also be related to knowledge of their likely sources (eg. an extensive monitoring programme for pesticides along a desert coastline would be unwarranted) and information from scientific literature on their transport and persistence in the environment. Such information will also help to identify which environmental compartment should most usefully be monitored. As an example, organophosphorus pesticides are rapidly metabolized by many marine organisms but are rather persistent in sediments. It would be pointless to monitor them in biota but highly relevant to monitor their biological effects.

9. SELECTION OF ORGANISMS

9.1 Spatial and trend monitoring

Experience has shown that the most reliable data on contaminant trends in organisms are obtained by sampling organisms which have the following characteristics:

- A simple relationship exists between contaminant residues in the organisms and the average concentrations in the surrounding seawater or sediments.
- The organism accumulates the contaminant without being affected by the levels encountered.
- The organism is sedentary and thus representative of the area of collection.
- The organism is widespread in the study region, to allow comparisons between different areas.
- The organism is sufficiently long-lived, to allow sampling of more than one year class if desired.
- The organism is of a reasonable size, to give adequate tissue for analysis.
- The organism is easy to sample and robust enough to survive in the laboratory, allowing (if desired) depuration before analysis and, if needed, studies of uptake of contaminants.
- The organism exhibits high concentration factors, to allow direct analysis without pre-concentration.
- The organism is tolerant of brackish water, to allow comparisons to be made between estuarine and offshore sites.

These characteristics restrict the useful organisms to a range of fairly large, abundant, widespread, inter-tidal organisms, mainly molluscs. Filter-feeding molluscs are more likely to reflect contaminants in the water column, whilst deposit feeders will also be influenced by sediment chemistry. The working of the sediments both by organisms and water currents will cause an averaging of short-term variations in contaminant loading. Water chemistry, however, will more rapidly respond to effluent discharges and dispersal conditions at the time of sampling. Filter-feeders are therefore more likely to provide the information required to fulfill the objectives of a monitoring programme concerned with water quality. In Appendix 4, lists are given of organisms which some scientists in the United Kingdom have suggested may be used for monitoring a range of metals and organochlorine compounds in either rocky or muddy inter-tidal areas in UK waters.

In practice the selection of an organism, for monitoring purposes, is determined by its availability in the study area and its known ability to act as a bio-indicator. If this latter information is not known it must be obtained from either the scientific literature (eg. Phillips 1980), or the pilot study. Final selection should be made in consultation with a knowledgeable biologist. Common mussels, (*Mytilus edulis*, *M. californianus* and *M. galloprovincialis*), that are used in global mussel watch programmes are generally suitable for spatial and trend monitoring programmes in coastal waters.

Other species of shellfish, and fish, can be used for spatial and trend monitoring purposes provided the organism can be shown to accumulate the specific contaminant(s) and that the concentrations of the contaminant(s) are in proportion to the concentrations in either water or sediment or food.

9.2 Public Health programmes

If the pilot study has revealed that edible species from the local fishery contain levels of contaminants which approach or exceed statutory limits for contaminants in foodstuffs, then these organisms should be included in any subsequent public health monitoring programme.

Since permissible limits of some contaminants (eg. Cd) in foodstuffs are extremely low, the analytical method for this work must be capable of producing the required data quality. A high degree of accuracy, and a detection limit which is ca 1/10 of the permissible concentration of the contaminant in the foodstuff, are essential for this work. These criteria enable the analyst to have confidence in the results that are provided to managers for regulatory purposes.

10. LOCATION OF SAMPLING SITES

10.1 Spatial and trend monitoring

Hot spots are usually found in estuarine and coastal areas where anthropogenic wastes are discharged. The offshore areas where hot spots are most likely to occur are those used for the dumping of wastes from ships or those in the vicinity of offshore oil platforms.

A decision to monitor contaminant levels in 'hot spots' should be taken only after careful consideration of the discharges to these areas. If, as a result of the pilot study, the relevant authorities decide to reduce inputs then it would be appropriate to monitor to judge whether the new controls have been effective in reducing levels in organisms. If no action is to be taken on the regulation of discharges then monitoring is only justified if there is a good reason to update the information collected in the pilot study.

Other estuarine, coastal and offshore sampling sites may be included in the programme to provide coverage of both clean and moderately contaminated areas. All sampling should be done by scientific personnel operating from research or chartered vessels, rather than by fishermen, to ensure that contamination of the samples during and after collection is kept within acceptable limits.

For long-term monitoring programmes, the precise locality of sampling sites should be registered as very small spatial variation may strongly influence the final data (ie "mussels from the harbour wall" should specify which point in the harbour wall). In some cases it may be useful to photograph the sites, particularly where intertidal organisms are taken.

10.2 Public Health Programmes

In some countries there may be officials who are knowledgeable about the edible species of fish and shellfish caught by commercial fishermen. Investigators may find it helpful to discuss their proposed monitoring programme with such officials since they can often offer valuable advice in the design of the collection programmes.

Samples of fish and shellfish may be obtained from the fish markets or from fishing vessels or research ships which are operating in traditional fishing areas. The basic requirement is a representative sample of the species normally consumed by the general public. It should be noted, however, that some countries may specify the exact sampling procedures for public health monitoring.

Commercial fishermen do not usually take any special precautions during the collection, storage, transport and off-loading of their catches, other than to ensure that they are presentable enough for sale. The retailer and the consumer do not normally adopt any stringent dissection procedures, other than from a public health viewpoint. The scientist, however, will use careful sampling and pre-treatment procedures to ensure that contamination is kept within acceptable limits. These different approaches to sampling may lead to differences in the amount of contaminants found in the samples. In general the scientific samples will be less contaminated than those taken from fish markets, fishing boats and fish retailers.

The final decision on where and how to collect samples for public health monitoring will depend on whether information is required on actual contaminant intake by the consumer (in which case samples will be taken from the fish markets or fish retailers) or whether the aim is to determine which edible species and areas are exposed to contamination (in which case the sampling must be done by scientific staff).

11. PERIOD AND FREQUENCY OF SAMPLING

11.1 Spatial and trend monitoring

For spatial monitoring, collections should be made over a short interval of time (within weeks rather than months) to enable a synoptic comparison of concentrations of contaminants at different sites. This also helps to ensure that organisms are in the same physiological state. If major annual changes in the quantity and/or composition of inputs are anticipated it would be appropriate to conduct an annual or biennial sampling. Experience has shown that the effects of changes in inputs of contaminants are often confined to the area in the immediate vicinity of the discharge. It is these areas where more frequent monitoring should be conducted.

For trend monitoring, the frequency of sampling will a) reflect the time scales over which the changes are required to be detected, b) the degree of confidence required in the measurement of these changes, and c) the available laboratory resources. Investigators should note that there is nothing more frustrating and time-wasting than a programme in which the proposed work is well below the minimum standard required to detect the desired changes in contaminant levels. If, for any reason, the resources are insufficient to meet the specific aims of the programme, then the programme should be canceled and replaced with one which has less ambitious aims but which can be carried out successfully with available resources.

If no changes in inputs are expected, then it would be sensible to restrict sampling to ca 5 yearly intervals. A more frequent sampling programme can only be justified if there is a need to provide more regular data for other purposes eg. to reassure the general public that levels of contaminants are not changing.

Seasonal variations in food supply, and the spawning cycle, are known to cause changes in total body weight, as well as lipid concentration and composition and, these may influence contaminant levels in the tissues of some organisms. In order to minimize these variations, it is suggested that sampling be undertaken at the pre-spawning period.

11.2 Public Health monitoring

Unless there is a seasonal fishing pattern for some species, samples may be taken at any time of the year. Ideally all species should be sampled at the same time so that a synoptic picture of the contaminant levels can be obtained. A typical monitoring programme might consist of a survey every 5 years. A more frequent sampling programme (ie annual) will be needed if the results of the pilot programme show that concentrations of contaminants in foodstuffs approach or exceed permissible limits for foodstuffs. Increased sampling should be confined to the particular species and contaminants which give cause for concern.

12. SIZE OF SAMPLE

12.1 Spatial and trend monitoring

Ideally, the investigator will have established the relationship between contaminant levels and size of organisms from the results of the pilot study. It is good practice to select a particular size or size range to minimize the variance of contaminant levels from sample to sample. The number of individuals required for each sample will be determined by the magnitude of the change that is considered to be significant in relation to the specific aims. The smaller the difference the greater the number of individuals required for each sample. (See Appendix 5 for further guidance)

If the relationship between size of organism and contaminant level has not been obtained from the pilot study then a sufficient number of individuals should be collected at one of the sampling sites to cover the size range of organisms in the population, to establish the variability of contaminant levels with size. This is a minimum requirement since, ideally, this sampling procedure should be done at all sites. The information on variability at one site will allow the investigator to make comparisons with other sites where individuals of a limited size range are collected.

If either analytical resources or sample material is limited it may not be practical for the individuals from each site to be analyzed separately. In this case, individuals should be combined to make one sample (often referred to as 'pooled' samples). For 'pooled samples', no information will be obtained on the variation of contaminant levels with size but the data can be used to assess site to site differences with some level of confidence, provided that a number of replicate analyses are done on each of the 'pooled' samples, and the 'pooled' samples consist of individuals from the same size range.

12.2 Public Health monitoring

The size(s) of organisms to be sampled should be based on information on consumption patterns. If a range of sizes is sold, then these different sizes should be analyzed. The number of individual organisms in each sample will be influenced by the importance of the species as a foodstuff, the availability of scientific manpower and the need to sample sufficient numbers of each species and of each size category to cover the range of values encountered in a typical population or catch. Generally, a sample of 5-10 individuals from each size range of fish and large shellfish (crabs, lobsters) and ca 50 individuals for smaller shellfish (eg. mussels, shrimps) would be sufficient.

13. SELECTION OF TISSUE

13.1 Spatial and trend monitoring

For invertebrates, whole soft tissue (less viscera) should be taken for analysis.

For fish, muscle is the most useful tissue for most purposes. However, liver and kidney tissues have been used for studies of fish and the digestive gland of large crustaceans. In general, whole soft tissue is taken for smaller shellfish.

13.2 Public Health monitoring

Only edible tissue need be analyzed for contaminants - usually this means muscle tissue for fish and large crustaceans and whole soft tissue (less viscera, ie guts, gills and gonad) for small shellfish.

Every opportunity should be taken to collect data on the size (or length) and age of the species. This may be relevant to subsequent decisions on regulatory action.

13.3 Normalization procedures

It is usual to report all tissue data on a dry weight basis (ie. g contaminant/g (dry weight)). However, some literature values use wet weight which may be required for public health studies. Since drying is a common part of most analytical protocols (see RM. No. 7 "Sampling of selected marine organisms and sample preparation for trace metal analysis" and RM. No. 12 "Sampling of selected marine organisms and sample preparation for the analysis of chlorinated hydrocarbons"), the reader is advised to record wet/dry weight ratios on a routine basis.

In the case of lipophilic contaminants, such as chlorinated hydrocarbons, contaminant concentrations are often expressed in terms of g contaminant/g HEOM (where HEOM is Hexane Extractable Organic Matter, principally lipid). This procedure enables a certain degree of normalization for seasonal or spatial variations in the lipid content of sentinel organisms and facilitates the comparability of data.

Appendix 1

GUIDANCE ON THE PLANNING OF A PILOT STUDY

Desk Study

It is important to determine what is known about contaminants in the proposed study area, before any field work is done. Some of this information can be found by reviewing the relevant scientific journals and other published material (eg. books, conference proceedings).

Annual reports of other marine institutes, local and central government and industrial research laboratories are also useful sources of data, as are unpublished scientific reports from these organizations. If these latter sources provide useful data, it is good practice to contact scientists from the relevant organizations to identify whether there is any other unpublished data or information, which might be useful to the investigator.

This review can often provide data on the current levels of contamination in water, sediments or biota and occasionally information on inputs of contaminants to the area via rivers, pipelines or dumping from ships. It may also reveal the type of industry and agriculture located in the coastal region, the range and scale of potentially toxic substances used by them, and possibly information on their discharges to the rivers and sea. These latter data should be verified by contacting the local or national authority, which has responsibility for regulating discharges to rivers and coastal waters. This authority should also be approached for information on the past and present discharges to the area.

For public health work, the investigator should identify which fish and shellfish species are caught for human consumption, and whether there are relevant permissible limits for contaminants in marine foodstuffs. Information on commercial catches can be obtained from either the local fishermen or their representative organizations or the local or central government fisheries department. Information on food standards can be obtained from the local environmental health department or the central government department responsible for food safety. It is difficult to be more specific about the exact sources of the above information in each country since they do vary from country to country.

This review should enable the principal investigator to identify the group of contaminants, and specific fish and shellfish, which should be given priority in the pilot study for public health purposes. It will also give some general guidance on the species to be selected for spatial and trend monitoring purposes. However, before the principal investigator can plan this latter work he needs to do some additional desk work to identify the locations where samples should be collected.

Identifying sampling sites

It is essential that the pilot study covers the areas which are likely to be contaminated and the areas which, from a hydrographic and input viewpoint, are unlikely to be significantly affected (ie sites located well offshore from industrialized areas or those located in inshore areas next to less populated and industrialized areas).

The level and extent of contamination in coastal and estuarine waters is determined by:

- the rate of input of contaminants
- the location of the individual inputs
- the composition of the waste - whether the contaminants are in solution, attached to solids or associated with mixtures of solid and liquid
- the dilution and dispersion of wastes following discharge, and in the case of discharges containing solids, the settlement of solid material to the sea bed sediments
- the physical and chemical processes in the sea (ie adsorption and desorption of substances between dissolved and particulate phases of seawater).

Unless the principal investigator has a good working knowledge of hydrography of the local area, it will be necessary to seek the help of an hydrographic expert to determine the optimum locations for sampling in relation to known inputs.

Assuming the principal investigator can provide the hydrographer with the relevant information on inputs, and that his colleague has a good understanding of the hydrographic characteristics of the area (direction, speed and variability of currents, salinity and temperature of the water masses, and the freshwater flows to the sea) it should be possible to calculate the theoretical dilution and dispersion of wastes at estuarine and coastal sites. This information can then be used to identify the locations where organisms are exposed to contamination and the adjacent areas where they will probably not be subject to contamination (ie clean or control areas).

If expert hydrographic advice is not available, the principal investigator should establish a sampling grid along the likely gradient of contamination; with sampling sites located at progressively increasing distances from the input (100m, 300m, 1000m, 3000m etc.). If a river is the principal source of contamination to the study area, the investigator can establish his sampling grid along the salinity gradient. It is relatively easy to calculate the dilution of river water, and the corresponding dilution of contaminants, by measuring the salinity at locations in an estuary and comparing these measurements with the salinity values of the water entering the estuary. For this calculation, the investigator assumes that river water has zero salinity and that the contaminants behave conservatively during mixing of freshwater and seawater.

Sample size

The concentration of some contaminants can vary with size of the organisms. It is important in spatial and trend monitoring to reduce this source of variability in the data to detect differences in contaminant levels between sites and with time (see Appendix 5). If this relationship is not known by the investigator prior to the commencement of monitoring, it will be necessary to establish it during the pilot study.

To do this, the investigator must collect a representative sample of each population of species at each sampling site. This sample should include sufficient numbers of individuals to cover the range of sizes/ages/lengths of individuals in each population. The investigator should consult a knowledgeable biologist for guidance on the range of sizes that might be expected for each species.

Selection of tissue

Although there is considerable scientific literature on the accumulation of contaminants by different tissues (eg. Phillips, 1980), it is advisable for the investigator to check this aspect for the specific organisms to be examined in the pilot study. It is also advisable to consult a biologist to determine the best procedure for dissection of organisms into their constituent parts, to ensure that there is no possibility of one tissue being contaminated by another.

Ideally, the investigator should investigate the relationship between the contaminant level, tissue and size of organism by analyzing tissue from individuals of different sizes rather than by analyzing pooled samples; even if the latter consist of a number of individuals of the same size or size range. However, if analytical resources are limited, it may be necessary for him to establish this relationship by analyzing pooled samples.

Appendix 2

DOCUMENTATION OF DATA

The adoption of the following guidelines by a laboratory should provide adequate documentation to allow it to trace samples from the collection stage to the completion of its analyses by providing a record of the appropriate data in logbooks or in computer files.

Documentation

- (i) Descriptions of the sampling strategy, methods of sample collection, procedures for storage, and pre-treatment and analytical procedures, plus a list of ancillary site observations;
- (ii) Sample documentation (description of organisms, numbers of individuals collected for each sample, weights of tissue taken for analysis (individual tissue or homogenate) plus ancillary data on organisms (length, weight and age);
- (iii) Description of analytical procedures, including details of accuracy, precision and limit of detection;
- (iv) Description of quality control and quality assessment and evidence that these procedures have been applied and have provided acceptable data;
- (v) Description of working standards used on each occasion and calculations of results;
- (vi) A secure system for the long term storage of data either in logbooks or computer files is essential. It is also advisable to have a duplicate set of records in case one is lost, mislaid or accidentally destroyed;

Advice should be sought on the correct method of storing computer tapes and/or discs to ensure the long-term stability of data files.

Storage of data

It has been shown that even the most experienced personnel can make simple arithmetic errors in calculating results. Thus, a check should be made for such errors before compiling tables of results. Once this check has been MADE it is appropriate to carry out a preliminary assessment of the quality of the data, prior to its evaluation and publication, to ensure that no erroneous results are included. This assessment can include a comparison of the results with existing data (ie data for the study area either previously collected by the laboratory or data published in the literature). Before consigning data to long term storage, a final check should be made to ensure that no errors have been made in transcribing the data (ie the re-typing of data sets by typists or data processors can sometimes lead to such errors).

Appendix 3

EXAMPLES OF CHEMICAL SUBSTANCES MEASURED IN MARINE ORGANISMS FOR MONITORING PURPOSES

(SOURCE:

Trace metals

Arsenic (As), Cadmium (Cd), Chromium (Cr), Copper (Cu), Lead (Pb), Mercury (Hg), Nickel (Ni), Tin (Sn), and Zinc (Zn).

DDT and its metabolites

o,p'-DDD, p,p'-DDD, o,p'-DDE, o,p'-DDT, and p,p'-DDT.

Chlorinated pesticides other than DDT

Aldrin, Alpha-Chlordane, Trans-Nonachlor, Dieldrin, Heptachlor, Heptachlor epoxide, Hexachlorobenzene, Lindane (gamma-BHC), and Mirex (+ Endosulfan ?)

Polychlorinated biphenyls (PCBs)

Measurements are usually restricted to either a small number of individual compounds (known as congeners) or to the total concentration of PCBs.

Polyaromatic hydrocarbons

These can include:

2-ring compounds	Naphthalene, 1-Methylnaphthalene, 2-Methylnaphthalene, 2,6-Dimethylnaphthalene, and Acenaphthene.
3-ring compounds	Fluorene, Phenanthrene, 1-Methylphenanthrene and Anthracene.
4-ring compounds	Fluoranthrene, Pyrene, and Benz(a)anthracene
5-ring compounds	Chrysene, Benzo(a)pyrene, Benzo(e)pyrene, and Dibenz(a,h)anthracene.

For the purposes of the Long-term programme for pollution monitoring and research in the Mediterranean sea (MED POL - Phase II) the following chemical contaminants were identified for analysis in marine organisms.

category I (mandatory)

total mercury
organic mercury
cadmium
halogenated hydrocarbons

category II (optional)

total arsenic
radionuclides
polynuclear aromatic hydrocarbons

Appendix 4

A. LIST OF MED-POL SPECIES

For the purposes of the Long-term programme for pollution monitoring and research in the Mediterranean sea (MED POL - Phase II) the following species (nearly all edible), representing different ecotypes, are recommended for the monitoring of chemical contaminants in marine organisms.

a) Bivalves

Mytilus galloprovincialis, or

Mytilus edulis, or

b) Demersal fish

Perna perna, or

Donax trunculus

M. edulis, P. perna or D. trunculus can only be monitored as alternative species if Mytilus galloprovincialis does not occur in the area.

Mullus barbatus, or

Mullus surmuletus, or

Upeneus molluccensis

M. surmuletus or U. molluccensis can only be monitored as alternative species if Mullus barbatus does not occur in the area.

c) Pelagic carnivore fish

Thunnus thynnus, or

Thunnus alalunga, or

Xiphias gladius

d) Pelagic plankton feeding fish

Sardina pilchardus

Other clupeids should only be monitored as alternative species if S. pilchardus does not occur in the area.

e) Crustaceans

Parapenaeus longirostris, or

Nephrops norvegicus, or

Penaeus kerathurus

N. norvegicus or P. kerathurus can only be monitored as alternative species if P. longirostris does not occur in the area.

**B. LIST OF POSSIBLE ORGANISMS FOR THE ASSESSMENT OF
CONTAMINATION IN THE NORTH ATLANTIC REGION**

	Cd	Hg	Cu	Cr	Pb	Zn	HH	PHC
Rocky substrate								
<u>Mytilus edulis</u> (common mussel)	+		?	+	+	+	+	+
<u>Littorina littorea</u> (gastropod)	+		+	?	+	+		
<u>Patella vulgata</u> (limpet, gastropod)	+		+		+	+		
Muddy substrate								
<u>Scrobicularia plana</u> (da Costa) (peppery furrow bivalve)	+	+	?	+	+	+		
<u>Macoma balthica</u> (bivalve)	+	+	?	+	+	+		
<u>Nereis diversicolor</u> (annelid)	+	+	+	+	+	+		

Key: + = appears to act as good indicator
 ? = doubt about use as indicator
 HH = halogenated hydrocarbons
 PHC = petroleum hydrocarbons

NOTES: The organisms listed for muddy substrates are all deposit feeders, whilst those for rocky substrates are filter feeders or herbivores. It is unlikely that contaminant levels in the tissues of the two groups will reflect contaminant levels in the same part of the marine environment.

Annex VII:

Sampling of selected marine organisms and sample preparation for trace metal analysis

Reference Methods for Marine Pollution Studies No. 7 Rev. 2

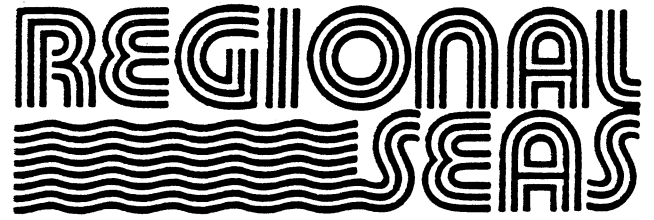

UNITED NATIONS ENVIRONMENT PROGRAMME

12 November 1984

*Sampling of selected marine organisms
and sample preparation for trace metal analysis*

Reference Methods for Marine Pollution Studies No. 7 Rev. 2

Prepared in co-operation with



FAO



IAEA



IOC

Note: This document has been prepared in co-operation between the Food and Agriculture Organization of the United Nations (FAO), the International Atomic Energy Agency (IAEA), the Intergovernmental Oceanographic Commission (IOC) of UNESCO and the United Nations Environment Programme (UNEP) under projects FP/ME/0503-75-07, ME/5102-81-01, FP/5102-77-03 and FP/5101-84-01.

For bibliographic purposes this document may be cited as:

UNEP/FAO/IAEA/IOC: Sampling of selected marine organisms and sample preparation for trace metal analysis. Reference Methods for Marine Pollution Studies No. 7 Rev. 2, UNEP 1984.

PREFACE

The Regional Seas Programme was initiated by UNEP in 1974. Since then the Governing Council of UNEP has repeatedly endorsed a regional approach to the control of marine pollution and the management of marine and coastal resources and has requested the development of regional action plans. The Regional Seas Programme at present ^{1/} ^{2/} includes ten regions and has over 120 coastal States participating in it.

One of the basic components of the action plans sponsored by UNEP in the framework of Regional Seas Programme is the assessment of the state of marine environment and of its resources, of the sources and trends of the pollution, and the impact of pollution on human health, marine ecosystems and amenities. In order to assist those participating in this activity and to ensure that the data obtained through this assessment can be compared on a world-wide basis and thus contribute to the Global Environment Monitoring System (GEMS) of UNEP, a set of reference methods and guidelines for marine pollution studies are being developed and are recommended to be adopted by Governments participating in the Regional Seas Programme.

The methods and guidelines are prepared in co-operation with the relevant specialized bodies of the United Nations system as well as other organizations and are tested by a number of experts competent in the field relevant to the methods described.

In the description of the methods and guidelines the style used by the International Organization for Standardization (ISO) is followed as closely as possible.

The methods and guidelines, as published in UNEP's series of Reference Methods for Marine Pollution Studies, are not considered as final. They are planned to be periodically revised taking into account the development of our understanding of the problems, of analytical instrumentation and the actual need of the users. In order to facilitate these revisions the users are invited to convey their comments and suggestions to:

International Laboratory of Marine
Radioactivity
International Atomic Energy Agency
c/o Musée Océanographique
MC98000 MONACO

which is responsible for the technical co-ordination of the development, testing and intercalibration of reference methods.

1/ UNEP: Achievements and planned development of UNEP's Regional Seas Programme and comparable programmes sponsored by other bodies. UNEP Regional Seas Reports and Studies No. 1 UNEP, 1982.

2/ P. HULM: A Strategy for the Seas. The Regional Seas Programme: Past and Future UNEP, 1983.

This issue (Rev.2) of the Reference Method for Marine Pollution Studies No. 7 was prepared in co-operation with the Food and Agriculture Organization of the United Nations (FAO), the International Atomic Energy Agency (IAEA) and the Intergovernmental Oceanographic Commission (IOC) of UNESCO. It includes comments received from IOC's GIPME Group of Experts on Methods, Standards and Intercalibration (GEMSI), from the FAO/UNEP/IAEA Experts Consultation Meeting on Reference Methods for the Determination of Chemical Contaminants in Marine Organisms (Rome, 4-8 June 1984) and from a number of scientists who reviewed and tested the method. The assistance of all those who contributed to the preparation of Revision 2 of this reference method is gratefully acknowledged.

CONTENTS

	<u>Page</u>
1. Scope and field of application	1
2. References	1
3. Principles	1
4. Reagents	1
5. Apparatus	2
6. Sampling and transport	3
7. Sample preparation	5
8. Sampling and sample preparation protocol	10
Appendix A : Preparation of plastic tweezers	14
Appendix B : Specimen identification note	15

1. SCOPE AND FIELD OF APPLICATION

This publication describes the sampling and sample preparation procedures suitable to obtain uncontaminated samples of mussels (total soft tissue), shrimps (muscles), and fish (muscles) for trace metal analysis by atomic absorption spectrophotometry.

2. REFERENCES

BERNHARD, M. (1976) Manual of methods in aquatic environment research. Part 3. Sampling and analyses of biological material. FAO Fish.Tech.Pap. No. 158 (FIRI/T158), pp. 124. FAU, Rome.

UNEP/FAO/IAEA (in preparation). Guidelines for monitoring chemical contaminants in marine organisms. Reference methods for marine pollution studies No. 6. UNEP, Geneva.

3. PRINCIPLES

Specimens of organisms selected and collected according to UNEP/FAO/IAEA (in preparation) are enclosed in plastic containers and transported to the analytical laboratory either as cooled (-2 to 4°C) or as deep-frozen (-18°C) samples. There the specimens are dissected under "clean conditions" and subsamples are prepared for the analyses of trace metals.

4. REAGENTS

- 4.1 Demineralized distilled water or glass distilled water of equivalent quality, with a trace metal content below detection limits when checked with this reference method.
- 4.2 Uncontaminated "open-ocean" subsurface (1 m below the surface) sea water.
- 4.3 Detergent recommended for laboratory use.

5. APPARATUS

5.1 Plastic thermo-insulated boxes (camping equipment) cooled with commercially available cooling bags. For storage and transport of mussels the boxes must be equipped with a grid in the bottom in order to avoid the mussels being submerged when moistened during transport and storage.

5.2 Refrigerator (required for 6.2, 6.3, 6.4).

5.3 Deep-freezer (-18°C).

5.4 Heavy duty, high-density polyethylene bags or suitable plastic containers for storage of specimens.

5.5 Plastic length-measuring board, length-measuring scale (ruler) or transparent Pyrex dish (cooking utensil) with centimetre scale attached underneath (for small and medium-size specimens).

5.6 Two or more plastic knives made out of high-density and purity polyethylene or similar material. Alternatively, quartz knives can be used.

5.7 Pyrex dishes or porcelain dishes (cooking utensils) as working surface for sample preparation.

5.8 Two or more pairs of plastic, commercially available or "home-made", tweezers (see Appendix A).

5.9 High density and purity polyethylene bags and airtight plastic containers with screw caps, for preservation of samples in deep-freezer, cleaned with detergent (4.3) and rinsed with distilled water (4.1) or uncontaminated sea water (4.2).

5.10 High-density polyethylene sheets for covering working bench.

5.11 Smaller polyethylene sheets to be used as "weighing plastic".

5.12 Balance (100-200 g) with a precision of 0.001 g or better, for weighing specimens and subsamples; preferably a "top-loading" balance.

5.13 Plastic wash bottle containing glass-distilled water (4.1).

5.14 Scraper (figure 1), a strong rust-free knife or similar for collecting mussels.

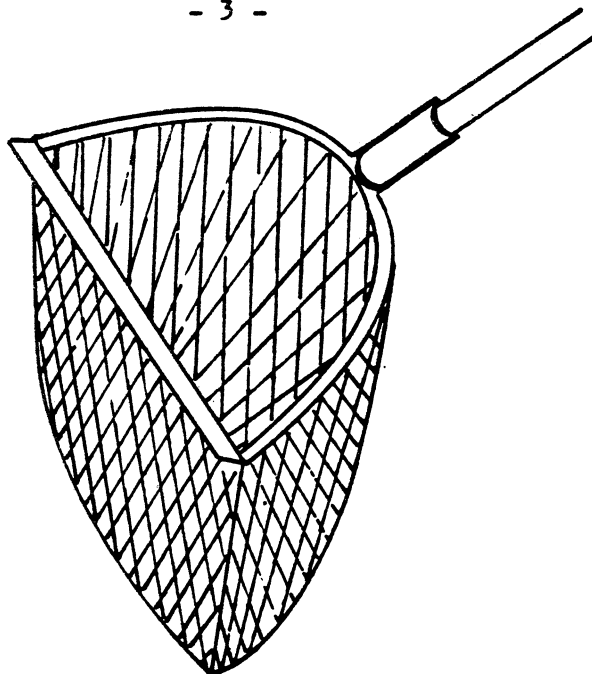

FIGURE 1 : SCRAPER FOR COLLECTING MUSSELS

5.15 Plastic tank or bottle (20 - 50 l) for the sea water (4.2) needed to moisten live mussel samples during storage and transport.

5.16 Large rust-free metal knife for cutting portions from large fishes.

5.17 Stainless steel blender or other tissue homogenizer made from glass and/or teflon. Stainless steel equipment should be tested for trace metal contamination by homogenizing reference (standard) material and comparing the analytical result obtained with same material which was not homogenized with stainless steel equipment.

5.18 Strong plastic brush for removing foreign material attached to the surface of mussels.

6. SAMPLING AND TRANSPORT

6.1 Presampling preparations

Clean the thermo-insulated boxes (5.1), the high density polyethylene bags or containers (5.4), the length-measuring board (5.5), the large rust-free knife (5.16), the scraper or the knife (5.14) with detergent (4.3) and rinse them with distilled water or, alternatively, with clean open-ocean sea water (4.2).

6.2 Sampling of mussels

Remove mussels from their attachments with the clean scraper or the rust-free knife (5.14).

Transfer a suitable number (UNEP/FAO/IAEA (in preparation)) of undamaged mussels into clean thermo-insulated boxes with grid on the bottom (5.1). Collect, from the sampling site, a clean sea water sample in a suitable container (5.15) to keep the mussels moist if a long transport (more than 2 hours in hot climates) is envisaged. Keep the mussels moist with the clean sea water without submerging them.

If the mussels have to be transported and stored before sample preparation (7) for more than 24 hours place a suitable number of mussels in plastic bag (5.9). Squeeze out the air and close the bag airtight with a knot, thermoseal, or similar. Place the bag into another bag (5.4) together with a sample identification note (see Appendix B), close airtight the second bag and deep-freeze.

This represents the "specimen sample".

NOTE: The transport of mussels collected near the laboratory will not present special transport and storage problems. Mussels should be kept exposed to air and moistured with clean sea water during the transport to the laboratory. When gathered from the intertidal zone, they will survive aerial exposure for 24 hours. Mussels submerged in sea water during transport will open their valves, start pumping water and excreting waste products, while during aerial exposure their valves will remain closed and their metabolic rate is greatly reduced; therefore their submersion in sea water during transport should be avoided.

6.3 Sampling of shrimps and small to medium-size fish

Place in a clean plastic bag (5.4) a suitable number of the undamaged specimens (select according to UNEP/FAO/IAEA (in preparation)) collected from a fishing vessel, fish market, etc., taking care that the legs, spines, etc. will not puncture the plastic. Squeeze out the air and close the bag airtight with a knot, thermoseal, or similar. Place the bag into another bag (5.4) together with a sample identification note (see Appendix B), and close the second bag airtight also. Deep-freeze (5.3) the bag whenever possible. Use a refrigerator (5.2) or a cooled thermo-insulated box (5.1) only if the storage period is not too long (48 hours in hot climates).

This represents the "specimen sample".

6.4 Sampling of large-size fish

Determine and note the fork-length, the body weight and sex of the collected specimen.

Separate with a clean rust-free metal knife (5.16) a portion of at least 100 g of muscle tissue. This portion must be at least 5 cm thick so that during sample preparation (7.3) contaminated and dirty tissue can be sliced off. Place each portion into a separate clean bag (5.4), squeeze out the air and close the bag airtight. Place it together with the sample identification note (see Appendix B) into a second bag (5.4) and close it airtight also. Deep-freeze

(5.3) the bag whenever possible, otherwise use a refrigerator (5.2) or a cooled thermo-insulated box (5.1) if the storage period is not too long (48 hours in hot climate).

This represents the "specimen sample".

7. SAMPLE PREPARATION

7.1 Preparatory activities

If necessary, partially thaw deep-frozen samples (6) by placing them overnight in a refrigerator at -2°C to 4°C (partially frozen samples are easier to cut than completely thawed or even fresh samples).

Clean the knives (5.6), the dishes (5.7), the tweezers (5.8), the length-measuring board (5.5) and "weighing plastics" (5.11) with detergent (4.3), rinse with distilled water (4.1) or clean sea water (4.2). Cover the working area with pre-cleaned plastic sheets (5.10). Clean hands carefully with detergent (4.3) and rinse them with distilled water (4.1) or clean sea water (4.2).

NOTE: If hands are cleaned and precautions are taken not to touch the dissected part with hands, bare hands are preferred to hands covered with gloves, since the operator has a much better control of instruments, etc. If possible a clean room should be used for preparatory activities.

7.2 Sample preparation of mussels

Scrape off all foreign materials attached to the outer surface of the shell with a clean plastic knife (knife no. 1) (5.6), to be used only for this purpose or with a strong plastic brush (5.18). Handle the mussels as little as possible.

Rinse each mussel with distilled water (4.1) or alternatively with clean sea water (4.2) and let the water drain off.

Pull out the byssus which extrudes from between the closed shells on the concave side of the shells.

Weigh (5.12) the whole mussel and note the weight.

Insert a second clean plastic knife (knife no. 2) (5.6) into the opening from which the byssus extrudes and cut the adductor muscles by turning the knife as indicated in figure 2 and open the mussel. Do not try to break the mussel open with the knife; if the muscles are cut, the mussel will open easily. Check if the byssus has been eliminated completely; if not, remove the remainder with clean tweezers (5.8).

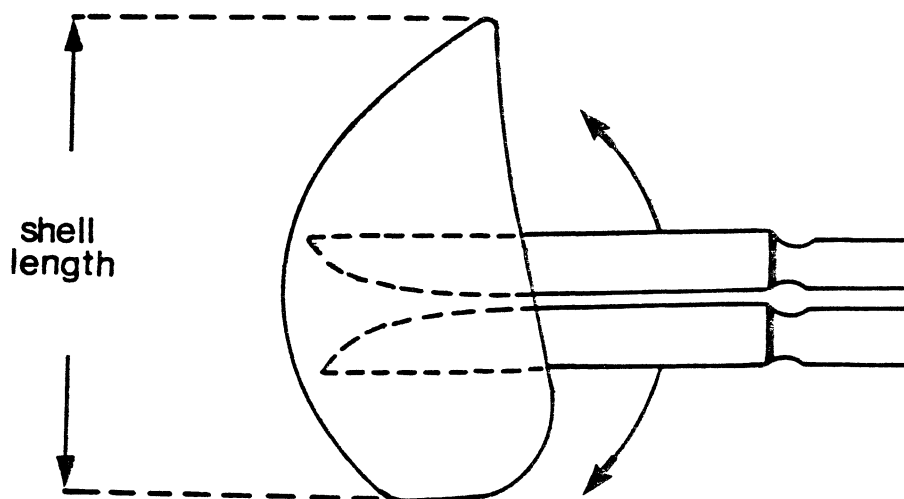

FIGURE 2 : CUTTING THE ADDUCTOR MUSCLE

Rinse the soft part of the mussel in its shells with distilled water (4.1) or clean sea water (4.2).

Loosen all tissue with the second clean knife (knife no. 2) (5.6), remove the soft tissue from the shell with a pair of clean plastic tweezers (5.8) without touching the outer part of the shells, and let all the water drain off.

(a) Single specimen sample: Weigh a clean empty container (5.9) on the balance and note the weight. Then put the soft part of the mussel in it and reweigh. Note the fresh weight of the soft part. Close the container airtight, label it with the sample preparation code. Determine the length of the mussel's shell (figure 2) by placing it with the inner part facing the cm scale (5.13). Note the length of the shell and the weight of the soft part of the mussel.

(b) Composite sample: Fill a container (5.9) of known weight with at least 10 soft parts of mussels prepared as described above. Reweigh the plastic container and note the composite fresh weight of the mussels. Homogenize the specimens in a cleaned blender (5.17), and return the homogenate in the plastic container. Note the total weight again and recalculate the fresh weight of the homogenate. Label the plastic container with the sample code.

NOTE: When preparing composite samples, use mussels of similar size. The length and weight of each specimen should be determined separately before the soft parts are pooled.

Place several plastic containers in a clean plastic bag (5.4), include an identification note with the containers sample codes, seal the bag airtight and deep-freeze.

This represents the "tissue sample".

7.3 Sample preparation of shrimps

(a) Single specimen sample: Determine the length of the shrimp from rostrum to uropod (see figure 3) using the appropriate length measuring device (5.5). Weigh the shrimp after placing a clean "weighing plastic" (5.11) on the balance (5.12) and note its length and fresh weight.

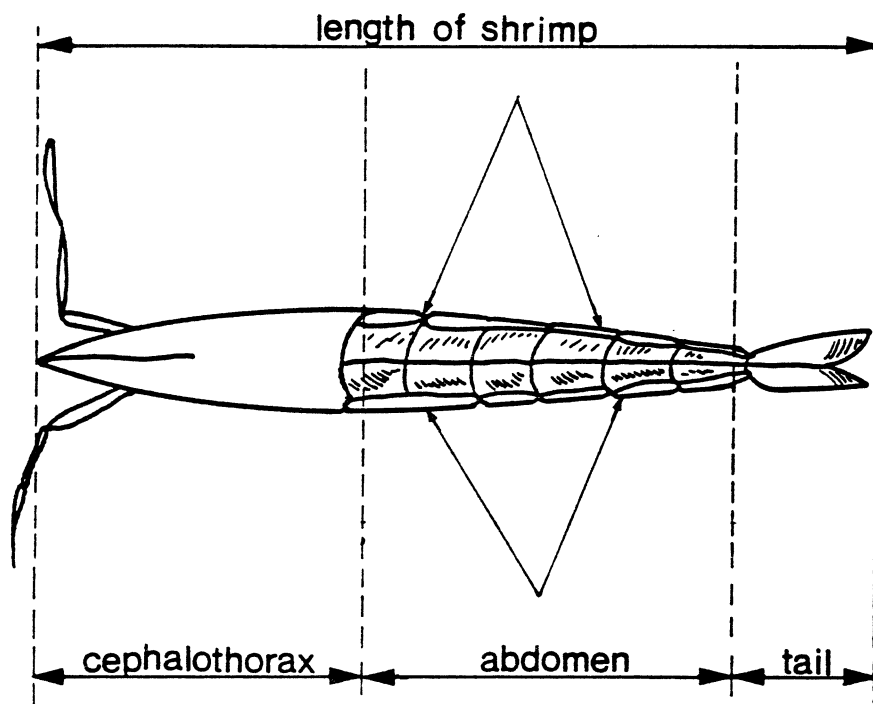

FIGURE 3 : SCHEMATIC DIAGRAM OF A SHRIMP
(arrows indicate where to cut after the legs have been removed)

Separate the abdomen from the cephalothorax and the "tail" (telson and uropod) with a first plastic knife (knife no. 1) taking care that no viscera remain in the abdomen (figure 3). Cut off all legs. Turn the abdomen with the ventral side up and cut with a plastic knife along the edges of the sterinities (ventral exoskeleton); lift the sterinities off with a pair of plastic tweezers and discard.

Loosen with a second clean knife (knife no. 2) the abdomen muscle and lift it from the exoskeleton with a clean pair of tweezers.

Determine and note the sex by examining the gonads.

Transfer the muscle with a clean pair of plastic tweezers (5.8) into a preweighed plastic container (5.9), determine and note the fresh weight of the muscle. Close the container airtight, label it with the sample code, place a suitable number of containers in a plastic bag, add a sample identification note to the containers, and close the bag airtight and deep freeze the samples.

(b) Composite sample: Start sample preparation as described for single specimen sample above taking care to record length, fresh weight, tail muscle weight and the sex of each specimen separately. Reduce the tail muscle(s) of the large specimens to the weight of the smallest tail muscle. A composite sample should not contain less than 6 tail muscles from 6 different specimens of

the same sex and size. Homogenize the tail muscles in a blender (5.17). Transfer the homogenate into a suitable clean container (5.9) which has been weighed empty. Close the container airtight, label it and weigh the container with the homogenate. Note the weight of the homogenate together with the other data in a protocol. Place a suitable number of containers in a plastic bag (5.4), add a sample identification note, close the bag airtight and deep-freeze (5.3) the containers.

This represents the "tissue sample".

NOTE: The concentration of trace metals in a composite sample should represent the mean value of metal concentrations of single specimens. In order to avoid overrepresentation of large specimens, only shrimp of similar size (age) should be used for the preparations of composite samples. In addition, the weight of the tail muscles of all specimens to be included in the composite sample should be reduced to that of the tail muscle of the smallest specimen. As there might be considerable differences in the trace metal content of male and female specimens, use them in separate composite samples.

7.4 Sample preparation for small and medium size fish

(a) Single specimen sample: Determine the fork-length (from tip of snout when the mouth is closed to the apex of the fork of the tail) of fish (figure 4) to the nearest mm on the length-measuring board (5.5). Weigh the fish on a clean "weighing plastic" (5.11) with an accuracy of 0.1% of its total weight and note both the fork-length and the fresh weight of the specimen.

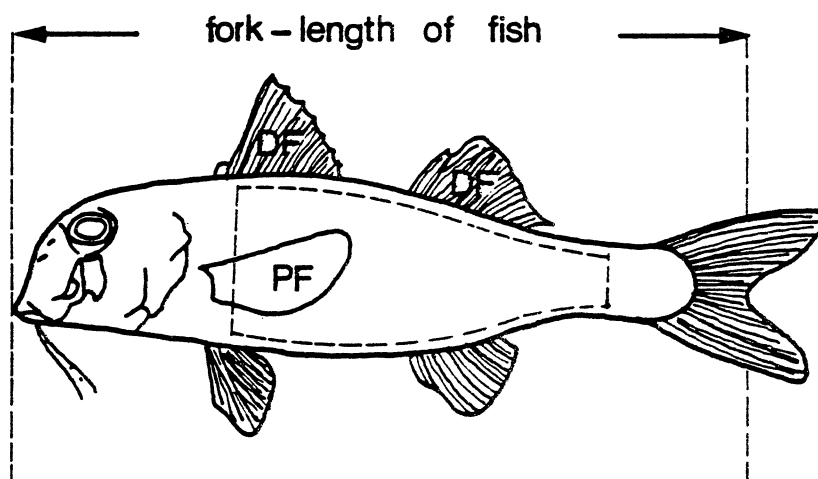

FIGURE 4 : SCHEMATIC DIAGRAM OF A FISH

(PF=pectoral fin, DF=dorsal fins, dashed line shows where the cuts should be made)

Rinse the fish with distilled water (4.1) or clean sea water (4.2) and place it on a clean working surface (5.7). Remove the pectoral fin and cut the skin of the fish with a first knife (5.6) near the dorsal fins, starting from the head to the tail (figure 4).

Cut near the gills across the body, along the ventral edge from the gills to the tail and finally across the body near the tail. These four cuts should be carried out first on one side only taking care not to cut too deep in order to avoid cutting into the viscera and thus contaminating the fillet. It is advisable that a second person hold the fish by the head and tail during this operation.

Pull the skin from the fillet with a pair of tweezers (5.8), taking care that the outer skin does not contaminate the fillet.

With a second clean knife (5.6), cut the fillet from the vertebral column (backbone) starting from the cut near the gills. Lift the fillet with a second clean pair of tweezers (5.8), so that the fillet will not touch the working surface (e.g. the Pyrex dish) or other parts of the fish.

Weigh the fillet in a clean plastic container (5.9) and note its fresh weight.

If one fillet does not yield enough material for analysis, put the fish, skin side upwards, on a clean portion of the working surface (5.3) or on a new working surface and remove the second fillet from the other side of the same fish as described above, add it to the first sample and record their total weight.

Close the container airtight. Identify the container with a code number and/or label, record all data in the protocol and deep-freeze (5.3).

This represents the "tissue sample".

Determine and note the sex of fish by examining the gonads.

NOTE: Comparing the weight of the container holding the fillet sample(s) determined at this point with the weight of the container before the digestion step will show if the tissues have lost moisture during prolonged storage.

(b) Composite sample: Start sample preparation as described for single specimen sample above taking care to record the length, the fresh weight and fillet (sample) weight of each fish separately. Determine and note by examining the gonads the sex of each specimen separately.

Reduce the fillet(s) of the large specimens to the weight of the smallest fillet. A composite sample should not contain less than 6 fillets from 6 different specimens of the same sex and size. Homogenize the fillets in a blender (5.17). Transfer the homogenate into a suitable clean container (5.9) which has been weighed empty. Close the container airtight, label it and weight the container with the homogenate. Note the weight of the homogenate together with the other data in a protocol and deep-freeze (5.3) the container.

This represents the "tissue sample".

NOTE: The concentration of trace metals in a composite sample should represent the mean value of metal concentrations of single specimens. In order to avoid overrepresentation of large specimens, only fish of similar size (age) should be used for the preparation of composite samples. In addition, the weight of the fillets of all specimens to be included in the composite sample should be reduced to that of the fillet of the smallest fish. As there might be considerable differences in the trace metal content of male and female specimens, use them in separate composite samples.

7.5 Sample preparation of large-size fish

If necessary, thaw partially, e.g. overnight in a refrigerator (-2 to 4°C), the subsample taken in the field during sampling (6.4).

Rinse the subsample with distilled water (4.1) or clean sea water (4.2) and place it on a clean working surface (5.7). Remove any skin and bone that may be present. Cut off thin slices from all surfaces with clean plastic knife (5.6) and discard them. Repeat the operation with a second clean knife (5.6) in order to obtain a clean uncontaminated block of homogeneous tissue.

NOTE: It has been recognized that differences in trace metal concentrations may exist between different muscles in large fish, therefore as much information as possible on the actual sample should be recorded.

Transfer the tissue into an airtight container (5.9), close and label it, weigh it, note all data together with data of the subsample in the protocol, and deep-freeze (5.3).

This represents the "tissue sample".

8. SAMPLING AND SAMPLE PREPARATION PROTOCOL

Fill in the sampling and sample preparation protocol (table 1) giving full details in every column. This protocol should be attached to the test report on the determination of trace metals in the analyzed sample.

The following guidelines should be kept in mind when completing the protocol (the numbers refer to those used in table 1):

1.1 Use the scientific name for the species sampled. If necessary indicate subspecies or variety.

1.2 Indicate the name under which the species is known locally.

1.3 Use any code adopted by your institution. Never use the same sample code for more than one sample.

3.2 For samples obtained on fish market, indicate the town (village) where the market is. For samples taken at standard sampling stations or areas, indicate the name (code) of the station or area.

3.3 If the sampling point does not coincide with a standard sampling station or area, it may be advisable to code (name) it, in particular when the sampling point is used more frequently (e.g. a particular fish market). Never use the same sampling point code for more than one sampling point.

3.4 and 3.5 Always indicate the longitude and latitude of the sampling point to the nearest minute. For samples obtained from fish market, enquire about their provenience and try to reflect it also as geographic co-ordinates. Circle either E or W and N or S, as appropriate.

3.6 Give any additional information which may be relevant for the interpretation of the results (e.g. sampling point in vicinity of outfalls or similar).

4.1 Indicate the difference between data given under 2 and 5.

4.2 Mark the storage conditions used. If none of them applicable, give additional explanations in 4.3.

6.2 Identify sex of the specimen whenever possible. As for specimen length, determine shell length for mussels, fork length for fish and total length for shrimp as indicated in figures 2, 3, and 4. Specimen weight always refers to the fresh weight of the whole mussel, of the whole shrimp and of the whole fish. Note that sample weight, in the case of mussels, refers to the total weight of soft tissues. In the case of shrimp, the sample weight refers only to the fresh weight of the muscle, and in the case of fish, to the fresh weight of the fillet or of the combined weight of fillets removed from the same fish.

6.3 Whenever possible use six or more specimens of the same sex and size (age) in preparing composite samples. Mean length and weight refers to the arithmetical mean of the weight and length of individual specimens, as explained above. Always calculate the standard deviations.

Table 1: Sampling and Sample Preparation Protocol

1. Sample (specimen)

1.1 Scientific name: _____

1.2 Common name: _____

1.3 Sample code: _____

2. Date of sampling: day _____; month _____; year _____

3. Sampling point

3.1 Country: _____

3.2 Type of sampling point: _____ fish market;
_____ sampling area/station

3.3 Sampling point code: _____

3.4 Longitude: _____ ° _____ ' E or W

3.5 Latitude: _____ ° _____ ' N or S

3.6 Conditions at sampling point which may be relevant for the interpretation of results:

4. Sample storage

4.1 Duration of storage: _____ hours; _____ days

4.2 Storage: deep-freezing _____; cooling _____

4.3 Factors relevant to sample storage which may be important for the interpretation of results:

5. Date of sample preparation: day _____; month _____; year _____

6. Sample preparation

6.1 Tissue type (kind) _____

6.2 Single specimen sample: sex____; specimen length_____cm;
specimen weight_____g; sample weight_____g

6.3 Composite sample:

- number of specimens _____; sex _____
- mean length of specimens _____cm; stand. dev. _____
- mean weight of specimens _____g; stand. dev. _____
- total weight of composite sample _____g
- total net weight of homogenate _____g

6.4 Factors relevant to sample preparation which may be important for the interpretation of results:

7. Full address of the institution carrying out the sampling and sample preparation:

8. Name(s) and signature(s) of the person(s) who carried out the sample preparation:

Date: _____

Appendix A

Preparing plastic tweezers

Methylmetacrylate of 4 mm thickness has been found to be very useful as it has the right elasticity. If thinner or thicker material has to be used, either the strips from which the tweezers are to be made are cut wider or narrower. The easiest way to heat the plastic and bend it is with a hot air blower used for forming plastics. A drying oven can be used also. However, it is much more difficult to make tweezers by heating the plastic in an oven since the plastic twists easily.

Materials:

- sheets of acrylic (methylmetacrylate) resin; 4 mm thick (trade names: e.g. Perspex, Flexiglas, Lucite);
- a plastic tube, about 40 mm in diameter.

Equipment:

- hot air blower (300-350°C) used for molding plastics, or Drying oven (135-140°C).

Procedure:

(a) With a hot air blower

- cut from the sheet with an electric or a hand saw strips of about 10 mm width and 250 mm length;
- heat about a 60 mm long part in the middle of the strip so that it bends easily. Bend it around the plastic tube carefully in order to make both ends meet. Cool the plastic with cold water;
- sharpen the ends with a file and roughen the inside of the tweezers so that they grip well;
- wash the tweezers carefully with detergents and rinse them with distilled water.

(b) With a drying oven

- place the plastic strip on a clean piece of wood in a drying oven (135-140°C) until it becomes soft;
- lift the strip at one end with a pair of tweezers and bend it around the plastic tube without letting the tweezer tips meet;
- cool the tips by dipping them in a beaker of clean cold water and afterwards bend the ends of the tweezer so that the tips meet;
- prepare the ends of the tweezers as described earlier.

Appendix B

Sample identification note

A standard sample identification note should contain the following data:

- sample code (the same code should be used in 1.3 of the Sampling and Sample Preparation Protocol; see table 1);
- species name (important in particular whenever storage of sample may create difficulties in determining the species);
- sampling date;
- sampling location (given as sampling point code, if possible; see 3.3 of table 1);
- collector's (sampler's) name;

Example:

AN 435
Mytillus galloprovincialis
3 March 1982
F 17
D. Degobbis

Issued and printed by:



Regional Seas Programme Activity Centre
United Nations Environment Programme

Additional copies of this and other publications issued by
the Regional Seas Programme Activity Centre of UNEP can be
obtained from:

Regional Seas Programme Activity Centre
United Nations Environment Programme
Palais des Nations
GENEVA
Switzerland

Annex VIII:

HELCOM

Manual for marine monitoring in the COMBINE programme

**ANNEX B-12, APPENDIX 1. TECHNICAL NOTE ON BIOLOGICAL MATERIAL
SAMPLING AND SAMPLE HANDLING FOR THE ANALYSIS OF PERSISTENT
ORGANIC POLLUTANTS (PAHS, PCBS AND OCPS) AND METALLIC TRACE
ELEMENTS**

HELCOM Manual for marine monitoring in the COMBINE programme

ANNEX B-12, APPENDIX 1. TECHNICAL NOTE ON BIOLOGICAL MATERIAL SAMPLING AND SAMPLE HANDLING FOR THE ANALYSIS OF PERSISTENT ORGANIC POLLUTANTS (PAHS, PCBS AND OCPS) AND METALLIC TRACE ELEMENTS

1. GENERAL PRINCIPLES

Muscle tissue or liver of fish have to be dissected while they are in good condition. If biological tissue deteriorates, uncontrollable losses of determinands or cross-contamination from other deteriorating tissues and organs may occur. To avoid this, individual fish specimens must be dissected at sea if adequate conditions prevail on board, or be frozen immediately after collection and transported frozen to the laboratory, where they are dissected later. If the option chosen is dissection on board the ship, two criteria must be met:

1. The work must be carried out by personnel capable of identifying and removing the desired organs according to the requirements of the investigations; and
2. There must be no risk of contamination from working surfaces or other equipment.

2. TOOLS AND WORKING AREA

Crushed pieces of glass or quartz knives, and scalpels made of stainless steel or titanium are suitable dissection instruments.

Colourless polyethylene tweezers are recommended as tools for holding tissues during the dissection of biological tissue for metallic trace element analysis. Stainless steel tweezers are recommended if biological tissue is dissected for analysis of chlorinated biphenyls (PCBs), organochlorine pesticides (OCPs) and polynuclear aromatic hydrocarbons (PAHs). After each sample has been prepared, including the samples of different organs from the same individual, the tools should be changed and cleaned.

The following procedures are recommended for cleaning tools used for preparing samples:

1) for analysis of metallic trace elements

- a) Wash in acetone or alcohol and high purity water.
- b) Wash in HNO₃ (p.a.) diluted (1+1) with high purity water. Tweezers and haemostates in diluted (1+6) acid.
- c) Rinse with high purity water.

2) for analysis of CBs and OCPs

- a) Wash in acetone or alcohol and rinse in high purity water.

The glass plate used during dissection should be cleaned in the same manner. The tools must be stored dust-free when not in use.

The dissection room should be kept clean and the air should be free from particles. If clean benches are not available on board the ship, the dissection of fish should be carried out in the land-based laboratory under conditions of maximum protection against contamination.

3. FISH MUSCLE AND LIVER SAMPLES DISSECTION

For fish analysis, commercial catches can be used if fish transport to the laboratory does not take longer than 24 hours. The fish must be transported on ice. The dissection then takes place at the laboratory.

For analysis of **fish muscle**, the epidermis and subcutaneous tissue should be carefully removed from the fish. Samples should be taken under the red muscle layer. In order to ensure uniformity of samples, the **right side dorso-lateral muscle** should be taken as the sample. If possible, the entire right dorsal lateral filet should be used as a uniform sample, from which subsamples can be taken after homogenizing for replicate dry weight and contaminant determinations. If, however, the amount of material obtained by this procedure is too large to handle in practice, a specific portion of the dorsal musculature should be chosen for the sample. It is recommended that the portion of the muscle lying directly under the first dorsal fin should be utilised in this case. As both fat and water content vary significantly in the muscle tissue from the anterior to the caudal muscle of the fish (Oehlschläger, 1994), it is important to obtain the same portion of the muscle tissue for each sample.

To sample **liver tissue**, the liver must be identified in the presence of other organs such as the digestive system or gonads (Harms and Kanisch, 2000). The appearance of the gonads will vary according to the sex of the fish and the season. After opening the body cavity with a scalpel, the connective tissue around the liver should be cut away and as much as possible of the liver is cut out in a single piece together with the gall bladder. The bile duct is then carefully clamped and the gall bladder dissected away from the liver.

When fish samples which have been frozen at sea are brought to the laboratory for analysis, they should be dissected as soon as the tissue has thawed sufficiently. The dissection of fish is easiest when the material, at least the surface layers of the muscle tissue, is half frozen. For dissection of other organs, the thawing must proceed further, but it is an advantage if, for example, the liver is still frozen. It must be noted that any loss of liquid or fat due to improper cutting or handling of the tissue makes the determinations of dry weight and fat content, and consequently the reported concentrations of determinands, less accurate.

After muscle preparations, the liver should be completely and carefully removed while still partly frozen to avoid water and fat loss. Immediately after removing it from the fish, the liver should be returned to the freezer so that it will be completely frozen prior to further handling. This is particularly important for cod liver.

4. SHELLFISH SAMPLING

The blue mussel (*Mytilus edulis*) occurs in shallow waters along almost all coasts of the Baltic Sea. It is therefore suitable for monitoring in near shore waters. No distinction is made between *M. edulis*, *M. galloprovincialis*, and *M. trossulus* because the latter species fills a similar ecological niche. A sampling size range of 20–70 mm shell length is specified to ensure availability throughout the whole maritime area.

Two alternative sampling strategies can be used: sampling to minimise natural variability and length-stratified sampling. Only details of length-stratified sampling are described in this document, as this strategy is used in monitoring programmes for temporal trends of contaminants in biota.

For shellfish, the upper limit of shell length should be chosen in such a way that at least 20 mussels in the largest length interval can easily be found. The length stratification should be

determined in such a way that it can be maintained over many years for the purposes of temporal trend monitoring. The length interval shall be at least 5 mm in size. The length range should be split into at least three length intervals (small, medium, and large) which are of equal size after log transformation.

Mussels are collected by a bottom grab and selected onboard. The number of specimens selected for analysis depends on their length, e.g. 80-100 individuals are necessary to suffice material within the length range 4-5 cm.

5. STORAGE OF FISH AND MUSSEL SAMPLES

Material from single fish specimens should be packaged and stored individually.

- Samples for analysis of metallic trace elements can be stored in polyethylene, polypropylene, polystyrene or glass containers.
- Samples for analysis of CBs and OCPs should be packaged in precleaned aluminium foil or in precleaned glass containers.

Liver tissue can deteriorate rather rapidly at room temperature. Consequently, samples should be frozen as soon as possible after packaging. They can be frozen rapidly by immersion in liquid nitrogen or blast freezing, but both these techniques need care. Whatever system is used, freezing a large bulk of closely packed material must be avoided. The samples in the centre will take longer to cool and will therefore deteriorate more than those in the outer layer.

Once frozen, samples can be stored in a deep freezer at temperatures of -20°C or below.

Frozen liver tissue should not be stored longer than six months, while lean muscle tissue can be stored up to two years. Each sample should be carefully and permanently labelled. The label should contain at least the sample's identification number, the type of tissue, and the date and location of sampling.

Mussels should be shucked live and opened with minimal tissue damage by detaching the adductor muscles from the interior of at least one valve. The soft tissues should be removed and homogenised as soon as possible, and frozen in glass jars at -20 °C until analysis. Mussel tissue for trace metal determination is homogenised and decomposed in a wet state while for persistent organic pollutants determination it is homogenised and water is removed by freeze-drying. Frozen liver tissue should not be stored longer than six months, while lean muscle tissue can be stored up to two years. Each sample should be carefully and permanently labelled. The label should contain at least the sample's identification number, the type of tissue, and the date and location of sampling.

REFERENCES

- Harms, U.; Kanisch, G. (2000): Intra-Individual Variability of levels of lead detected in the liver of Baltic cod (*Gadus morhua*). *Mar. Poll. Bull.*, 40 / 8, 710-712
- Oehlenschläger, J. 1994. Quality assurance during sampling onboard. *In ICES/HELCOM Workshop on Quality Assurance of Chemical Analytical Procedures for the Baltic Monitoring Programme*. Ed. by G. Topping and U. Harms. *Baltic Sea Environment Proceedings No. 58: 82-84.*

Annex IX:

**Guidance for Assessing Chemical Contaminant
Data for Use in Fish Advisories**

**Volume 1: Fish Sampling and Analysis
Third Edition**



Guidance for Assessing Chemical Contaminant Data for Use in Fish Advisories

Volume 1 Fish Sampling and Analysis Third Edition



Guidance for Assessing Chemical Contaminant Data for Use in Fish Advisories

**Volume 1: Fish Sampling and Analysis
Third Edition**

**Office of Science and Technology
Office of Water
U.S. Environmental Protection Agency
Washington, DC**



United States

Environmental Protection Agency

(4305)

Washington, DC 20460

Official Business

Penalty for Private Use \$300



Guidance for Assessing Chemical Contaminants

Volume 1: Fish Sampling and Analysis



TABLE OF CONTENTS

Section	Page
Figures	vii
Tables	ix
Acknowledgments	xii
Acronyms	xiii
Executive Summary	ES-1
1 Introduction	1-1
1.1 Historical Perspective	1-1
1.1.1 Establishment of the Fish Contaminant Workgroup ...	1-3
1.1.2 Development of a National Fish Advisory Database ...	1-3
1.2 Purpose	1-10
1.3 Objectives	1-13
1.4 Relationship of Manual to Other Guidance Documents	1-15
1.5 Contents of Volume 1	1-15
1.6 New Information And Revisions to Volume 1	1-18
2 Monitoring Strategy	2-1
2.1 Screening Studies (Tier 1)	2-4
2.2 Intensive Studies (Tier 2)	2-13
3 Target Species	3-1
3.1 Purpose of Using Target Species	3-1
3.2 Criteria for Selecting Target Species	3-2
3.3 Freshwater Target Species	3-3
3.3.1 Target Finfish Species	3-5
3.3.2 Target Turtle Species	3-10
3.4 Estuarine/marine Target Species	3-15
3.4.1 Target Shellfish Species	3-23
3.4.2 Target Finfish Species	3-28
4 Target Analytes	4-1
4.1 Recommended Target Analytes	4-1
4.2 Selection and Prioritization of Target Analytes	4-3
4.3 Target Analyte Profiles	4-12
4.3.1 Metals	4-12
4.3.2 Organochlorine Pesticides	4-24
4.3.3 Organophosphate Pesticides	4-38

Section	Page
4.3.4 Chlorophenoxy Herbicides	4-43
4.3.5 Polycyclic Aromatic Hydrocarbons	4-44
4.3.6 Polychlorinated Biphenyls (Total)	4-47
4.3.7 Dioxins and Dibenzofurans	4-54
4.4 Target Analytes Under Evaluation	4-58
4.4.1 Lead	4-58
5 Screening Values for Target Analytes	5-1
5.1 General Equations for Calculating Screening Values	5-1
5.1.1 Noncarcinogens	5-3
5.1.2 Carcinogens	5-3
5.1.3 Recommended Values for Variables in Screening Value Equations	5-4
5.2 Screening Values for Target Analytes	5-9
5.3 Comparison of Target Analyte Concentrations with Screening Values	5-16
5.3.1 Metals	5-16
5.3.2 Organics	5-18
6 Field Procedures	6-1
6.1 Sampling Design	6-1
6.1.1 Screening Studies (Tier 1)	6-2
6.1.2 Intensive Studies (Tier 2)	6-22
6.2 Sample Collection	6-38
6.2.1 Sampling Equipment and Use	6-38
6.2.2 Preservation of Sample Integrity	6-45
6.2.3 Field Recordkeeping	6-46
6.3 Sample Handling	6-55
6.3.1 Sample Selection	6-55
6.3.2 Sample Packaging	6-61
6.3.3 Sample Preservation	6-64
6.3.4 Sample Shipping	6-65
7 Laboratory Procedures I—Sample Handling	7-1
7.1 Sample Receipt And Chain-of-custody	7-1
7.2 Sample Processing	7-3
7.2.1 General Considerations	7-3
7.2.2 Processing Fish Samples	7-7
7.2.3 Processing Turtle Samples	7-16
7.2.4 Processing Shellfish Samples	7-24
7.3 Sample Distribution	7-29
7.3.1 Preparing Sample Aliquots	7-29
7.3.2 Sample Transfer	7-32

Section	Page
8 Laboratory Procedures II—Sample Analyses	8-1
8.1 Recommended Analytes	8-1
8.1.1 Target Analytes	8-1
8.1.2 Lipid	8-1
8.2 Analytical Methods	8-3
8.2.1 Lipid Method	8-3
8.2.2 Target Analyte Methods	8-4
8.3 Quality Assurance and Quality Control Considerations	8-12
8.3.1 QA Plans	8-14
8.3.2 Method Documentation	8-14
8.3.3 Minimum QA and QC Requirements for Sample Analyses	8-14
8.4 Documentation and Reporting of Data	8-46
8.4.1 Analytical Data Reports	8-46
8.4.2 Summary Reports	8-47
9 Data Analysis and Reporting	9-1
9.1 Data Analysis	9-1
9.1.1 Screening Studies	9-1
9.1.2 Intensive Studies	9-2
9.2 Data Reporting	9-3
9.2.1 State Data Reports	9-3
9.2.2 Reports to the National Fish Tissue Residue Data Repository (NFTRDR)	9-3
10 Literature Cited	10-1
 Appendix	
A 1993 Fish Contaminant Workgroup	A-1
B Screening Values for Defining Green Areas	B-1
C Use of Individual Samples in Fish Contaminant Monitoring Programs	C-1
D Fish and Shellfish Species for which State Consumption Advisories Have Been Issued	D-1
E Target Analytes Analyzed in National or Regional Monitoring Programs	E-1
F Pesticides and Herbicides Recommended as Target Analytes	F-1

Section	Page
G Target Analyte Dose-Response Variables and Associated Information	G-1
H A Recommended Method for Inorganic Arsenic Analysis	H-1
I Quality Assurance and Quality Control Guidance	I-1
J Recommended Procedures for Preparing Whole Fish Composite Homogenate Samples	J-1
K General Procedures for Removing Edible Tissues from Freshwater Turtles	K-1
L General Procedures for Removing Edible Tissues from Shellfish ..	L-1
M Sources of Reference Materials and Standards	M-1
N Statistical Methods for Comparing Samples: Spatial and Temporal Considerations	N-1

FIGURES

Number		Page
1-1	Total number of fish advisories in effect in each state in 1998 (change from 1997)	1-6
1-2	Trends in number of advisories issued for various pollutants	1-7
1-3	Series summary: Guidance for assessing chemical contamination data for use in fish advisories	1-16
2-1	Recommended strategy for State fish and shellfish contaminant monitoring programs	2-3
3-1	Geographic range of the common snapping turtle (<i>Chelydra serpentina</i>)	3-12
3-2	Geographic distributions of three bivalve species used extensively in national contaminant monitoring programs	3-27
4-1	States issuing fish and shellfish advisories for mercury	4-21
4-2	States issuing fish and shellfish advisories for chlordane	4-27
4-3	States issuing fish and shellfish advisories for PCBs	4-51
4-4	States issuing fish and shellfish advisories for dioxin/furans	4-57
5-1	Recommended Values for Mean Body Weights (BW) and Fish Consumption Rates (CRs) for Selected Subpopulations	5-5
5-2	Fish Consumption Rates for Various Fisher Populations	5-10
5-3	Dose-Response Variables and Recommended Screening Values (SVs) for Target Analytes - Recreational Fishers	5-11
5-4	Dose-Response Variables and Recommended Screening Values (SVs) for Target Analytes - Subsistence Fishers	5-13
5-5	Example Screening Values (SVs) for Various Target Populations and Risk Levels (RLs)	5-17
5-6	Toxicity Equivalency Factors for Various PAHs	5-20
5-7	Toxicity Equivalency Factors (TEFs) for Tetra-through Octa-Chlorinated Dibenzo-p-Dioxins and Dibenzofurans and Dioxin-Like PCBs	5-22

Number		Page
6-1	Example of a sample request form	6-3
6-2	U.S. fish and wildlife service regions	6-7
6-3	Example of a field record for fish contaminant monitoring program—screening study	6-47
6-4	Example of a field record for shellfish contaminant monitoring program—screening study	6-48
6-5	Example of a field record for fish contaminant monitoring program—intensive study	6-49
6-6	Example of a field record for shellfish contaminant monitoring program—intensive study	6-51
6-7	Example of a sample identification label	6-52
6-8	Example of a chain-of-custody tag or label	6-53
6-9	Example of a chain-of-custody record form	6-54
6-10	Recommended measurements of body length and size for fish, shellfish, and turtles	6-58
7-1	Preparation of fish fillet composite homogenate samples	7-8
7-2	Sample processing record for fish contaminant monitoring program—fish fillet composites.	7-10
7-3	Illustration of basic fish filleting procedure.	7-13
7-4	Preparation of individual turtle homogenate samples	7-17
7-5	Sample processing record for a contaminant monitoring program—individual turtle samples	7-19
7-6	Illustration of basic turtle resection procedure	7-21
7-7	Preparation of shellfish edible tissue composite homogenate samples	7-25
7-8	Sample processing record for shellfish contaminant monitoring program—edible tissue composites.	7-27
7-9	Example of a fish and shellfish monitoring program sample aliquot record.	7-31
7-10	Example of a fish and shellfish monitoring program sample transfer record	7-33
8-1	Recommended contents of analytical standard operating procedures (SOPs).	8-15
9-1	Recommended data reporting requirements for screening and intensive studies	9-4
9-2	Key information fields for the National Fish Tissue Residue Data Repository	9-6

TABLES

Number		Page
1-1	U.S. Advisories Issued from 1993 to 1998 by Type	1-5
1-2	Summary of Statewide Advisories in Effect in 1998	1-9
1-3	Comparison of FDA Action Levels and Tolerances with EPA Screening Values	1-12
2-1	Recommended Strategy for State Fish and Shellfish Contaminant Monitoring Programs	2-5
3-1	Recommended Target Species for Inland Fresh Waters	3-4
3-2	Recommended Target Species for Great Lakes Waters	3-4
3-3	Comparison of Freshwater Finfish Species Used in Several National Fish Contaminant Monitoring Programs	3-6
3-4	Freshwater Turtles Recommended for Use as Target Species . . .	3-7
3-5	Average Fish Tissue Concentrations (ppb) of Xenobiotics for Major Finfish Species Sampled in the National Study of Chemical Residues in Fish	3-8
3-6	Average Fish Tissue Concentrations (ppt) of Dioxins and Furans for Major Finfish Species Sampled in the National Study of Chemical Residues in Fish	3-9
3-7	Principal Freshwater Fish Species Cited in State Fish Consumption Advisories	3-11
3-8	Principal Freshwater Turtle Species Cited in State Consumption Advisories	3-12
3-9	Studies Using Freshwater Turtles as Biomonitors of Environmental Contamination	3-14
3-10	Recommended Target Species for Northeast Atlantic Estuaries and Marine Waters (Maine through Connecticut)	3-16
3-11	Recommended Target Species for Mid-Atlantic Estuaries and Marine Waters (New York through Virginia)	3-17
3-12	Recommended Target Species for Southeast Atlantic Estuaries and Marine Waters (North Carolina through Florida) . .	3-18
3-13	Recommended Target Species for Gulf of Mexico Estuaries and Marine Waters (West Coast of Florida through Texas)	3-19
3-14	Recommended Target Species for Pacific Northwest Estuaries and Marine Waters (Alaska through Oregon)	3-20
3-15	Recommended Target Species for Northern California Estuaries and Marine Waters (Klamath River through Morro Bay)	3-21

Number	Page
3-16 Recommended Target Species for Southern California Estuaries and Marine Waters (Santa Monica Bay to Tijuana Estuary)	3-22
3-17 Sources of Information on Commercial and Sportfishing Species in Various Coastal Areas of the United States	3-24
3-18 Estuarine/Marine Species Used in Several National Fish and Shellfish Contaminant Monitoring Programs	3-25
3-19 Principal Estuarine/Marine Fish and Shellfish Species Cited in State Consumption Advisories	3-29
4-1 Recommended Target Analytes	4-2
4-2 Contaminants Resulting in Fish and Shellfish Advisories	4-4
4-3 Selection and Prioritization of Target Analytes by Watershed Type	4-6
4-4 Total Mercury and Methylmercury Concentrations in Estuarine Fish from South Florida	4-18
4-5 Chlordane Constituent Concentrations ^a Detected in the EPA National Study of Chemical Residues in Fish	4-26
4-6 Summary of PCBs Detected in Fish Tissue ^a as Part of the National Study of Chemical Residues in Fish	4-50
4-7 Polychlorinated Biphenyl (PCB) Congeners Recommended for Quantitation as Potential Target Analytes	4-53
4-8 Summary of Dioxins/Furans Detected in Fish Tissue as Part of the EPA National Study of Chemical Residues in Fish	4-56
4-9 Dibenzo-p-Dioxins and Dibenzofurans Recommended for Analysis as Target Analytes	4-59
5-1 Recommended Values for Mean Body Weights (BW _s) and Fish Consumption Rates (CR _s) for Selected Subpopulations	5-5
5-2 Fish Consumption Rates for Various Fisher Populations	5-10
5-3 Dose-Response Variables and Recommended Screening Values (SV _s) for Target Analytes - Recreational Fishers	5-11
5-4 Dose-Response Variables and Recommended Screening Values (SV _s) for Target Analytes - Subsistence Fishers	5-13
5-5 Example Screening Values (SV _s) for Various Target Populations and Risk Levels (RL _s)	5-17
5-6 Toxicity Equivalency Factors for Various PAHs	5-20
5-7 Toxicity Equivalency Factors (TEF _s) for Tetra-through Octa-Chlorinated Dibenzo-p-Dioxins and Dibenzofurans and Dioxin-Like PCBs	5-22

Number		Page
6-1	Values of $\left[\frac{2}{n^2 m^2 (n-1)} \right]^{1/2}$ for Various Combinations of n and m . .	6-30
6-2	Estimates of Statistical Power of Hypothesis of Interest Under Specified Assumptions	6-32
6-3	Observed Ratios (σ/SV) of Selected Target Analytes	6-33
6-4	Summary of Fish Sampling Equipment	6-39
6-5	Summary of Shellfish Sampling Equipment	6-40
6-6	Checklist of Field Sampling Equipment and Supplies for Fish and Shellfish Contaminant Monitoring Programs	6-42
6-7	Safety Considerations for Field Sampling Using a Boat	6-43
6-8	Recommendations for Preservation of Fish, Shellfish, and Turtles Samples from Time of Collection to Delivery at the Processing Laboratory	6-63
7-1	Recommendations for Container Materials, Preservation, and Holding Times for Fish, Shellfish, and Turtle Tissues from Receipt at Sample Processing Laboratory to Analysis	7-4
7-2	Weights (g) of Individual Homogenates Required for Screening Study Composite Homogenate Sample	7-16
7-3	Recommended Sample Aliquot Weights and Containers for Various Analyses	7-30
8-1	Contract Laboratories Conducting Dioxin/Furan Analyses in Fish and Shellfish Tissues	8-2
8-2	Current References for Analytical Methods for Contaminants in Fish and Shellfish Tissues	8-5
8-3	Recommended Analytical Techniques for Target Analytes	8-8
8-4	Range of Detection and Quantitation Limits of Current Analytical Methods for Recommended Target Analytes	8-10
8-5	Approximate Range of Costs per Sample for Analysis of Recommended Target Analytes	8-13
8-6	Recommended Quality Assurance and Quality Control Samples	8-17
8-7	Minimum Recommended QA and QC Samples for Routine Analysis of Target Analytes	8-23
8-8	Fish and Shellfish Tissue Reference Materials	8-26

ACKNOWLEDGMENTS

This report was prepared by the U.S. Environmental Protection Agency, Office of Water, Fish and Wildlife Contamination Program. The EPA Project Manager for this document was Jeffrey Bigler who provided overall project coordination as well as technical direction. EPA was supported in the development of this document by the Research Triangle Institute (RTI) (EPA Contract Number 68-C7-0056). Pat Cunningham of RTI was the contractor's Project Manager. Preparation of the First Edition of this guidance in 1993 was facilitated by the substantial efforts of the numerous Workgroup members and reviewers listed in Appendix A.

ACRONYMS

AFS	American Fisheries Society
ANOVA	Analysis of Variance
ATSDR	Agency for Toxic Substances and Disease Registry
BCF	bioconcentration factor
BW	body weight
CDD	chlorodibenzo- <i>p</i> -dioxin
CDF	chlorodibenzofuran
CERCLA	Comprehensive Environmental Response, Compensation, and Liability Act
CLP	Contract Laboratory Program
COC	chain-of-custody
CR	consumption rate
CRM	certified reference material
CRADAs	Cooperative Research and Development Agreements
CSF	cancer slope factor
CSFII	Continuing Survey of Food Intake by Individuals
CSOs	combined sewer overflows
CV	coefficient of variation
CVAAS	cold vapor atomic absorption spectrometry
DFTPP	decafluorotriphenylphosphine
DOT	U.S. Department of Transportation
EMAP	Environmental Monitoring and Assessment Program
EMAP-NC	Environmental Monitoring and Assessment Program—Near Coastal
EPA	U.S. Environmental Protection Agency
EMMI	Environmental Monitoring Methods Index System
FDA	U.S. Food and Drug Administration

FWS	U.S. Fish and Wildlife Service
γ-BHC	benzene hexachloride
γ-HCH	hexachlorocyclohexane
GC/ECD	gas chromatography/electron capture detection
GC/FID	gas chromatography/flame ionization detection
GC/FPD	gas chromatography/flame photometric detection
GC/NPD	gas chromatography/nitrogen-phosphorus detection
GC/MS	gas chromatography/mass spectrometry
GFAA	graphic furnace atomic absorption spectrometry
GLIFWC	Great Lakes Indian Fish and Wildlife Commission
GPS	Global Positioning System
HAA	hydride generation atomic absorption spectrometry
HEAST	Health Effects Assessment Summary Tables
HPLC/MS	high-performance liquid chromatography/mass spectrometry
HRGC/LRMS	high-resolution gas chromatography/low-resolution mass spectrometry
HRGC/HRMS	high-resolution gas chromatography/high-resolution mass spectrometry
ICP	inductively coupled plasma atomic emission spectrometry
IDL	instrument detection limit
IRIS	Integrated Risk Information System
IUPAC	Information Union of Pure and Applied Chemistry
LAN	local area network
LLD	lower limits of detection
LOAEL	lowest observed adverse effects level
LOD	limit of detection
LOQ	limit of quantitation
MDL	method detection limit
MQL	method quantitation limit
NAS	National Academy of Sciences
NEP	National Estuary Program
NERRS	National Estuarine Research Research System

NCBP	National Contaminant Biomonitoring Program
NCR	no-carbon-required
ND	not detected
NEP	National Estuary Program
NFTDR	National Fish Tissue Data Repository
NIST	National Institute of Standards and Technology
NLFWA	National Listing of Residue Fish and Wildlife Advisors
NOAA	National Oceanic and Atmospheric Administration
NOAEL	no observed adverse effects level
NRCC	National Research Council of Canada
NS&T	National States and Trends Program
NSCRF	National Study of Chemical Residues in Fish
NTIS	National Technical Information Service
OAPCA	Organotin Antifouling Paint Control Act
OAQPS	Office of Air Quality Planning and Standards
OCDD	octachlorodibenzo- <i>p</i> -dioxin
OCDF	octachlorodibenzofuran
ODES	Ocean Discharge Evaluation System
ODW	Office of Drinking Water
OHEA	Office of Health and Environmental Assessment
OPP	Office of Pesticide Programs
ORSANCO	Ohio River Valley Water Sanitation Commission
PAB	Population Adjusted Dose
PAHs	polycyclic aromatic hydrocarbons
PBBs	polybrominated biphenyls
PCBs	polychlorinated biphenyls
PCDDs	polychlorinated dibenzo- <i>p</i> -dioxins
PCDFs	polychlorinated dibenzofurans
PEC	potency equivalency concentration
PNAs	polynuclear aromatic hydrocarbons
PQL	practical quantitation limit
PTFE	polytetrafluoroethylene

QA	quality assurance
QC	quality control
RCRA	Resource Conservation and Recovery Act
RDL	reliable detection limit
RFs	response factors
RfD	reference dose
RL	risk level
RPs	relative potencies
RPD	relative percent difference
RRFs	relative response factors
RSD	relative standard deviation
SOPs	standard operating procedures
SRMs	standard reference materials
SVs	screening values
2,4,5-T	2,4,5-trichlorophenoxyacetic acid
2,3,7,8-TCDD	2,3,7,8-tetrachlorodibenzo- <i>p</i> -dioxin
2,3,7,8-TCDF	2,3,7,8-tetrachlorodibenzofuran
2,4,5-T	2,4,5-trichlorophenoxyacetic acid
2,4,5-TCP	2,4,5-trichlorophenol
TEFs	toxicity equivalency factor
TEQs	toxicity equivalency concentrations
TVA	Tennessee Valley Authority
UF	uncertainty factor
UM	modifying factor
USDA	U.S. Department of Agriculture
USGS	U.S. Geological Survey
USFWS	U.S. Fish and Wildlife Service
WHO	World Health Organization

EXECUTIVE SUMMARY

A 1988 survey, funded by the U.S. Environmental Protection Agency (EPA) and conducted by the American Fisheries Society, identified the need for standardizing the approaches to evaluating risks and developing fish consumption advisories that are comparable across different jurisdictions. Four major components were identified as critical to the development of a consistent risk-based approach: standardized practices for sampling and analyzing fish, standardized risk assessment methods, standardized procedures for making risk management decisions, and standardized approaches for communicating risk to the general public.

To address concerns raised by the survey respondents, EPA began developing a series of four documents designed to provide guidance to state, local, regional, and tribal environmental health officials responsible for designing contaminant monitoring programs and issuing fish and shellfish consumption advisories. It is essential that all four documents be used together, since no single volume addresses all of the topics involved in the development of fish consumption advisories. The documents are meant to provide guidance only and do not constitute a regulatory requirement. This document series includes:

Guidance for Assessing Chemical Contaminant Data for Use in Fish Advisories

- Volume 1: Fish Sampling and Analysis*
- Volume 2: Risk Assessment and Fish Consumption Limits*
- Volume 3: Overview of Risk Management*
- Volume 4: Risk Communication.*

Volume 1 was first released in September 1993 and was followed by a second edition in September 1995. This current revision to the Volume 1 guidance provides the latest information on sampling and analysis procedures based on new information provided by EPA. The major objective of Volume 1 is to provide information on sampling strategies for a contaminant monitoring program. In addition, information is provided on selection of target species; selection of chemicals as target analytes; development of human health screening values; sample collection procedures including sample processing, sample preservation, and shipping; sample analysis; and data reporting and analysis.

Volume 2 was first released in June 1994 and was followed by a second edition in July 1997. A third edition will be released in November 2000. This volume provides guidance on the development of appropriate meal sizes and frequency of meal consumption (e.g., one meal per week) for the target analytes that

bioaccumulate in fish tissues. In addition to the presentation of consumption limits, Volume 2 contains a discussion of risk assessment methods used to derive the consumption limits as well as a discussion of methods to modify these limits to reflect local conditions. Volume 2 also contains toxicological profiles for each of the 25 target analytes.

Volume 3 was published in June 1996 and provides an overview of a risk management framework. This volume provides information on selecting and implementing various options for reducing health risks associated with the consumption of chemically contaminated fish and shellfish. Using a human health risk-based approach, states can determine the level of the advisory and the most appropriate type of advisory to issue. Methods to evaluate population risks for specific groups, waterbodies, and geographic areas are also presented.

Volume 4 was published in March 1995 and provides guidance on risk communication as a process for sharing information with the public on the health risks of consuming chemically contaminated fish and shellfish. This volume provides guidance on problem analysis and program objectives, audience identification and needs assessments, communication strategy design, implementation and evaluation, and responding to public inquiries.

EPA welcomes your suggestions and comments. A major goal of this guidance document series is to provide a clear and usable summary of critical information necessary to make informed decisions concerning the development of fish consumption advisories. We encourage comments and hope this document will be a useful adjunct to the resources used by the states, local governments, and tribal organizations in making decisions concerning the development of fish advisories within their various jurisdictions.

SECTION 1

INTRODUCTION

1.1 HISTORICAL PERSPECTIVE

Contamination of aquatic resources, including freshwater, estuarine, and marine fish and shellfish, has been documented in the scientific literature for many regions of the United States (NAS, 1991). Environmental concentrations of some pollutants have decreased over the past 25 years as a result of better water quality management practices. However, environmental concentrations of other heavy metals, pesticides, and toxic organic compounds have increased due to intensifying urbanization, industrial development, and use of new agricultural chemicals. Our Nation's waterbodies are among the ultimate repositories of pollutants released from these activities. Pollutants come from permitted point source discharges (e.g., industrial and municipal facilities), accidental spill events, and nonpoint sources (e.g., agricultural practices, resource extraction, urban runoff, in-place sediment contamination, groundwater recharge, vehicular exhaust, and atmospheric deposition from various combustion and incineration processes).

Once these toxic contaminants reach surface waters, they may concentrate through aquatic food chains and bioaccumulate in fish and shellfish tissues. Aquatic organisms may bioaccumulate environmental contaminants to more than 1,000,000 times the concentrations detected in the water column (U.S. EPA, 1992c, 1992d). Thus, fish and shellfish tissue monitoring serves as an important indicator of contaminated sediments and water quality problems, and many states routinely conduct chemical contaminant analyses of fish and shellfish tissues as part of their comprehensive water quality monitoring programs (Cunningham and Whitaker, 1989; Cunningham, 1998; Cunningham and Sullivan, 1999). Tissue contaminant monitoring also enables state agencies to detect levels of contamination in fish and shellfish tissue that may be harmful to human consumers. If states conclude that consumption of chemically contaminated fish and shellfish poses an unacceptable human health risk, they may issue local fish consumption advisories or bans for specific waterbodies and specific fish and shellfish species for specific populations.

In 1989, the American Fisheries Society (AFS), at the request of the U.S. Environmental Protection Agency (EPA), conducted a survey of state fish and shellfish consumption advisory practices. Questionnaires were sent to health departments, fisheries agencies, and water quality/environmental management departments in all 50 states and the District of Columbia. Officials in all 50 states and the District responded.

Respondents were asked to provide information on several issues including

- Agency responsibilities
- Sampling strategies
- Sample collection procedures
- Chemical residue analysis procedures
- Risk assessment methodologies
- Data interpretation and advisory development
- State concerns
- Recommendations for federal assistance.

Cunningham et al. (1990) summarized the survey responses and reported that monitoring and risk assessment procedures used by states in their fish and shellfish advisory programs varied widely. States responded to the question concerning assistance from the federal government by requesting that federal agencies

- Provide a consistent approach for state agencies to use in assessing health risks from consumption of chemically contaminated fish and shellfish
- Develop guidance on sample collection procedures
- Develop and/or endorse uniform, cost-effective analytical methods for quantitation of contaminants
- Establish a quality assurance (QA) program that includes use of certified reference materials for chemical analyses.

In March 1991, the National Academy of Sciences (NAS) published a report entitled *Seafood Safety* (NAS, 1991) that reviewed the nature and extent of public health risks associated with seafood consumption and examined the scope and adequacy of current seafood safety programs. After reviewing over 150 reports and publications on seafood contamination, the NAS Institute of Medicine concluded that high concentrations of chemical contaminants exist in various fish species in a number of locations in the country. The report noted that the fish monitoring data available in national and regional studies had two major shortcomings that affected their usefulness in assessing human health risks:

- In some of the more extensive studies, analyses were performed on nonedible portions of finfish (e.g., liver tissue) or on whole fish, which precludes accurate determination of human exposures.
- Studies did not use consistent methods of data reporting (e.g., both geometric and arithmetic means were reported in different studies) or failed to report crucial information on sample size, percent lipid, mean values of contaminant concentrations, or fish size, thus precluding direct comparison of the data from different studies and complicating further statistical analysis and risk assessment.

1.1.1 Establishment of the Fish Contaminant Workgroup

As a result of NAS concerns and state concerns expressed in the AFS survey, EPA's Office of Water established a Fish Contaminant Workgroup. It was composed of representatives from EPA and the following state and federal agencies:

- U.S. Food and Drug Administration (FDA)
- U.S. Fish and Wildlife Service (FWS)
- Ohio River Valley Water Sanitation Commission (ORSANCO)
- National Oceanic and Atmospheric Administration (NOAA)
- Tennessee Valley Authority (TVA)
- United States Geological Survey (USGS)

and representatives from 26 states: Alabama, Arkansas, California, Colorado, Delaware, Florida, Georgia, Illinois, Indiana, Louisiana, Maryland, Massachusetts, Michigan, Minnesota, Missouri, Nebraska, New Hampshire, New Jersey, New York, North Carolina, North Dakota, Ohio, Oregon, Texas, Virginia, and Wisconsin.

The objective of the EPA Fish Contaminant Workgroup was to formulate guidance for states on how to sample and analyze chemical contaminants in fish and shellfish where the primary end uses of the data included development of fish consumption advisories. The Workgroup compiled documents describing protocols currently used by various federal agencies, EPA Regional offices, and states that have extensive experience in fish contaminant monitoring. Using these documents, they selected methods considered most cost-effective and scientifically sound for sampling and analyzing fish and shellfish tissues. These methods were recommended as standard procedures for use by the states and are described in this guidance document.

1.1.2 Development of a National Fish Advisory Database

In addition to initiating work on the national guidance document series in 1993, EPA also initiated work on the development of a national database — The National Listing of Fish and Wildlife Advisories (NLFWA) database — for tracking fish and wildlife advisories issued by the states. The 1998 update of the NLFWA database includes all available information describing state, territorial, tribal, and federal fish consumption advisories issued in the United States (U.S. EPA 1999a, 1999c). The database contains fish consumption advisory information provided to EPA by the states and other jurisdictions from 1993 through December 1998. It also includes information from 1996 through 1997 for 12 Canadian provinces and territories. No updates to information on Canadian advisories were made in 1998. Since the release of the first fish advisory results in 1994, advisory results and trends have been accessible to states, territories, tribal organizations, and the general public by querying the NLFWA database or through summary information reported each year in the *EPA Fact Sheet—Update: National Listing of Fish and*

Wildlife Advisories. Fish advisory results and trends reported in the 1999 Fish Advisory Fact Sheet (U.S. EPA, 1999c) are presented below. The most recent updates of the Fish Advisory Fact Sheet are available on the EPA website at <http://epa.gov/OST/fish>.

1.1.2.1 Background—

The states, U.S. territories, and Native American tribes (hereafter referred to as states) have primary responsibility for protecting residents from the health risks of consuming contaminated noncommercially caught fish and wildlife. They do this by issuing consumption advisories for the general population, including recreational and subsistence fishers, as well as for sensitive subpopulations (such as pregnant women, nursing mothers, and children). These advisories inform the public that high concentrations of chemical contaminants (e.g., mercury and dioxins) have been found in local fish and wildlife. The advisories include recommendations to limit or avoid consumption of certain fish and wildlife species from specified waterbodies or, in some cases, from specific waterbody types (e.g., all inland lakes). Similarly, in Canada, the provinces and territories have primary responsibility for issuing fish consumption advisories for their residents.

States typically issue five major types of advisories and bans to protect both the general population and specific subpopulations.

- When levels of chemical contamination pose a health risk to the general public, states may issue a no consumption advisory for the general population.
- When contaminant levels pose a health risk to sensitive subpopulations, states may issue a no consumption advisory for the sensitive subpopulation.
- In waterbodies where chemical contamination is less severe, states may issue an advisory recommending that either the general population or a sensitive subpopulation restrict their consumption of the specific species for which the advisory is issued.
- The fifth type of state-issued advisory is the commercial fishing ban, which prohibits the commercial harvest and sale of fish, shellfish, and/or wildlife species from a designated waterbody and, by inference, the consumption of all species identified in the fishing ban from that waterbody.

As shown in Table 1-1, advisories of all types increased overall in number from 1993 to 1998.

1.1.2.2 Advisories in Effect—

The database includes information on

- Species and size ranges of fish and/or wildlife sampled
- Chemical contaminants identified in the advisory

Table 1-1. U.S. Advisories Issued from 1993 to 1998 by Type

	1993	1994	1995	1996	1997	1998
No Consumption – General Population	503	462	463	563	545	532
No Consumption – Sensitive Subpopulation	555	720	778	1,022	1,119	1,211
Restricted Consumption – General Population	993	1,182	1,372	1,763	1,843	2,062
Restricted Consumption – Sensitive Subpopulation	689	900	1,042	1,370	1,450	1,595
Commercial Fishing Ban	30	30	55	50	52	50

Source: U.S. EPA 1999a, 1999c.

- Geographic location of each advisory (including narrative information on landmarks, river miles, or latitude and longitude coordinates of the affected waterbody and map showing location of waterbody)
- Lake acreage or river miles under advisory
- Population for whom the advisory was issued
- Fish tissue chemical residue data from waterbodies under advisory.

The 1994, 1995, 1996, 1997, and 1998 versions of the NLFWA database can generate national, regional, and state maps that illustrate any combination of these advisory parameters. In addition, the 1996 through 1998 versions of the database can provide information on the percentage of waterbodies in each state currently under an advisory and the percentage of waters assessed. A new feature of the 1998 database provides users access to fish tissue residue data for those waterbodies under advisory in 16 states. The name of each state contact, phone number, FAX number, and e-mail address are also provided so that users can obtain additional information concerning specific advisories. Comparable advisory information (excluding tissue residue data) and contact information for 1996 and 1997 are provided for each Canadian province or territory.

1.1.2.3 Advisory Trends—

The number of waterbodies in the United States under advisory reported in 1998 (2,506) represents a 9% increase from the number reported in 1997 (2,299 advisories) and a 98% increase from the number of advisories issued since 1993 (1,266 advisories). Figure 1-1 shows the number of advisories in effect for each state in 1998 and the number of advisories issued or rescinded since 1997. The increase in advisories issued by the states generally reflects an increase in the number of assessments of the levels of chemical contaminants in fish and wildlife tissues. These additional assessments were conducted as a result of the increased awareness of health risks associated with the consumption of chemically contaminated fish and wildlife. Some of the increase in advisory numbers, however, may be due to the increasing use of EPA risk assessment procedures in setting advisories rather than FDA action levels developed for commercial fisheries.

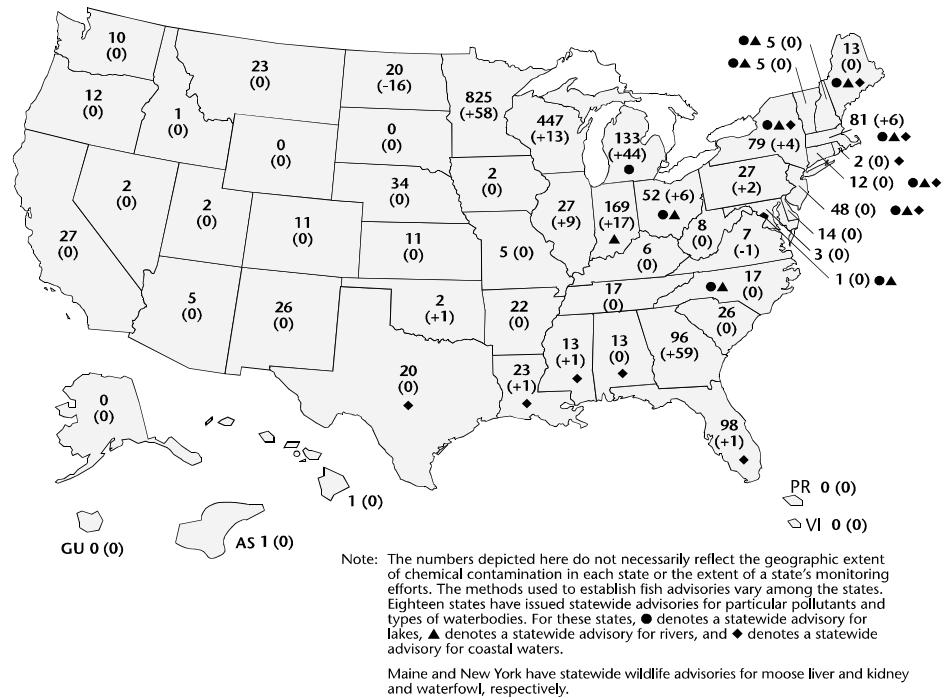

Source: U.S. EPA, 1999c.

Figure 1-1. Total number of fish advisories in effect in each state in 1998 (change from 1997).

1.1.2.4 Bioaccumulative Pollutants—

Although U.S. advisories have been issued for a total of 46 chemical contaminants, most advisories issued have involved five primary contaminants. These chemical contaminants are biologically accumulated in the tissues of aquatic organisms at concentrations many times higher than concentrations in the water. In addition, these chemical contaminants persist for relatively long periods in sediments where they can be accumulated by bottom-dwelling organisms and passed up the food chain to fish. Concentrations of these contaminants in the tissues of aquatic organisms may be increased at each successive level of the food chain. As a result, top predators in a food chain, such as largemouth bass, salmon, or walleye, may have concentrations of these chemicals in their tissues that can be a million times higher than the concentrations in the water. Mercury, PCBs, chlordane, dioxins, and DDT (and its degradation products, DDE and DDD) were at least partly responsible for 99 percent of all fish consumption advisories in effect in 1998. (See Figure 1-2.)

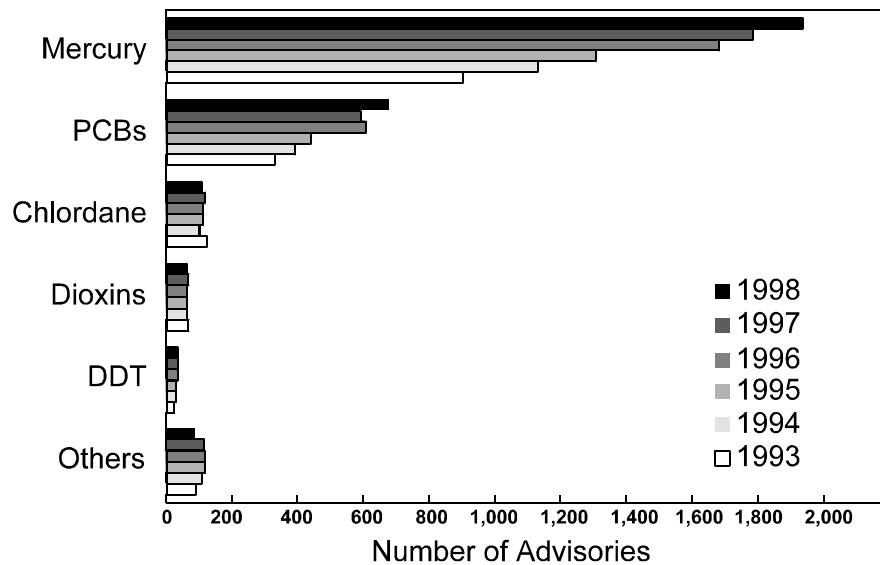

Source: U.S. EPA, 1999a, 1999c.

Figure 1-2. Trends in number of advisories issued for various pollutants.

1.1.2.5 Wildlife Advisories—

In addition to advisories for fish and shellfish, the database also contains several wildlife advisories. Four states have issued consumption advisories for turtles: Arizona (3), Massachusetts (1), Minnesota (8), and New York (statewide advisory). One state (Massachusetts) has an advisory for frogs, New York has a statewide advisory for waterfowl (including mergansers), Arkansas has an advisory for woodducks, and Utah has an advisory for American coot and ducks. Maine issued a statewide advisory for moose liver and kidneys due to cadmium levels. No new wildlife advisories were issued in 1998.

1.1.2.6 1998 United States Advisories—

The 1998 database lists 2,506 advisories in 47 states, the District of Columbia, and the U.S. Territory of American Samoa. Some of these advisories represent statewide advisories for certain types of waterbodies (e.g., lakes, rivers, and/or coastal waters). An advisory may represent one waterbody or one type of waterbody within a state's jurisdiction. Statewide advisories are counted as one advisory. The database counts one advisory for each waterbody name or type of waterbody regardless of the number of fish or wildlife species that are affected or the number of chemical contaminants detected at concentrations of human health concern. Eighteen states (Alabama, Connecticut, District of Columbia, Florida, Indiana, Louisiana, Maine, Massachusetts, Michigan, Mississippi, New Hampshire, New Jersey, New York, North Carolina, Ohio, Rhode Island, Texas,

and Vermont) currently have statewide advisories in effect (see Table 1-2). Missouri rescinded its statewide advisories for lakes and rivers in 1998, and Mississippi added a statewide coastal advisory for mercury. A statewide advisory is issued to warn the public of the potential for widespread contamination of certain species of fish in certain types of waterbodies (e.g., lakes, rivers and streams, or coastal waters) or certain species of wildlife (e.g., moose or waterfowl). In such a case, the state may have found a level of contamination of a specific pollutant in a particular fish or wildlife species over a relatively wide geographic area that warrants advising the public of the situation.

The statewide advisories and 2,506 specifically named waterbodies represent approximately 15.8 percent of the Nation's total lake acreage and 6.8% of the Nation's total river miles. In addition, 100 percent of the Great Lakes waters and their connecting waters are also under advisory due to one or more contaminants (e.g., PCBs, dioxins, mercury, and/or chlordane). The Great Lakes waters are considered separately from other lakes, and their connecting waters are considered separately from other river miles.

Several states also have issued fish advisories for all of their coastal waters. Using coastal mileages calculated by the National Oceanic and Atmospheric Administration (NOAA), an estimated 58.9 percent of the coastline of the contiguous 48 states currently is under advisory. This includes 61.5 percent of the Atlantic Coast and 100 percent of the Gulf Coast. No Pacific Coast state has issued a statewide advisory for any of its coastal waters although several localized areas along the Pacific Coast are under advisory. The Atlantic coastal advisories have been issued for a wide variety of chemical contaminants including mercury, PCBs, dioxins, and cadmium, while all of the Gulf Coast advisories have been issued for mercury.

1.1.2.7 Database Use and Access—

The NLFWA database was developed by EPA to help federal, state, and local government agencies and Native American tribes assess the potential for human health risks associated with consumption of chemical contaminants in noncommercially caught fish and wildlife. The data contained in this database may also be used by the general public to make informed decisions about the waterbodies in which they choose to fish or harvest wildlife; the frequency with which they fish these waterbodies; the species, size, and number of fish they collect; and the frequency with which they consume fish from specific waterbodies. Note: State fish advisory contact information and hyperlinks to state fish advisory websites are also provided.

EPA provides this 1998 update of the NLFWA database available on the Internet at

<http://www.epa.gov/OST/fish>

Table 1-2. Summary of Statewide Advisories in Effect in 1998

State	Lakes	Rivers	Coastal Waters
Alabama	—	—	Mercury
Connecticut	Mercury	Mercury	PCBs
District of Columbia	PCBs	PCBs	—
Florida	—	—	Mercury
Indiana	—	Mercury PCBs	—
Louisiana	—	—	Mercury
Maine	Mercury	Mercury	Dioxins
Massachusetts	Mercury	Mercury	PCBs Organics
Michigan	Mercury	—	—
Mississippi	—	—	Mercury
New Hampshire	Mercury	Mercury	PCBs
New Jersey	Mercury	Mercury	PCBs Cadmium Dioxins
New York	PCBs Chlordane Mirex DDT	PCBs Chlordane Mirex DDT	PCBs Cadmium Dioxins
North Carolina	Mercury	Mercury	—
Ohio	Mercury	Mercury	—
Rhode Island	—	—	PCBs
Texas	—	—	Mercury
Vermont	Mercury	Mercury	—

Source: U.S. EPA, 1999a, 1999c.

Further information on specific advisories within a particular state is available from the appropriate state agency contact listed in the database. This is particularly important for advisories recommending that consumers restrict their consumption of fish from certain waterbodies. State health departments provide more specific information for restricted consumption advisories (RGP and RSP) on the appropriate meal size and meal frequency (number of meals per week or month) that is considered safe to consume for a specific consumer group (e.g., the general public versus pregnant women, nursing mothers, and young children). For further information on Canadian advisories, contact the appropriate Province contact given in the database.

For more information concerning the National Fish and Wildlife Contamination Program, contact:

U.S. Environmental Protection Agency
 Office of Science and Technology
 National Fish and Wildlife Contamination Program—4305
 1200 Pennsylvania Avenue, NW
 Washington, DC 20460
 Phone 202 260-7301 FAX 202 260-9830
 e-mail: Bigler.Jeff@epa.gov

1.2 PURPOSE

The purpose of this manual is to provide overall guidance to states on methods for sampling and analyzing contaminants in fish and shellfish tissue that will promote consistency in the data they use to determine the need for fish consumption advisories. This manual provides guidance only and does not constitute a regulatory requirement for the states. It is intended to describe what EPA believes to be scientifically sound methods for sample collection, chemical analyses, and statistical analyses of fish and shellfish tissue contaminant data for use in fish contaminant monitoring programs that have as their objective the protection of public health. This nonregulatory, technical guidance manual is intended for use as a handbook by state and local agencies that are responsible for sampling and analyzing fish and shellfish tissue. Adherence to this guidance will enhance the comparability of fish and shellfish contaminant data, especially in interstate waters and thus provide more standardized information on fish contamination problems.

It should be noted that the EPA methodology described in Volumes 1 and 2 of this guidance series offers great flexibility to state users. These documents are designed to meet the objectives of state monitoring and risk assessment programs by providing options to meet specific state or study needs within state budgetary constraints. The users of this fish advisory guidance document should recognize that it is the consistent application of the EPA methodology and processes rather than individual elements of the program sampling design that are of major importance in improving consistency among state fish advisory programs. For example, whether a state elects to collect three composite samples of five individual fish or four composite samples of eight individual fish as the basis of its state program is of less importance than a state designing and executing its monitoring program with attention to all elements of the EPA methodology having been considered and addressed during the planning and implementation phases.

One major factor currently affecting the comparability of fish advisory information nationwide, is the fact that the states employ different methodologies to determine the necessity for issuing an advisory. For example, some states currently do not use the EPA methodology at all or use it only in their assessment of health risks for certain chemical contaminants. Often these states rely instead on exceedances of FDA action levels or tolerances to determine the need to issue an advisory. FDA's mission is to protect the public health with respect to levels of chemical contaminants in all foods, including fish and shellfish sold in interstate commerce. FDA has developed both action levels and tolerances to address levels of contamination in foods. FDA may establish an action level when food contains a chemical from sources of contamination that cannot be avoided even by adherence to good agricultural or manufacturing practices, such as

contamination by a pesticide that persists in the environment. An action level is an administrative guideline or instruction to the agency field unit that defines the extent of contamination at which FDA may regard food as adulterated. An action level represents the limit at or above which FDA may take legal action to remove products from the marketplace. Under the Food, Drug, and Cosmetic Act, FDA also may set tolerances for unavoidably added poisonous or deleterious substances, that is, substances that are either required in the production of food or are otherwise unavoidable by good manufacturing practices. A tolerance is a regulation that is established following formal rulemaking procedures; an action level is a guideline or "instruction" and is not a formal regulation (Boyer et al., 1991).

FDA's jurisdiction in setting action levels or tolerances is limited to contaminants in food shipped and marketed in interstate commerce. Thus, the methodology used by FDA in establishing action levels or tolerances is directed at determining the health risks of chemical contaminants in fish and shellfish that are bought and sold in interstate commerce rather than in locally harvested fish and shellfish (Bolger et al., 1990). FDA action levels and tolerances are indicators of chemical residue levels in fish and shellfish that should not be exceeded for the general population who consume fish and shellfish typically purchased in supermarkets or fish markets that sell products that are harvested from a wide geographic area, including imported fish and shellfish products. However, the underlying assumptions used in the FDA methodology were never intended to be protective of recreational, tribal, ethnic, and subsistence fishers who typically consume larger quantities of fish than the general population and often harvest the fish and shellfish they consume from the same local waterbodies repeatedly over many years. If these local fishing and harvesting areas contain fish and shellfish with elevated tissue levels of chemical contaminants, these individuals potentially could have increased health risks associated with their consumption of the contaminated fish and shellfish.

The following chemical contaminants discussed in this volume have FDA action levels for their concentration in the edible portion of fish and shellfish: chlordane, DDT, DDE, DDD, heptachlor epoxide, mercury, and mirex. FDA has not set an action level for PCBs in fish but has established a tolerance in fish for this chemical. Table 1-3 compares the FDA action levels and tolerance for these six chemical contaminants with EPA's recommended screening values (SVs) for recreational and subsistence fishers calculated for these target analytes using the EPA methodology.

The EPA SV for each chemical contaminant is defined as the concentration of the chemical in fish tissue that is of potential public health concern and that is used as a threshold value against which tissue residue levels of the contaminant in fish and shellfish can be compared. The SV is calculated based on both the

Table 1-3. Comparison of FDA Action Levels and Tolerances with EPA Screening Values

Chemical contaminant	FDA Action Level ^a (ppm)	EPA SV for Recreational Fishers (ppm)	EPA SV for Subsistence Fishers (ppm)
Chlordane	0.3	0.114	0.014
Total DDT	5	0.117	0.014
Dieldrin	0.3	2.50 x 10 ⁻³	3.07 x 10 ⁻⁴
Heptachlor epoxide	0.3	4.39 x 10 ⁻³	5.40 x 10 ⁻⁴
Mercury	1.0	0.40	0.049
Mirex	0.1	0.80	0.098
	FDA Tolerance Level (ppm)		
PCBs	2	0.02	2.45 x 10 ⁻³

^aU.S. FDA 1998.

noncarcinogenic and carcinogenic effects of the chemical contaminant, which are discussed in detail in Section 5 of this volume. EPA recommends that the more conservative of the calculated values derived from the noncarcinogenic rather than the carcinogenic effects be used because it is more protective of the consumer population (either recreational or subsistence fishers). As can be seen in Table 1-3 for the recreational fisher SV, the EPA-recommended values typically range from 2 to 120 times lower and are thus more protective than the corresponding FDA action or tolerance level. This difference is even more striking for subsistence fishers for whom the SVs are 20 to 997 times lower than the FDA values.

EPA and FDA have agreed that the use of FDA Action Levels for the purpose of making local advisory determinations is inappropriate. In letters to all states, guidance documents, and annual conferences, this practice has been discouraged by EPA and FDA in favor of EPA's risk-based approach to derive local fish consumption advisories.

EPA has provided this guidance to be especially protective of recreational fishers and subsistence fishers within the general U.S. population. EPA recognizes, however, that Native American subsistence fishers are a unique subsistence fisher population that needs to be considered separately. For Native American subsistence fishers, eating fish is not simply a dietary choice that can be completely eliminated if chemical contamination reaches unacceptable levels; rather, eating fish is an integral part of their lifestyle and culture. This traditional lifestyle is a living religion that includes values about environmental responsibility and community health as taught by elders and tribal religious leaders (Harris and Harper, 1977). Therefore, methods for balancing benefits and risks from eating

contaminated fish must be evaluated differently than for the general fisher population (see Section 5.1.3.2).

To enhance the use of this guidance as a working document, EPA will issue additional information and updates to users as appropriate. It is anticipated that updates will include minor revisions such as the addition or deletion of chemicals from the recommended list of target analytes, new screening values as new toxicologic data become available, and new chemical analysis procedures for some target analytes as they are developed. A new edition of this document will be issued to include the addition of major new areas of guidance or when major changes are made to the Agency's risk assessment procedures.

EPA's Office of Water realizes that adoption of these recommended methods requires adequate funding. In practice, funding varies among states and resource limitations will cause states to tailor their fish and shellfish contaminant monitoring programs to meet their own needs. States must consider tradeoffs among the various parameters when developing their fish contaminant monitoring programs. These parameters include

- Total number of stations sampled
- Intensity of sampling at each site
- Number of chemical analyses and their cost
- Resources expended on data storage and analysis, QA and quality control (QC), and sample archiving.

Consideration of these tradeoffs will determine the number of sites sampled, number of target analytes analyzed at each site, number of target species collected, and number of replicate samples of each target species collected at each site (Crawford and Luoma, 1993).

1.3 OBJECTIVES

The specific objectives of this manual are to

1. Recommend a tiered monitoring strategy designed to
 - Screen waterbodies (**Tier 1**) to identify those harvested sites where chemical contaminant concentrations in the edible portions of fish and shellfish exceed human consumption levels of potential concern (screening values [**SVs**]). SVs for contaminants with carcinogenic effects are calculated based on selection of an acceptable cancer risk level. SVs for contaminants with noncarcinogenic effects are concentrations determined to be without appreciable noncancer health risk. For a contaminant with both carcinogenic and noncarcinogenic effects, EPA recommends that the lower (more conservative) of these two calculated SVs be used.

- Conduct intensive followup sampling (**Tier 2, Phase I**) to determine the magnitude of the contamination in edible portions of fish and shellfish species commonly consumed by humans in waterbodies identified in the screening process.
 - Conduct intensive sampling at additional sites (**Tier 2, Phase II**) in a waterbody where screening values were exceeded to determine the geographic extent of contamination in various size classes of fish and shellfish.
 - Conduct intensive followup sampling in waterbodies where none of the 25 SVs are exceeded in order to establish areas of unrestricted fish consumption or “green areas.”
2. Recommend target species and criteria for selecting additional species if the recommended target species are not present at a site.
 3. Recommend target analytes to be analyzed in fish and shellfish tissue and criteria for selecting additional analytes.
 4. Recommend risk-based procedures for calculating target analyte screening values.
 5. Recommend standard field procedures including
 - Site selection
 - Sampling time
 - Sample type and number of replicates
 - Sample collection procedures including sampling equipment
 - Field recordkeeping and chain of custody
 - Sample processing, preservation, and shipping.
 6. Recommend cost-effective, technically sound analytical methods and associated QA and QC procedures, including identification of
 - Analytical methods for target analytes with detection limits capable of measuring tissue concentrations at or below SVs
 - Sources of recommended certified reference materials
 - Federal agencies currently conducting QA interlaboratory comparison programs.
 7. Recommend procedures for data analysis and reporting of fish and shellfish contaminant data.
 8. Recommend QA and QC procedures for all phases of the monitoring program and provide guidance for documenting QA and QC requirements in a QA plan or in a combined work/QA project plan.

1.4 RELATIONSHIP OF MANUAL TO OTHER GUIDANCE DOCUMENTS

This manual is the first in a series of four documents to be prepared by EPA's Office of Water as part of a Federal Assistance Plan to help states standardize fish consumption advisories. This series of four documents—*Guidance for Assessing Chemical Contaminant Data for Use in Fish Advisories* includes

- Volume 1: *Fish Sampling and Analysis* (EPA 823-R-93-002), published August 1993; a second edition, published September 1995; and the current third edition (EPA-823-B-00-007) to be published in November 2000.
- Volume 2: *Risk Assessment and Fish Consumption Limits* (EPA 823-B-94-004), published June 1994; a second edition (EPA 823-B-97-009), published in July 1997; and a third edition (EPA-823-B-00-008) to be published in November 2000.
- Volume 3: *Overview of Risk Management* (EPA 823-B-96-006), published in June 1996.
- Volume 4: *Risk Communication* (EPA 823-R-95-001), published March 1995.

This sampling and analysis manual is not intended to be an exhaustive guide to all aspects of sampling, statistical design, development of risk-based screening values, laboratory analyses, QA and QC considerations, data analysis, and reporting for fish and shellfish contaminant monitoring programs. Key references are provided in Section 10, Literature Cited, that detail various aspects of these topics.

1.5 CONTENTS OF VOLUME 1

Figure 1-3 shows how Volume 1 fits into the overall guidance series and lists the major categories of information provided. The first five sections discuss the history of the EPA Fish and Wildlife Contamination Program, monitoring strategy, including selection of target fish and shellfish species, selection of target analytes, and calculation of screening values for all target analytes. Section 6 provides guidance on field sampling and preservation procedures. Sections 7 and 8 provide guidance on laboratory procedures including sample handling and analysis, and Section 9 discusses data analysis and reporting procedures.

Appropriate QA and QC considerations are integral parts of each of the recommended procedures. Section 10 is a compilation of all literature cited in Sections 1 through 9 of this document. New information or revisions to existing information contained in previous editions of this guidance document are briefly described in Section 1.6.

Section 1 of this document reviews the historical development of this guidance document series, describes the purpose and objectives of the Volume 1 manual,

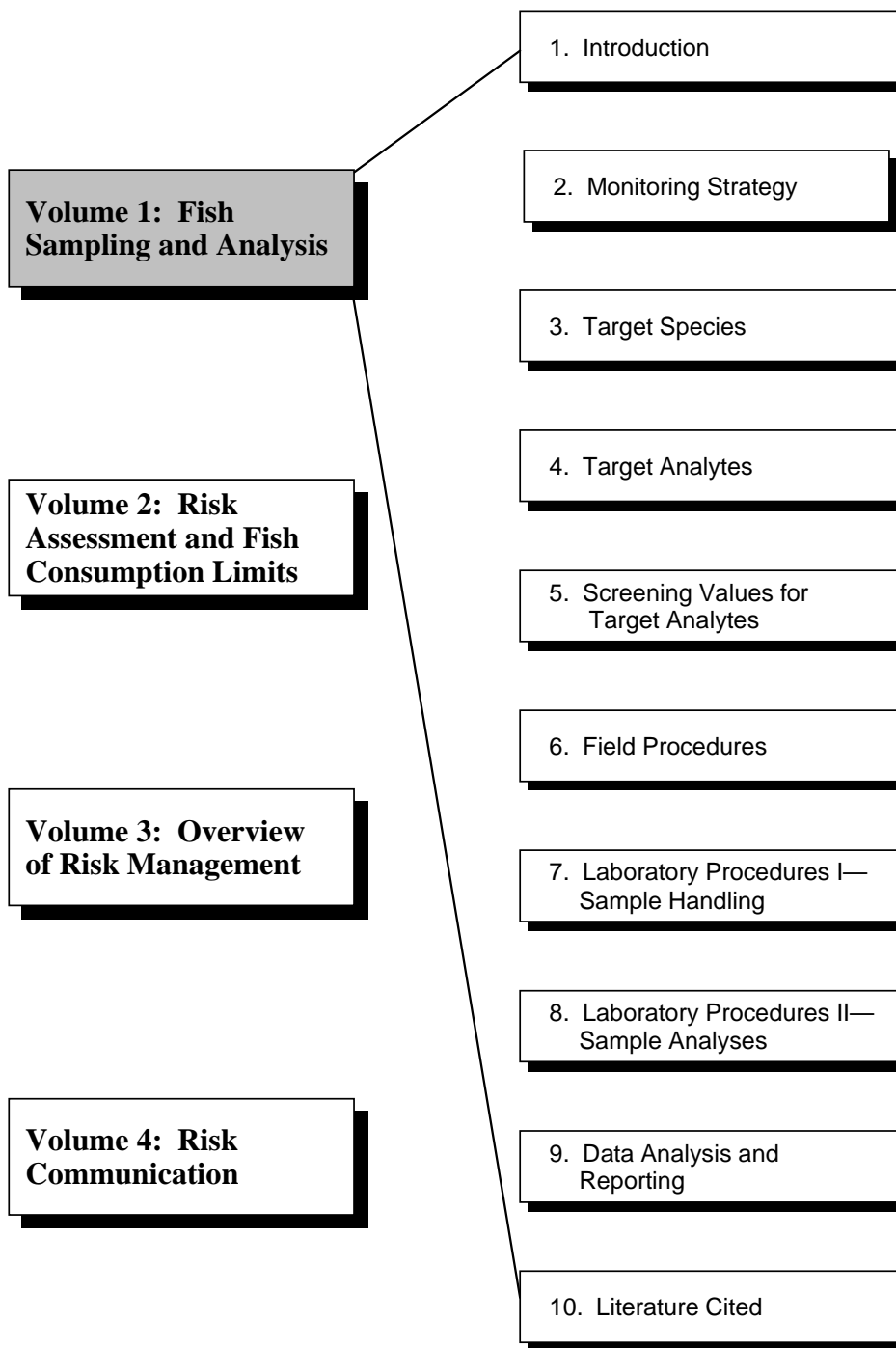

Figure 1-3. Series summary: Guidance for assessing chemical contamination data for use in fish advisories.

outlines the relationship of the manual to the other three documents in the series, describes the contents of the manual, and identifies new revisions made to the guidance of this third edition.

Section 2 outlines the recommended strategy for state fish and shellfish contaminant monitoring programs. This strategy is designed to (1) routinely screen waterbodies to identify those locations where chemical contaminants in edible portions of fish and shellfish exceed human health screening values, (2) sample more intensively those waterbodies where exceedances of these SVs have been found in order to assess the magnitude and the geographic extent of the contamination, and (3) identify those areas where chemical contaminant concentrations are low and would allow states to designate areas where unrestricted fish consumption may be permitted.

Section 3 discusses the purpose of using target species and criteria for selection of target species for both screening and intensive studies. Lists of recommended target species are provided for inland fresh waters, Great Lakes waters, and seven distinct estuarine and coastal marine regions of the United States.

Section 4 presents a list of recommended target analytes to be considered for inclusion in screening and intensive studies, briefly discusses the original criteria used in selecting these analytes, provides a summary of the toxicological information available for each analyte as well as pertinent information on the analyte's detection in national and regional fish monitoring studies.

Section 5 describes the new EPA risk-based procedure for calculating screening values for target analytes using (1) an adult body weight of 70 kg, (2) a lifetime exposure of 70 years, and (3) new consumption rate default values for both the general population and recreational fishers (17.5 g/d) and subsistence fishers (142.4 g/d). The last part of this section describes how to compare these new SVs against results obtained in fish tissue residue analysis.

Section 6 recommends field procedures to be followed from the time fish or shellfish samples are collected until they are delivered to the laboratory for processing and analysis. Guidance is provided on site selection and sample collection procedures; the guidance addresses material and equipment requirements, time of sampling, size of animals to be collected, sample type, and number of samples. Sample identification, handling, preservation, shipping, and storage procedures are also described.

Section 7 describes recommended laboratory procedures for sample handling including: sample measurements, sample processing procedures, and sample preservation and storage procedures.

Section 8 presents recommended laboratory procedures for sample analyses, including cost-effective analytical methods and associated QC procedures; and information on sources of certified reference materials; recommended analytical

techniques for target analytes, including revised detection and quantitation limits; information on the per-sample cost of chemical analysis for each target analyte; and information on federal agencies currently conducting interlaboratory comparison programs.

Section 9 includes procedures for data analysis to determine the need for additional monitoring and risk assessment and for data reporting.

Supporting documentation for this guidance is provided in Section 10, Literature Cited and in Appendixes A through N.

1.6 NEW INFORMATION AND REVISIONS TO VOLUME 1

This 3rd edition of Volume 1 contains newly prepared material as well as major updates and revisions to existing information. A brief summary of major additions and revisions is provided below.

Section 1

- New information is presented on the NLFWA database, including the 5-year trend in the total number of advisories issued nationwide, the number of advisories issued for five major pollutants of concern, and the issuance of increasing numbers of statewide advisories for freshwater lakes and/or rivers and coastal marine areas.
- Additional information describes the flexibility that is built into the EPA methodology, which allows the method to be used to meet a wide variety of state or tribal study needs within budgetary constraints.
- Clarification of the FDA methodology is provided emphasizing the inappropriateness of the method and reasons states should adopt and use the EPA methodology when issuing fish consumption advisories to protect their recreational and subsistence fishers.

Section 2

- Updated information is presented in Table 2-1 to be consistent with monitoring design and risk assumptions used in this 3rd edition.
- New discussion of the criteria states may use to identify green areas where chemical contaminant concentrations are at or below the screening values for recreational or subsistence fishers is introduced with more detailed information provided in Appendix B.

Section 3

- Several tables, including Tables 3-7 and 3-19, were updated to include new information from the 1998 NLFWA database on the number of states that have issued fish advisories for freshwater and marine species.
- Table 3-9 was updated and associated narrative text was revised to include information on studies using turtles as biomonitors of environmental contaminants.

Section 4

- Information on the environmental sources, toxicology, and the number of fish advisories issued in 1998 for each of the 25 target analytes was updated.
- New information is included on the range in concentrations of each contaminant detected in the FWS National Contaminant Biomonitoring Program and the EPA National Study of Chemical Residues in Fish as well as information on more recent regional studies.
- A procedure is described for the selection and prioritization of target analytes for analysis predicated on a watershed-based approach that takes into consideration land use categories, as well as geological characteristics, regional differences, national fish advisory trends, and monitoring and analysis costs.
- Additional guidance is presented on organophosphate pesticides and when and under what situations to monitor fish tissues for these compounds.
- A clarification is provided of the recommendation for selection of target species, especially bivalve molluscs and/or crustaceans when PAH contamination is suspected.
- A new discussion is provided to reflect the Agency's position on using Aroclor and congener analysis for calculating total PCB concentration.
- A new discussion is provided for determining the TEQ value for dioxins, which are now defined as including the 17 2,3,7,8 congeners of dioxin and 2,3,7,8 congeners of dibenzofuran, and the 12 coplanar PCBs with dioxin-like properties based on recent guidance from the World Health Organization (Van den Berg et al., 1998).
- Several tables, including Tables 4-1, 4-2, 4-7, and 4-9 were revised with new information. Tables 4-3, 4-4, 4-5, 4-6, and 4-8 are new to the document.
- All of the toxicological information was revised in light of the most current information concerning each target analyte.

Section 5

- Revisions were made describing major changes in the assumptions used in the risk assessment equations to calculate screening values including use of default consumption rates of 17.5 g/d for the general population and recreational fishers and 142.4 g/d for subsistence fishers based on more recent information from the 1994 to 1996 Continuing Survey of Food Intake by Individuals study conducted by the U.S. Department of Agriculture.
- Additional guidance is provided on how states should handle the interpretation and risk assessment of chemicals that have detection limits higher than the risk-based screening values.
- Tables 5-1, 5-3, 5-4, and 5-5 were revised to reflect changes in consumption rates. Screening values shown in Tables 5-3 and 5-4 were developed using the new consumption rates as well as the most recent RfD and cancer slope factors available.
- Additional information is provided on Native American subsistence fishers, and Table 5-2 was added to summarize several recent studies on Native American fish consumption rates.
- Additional guidance is provided on how states should deal with interpreting analytical results in cases where the screening value is lower than the detection limit for a particular analyte.
- New guidance is provided on determining total PCBs by summary Aroclor equivalents or PCB congeners.
- New information from the World Health Organization (Van den Berg et al., 1998) is included in Table 5-6 showing the most recent Toxic Equivalency Factors (TEF) for the 2,3,7,8-substituted dioxins, dibenzofurans, and the 12 coplanar PCBs.

Section 6

- Additional information is provided on the statistical implications associated with deviations from the recommended sampling design, including the use of unequal numbers of fish per composite, sizes of fish exceeding the size range recommendations for composites, and the use of unequal numbers of replicate samples across sampling sites.
- Clarification is provided on the recommended number of fish that should make up a composite sample.

- More explicit information is provided regarding exceedances of screening values and the statistical basis for issuing a new advisory or rescinding an existing advisory.
- Discussion is provided on the number of samples necessary to characterize different waterbody types and sizes of waterbodies with consideration given to the home range and mobility of the target species.
- How regional data should be used in the risk assessment process to address statewide advisories is discussed.
- Additional guidance is provided on how sample type selection should be based on the study objectives as well as on the sample type consumed by the target population.
- Clarification is provided as to EPA's position on the use of dead, lacerated, or mutilated fish for human health risk assessments.
- New information is provided on U.S. Fish and Wildlife Service and National Marine Fisheries permit requirements in situations where concerns exist about the impact of sampling for the target species in areas inhabited by threatened or endangered species.
- Revisions were made in recordkeeping for field sampling associated with use of the Year 2000 compliant format (YYYYMMDD) for sampling date information.

Section 7

- Revisions were made in recordkeeping forms to initiate use of the Year 2000 compliant format for the date of sampling and analysis procedures.

Section 8

- Updated information is included in Tables 8-1 through 8-5.
- Updated information is provided on the EPA Environmental Monitoring Methods Index System (EMMI).
- Revised information is provided in Section 8.3.3.8.1 concerning round-robin analysis interlaboratory comparison programs.

Section 9

- New information is included on the National Tissue Residue Data Repository, now housed within the NLFWA database.

- Recommended data reporting requirements were updated (Figure 9-1) to include Year 2000 compliant format.
- Detailed information is provided on the Internet-based data entry facility contained within the NLFWA database that can accept fish contaminant residue data to support state fish advisories.
- An example of the new data tables (Figure 9-2) currently used in the fish tissue residue data repository is provided.

Section 10

- Literature citations were revised to include all new references cited in Sections 1 through 9.

Appendixes:

- The following appendixes were revised or added:
 - A - EPA 1993 Fish Contamination Workgroup Members
 - B - Screening Values for Defining Green Areas
 - D - Fish and Shellfish Species for Which State Consumption Advisories Have Been Issued
 - F - Pesticide and Herbicides Recommended as Target Analytes
 - G - Target Analyte Dose-Response Variables and Associated Information
 - I - Quality Assurance and Quality Control Guidance
 - M - Sources of Reference Materials

SECTION 2

MONITORING STRATEGY

The objective of this section is to describe the strategy recommended by the EPA Office of Water for use by states in their fish and shellfish contaminant monitoring programs. A two-tiered strategy is recommended as the most cost-effective approach for State contaminant monitoring programs to obtain data necessary to evaluate the need to issue fish or shellfish consumption advisories. This monitoring strategy is shown schematically in Figure 2-1 and consists of

- **Tier 1—Screening studies** of a large number of sites for chemical contamination where sport, subsistence, and/or commercial fishing is conducted. This screening will help states identify those sites where concentrations of chemical contaminants in edible portions of commonly consumed fish and shellfish indicate the potential for significant health risks to human consumers.
- **Tier 2—Two-phase intensive studies** of problem areas identified in screening studies to determine the magnitude of contamination in edible portions of commonly consumed fish and shellfish species (**Phase I**), to determine size-specific levels of contamination, and to assess the geographic extent of the contamination (**Phase II**).

One key objective in the recommendation of this approach is to improve the data used by states for issuing fish and shellfish consumption advisories. Other specific aims of the recommended strategy are

- To ensure that resources for fish contaminant monitoring programs are allocated in the most cost-effective way. By limiting the number of sites targeted for intensive studies, as well as the number of target analytes at each intensive sampling site, screening studies help to reduce overall program costs while still allowing public health protection objectives to be met.
- To ensure that sampling data are appropriate for developing risk-based consumption advisories.
- To ensure that sampling data are appropriate for determining contaminant concentrations in various size (age) classes of each target species so that states can give size-specific advice on contaminant concentrations (as appropriate).

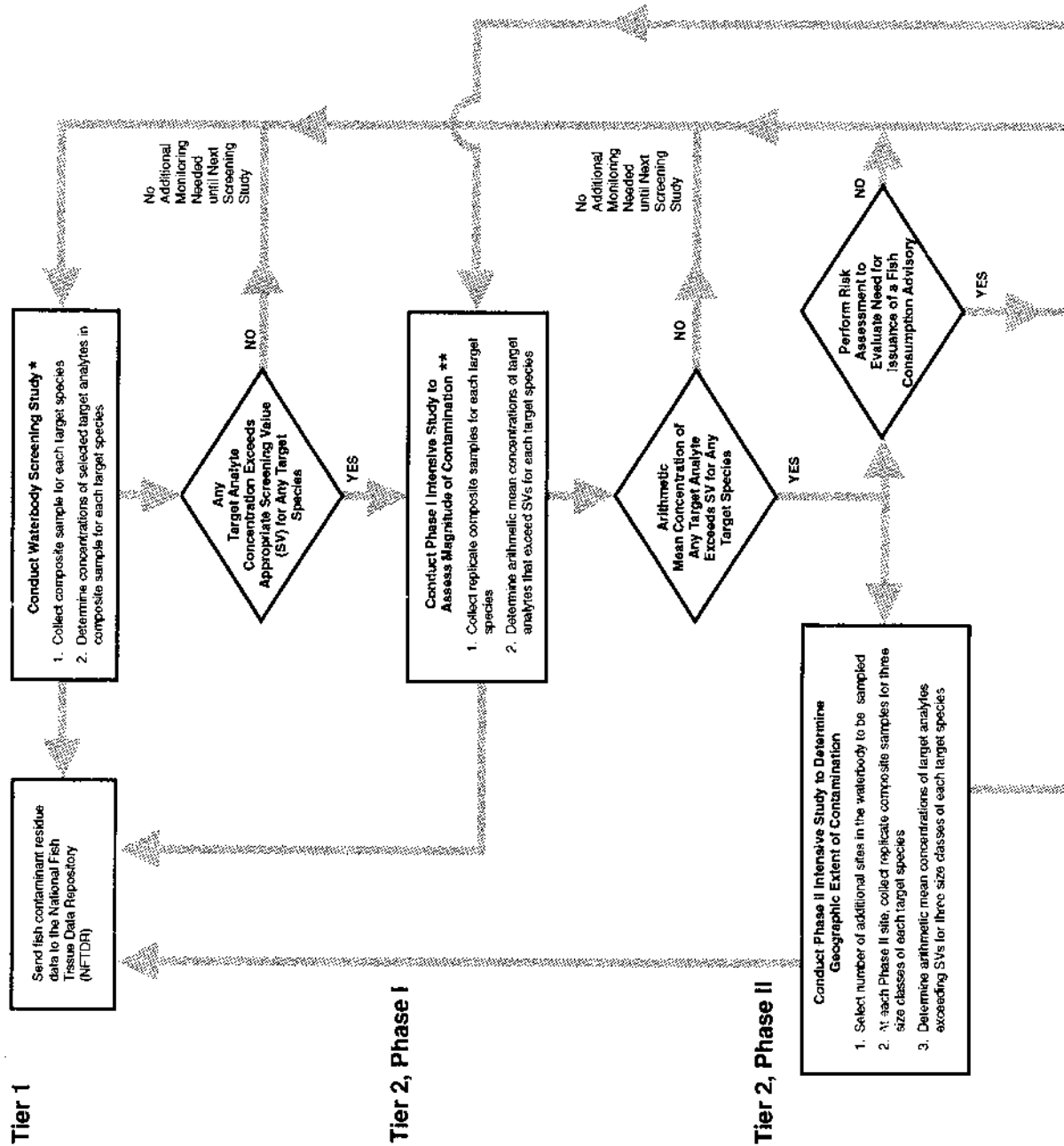

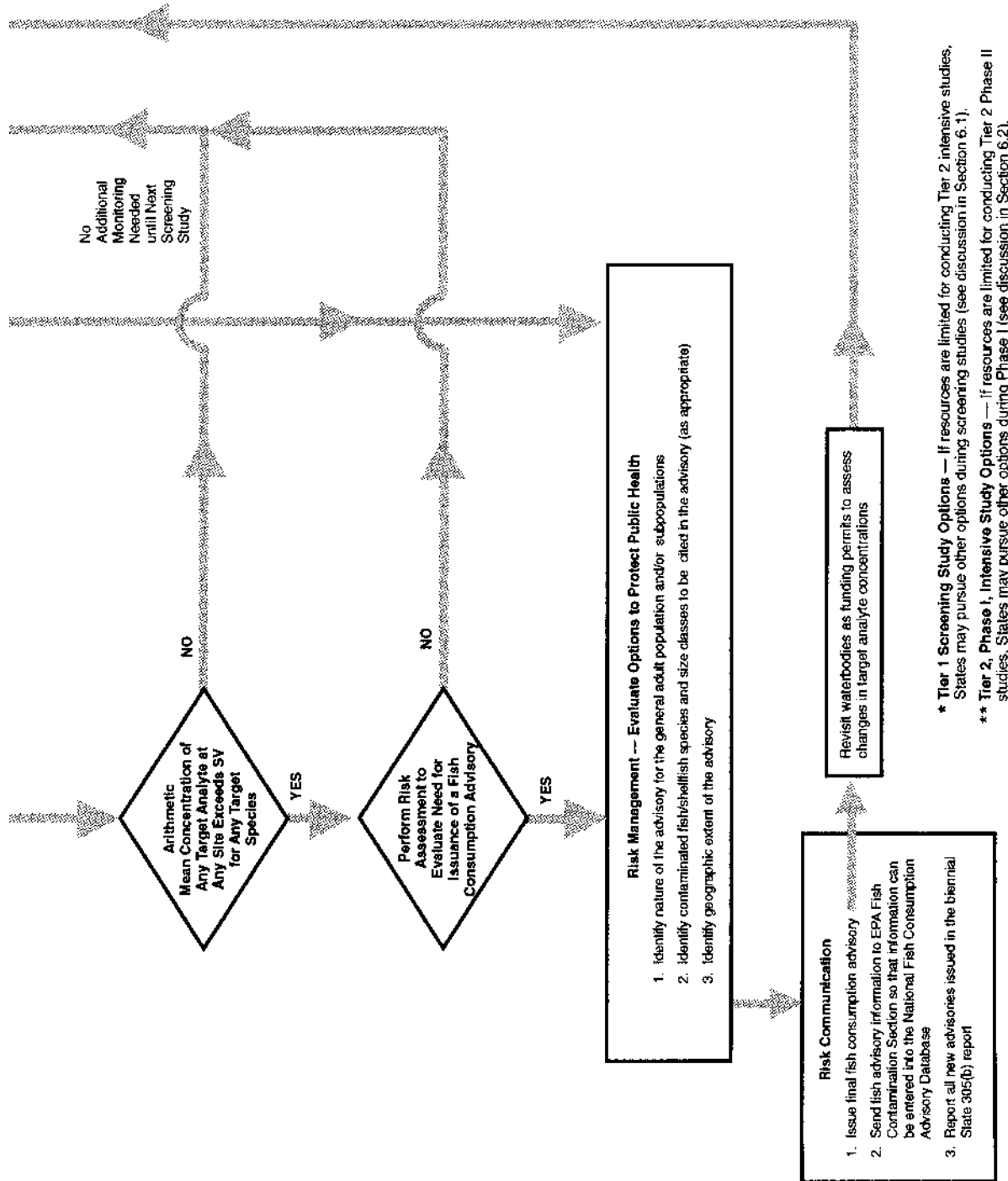

Figure 2-1. Recommended strategy for state fish and shellfish contaminant monitoring programs.

- To ensure that sampling designs are appropriate to allow statistical hypothesis testing. Such sampling designs permit the use of statistical tests to detect a difference between the average tissue contaminant concentration at a site and the human health screening value for any analyte.

The following elements must be considered when planning either screening studies or more intensive followup sampling studies:

- Study objective
- Target species (and size classes)
- Target analytes
- Target analyte screening values
- Sampling locations
- Sampling times
- Sample type
- Sample replicates
- Sample analysis
- Data analysis and reporting.

Detailed guidance for each of these elements, for screening studies (**Tier 1**) and for both Phase I and Phase II of intensive studies (**Tier 2**), is provided in this document. The key elements of the monitoring strategy are summarized in Table 2-1, with reference to the section number of this document where each element is discussed.

2.1 SCREENING STUDIES (TIER 1)

The primary aim of screening studies is to identify frequently fished sites where concentrations of chemical contaminants in edible fish and shellfish composite samples exceed specified human health screening values and thus require more intensive followup sampling. Ideally, screening studies should include all waterbodies where commercial, recreational, or subsistence fishing is practiced; specific sampling sites should include areas where various types of fishing are conducted routinely (e.g., from a pier, from shore, or from private and commercial boats), thereby exposing a significant number of individuals to potentially adverse health effects. Composites of skin-on fillets (except for catfish and other scaleless species, which are usually prepared as skin-off fillets) and edible portions of shellfish are recommended for contaminant analyses in screening studies to provide conservative estimates of typical exposures for the general population. If consumers remove the skin and fatty areas from a fish before preparing it for eating, exposures to some contaminants can be reduced (see U.S. EPA, 2000a, Appendix C of Volume 2 of this guidance document series).

Note: If the target population of consumers includes primarily ethnic or subsistence fishers who consume the whole fish or tissues of the fish not typically consumed by the general population, state monitoring programs should include the fish sample type associated with the target consumers' dietary and/or culinary preference (see Section 6.1.1.6, Sample Type, for additional information.)

Table 2-1. Recommended Strategy for State Fish and Shellfish Contaminant Monitoring Programs

Program element	Tier 1 Screening study	Tier 2 Intensive study (Phase I)	Tier 2 Intensive study (Phase II)
	Objective (see Section 2)	Identify frequently fished sites where commonly consumed fish and shellfish target species are contaminated and may pose potential human health risk.	Assess and verify magnitude of tissue contamination at screening site for commonly consumed target species.
Target species and size classes (see Sections 3 and 6)	Select target species from commonly consumed species using the following additional criteria: known to bioaccumulate high concentrations of contaminants and distributed over a wide geographic area.	Resample target species at sites where they were found to be contaminated in screening study.	Resample at additional sites in the waterbody 3 size classes of the target species found to be contaminated in Phase I study.
	Recommended types of target species: Inland fresh waters: 1 bottom-feeder 1 predator Great Lakes: 1 bottom-feeder 1 predator Estuarine/marine: 1 shellfish and 1 fish species 2 fish species (one species should be bottom-feeder). or 2 fish species (one species should be bottom-feeder).		
	OPTIONAL: If resources are limited and a state cannot conduct Tier 2 intensive studies, the state may find it more cost-effective to collect additional samples during the Tier 1 screening study. States may collect (1) one composite sample of each of three size classes for each target species, (2) replicate composite samples for each target species, or (3) replicate composite samples of each of three size classes for each target species.	OPTIONAL: If resources are limited and a state cannot conduct Tier 2, Phase II, intensive studies, the state may find it more cost-effective to collect additional samples during the Tier 2, Phase I, intensive study. States may collect replicate composite samples of three size classes of the target species found to be contaminated to assess size-specific contaminant concentrations. Other commonly consumed target species may also be sampled if resources allow.	OPTIONAL: If resources allow, select additional commonly consumed target species using same criteria as in Phase I study.

See notes at end of table.

(continued)

Table 2-1. (continued)

Program element	Tier 1 Screening study	Tier 2 Intensive study (Phase I)	Tier 2 Intensive study (Phase II)
<p><u>Target analytes</u> (see Section 4)</p>	<p>Consider all target analytes listed in Table 4-1 for analysis but prioritize the 25 target analytes based on water and sediment sampling results, land use within the watershed, geographic characteristics, regional and national advisory trends and analytical costs. Include additional site-specific target analytes as appropriate based on current or historic data.</p>	<p>Analyze only for those target analytes from Tier 1 screening study that exceeded SVs.</p>	<p>Analyze only for those target analytes from Tier 2, Phase I, study that exceeded SVs.</p>
<p><u>Screening values</u> (see Section 5)</p>	<p>Calculate SVs using oral RfDs for noncarcinogens and using oral slope factors and an appropriate risk level (10^{-4} to 10^{-7}) for carcinogens, for adults consuming 17.5 g/d and 142.4 g/d of fish and shellfish (default values) or based on site-specific dietary data.</p>	<p>Use same SVs as in screening study.</p>	<p>Use same SVs as in screening study.</p>
<p><u>Sampling sites</u> (see Section 6)</p>	<p>Note: In this guidance document, EPA's Office of Water used 17.5 g/d (for recreational fishers) and 142.4 g/d (for subsistence fishers) consumption rates, 70-kg adult body weight, and, for carcinogens, used a 10^{-5} risk level, 70-year exposure, and assumed no loss of contaminants during preparation or cooking. States may use other SVs for site-specific exposure scenarios by adjusting values for consumption rate, body weight, risk level, exposure period, and contaminant loss during preparation or cooking.</p> <p>Sample target species at sites in each harvest area that have a high probability of contamination and at presumed clean sites or given areas as resources allow (see Appendix A).</p>	<p>Sample target species at each site identified in the screening study where fish/shellfish tissue concentrations exceed SVs to assess the magnitude of contamination.</p>	<p>Sample at additional sites in the harvest area 3 size classes of the target species found to be contaminated in Phase I study to assess the geographic extent of the contamination in the waterbody.</p>

See notes at end of table.

(continued)

Table 2-1. (continued)

Program element	Tier 1 Screening study	Tier 2 Intensive study (Phase I)	Tier 2 Intensive study (Phase II)
<u>Sampling times</u> (see Section 6)	Sample during legal harvest season when target species are most available to consumers. Ideally, sampling time should not include the spawning period for target species unless the target species can be legally harvested during this period.	Same as screening study.	Same as screening study.
<u>Sample type</u> (see Sections 6 and 7)	Collect composite fillet samples (skin on, belly flap included) for each target fish species and composite samples of edible portions of target shellfish species. The exceptions to the "skin on, belly flap included" recommendation is to use skin-off fillets for catfish and other scaleless species. OPTIONAL: States may use individual fish samples, whole fish, or other sample types, if necessary, to improve exposure estimates of local fish-, shellfish-, or turtle-consuming populations. Sample type should reflect dietary and fish preparation methods of the target population of concern.	Same as screening study.	Same as screening study but collect composite samples for three size classes of each target species as appropriate.
<u>Sample replicates</u> (see Section 6)	Collect one composite sample for each target species. Collection of replicate composite samples is encouraged but is optional. If resources allow, collect a minimum of one replicate composite sample for each target species at 10% of the screening sites for QC.	Same as screening study.	Same as screening study.
<u>Sample analysis</u> (see Section 8)	Use standardized and quantitative analytical methods with limits of detection adequate to allow reliable quantitation of selected target analytes at or below SVs.	Use same analytical methods as in screening study.	Use same analytical methods as in screening study.

See notes at end of table.

(continued)

Table 2-1. (continued)

Program element	Tier 1 Screening study	Tier 2 Intensive study (Phase I)	Tier 2 Intensive study (Phase II)
Data analysis and reporting (see Sections 6, 7, 8, and 9)	For each target species, compare target analyte concentrations of composite sample with SVs to determine which sites require Tier 2, Phase I, intensive study.	For each target species, compare target analyte arithmetic mean concentrations of replicate composite samples with SVs to determine which sites require Phase II intensive study. If resources are insufficient to conduct Phase II intensive study, conduct a risk assessment and assess the need for issuing a preliminary fish or shellfish consumption advisory.	For each of three size classes within each target species, compare target analyte arithmetic mean concentrations of replicate composite samples at each Phase II site with SVs to determine geographic extent of fish or shellfish contamination. Assess the need for issuing a final fish or shellfish consumption advisory.
Data analysis and reporting (see Sections 6, 7, 8, and 9) (continued)	The following information should be reported for each target species at each site: <ul style="list-style-type: none"> • Site location (e.g., sample site name, water-body name, type of waterbody, and latitude/longitude) • Scientific and common name of target species • Sampling date and time • Sampling gear type used • Sampling depth • Number of QC replicates (optional) • Number of individual organisms used in the composite sample and in the QC replicate composite sample if applicable 	The following information should be reported for each target species at each site: <ul style="list-style-type: none"> • Same as screening study. • Same as screening study • Same as screening study • Same as screening study • Sampling depth • Number of replicates • Number of individual organisms used in each replicate composite sample 	The following information should be reported for each of three size classes within each target species at each site: <ul style="list-style-type: none"> • Same as screening study. • Same as screening study • Same as screening study • Same as screening study • Sampling depth • Same as Phase I study • Same as Phase I study

See notes at end of table.

(continued)

Table 2-1. (continued)

Program element	Tier 1 Screening study	Tier 2 Intensive study (Phase I)	Tier 2 Intensive study (Phase II)
	<ul style="list-style-type: none"> Predominant characteristics of specimens used in the composite sample and in the QC replicate if applicable (e.g., life stage, age, sex, total length or body size) and description of fish fillet or edible parts of shellfish (tissue type) used Analytical methods used (including a method for lipid analysis) and method detection and quantitation limits for each target analyte. 	<ul style="list-style-type: none"> Predominant characteristics of specimens used in each replicate composite sample (e.g., life stage, age, sex, total length or body size) and description of fish fillet or edible parts of shellfish (tissue type) used Same as screening study 	<ul style="list-style-type: none"> Same as Phase I study Same as screening study
<u>Data analysis and reporting</u> (see Sections 6, 7, 8, and 9) (continued)	<ul style="list-style-type: none"> Sample cleanup procedures Data qualifiers Percent lipid in each composite sample. For each target analyte: <ul style="list-style-type: none"> Total wet weight of composite sample (g) used in analysis Measured concentration (wet weight) in composite sample including units of measurement for target analyte Measured concentration (wet weight) in the QC replicate, if applicable 	<ul style="list-style-type: none"> Same as screening study. Same as screening study. Same as screening study. For each target analyte: <ul style="list-style-type: none"> Total wet weight of each replicate composite sample (g) used in analysis Measured concentration (wet weight) in each replicate composite sample and units of measurement for target analyte Range of concentrations (wet weight) for each set of replicate composite samples Mean (arithmetic) concentration (wet weight) for each set of replicate composite samples Standard deviation of mean concentration (wet weight) 	<ul style="list-style-type: none"> Same as screening study. Same as screening study. Same as screening study. For each target analyte: <ul style="list-style-type: none"> Same as Phase I study Same as Phase I study Same as Phase I study Same as Phase I study Same as Phase I study

See notes at end of table.

(continued)

Table 2-1. (continued)

Program element	Tier 1 Screening study	Tier 2 Intensive study (Phase I)	Tier 2 Intensive study (Phase II)
-	Evaluation of laboratory performance (i.e., description of all QA and QC samples associated with the sample(s) and results of all QA and QC analyses)	- Same as screening study	- Same as screening study
-	Comparison of measured concentration of composite sample with SV and clear indication of whether SV was exceeded	- Comparison of target analyte arithmetic mean concentration of replicate composite samples with SV using hypothesis testing and clear indication of whether the SV was exceeded	- Same as Phase I study

QA = Quality assurance.
 QC = Quality control.

RfDs = Reference doses.
 SVs = Screening values.

Because the sampling sites in screening studies are focused primarily on the most likely problem areas and the numbers of commonly consumed target species and samples collected are limited, relatively little detailed information is obtained on the magnitude and geographic extent of contamination in a wide variety of harvestable fish and shellfish species of concern to consumers. More information is obtained through additional intensive followup studies (**Tier 2, Phases I and II**) conducted at potentially contaminated sites identified in screening studies.

Although the EPA Office of Water recommends that screening study results not be used as the sole basis for conducting a risk assessment, EPA recognizes that this practice may be unavoidable if monitoring resources are limited or if the state must issue an advisory based on detection of elevated concentrations in one composite sample. States have several options for collecting samples during the **Tier 1** screening study (see Figure 2-1), which can provide additional information on contamination without necessitating additional field monitoring expenditures as part of the **Tier 2** intensive studies.

The following assumptions are made in this guidance document for sampling fish and shellfish and for calculating human health SVs for recreational and subsistence fishers:

- Use of commonly consumed target species that are dominant in the catch and have high bioaccumulation potential (see Section 3, Target Species)
- Use of fish fillets (with skin on and belly flap tissue included) for scaled finfish species, use of skinless fillets for scaleless finfish species, and use of edible portions of shellfish (see Section 6.1.1.6, Sample Type)
- Use of fish and shellfish above legal size to maximum size in the target species
- Use of a 10^{-5} risk level, a human body weight of 70 kg (average adult), a consumption rate of 17.5 g/d for recreational fishers and 142.4 g/d for subsistence fishers, and a 70-yr lifetime exposure period to calculate SVs for carcinogens.
- Use of a human body weight of 70 kg (average adult) and a consumption rate of 17.5 g/d for recreational fishers and 142.4 g/d for subsistence fishers to calculate SVs for noncarcinogens (see Section 5, Screening Values for Target Analytes).
- Use of no contaminant loss during preparation and cooking or from incomplete absorption in the intestines.

For certain site-specific situations, states may wish to use one or more of the following exposure assumptions to protect the health of high-end fish consumers such as subsistence fishers at potentially greater risk:

- Use of commonly consumed target species that are dominant in the catch and have the highest bioaccumulation potential
- Use of whole fish or whole body of shellfish (excluding shell of bivalves), which may provide a better estimate of contaminant exposures in ethnic or Native American subsistence populations that consume whole fish or shellfish
- Use of the largest (oldest) individuals in the target species to represent the highest likely exposure levels
- Use of a 10^{-6} or 10^{-7} risk level, body weights less than 70 kg for women and children, site-specific consumption rates for sport fishers or for subsistence fishers or other consumption rates based on dietary studies of local fish-consuming populations, and a 70-yr exposure period to calculate SVs for carcinogens. **Note:** EPA has reviewed national data on the consumption rate for sport and subsistence fishers and the recommended default values for these populations are 17.5 and 142.4 g/d, respectively (USDA/ARS, 1998; U.S. EPA, 2000c).
- Use of body weights less than 70 kg for women and children and site-specific consumption rates for sport fishers or for subsistence fishers or other consumption rates based on dietary studies of local fish-consuming populations to calculate SVs for noncarcinogens. **Note:** EPA has reviewed national data on the consumption rate for sport and subsistence fishers and the recommended default values for these populations are 17.5 and 142.4 g/d, respectively (USDA/ARS, 1998; U.S. EPA, 2000c).

There are additional aspects of the screening study design that states should review because they affect the statistical analysis and interpretation of the data. These include

- Use of composite samples, which results in loss of information on the distribution of contaminant concentrations in the individual sampled fish and shellfish. Maximum contaminant concentrations in individual sampled fish, which can be used as an indicator of potentially harmful levels of contamination (U.S. EPA, 1989d), are not available when composite sampling is used.
- Use of a single sample per screening site for each target species, which precludes estimating the variability of the contamination level at that site and, consequently, of conducting valid statistical comparisons to the target analyte SVs.
- Uncertainty factors affecting the numerical calculation of quantitative health risk information (i.e., reference doses and cancer slope factors) as well as human health SVs.

The use of composite samples is often the most cost-effective method for estimating average tissue concentrations of analytes in target species populations to assess chronic human health risks. However, there are some situations in which individual sampling can be more appropriate from both ecological and risk assessment perspectives. Individual sampling provides a direct measure of the range and variability of contaminant levels in target fish populations. Information on maximum contaminant concentrations in individual fish is useful in evaluating acute human health risks. Estimates of the variability of contaminant levels among individual fish can be used to ensure that studies meet desired statistical objectives. For example, the population variance of a contaminant can be used to estimate the sample size needed to detect statistically significant differences in contaminant screening values compared to the mean contaminant concentration. Finally, the analysis of individual samples may be desirable, or necessary, when the objective is to minimize the impacts of sampling on certain vulnerable target populations, such as predators in headwater streams and aquatic turtles, and in cases where the cost of collecting enough individuals for a composite sample is excessive. For states that wish to consider use of individual sampling during either the screening or intensive studies, additional information on collecting and analyzing individual samples is provided in Appendix C. States should consider the potential effects of these study design features when evaluating screening study results.

Note: As part of screening studies, states may wish to issue information not only on restricting or avoiding consumption of certain species from certain waterbodies, but on promoting unrestricted fish consumption in those waterbodies where the levels of contamination are below the SVs for all 25 of the target analytes. Waterbodies in which target analyte concentrations (see Section 5) are below the selected target analyte SVs are known as “green areas” where states can promote fish consumption to specified fisher populations. Guidance to assist states in designating these safe or green areas is provided in detail in Appendix B.

2.2 INTENSIVE STUDIES (TIER 2)

The primary aims of intensive studies are to assess the magnitude of tissue contamination at screening sites, to determine the size class or classes of fish within a target species whose contaminant concentrations exceed the SVs, and to assess the geographic extent of the contamination for the target species in the waterbody under investigation. With respect to the design of intensive studies, EPA recommends a sampling strategy that may not be feasible for some site-specific environments. Specifically, EPA recognizes that some waterbodies cannot sustain the same intensity of sampling (i.e., number of replicate composite samples per site and number of individuals per composite sample) that others (i.e., those used for commercial harvesting) can sustain. In such cases, state fisheries personnel may consider modifying the sampling strategy (e.g., analyzing individual fish) for intensive studies to protect the fishery resource. Although one strategy cannot cover all situations, these sampling guidelines are reasonable for the majority of environmental conditions, are scientifically defensible, and provide

information that can be used to assess the risk to public health. Regardless of the final study design and protocol chosen for a fish contaminant monitoring program, state fisheries, environmental, and health personnel should always evaluate and document the procedures used to ensure that results obtained meet state objectives for protecting human health.

The allocation of limited funds to screening studies or to intensive studies should always be guided by the goal of conducting adequate sampling of state fish and shellfish resources to ensure the protection of public health. The amount of sampling that can be performed by a state will be determined by available economic resources. Ideally, state agencies will allocate funds for screening as many sites as is deemed necessary while reserving adequate resources to conduct subsequent intensive studies at sites where excessive fish tissue contamination is detected. State environmental and health personnel should use all information collected in both screening and intensive studies to (1) conduct a risk assessment to determine whether the issuance of an advisory is warranted, (2) use risk management to determine the nature and extent of the advisory, and then (3) effectively communicate this risk to the fish-consuming public. Additional information on risk assessment, risk management, and risk communication procedures will be provided in subsequent volumes in this series.

SECTION 3

TARGET SPECIES

The primary objectives of this section are to: (1) discuss the purpose of using target species, (2) describe the criteria used by the 1993 EPA Fish Contaminant Workgroup to select target species, and (3) provide lists of recommended target species. Target species recommended for freshwater and estuarine/marine ecosystems are discussed in Sections 3.3 and 3.4, respectively.

3.1 PURPOSE OF USING TARGET SPECIES

The use of target species allows comparison of fish, shellfish, and turtle tissue contaminant monitoring data among sites over a wide geographic area. Differences in habitat, food preferences, and rate of contaminant uptake among various fish, shellfish, and turtle species make comparison of contaminant monitoring results within a state or among states difficult unless the contaminant data are from the same species. It is virtually impossible to sample the same species at every site, within a state or region or nationally, due to the varying geographic distributions and environmental requirements of each species. However, a limited number of species can be identified that are distributed widely enough to allow for collection and comparison of contaminant data from many sites.

Three aims are achieved by using target species in screening studies. First, states can cost-effectively compare contaminant concentrations in their state waters and then prioritize sites where tissue contaminants exceed human health screening values. In this way, limited monitoring resources can be used to conduct intensive studies at sites exhibiting the highest degree of tissue contamination in screening studies. By resampling target species used in the screening study in Phase I intensive studies and sampling additional size classes and additional target species in Phase II intensive studies as resources allow, states can assess the magnitude and geographic extent of contamination in species of commercial, recreational, or subsistence value. Second, the use of common target species among states allows for more reliable comparison of sampling information. Such information allows states to design and evaluate their own contaminant monitoring programs more efficiently, which should further minimize overall monitoring costs. For example, monitoring by one state of fish tissue contamination levels in the upper reaches of a particular river can provide useful information to an adjacent state on tissue contamination levels that might be anticipated in the same target species at sampling sites downstream. Third, the use of a select group of target fish, shellfish, and freshwater turtle species will allow for the development of a national database for tracking the magnitude and

geographic extent of pollutant contamination in these target species nationwide and will permit analyses of trends in fish, shellfish, and turtle contamination over time.

3.2 CRITERIA FOR SELECTING TARGET SPECIES

The appropriate choice of target species is a key element of any chemical contaminant monitoring program. Criteria for selecting target species used in the following national fish and shellfish contaminant monitoring programs were reviewed by the 1993 EPA Fish Contaminant Workgroup to assess their applicability for use in selecting target species for state fish contaminant monitoring programs:

- National Study of Chemical Residues in Fish (U.S. EPA)
- National Dioxin Study (U.S. EPA)
- 301(h) Monitoring Program (U.S. EPA)
- National Pesticide Monitoring Program (U.S. FWS)
- National Contaminant Biomonitoring Program (U.S. FWS)
- National Status and Trends Program (NOAA).
- National Water Quality Assessment Program (USGS).

The criteria used to select target species in many of these programs are similar although the priority given each criterion may vary depending on program aims.

According to the 1993 EPA Fish Contaminant Workgroup, the most important criterion for selecting target fish, shellfish, and turtle species for state contaminant monitoring programs assessing human consumption concerns was that the species were commonly consumed in the study area and were of commercial, recreational, or subsistence fishing value. Two other criteria of major importance are that the species have the potential to bioaccumulate high concentrations of chemical contaminants and have a wide geographic distribution. EPA recommends that states use the same criteria to select species for both screening and intensive site-specific studies.

In addition to the three primary criteria for target species selection, it is also important that the target species be easy to identify taxonomically because there are significant species-specific differences in bioaccumulation potential. Because many closely related species can be similar in appearance, reliable taxonomic identification is essential to prevent mixing of closely related species with the target species. **Note:** Under no circumstance should individuals of more than one species be mixed to create a composite sample (U.S. EPA, 1991e). It is also both practical and cost-effective to sample target species that are abundant, easy to capture, and large enough to provide adequate tissue samples for chemical analyses.

It cannot be overemphasized that final selection of target species will require the expertise of state fisheries biologists with knowledge of local species that best meet the selection criteria and knowledge of local human consumption patterns. Although, ideally, all fish, shellfish, or turtle species consumed from a given waterbody by the local population should be monitored, resource constraints may dictate that only a few of the most frequently consumed species be sampled.

In the next two sections, lists of recommended target species are provided for freshwater ecosystems (inland fresh waters and the Great Lakes) and estuarine/marine ecosystems (Atlantic, Gulf, and Pacific waters), and the methods used to develop each list are discussed.

3.3 FRESHWATER TARGET SPECIES

As part of the two-tiered sampling strategy proposed for state fish contaminant monitoring programs, EPA recommends that states collect one bottom-feeding fish species and one predator fish species at each freshwater screening study site. Some suggested target species for use in state fish contaminant monitoring programs are shown in Table 3-1 for inland fresh waters and in Table 3-2 for Great Lakes waters.

The lists of target species recommended by the 1993 EPA Fish Contaminant Workgroup for freshwater ecosystems were developed based on a review of species used in the following national monitoring programs:

- National Study of Chemical Residues in Fish (U.S. EPA)
- National Dioxin Study (U.S. EPA)
- National Pesticide Monitoring Program (U.S. FWS)
- National Contaminant Biomonitoring Program (U.S. FWS)
- National Water Quality Assessment Program (USGS)

and on a review of fish species cited in state fish consumption advisories or bans (RTI, 1993). Separate target species lists were developed for inland fresh waters (Table 3-1) and Great Lakes waters (Table 3-2) because of the distinct ecological characteristics of these waters and their fisheries. Each target species list has been reviewed by regional and state fisheries experts.

Use of two distinct ecological groups of finfish (i.e., bottom-feeders and predators) as target species in freshwater systems is recommended. This permits monitoring of a wide variety of habitats, feeding strategies, and physiological factors that might result in differences in bioaccumulation of contaminants. Bottom-feeding species may accumulate high contaminant concentrations from direct physical contact with contaminated sediment and/or by consuming benthic invertebrates and epibenthic organisms that live in contaminated sediment. Predator species are also good indicators of persistent pollutants (e.g., mercury or DDT and its metabolites) that may be biomagnified through several trophic levels of the food web. Species used in several federal programs to assess the

Table 3-1. Recommended Target Species for Inland Fresh Waters

Family name	Common name	Scientific name
<i>Percichthyidae</i>	White bass	<i>Morone chrysops</i>
<i>Centrarchidae</i>	Largemouth bass	<i>Micropterus salmoides</i>
	Smallmouth bass	<i>Micropterus dolomieu</i>
	Black crappie	<i>Pomoxis nigromaculatus</i>
	White crappie	<i>Pomoxis annularis</i>
<i>Percidae</i>	Walleye	<i>Stizostedion vitreum</i>
	Yellow perch	<i>Perca flavescens</i>
<i>Cyprinidae</i>	Common carp	<i>Cyprinus carpio</i>
<i>Catostomidae</i>	White sucker	<i>Catostomus commersoni</i>
<i>Ictaluridae</i>	Channel catfish	<i>Ictalurus punctatus</i>
	Flathead catfish	<i>Pylodictis olivaris</i>
<i>Esocidae</i>	Northern pike	<i>Esox lucius</i>
<i>Salmonidae</i>	Lake trout	<i>Salvelinus namaycush</i>
	Brown trout	<i>Salmo trutta</i>
	Rainbow trout	<i>Oncorhynchus mykiss^a</i>

^aFormerly *Salmo gairdneri*.

Table 3-2. Recommended Target Species for Great Lakes Waters

Family name	Common name	Scientific name
<i>Percichthyidae</i>	White bass	<i>Morone chrysops</i>
<i>Centrarchidae</i>	Smallmouth bass	<i>Micropterus dolomieu</i>
<i>Percidae</i>	Walleye	<i>Stizostedion vitreum</i>
<i>Cyprinidae</i>	Common carp	<i>Cyprinus carpio</i>
<i>Catostomidae</i>	White sucker	<i>Catostomus commersoni</i>
<i>Ictaluridae</i>	Channel catfish	<i>Ictalurus punctatus</i>
<i>Esocidae</i>	Muskellunge	<i>Esox masquinongy</i>
<i>Salmonidae</i>	Chinook salmon	<i>Oncorhynchus tshawytscha</i>
	Lake trout	<i>Salvelinus namaycush</i>
	Brown trout	<i>Salmo trutta</i>
	Rainbow trout	<i>Oncorhynchus mykiss^a</i>

^aFormerly *Salmo gairdneri*.

extent of freshwater fish tissue contamination nationwide are compared in Table 3-3.

In addition to finfish species, states should consider monitoring the tissues of freshwater turtles for environmental contaminants in areas where turtles are consumed by recreational, subsistence, or ethnic populations. Interest has been increasing in the potential transfer of environmental contaminants from the aquatic food chain to humans via consumption of freshwater turtles. Turtles may bioaccumulate environmental contaminants in their tissues from exposure to contaminated sediments or via consumption of contaminated prey. Because some turtle species are long-lived and occupy a medium to high trophic level of the food chain, they have the potential to accumulate high concentrations of chemical contaminants from their diets (Hebert et al., 1993). Some suggested target turtle species for use in state contaminant monitoring programs are listed in Table 3-4.

The list of target turtle species recommended for freshwater ecosystems was developed based on a review of turtle species cited in state consumption advisories or bans (RTI, 1993) and a review of the recent scientific literature. The recommended target species list has been reviewed by regional and state experts.

3.3.1 Target Finfish Species

3.3.1.1 Bottom-Feeding Species

EPA recommends that, whenever practical, states use common carp (*Cyprinus carpio*), channel catfish (*Ictalurus punctatus*), and white sucker (*Catostomus commersoni*) in that order as bottom-feeding target species in both inland fresh waters (Table 3-1) and in Great Lakes waters (Table 3-2). These bottom-feeders have been used consistently for monitoring a wide variety of contaminants including dioxins/furans (Crawford and Luoma, 1993; U.S. EPA, 1992c, 1992d; Versar Inc., 1984), organochlorine pesticides (Crawford and Luoma, 1993; Schmitt et al., 1983, 1985, 1990; U.S. EPA, 1992c, 1992d), and heavy metals (Crawford and Luoma, 1993; Lowe et al., 1985; May and McKinney, 1981; Schmitt and Brumbaugh, 1990; U.S. EPA, 1992c, 1992d). These three species are commonly consumed in the areas in which they occur and have also demonstrated an ability to accumulate high concentrations of environmental contaminants in their tissues as shown in Tables 3-5 and 3-6. **Note:** The average contaminant concentrations shown in Tables 3-5 and 3-6 for fish collected for the EPA National Study of Chemical Residues in Fish (U.S. EPA, 1992c, 1992d) were derived from concentrations in fish from undisturbed areas and from areas expected to have elevated tissue contaminant concentrations. The mean contaminant concentrations shown, therefore, may be higher or lower than those found in the ambient environment because of site selection criteria used in this study.

Table 3-3. Comparison of Freshwater Finfish Species Used in Several National Fish Contaminant Monitoring Programs

	U.S. EPA National Dioxin Study	U.S. FWS NPMP and NCBP	U.S. EPA NSCRF	USGS NWQAP
BOTTOM FEEDERS				
Family <i>Cyprinidae</i> Carp (<i>Cyprinus carpio</i>)	●	●	●	●
Family <i>Ictaluridae</i> Channel catfish (<i>Ictalurus punctatus</i>)	●	● Or other ictalurid	●	●
Family <i>Catostomidae</i> White sucker (<i>Catostomus commersoni</i>)	●	● Or other catostomid	●	●
Longnose sucker (<i>C. catostromus</i>)				●
Largescale sucker (<i>C. macrocheilus</i>)				
Spotted sucker (<i>Minytrema melanops</i>)			●	
Redhorse sucker (<i>Moxostoma sp.</i>) included variety of species: Silver redhorse (<i>M. anisurum</i>) Grey redhorse (<i>M. congetum</i>) Black redhorse (<i>M. duquesnei</i>) Golden redhorse (<i>M. erythrurum</i>) Shorthead redhorse (<i>M. macrolepidotum</i>) Blacktail redhorse (<i>M. poecilurum</i>)			●	
PREDATORS				
Family <i>Salmoridae</i> Rainbow trout (<i>Oncortynchus mykiss</i>) [formerly <i>Salmo gairdneni</i>]	●	●		
Brown trout (<i>Salmo trutta</i>)	●	●	●	●
Brook trout (<i>Salvelinus fontinalis</i>)	●	●		●
Lake trout (<i>Salmo namaycush</i>)	●	●		
Family <i>Percidae</i> Walleye (<i>Stizostedion vitreum</i>)	● Or other pericid	● Or other pericid	●	
Sauger (<i>Stizostedion canadense</i>)	○	○		
Yellow perch (<i>Perca flavescans</i>)	○	○		
Family <i>Percichthyidae</i> White bass (<i>Morone chrysops</i>)			●	
Family <i>Centrarchidae</i> Largemouth bass (<i>Micropterus salmoides</i>)	● Or other centrarchid	● Or other centrarchid	●	●
Smallmouth bass (<i>Micropterus dolomieu</i>)			●	
Black crappie (<i>Pomoxis nigromaculatus</i>)	○	○		
White crappie (<i>Pomoxis annularis</i>)	○	○	●	
Bluegill sunfish (<i>Lepomis macrochirus</i>)	○	○		●
Family <i>Esocidae</i> Northern pike (<i>Esox lucius</i>)			●	
Family <i>Ictaluridae</i> Flathead catfish (<i>Pylodictis olivaris</i>)			●	

- Recommended target species
- Alternate target species

NPMP = National Pesticide Monitoring Program
 NCBP = National Contaminant Biomonitoring Program
 NSCRF = National Study of Chemical Residues in Fish
 NWQAP = National Water Quality Assessment Program

Sources: Versar, Inc., 1984; Schmitt et al., 1990; Schmitt et al., 1983; May and McKinney, 1981; U.S. EPA, 1992c, 1992d; Crawford and Luoma, 1993.

Table 3-4. Freshwater Turtles Recommended for Use as Target Species

Family name	Common name	Scientific name
<i>Chelydridae</i>	Snapping turtle	<i>Chelydra serpentina</i>
<i>Emydidae</i>	Yellow-bellied turtle	<i>Trachemys scripta scripta</i>
	Red-eared turtle	<i>Trachemys scripta elegans</i>
	River cooter	<i>Pseudemys concinna concinna</i>
	Suwanee cooter	<i>Pseudemys concinna suwanniensis</i>
	Slider	<i>Pseudemys concinna hieroglyphica</i>
	Texas slider	<i>Pseudemys concinna texana</i>
	Florida cooter	<i>Pseudemys floridana floridana</i>
	Peninsula cooter	<i>Pseudemys floridana penisularis</i>
<i>Trionychidae</i>	Smooth softshell	<i>Apalone muticus</i>
	Eastern spiny softshell	<i>Apalone spinifera spinifera</i>
	Western spiny softshell	<i>Apalone spinifera hartwegi</i>
	Gulf Coast spiny softshell	<i>Apalone spinifera aspera</i>
	Florida softshell	<i>Apalone ferox</i>

In addition, these three species are relatively widely distributed throughout the continental United States, and numerous states are already sampling these species in their contaminant monitoring programs. A review of the database *National Listing of State Fish and Shellfish Consumption Advisories and Bans* (RTI, 1993) indicated that the largest number of states issuing advisories for specific bottom-feeding species did so for carp (21 states) and channel catfish (22 states), with eight states issuing advisories for white suckers (see Table 3-7). Appendix D lists the freshwater fish species cited in consumption advisories for each state as of 1998.

3.3.1.2 Predator Species

EPA recommends that, whenever practical, states use predator target species listed in Tables 3-1 and 3-2 for inland fresh waters and Great Lakes waters, respectively. Predator species, because of their more definitive habitat and water temperature preferences, generally have a more limited geographic distribution. Thus, a greater number of predator species than bottom feeders have been used in national contaminant monitoring programs (Table 3-3) and these are recommended for use as target species in freshwater ecosystems. Predator fish that prefer relatively cold freshwater habitats include many members of the following families: *Salmonidae* (trout and salmon), *Percidae* (walleye and yellow perch), and *Esocidae* (northern pike and muskellunge). Members of the *Centrarchidae* (large- and smallmouth bass, crappie, and sunfish), *Percichthyidae* (white bass), and *Ictaluridae* (flathead catfish) families prefer relatively warm water habitats. Only two predator species (brown trout and largemouth bass) were used in all four of the national monitoring programs reviewed by the 1993 EPA Fish Contaminant Workgroup (Table 3-3). However, most of the other predator species recommended as target species have been used in at least one national monitoring program. To identify those predator species with a known ability to bioaccumulate contaminants in their tissues, the 1993 EPA Workgroup reviewed average tissue concentrations of xenobiotic contaminants for major

Table 3-5. Average Fish Tissue Concentrations (ppb) of Xenobiotics for Major Finfish Species Sampled in the National Study of Chemical Residues in Fish^a

Fish Species	Alpha-BHC	Gamma-BHC	Biphenyl	Chlorpyrifos	Dicofol	Dieldrin	Endrin	Heptachlor epoxide	Mercury	Mirex	Oxychlor-dane	PCBs
Bottom Feeders^b												
Carp	3.10	4.34	4.38	8.23	0.88	44.75	1.40	4.00	0.11	3.70	8.20	2941.13
White sucker	3.31	1.66	1.28	1.75	0.48	22.75	0.24	1.09	0.11	4.35	3.10	1697.81
Channel cat	2.87	3.17	1.24	6.97	0.59	15.44	9.07	0.50	0.09	14.59	6.41	1300.52
Redhorse sucker	0.82	0.41	1.25	0.35	ND	5.35	0.97	ND	0.27	0.57	2.37	487.72
Spotted sucker	1.45	2.63	3.35	0.56	0.05	5.52	ND	ND	0.12	1.79	0.05	133.90
Predators^b												
Largemouth bass	0.15	0.07	0.38	0.23	0.20	5.01	ND	0.30	0.46	0.21	0.47	232.26
Smallmouth bass	0.36	0.15	0.33	0.08	ND	2.34	ND	0.07	0.34	1.99	0.54	496.22
Walleye	ND	ND	0.40	0.04	ND	3.73	ND	0.21	0.51	0.08	1.11	368.65
Brown trout	1.59	ND	0.81	ND	0.94	20.13	ND	2.08	0.14	43.98	5.38	2434.07
White bass	0.34	0.79	0.62	1.32	ND	9.35	ND	1.40	0.35	0.11	0.84	288.35
Northern pike	0.55	ND	0.59	11.43	0.31	9.04	ND	ND	0.34	2.39	4.00	788.40
Flathead cat	0.92	0.58	0.60	22.57	1.28	37.38	3.45	0.57	0.27	ND	0.63	521.19
White crappie	0.23	ND	0.21	ND	ND	ND	ND	ND	0.22	ND	ND	22.34
Bluefish	0.38	0.12	0.20	ND	ND	2.87	ND	ND	0.22	0.13	ND	368.06
Fish Species												
	Penta-chloro-anisole	Penta-chloro-benzene	DDE	Total Chlordane	Total Nonachlor	123 TCB	124 TCB	135 TCB	1234 TECB	Trifluralin	Hexa-chloro-benzene	
Bottom Feeders^b												
Carp	16.50	1.04	415.43	67.15	63.15	1.54	4.77	0.08	0.30	12.55	3.58	
White sucker	9.06	0.39	78.39	18.43	20.83	0.16	0.30	0.14	0.15	ND	3.62	
Channel cat	39.60	1.32	627.77	54.39	66.28	0.14	0.37	ND	0.88	1.00	2.36	
Redhorse sucker	2.87	0.02	87.25	16.48	30.73	0.55	6.48	0.08	0.09	ND	0.58	
Spotted sucker	17.68	0.02	75.31	12.33	15.00	3.34	12.00	1.00	0.09	ND	0.02	
Predators^b												
Largemouth bass	0.57	0.02	55.72	2.89	4.21	0.22	0.19	0.03	0.01	ND	0.20	
Smallmouth bass	0.23	0.02	33.63	4.01	7.82	0.70	0.59	0.04	0.04	ND	0.36	
Walleye	0.76	ND	34.00	3.62	8.04	0.29	0.38	ND	0.004	ND	0.11	
Brown trout	0.09	0.60	158.90	7.25	32.60	1.10	0.98	ND	0.09	ND	3.06	
White bass	0.93	ND	17.44	10.67	16.00	0.21	0.10	ND	0.01	ND	0.83	
Northern pike	1.51	0.09	59.50	5.45	13.88	0.30	0.23	ND	0.01	ND	0.20	
Flathead catfish	0.31	ND	755.18	16.07	14.04	0.10	0.18	ND	ND	44.37	0.85	
White crappie	0.33	ND	10.04	0.34	0.28	0.08	0.08	0.08	ND	ND	ND	
Bluefish	0.05	ND	29.13	2.74	2.56	6.25	4.66	4.66	ND	ND	ND	

^a These average fish tissue concentrations may be higher or lower than those found in the ambient environment because of site selection criteria used in this study.

^b Values were calculated using whole-body samples for bottom feeders and fillet samples for predators. Individual values below detection limit were set at zero. Asterisk indicates all values below the detection limit. Units = ppb, (µg/g) wet weight basis. ND = Not detected.

Source: US. EPA, 1991h.

Table 3-6. Average Fish Tissue Concentrations (ppt) of Dioxins and Furans for Major Finfish Species Sampled in the National Study of Chemical Residues in Fish^a

Fish Species	2378 TCDD	12378 PeCDD	123478 HxCDD	123678 HxCDD	123789 HxCDD	1234678 HpCDD	2378 TCDF	12378 PeCDF	23478 PeCDF	123478 HxCDF	123678 HxCDF	123789 HxCDF	234678 HxCDF	1234678 HpCDF	1234789 TEQ	
Bottom Feeders^b																
Carp	7.76	3.63	2.16	6.81	1.54	22.29	10.15	1.31	4.01	2.54	1.91	1.16	1.20	2.49	1.22	13.06
White sucker	8.08	2.05	1.03	1.96	0.88	3.72	22.89	1.10	2.64	2.21	1.29	1.06	1.09	1.23	1.13	12.79
Channel catfish	11.56	2.37	1.61	5.62	1.29	9.40	2.22	0.52	2.91	2.41	1.41	1.38*	1.62	2.55	1.26	14.80
Redhorse sucker	4.65	1.50	1.40	2.36	0.84	4.94	30.09	0.75	1.28	2.10	1.16	1.19*	1.50	1.57	1.36*	9.22
Spotted sucker	1.73	2.34	1.70	12.08	1.14	17.48	7.49	2.12	2.06	2.22	1.79	1.28*	1.78	1.77	1.08	6.23
Predators^b																
Largemouth bass	1.73	0.59	1.12	1.28	0.64	2.48	2.18	0.37	0.47	1.24	1.23	1.21*	0.88	0.82	1.21*	1.91
Smallmouth bass	0.72	0.50*	1.13*	0.79	0.64*	0.67	1.93	0.36*	0.51	1.28	1.23	1.26*	0.89*	0.69	1.30*	0.65*
Walleye	0.88	0.54*	0.99*	0.73	0.62*	0.88	1.83	0.35*	0.38	1.04	1.09*	1.07*	0.75	0.74	1.21*	0.79*
Brown trout	2.52	1.01	1.07*	0.98	0.68*	1.18	3.74	0.60	1.36	1.47	1.12*	1.09*	0.94*	0.67*	1.16*	3.31
White bass	3.00	0.66	1.05*	0.78	0.61*	1.01	5.07	0.40	0.49	1.04	1.16*	1.13*	0.81*	0.63	1.17*	3.44
Northern pike	0.77	0.46*	1.23*	0.91	0.69*	0.73	1.01	0.44	0.66	1.41*	1.42*	1.38*	0.98*	0.56	1.30*	0.66
Fathead cat	0.78	0.43	0.90	1.06	0.50	1.67	1.63	0.40	0.56	1.05	1.20*	1.17*	0.61*	0.56	1.10*	0.99
White crappie	2.13	0.60	1.29*	1.03*	0.83*	1.33	10.46	0.54	0.67	1.33*	1.33*	1.30*	0.95*	0.96*	1.34*	3.80
Bluefish	0.85	0.56	1.23*	0.98*	0.69*	0.65	2.11	0.41	0.59	1.42*	1.42*	1.39*	0.98*	0.72*	1.31*	1.41

^a These average fish tissue concentrations may be higher or lower than those found in the ambient environment because of site selection criteria used in this study.
^b Values were calculated using whole-body samples for bottom feeders and fillet samples for predators. Values below detection limit have been replaced by one-half detection limit for the given sample. Asterisk indicates all values below detection limit. Units = ppt (pg/g) wet weight basis.
 TEQ = Toxicity equivalency was based on TEF-89 toxicity weighting values; however, octachlorodibenzo-*p*-dioxin and octachlorodibenzofurans were not analyzed; therefore, the TEQ value does not include these two compounds.

Source: U.S. EPA, 1991h.

predator fish species sampled in the National Study of Chemical Residues in Fish. Unlike the bottom feeders (common carp, channel catfish, and white suckers), no single predator species or group of predator species consistently exhibited the highest tissue concentrations for the contaminants analyzed (Tables 3-5 and 3-6). However, average fish tissue concentrations for some contaminants (i.e., mercury, mirex, chlorpyrifos, DDE, 1,2,3-trichlorobenzene [123-TCB], and trifluralin) were higher for some predator species than for the bottom feeders despite the fact that only the fillet portion rather than the whole body was analyzed for predator species. This finding emphasizes the need for using two types of fish (i.e., bottom feeders and predators) with different habitat and feeding strategies as target species.

The existence of fish consumption advisories for these predator target species was further justification for their recommended use. As was shown for the bottom-feeder target species, states were already sampling the recommended predator target species listed in Table 3-7. The largest number of states issuing advisories in 1993 for specific predator species did so for largemouth bass (15), lake trout (10), white bass (10), smallmouth bass (9), brown trout (9), walleye (9), rainbow trout (8), yellow perch (8), chinook salmon (7), northern pike (7), black crappie (5), flathead catfish (4), and muskellunge (4) (RTI, 1993). For comparison, the number of states reporting advisories for each species in 1998 is also presented in Table 3-7.

Because some freshwater finfish species (e.g., several Great Lake salmonids) are highly migratory, harvesting of these species may be restricted to certain seasons because sexually mature adult fish (i.e., the recommended size for sampling) may make spawning runs from the Great Lakes into tributary streams. EPA recommends that spawning populations not be sampled in fish contaminant monitoring programs. Sampling of target finfish species during their spawning period should be avoided because contaminant tissue concentrations may decrease during this time (Phillips, 1980) and because the spawning period is generally outside the legal harvest period. **Note:** Target finfish may be sampled during their spawning period, however, if the species can be legally harvested at this time.

State personnel, with their knowledge of site-specific fisheries and human consumption patterns, must be the ultimate judge of the species selected for use in freshwater fish contaminant monitoring programs within their jurisdiction.

3.3.2 Target Turtle Species

EPA recommends that states in which freshwater turtles are consumed by recreational, subsistence, or ethnic populations consider monitoring turtles to assess the level of environmental contamination and whether they pose a human health risk. In all cases, the primary criterion for selecting the target turtle species is whether it is commonly consumed. To identify those turtle species with a known ability to bioaccumulate contaminants in their tissues, the 1993 EPA Workgroup reviewed turtle species cited in state consumption advisories and those species identified

Table 3-7. Principal Freshwater Fish Species Cited in State Fish Consumption Advisories^a

Family name	Common name	Scientific name	Number of states with advisories ^b	
			1993	1998
<i>Percichthyidae</i>	White bass	<i>Morone chrysops</i>	10	17
	Striped bass	<i>Morone saxatilis</i>	6	12
	White perch	<i>Morone americana</i>	4	7
<i>Centrarchidae</i>	Largemouth bass	<i>Micropterus salmoides</i>	15	33
	Smallmouth bass	<i>Micropterus dolomieu</i>	9	18
	Black crappie	<i>Pomoxis nigromaculatus</i>	5	18
	White crappie	<i>Pomoxis annularis</i>	2	11
	Bluegill sunfish	<i>Lepomis macrochirus</i>	5	11
	Rock bass	<i>Ambloplites rupestris</i>	3	5
<i>Percidae</i>	Yellow perch	<i>Perca flavescens</i>	8	12
	Sauger	<i>Stizostedion canadense</i>	4	9
	Walleye	<i>Stizostedion vitreum</i>	9	12
<i>Cyprinidae</i>	Common carp	<i>Cyprinus carpio</i>	21	25
<i>Acipenseridae</i>	Shovelnose sturgeon	<i>Scaphirhynchus platyrhynchus</i>	1	3
	Lake sturgeon	<i>Acipenser fulvescens</i>	2	3
<i>Catostomidae</i>	Smallmouth buffalo	<i>Ictiobus bubalus</i>	4	5
	Bigmouth buffalo	<i>Ictiobus cyprinellus</i>	4	6
	Shorthead redhorse	<i>Moxostoma macrolepidotum</i>	2	3
	White sucker	<i>Catostomus commersoni</i>	8	11
	Quillback carpsucker	<i>Carpodes cyprinus</i>	2	5
<i>Ictaluridae</i>	White catfish	<i>Ictalurus catus</i>	5	6
	Channel catfish	<i>Ictalurus punctatus</i>	22	26
	Flathead catfish	<i>Pylodictis olivaris</i>	4	11
	Black bullhead	<i>Ictalurus melas</i>	2	3
	Brown bullhead	<i>Ictalurus nebulosus</i>	7	10
	Yellow bullhead	<i>Ictalurus natalis</i>	2	8
<i>Sciaenidae</i>	Freshwater drum	<i>Aplodinotus grunniens</i>	3	13
<i>Esocidae</i>	Northern pike	<i>Esox lucius</i>	7	10
	Muskellunge	<i>Esox masquinongy</i>	4	4
<i>Salmonidae</i>	Coho salmon	<i>Oncorhynchus kisutch</i>	6	8
	Chinook salmon	<i>Oncorhynchus tshawytscha</i>	7	7
	Brown trout	<i>Salmo trutta</i>	9	11
	Lake trout	<i>Salvelinus namaycush</i>	10	12
	Rainbow trout	<i>Oncorhynchus mykiss</i> ^c	8	12
	Brook trout	<i>Salvelinus fontinalis</i>	3	4
	Lake whitefish	<i>Coregonus clupea formis</i>	2	7
<i>Anguillidae</i>	American eel	<i>Anguilla rostrata</i>	6	7

^a Species in boldface are EPA-recommended target species for inland fresh waters (see Table 3-1) and the Great Lakes waters (Table 3-2).

^b Many states did not identify individual species of finfish in their advisories.

^c Formerly *Salmo gairdneri*.

Sources: RTI, 1993; U.S. EPA, 1999c (NLFWA).

in the scientific literature as having accumulated high concentrations of environmental contaminants.

Based on information in state advisories and a number of environmental studies using turtles as biological indicators of pollution, one species stands out as an obvious choice for a target species, the common snapping turtle (*Chelydra serpentina*). This turtle has been recommended by several researchers as an important bioindicator species (Bishop et al., 1996; Bonin et al., 1995; Olafsson et al., 1983; Stone et al., 1980) and has the widest geographic distribution of any of the North American aquatic turtles (see Figure 3-1). In addition, this species is highly edible, easily identified, easily collected, long-lived (>20 years), grows to a large size, and has been extensively studied with respect to a variety of environmental contaminants. Other turtle species that should be considered for use as target species are listed in Table 3-4.

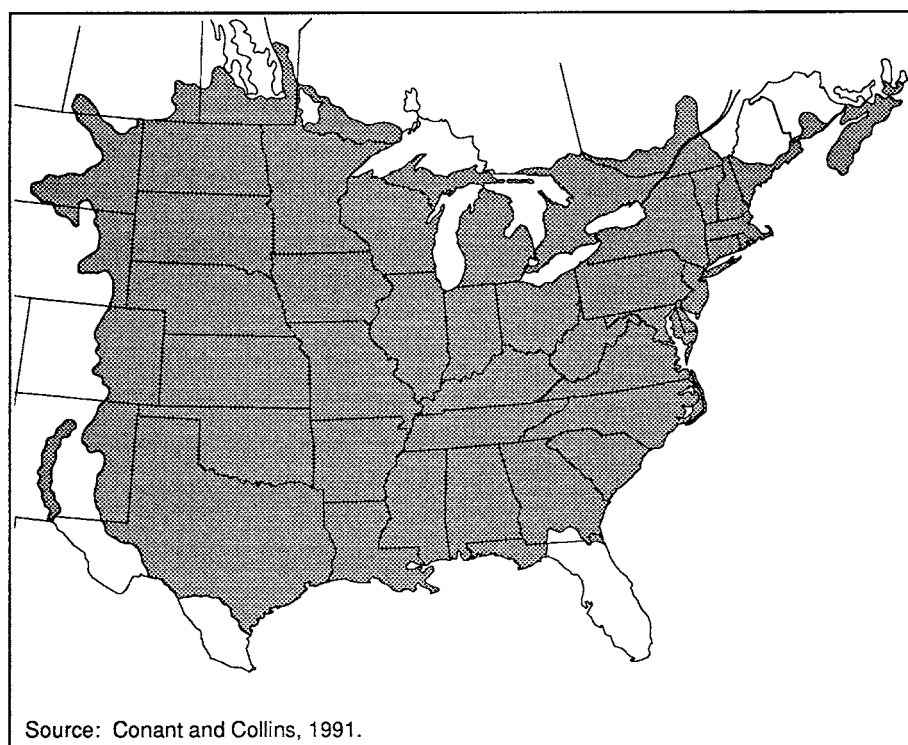

Figure 3-1. Geographic range of the common snapping turtle (*Chelydra serpentina*).

Four states (Arizona, Massachusetts, Minnesota, and New York) currently have consumption advisories in force for various turtle species (U.S. EPA, 1999c; New York State Department of Health, 1994). The species cited in the state advisories and the pollutants identified in turtle tissues as exceeding acceptable levels of contamination with respect to human health are listed in Table 3-8. New York

Table 3-8. Principal Freshwater Turtle Species Cited in State Consumption Advisories

Family name	Common name	Scientific name	Pollutant	State
<i>Chelydridae</i>	Snapping turtle ^a	<i>Chelydra serpentina</i>	Mercury	MN
	Snapping turtle ^a (and other unspecified turtle species)	<i>Chelydra serpentina</i>	PCBs	MA
	Snapping turtle ^b	<i>Chelydra serpentina</i>	PCBs	NY
<i>Trionychidae</i>	Western spiny softshell ^a	<i>Apalone spiniferus</i>	DDT toxaphene, chlordane, dieldrin	AZ

PCB = Polychlorinated biphenyls. DDT = 1,1,1-trichloro-2,2 bis(p-chlorophenyl)ethane.

^aSource: U.S. EPA 1999c (NLFWA).

^bSource: New York State Department of Health, 1994.

state has a statewide advisory directed specifically at women of childbearing age and children under 15 and advises these groups to avoid eating snapping turtles altogether. The advisory also recommends that members of the general population who wish to consume turtle meat should trim away all fat and discard the liver tissue and eggs of the turtles prior to cooking the meat or preparing other dishes. These three tissues (fat, liver, and eggs) have been shown to accumulate extremely high concentrations of a variety of environmental contaminants in comparison to muscle tissue (Bishop et al., 1996; Bonin et al., 1995; Bryan et al., 1987; Hebert et al., 1993; Olafsson et al 1983; 1987; Ryan et al., 1986; Stone et al., 1980). The Minnesota advisory also recommends that consumers remove all fat from turtle meat prior to cooking as a risk-reducing strategy (Minnesota Department of Health, 1994). States should consider monitoring pollutant concentrations in all three tissues (fat, liver, and eggs) in addition to muscle tissue if resources allow. If residue analysis reveals the presence of high concentrations of any environmental contaminant of concern, the state should consider making the general recommendation to consumers to discard these three highly lipophilic tissues (fat, liver, and eggs) to reduce the risk of exposure particularly to many organic chemical contaminants.

To identify those freshwater turtle species with a known ability to bioaccumulate chemical contaminants in their tissues, several studies were reviewed that identified freshwater turtle species as useful biomonitors of PCBs (Bishop et al., 1996; Bonin et al., 1995; Bryan et al., 1987; Hebert et al., 1993; Helwig and Hora, 1983; Olafsson et al., 1983; 1987; Safe, 1985; and Stone et al., 1980), dioxins and dibenzofurans (Bishop et al., 1996; Rappe et al., 1981; Ryan et al., 1986), organochlorine pesticides (Bishop et al., 1996; Bonin et al., 1995; Hebert et al., 1993; Stone et al., 1980), heavy metals (Bonin et al., 1995; Helwig and Hora, 1983; Stone et al., 1980), and radioactive nuclides (cesium-137 and strontium-90) (Lamb et al., 1991; Scott et al., 1986). The turtle species used in these studies, the pollutants monitored, and the reference sources are summarized in Table 3-9.

Table 3-9. Studies Using Freshwater Turtles as Biomonitors of Environmental Contamination

Species	Pollutant monitored	Source
Snapping turtle (<i>Chelydra serpentina</i>)	PCBs, total DDT, mirex	Hebert et al., 1993
Snapping turtle (<i>Chelydra serpentina</i>)	PCBs	Olafsson et al., 1987 Olafsson et al., 1983
Snapping turtle (<i>Chelydra serpentina</i>)	PCBs	Safe, 1987
Snapping turtle (<i>Chelydra serpentina</i>)	PCBs	Bryan et al., 1987
Snapping turtle (<i>Chelydra serpentina</i>)	Dioxins/Furans	Ryan et al., 1986
Snapping turtle (<i>Chelydra serpentina</i>)	PCBs, mercury, cadmium	Helwig and Hora, 1983
Snapping turtle (<i>Chelydra serpentina</i>)	Furans	Rappe et al., 1981
Snapping turtle (<i>Chelydra serpentina</i>)	Organochlorine pesticides (DDE, dieldrin, hexachlorobenzene, heptachlor epoxide, mirex), PCBs, cadmium, mercury	Stone et al., 1980
Snapping turtle (<i>Chelydra serpentina</i>)	29 Organochlorine pesticides, 39 PCB congeners, mercury	Bonin et al., 1995
Snapping turtle eggs	4 Organochlorine pesticides (DDE, dieldrin, mirex, hexachloro- benzene), PCBs, dioxins/furans	Bishop et al., 1996
Yellow-bellied turtle (<i>Trachemys scripta</i>)	Cesium-137 Strontium-90	Lamb et al., 1991
Yellow-bellied turtle (<i>Trachemys scripta</i>)	Cesium-137 Strontium-90	Scott et al., 1986
PCBs = Polychlorinated biphenyls. DDT = 1,1,1-Trichloro-2,2 bis(p-chlorophenyl)ethane. DDE = 1,1-Dichloro-2,2-bis(p-chlorophenyl)-ethylene.		

State personnel, with their knowledge of site-specific fisheries and human consumption patterns, must be the ultimate judge of the turtle species selected for use in contaminant monitoring programs within their jurisdictions. Because several turtle species are becoming less common as a result of habitat loss or degradation or overharvesting, biologists need to ensure that the target species selected for the state toxics monitoring program is not of special concern within their jurisdiction or designated as a threatened or endangered species. For example, two highly edible turtle species, the Alligator snapping turtle (*Macrolemys temmincki*) and the Northern diamondback terrapin (*Malaclemys terrapin terrapin*) are protected in some states or designated as species of concern within portions of their geographic range and are also potential candidates for federal protection (Sloan and Lovich, 1995). Although protected to varying degrees by several states, George (1987) and Pritchard (1989) concluded that the Alligator snapping turtle should receive range-wide protection

from the federal government as a threatened species under the Endangered Species Act. Unfortunately, basic ecological and life history information necessary to make environmental management decisions (i.e., federal listing as endangered or threatened species) is often not available for turtles and other reptiles (Gibbons, 1988).

Several species of freshwater turtles already have been designated as endangered or threatened species in the United States including the Bog turtle (*Clemmys muhlenbergii*), Plymouth red-bellied turtle (*Pseudemys rubriventris bangsi*), Alabama red-bellied turtle (*Pseudemys alabamensis*), Flattened musk turtle (*Stemotherus depressus*), Ringed map (=sawback) turtle (*Graptemys oculifera*), and the Yellow-blotched map (=sawback) turtle (*Graptemys flavimaculata*) (U.S. EPA, 1994; U.S. Fish and Wildlife Service, 1994). In addition, all species of marine sea turtles including the Green sea turtle (*Chelonia mydas*), Hawksbill sea turtle (*Eretmochelys imbricata*), Kemp's ridley sea turtle (*Lepidochelys kempii*), Olive ridley sea turtle (*Lepidochelys olivacea*), Loggerhead sea turtle (*Caretta caretta*), and the Leatherback sea turtle (*Dermochelys coriacea*) have been designated as endangered (U.S. EPA, 1994; U.S. Fish and Wildlife Service, 1994).

3.4 ESTUARINE/MARINE TARGET SPECIES

EPA recommends that states collect **either** one shellfish species (preferably a bivalve mollusc) and one finfish species **or** two finfish species at each estuarine/marine screening site. In all cases, the primary criterion for selecting the target species is that it is commonly consumed. Ideally, one shellfish species and one finfish species should be sampled; however, if no shellfish species from the recommended target species list meets the primary criterion, EPA recommends that states use two finfish species selected from the appropriate regional estuarine/marine target species lists. If two finfish are selected as the target species, one should be a bottom-feeding species.

EPA recommends that, whenever practical, states use target species selected from fish and shellfish species identified in Tables 3-10 through 3-16 for the following specific estuarine/marine coastal areas:

- Northeast Atlantic region (Maine through Connecticut)—Table 3-10
- Mid-Atlantic region (New York through Virginia)—Table 3-11
- Southeast Atlantic region (North Carolina through Florida)—Table 3-12
- Gulf Coast region (west coast of Florida through Texas)—Table 3-13
- Pacific Northwest region (Alaska through Oregon)—Table 3-14
- Northern California waters (Klamath River through Morro Bay)—Table 3-15
- Southern California waters (Santa Monica Bay to Tijuana Estuary)—Table 3-16.

Table 3-10. Recommended Target Species for Northeast Atlantic Estuaries and Marine Waters (Maine through Connecticut)

Family name	Common name	Scientific name
Finfish Species		
<i>Anguillidae</i>	American eel	<i>Anguilla rostrata</i>
<i>Percichthyidae</i>	Striped bass	<i>Morone saxatilis</i>
<i>Pomatomidae</i>	Bluefish	<i>Pomatomus saltatrix</i>
<i>Sparidae</i>	Scup	<i>Stenotomus chrysops</i>
<i>Sciaenidae</i>	Weakfish	<i>Cynoscion regalis</i>
<i>Bothidae</i>	Summer flounder	<i>Paralichthys dentatus</i>
	Four-spotted flounder	<i>Paralichthys oblongus</i>
<i>Pleuronectidae</i>	Winter flounder	<i>Pseudopleuronectes americanus</i>
	Yellowtail flounder	<i>Limanda ferruginea</i>
	American dab	<i>Hippoglossoides platessoides</i>
Shellfish Species		
<i>Bivalves</i>	Soft-shell clam	<i>Mya arenaria</i>
		<i>Mercenaria mercenaria</i>
		<i>Arctica islandica</i>
		<i>Spisula solidissima</i>
		<i>Mytilus edulis</i>
<i>Crustaceans</i>	American lobster	<i>Homarus americanus</i>
	Eastern rock crab	<i>Cancer irroratus</i>

Table 3-11. Recommended Target Species for Mid-Atlantic Estuaries and Marine Waters (New York through Virginia)

Family name	Common name	Scientific name
Finfish Species		
<i>Anguillidae</i>	American eel	<i>Anguilla rostrata</i>
<i>Ictaluridae</i>	Channel catfish	<i>Ictalurus punctatus</i>
	White catfish	<i>Ictalurus catus</i>
<i>Percichthyidae</i>	White perch	<i>Morone americana</i>
	Striped bass	<i>Morone saxatilis</i>
<i>Pomatomidae</i>	Bluefish	<i>Pomatomus saltatrix</i>
<i>Sparidae</i>	Scup	<i>Stenotomus chrysops</i>
<i>Sciaenidae</i>	Weakfish	<i>Cynoscion regalis</i>
	Spot	<i>Leiostomus xanthurus</i>
	Atlantic croaker	<i>Micropogonias undulatus</i>
	Red drum	<i>Sciaenops ocellatus</i>
<i>Bothidae</i>	Summer flounder	<i>Paralichthys dentatus</i>
<i>Pleuronectidae</i>	Winter flounder	<i>Pseudopleuronectes americanus</i>
Shellfish Species		
<i>Bivalves</i>	Hard clam	<i>Mercenaria mercenaria</i>
	Soft-shell clam	<i>Mya arenaria</i>
	Ocean quahog	<i>Arctica islandica</i>
	Surf clam	<i>Spisula solidissima</i>
	Blue mussel	<i>Mytilus edulis</i>
	American oyster	<i>Crassostrea virginica</i>
<i>Crustaceans</i>	Blue crab	<i>Callinectes sapidus</i>
	American lobster	<i>Homarus americanus</i>
	Eastern rock crab	<i>Cancer irroratus</i>

Table 3-12. Recommended Target Species for Southeast Atlantic Estuaries and Marine Waters (North Carolina through Florida)

Family name	Common name	Scientific name
Finfish Species		
<i>Anguillidae</i>	American eel	<i>Anguilla rostrata</i>
<i>Ictaluridae</i>	Channel catfish	<i>Ictalurus punctatus</i>
	White catfish	<i>Ictalurus catus</i>
<i>Percichthyidae</i>	White perch	<i>Morone americana</i>
	Striped bass	<i>Morone saxatilis</i>
<i>Sciaenidae</i>	Spot	<i>Leiostomus xanthurus</i>
	Atlantic croaker	<i>Micropogonias undulatus</i>
	Red drum	<i>Sciaenops ocellatus</i>
<i>Bothidae</i>	Southern flounder	<i>Paralichthys lethostigma</i>
	Summer flounder	<i>Paralichthys dentatus</i>
Shellfish Species		
<i>Bivalves</i>	Hard clam	<i>Mercenaria mercenaria</i>
	American oyster	<i>Crassostrea virginica</i>
<i>Crustaceans</i>	West Indies spiny lobster	<i>Panulirus argus</i>
	Blue crab	<i>Callinectes sapidus</i>

Table 3-13. Recommended Target Species for Gulf of Mexico Estuaries and Marine Waters (West Coast of Florida through Texas)

Family name	Common name	Scientific name
Finfish Species		
<i>Ictaluridae</i>	Blue catfish	<i>Ictalurus furcatus</i>
	Channel catfish	<i>Ictalurus punctatus</i>
<i>Ariidae</i>	Hardhead catfish	<i>Arius felis</i>
<i>Sciaenidae</i>	Spotted seatrout	<i>Cynoscion nebulosus</i>
	Spot	<i>Leiostomus xanthurus</i>
	Atlantic croaker	<i>Micropogonias undulatus</i>
	Red drum	<i>Sciaenops ocellatus</i>
<i>Bothidae</i>	Gulf flounder	<i>Paralichthys albigutta</i>
	Southern flounder	<i>Paralichthys lethostigma</i>
Shellfish Species		
<i>Bivalves</i>	American oyster	<i>Crassostrea virginica</i>
	Hard clam	<i>Mercenaria mercenaria</i>
<i>Crustaceans</i>	White shrimp	<i>Penaeus setiferus</i>
	Blue crab	<i>Callinectes sapidus</i>
	Gulf stone crab	<i>Menippe adina</i>
	West Indies spiny lobster	<i>Panulirus argus</i>

Table 3-14. Recommended Target Species for Pacific Northwest Estuaries and Marine Waters (Alaska through Oregon)

Family name	Common name	Scientific name
Finfish Species		
<i>Embiotocidae</i>	Redtail Surfperch	<i>Amphistichus rhodoterus</i>
<i>Scorpaenidae</i>	Copper rockfish	<i>Sebastes caurinus</i>
	Black rockfish	<i>Sebastes melanops</i>
<i>Bothidae</i>	Speckled sanddab	<i>Citharichthys stigmaeus</i>
	Pacific sanddab	<i>Citharichthys sordidus</i>
<i>Pleuronectidae</i>	Starry flounder	<i>Platichthys stellatus</i>
	English sole	<i>Parophrys vetulus</i>
<i>Salmonidae</i>	Coho salmon	<i>Onchorhynchus kisutch</i>
	Chinook salmon	<i>Onchorhynchus tshawytscha</i>
Shellfish Species		
<i>Bivalves</i>	Blue mussel	<i>Mytilus edulis</i>
	California mussel	<i>Mytilus californianus</i>
	Pacific oyster	<i>Crassostrea gigas</i>
	Horseneck clam	<i>Tresus capax</i>
	Pacific littleneck clam	<i>Protothaca staminea</i>
	Soft-shell clam	<i>Mya arenaria</i>
	Manila clam	<i>Venerupis japonica</i>
<i>Crustaceans</i>	Dungeness crab	<i>Cancer magister</i>
	Red crab	<i>Cancer productus</i>

Table 3-15. Recommended Target Species for Northern California Estuaries and Marine Waters (Klamath River through Morro Bay)

Family name	Common name	Scientific name
Finfish Species		
<i>Triakidae</i>	Leopard shark	<i>Triakis semifasciata</i>
<i>Sciaenidae</i>	White croaker	<i>Genyonemus lineatus</i>
<i>Embiotocidae</i>	Redtailed surfperch	<i>Amphistichus rhodoterus</i>
	Striped seaperch	<i>Embiotoca lateralis</i>
<i>Scorpaenidae</i>	Black rockfish	<i>Sebastes melanops</i>
	Yellowtail rockfish	<i>Sebastes flavidus</i>
	Bocaccio	<i>Sebastes paucispinis</i>
<i>Bothidae</i>	Pacific sanddab	<i>Citharichthys sordidus</i>
	Speckled sanddab	<i>Citharichthys stigmaeus</i>
<i>Pleuronectidae</i>	Starry flounder	<i>Platichthys stellatus</i>
	English sole	<i>Parophrys vetulus</i>
<i>Salmonidae</i>	Coho salmon	<i>Onchorhynchus kisutch</i>
	Chinook salmon	<i>Onchorhynchus tshawytscha</i>
Shellfish Species		
<i>Bivalves</i>	Blue mussel	<i>Mytilus edulis</i>
	California mussel	<i>Mytilus californianus</i>
	Pacific littleneck clam	<i>Protothaca staminea</i>
	Soft-shell clam	<i>Mya arenaria</i>
<i>Crustaceans</i>	Dungeness crab	<i>Cancer magister</i>
	Red crab	<i>Cancer productus</i>
	Pacific rock crab	<i>Cancer antennarius</i>

Table 3-16. Recommended Target Species for Southern California Estuaries and Marine Waters (Santa Monica Bay to Tijuana Estuary)

Family name	Common name	Scientific name
Finfish Species		
<i>Serranidae</i>	Kelp bass	<i>Paralabrax clathratus</i>
	Barred sand bass	<i>Paralabrax nebulifer</i>
<i>Sciaenidae</i>	White croaker	<i>Genyonemus lineatus</i>
	Corbina	<i>Menticirrhus undulatus</i>
<i>Embiotocidae</i>	Black perch	<i>Embiotoca jacksoni</i>
	Walleye surf perch	<i>Hyperprosopan argenteum</i>
	Barred surfperch	<i>Amphistichus argenteus</i>
<i>Scorpaenidae</i>	California scorpionfish	<i>Scorpaena guttata</i>
	Widow rockfish	<i>Sebastes entomelas</i>
	Blue rockfish	<i>Sebastes mystinus</i>
	Bocaccio	<i>Sebastes paucispinis</i>
<i>Pleuronectidae</i>	Diamond turbot	<i>Hypsopetta guttulata</i>
	Dover sole	<i>Microstomus pacificus</i>
Shellfish Species		
<i>Bivalves</i>	Blue mussel	<i>Mytilus edulis</i>
	California mussel	<i>Mytilus californianus</i>
	Pacific littleneck clam	<i>Protothaca staminea</i>
<i>Crustaceans</i>	Pacific rock crab	<i>Cancer antennarius</i>
	Red crab	<i>Cancer productus</i>
	California rock lobster	<i>Panulirus interruptus</i>

The seven separate regional lists of target species recommended by the 1993 EPA Workgroup for estuarine/marine ecosystems were developed because of differences in species' geographic distribution and abundance and the nature of the regional fisheries and were developed based on a review of species used in the following national monitoring programs:

- National Dioxin Study (U.S. EPA)
- Section 301(h) Monitoring Program (U.S. EPA)
- National Status and Trends Program (NOAA)
- National Study of Chemical Residues in Fish (U.S. EPA).

Because some of these programs identified some fish and shellfish species that are not of commercial, sportfishing, or subsistence value, several additional literature sources identifying commercial and sportfishing species were also

reviewed (Table 3-17). Some sources included information on seasonal distribution and abundance of various life stages (i.e., adults, spawning adults, juveniles) of fish and shellfish species. This information was useful in delineating seven regional estuarine/marine areas nationwide. The 1993 EPA Workgroup also reviewed fish and shellfish species cited in state consumption advisories for estuarine/marine waters (Appendix D). Each of the final regional lists of target species has been reviewed by state, regional, and national fisheries experts.

Use of two distinct ecological groups of organisms (shellfish and finfish) as target species in estuarine/marine systems is recommended. This permits monitoring of a wide variety of habitats, feeding strategies, and physiological factors that might result in differences in bioaccumulation of contaminants. Estuarine/marine species used in several national contaminant monitoring programs reviewed by the 1993 EPA Workgroup are compared in Table 3-18.

3.4.1 Target Shellfish Species

Selection of shellfish species (particularly bivalve molluscs) as target species received primary consideration by the 1993 EPA Workgroup because of the commercial, recreational, and subsistence value of shellfish in many coastal areas of the United States. Bivalve molluscs (e.g., oysters, mussels, and clams) are filter feeders that accumulate contaminants directly from the water column or via ingestion of contaminants adsorbed to phytoplankton, detritus, and sediment particles. Bivalves are good bioaccumulators of heavy metals (Cunningham, 1979) and polycyclic aromatic hydrocarbons (PAHs) and other organic compounds (Phillips, 1980; NOAA, 1987) and, because they are sessile, they may reflect local contaminant concentrations more accurately than more mobile crustacean or finfish species.

Three bivalve species—the blue mussel (*Mytilus edulis*), the California mussel (*Mytilus californianus*), and the American oyster (*Crassostrea virginica*)—were recommended and/or used in three of the national monitoring programs reviewed by the 1993 EPA Workgroup. Two other bivalve species—the soft-shell clam (*Mya arenaria*) and the Pacific oyster (*Crassostrea gigas*)—were also recommended and/or used in two national programs. Although no bivalve species was identified by name in state fish and shellfish consumption advisories (Appendix D), seven coastal states issued advisories in 1993 for unspecified bivalves or shellfish species that may have included these and other bivalve species. All three species are known to bioaccumulate a variety of environmental contaminants (Phillips, 1988). The wide distribution of these three species makes them useful for comparison within a state or between states sharing coastal waters (Figure 3-2). Because these three species met all of the selection criteria, they were recommended as target species for use in geographic areas in which they occur.

Table 3-17. Sources of Information on Commercial and Sportfishing Species in Various Coastal Areas of the United States

Geographic area	Source
Atlantic Coast	<p>National Marine Fisheries Service. 1987. <i>Marine Recreational Fishery Statistics Survey, Atlantic and Gulf Coasts, 1986</i>. Current Fishery Statistics Number 8392. National Oceanic and Atmospheric Administration, U.S. Department of Commerce, Rockville, MD.</p> <p>Leonard, D.L., M.A. Broutman, and K.E. Harkness. 1989. <i>The Quality of Shellfish Growing Waters on the East Coast of the United States</i>. Strategic Assessment Branch, National Oceanic and Atmospheric Administration, U.S. Department of Commerce, Rockville, MD.</p> <p>Nelson, D.M., M.E. Monaco, E.A. Irlandi, L.R. Settle, and L. Coston-Clements. 1991. <i>Distribution and Abundance of Fishes and Invertebrates in Southeast Estuaries</i>. ELMR Report No. 9. Strategic Assessment Division. National Oceanic and Atmospheric Administration, U.S. Department of Commerce, Rockville, MD.</p> <p>Stone, S.L., T.A. Lowery, J.D. Field, C.D. Williams, D.M. Nelson, S.H. Jury, M.E. Monaco, and L. Andreasen. 1994. <i>Distribution and Abundance of Fishes and Invertebrates in Mid-Atlantic Estuaries</i>. ELMR Rep. No. 12. NOAA/NOS Strategic Environmental Assessments Division, Silver Spring, MD.</p> <p>Jury, S.H., J.D. Field, S.L. Stone, D.M. Nelson, and M.E. Monaco. 1994. <i>Distribution and Abundance of Fishes and Invertebrates in North Atlantic Estuaries</i>. ELMR Rep. No. 13. NOAA/NOS Strategic Environmental Assessments Division, Silver Spring, MD.</p>
Gulf Coast	<p>National Marine Fisheries Service. 1987. <i>Marine Recreational Fishery Statistics Survey, Atlantic and Gulf Coasts, 1986</i>. Current Fishery Statistics Number 8392. National Oceanic and Atmospheric Administration, U.S. Department of Commerce, Rockville, MD.</p> <p>Broutman, M.A., and D.L. Leonard. 1988. <i>The Quality of Shellfish Growing Waters in the Gulf of Mexico</i>. Strategic Assessment Branch, National Oceanic and Atmospheric Administration, Rockville, MD.</p> <p>Monaco, M.E., D.M. Nelson, T.C. Czapl, and M.E. Patillo. 1989. <i>Distribution and Abundance of Fishes and Invertebrates in Texas Estuaries</i>. ELMR Report No. 3. Strategic Assessment Branch, National Oceanic and Atmospheric Administration, U.S. Department of Commerce, Rockville, MD.</p> <p>Williams, C.D., D.M. Nelson, M.E. Monaco, S.L. Stone, C. Iancu, L. Coston-Clements, L.R. Settle, and E.A. Irlandi. 1990. <i>Distribution and Abundance of Fishes and Invertebrates in Eastern Gulf of Mexico Estuaries</i>. ELMR Report No. 6. Strategic Assessment Branch, National Oceanic and Atmospheric Administration, U.S. Department of Commerce, Rockville, MD.</p> <p>Czapl, T.C., M.E. Patillo, D.M. Nelson, and M.E. Monaco. 1991. <i>Distribution and Abundance of Fishes and Invertebrates in Central Gulf of Mexico Estuaries</i>. ELMR Report No. 7. Strategic Assessment Branch, National Oceanic and Atmospheric Administration, U.S. Department of Commerce, Rockville, MD.</p> <p>Nelson, D.M. (editor). 1992. <i>Distribution and Abundance of Fishes and Invertebrates in Gulf of Mexico Estuaries</i>, Volume I: Data Summaries. ELMR Rep. No. 10. NOAA/NOS Strategic Environmental Assessments Division, Rockville, MD.</p> <p>Patillo, M.E., T.E. Czapl, D.M. Nelson, and M.E. Monaco. 1997. <i>Distribution and Abundance of Fishes and Invertebrates in Gulf of Mexico Estuaries. Vol. II: Species Life History Summaries</i>. ELMR Rep. No. 14. NOAA/NOS Strategic Environmental Assessments Division, Silver Spring, MD.</p>
West Coast	<p>National Marine Fisheries Service. 1987. <i>Marine Recreational Fishery Statistics Survey, Pacific Coast, 1986</i>. Current Fishery Statistics Number 8393. National Oceanic and Atmospheric Administration, U.S. Department of Commerce, Rockville, MD.</p> <p>Leonard, D.L., and E.A. Slaughter. 1990. <i>The Quality of Shellfish Growing Waters on the West Coast of the United States</i>. Strategic Assessment Branch, National Oceanic and Atmospheric Administration, U.S. Department of Commerce, Rockville, MD.</p> <p>Monaco, M.E., D.M. Nelson, R.L. Emmett, and S.A. Hinton. 1990. <i>Distribution and Abundance of Fishes and Invertebrates in West Coast Estuaries</i>. Volume I: Data Summaries. ELMR Report No. 4. Strategic Assessment Branch, National Oceanic and Atmospheric Administration, Rockville, MD.</p> <p>Emmett, R.L., S.A. Hinton, S.L. Stone, and M.E. Monaco. 1991. <i>Distribution and Abundance of Fishes and Invertebrates in West Coast Estuaries</i>. Volume II: Life History Summaries. ELMR Report No. 8. Strategic Environmental Assessment Division, Rockville, MD.</p>

Table 3-18. Estuarine/Marine Species Used in Several National Fish and Shellfish Contaminant Monitoring Programs

	U.S. EPA National Dioxin Study ^a	NOAA Status and Trends	U.S. EPA 301(h) Program	U.S. EPA NSCRF ^b
FINFISH				
Family <i>Acipenseridae</i> White sturgeon (<i>Acipenser transmontanus</i>)				●
Family <i>Ariidae</i> Hardhead catfish (<i>Arius felis</i>)				●
Family <i>Percichthyidae</i> White perch (<i>Morone americana</i>)				●
Family <i>Pomatomidae</i> Bluefish (<i>Pomatomus saltatrix</i>)				●
Family <i>Lutjanidae</i> Red snapper (<i>Lutjanus campechanus</i>)				●
Family <i>Sparidae</i> Sheepshead (<i>Archosargus probatocephalus</i>)				●
Family (<i>Sciaenidae</i>) Spotted seatrout (<i>Cynoscion nebulosus</i>)				●
Weakfish (<i>Cynoscion regalis</i>)				●
Spot (<i>Leiostomus xanthurus</i>)		●	●	●
White croaker (<i>Genyonemus lineatus</i>)		●		●
Atlantic croaker (<i>Micropogonias undulatus</i>)		●		●
Black drum (<i>Pogonias cromis</i>)				●
Red drum (<i>Sciaenops ocellatus</i>)				●
Family <i>Serranidae</i> Barred sand bass (<i>Paralabrax nebulifer</i>)		●		
Family <i>Mugilidae</i> Striped mullet (<i>Mugil cephalus</i>)				●
Family <i>Bothidae</i> Southern flounder (<i>Paralichthys lethostigma</i>)				●
Windowpane flounder (<i>Scophthalmus aquosus</i>)		●		
Family <i>Pleuronectidae</i> Pacific sanddab (<i>Citharichthys sordidus</i>)			●	
Flathead sole (<i>Hippoglossoides elassodon</i>)				●
Diamond turbot (<i>Hypsopsetta guttulata</i>)		●		
Starry flounder (<i>Platichthys stellatus</i>)		●		●
Hornyhead turbot (<i>Pleuronichthys verticalis</i>)		●		
Winter flounder (<i>Pseudopleuronectes americanus</i>)		●	●	●
English sole (<i>Parophrys vetulus</i>)		●	●	
Dover sole (<i>Microstomus pacificus</i>)		●	●	

See notes at end of table.

(continued)

Table 3-18. (continued)

	U.S. EPA National Dioxin Study ^a	NOAA Status and Trends	U.S. EPA 301(h) Program	U.S. EPA NSCRF ^b
SHELLFISH				
Bivalves				
Hard clam (<i>Mercenaria mercanaria</i>)			●	
Soft-shell clam (<i>Mya arenaria</i>)			●	●
Ocean quahog (<i>Arctica islandia</i>)			●	
Surf clam (<i>Spisula solidissima</i>)			●	
Blue mussel (<i>Mytilus edulis</i>)	●	●	●	
California mussel (<i>Mytilus californianus</i>)	●	●	●	
American oyster (<i>Crassostrea virginica</i>)	●	●	●	
Hawaiian oyster (<i>Ostrea sandwichensis</i>)		●		
Pacific oyster (<i>Crassostrea gigas</i>)			●	●
Bent-nosed macoma (<i>Macoma nasuta</i>)			●	
Baltic macoma (<i>Macoma baltica</i>)			●	
White sand macoma (<i>Macoma secta</i>)			●	
Crustaceans				
American lobster (<i>Homarus americanus</i>)			●	
West Indies spiny lobster (<i>Panulirus argus</i>)			●	
California rock lobster (<i>Panulirus interruptus</i>)			●	
Hawaiian spiny lobster (<i>Panulirus penicillatus</i>)			●	
Eastern rock crab (<i>Cancer irroratus</i>)			●	
Dungeness crab (<i>Cancer magister</i>)			●	●
Pacific rock crab (<i>Cancer antennarius</i>)			●	
Yellow crab (<i>Cancer anthonyi</i>)			●	
Red crab (<i>Cancer productus</i>)			●	

NSCRF = National Study of Chemical Residues in Fish.

^a Only freshwater finfish were identified as target species; bivalves were identified as estuarine/marine target species.

^b Species listed were those collected at more than one site nationally; *Salmonidae* were not listed because they were included on freshwater lists.

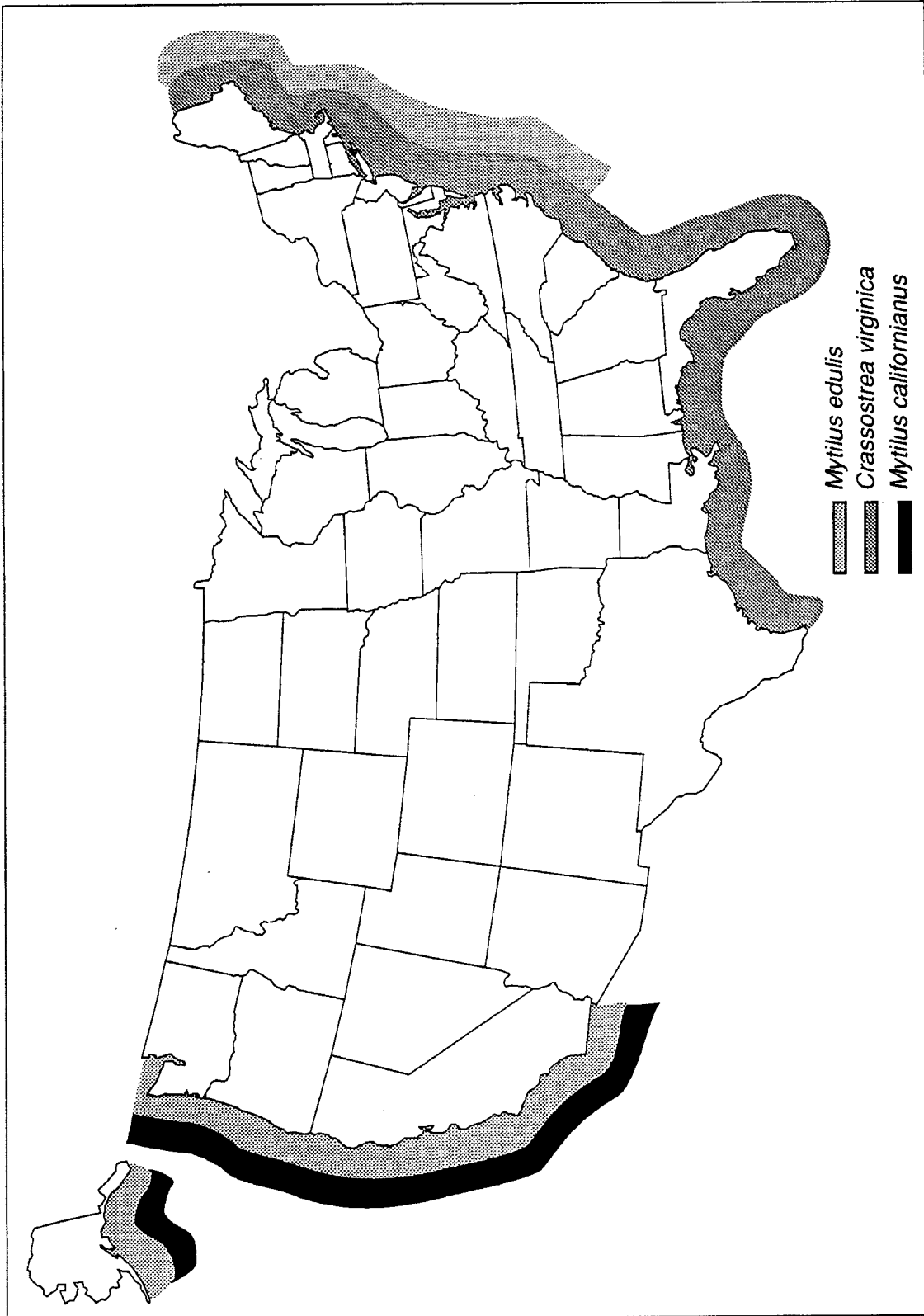

Source: Abbott, 1974.

Figure 3-2. Geographic distributions of three bivalve species used extensively in national contaminant monitoring programs.

In addition, several species of edible clams were added to the various estuarine/marine target species lists based on recommendations received from specific state and regional fisheries experts.

Crustaceans are also recommended as target species for estuarine/marine sampling sites. Many crustaceans are bottom-dwelling and bottom-feeding predator and/or scavenger species that are good indicators of contaminants that may be biomagnified through several trophic levels of the food web. Several species of lobsters and crabs were recommended in one national monitoring program, and the Dungeness crab was recommended in two national monitoring programs (Table 3-18). These crustaceans, although of fishery value in many areas, are not as widely distributed nationally as the three bivalve species (Figure 3-2). However, they should be considered for selection as target species in states where they are commonly consumed.

Only two crustaceans—the American lobster (*Homarus americanus*) and the blue crab (*Callinectes sapidus*)—were specifically identified in state advisories (RTI, 1993). However, in 1993, seven coastal states reported advisories in estuarine/marine waters for unspecified shellfish species that may have included these and other crustacean species (Table 3-19). All of the shellfish species cited in state advisories are included as EPA-recommended target species on the appropriate estuarine/marine regional lists.

3.4.2 Target Finfish Species

Two problems were encountered in the selection of target finfish species for monitoring fish tissue contamination at estuarine/marine sites regionally and nationally. First is the lack of finfish species common to both Atlantic and Gulf Coast waters as well as Pacific Coast waters. Species used in several federal fish contaminant monitoring programs are compared in Table 3-18. Members of the families *Sciaenidae* (seven species), *Bothidae* (two species), and *Pleuronectidae* (eight species) were used extensively in these programs. Bottom-dwelling finfish species (e.g., flounders in the families *Bothidae* and *Pleuronectidae*) may accumulate high concentrations of contaminants from direct physical contact with contaminated bottom sediments. In addition, these finfish feed on sedentary infaunal or epifaunal organisms and are at additional risk of accumulating contaminants via ingestion of these contaminated prey species (U.S. EPA, 1987a). For finfish species, two Atlantic coast species, spot (*Leiostomus xanthurus*) and winter flounder (*Pseudopleuronectes americanus*), are recommended and/or used in three of the national monitoring programs, and the Atlantic croaker (*Micropogonias undulatus*) is recommended and/or used in two national monitoring programs. Three Pacific coast species, Starry flounder (*Platichthys stellatus*), English sole (*Parophrys vetulus*), and Dover sole (*Microstomus pacificus*), are recommended or used in two of the national monitoring programs.

Table 3-19. Principal Estuarine/Marine Fish and Shellfish Species Cited in State Consumption Advisories^{a,b}

Species group name	Common name	Scientific name	Number of states with advisories in 1993	Number of states with advisories in 1998
Finfish				
<i>Percichthyidae</i>	Striped bass	<i>Morone saxatilis</i>	5	6
	White perch	<i>Morone americana</i>	3	3
<i>Centrarchidae</i>	Largemouth bass	<i>Micropterus salmoides</i>	0	3
	Smallmouth bass	<i>Micropterus dolomieu</i>	0	1
<i>Ictaluridae</i>	White catfish	<i>Ictalurus catus</i>	4	2
	Channel catfish	<i>Ictalurus punctatus</i>	5	2
<i>Anguillidae</i>	American eel	<i>Anguilla rostrata</i>	6	5
<i>Elopidae</i>	Ladyfish	<i>Elops saurus</i>	0	1
<i>Carangidae</i>	Crevalle jack	<i>Caranx hippos</i>	0	1
<i>Pomatomidae</i>	Bluefish	<i>Pomatomus saltatrix</i>	4	6
<i>Labridae</i>	Tautog	<i>Tautoga onitis</i>	0	1
<i>Sparidae</i>	Scup	<i>Stenotomus chrysops</i>	0	1
<i>Sciaenidae</i>	Spotted sea trout	<i>Cynoscion nebulosus</i>	0	2
	Atlantic croaker	<i>Micropogonias undulatus</i>	0	1
	Red drum	<i>Sciaenops ocellatus</i>	0	1
	Black drum	<i>Pogonias cromis</i>	0	1
	Silver perch	<i>Bairdiella chrysoura</i>	0	1
<i>Scombridae</i>	King mackerel	<i>Scomberomorus cavalla</i>	0	5
	Spanish mackerel	<i>Scomberomorus maculatus</i>	0	1
<i>Ariidae</i>	Gafftopsail catfish	<i>Bagre marinus</i>	0	1
<i>Belonidae</i>	Atlantic needlefish	<i>Strongylura marina</i>	1	1
<i>Serranidae</i>	Kelp bass	<i>Paralabrax clathratus</i>	1	1
<i>Sciaenidae</i>	Black croaker	<i>Cheilotrema saturnum</i>	1	1
	White croaker	<i>Genyonemus lineatus</i>	1	1
	Queenfish	<i>Seriphus politus</i>	1	1
	Corbina	<i>Menticirrhus undulatus</i>	1	1
Shellfish				
<i>Crustaceans^c</i>	American lobster	<i>Homarus americanus</i>	1	5
	Blue crab	<i>Callinectes sapidus</i>	3	4

^a Species in boldface are EPA-recommended target species for regional estuarine/marine waters (see Tables 3-10 through 3-16).

^b Many coastal states issued advisories for fish and shellfish species and thus did not identify specific finfish and shellfish species in their advisories.

^c Eight coastal states (California, Georgia, Hawaii, Louisiana, Massachusetts, North Carolina, Texas, and Washington) and the U.S. territory of American Samoa report advisories for unspecified shellfish or bivalve species.

Sources: RTI, 1993, EPA 1999a (NLFWA).

Second, because some estuarine/marine finfish species are highly migratory, harvesting of these species may be restricted to certain seasons because sexually mature adult fish (i.e., the recommended size for sampling) may enter the estuaries only to spawn. EPA recommends that neither spawning populations nor undersized juvenile stages be sampled in fish contaminant monitoring programs. Sampling of target finfish species during their spawning period should be avoided as contaminant tissue concentrations may decrease during this time (Phillips, 1980) and because the spawning period is generally outside the legal harvest period. **Note:** Target finfish species may be sampled during their spawning period if the species can be legally harvested at this time. Sampling of undersized juveniles of species that use estuaries as nursery areas is precluded by EPA's recommended monitoring strategy because juveniles may not have had sufficient time to bioaccumulate contaminants or attain harvestable size.

Because of these problems, the 1993 EPA Workgroup consulted with regional and state fisheries experts and reviewed the list of state fish consumption advisories and bans to determine which estuarine/marine finfish species should be recommended as target species. As shown in Table 3-19, the largest number of states issuing advisories in 1993 for specific estuarine and marine waters did so for the American eel (6), channel catfish (5), striped bass (5), bluefish (4), white catfish (4), and white perch (3). Several other estuarine/marine species were cited in advisories for one state each (Table 3-19). Many coastal states did not identify individual finfish species by name in their advisories (see Appendix D); however, almost all of the species that have been cited in state advisories are recommended as target species by EPA (see Tables 3-10 through 3-16). The listing of estuarine fish and shellfish cited in state advisories in 1998 is also shown in Table 3-19.

These seven regional lists of recommended estuarine/marine target species are provided to give guidance to states on species commonly consumed by the general population. State personnel, with their knowledge of site-specific fisheries and human consumption patterns, must be the ultimate judge of the species selected for use in estuarine/marine fish contaminant monitoring programs within their jurisdiction.

SECTION 4

TARGET ANALYTES

The selection of appropriate target analytes in fish and shellfish contaminant monitoring programs is essential to the adequate protection of the health of fish and shellfish consumers. The procedures used for selecting target analytes for screening studies and a list of recommended target analytes are presented in this section.

4.1 RECOMMENDED TARGET ANALYTES

Recommended target analytes for screening studies in fish and shellfish contaminant monitoring programs are listed in Table 4-1. This list was developed by the EPA 1993 Fish Contaminant Workgroup from a review of the following information:

1. Pollutants analyzed in several national or regional fish contaminant monitoring programs—The monitoring programs reviewed included

- National Study of Chemical Residues in Fish (U.S. EPA)
- National Dioxin Study (U.S. EPA)
- 301(h) Monitoring Program (U.S. EPA)
- National Pollutant Discharge Elimination System (U.S. EPA)
- National Pesticide Monitoring Program (U.S. FWS)
- National Contaminant Biomonitoring Program (U.S. FWS)
- National Status and Trends Program (NOAA)
- Great Lakes Sportfish Consumption Advisory Program
- National Water Quality Assessment Program (USGS).

Criteria for selection of the target analytes in these programs varied widely depending on specific program objectives. The target analytes used in these major fish contaminant monitoring programs are compared in Appendix E. Over 200 potential contaminants are listed, including metals, pesticides, base/neutral organic compounds, dioxins, dibenzofurans, acidic organic compounds, and volatile organic compounds.

Table 4-1. Recommended Target Analytes

Metals	Organophosphate Pesticides
Arsenic (inorganic)	Chlorpyrifos
Cadmium	Diazinon
Mercury (methylmercury)	Disulfoton
Selenium	Ethion
Tributyltin	Terbufos
Organochlorine Pesticides	Chlorophenoxy Herbicides
Chlordane, total (cis- and trans-chlordane, cis- and trans-nonachlor, oxychlordane)	Oxyfluorfen
DDT, total (2,4'-DDD, 4,4'-DDD, 2,4'-DDE, 4,4'-DDE, 2,4'-DDT, 4,4'-DDT)	PAHs^d
Dicofol	PCBs
Dieldrin	Total PCBs ^e (sum of PCB congeners or Aroclor equivalents)
Endosulfan (I and II)	Dioxins/furans^{f,g}
Endrin	
Heptachlor epoxide ^a	
Hexachlorobenzene	
Lindane (γ -hexachlorocyclohexane; γ -HCH) ^b	
Mirex ^c	
Toxaphene	

PAHs = Polycyclic aromatic hydrocarbons; PCBs = Polychlorinated biphenyls; DDT = p,p'-dichlorodiphenyl trichloroethane; DDE = p,p'-dichlorodiphenyl dichloroethylene; and DDD = dichlorodiphenyldichloro ethane.

^a Heptachlor epoxide is not a pesticide but is a metabolite of two pesticides, heptachlor and chlordane.

^b Also known as γ -benzene hexachloride (γ -BHC).

^c Mirex should be regarded primarily as a regional target analyte in the Southeast and Great Lakes states, unless historic tissue, sediment, or discharge data indicate the likelihood of its presence in other areas.

^d It is recommended that tissue samples be analyzed for benzo[*a*]pyrene, and 14 other PAHs and that the order-of-magnitude relative potencies given for these PAHs be used to calculate a potency equivalency concentration (PEC) for each sample for comparison with the recommended SVs for benzo[*a*]pyrene (see Section 5.3.2.5).

^e Analysis of total PCBs (as the sum of Aroclors or PCB congeners) is recommended for conducting human health risk assessments for total PCBs (see Sections 4.3.6 and 5.3.2.6). A standard method for Aroclor analysis is available (EPA Method 608). A standard method for congener analysis (EPA Method 1668) is currently under development; however, it has not been finalized. States that currently do congener-specific PCB analysis should continue to do so and other states are encouraged to develop the capability to conduct PCB congener analysis. When standard methods for congener analysis are verified and peer reviewed, the Office of Water will evaluate the use of these methods.

^f Note: The EPA Office of Research and Development is currently reassessing the human health effects of dioxins/furans.

^g It is recommended that the 17 2,3,7,8-substituted tetra- through octa-chlorinated dibenzo-*p*-dioxins (PCDDs) and dibenzofurans (PCDFs) and 12 dioxin-like PCBs be determined and a toxicity-weighted total concentration calculated for each sample (Van den Berg et al., 1998) (see Sections 4.3.7, 5.3.2.6, and 5.3.2.7).

2. Pesticides with active registrations—The EPA Office of Pesticide Programs (OPP) Fate One Liners Database (U.S. EPA, 1993a) containing information for more than 900 registered pesticides was reviewed to identify pesticides and herbicides with active registrations that met four criteria. The screening criteria used were

- Oral toxicity, Class I or II
- Bioconcentration factor greater than 300
- Half-life value of 30 days or more
- Initial use application profile.

At the time of this review, complete environmental fate information was available for only about half of the registered pesticides. As more data become available, additional pesticides will be evaluated for possible inclusion on the target analyte list.

Use of the OPP database was necessary because many pesticides and herbicides with active registrations have not been monitored extensively either in national or state fish contaminant monitoring programs.

3. **Contaminants that have triggered states to issue fish and shellfish consumption advisories or bans**—The database, *National Listing of State Fish and Shellfish Consumption Advisories and Bans* (RTI, 1993), was reviewed to identify specific chemical contaminants that have triggered issuance of consumption advisories by the states. As shown in Table 4-2, four contaminants (PCBs, mercury, chlordane, and dioxins/furans) triggered advisories in the largest number of states in 1993. As a comparison, the number of states issuing advisories for each pollutant in 1998 has also been presented while the total number of states issuing advisories for most pollutants generally has increased, the number of states issuing advisories for two major pollutants, chlordane and dioxin, has decreased over the past 5 years.
4. **Published literature on the chemistry and health effects of potential contaminants**—The physical, chemical, and toxicologic factors considered to be of particular importance in developing the recommended target analyte list were
 - Oral toxicity
 - Potential of the analyte to bioaccumulate
 - Prevalence and persistence of the analyte in the environment
 - Biochemical fate of the analyte in fish and shellfish
 - Human health risk of exposure to the analyte via consumption of contaminated fish and shellfish
 - Analytical feasibility.

Final selection of contaminants by the EPA 1993 Workgroup for the recommended target analyte list (Table 4-1) was based on their frequency of inclusion in national monitoring programs, on the number of states issuing consumption advisories for them in 1993 (Table 4-2), and on their origins, chemistry, potential to bioaccumulate, estimated human health risk, and feasibility of analysis. Primary consideration was also given to the recommendations of the Committee on Evaluation of the Safety of Fishery Products, published in *Seafood Safety* (NAS, 1991).

4.2 SELECTION AND PRIORITIZATION OF TARGET ANALYTES

The decision to conduct a fish tissue monitoring study is normally the result of the discovery of specific contaminants during water quality or sediment studies and/or

Table 4-2. Contaminants Resulting in Fish and Shellfish Advisories

Contaminant	Number of states issuing advisories	
	1993	1998
Metals		
Arsenic (total)	1	3
Cadmium	2	3
Chromium	1	1
Copper	1	1
Lead	4	5
Mercury	29	40
Selenium	5	5
Tributyltin	1	0
Zinc	1	1
Organometallics	1	1
Unidentified metals	3	1
Pesticides		
Chlordane	24	22
DDT and metabolites	9	12
Dieldrin	3	6
Heptachlor epoxide	1	1
Hexachlorobenzene	2	2
Kepone	1	1
Mirex	3	3
Photomirex	1	0
Toxaphene	2	4
Unidentified pesticides	2	2
Polycyclic aromatic hydrocarbons (PAHs)	3	4
Polychlorinated biphenyls (PCBs)	32	36
Dioxins/furans	20	19
Other chlorinated organics		
Dichlorobenzene	1	1
Hexachlorobutadiene	1	1
Pentachlorobenzene	1	0
Pentachlorophenol	1	2
Tetrachlorobenzene	2	0
Tetrachloroethane	1	0
Others		
Creosote	2	2
Gasoline	1	1
Multiple pollutants	2	1
Phthalate esters	1	0
Polybrominated biphenyls (PBBs)	1	1
Unspecified pollutants	3	0

Sources: RTI, 1993; U.S. EPA, 1999c.

the identification of pollutant sources in waters routinely used by recreational or subsistence fishers. EPA recognizes that measuring all 25 target analytes in fish tissues collected at all state monitoring sites is expensive and that cost is an important consideration that states must evaluate in designing and implementing

their fish monitoring programs. Ideally, if resources are available to conduct sampling and analysis of all 25 target analytes, the state should consider this option because it provides the greatest amount of information for fishers in the state on levels of contamination statewide. Also, this approach can better detect the presence of those contaminants that are transported long distances from their points of release (e.g., methylmercury, dioxins/furans, toxaphene), often outside the state's borders, and contaminate relatively pristine areas devoid of any obvious pollutant sources.

If the cost of this approach is prohibitive, however, the state may wish to use a watershed-based approach as a way to reduce sampling and analysis costs (Table 4-3). The selection and prioritization recommendations discussed below are watershed-based and take into consideration land use categories (rural, agricultural, suburban/urban, and industrial) as well as geological characteristics, regional differences, and national pollution trends. Land use patterns (both current and historic) are often the most important factors in deciding what analytes to select for analysis. The watershed-based approach gives the highest priority (XXX) to analysis of contaminants that are widely dispersed nationally and relatively inexpensive to analyze, such as mercury. This approach gives a lower priority (X) to monitoring organochlorine pesticides (e.g., chlordane, DDT, and dieldrin) at rural and suburban sites, but a higher priority (XX) to monitoring these same chemicals in agricultural watersheds where their use has been extensive or in industrial watersheds where they may have been released during manufacturing, formulation, packaging, or disposal. Because of the very high cost of analysis for some contaminants (e.g., PCBs and dioxins/furans and dioxin-like PCBs), this watershed approach also allows money for these analyses to be directed toward analysis primarily in suburban/urban and industrial watersheds where sources either from historic manufacturing or historic and/or current practices (combustion or incineration sources) have been identified or where water and/or sediment data in the watershed have detected these chemicals at elevated concentrations.

States should use all available environmental data and their best scientific judgment when developing their fish monitoring programs. Using the watershed approach gives states the flexibility to tailor their sampling and analysis programs to obtain needed information as cost-effectively as possible by directing limited resources to obtaining information on contaminant levels most likely to be found in fish tissue at a given site. To be most effective, states need to recognize and carefully evaluate all existing data when assessing which target analytes to monitor at a particular site. States should include any of the recommended EPA target analytes and any additional target analytes in their screening programs when site-specific information (e.g., tissue, water, or sediment data; discharge monitoring data from municipal and industrial sources; or pesticide use data) suggests that these contaminants may be present at levels of concern for human health.

Table 4-3. Selection and Prioritization of Target Analytes by Watershed Type

Analyte	Rural	Agricultural	Suburban/ Urban	Industrial	Sources/Uses
Metals					
Arsenic	XX ^a	X ^{a,b}	X ^{a,b}	XX ^b	Naturally occurring as a sulfide in mineral ores; fossil fuel combustion; mining/smelting; wood preservative; insecticide, herbicide, and algicide; hazardous waste site leachate
Cadmium	XX ^a	X ^{a,b}	X ^{a,b}	XX ^b	Smelting/mining; surface mine drainage; uses in paints, alloys, batteries, plastics, pesticides, herbicides; waste disposal operations.
Mercury	XXX ^c	XXX ^c	XXX ^c	XXX ^c	Naturally occurring; atmospheric transport from fossil fuel combustion; mining/smelting; chlorine alkali production; historic use in pulp and paper and paints; Hazardous waste site leachate; statewide freshwater and/or coastal advisories in 15 states
Selenium	XX ^a	X ^a	X ^a	XX ^d	Naturally occurring in west and southwest soils; emissions from fossil fuel combustion; leachate from coal fly ash disposal areas
Tributyltin			X ^d	XX ^d	Shipyards and marinas; uses in antifouling paint, cooling tower disinfectants, wood preservatives, pulp and paper industry, and textile mills.
Organochlorine Pesticides					
Chlordane		XX ^b	X ^b	XX ^b	Domestic termite control; pesticide manufacturing/packaging/formulation sites
DDT		XX ^b	X ^b	XX ^b	Broad spectrum pesticide use; pesticide manufacturing/packaging/formulation sites
Dicofol ^e		XX ^b		XX ^b	Miticide/pesticide for cotton, apples, and citrus primarily in FL and CA; lesser use in turf, ornamentals, pears, apricots, and cherries; pesticide manufacturing/packaging/formulation sites
Dieldrin		XX ^b	X ^b	XX ^b	Broad spectrum pesticide for termites/soil insects and for cotton, corn, and citrus; pesticide manufacturing/packaging/formulation sites
Endosulfan ^e		XX ^b		XX ^b	Noncontact insecticide for seed and soil treatments; pesticide manufacturing/packaging/formulation sites
Endrin		XX ^b		XX ^b	Broad spectrum pesticide; pesticide manufacturing/packaging/formulation sites
Heptachlor epoxide		XX ^b	X ^b	XX ^b	Degradation product of heptachlor used as a contact and ingested soil insecticide for termites and household pesticide and chlordane also used as a termiticide; pesticide manufacturing/packaging/formulation sites for heptachlor and chlordane

Table 4-3. (continued)

Analyte	Rural	Agricultural	Suburban/ Urban	Industrial	Sources/Uses
Hexachlorobenzene		XX ^b		XX ^b	Fungicide used as seed protectant, used as chemical intermediate in production of many other organochlorine pesticides; pesticide manufacturing/packaging/formulation sites for a wide variety of organochlorine pesticides
Lindane ^e		XX ^b	X ^b	XX ^b	Seed and soil treatments for tobacco; foliage applications for fruit and nut trees and vegetables; wood preservative. pesticide manufacturing/packaging/formulation sites
Mirex		XX ^b	X ^b	XX ^b	Used extensively in Southeast and Gulf Coast states against fire ants; used in fire retardants and plastic polymerizer; pesticide manufacturing/packaging/formulation sites
Toxaphene		XX ^b		XX ^b	Insecticide for cotton; piscicide for rough fish; pesticide manufacturing/packaging/formulation sites
Organophosphate Pesticides					
Chlorpyrifos ^e		XX ^b	X ^b	XX ^b	Widely used on cotton, peanuts, and sorghum as well as fruits and vegetables; domestic household insecticide with lawn and garden applications. Use applications will change by the end of 2001. All residential use will end as will use on tomatoes. Use on apples and grapes will be greatly reduced (U.S. EPA, 2000b). Used as a termiticide in California; pesticide manufacturing/packaging/formulation sites
Diazinon ^e		XX ^b	X ^b	XX ^b	Widely used on a broad variety of fruits and vegetables, field crops, and pastureland; domestic household insecticide used for lawn and garden applications; pesticide manufacturing/packaging/formulation sites
Disulfoton ^e		XX ^b		XX ^b	Widely used as a side dressing, broadcast, and foliar spray and as a seed dressing; pesticide manufacturing/packaging/formulation sites
Ethion ^e		XX ^b	X ^b	XX ^b	Major use on citrus, fruit and nut trees, and vegetables. Domestic outdoor use around homes and lawns; pesticide manufacturing/packaging/formulation sites
Terbufos ^e		XX ^b		XX ^b	Used principally on corn, sugar beets, and grain sorghum; pesticide manufacturing/packaging/formulation sites
Chlorophenoxy Herbicides					
Oxyfluorfen ^e		XX ^b		XX ^b	Widely used to control grass and weeds in corn, cotton, soybeans, fruit and nut trees, and ornamental crops; pesticide manufacturing/packaging/formulation sites

Table 4-3. (continued)

Analyte	Rural	Agricultural	Suburban/ Urban	Industrial	Sources/Uses
Polycyclic Aromatic Hydrocarbons (PAHS)			X ^d	X ^d	Components of crude and refined petroleum and coal products; waste incineration, wood preservatives, creosote, coal tar, coal coking, urban runoff from asphalt, automobile tires and exhaust emissions, and petroleum spills; coal gasification sites, and petroleum refineries.
Polychlorinated Biphenyls (PCBs)			X ^d	X ^d	Produced as Arochlors for use as dielectric fluid in electrical transformers and as hydraulic fluid; leachate from land fills and Superfund sites.
Dioxins and Dibenzofurans			X ^d	X ^d	Industrial sites including bleached kraft paper mills, facilities handling 2,4,5-trichlorophenoxyacetic acid (2,4,5,-T), 2,4,5-trichlorophenol (2,4,5-TCP), silvex, hexachlorobenzene, pentachlorophenol, and PCBs.; Industrial and municipal combustors and incinerators

^a Tissue residue analysis is recommended if geologic characteristics suggest potential for elevated metal concentrations in water or sediment or if sources are identified in the watershed suggesting the presence of this target analyte at the sampling site.

^b Tissue residue analysis is recommended if use application of this pesticide has been reported in the watershed either from historic or current use data, if sources like pesticide production/packaging/formulation facilities exist in the watershed, or if the state has water and/or sediment data indicating the presence of this target analyte at the sampling site.

^c Tissue residue analysis is highly recommended at all sites.

^d Tissue residue analysis is recommended if sources as described in Sources/Uses column are identified in suburban/urban or industrial watershed or the state has water and/or sediment data indicating the presence of this analyte at the sampling site.

^e Pesticide with currently active registration

X = Analysis for target analyte should be considered if water and or sediment analysis results detect the target analyte or if historic or current use information provide evidence for the potential presence of this target analyte in the watershed.

XX = Analysis for target analyte is recommended for this land use type if historic or current use information provides evidence of the potential presence of this target analyte in the watershed.

XXX = Analysis for target analyte is highly recommended at all stations in all watershed types.

Rural. The major analytes of concern in rural waterbodies (i.e., watersheds with no past or current urban/suburban, industrial, or agricultural uses) are the metals, including arsenic, cadmium, mercury, and selenium. Weathering processes in certain geologic areas can result in elevated levels of arsenic, cadmium, mercury, and selenium in water and sediments. State agencies should also be aware of past land use patterns in what are now considered rural areas of their states. For example, abandoned mining sites may be a source of metal contamination via leaching from mine drainage or slag piles. Large areas east of the Appalachians were agricultural watersheds during the early to mid twentieth century. While some of this agriculture land is now suburban/urban in its use, other areas, particularly in the South, are reverting to forests that might at first glance be classified as rural use. Arsenic compounds were used as pesticides in the early

1900s, and, along with organochlorine pesticides, may still be present in farmland abandoned after the 1940s. States should also be aware that mercury has been identified in fish collected from what would be classified as rural or pristine areas of the Great Lakes basins and waterbodies in the northeastern and southeastern states remote from any obvious point sources of pollution. Mercury contamination in these areas seems to be facilitated through the atmospheric transport of this metal. Because mercury is the target analyte that has triggered issuance of the largest number of advisories in the United States (nearly 68 percent of all advisories nationwide) and because of the relatively low cost of chemical analysis for this analyte, EPA recommends that this metal be monitored at all rural sites, especially those where little or no monitoring data are available.

Depending on site-specific conditions and considerations, states may opt to analyze for mercury as well as a suite of other heavy metals that can be analyzed as a group at relatively low cost. The only target analyte metal that should not be analyzed for routinely in rural areas without other supporting data is tributyltin, which is typically found near boatyards and marinas or near wood preservative production facilities. States may include any of the recommended EPA target analytes and any additional target analytes in their screening programs when site-specific information on a rural watershed suggests that these contaminants may be present at levels of concern for human health.

Agricultural. The major analytes of concern in agricultural waterbodies (i.e., watersheds where past or current land use is dominated by agriculture) are the organochlorine and organophosphate pesticides and the chlorophenoxy herbicide, oxyfluorfen. These analytes fall into two categories, those with inactive registrations (i.e. banned or withdrawn from the market) and those with active registrations (endosulfan, lindane, dicofol, chlorpyrifos, diazinon, terbufos, ethion, disulfoton, and oxyfluorfen). Although use of some of the organochlorine pesticides was terminated more than 20 years ago in the United States (e.g., DDT, dieldrin, endrin, and mirex), these compounds still need to be monitored. Many of the organochlorine pesticides that are now banned were used in large quantities for over a decade and are still present in high concentrations at some sites. On a nationwide basis, chlordane and DDT, for example, are responsible for 3 and 1 percent, respectively, of the advisories currently in effect. For the pesticides with active registrations, use and rate application information maintained by the state's Department of Agriculture should be reviewed to identify watersheds where these pesticides are currently used and are likely to be present in aquatic systems as a result of agricultural runoff or drift. Unlike many of the historically used organochlorine pesticides, the pesticides in current use degrade relatively rapidly in the environment. In addition, federal regulations are in effect that set maximum application rates and minimize use near waterbodies. At the time of this writing, no fish consumption advisories for these analytes have yet been issued; however, state agencies should be aware of special circumstances that could result in accumulation in fish. In addition to accidental spills and misapplication, heavy and repeated rainfall shortly after application may wash these pesticides into streams. Signs of pesticide pollution may include erratic swimming behavior in fish as well as fish kills.

It is also important to note that pesticide uses and labels may change over time. All pesticides with active registrations are currently being reviewed by EPA under provisions of the Food Quality Protection Act of 1996. The state agency responsible for designing the fish contaminant monitoring program should be aware of all historic and current uses of each pesticide within its state, including the watersheds, application rates, and acreage where the pesticide has been or currently is applied to ensure that all potentially contaminated sites are included in the sampling plan. Because mercury contamination seems to be facilitated through atmospheric transport, because it has triggered issuance of the largest number of U.S. advisories, and because of the relatively low cost of chemical analysis for this analyte, EPA recommends that this metal be monitored at all agricultural sites, especially those for which little or no monitoring data are available. Additionally, states may also want to analyze for other metals (arsenic, cadmium, and selenium). States may include any of the recommended EPA target analytes and any additional target analytes in their screening programs when site-specific information on an agricultural watershed suggests that these contaminants may be present at levels of concern for human health.

Suburban/Urban. Water and sediment quality are often regularly monitored in suburban and urban areas, and selection of target analytes should be based on these data when available. Some suburban watersheds of today were agricultural watersheds during the early twentieth century. Arsenic compounds were widely used as pesticides in the early 1900s, as were organochlorine pesticides. These contaminants may still be present in farmland abandoned after the 1940s. As a result of the rapid population growth in recent years, other suburban areas have been built on former industrial sites, so historical information on land use should be obtained by states whenever possible and reviewed carefully during the target analyte selection process.

Several of the organophosphates as well as organochlorine pesticides have had wide use in control of pests around domestic structures as well as in lawn and garden applications (see Table 4-3). Chlorpyrifos and diazinon are currently used by pest control applicators and the general public (Robinson et al., 1994), and diazinon has been reported at high concentrations in effluents from POTWs in some suburban/urban areas (Amato et al., 1992; Burkhard and Jensen, 1993). Historically, chlordane was used extensively in termite control around homes and DDT was used as a general all-purpose insecticide. Nationally, chlordane and DDT are responsible for 3 and 1 percent, respectively, of the advisories currently in effect, and their use within suburban/urban watersheds should be considered as should the use of any of the pesticides registered for use around domestic structures or in lawn and garden applications. Depending on the proximity of some suburban/urban sites to industrial areas, states may also wish to review historic or current information on production sites associated with any of the pesticides, PAHs, PCBs, and dioxin/furans. Because of the historic and current uses of mercury in a variety of industrial processes, because it has triggered issuance of the largest number of U.S. advisories, and because of the relatively low cost of chemical analysis, EPA recommends that this metal be monitored at all suburban/urban sites, especially those where either little or no monitoring data

are available. States should include any of the recommended EPA target analytes and any additional target analytes in their screening programs when site-specific information on a suburban/urban watershed suggests that these contaminants may be present at levels of concern for human health.

Industrial. All of the recommended target analytes can enter waterbodies through releases from industrial processes, Superfund sites, or landfills. Often water and sediment data are available to help guide the selection of the target analytes that should be given high priority with respect to analysis. Selection of analytes for analysis in industrial watersheds should be guided by knowledge of the type of industrial production that has existed in the past or is currently present in the watershed. Historical information is particularly important since potential contaminants may still be present at abandoned industrial sites or contained in sediments in receiving waterbodies. Sources of these target analytes are listed in Section 4.3, which contains the individual target analyte profiles and descriptions of the types of industries that may contribute to releases of these specific pollutants. Again, the states should review all existing water and sediment quality data available before selecting the specific target analytes for analysis at each site. Because of the historic and current uses of mercury in a variety of industrial processes, because it has triggered issuance of the largest number of U.S. advisories, and because of the relatively low cost of chemical analysis, EPA recommends that this metal be monitored at all industrial sites, especially those where little or no monitoring data are available. The other metals, including tributyltin, should also be considered for analysis based on existence of industrial production facilities, waste disposal facilities (e.g., Superfund or hazardous waste sites, and landfills), or shipyards where these target analytes may have been released to the environment. With respect to the pesticides, sites of production, formulation, and packaging facilities can all potentially be sites for release of these contaminants into the surrounding environment. Petroleum refining and coal gasification and processing facilities can also be sites for discharges of PAHs. PCBs can be released from historic landfills where PCB-containing equipment was disposed of or from sites of historic PCB production or use. Dioxins and dibenzofurans are likely to be found in proximity to historic or current industrial sites such as bleached kraft paper mills or production facilities for 2,4,5-trichlorophenoxyacetic acid (2,4,5-T), 2,4,5-trichlorophenol (2,4,5-TCP), and/or silvex and medical, municipal, or industrial combustors or incinerators. States should include any of the recommended EPA target analytes and any additional target analytes in their screening programs when site-specific information on an industrial watershed suggests that these contaminants may be present at levels of concern for human health.

Specific factors that have been considered in the selection of the recommended 25 target analytes and sources for their release into the environment are summarized in the next section. Chemical pollutants that are currently under review by EPA's Office of Water for inclusion as recommended target analytes are discussed in Section 4.4.

4.3 TARGET ANALYTE PROFILES

4.3.1 Metals

Five metals—arsenic, cadmium, mercury, selenium, and tributyltin—are recommended as target analytes in screening studies. Arsenic, cadmium, and mercury have been included in at least five of the eight major fish contaminant monitoring programs reviewed by the 1993 Workgroup (see Appendix E). It should be noted, however, that with respect to arsenic, all monitoring programs measured total arsenic rather than inorganic arsenic. Selenium was monitored in four national monitoring programs. Tributyltin, a constituent in antifouling paints was not recommended for analysis in any of the national programs evaluated by the 1993 Workgroup. As of 1993, fish consumption advisories were in effect for arsenic, cadmium, mercury, selenium, and tributyltin in 1, 2, 29, 5, and 1 states, respectively (Table 4-2). As of 1998, fish advisories were in effect for arsenic, cadmium, mercury, and selenium in 3, 3, 40, and 11 states, respectively. No states had active advisories for tributyltin (U.S. EPA, 1999c). Also, with the exception of tributyltin, these metals have been identified as having the greatest potential toxicity resulting from ingestion of contaminated fish and shellfish (NAS, 1991).

4.3.1.1 Arsenic—

Arsenic is the twentieth most abundant element in the earth's crust and naturally occurs as a sulfide in a variety of mineral ores containing copper, lead, iron, nickel, cobalt, and other metals (Eisler, 1988; Merck Index, 1989; Woolson, 1975). Arsenic is released naturally to the atmosphere from volcanic eruptions and forest fires (Walsh et al., 1979) and to water via natural weathering processes (U.S. EPA, 1982b). Arsenic also has several major anthropogenic sources including industrial emissions from coal-burning electric generating facilities, releases, as a byproduct of nonferrous metal (gold, silver, copper, lead, uranium, and zinc) mining and smelting operations (Eisler, 1988; May and McKinney, 1981; NAS, 1977), releases associated with its production and use as a wood preservative (primarily as arsenic trioxide), and application as an insecticide, herbicide, algicide, and growth stimulant for plants and animals (Appendix F) (Eisler, 1988). Arsenic releases are also associated with leaching at hazardous waste disposal sites and discharges from sewage treatment facilities. Arsenic trioxide is the arsenic compound of chief commercial importance (U.S. EPA, 1982b) and was produced in the United States until 1985 at the ASARCO smelter near Tacoma, Washington. Arsenic is no longer produced commercially within the United States in any significant quantities, but arsenic compounds are imported into the United States primarily for use in various wood preservative and pesticide formulations.

The toxicity of arsenicals is highly dependent upon the nature of the compounds, and particularly upon the valency state of the arsenic atom (Frost, 1967; Penrose, 1974; Vallee et al., 1960). Typically, compounds containing trivalent (+3) arsenic are much more toxic than those containing pentavalent (+5) arsenic. The valency of the arsenic atom is a more important factor in determining toxicity than the

organic or inorganic nature of the arsenic-containing compound (Edmonds and Francesconi, 1993). With respect to inorganic arsenic compounds, salts of arsenic acid (arsenates) with arsenic in the pentavalent state are less toxic than arsenite compounds with arsenic in the trivalent state (Penrose, 1974). Because some reduction of arsenate (pentavalent arsenic) to arsenite (trivalent arsenic) might occur in the mammalian body (Vahter and Envall, 1983), it would be unwise to disregard the possible toxicity of inorganic arsenic ingested in either valency state (Edmonds and Francesconi, 1993).

Seafood is a major source of trace amounts of arsenic in the human diet. However, arsenic in the edible parts of fish and shellfish is predominantly present as the arsenic-containing organic compound arsenobetaine (Cullen and Reimer, 1989; Edmonds and Francesconi, 1987a; NAS, 1991). Arsenobetaine is a stable compound containing a pentavalent arsenic atom, which has been shown to be metabolically inert and nontoxic in a number of studies (Cannon et al., 1983; Bos et al., 1985; Kaise et al., 1985; Sabbioni et al., 1991; Vahter et al., 1983) and is not generally considered a threat to human health (ATSDR, 1998a). Inorganic arsenic, although a minor component of the total arsenic content of fish and shellfish when compared to arsenobetaine, presents potential toxicity problems. To the degree that inorganic forms of arsenic are either present in seafood or, upon consumption, may be produced as metabolites of organic arsenic compounds in seafood, some human health risk, although small, would be expected (NAS, 1991).

Inorganic arsenic is very toxic to mammals and has been assigned to Toxicity Class I based on oral toxicity tests (U.S. EPA, 1998d). Use of several arsenical pesticides has been discontinued because of the health risks to animals and man. Inorganic arsenic also has been classified as a human carcinogen (A), and long-term effects include dermal hyperkeratosis, dermal melanosis and carcinoma, hepatomegaly, and peripheral neuropathy (IRIS, 1999) (Appendix G).

Total arsenic (inclusive of both inorganic and organic forms) has been included in five of the eight national monitoring programs evaluated by the 1993 Workgroup (Appendix E). Arsenic and arsenic-containing organic compounds have not been shown to bioaccumulate to any great extent in aquatic organisms (NAS, 1977). Experimental evidence indicates that inorganic forms of both pentavalent and trivalent arsenic bioaccumulate minimally in several species of finfish including rainbow trout, bluegill, and fathead minnows (ASTER, 1999). A bioconcentration factor (BCF) value of 350 was reported for the American oyster (*Crassostrea virginica*) exposed to trivalent arsenic (Zaroogian and Hoffman, 1982).

In 1984 and 1985, the U.S. Fish and Wildlife Service collected 315 composite samples of whole fish from 109 stations nationwide as part of the National Contaminant Biomonitoring Program (Schmitt and Brumbaugh, 1990). The authors reported the the maximum, geometric mean, and 85th percentile concentrations for total arsenic were 1.5, 0.14, and 0.27 ppm (wet weight), respectively. No information, however, was available on the percentage of inorganic arsenic in the fish sampled in the NCBP study. Kidwell et al. (1995)

conducted an analysis of total arsenic levels in bottom-feeding and predator fish using the 1984-1985 data from the NCBP study. These authors reported that the mean total arsenic tissue concentrations of 0.16 ± 0.23 ppm in bottom feeders and 0.16 ± 0.14 ppm in predator fish were not significantly different.

Edmonds and Francesconi (1993) summarized existing data from studies conducted outside the United States comparing concentrations of total arsenic, organic arsenic, and inorganic arsenic in marine fish and shellfish. Inorganic arsenic was found to represent from 0 to 44 percent of the total arsenic in marine fish and shellfish species surveyed. Residue concentrations of inorganic arsenic in the tissues typically ranged from 0 to 5.6 ppm (wet weight basis); but were generally less than 0.5 ppm for most species. In a study of six species of freshwater fish monitored as part of the Lower Columbia River study, inorganic arsenic represented from 0.1 to 27 percent of the total arsenic, and tissue residues of inorganic arsenic ranging from 0.001 to 0.047 ppm (wet weight) were 100 times lower than those reported for marine species (Tetra Tech, 1995).

In 1993, only one state (Oregon) had an advisory in effect for arsenic contamination (RTI, 1993). As of 1998, there were three advisories in effect in three states (Louisiana, Oregon, and Washington) for this metal (U.S. EPA, 1999c). Because it is the concentration of inorganic arsenic in fish and shellfish that poses the greatest threat to human health, EPA recommends that total inorganic arsenic (not total arsenic) be analyzed in contaminant monitoring programs. A chemical analysis procedure for determining total inorganic arsenic residues in fish and shellfish tissues is provided in Appendix H. Total inorganic arsenic should be considered for inclusion in state fish and shellfish monitoring programs in areas where it occurs in geologic formations, sites where mining or smelter operations have occurred, or where its use is or has been extensive. States should contact their appropriate state agencies to obtain information on the historic and current uses of arsenic particularly as a wood preservative and in agricultural pesticides.

4.3.1.2 Cadmium—

Cadmium is commonly found in zinc, lead, and copper deposits (May and McKinney, 1981). It is released into the environment from several anthropogenic sources: smelting and refining of ores, electroplating, application of phosphate fertilizers, surface mine drainage (Frag et al., 1998; U.S. EPA, 1978), and waste disposal operations (municipal incineration and land application) (U.S. EPA, 1979a, 1987c). Cadmium is also used in the manufacture of paints, alloys, batteries, and plastics and has been used in the control of moles and plant diseases in lawns.

Cadmium is a cumulative human toxicant; it has been shown to cause renal dysfunction and a degenerative bone disease, Itai-Itai, in Japanese populations exposed via consumption of contaminated rice, fish, and water. Because cadmium is retained in the kidney, older individuals (over 40-50 years of age) typically have both the highest renal concentrations of cadmium and the highest prevalence of renal dysfunction (U.S. EPA, 1979a). Cadmium is a known

carcinogen in animals, and there is limited evidence of the carcinogenicity of cadmium or cadmium compounds in humans. It has been classified by EPA as a probable human carcinogen by inhalation (B1) (IRIS, 1999).

Cadmium has been found to bioaccumulate in fish and shellfish tissues in fresh water (Schmitt and Brumbaugh, 1990) and in estuarine/marine waters (NOAA, 1987, 1989a) nationwide. In 1984 and 1985, the U.S. Fish and Wildlife Service collected 315 composite samples of whole fish from 109 stations nationwide as part of the NCBP (Schmitt and Brumbaugh, 1990). The authors reported the maximum, geometric mean, and 85th percentile concentrations for cadmium were 0.22, 0.03, and 0.05 ppm (wet weight), respectively. In the NCBP study, geometric mean concentrations of cadmium in freshwater fish were found to have declined from 0.07 ppm in 1976 to 0.03 ppm in 1984 (Schmitt and Brumbaugh, 1990). This trend contradicts the general trend of increasing cadmium concentrations in surface waters, which Smith et al. (1987) attribute to increasing U.S. coal combustion (Schmitt and Brumbaugh, 1990). Kidwell et al. (1995) conducted an analysis of cadmium concentrations in bottom-feeding and predatory fish species using the 1984-1985 data from the NCBP study. These authors found that mean cadmium tissue concentration (whole fish samples) of 0.04 ± 0.05 ppm in bottom feeders (e.g., carp, white sucker, and channel catfish) was significantly higher than the mean cadmium tissue concentration of 0.01 ± 0.02 ppm found in predator fish (e.g., trout, walleye, largemouth bass).

In 1993, only two states (New York and Ohio) had issued fish advisories for cadmium contamination (RTI, 1993). As of 1998, there were seven advisories in effect in three states (Maine, New Jersey, and New York) for this heavy metal (U.S. EPA, 1999c). Two of these states, New York and New Jersey, have issued advisories for this metal in all of their marine coastal waters. Maine has a statewide wildlife advisory in effect for cadmium in moose liver and kidney tissue (U.S. EPA, 1999c). Cadmium should be considered for inclusion in all state fish and shellfish contaminant monitoring programs in areas where it occurs in geologic formations, where mining or smelter operations have occurred, or where its use is or has been extensive.

4.3.1.3 Mercury—

A major source of atmospheric mercury is the natural degassing of the earth's crust, amounting to 2,700 to 6,000 tons per year (WHO, 1990). Primary points of entry of mercury into the environment from anthropogenic sources include mining and smelting, industrial processes including chlorine-alkali production facilities and atmospheric deposition resulting from combustion of coal and other fossil fuels and municipal and medical refuse incinerators (U.S. EPA, 1997c; Glass et al., 1990). Primary industrial uses of mercury are in the manufacture of batteries, vapor discharge lamps, rectifiers, fluorescent bulbs, switches, thermometers, and industrial control instruments (May and McKinney, 1981), and these products ultimately end up in landfills or incinerators. Mercury has also been used as a slimicide in the pulp and paper industry, as an antifouling and mildew-proofing

agent in paints, and as an antifungal seed dressing (ATSDR, 1998; *Farm Chemicals Handbook*, 1989; Friberg and Vostal, 1972).

Although mercury use and losses from industrial processes in the United States have been reduced significantly since the 1970s, mercury contamination associated with increased fossil fuel combustion is of concern in some areas and may pose more widespread contamination problems in the future. An estimated 5,000 tons of mercury per year is released into the environment from fossil fuel burning (Klaassen et al., 1986). The best estimate of annual anthropogenic U.S. emissions of mercury in 1994-1995 was 158 tons. Of this, about 87 percent was released from combustion sources, including waste and fuel combustion. (U.S. EPA, 1997). There is also increasing evidence of elevated mercury concentrations in areas where acid rain is believed to be a factor (NESCAUM, 1998; Sheffy, 1987; Wiener, 1987). Volatilization from surfaces painted with mercury-containing paints, both indoors and outdoors, may have been a significant source in the past (Agocs et al., 1990; Sheffy, 1987). The United States estimated that 480,000 pounds of mercuric fungicides were used in paints and coatings in 1987 (NPCA, 1988). In July 1990, EPA announced an agreement with the National Paint and Coatings Association to cancel all registrations for use of mercury or mercury compounds in interior paints and coatings. In May 1991, the paint industry voluntarily canceled all remaining registrations for mercury in exterior paints.

Cycling of mercury in the environment is facilitated by the volatile character of its metallic form and by bacterial transformation of metallic and inorganic forms to stable alkyl mercury compounds, particularly in bottom sediments, which leads to bioaccumulation of mercury (Wood, 1974). Practically all mercury in fish tissue is in the form of methylmercury (Bache et al., 1971; Bloom, 1992; Kannan et al., 1998; Spry and Wiener, 1991), which is toxic to humans (NAS, 1991; Tollefson, 1989), with the percentage of methylmercury to total mercury in the muscle tissue increasing as the fish ages (Bache et al., 1971). Several studies have shown that mercury concentrations in fish tissue generally increase with age, and therefore size (length or weight), owing to methylmercury accumulation with increasing duration of exposure (Driscoll et al., 1994; Jackson, 1990; Johnson, 1987; Lange et al., 1993); however this relationship is not as strongly correlated in all environmental situations or for all fish species (Goldstein et al., 1996; Neumann et al., 1997).

EPA has classified methylmercury as a Group C, possible human carcinogen, based on inadequate data in humans and limited evidence in animals (Appendix G). No persuasive evidence of increased carcinogenicity attributable to methylmercury exposure was observed in three human studies; however, interpretation of these studies was limited by poor study design and other problems. Animal studies have shown significant increases in the incidences of kidney tumors in male, but not in female, mice (IRIS, 1999).

Both inorganic and organic forms of mercury are neurotoxicants. Fetuses exposed to organic mercury have been found to be born mentally retarded and

with symptoms similar to those of cerebral palsy (Marsh, 1987; U.S. EPA, 1997c). Individuals exposed to mercury via long-term ingestion of mercury-contaminated fish have been found to exhibit a wide range of symptoms, including numbness of the extremities, tremors, spasms, personality and behavior changes, difficulty in walking, deafness, blindness, and death (U.S. EPA, 1997c). Organomercury compounds were the causative agents of Minamata Disease, a neurological disorder reported in Japan during the 1950s among individuals consuming contaminated fish and shellfish (Kurland et al., 1960), with infants exposed prenatally found to be at significantly higher risk than adults. Another methylmercury poisoning incident involving fish and shellfish occurred in 1965 in Niigata, Japan. A third methylmercury poisoning incident occurred in the late 1960s and early 1970s in Iraq; however, this last incident was associated with the accidental consumption of seed grain treated with organomercury fungicide (U.S. EPA, 1997c). The EPA is especially concerned about evidence that the fetus is at increased risk of adverse neurological effects from exposure to methylmercury (e.g., Marsh et al., 1987; Piotrowski and Inskip, 1981; Skerfving, 1988; WHO, 1976, 1990; U.S. EPA, 1997c).

The EPA has set an interim Reference Dose (RfD) for methylmercury of $0.1 \mu\text{g}/\text{kg}\text{-d}$ (IRIS 1999). The National Academy of Sciences (NAS) conducted an independent assessment of the interim RfD. They concluded "On the basis of its evaluation, the committee's consensus is that the value of EPA's current RfD for methylmercury, $0.1 \mu\text{g}/\text{kg}$ per day, is a scientifically justifiable level for the protection of public health". However, the NAS recommended that the Iraqi study no longer be used as the scientific basis for the RfD. In addition, the NAS recommended that the developmental neurotoxic effects of methylmercury reported in the Faroe Islands study should be used as the basis for the derivation of the RfD." (NAS, 2000)

Mercury has been found in both fish and shellfish from estuarine/marine (NOAA, 1987, 1989a) and fresh waters (Schmitt and Brumbaugh, 1990) at diverse locations nationwide. In 1984 and 1985, the U.S. Fish and Wildlife Service collected 315 composite samples of whole fish from 109 stations nationwide as part of the National Contaminant Biomonitoring Program (NCBP) (Schmitt and Brumbaugh, 1990). The authors reported that the maximum, geometric mean, and 85th percentile concentrations for mercury were 0.37, 0.10, and 0.17 ppm (wet weight), respectively. In contrast to cadmium and selenium, concentrations of mercury in freshwater fish tissue did not decline between 1976 and 1984 (Schmitt and Brumbaugh, 1990). Kidwell et al. (1995) conducted an analysis of mercury levels in bottom-feeding and predator fish using the 1984-1985 data from the NCBP study. These authors reported that the mean mercury tissue concentration (whole fish samples) of 0.12 ± 0.08 ppm in predator fish (e.g., trout, walleye, largemouth bass) was significantly higher than the mean tissue concentration of 0.08 ± 0.006 ppm in bottom feeders (e.g., carp, white sucker, and channel catfish).

Mercury, the only metal analyzed as part of the EPA National Study of Chemical Residues in Fish, was detected at 92 percent of 374 sites surveyed. Maximum,

arithmetic mean, and median concentrations in fish tissue were 1.77, 0.26, and 0.17 ppm (wet weight), respectively (U.S. EPA, 1991h, 1992c, 1992d). Bahnick et al. (1994) analyzed the NSCRF data by fish species and reported that mean mercury concentrations in bottom feeders (whole body samples) were generally lower than concentrations for predator fish (fillet samples). Carp, white sucker, and channel catfish (bottom feeders) had average tissue concentrations of 0.11, 0.11, and 0.09 ppm, respectively. Largemouth bass, smallmouth bass, and walleye (predator species) had average tissue concentrations of 0.46, 0.34, and 0.52 ppm, respectively (Bahnick et al., 1994). With regard to the source of the mercury contamination, Bahnick et al. (1994) reported that the highest mean concentration of mercury was detected in fish sampled near public treatment works (0.59 ppm); however, background sites and sites near wood preserving facilities exhibited the second (0.34 ppm) and third (0.31 ppm) highest mean mercury concentrations. The authors also reported that most of the higher tissue concentrations of mercury were detected in freshwater fish samples collected in the Northeast.

Recently, the northeastern states and eastern Canadian provinces issued their own mercury study, including a comprehensive analysis of mercury concentrations in a variety of freshwater sportfish (NESCAUM, 1998). This study involved a large number of sampling sites, including remote lake sites that did not receive point source discharges. Top-level piscivores (i.e., predator fish), such as walleye, chain pickerel, and large and smallmouth bass, were typically found to exhibit the highest concentrations, with mean tissue residues greater than 0.5 ppm and maximum residues exceeding 2 ppm. One largemouth bass sample was found to contain 8.94 ppm of mercury, while a smallmouth bass sampled contained 5 ppm. A summary of the range and the mean concentrations found in eight species of sportfish sampled is shown in Table 4-4 (NESCAUM, 1998).

Table 4-4. Total Mercury and Methylmercury Concentrations in Estuarine Fish from South Florida

Species	Mean mercury concentration ^a (ppm) and range	Mean methylmercury ^a concentration (ppm) and range
Hardhead catfish	1.94 (0.44-4.64)	1.54 (0.18-4.42)
Gafftopsail catfish	3.0 (0.76-10.10)	1.86 (0.72-4.50)
Sand seatrout	2.41 (2.21-2.61)	2.04 (1.60-2.47)
Sand seaperch	0.48 (0.40-0.54)	0.42 (0.40-0.49)
Pinfish	0.54 (0.32-1.06)	0.44 (0.20-0.90)
White grunt	0.49 (0.28-1.03)	0.49 (0.31-0.99)
Lane snapper	0.57 (0.22-1.03)	0.58 (0.19-1.27)
Spot	0.29 (0.11-0.43)	0.24 (0.06-0.40)

^aConcentrations are in ppm (µg/g) wet weight basis.

Source: Kannan et al., 1998.

EPA's Office of Water also recently published results of a national survey of mercury concentrations in fish (U.S. EPA, 1999d). This survey compiled state data on tissue residue levels of mercury in fish analyzed by 39 states between 1990 and 1995. The range of mean mercury concentrations (ppm) for the nine major fish species reported were as follows: largemouth bass, 0.001-8.94; smallmouth bass, 0.008-3.34; walleye, 0.008-3.0; northern pike, 0.10-4.4; channel catfish, 0.001-2.57; bluegill sunfish, 0.001-1.68; common carp, 0.001-1.8; white sucker, 0.002-1.71; and yellow perch, 0.01-2.14. All mercury concentrations used in the study were expressed on a wet weight and fillet basis. While the majority of the finfish sampled were freshwater species, some estuarine and marine species were also included; however, the report excluded all nonfish species such as turtles, molluscs, and crustaceans. Although comparison of data between states was difficult because of differences in sampling strategies (representative versus targeted), differences in analytical procedures, and the fact that mercury concentrations may vary with age of the fish, the analysis did indicate that both the magnitude and variability of mercury concentrations were greater in higher trophic level fish species.

Another recent study was conducted to assess total mercury and methylmercury concentrations in estuarine fish from south Florida coastal waters (Kannan et al., 1998). The authors reported that concentrations of total mercury in fish muscle tissue ranged between 0.03 and 2.22 ppm (mean: 0.31 ppm) (wet weight basis), with methylmercury contributing 83 percent of the total mercury. The mean concentrations and range of total mercury and methylmercury in muscle tissue of different species collected from south Florida's coastal waters are shown in Table 4-4.

In another study, methylmercury concentrations in muscle tissue of nine species of sharks were analyzed from four different locations along the coast of Florida (Hueter et al., 1995). Muscle tissue methylmercury concentrations averaged 0.88 ppm (wet weight) and ranged from 0.06 to 2.87 ppm, with 31 percent of the samples tested exceeding 1 ppm. A positive correlation was found between methylmercury concentration and the body length (size) of the shark, such that sharks larger than 2 m in total length contained methylmercury concentrations >1 ppm. Sharks collected off the southern and southwestern coastal areas contained significantly higher concentrations than those caught in the northeast coastal region (Cape Canaveral and north). Methylmercury concentrations were highest in the Caribbean reef shark (*Carcharhinus perezii*). The two most abundant shark species in the U.S. East Coast commercial shark fishery, the sandbar (*C. plumbeus*) and blacktip (*C. limbatus*) sharks, are of special public health concern. Although the mean methylmercury concentration in the sandbar shark (0.77 ppm) was below the average for all sharks, sandbar shark tissues contained up to 2.87 ppm methylmercury, and 20.9 percent of the sampled fish exceeded 1 ppm. Of more concern is that 71.4 percent of the blacktip shark samples (mean, 1.3 ppm) exceeded 1 ppm methylmercury. The authors suggest that continued monitoring of methylmercury concentrations in various shark species is warranted, since these fish are taken in both recreational and commercial fisheries. Similarly, on the West Coast, Fairey et al. (1997) reported

that the highest concentrations of mercury found in all of the fish species sampled as part of a fish monitoring effort in the San Francisco Bay and Estuary were detected in leopard shark muscle tissue (1.26 ppm wet weight basis).

In 1993, 898 fish advisories had been issued in 29 states as a result of mercury contamination (see Figure 4-1). In particular, mercury was included in a large number of the fish advisories in effect for lakes in Minnesota, Wisconsin, and Michigan and for rivers and lakes in Florida (RTI, 1993). As of 1998, 1,931 advisories had been issued in 40 states for this metal, and mercury is responsible for more than 68 percent of all fish advisories issued in the United States. In addition, 10 states have statewide advisories in effect for mercury in freshwater lakes and/or rivers and 5 Gulf Coast states have statewide mercury advisories in effect for their coastal marine waters (U.S. EPA, 1999c).

Because of its widespread occurrence in fish across the United States, mercury should be monitored in all state fish and shellfish contaminant monitoring programs at all stations. Only one national program reviewed by the 1993 Workgroup—EPA 301(h) monitoring program—recommended analyzing specifically for methylmercury; however, six programs recommended analyzing for total mercury (Appendix E). Because of the higher cost of methylmercury analysis two to three times greater than for total mercury analysis). EPA recommends that total mercury be determined in state fish contaminant monitoring programs and the conservative assumption be made that all mercury is present as methylmercury so as to be most protective of human health. It should be noted that Bache et al. (1971) analyzed methylmercury concentrations in lake trout of known ages and found that methylmercury concentration and the ratio of methylmercury to total mercury increased with age. Relative proportions of methylmercury in fish varied between 30 and 100 percent, with methylmercury concentrations lower than 80 percent occurring in fish 3 years of age or younger. Thus, when high concentrations of total mercury are detected, and if resources are sufficient, states may wish to repeat sampling and obtain more specific information on actual concentrations of methylmercury in various age or size classes of fish.

4.3.1.4 Selenium—

Selenium is a natural component of many soils, particularly in the west and southwest regions of the United States (NAS, 1991). It enters the environment primarily via emissions from oil and coal combustion (May and McKinney, 1981; Pillay et al., 1969). Selenium is an essential nutrient but is toxic to both humans and animals at high concentrations (NAS, 1991). Long-term adverse effects from ingestion by humans have not been studied thoroughly. EPA has determined that the evidence of carcinogenicity of selenium in both humans and animals is inadequate and, therefore, has assigned this metal a D carcinogenicity classification (IRIS, 1999).

Selenium is frequently detected in ground and surface waters in most regions of the United States and has been detected in marine fish and shellfish (NOAA,

4. TARGET ANALYTES

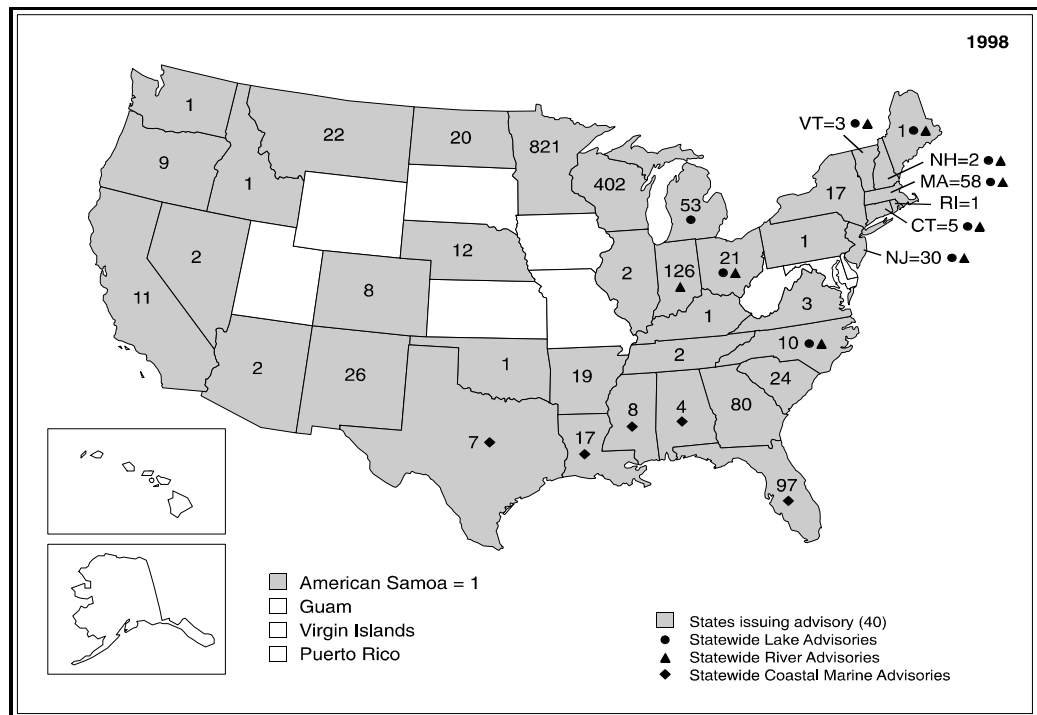
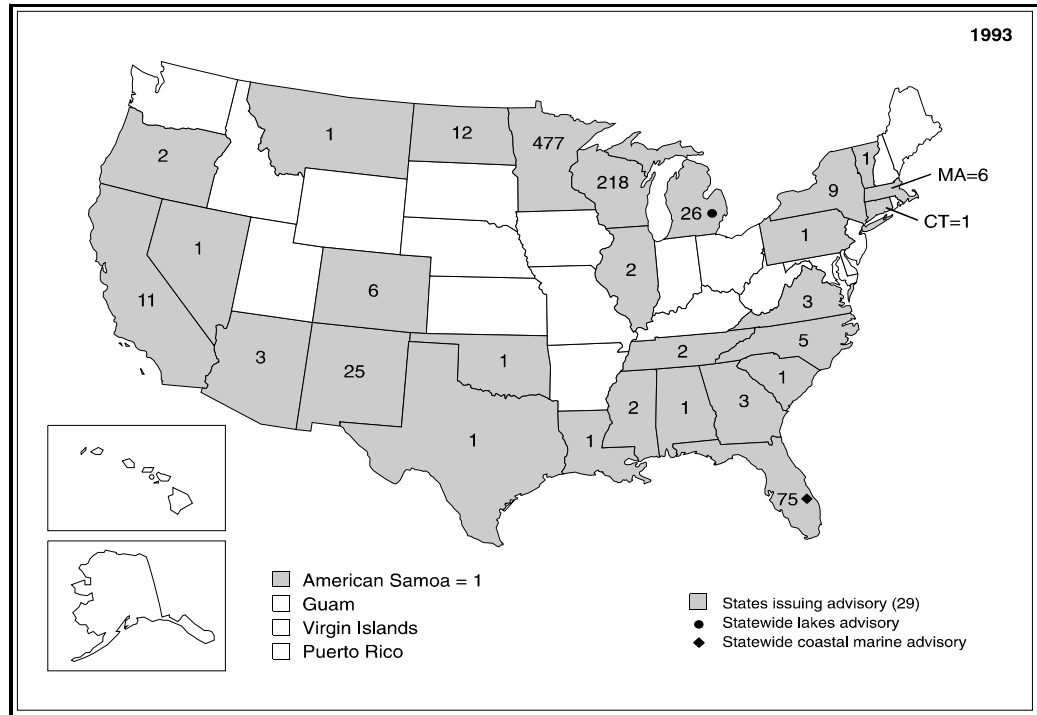

Figure 4-1. States issuing fish and shellfish advisories for mercury.

1987, 1989a) and in freshwater fish (Schmitt and Brumbaugh, 1990) from several areas nationwide. In 1984 and 1985, the U.S. Fish and Wildlife Service collected 315 composite samples of whole fish from 109 stations nationwide as part of the National Contaminant Biomonitoring Program (Schmitt and Brumbaugh, 1990). The authors reported the maximum, geometric mean, and 85th percentile concentrations for selenium were 2.30, 0.42, and 0.73 ppm (wet weight), respectively. Kidwell et al. (1995) conducted an analysis of selenium concentrations in bottom-feeding and predator fish using the 1984-1985 data from the NCBP study. Mean selenium tissue concentrations (whole fish samples) were not significantly different in bottom feeders (0.50 ± 0.41 ppm) as compared to predator fish (0.50 ± 0.42 ppm). Like cadmium, concentrations of selenium declined in fish tissues between 1976 and 1984 (Schmitt and Brumbaugh, 1990).

In a more recent study (May 1993 to January 1994), selenium concentrations in the tissues of fish from the Pigeon River and Pigeon Lake in Michigan were examined. Mean selenium concentrations in white sucker fillets were 0.49 ± 0.19 , 1.8 ± 0.96 , and 1.7 ± 0.80 ppm (wet weight) in samples taken from the Upper Pigeon River, Lower Pigeon River, and Pigeon Lake, respectively. At these same locations, northern pike fillets contained selenium concentrations of 0.88 ± 0.22 , 1.1 ± 0.91 , and 2.2 ± 0.90 ppm (wet weight), respectively (Besser et al., 1996). This study was conducted to assess the potential hazard of selenium leaching from a coal fly ash disposal area.

Selenium was monitored in four national fish contaminant monitoring programs reviewed by the EPA 1993 Workgroup (Appendix E). Definitive information concerning the chemical forms of selenium found in fish and shellfish is not available (NAS, 1976, 1991).

In 1993, five states (California, Colorado, North Carolina, Texas, and Utah) had issued advisories for selenium contamination in fish (RTI, 1993). As of 1998, there were 11 advisories in effect in these same five states for this heavy metal (U.S. EPA, 1999c). These advisories include one wildlife advisory in Nevada for selenium in several species of waterfowl. Selenium should be considered for inclusion in all state fish and shellfish monitoring programs in areas where it occurs in geologic formations (particularly in the western and southwestern states) and near sites where oil or coal combustion currently occurs or historically has occurred.

4.3.1.5 Tributyltin Compounds—

Tributyltin compounds belong to the organometallic family of tin compounds that have been used as biocides, disinfectants, and antifoulants. Antifoulant paints containing tributyltin compounds were first registered for use in the United States in the early 1960s (Appendix F). Tributyltin compounds are used in paints applied to boat and ship hulls as well as to crab pots, fishing nets, and buoys to retard the growth of fouling organisms. These compounds were also registered for use as wood preservatives, disinfectants, and biocides in cooling towers, pulp and paper mills, breweries, leather processing facilities, and textile mills (U.S. EPA, 1988c).

Tributyltin compounds are acutely toxic to aquatic organisms at concentrations below 1 ppb and are chronically toxic to aquatic organisms at concentrations as low as 0.002 ppb (U.S. EPA, 1988c). EPA initiated a Special Review of tributyltin compounds used as antifoulants in January of 1986 based on concerns over its adverse effects on nontarget aquatic species. Shortly thereafter the Organotin Antifouling Paint Control Act (OAPCA) was enacted in June 1988, which contained interim and permanent tributyltin use restrictions as well as environmental monitoring, research, and reporting requirements. The Act established interim release rate restrictions under which only tributyltin-containing products that do not exceed an average daily release rate of 4 micrograms organotin/cm²-d can be sold or used. The OAPCA also contained a permanent provision to prohibit the application of tributyltin antifouling paints to non-aluminum vessels under 25 meters (82 feet) long (U.S. EPA, 1988c).

Tributyltin oxide appears to be toxic to animals, with oral LD₅₀s ranging between 52 and 194 mg/kg (ATSDR, 1992; HSDB, 1999; WHO, 1999). Immunotoxicity is the critical effect produced by chronic exposure to tributyltin. Insufficient data are available to evaluate the carcinogenicity of tributyltin oxide compounds; therefore, EPA has listed this compound in Group D (Appendix G) (IRIS, 1999).

Tributyltins have been found to bioaccumulate in fish, bivalve mollusks, and crustaceans. Bioconcentration factors have been reported to range from 200 to 4,300 for finfish, from 2,000 to 6,000 for bivalves, and a BCF value of 4,400 was reported for crustaceans (U.S. EPA, 1988c). Tributyltin used to control marine fouling organisms in an aquaculture rearing pen has been found to bioaccumulate in fish tissue (Short and Thrower, 1987a and 1987b). Tsuda et al. (1988) reported a BCF value of 501 for tributyltin in carp (*Cyprinus carpio*) muscle tissue. Martin et al. (1989) reported a similar BCF value of 406 for tributyltin in rainbow trout (*Salmo gairdneri*) and Ward et al. (1981) reported a BCF value of 520 for the sheepshead minnow (*Cyprinodon variegatus*). In an environmental monitoring study conducted in England, a BCF value of 1,000 was reported for tributyltin in seed oysters (*Crassostrea gigas*) (Ebdon et al., 1989).

Tributyltin was not monitored in any national fish contaminant monitoring program evaluated by the EPA 1993 Workgroup (Appendix E). In 1993, only one state, Oregon, had an advisory in effect for tributyltin contamination in shellfish (RTI, 1993). As of 1998, there were no active fish advisories in effect for tributyltin, since the advisory in Oregon was rescinded (U.S. EPA, 1999c).

Tributyltin compounds should be considered for inclusion in all state fish and shellfish contaminant monitoring programs, particularly in states with coastal waters, states bordering the Great Lakes, or states with large rivers where large ocean-going vessels are used for commerce. Tributyltin concentrations have been reported to be highest in areas of heavy boating and shipping activities including shipyards, drydocks, and marinas where tributyltin-containing antifouling paints are often removed and reapplied. Before recoating, old paint containing tributyltin residues is scraped from the vessel hull and these paint scrapings are sometimes washed into the water adjacent to the boat or shipyard despite the tributyltin label

prohibiting this practice (U.S. EPA, 1988c). Tributyltin should be considered for inclusion in state fish and shellfish monitoring programs in areas where its use is or has been extensive. States should contact their appropriate agencies to obtain information on the historic and current uses of tributyltin, particularly with respect to its uses in antifouling paints and wood preservatives.

4.3.2 Organochlorine Pesticides

The following organochlorine pesticides and metabolites are recommended as target analytes in screening studies: total chlordane (sum of cis- and trans-chlordane, cis- and trans-nonachlor, and oxychlordane), total DDT (sum of 2,4'- and 4,4'-homologues of DDT, DDD, and DDE), dicofol, dieldrin, endosulfan I and II, endrin, heptachlor epoxide, hexachlorobenzene, lindane (γ -hexachlorocyclohexane), mirex, and toxaphene (see Appendix F). Mirex is of particular concern in the Great Lakes states and the southeast states (NAS, 1991). All of these compounds are neurotoxins and most are known or suspected human carcinogens (IRIS, 1999; Sax, 1984).

With the exception of endosulfan I and II, dicofol, and total DDT, each of the pesticides on the recommended target analyte list (Table 4-1) had been included in at least four major fish contaminant monitoring programs (Appendix E), and seven of the compounds had triggered at least one state fish consumption advisory in 1993 (Table 4-2). Although use of some of these pesticides has been terminated or suspended within the United States for over 25 years (Appendix F), these compounds still require long-term monitoring. Many of the organochlorine pesticides that are now banned were used in large quantities for over a decade and are still present in sediments at high concentrations. These organochlorine pesticides are not easily degraded or metabolized and, therefore, persist in the environment. These compounds are either insoluble or have relatively low solubility in water, but are quite lipid-soluble. Because these compounds are not readily metabolized or excreted from the body and are readily stored in fatty tissues, they can bioaccumulate to high concentrations through aquatic food chains to secondary consumers (e.g., fish, piscivorous birds, and mammals including humans).

Pesticides may enter aquatic ecosystems from point source industrial discharges or from nonpoint sources such as aerial drift and/or runoff from agricultural use areas, leaching from landfills, or accidental spills or releases. Agricultural runoff from crop and grazing lands is considered to be the major source of pesticides in water, with industrial waste (effluents) from pesticide manufacturing the next most common source (Li, 1975). Significant atmospheric transport of pesticides to aquatic ecosystems can also result from aerial drift of pesticides, volatilization from applications in terrestrial environments, and wind erosion of treated soil (Li, 1975). Once in water, pesticide residues may become adsorbed to suspended material, deposited in bottom sediment, or absorbed by organisms in which they are detoxified and eliminated or accumulated (Nimmo, 1985).

The reader should note that three of the organochlorine pesticides still have active registrations: endosulfan, lindane, and dicofol. These pesticides are much less persistent in the environment and have a lower bioaccumulation potential than the banned organochlorines. However, agricultural runoff particularly during the period immediately after field application could result in significant levels of these pesticides in fish and shellfish tissues. States should contact their appropriate state agencies to obtain information on both the historic and current uses of these pesticides.

4.3.2.1 Chlordane (Total)—

Chlordane is a multipurpose insecticide that has been used extensively in home and agricultural applications in the United States for the control of termites and many other insects (Appendix F). This pesticide is similar in chemical structure to dieldrin, although less toxic (Toxicity Class II), and has been classified as a probable human carcinogen (B2) by EPA (Appendix G) (IRIS, 1999; Worthing, 1991).

Although the last labeled use of chlordane as a termiticide was phased out in the United States beginning in 1975, it has been monitored in seven national fish contaminant programs evaluated by the EPA 1993 Workgroup (Appendix E) and has been widely detected in freshwater fish (Schmitt et al., 1990) and in both estuarine/marine finfish (NOAA, 1987) and marine bivalves (NOAA, 1989a) at concentrations of human health concern. In 1984 and 1985, the U.S. Fish and Wildlife Service collected 321 composite samples of whole fish from 112 stations nationwide as part of the National Contaminant Biomonitoring Program (Schmitt et al., 1990). These authors reported the maximum and geometric mean concentrations for the five major degradation products of chlordane (*cis*-chlordane, *trans*-chlordane, *cis*-nonachlor, *trans*-nonachlor, and oxychlordane) were 0.66 and 0.03 ppm, 0.35 and 0.02 ppm, 0.45 and 0.02 ppm, 1.00 and 0.30 ppm, and 0.29 and 0.01 ppm (wet weight), respectively. Kidwell et al. (1995) conducted an analysis of all 1984-1985 data from the NCBP study on the major constituents of chlordane (including *cis*- and *trans*-chlordane, *cis*- and *trans*-nonachlor, and oxychlordane) in bottom-feeding and predator fish species. The authors reported there was no significant difference in residues in these two trophic groups of fish except for concentrations of *trans*-chlordane, which were significantly higher in the tissues of bottom feeders. Mean tissue concentrations of *cis*- and *trans*-chlordane, *cis*- and *trans*-nonachlor, and oxychlordane were 0.03 ± 0.06 , 0.02 ± 0.04 , 0.02 ± 0.04 , 0.03 ± 0.01 , and 0.01 ± 0.02 ppm, respectively, for bottom feeders as compared to 0.02 ± 0.04 , 0.01 ± 0.02 , 0.02 ± 0.03 , 0.03 ± 0.06 , and 0.01 ± 0.01 ppm, respectively, for predator species (Kidwell et al., 1995).

The *cis*- and *trans*-isomers of chlordane and *cis*- and *trans*-isomers of nonachlor, which are primary constituents of technical-grade chlordane, and oxychlordane, the major metabolite of chlordane, were also monitored as part of the EPA National Study of Chemical Residues in Fish (U.S. EPA, 1992c, 1992d). These compounds were detected in fish tissue at the following percentage of the 362

sites surveyed: *cis*-chlordane (64 percent), *trans*-chlordane (61 percent), *cis*-nonachlor (35 percent), *trans*-nonachlor (77 percent), and oxychlordane (27 percent) (U.S. EPA, 1992c, 1992d). The maximum, arithmetic mean, and median concentrations (wet weight) of *cis*-chlordane, *trans*-chlordane, *cis*-nonachlor, *trans*-nonachlor, and oxychlordane are summarized in Table 4-5. Mean total chlordane residues from the NSCRF study were highest in bottom feeders such as carp (0.067 ppm), white sucker (0.018 ppm), and channel catfish (0.054 ppm) as compared to predator fish such as largemouth bass (0.029 ppm), smallmouth bass (0.004 ppb), and walleye (0.004 ppm) (Kuehl et al., 1994).

Table 4-5. Chlordane Constituent Concentrations^a Detected in the EPA National Study of Chemical Residues in Fish

Chlordane constituent or metabolite	Maximum	Arithmetic mean	Median
<i>cis</i> -Chlordane	0.378	0.021	0.004
<i>trans</i> -Chlordane	0.310	0.017	0.003
<i>cis</i> -Nonachlor	0.127	0.009	ND
<i>trans</i> -Nonachlor	0.477	0.031	0.009
Oxychlordane	0.243	0.005	ND

ND = Not detected.

^aConcentrations are in ppm (micrograms/g) on a wet weight basis.

Source: U.S. EPA, 1992c, 1992d.

In 1993, 120 fish advisories in 24 states had been issued as a result of chlordane contamination (see Figure 4-2). As of 1998, there were 104 advisories in effect in 22 states for this pesticide, and New York currently has a statewide advisory for chlordane in all waterfowl (U.S. EPA, 1999c). Because of its extensive use in termite control and its widespread detection in fish tissues, total chlordane (i.e., sum of *cis*- and *trans*-chlordane, *cis*- and *trans*-nonachlor, and oxychlordane) should be considered for inclusion in all state fish and shellfish contaminant monitoring programs (NAS, 1991). Monitoring sites in agricultural watersheds should be reviewed to determine the application rate and acreage where chlordane was used historically. In suburban/urban watersheds, the degree of historic use of chlordane as a termiticide around domestic structures should also be evaluated. Sites in industrial watersheds should be reviewed to identify historic sites of chlordane production, formulation, or packaging facilities.

4.3.2.2 DDT (Total)—

Although the use of DDT was terminated in the United States in 1972, DDT and its DDE and DDD metabolites persist in the environment and are known to bioaccumulate (Ware, 1978). DDT, DDD, and DDE have all been classified by EPA as probable human carcinogens (B2) (Appendix G) (IRIS, 1999).

4. TARGET ANALYTES

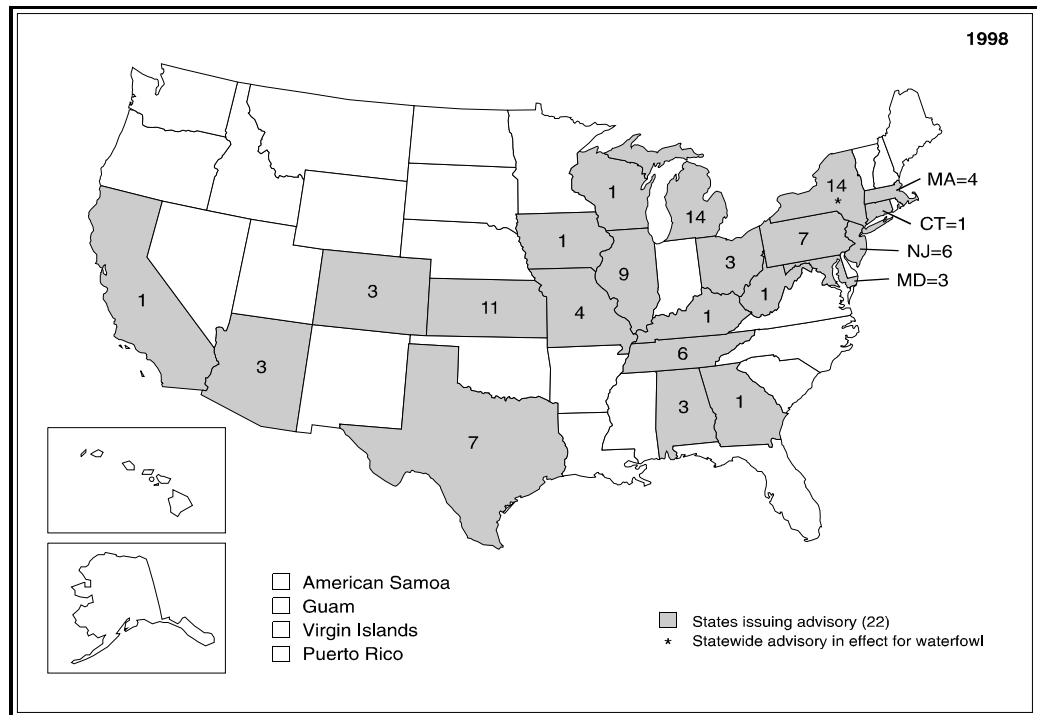
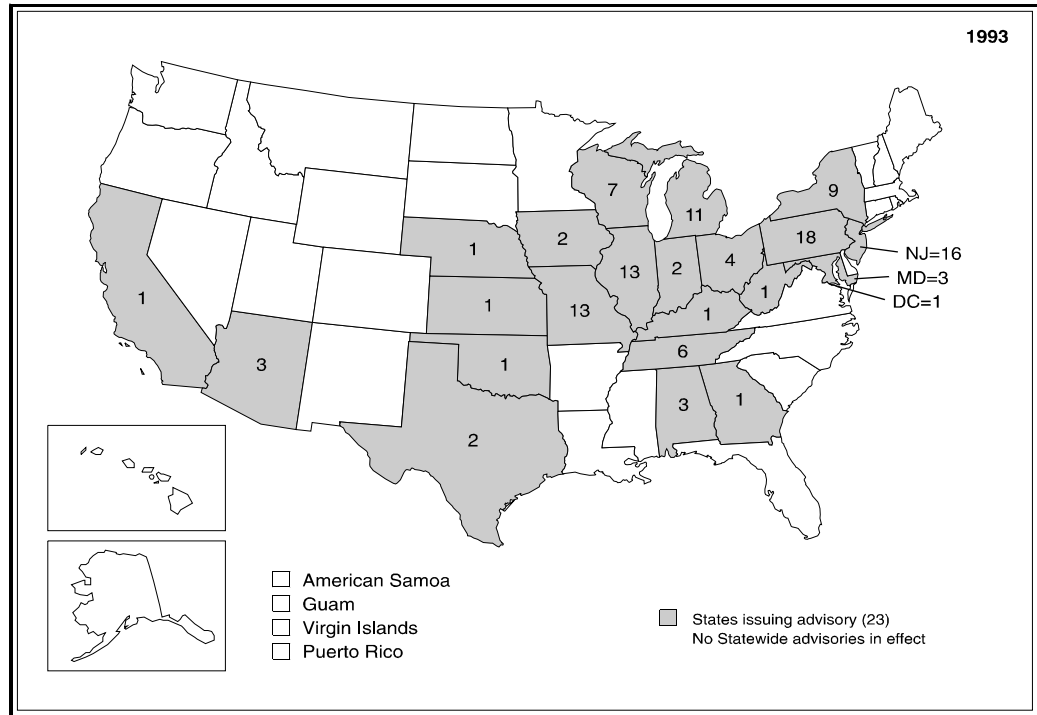

Figure 4-2. States issuing fish and shellfish advisories for chlordanes.

DDT or its metabolites have been included as target analytes in as many as seven major fish and shellfish monitoring programs (Appendix E) and contamination has been found to be widespread (NOAA, 1987, 1989a; Schmitt et al., 1990). In 1984 and 1985, the U.S. Fish and Wildlife Service collected 321 composite samples of whole fish from 112 stations nationwide as part of the National Contaminant Biomonitoring Program (Schmitt et al., 1990). Maximum and geometric mean tissue concentrations of DDT, DDE, and DDD in 1984 were 1.79 and 0.03 ppm, 4.74 and 0.19 ppm, and 2.55 and 0.06 ppm (wet weight), respectively (Schmitt et al., 1990). Kidwell et al. (1995) conducted an analysis of all 1984-1985 data from the NCBP study on DDT and its major metabolites (DDE and DDD) in bottom-feeding and predator fish. The authors reported that there was no significant difference in residues in these two trophic groups of fish. Mean tissue concentrations of DDT, DDE, and DDD were 0.03 ± 0.14 , 0.21 ± 0.46 , and 0.07 ± 0.21 ppm for bottom feeders as compared to 0.03 ± 0.06 , 0.24 ± 0.55 , and 0.06 ± 0.14 ppm for predator species, respectively. DDE, the only DDT metabolite surveyed in fish tissue in the EPA National Study of Chemical Residues in Fish, was detected at more sites than any other single chemical pollutant (99 percent of the 362 sites sampled) (U.S. EPA, 1992c, 1992d). Maximum, arithmetic mean, and median concentrations of DDE were 14, 0.295, and 0.058 ppm (wet weight), respectively. Mean DDE residues from the NSCRF study were highest in bottom feeders such as carp (0.42 ppm), white sucker (0.08 ppm), and channel catfish (0.63 ppm) as compared to predator species such as largemouth bass (0.06 ppm), smallmouth bass (0.03 ppb), and walleye (0.03 ppm) (Kuehl et al., 1994). In 1993, eight states (Alabama, Arizona, California, Delaware, Massachusetts, Nebraska, New York, and Texas) and the territory of American Samoa had fish consumption advisories in effect for DDT or its metabolites (RTI, 1993). As of 1998, there were 34 advisories in effect in 11 states and the territory of American Samoa for DDT and/or one of its metabolites, DDE or DDD (U.S. EPA, 1999c). In addition, New York has a statewide DDT advisory in effect for mergansers. Because of the extensive national use of this compound and its widespread detection in fish tissues, total DDT (i.e., sum of the 4,4'- and 2,4'-homologues of DDT and of its metabolites, DDE and DDD) should be considered for inclusion in all state fish and shellfish contaminant monitoring programs. Monitoring sites in agricultural watersheds should be reviewed to determine the application rate and acreage where DDT was applied historically. In suburban/urban watersheds, the degree of historic use of DDT in domestic home and garden applications should be evaluated. Sites in industrial watersheds should be reviewed to identify historic sites of DDT production, formulation, or packaging facilities.

4.3.2.3 Dicofol—

Dicofol, one of the three organochlorine target analytes with an active registration, is a miticide/pesticide that was first registered for use in 1957. Currently, dicofol is used primarily on cotton, apples, and citrus crops, mostly in California and Florida (U.S. EPA, 1998c). Dicofol is considered a DDT analog based on its structure and activity (Hayes and Laws, 1991). In the past, dicofol often contained 9 to 15 percent DDT and its analogs. In 1989, EPA required that these contaminants constitute less than 0.1 percent of dicofol (HSDB, 1993).

Historically, dicofol has been used to control mites on cotton and citrus (60 percent), on apples (10 percent), on ornamental plants and turf (10 percent), and on a variety of other agricultural products (20 percent) including pears, apricots, and cherries (*Farm Chemical Handbook*, 1989), as a seed crop soil treatment, on vegetables (e.g., beans and corn), and on shade trees (U.S. EPA, 1992c, 1992d).

Dicofol is moderately toxic to laboratory rats and has been assigned to EPA Toxicity Class III based on an oral LD₅₀ of 587 mg/kg in rats (U.S. EPA, 1998d) (Appendix F). Technical-grade dicofol induced hepatocellular (liver) carcinomas in male mice; however, results were negative in female mice and in rats (NCI, 1978) and in a second 2-year feeding study in both sexes of rats (U.S. EPA, 1998d). EPA has classified dicofol as a possible human carcinogen (C) (Appendix G) (U.S. EPA, 1998c).

Dicofol was recommended for monitoring by the EPA Office of Water as part of the Assessment and Control of Bioconcentratable Contaminants in Surface Waters Program and has been included in two other national monitoring programs (see Appendix E). Experimental evidence indicates this compound bioaccumulates extensively in bluegill sunfish (BCF from 6,600 to 17,000) (U.S. EPA, 1993a).

In the EPA National Study of Chemical Residues in Fish, dicofol was detected at 16 percent of the 374 sites monitored (U.S. EPA, 1992c, 1992d). Maximum, arithmetic mean, and median dicofol concentrations (wet weight basis) were 0.074 ppm, 0.001 ppm, and ND (not detectable). Dicofol concentrations were greater than the quantification limit (0.0025 ppm) in samples from only 7 percent of the sites. Most of the sites where dicofol was detected were in agricultural areas where citrus and other fruits and vegetables are grown (U.S. EPA, 1992c, 1992d). It should be noted that this national study did not specifically target agricultural sites where this pesticide historically had been or currently was used. Dicofol residues in fish could be much higher if sampling were targeted for pesticide runoff, particularly during the period immediately after field application. Mean dicofol residues from the NSCRF study were highest in bottom feeders such as carp (0.88 ppm), white sucker (0.48 ppm), and channel catfish (0.59 ppm) as compared to predator species such as largemouth bass (0.20 ppm), smallmouth bass (not detected), and walleye (not detected) (Kuehl et al., 1994).

In 1993, however, no consumption advisories were in effect for dicofol (RTI, 1993). As of 1998, there were no advisories in effect for this pesticide (U.S. EPA, 1999c). Dicofol should be considered for inclusion in state fish and shellfish contaminant monitoring programs, in areas where its use is or has been extensive. States should contact their appropriate state agencies to obtain information on the historic and current uses of this pesticide. Monitoring sites in agricultural watersheds should be reviewed to determine the application rate and acreage where dicofol is currently used and was used historically. Sites in industrial watersheds should be reviewed to identify historic and current sites of dicofol production, formulation, or packaging facilities.

4.3.2.4 Dieldrin—

Dieldrin is a chlorinated cyclodiene that was widely used in the United States from 1950 to 1974 as a broad spectrum pesticide, primarily on termites and other soil-dwelling insects and on cotton, corn, and citrus crops. Because the toxicity of this persistent pesticide posed an imminent danger to human health, EPA banned the production and most major uses of dieldrin in 1974, and, in 1987, all uses of dieldrin were voluntarily canceled by industry (see Appendix F).

Dieldrin has been classified by EPA as a probable human carcinogen (B2) (Appendix G) (IRIS, 1999) and has been identified as a human neurotoxin (ATSDR, 1991). Dieldrin has been included in seven national monitoring programs (Appendix E) and has been detected nationwide in freshwater finfish (Schmitt et al., 1990) and estuarine/marine finfish and shellfish (NOAA, 1987, 1989a). Because it is a metabolite of aldrin, the environmental concentrations of dieldrin are a cumulative result of the historic use of both aldrin and dieldrin (Schmitt et al., 1990).

In 1984 and 1985, the U.S. Fish and Wildlife Service collected 321 composite samples of whole fish from 112 stations nationwide as part of the National Contaminant Biomonitoring Program. Maximum and geometric mean tissue concentrations of dieldrin in 1984 were 1.39 and 0.04 ppm (wet weight), respectively (Schmitt et al., 1990). Kidwell et al. (1995) conducted an analysis of all 1984-1985 data from the NCBP study on dieldrin in bottom-feeding and predator fish. These authors reported there was no significant difference in residues in these two trophic groups of fish. Mean tissue concentrations of dieldrin were 0.05 ± 0.14 ppm for bottom feeders as compared to 0.04 ± 0.10 ppm for predator species. Dieldrin was also detected in fish tissue at 60 percent of the 362 sites surveyed as part of the EPA National Survey of Chemical Residues in Fish (U.S. EPA, 1992c, 1992d). Maximum, arithmetic mean, and median concentrations of dieldrin in fish tissues were 0.450, 0.028, and 0.004 ppm (wet weight), respectively. Mean dieldrin residues from the NSCRF study were highest in bottom feeders such as carp (0.045 ppm), white sucker (0.023 ppm), and channel catfish (0.015 ppm) as compared to predator species such as largemouth bass (0.005 ppm), smallmouth bass (0.002 ppm), and walleye (0.002 ppm) (Kuehl et al., 1994).

In 1993, three states (Arizona, Illinois, and Nebraska) had issued advisories for dieldrin contamination in fish (RTI, 1993). As of 1998, there were 23 advisories in effect in six states (Arizona, California, Colorado, Hawaii, Nebraska, and Texas) for this pesticide (U.S. EPA, 1999c). Dieldrin should be considered for inclusion in all state fish and shellfish contaminant monitoring programs in areas where its use as well as the use of aldrin have been extensive. States should contact their appropriate state agencies to obtain information on the historic uses of these two pesticides. Monitoring sites in agricultural watersheds should be reviewed to determine the application rate and acreage where dieldrin and aldrin were applied since dieldrin is a degradation product of aldrin. In suburban/urban watersheds, the degree of historic use of dieldrin and aldrin in domestic home and garden

applications should be evaluated. Sites in industrial watersheds should be reviewed to identify historic sites of dieldrin and aldrin production, formulation, or packaging facilities.

4.3.2.5 Endosulfan—

Endosulfan is a chlorinated cyclodiene pesticide that is currently in wide use primarily as a noncontact insecticide for seed and soil treatments (Appendix F). Two stereohomologues (I and II) exist and exhibit approximately equal effectiveness and toxicity (Worthing, 1991).

Endosulfan is highly toxic to laboratory animals and has been assigned to EPA Toxicity Class I (U.S. EPA, 1998d). To date, no studies have been found concerning carcinogenicity in humans after oral exposure to endosulfan (ATSDR, 1998c). EPA has classified endosulfan as Group E, evidence of noncarcinogenicity for humans (U.S. EPA, 1999b).

Agricultural runoff is the primary source of this pesticide in aquatic ecosystems. Endosulfan has been shown to be highly toxic to fish and marine invertebrates and is readily absorbed in sediments. It therefore represents a potential hazard in the aquatic environment (Sittig, 1980). However, data are insufficient to assess nationwide endosulfan contamination (NAS, 1991). Endosulfan has been included in one national fish contaminant monitoring program—the U.S. EPA 301(h) Program—the (U.S. EPA 301(h) Program—evaluated by the 1993 EPA Workgroup (Appendix E); however, no information was located related to its concentrations in fish or shellfish tissue.

In 1993, no consumption advisories were in effect for endosulfan I or II (RTI, 1993). As of 1998, there were no advisories in effect for this pesticide (U.S. EPA, 1999c). Endosulfan I and II should be considered for inclusion in all state fish and shellfish contaminant monitoring programs in areas where its use is or has been extensive. States should contact their appropriate agencies to obtain information on the historic and current uses of this pesticide. Monitoring sites in agricultural watersheds should be reviewed to determine the application rate and acreage where endosulfan currently is used and was used historically. Sites in industrial watersheds should be reviewed to identify historic and current sites of endosulfan production, formulation, or packaging facilities.

4.3.2.6 Endrin—

Endrin is a chlorinated cyclodiene that historically was widely used as a broad spectrum pesticide. Endrin was first registered for use in the United States in 1951. However, recognition of its long-term persistence in soil and its high levels of mammalian toxicity led to restriction of its use beginning in 1964 and 1979 (U.S. EPA, 1980a; 44 FR 43632) and to final cancellation of its registration in 1984 (U.S. EPA, 1984a) (Appendix F).

Endrin is highly toxic to humans (EPA Toxicity Class I) (U.S. EPA, 1998d), with acute exposures affecting the central nervous system primarily (Sax, 1984). At present, evidence of both animal and human carcinogenicity of endrin is considered inadequate, and EPA has classified endrin in Group D, not classifiable as to human carcinogenicity insufficient information available (Appendix G) (IRIS, 1999).

Although endrin has been included in five national fish contaminant monitoring programs (Appendix E), it has not been found widely throughout the United States. In 1984 and 1985, the U.S. Fish and Wildlife Service collected 321 composite samples of whole fish from 112 stations nationwide as part of the National Contaminant Biomonitoring Program (Schmitt et al., 1990). Endrin was detected in freshwater fish at only 29 percent of 112 stations sampled in the NCBP study. Maximum and geometric mean tissue concentrations of endrin in 1984 were 0.22 and <0.01 ppm (wet weight), respectively (Schmitt et al. 1990). Endrin was also detected in freshwater and marine species at 11 percent of the 362 sites surveyed in the EPA National Study of Chemical Residues in Fish (U.S. EPA, 1992c, 1992d). Maximum, arithmetic mean, and median concentrations of endrin in fish tissues were 0.162 ppm, 0.002 ppm, and not detectable (wet weight), respectively. Mean endrin residues from the NSCRF study were highest in bottom feeders such as carp (0.0014 ppm), white sucker (0.0002 ppm), and channel catfish (0.009 ppm) as compared to predatory species such as largemouth bass (not detectable), smallmouth bass (not detectable), and walleye (not detectable) (Kuehl et al., 1994).

In 1993, no state had issued a fish advisory for endrin (RTI, 1993). As of 1998, there were no advisories in effect for this pesticide (U.S. EPA, 1999c). Endrin should be considered for inclusion in all state fish and shellfish contaminant monitoring programs in areas where its use has been extensive. States should contact their appropriate agencies to obtain information on the historic uses of this pesticide. Monitoring sites in agricultural watersheds should be reviewed to determine the application rate and acreage where endrin was used historically. Sites in industrial watersheds should be reviewed to identify historic sites of endrin production, formulation, or packaging facilities.

4.3.2.7 Heptachlor Epoxide—

Heptachlor epoxide is not a formulated pesticide but is a metabolic degradation product of the pesticides heptachlor and chlordane. It is also found as a contaminant in heptachlor and chlordane formulations (Appendix F). Heptachlor epoxide is also more toxic than either parent compound (ATSDR, 1993). Heptachlor has been used as a persistent, nonsystemic contact and ingested insecticide on soils (particularly for termite control) and seeds and as a household insecticide (Worthing, 1991). EPA suspended the major uses of heptachlor in 1978 (ATSDR, 1993). Acute exposures to high doses of heptachlor epoxide in humans can cause central nervous system effects (e.g., irritability, dizziness, muscle tremors, and convulsions (U.S. EPA, 1986c). In animals, liver, kidney, and blood disorders can occur (IRIS, 1999). Exposure to this compound

produced an increased incidence of liver carcinomas in rats and mice and hepatomas in female rats (IRIS, 1999). Heptachlor epoxide has been classified by EPA as a probable human carcinogen (B2) (Appendix G) (IRIS, 1999).

Heptachlor epoxide has been included in six national fish monitoring programs (Appendix E) and has been detected widely in freshwater finfish (Schmitt et al., 1990), but infrequently in bivalves and marine fish (NOAA, 1987, 1989a). In 1984 and 1985, the U.S. Fish and Wildlife Service collected 321 composite samples of whole fish from 112 stations nationwide as part of the National Contaminant Biomonitoring Program (Schmitt et al., 1990). Heptachlor epoxide was detected in freshwater fish at 49 percent of 112 stations sampled in the NCBP study. Maximum and geometric mean tissue concentrations of heptachlor epoxide in 1984 were 0.29 and 0.01 ppm (wet weight), respectively (Schmitt et al., 1990). Heptachlor epoxide also was detected in fish tissue at 16 percent of the 362 sites where it was surveyed in the EPA National Study of Chemical Residues in Fish (U.S. EPA, 1992c, 1992d). Maximum, arithmetic mean, and median concentrations of heptachlor epoxide were 0.063 ppm, 0.002 ppm, and not detectable (wet weight). It should be noted that one of the parent compounds, heptachlor was detected at only 2 percent of the 362 sites where it was surveyed at a maximum, arithmetic mean, and median concentration of 0.076, 0.0004 ppm, and not detectable, respectively. The five degradation products of chlordane were detected at from 27 to 77 percent of these same sites (see Section 4.3.2.1 for a discussion of chlordane). Mean heptachlor epoxide residues from the NSCRF study were highest in bottom feeders such as carp (0.004 ppm), white sucker (0.001 ppm), and channel catfish (0.0005 ppm) as compared to predator species such as largemouth bass (0.0003 ppm), smallmouth bass (0.00007 ppm), and walleye (0.0002 ppm) (Kuehl et al., 1994).

In 1993, only Nebraska had fish advisories for heptachlor epoxide contamination (RTI, 1993). As of 1998, there was only one advisory in effect, in Texas, for this pesticide degradation product (U.S. EPA, 1999c). Heptachlor epoxide should be considered for inclusion in all state fish and shellfish monitoring programs in areas where the use of heptachlor or chlordane have been extensive. States should contact their appropriate agencies to obtain information on the historic uses of these pesticides. Monitoring sites in agricultural watersheds should be reviewed to determine the application rate and acreage where heptachlor and chlordane were historically used since both of these pesticides degrade to heptachlor epoxide. In suburban/urban watersheds, the degree of historic use of heptachlor and chlordane in domestic home and garden applications should be evaluated. Sites in industrial watersheds also should be reviewed to identify historic sites of heptachlor and chlordane production, formulation, or packaging facilities.

4.3.2.8 Hexachlorobenzene—

Hexachlorobenzene is a fungicide that was widely used as a seed protectant in the United States until 1984 (Appendix F). The use of hexachlorobenzene and the presence of hexachlorobenzene residues in food are banned in many countries

including the United States (Worthing, 1991). Registration of hexachlorobenzene as a pesticide was voluntarily canceled in 1984 (Morris and Cabral, 1986).

The toxicity of this compound is minimal; it has been given an EPA toxicity classification of IV (i.e., oral LD₅₀ greater than 5,000 ppm in laboratory animals (U.S. EPA, 1998d). However, nursing infants are particularly susceptible to hexachlorobenzene poisoning as lactational transfer can increase infant tissue levels to two to five times maternal tissue levels (ATSDR, 1996). Hexachlorobenzene is a known animal carcinogen (ATSDR, 1996) and has been classified by EPA as a probable human carcinogen (B2) (Appendix G) (IRIS, 1999).

Of the chlorinated benzenes, hexachlorobenzene is the most widely monitored (Worthing, 1991). It was included as a target analyte in seven of the major monitoring programs reviewed by the 1993 Workgroup (Appendix E). In 1984 and 1985, the U.S. Fish and Wildlife Service collected 321 composite samples of whole fish from 112 stations nationwide as part of the National Contaminant Biomonitoring Program (Schmitt et al., 1990). Hexachlorobenzene was detected in freshwater fish at 19 percent of 112 stations sampled in the NCBP study. Maximum and geometric mean tissue concentrations of hexachlorobenzene in 1984 were 0.41 and <0.01 ppm (wet weight), respectively (Schmitt et al., 1990). Kidwell et al. (1995) conducted an analysis of all 1984-1985 data from the NCBP on hexachlorobenzene in bottom-feeding and predator fish. The authors reported that there was no significant difference in residues in these two trophic groups. Mean tissue concentrations of HCB were 0.00 ± 0.01 and 0.01 ± 0.04 ppm, respectively, for bottom feeders and predator species. Hexachlorobenzene also was detected in fish tissue at 46 percent of the 362 sites where it was surveyed in the EPA National Study of Chemical Residues in Fish (U.S. EPA, 1992c, 1992d). Maximum, arithmetic mean, and median concentrations were 0.913 ppm, 0.006 ppm, and not detectable (wet weight), respectively. Mean hexachlorobenzene residues from the NSCRF study were highest in bottom feeders such as carp (0.0036 ppm), white sucker (0.0036 ppm), and channel catfish (0.0024 ppm) as compared to predator species such as largemouth bass (0.0002 ppm), smallmouth bass (0.0004 ppm), and walleye (0.0001 ppm) (Kuehl et al., 1994).

In 1993, Louisiana and Ohio had issued advisories for hexachlorobenzene contamination in fish and shellfish (RTI, 1993). As of 1988, there were three advisories in effect in these two states for this pesticide (U.S. EPA, 1999c). Hexachlorobenzene should be considered for inclusion in all state fish and shellfish monitoring programs. Monitoring sites in agricultural watersheds should be reviewed to determine the application rate and acreage where hexachlorobenzene was historically used. Sites in industrial watersheds also should be reviewed to identify historic sites of hexachlorobenzene as well as other organochlorine pesticide production, formulation, or packaging facilities since hexachlorobenzene was used as an intermediate in the chemical synthesis of many organochlorine pesticides.

4.3.2.9 Lindane—

Lindane is a mixture of homologues of hexachlorocyclohexane (C₆H₆Cl₆), whose major component (≥99 percent) is the gamma isomer. It is commonly referred to as either γ-HCH (hexachlorocyclohexane) or γ-BHC (benzene hexachloride). Lindane is used primarily in seed treatments, soil treatments for tobacco transplants, foliage applications on fruit and nut trees and vegetables, and wood and timber protection. Lindane is used as a therapeutic scabicide, pediculicide, and ectoparasiticide for humans and animals (Merck Index 1989). Since 1985, many uses of lindane have been banned or restricted (see Appendix F) and its application is permitted only under supervision of a certified applicator (U.S. EPA, 1985c). In 1993, EPA issued a “Notice of Receipt of a Request for Amendments to Delete Uses” for several formulations of lindane provider, 99.5 percent technical, and dust concentrate, which would delete from the pesticide label most uses of lindane for agricultural crops and use on animals and humans (EPA 1993).

Lindane is a neurotoxin (assigned to EPA Toxicity Class II) (U.S. EPA, 1998d) and has been found to cause aplastic anemia in humans (Worthing, 1991). Lindane has been classified by EPA as a probable/possible human carcinogen (B2/C) (Appendix G) (U.S. EPA, 1999b).

Lindane has been included in seven major fish contaminant monitoring programs (Appendix E). This pesticide has been detected in freshwater fish (Schmitt et al., 1990) and in marine fish and bivalves (NOAA, 1987, 1989a) nationwide. In 1984 and 1985, the U.S. Fish and Wildlife Service collected 321 composite samples of whole fish from 112 stations nationwide as part of the National Contaminant Biomonitoring Program (Schmitt et al., 1990). Lindane was detected in freshwater fish at 47 percent of 112 stations sampled in the NCBP study. Maximum and geometric mean tissue concentrations of lindane in 1984 were 0.40 and <0.01 ppm (wet weight), respectively (Schmitt et al., 1990). Kidwell et al. (1995) conducted an analysis of all 1984-1985 data from the NCBP study on lindane in bottom-feeding and predator fish. These authors reported there was no significant difference in residues in these two trophic groups of fish. Lindane also was detected in fish tissue at 42 percent of 362 sites surveyed in the EPA National Study of Chemical Residues in Fish (U.S. EPA, 1992c, 1992d). Maximum, arithmetic mean, and median lindane concentrations were 0.083 ppm, 0.003 ppm, and not detectable (wet weight), respectively. Mean lindane residues from the NSCRF study were highest in bottom feeders such as carp (0.0043 ppm), white sucker (0.0017 ppm), and channel catfish (0.0032 ppm) as compared to predator species such as largemouth bass (0.00007 ppm), smallmouth bass (0.00015 ppm), and walleye (not detectable) (Kuehl et al., 1994).

In 1993, although it had been widely monitored and widely detected, no consumption advisories were in effect for lindane (RTI, 1993). As of 1998, there were no advisories in effect for this pesticide (U.S. EPA, 1999c). Lindane should be considered for inclusion in all state fish and shellfish monitoring programs in areas where its use has been extensive. States should contact their appropriate

agencies to obtain information on the historic and current uses of this pesticide. Monitoring sites in agricultural watersheds should be reviewed to determine the application rate and acreage where lindane was used historically. In suburban/urban watersheds, the degree of historic use of lindane in domestic home and garden applications should be evaluated. Sites in industrial watersheds should be reviewed to identify historic and current sites of lindane production, formulation, or packaging facilities.

4.3.2.10 Mirex—

Mirex is a chlorinated cyclodiene pesticide that was used in large quantities in the United States from 1962 through 1975 primarily for control of fire ants in the Southeast and Gulf Coast states and, more widely, under the name Dechlorane as a fire retardant and polymerizing agent in plastics (Kaiser, 1978; Kutz et al., 1985) (Appendix F).

Mirex has been assigned to EPA Toxicity Class II on the basis of an oral LD₅₀ in rats of 368 mg/kg (ATSDR, 1995; U.S. EPA, 1998d) (Appendix F). Mirex has been assigned a carcinogenicity classification of group B2, probable human carcinogen (HEAST, 1997). EPA instituted restrictions on the use of mirex in 1975, and, thereafter, the U.S. Department of Agriculture (USDA) suspended the fire ant control program (Hodges, 1977).

Mirex has been included in seven major fish contaminant monitoring programs (Appendix E). It has been found primarily in the Southeast, Gulf Coast, and the Great Lakes regions (Kutz et al., 1985; NAS, 1991; Schmitt et al., 1990). In 1984 and 1985, the U.S. Fish and Wildlife Service collected 321 composite samples of whole fish from 112 stations nationwide as part of the National Contaminant Biomonitoring Program (NCBP) (Schmitt et al., 1990). Mirex was detected in freshwater fish at 13 percent of 112 stations sampled in the NCBP study. Maximum and geometric mean tissue concentrations of mirex in 1984 were 0.44 and <0.01 ppm (wet weight), respectively (Schmitt et al., 1990). Kidwell et al. (1995) conducted an analysis of all 1984-1985 data from the NCBP study on mirex in bottom-feeding and predator fish. These authors reported there was no significant difference in residues in these two trophic groups of fish. Mean tissue concentrations of mirex were 0.00 ± 0.04 and 0.01 ± 0.05 ppm, respectively, for bottom feeders and predator species. Mirex also was detected in fish tissue at 38 percent of 362 sites surveyed in the EPA National Study of Chemical Residues in Fish (NSCRF) (U.S. EPA, 1992c, 1992d). Maximum, arithmetic mean, and median mirex concentrations were 0.225 ppm, 0.004 ppm, and not detectable (wet weight), respectively. Mean mirex residues from the EPA NSCRF study were highest in bottom feeders such as carp (0.0037 ppm), white sucker (0.0044 ppm), and channel catfish (0.0146 ppm) as compared to predator species such as largemouth bass (0.0002 ppm), smallmouth bass (0.002 ppm), and walleye (0.00008 ppm) (Kuehl et al., 1994).

In 1993, three states (New York, Ohio, and Pennsylvania) had issued fish advisories for mirex (RTI, 1993). As of 1998, there were 11 advisories in effect

in these same three states for this pesticide (U.S. EPA, 1999c). New York has a statewide advisory in effect for mergansers. Mirex should be considered for inclusion in all state fish and shellfish monitoring programs in areas where its use has been extensive. States should contact their appropriate agencies to obtain information on the historic uses of this pesticide. Monitoring sites in agricultural watersheds should be reviewed to determine the application rate and acreage where mirex was used historically. In suburban/urban watersheds, the degree of historic use of mirex in domestic home and garden applications should be evaluated. Sites in industrial watersheds should be reviewed to identify historic sites of mirex production, formulation, or packaging facilities.

4.3.2.11 Toxaphene—

Toxaphene is an organochlorine pesticide composed of a complex mixture of chlorinated camphenes (chlorinated bornanes and some bornenes) that was first registered for use in the United States in 1947. It was commercially produced by the chlorination of camphenes derived from pine trees. It has been estimated that the commercial mixture of toxaphene contained at least 670 congeners with the majority of these having 6 to 10 chlorines (Jansson and Wideqvist, 1983). Historically, this compound was used in the United States as an insecticide primarily on cotton (Hodges, 1977). In addition, toxaphene was used as a piscicide for rough fish in the 1950s and 1960s in North America and was the replacement for DDT after DDT's use was severely restricted in 1972 (Saleh, 1991). Partly as a consequence of the ban on the use of DDT imposed in 1972, toxaphene was for many years the most heavily used pesticide in the United States (Eichers et al., 1978). In 1982, toxaphene's registration for most uses was canceled (47 FR 53784) and all uses were banned in 1990 (55 FR 31164-31174). Toxaphene is a global pollutant whose chemical-physical properties make it a candidate for long-range atmospheric transport via the cold condensation effect once it is released into the environment (Wania and Mackay, 1993, 1996).

Like many of the other organochlorine pesticides, toxaphene has been assigned to EPA Toxicity Class II (U.S. EPA, 1998d) (Appendix F). Some components of toxaphene may accumulate in body fat. Toxaphene has been classified by EPA as a probable human carcinogen (B2) (Appendix G) (IRIS, 1999).

Toxaphene has been included in four major fish contaminant monitoring programs (Appendix E). It has been detected frequently in both freshwater fish (Schmitt et al., 1990) and estuarine species (NOAA, 1989a) but is only consistently found in Georgia, Texas, and California (NAS, 1991). In 1984 and 1985, the U.S. Fish and Wildlife Service collected 321 composite samples of whole fish from 112 stations nationwide as part of the National Contaminant Biomonitoring Program (Schmitt et al., 1990). Toxaphene was detected in freshwater fish at 69 percent of 112 stations sampled in the NCBP study. Maximum and geometric mean tissue concentrations of toxaphene in 1984 were 8.2 and 0.14 ppm (wet weight), respectively (Schmitt et al., 1990). Kidwell et al. (1995) conducted an analysis of all 1984-1985 data from the NCBP study on toxaphene in bottom-feeding and predatory fish species. These authors reported there was no significant difference

in residues in these two trophic groups of fish. Mean tissue concentrations of toxaphene were 0.19 ± 0.63 and 0.17 ± 0.35 ppm, respectively, for bottom feeders and predator species.

In 1993, two states (Arizona and Texas) had fish advisories in effect for toxaphene (RTI, 1993). As of 1988, there were six advisories in effect in four states (Arizona, Georgia, Oklahoma, and Texas) for this pesticide (U.S. EPA, 1999c). Toxaphene should be considered for inclusion in all state fish and shellfish monitoring programs in areas where its use has been extensive. States should contact their appropriate agencies to obtain information on the historic uses of this pesticide. Monitoring sites in agricultural watersheds should be reviewed to determine the application rate and acreage where toxaphene was used historically. Sites in industrial watersheds should be reviewed to identify historic sites of toxaphene production, formulation, or packaging facilities.

4.3.3 Organophosphate Pesticides

The following organophosphate pesticides are recommended as target analytes in screening studies: chlorpyrifos, diazinon, disulfoton, ethion, and terbufos (Appendix E). These pesticides share two distinct features that differentiate them from the organochlorines. Organophosphate pesticides are generally more acutely toxic to vertebrates than organochlorine pesticides and exert their toxic action by inhibiting the activity of cholinesterase (ChE), one of the vital nervous system enzymes. In addition, organophosphates are chemically unstable (they are all slowly hydrolyzed by water) and thus are less persistent in the environment. It is this latter feature that made them attractive alternatives to the organochlorine pesticides that were used extensively in agriculture from the 1940s to the early 1970s.

With the exception of chlorpyrifos, none of the organophosphates has been included in any of the national fish contaminant monitoring programs evaluated by the EPA 1993 Workgroup and none of these pesticides (including chlorpyrifos) has triggered state fish consumption advisories. All of the organophosphate pesticides have active pesticide registrations and have been recommended for monitoring because they have an EPA Toxicity Classification of I or II (Appendix F), BCFs >300, and a half-life of 30 days or more in the environment and their use profiles suggest they could be potential problems in some agricultural watersheds.

The target organophosphates are used in agriculture throughout the United States, particularly in areas under intensive cultivation (row crops, orchards, fruits, and vegetables). Bioconcentration studies indicate they can accumulate in fish and, because they are known human neurotoxins, the potential exists for human health effects from consuming contaminated fish. For this reason, federal regulations are in effect that set maximum application rates and minimize use near waterbodies. At the time of this writing, no fish consumption advisories for these target analytes have yet been issued; however, state agencies should be aware of special circumstances that could result in their accumulation in fish. In

addition to chemical spills and misapplications, heavy and repeated rainfall shortly after application may wash pesticides off of plants and into streams. Signs of acute organophosphate pollution may include erratic swimming behavior in fish or fish kills.

States should contact their appropriate agencies to obtain information on both the historic and current uses of these pesticides. With the exception of ethion, which is used almost exclusively on citrus, the target organophosphates are used on a wide variety of crops. In addition, chlorpyrifos and diazinon have significant uses in domestic and commercial pest control in suburban/urban areas (Robinson et al., 1994). If a state determines that high concentrations of these pesticides may be present in its agricultural watersheds, sampling should be conducted during late spring or early summer within 1 to 2 months following pesticide application to maximize detection of these compounds in fish tissues. In general, the organophosphates are degraded relatively rapidly in the environment and metabolized relatively rapidly by fish, so timing of the sampling program is a more important consideration for this class of pesticides. Additional discussion of appropriate sampling times for fish contaminant monitoring programs is provided in Section 6.1.1.5.

All of the target organophosphates are members of the organothiophosphate group of insecticides. They are all metabolized in the liver to their active form, referred to as an "oxon" (e.g., chlorpyrifos is activated to chlorpyrifos oxon) (Klaasen, 1996). The oxons are approximately 300- to 1,000-fold more toxic than the parent compounds; however, they are also less lipid-soluble than the parent compounds and, therefore, are expected to be less likely to bioaccumulate in fish tissue. In another laboratory study where chlorpyrifos was fed to channel catfish, only chlorpyrifos and its inactive metabolites were found; the oxon was not detected in any tissue (Barron et al., 1991). No information is available on the presence of the oxon metabolites in fish tissue for the other organophosphates.

Note: The potential human toxicity of the organophosphates is undergoing reassessment by EPA at this time as a result of the provisions of the Food Quality Protection Act of 1996. For more information, consult the EPA Office of Pesticide Programs webpage available on the Internet at:

<http://www.epa.gov.pesticides/op>.

4.3.3.1 Chlorpyrifos—

This organophosphate pesticide was first introduced in 1965 to replace the more persistent organochlorine pesticides (e.g., DDT) (U.S. EPA, 1986c) and has been used for a broad range of insecticide applications (Appendix F). Chlorpyrifos is used primarily to control soil and foliar insects on cotton, peanuts, and sorghum (Worthing, 1991; U.S. EPA, 1986c). Chlorpyrifos is also used to control root-infesting and boring insects on a variety of fruits (e.g., apples, bananas, citrus, grapes), nuts (e.g., almonds, walnuts), vegetables (e.g., beans, broccoli, brussel sprouts, cabbage, cauliflower, peas, and soybeans), and field crops (e.g., alfalfa and corn) (U.S. EPA, 1984c). As a household insecticide, chlorpyrifos has been

used to control ants, cockroaches, fleas, and mosquitoes (Worthing, 1991) and is registered for use in controlling subsurface termites in California (U.S. EPA, 1983a). Based on use application, 48 percent of chlorpyrifos use is agricultural and 52 percent is nonagricultural (U.S. EPA, 2000b). Chlorpyrifos is also used by the general public for home, lawn, and garden insect control (ATSDR, 1997).

Note: As a result of the reassessment conducted under the Food Quality Act of 1996, use patterns of chlorpyrifos will change significantly by the end of 2001. In particular, virtually all indoor and outdoor residential use will end, as well as all agricultural use on tomatoes. Agricultural use of chlorpyrifos on apples and grapes will be reduced substantially (U.S. EPA, 2000b).

Chlorpyrifos has a moderate mammalian toxicity and has been assigned to EPA Toxicity Class II based on oral feeding studies (U.S. EPA, 1998d). No carcinogenicity was found in chronic feeding studies with rats, mice, and dogs (U.S. EPA, 1983a). Because chlorpyrifos did not increase the incidence of cancer in feeding studies on rats and mice (U.S. EPA, 1999b, U.S. EPA, 2000b) EPA has classified chlorpyrifos in Group E (Appendix G) (U.S. EPA, 2000b). Experimental evidence indicates this compound bioaccumulates in rainbow trout (BCF from 1,280 to 3,903) (U.S. EPA, 1993a).

Chlorpyrifos has been included in one national monitoring program reviewed by the EPA 1993 Workgroup, the EPA National Study of Chemical Residues in Fish (NSCRF) (see Appendix E). In this study, chlorpyrifos was detected at 26 percent of sites sampled nationally (U.S. EPA, 1992c, 1992d). Eighteen percent of the sites with relatively high concentrations (0.0025 to 0.344 ppm) were scattered throughout the East, Midwest, and in California; the highest mean concentrations detected (0.060 to 0.344 ppm) were found either in agricultural areas or in urban areas with a variety of nearby industrial sources. Maximum, arithmetic mean, and median tissue concentrations (wet weight) of chlorpyrifos were 0.344 ppm, 0.004 ppm, and not detectable, respectively. Mean chlorpyrifos residues from the NSCRF study were highest in bottom feeders such as carp (0.0082 ppm), white sucker (0.0018 ppm), and channel catfish (0.007 ppm) as compared to predator species such as largemouth bass (0.00028 ppm), smallmouth bass (0.00008 ppm), and walleye (0.00004 ppm) (Kuehl et al., 1994). It should be noted that this national study did not specifically target agricultural sites where this pesticide historically had been used or is currently used. Chlorpyrifos residues in fish could be much higher if sampling were targeted for pesticide runoff, especially during the period immediately after field application.

In 1993, no consumption advisories were in effect for chlorpyrifos (RTI, 1993). As of 1998, there were no advisories in effect for this pesticide (U.S. EPA, 1999c). Chlorpyrifos should be considered for inclusion in state fish and shellfish contaminant monitoring programs in areas where its use is or has been extensive. States should contact their appropriate agencies to obtain information on the historic and current uses of this pesticide. Monitoring sites in agricultural watersheds should be reviewed to determine the application rate and acreage where chlorpyrifos is currently used or was used historically. In suburban/urban water-

sheds, the degree of historic and current use of chlorpyrifos in domestic home and garden applications should be evaluated. Sites in industrial watersheds also should be reviewed to identify historic and current sites of chlorpyrifos production, formulation, or packaging facilities.

4.3.3.2 Diazinon—

Diazinon is a phosphorothiate insecticide and nematicide that was first registered in 1952 for control of soil insects and pests of fruits, vegetables, tobacco, forage, field crops, range, pasture, grasslands, and ornamentals; for control of cockroaches and other household insects; for control of grubs and nematodes in turf; as a seed treatment; and for fly control (U.S. EPA, 1986d). Diazinon is also used by the general public for home, lawn, and garden insect control (Appendix F) (ATSDR, 1996).

Diazinon is moderately toxic to mammals and has been assigned to EPA Toxicity Class II based on oral toxicity tests (U.S. EPA, 1998d) (Appendix F). Diazinon was not found to be carcinogenic in rats and mice (ATSDR, 1996). Because of inadequate evidence of carcinogenicity, EPA has classified diazinon as “not likely to be a human carcinogen” (Appendix G) (U.S. EPA, 1998d). This compound is also highly toxic to birds, fish, and other aquatic invertebrates (U.S. EPA, 1986d).

Diazinon was not included in any national fish contaminant monitoring program evaluated by the EPA 1993 Workgroup (Appendix E). Experimental evidence indicates this compound accumulates in trout (BCF of 542) (U.S. EPA, 1993a).

In 1993, no consumption advisories were in effect for diazinon (RTI, 1993). As of 1998, there were no advisories in effect for this pesticide (U.S. EPA, 1999c). Diazinon should be considered for inclusion in state fish and shellfish contaminant monitoring programs in areas where its use is or has been extensive. States should contact their appropriate agencies to obtain information on the historic and current uses of this pesticide. Monitoring sites in agricultural watersheds should be reviewed to determine the application rate and acreage where diazinon is currently used or was used historically. In suburban/urban watersheds, the degree of historic and current use of diazinon in domestic home and garden applications should be evaluated. Sites in industrial watersheds should be reviewed to identify historic and current sites of diazinon production, formulation, or packaging facilities.

4.3.3.3 Disulfoton—

Disulfoton is a multipurpose systemic insecticide and acaricide first registered in 1958 for use as a side dressing, broadcast, or foliar spray in the seed furrow to control many insect and mite species and as a seed treatment for sucking insects (Appendix F) (*Farm Chemicals Handbook*, 1989).

Disulfoton is highly toxic to all mammalian systems and has been assigned to EPA Toxicity Class I on the basis of all routes of exposure (U.S. EPA, 1998d).

Disulfoton was not found to be carcinogenic in dogs, rats, or mice (ATSDR, 1995). Because of inadequate evidence of carcinogenicity, EPA has classified disulfoton as Group E, evidence of noncarcinogenicity for humans (Appendix G) (U.S. EPA, 1999b).

Disulfoton was not included in any national fish contaminant monitoring program evaluated by the EPA 1993 Workgroup (Appendix E). Experimental evidence indicates this compound accumulates in fish (BCF from 460 to 700) (U.S. EPA, 1993a).

In 1993, no consumption advisories were in effect for disulfoton (RTI, 1993). As of 1998, there were no advisories in effect for this pesticide (U.S. EPA, 1999c). Disulfoton should be considered for inclusion in state fish and shellfish contaminant monitoring programs in areas where its use is or has been extensive. States should contact their appropriate agencies to obtain information on the historic and current uses of this pesticide. Monitoring sites in agricultural watersheds should be reviewed to determine the application rate and acreage where disulfoton currently is used or was used historically. Sites in industrial watersheds also should be reviewed to identify historic and current sites of disulfoton production, formulation, or packaging facilities.

4.3.3.4 Ethion—

Ethion is a multipurpose insecticide and acaricide that has been registered since 1965 for use on a wide variety of nonfood crops (turf, evergreen plantings, and ornamentals), food crops (seed, fruit, nut, fiber, grain, forage, and vegetables), and for domestic outdoor uses around dwellings and for lawns (Appendix F) (*Farm Chemicals Handbook*, 1989). Application to citrus crops accounts for 86 to 89 percent of the ethion used in the United States. The remaining 11 to 14 percent is applied to cotton and a variety of fruit and nut trees and vegetables. Approximately 55 to 70 percent of all domestically produced citrus fruits are treated with ethion (U.S. EPA, 1989e).

Acute oral toxicity studies have shown that technical-grade ethion is moderately toxic to mammals (EPA Toxicity Class II) (U.S. EPA, 1998d). Ethion was not found to be carcinogenic in rats and mice (U.S. EPA, 1989e). EPA has classified ethion in Group E—evidence of noncarcinogenicity for humans (Appendix G) (U.S. EPA, 1999b).

Ethion was not included in any national fish contaminant monitoring program evaluated by the EPA 1993 Workgroup (Appendix E). Experimental evidence indicates this compound accumulates in bluegill sunfish (BCF from 880 to 2,400) (U.S. EPA, 1993a).

In 1993, no consumption advisories were in effect for ethion (RTI, 1993). As of 1998, there were no advisories in effect for this pesticide (U.S. EPA, 1999c). Ethion should be considered for inclusion in state fish and shellfish contaminant monitoring programs in areas where its use is or has been extensive. States

should contact their appropriate agencies to obtain information on the historic and current uses of this pesticide. Monitoring sites in agricultural watersheds should be reviewed to determine the application rate and acreage where ethion currently is used or was used historically. In suburban/urban watersheds, the degree of historic and current use of ethion in domestic home and garden applications should be evaluated. Sites in industrial watersheds also should be reviewed to identify historic and current sites of ethion production, formulation, or packaging facilities.

4.3.3.5 Terbufos—

Terbufos is a systemic organophosphate insecticide and nematicide registered in 1974 principally for use on corn, sugar beets, and grain sorghum. The primary method of application involves direct soil incorporation of a granular formulation (*Farm Chemicals Handbook*, 1989). Two soil metabolites of terbufos, terbufos sulfoxide and terbufos sulfone, are also toxic to humans and are found at sites where terbufos has been applied (U.S. EPA, 1995)

Terbufos is highly toxic to humans and has been assigned to EPA Toxicity Class I (U.S. EPA, 1998d) (Appendix F). Terbufos was not found to be carcinogenic in rats and mice (U.S. EPA, 1995j). EPA has assigned terbufos to carcinogenicity classification E, evidence of noncarcinogenicity for humans (U.S. EPA, 1998d) (Appendix G). Terbufos is also highly toxic to birds, fish, and other aquatic invertebrates (U.S. EPA, 1985d).

Terbufos was not included in any national fish contaminant monitoring program evaluated by the EPA 1993 Workgroup (Appendix E). Experimental evidence indicates this compound accumulates in fish (BCF from 320 to 1,400) (U.S. EPA, 1993a).

In 1993, no consumption advisories were in effect for terbufos (RTI, 1993). As of 1998, there were no advisories in effect for this pesticide (U.S. EPA, 1999c). Terbufos and its toxic metabolites should be considered for inclusion in state fish and shellfish contaminant monitoring programs in areas where its use is or has been extensive. States should contact their appropriate agencies to obtain information on the historic and current uses of this pesticide. Monitoring sites in agricultural watersheds should be reviewed to determine the application rate and acreage where terbufos currently is used or was used historically. Sites in industrial watersheds also should be reviewed to identify historic and current sites of terbufos production, formulation, or packaging facilities.

4.3.4 Chlorophenoxy Herbicides

Chlorophenoxy herbicides, which include oxyfluorfen, are nonselective foliar herbicides that are most effective in hot weather (Ware, 1978).

4.3.4.1 Oxyfluorfen—

Oxyfluorfen is a pre- and postemergence herbicide with an active registration that has been registered since 1979 for use to control a wide spectrum of annual broadleaf weeds and grasses in apples, artichokes, corn, cotton, jojoba, tree fruits, grapes, nuts, soybeans, spearmint, peppermint, and certain tropical plantation and ornamental crops (Appendix F) (*Farm Chemicals Handbook*, 1989).

Oxyfluorfen is of low toxicity to mammals (oral LD₅₀ in rats >5,000 mg/kg) and has been assigned to EPA Toxicity Class IV (U.S. EPA, 1998d) (Hayes and Lawes, 1991). There is also evidence of carcinogenicity (liver tumors) in mice (U.S. EPA, 1993a) and therefore oxyfluorfen has been classified by EPA as a possible human carcinogen (C) (Appendix G) (U.S. EPA, 1999b).

Oxyfluorfen was not included in any national fish contaminant monitoring program evaluated by the EPA 1993 Workgroup (Appendix E). Experimental evidence indicates this herbicide accumulates in bluegill sunfish (BCF from 640 to 1,800) (U.S. EPA, 1993a).

In 1993, no consumption advisories were in effect for oxyfluorfen (RTI, 1993). As of 1998, there were no advisories in effect for this herbicide (U.S. EPA, 1999c). Oxyfluorfen should be considered for inclusion in state fish and shellfish contaminant monitoring programs in areas where its use is or has been extensive. States should contact their appropriate agencies to obtain information on the historic and current uses of this pesticide. Monitoring sites in agricultural watersheds should be reviewed to determine the application rate and acreage where oxyfluorfen currently is used or was used historically. Sites in industrial watersheds also should be reviewed to identify historic and current sites of oxyfluorfen production, formulation, or packaging facilities.

4.3.5 Polycyclic Aromatic Hydrocarbons

PAHs are base/neutral organic compounds that have a fused ring structure of two or more benzene rings. PAHs are also commonly referred to as polynuclear aromatic hydrocarbons (PNAs). PAHs with two to five benzene rings (i.e., 10 to 24 skeletal carbons) are generally of greatest concern for environmental and human health effects (Benkert, 1992). These PAHs have been identified as the most important with regard to human exposure (ATSDR, 1995):

- Acenaphthene
- Acenaphthylene
- Anthracene
- Benz[*a*]anthracene
- Benzo[*a*]pyrene
- Benzo[*e*]pyrene
- Benzo[*b*]fluoranthene
- Benzo[*k*]fluoranthene
- Benzo[*j*]fluoranthene
- Benzo[*g,h,i*]perylene
- Chrysene
- Dibenz[*a,h*]anthracene
- Fluoranthene
- Fluorene
- Indeno[*1,2,3-cd*]pyrene
- Phenanthrene

- Pyrene.

The metabolites of many of the high-molecular-weight PAHs (e.g., benz[*a*]anthracene, benzo[*a*]pyrene, benzo[*b*]fluoranthene, benzo[*k*]fluoranthene, chrysene, dibenz[*a,h*]anthracene, indeno[1,2,3-*cd*]pyrene, and benzo[*g,h,i*]perylene) have been shown in laboratory test systems to be carcinogens, cocarcinogens, teratogens, and/or mutagens (Moore and Ramamoorthy, 1984; ATSDR 1995). Benzo[*a*]pyrene, one of the most widely occurring and potent PAHs, and six other PAHs (e.g., benz[*a*]anthracene, benzo[*b*]fluoranthene, benzo[*k*]fluoranthene, chrysene, dibenz[*a,h*]anthracene, indeno[1,2,3-*cd*]pyrene) have been classified by EPA as probable human carcinogens (B2) (IRIS, 1999). Evidence for the carcinogenicity of PAHs in humans comes primarily from epidemiologic studies that have shown an increased mortality due to lung cancer in humans exposed to PAH-containing coke oven emissions, roof-tar emissions, and cigarette smoke (ATSDR, 1995).

PAHs are ubiquitous in the environment and usually occur as complex mixtures with other toxic chemicals. They are components of crude and refined petroleum products and of coal. They are also produced by the incomplete combustion of organic materials. Many domestic and industrial activities involve pyrosynthesis of PAHs, which may be released into the environment in airborne particulates or in solid (ash) or liquid byproducts of the pyrolytic process. Domestic activities that produce PAHs include cigarette smoking, home heating with wood or fossil fuels, waste incineration, broiling and smoking foods, and use of internal combustion engines. Industrial activities that produce PAHs include wood preserving, coal coking; production of carbon blacks, creosote, and coal tar; petroleum refining; synfuel production from coal; and use of Soderberg electrodes in aluminum smelters and ferrosilicum and iron works (ATSDR, 1995; Neff, 1985). Historic coal gasification sites have also been identified as significant sources of PAH contamination (ATSDR, 1995).

Major sources of PAHs found in marine and fresh waters include biosynthesis (restricted to anoxic sediments), spillage and seepage of fossil fuels, discharge of domestic and industrial wastes, atmospheric deposition, and runoff (Neff, 1985). Urban stormwater runoff contains PAHs from leaching of asphalt roads, wearing of tires, deposition from automobile exhaust, and oiling of roadsides and unpaved roadways with crankcase oil (ATSDR, 1995; MacKenzie and Hunter, 1979). Solid PAH-containing residues from activated sludge treatment facilities have been disposed of in landfills or in the ocean (ocean dumping was banned in 1989). Although liquid domestic sewage contains <1 µg/L total PAH, the total PAH content of industrial sewage is 5 to 15 µg/L (Borneff and Kunte, 1965) and that of sewage sludge is 1 to 30 mg/kg (Grimmer et al., 1978; Nicholls et al., 1979).

In most cases, there is a direct relationship between PAH concentrations in river water and the degree of industrialization and human activity in the surrounding watersheds. Rivers flowing through heavily industrialized areas may contain 1 to

5 ppb total PAH, compared to unpolluted river water, ground water, or seawater that usually contains less than 0.1 ppb PAH (Neff, 1979).

PAHs can accumulate in aquatic organisms from water, sediments, and food. BCFs of PAHs in fish, crustaceans, and bivalves have frequently been reported to be in the range of 12 to 9,200 for fish, 200 to 134,248 for crustaceans, and 8 to 242 for bivalves based on short-term exposure studies typically less than 7 days duration (Eisler, 1987). In general, bioconcentration was greater for the higher molecular weight PAHs than for the lower molecular weight PAHs. Biotransformation by the mixed function oxidase system in the fish liver can result in the formation of carcinogenic and mutagenic intermediates, and exposure to PAHs has been linked to the development of tumors in fish (Eisler, 1987). The ability of fish to metabolize PAHs probably explains why benzo[a]pyrene frequently is not detected or is found only at very low concentrations in fish from areas heavily contaminated with PAHs (Varanasi and Gmur, 1980, 1981).

Sediment-associated PAHs can be accumulated by bottom-dwelling invertebrates and fish (Eisler, 1987). For example, Great Lakes sediments containing elevated levels of PAHs were reported by Eadie et al. (1983) to be the source of the body burdens of the compounds in bottom-dwelling invertebrates. Similarly, Varanasi et al. (1985) found that benzo[a]pyrene was accumulated in fish, amphipod crustaceans, shrimp, and clams when estuarine sediment was the source of the compound. Approximate tissue-to-sediment ratios were 0.6 to 1.2 for amphipods, 0.1 for clams, and 0.05 for fish and shrimp. Although fish and most crustaceans evaluated to date have the mixed function oxidase system required for biotransformation of PAHs, many molluscs lack this system and are unable to metabolize PAHs efficiently (Varanasi et al., 1985). More important, PAHs induce mixed function oxidase enzymes (and thus their own biotransformation) in fish and other vertebrates, but not in molluscs and crustaceans (Stegeman and Lech, 1991). The resulting dramatic difference in biotransformation means that in PAH-contaminated waters, fish may show little or no accumulation of PAHs, while bivalve molluscs and crustaceans are heavily contaminated. Varanasi et al. (1985) ranked benzo[a]pyrene metabolism by aquatic organisms as follows: fish > shrimp > amphipod crustaceans > clams. Half-lives for elimination of PAHs in fish ranged from less than 2 days to 9 days (Niimi, 1987). NAS (1991) reported that PAH contamination in bivalves has been found in all areas of the United States. If PAHs are selected as a target analyte to be monitored at a site, primary preference should be given to selection of a bivalve mollusc (clam, oyster, mussel) as the target species, secondary preference should be given to a crustacean (shrimp, lobster, crab) (if available), and finfish should be given the lowest priority for selection as the target species. This ranking of the preferred target species for PAH analysis assumes that a bivalve mollusc and crustacean are available at the sampling site and that these species are eaten by the consumer population of concern.

In 1993, three states (Massachusetts, Michigan, and Ohio) had issued advisories for PAH contamination in finfish (RTI, 1993). As of 1998, there were five advisories in effect in four states (Massachusetts, Michigan, Ohio, and

Washington) for PAHs (U.S. EPA, 1999c). Monitoring sites in industrial and suburban/urban watersheds should be reviewed to identify current and historic sites of waste incinerators, coal gasification facilities, petroleum refineries, and creosote, coal tar, coal coking, and wood preservative facilities that are potential sources for PAH releases to the environment. Sites of petroleum spills should also be reviewed.

The EPA and others have developed a relative potency estimate approach for the PAHs (Nisbet and LaGoy, 1992; U.S. EPA, 1993c). Using this approach, the cancer potency of 14 carcinogenic PAHs can be estimated based on their relative potency to benzo[a]pyrene. Toxicity equivalence factors (TEF) for benzo[a]pyrene and the other 14 PAHs based on carcinogenicity are discussed in Section 5.3.2.4.

Although several PAHs have been classified as probable human carcinogens (Group B2), benzo[a]pyrene is the only PAH for which an oral CSF is currently available in IRIS (1999). It is recommended that, in both screening and intensive studies, tissue samples be analyzed for benzo[a]pyrene and the other 14 PAHs for which TEFs are available and that the relative potencies given for these PAHs (Nisbet and LaGoy, 1992; U.S. EPA, 1993c) be used to calculate a potency equivalency concentration for each sample for comparison with the recommended SVs for benzo[a]pyrene (see Section 5.3.2.4).

4.3.6 Polychlorinated Biphenyls (Total)

PCBs are base/neutral compounds that are formed by the direct chlorination of biphenyl. PCBs are closely related to many chlorinated hydrocarbon pesticides (e.g., DDT, dieldrin, and aldrin) in their chemical, physical, and toxicologic properties and in their widespread occurrence in the aquatic environment (Nimmo, 1985). There are 209 different PCB compounds, termed congeners, based on the possible chlorine substitution patterns. In the United States, mixtures of various PCB congeners were formulated for commercial use under the trade name Aroclor on the basis of their percent chlorine content. For example, a common PCB mixture, Aroclor 1254, has an average chlorine content of 54 percent by weight (Nimmo, 1985).

Unlike the organochlorine pesticides, PCBs were never intended to be released directly into the environment; most uses were in closed industrial systems. Important properties of PCBs for industrial applications include thermal stability, fire and oxidation resistance, and solubility in organic compounds (Hodges, 1977). PCBs were used as insulating fluids in electrical transformers and capacitors, as plasticizers, as lubricants, as fluids in vacuum pumps and compressors, and as heat transfer and hydraulic fluids (Hodges, 1977; Nimmo, 1985). Although use of PCBs as a dielectric fluid in transformers and capacitors was generally considered a closed-system application, the uses of PCBs, especially during the 1960s, were broadly expanded to many open systems where losses to the environment were likely. Heat transfer systems, hydraulic fluids in die cast machines, and uses in specialty inks are examples of more open-ended

applications that resulted in serious contamination in fish near industrial discharge points (Hesse, 1976).

Although PCBs were once used extensively by industry, their production and use in the United States were banned by the EPA in July 1979 (Miller, 1979). Prior to 1979, the disposal of PCBs and PCB-containing equipment was not subject to federal regulation. Prior to regulation, of the approximately 1.25 billion pounds purchased by U.S. industry, 750 million pounds (60 percent) were still in use in capacitors and transformers, 55 million pounds (4 percent) had been destroyed by incineration or degraded in the environment, and over 450 million pounds (36 percent) were either in landfills or dumps or were available to biota via air, water, soil, and sediments (Durfee et al., 1976).

PCBs are extremely persistent in the environment and are bioaccumulated throughout the food chain (Eisler, 1986; Worthing, 1991). There is evidence that PCB health risks increase with increased chlorination because more highly chlorinated PCBs are retained more efficiently in fatty tissues (IRIS, 1999). However, individual PCB congeners have widely varying potencies for producing a variety of adverse biological effects including hepatotoxicity, cardiovascular toxicity, developmental toxicity, immunotoxicity, neurotoxicity, and carcinogenicity. The non-ortho-substituted coplanar PCB congeners, and some of the mono-ortho-substituted congeners, have been shown to exhibit "dioxin-like" effects (Golub et al., 1991; Kimbrough and Jensen, 1989; McConnell, 1980; Poland and Knutson, 1982; Safe, 1985, 1990; Tilson et al., 1990; U.S. EPA 1993c; Van den Berg et al., 1998). The neurotoxic effects of PCBs appear to be associated with some degree of ortho-chlorine substitution. There is increasing evidence that many of the toxic effects of PCBs result from alterations in hormonal function. Because PCBs can act directly as hormonal agonists or antagonists, PCB mixtures may have complex interactive effects in biological systems (Korach et al., 1988; Safe et al., 1991; Shain et al., 1991; U.S. EPA, 1993c). Because of the lack of sufficient toxicologic data, EPA has not developed quantitative estimates of health risk for specific congeners; however, 12 dioxin-like congeners have been assigned TEFs and may be evaluated as contributing to dioxin health risk (Van den Berg et al., 1998). PCB mixtures have been classified as probable human carcinogens (Group B2) (Appendix G) (IRIS, 1999; U.S. EPA, 1988a).

PCB mixtures have been shown to cause adverse developmental effects in experimental animals (ATSDR, 1998b). Data are inconclusive in regard to developmental effects in humans. Several studies in humans have suggested that PCB exposure may cause adverse developmental effects in children and in developing fetuses (ATSDR, 1998b). These include lower IQ scores (Jacobson and Jacobson, 1996), low birth weight (Rylander et al., 1998), and lower behavior assessment scores (Lonky et al., 1996). However, study limitations, including lack of control for confounding variables, deficiencies in the general areas of exposure assessment, selection of exposed and control subjects, and the comparability of exposed and control samples obscured interpretation of these results (ATSDR, 1998b).

PCBs, total or as Aroclors, have been included in seven major fish contaminant monitoring programs evaluated by the 1993 EPA Workgroup (Appendix E). A summary of the U.S. Fish and Wildlife Service National Contaminants Biomonitoring Program (NCBP) data from 1976 through 1984 indicated a significant downward trend in the geometric mean concentration (wet weight basis) of total PCBs (from 0.89 ppm in 1976 to 0.39 ppm in 1984); however, PCB residues in fish tissue remain widespread, being detected at 91 percent of the sites monitored in 1984 (Schmitt et al., 1990). Maximum total PCB tissue residue concentrations during this same period also declined, from 70.6 ppm in 1976 to 6.7 ppm in 1984. Coinciding declines in tissue residue concentrations of three Aroclors (1248, 1254, and 1260) were also observed. Kidwell et al. (1995) conducted an analysis of all 1984-1985 data from the NCBP study on the three Aroclors in bottom-feeding and predatory fish species. These authors reported there was no significant difference in residues in these two trophic groups of fish for Aroclor 1248 and 1254; however, there were significantly higher concentrations of Aroclor 1260 in predator species as compared to bottom feeders. Mean tissue concentrations of Aroclor 1248, 1254, and 1260 were 0.06 ± 0.32 , 0.21 ± 0.39 , and 0.14 ± 0.24 ppm, respectively, for bottom feeders (e.g., carp, white suckers, and channel catfish) and 0.08 ± 0.31 , 0.35 ± 0.69 , and 0.23 ± 0.38 ppm, respectively, for predator species (e.g., rainbow, brown, brook, and lake trout, largemouth bass, and walleye).

Total PCBs also were detected at 91 percent of 374 sites surveyed in the EPA National Study of Chemical Residues in Fish (NSCRF) (U.S. EPA, 1992c, 1992d). Maximum, arithmetic mean, and median total PCB concentrations (wet weight) reported were 124, 1.89, and 0.209 ppm, respectively. As is shown in Table 4-6, the tri-, tetra-, penta-, hexa-, and heptachlorobiphenyls were detected in fish tissue samples at >50 percent of the NSCRF sites. Mean tissue concentrations were highest for the tetra- and pentachlorobiphenyls with concentrations of 0.696, 0.565, and 0.356 ppm, respectively. The median fish tissue concentrations were highest for the hexa- followed by the pentachlorobiphenyls with concentrations of 0.077 and 0.072 ppm, respectively.

With respect to sources of these compounds, PCBs were detected in all parts of the country with the highest concentrations being associated with paper mills, refinery/other industry sites, Superfund sites, wood preserving facilities, and industrial/urban areas. Mean total PCB concentrations from the NSCRF study were highest in bottom feeders (whole fish) such as carp (2.94 ppm), white sucker (1.7 ppm), and channel catfish (1.3 ppm) as compared to predator species (fillet samples) such as largemouth bass (0.23 ppm), smallmouth bass (0.5 ppm), and walleye (0.37 ppm) (Kuehl et al., 1994).

In 1993, PCB contamination in fish and shellfish resulted in the issuance of 328 advisories in 31 states and the U.S. territory of American Samoa (Figure 4-3) (RTI, 1993). As of 1998, there were 679 advisories in effect in 36 states and the U.S. territory of American Samoa for this compound (Figure 4-3) (U.S. EPA, 1999c.). In addition, two states (Indiana and New York) and the District of Columbia had statewide advisories for PCBs in freshwater rivers and/or lakes.

Table 4-6. Summary of PCBs Detected in Fish Tissue^a as Part of the National Study of Chemical Residues in Fish

Congener group	% sites where detected	Maximum	Mean	Median
Monochlorobiphenyl	13.8	0.235	0.001	ND
Dichlorobiphenyl	30.7	5.072	0.021	ND
Trichlorobiphenyl	57.5	18.344	0.150	0.002
Tetrachlorobiphenyl	72.4	60.764	0.696	0.023
Pentachlorobiphenyl	86.7	29.578	0.565	0.072
Hexachlorobiphenyl	88.7	8.862	0.356	0.077
Heptachlorobiphenyl	69.1	1.850	0.097	0.017
Octachlorobiphenyl	34.8	0.593	0.017	ND
Nonachlorobiphenyl	9.7	0.413	0.003	ND
Decachlorobiphenyl	3.3	0.038	0.001	0.003
Total PCBs*	91.4	-----	1.898	0.209

* The sum of the concentrations of compounds with 1 to 10 chlorines.

^a Concentrations are in ppm (µg/g) wet weight basis.

Source: U.S. EPA, 1992c, 1992d.

One state, Connecticut, had an advisory for all its coastal estuarine waters (Long Island Sound), and five states (Massachusetts, New Hampshire, New Jersey, New York, and Rhode Island) had advisories in effect for all of their coastal marine waters (U.S. EPA, 1999c). Monitoring sites in industrial and suburban/urban watersheds should be reviewed to identify sites of historical Aroclor production facilities, current and historic transformer manufacturing or refurbishing facilities, current and historic landfill and Superfund sites, and current and historic incineration or combustion facilities that are potential sources for PCB releases to the environment.

PCBs may be analyzed quantitatively as Aroclor equivalents, as homologue groups, or as individual congeners. Historically, Aroclor analysis has been performed by most laboratories. This procedure can, however, result in significant error in determining total PCB concentrations (Schwartz et al., 1987; Cogliano, 1998; U.S. EPA, 1996) and in assessing the toxicologic significance of PCBs, because it is based on the assumption that distribution of PCB congeners in environmental samples and parent Aroclors is similar.

The distribution of PCB congeners in Aroclors is, in fact, altered considerably by physical, chemical, and biological processes after release into the environment, particularly when the process of biomagnification is involved (Norstrom, 1988; Oliver and Niimi, 1988; Smith et al., 1990; U.S. EPA, 1996). Aquatic environmental studies indicate that the chlorine content of PCBs increases at higher trophic levels (Bryan et al., 1987; Kubiak et al., 1989; Oliver and Niimi, 1988).

4. TARGET ANALYTES

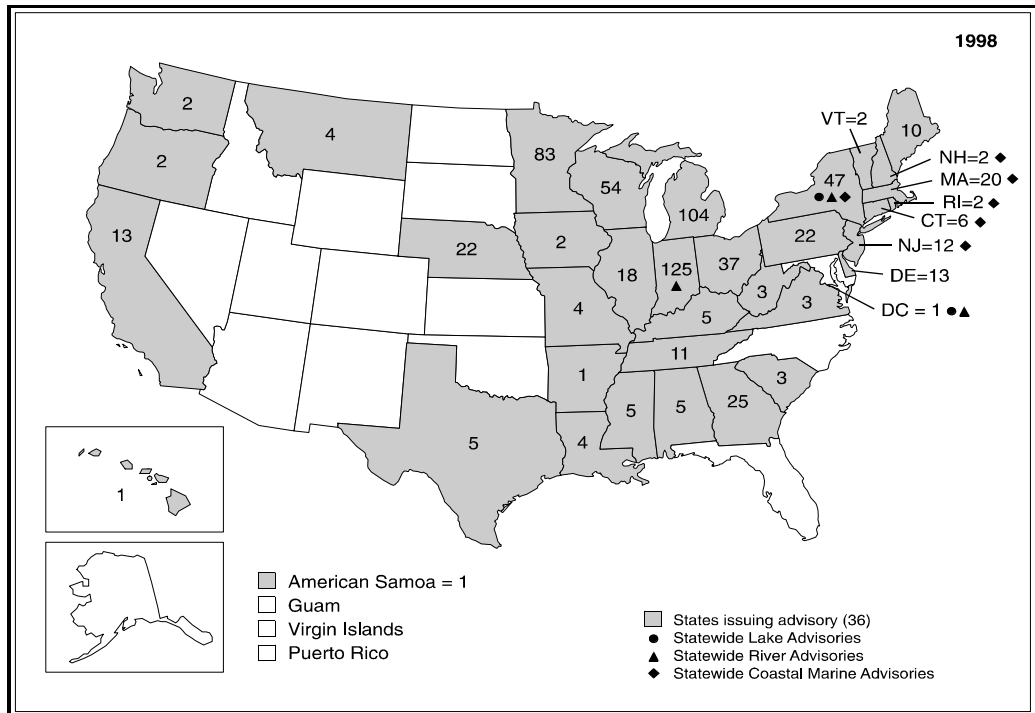
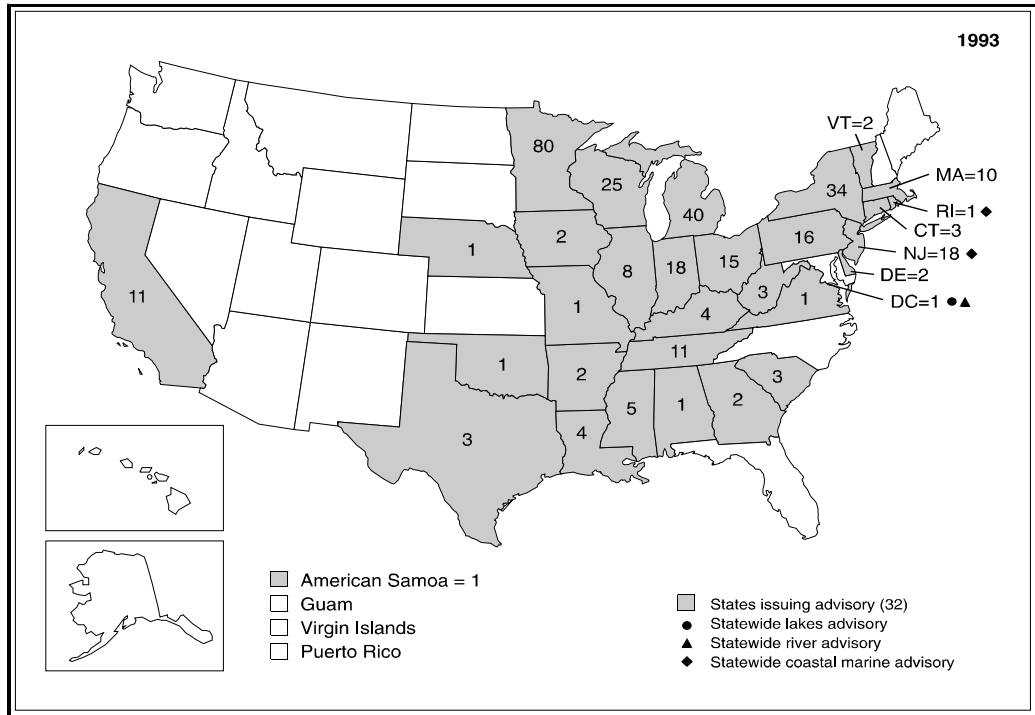

Figure 4-3. States issuing fish and shellfish advisories for PCBs.

The available data indicate that bioaccumulated PCBs are more toxic and more persistent than the original Aroclor mixtures (Cogliano, 1998). Consequently, analysis of homologue groups or congeners should provide a more accurate determination of total PCB concentrations than Aroclor analysis. PCB concentrations derived from Aroclor methods may underestimate total PCBs. In one study, the Delaware Department of National Resources and Environmental Control (DDNREC) compared results of PCBs in six fish samples as determined by Aroclor analysis (Method 608) and homologue analysis (Method 680) (Greene, 1992). On the average, the homologue method gave PCB estimates that were 230 percent higher than the results from the Aroclor method.

The major advantage to analyzing PCBs as Aroclor equivalents is that the analysis is relatively inexpensive (approximately \$200 - \$500) compared to analyzing PCBs as individual congeners (approximately \$800-\$2000). Another disadvantage to analyzing PCBs as individual congeners is that the large number of PCB congeners presents analytical difficulties. Quantitation of individual PCB congeners is relatively time-consuming. EPA has not issued a standard method for PCB congener analysis but has developed a draft method (1668) for dioxin-like congeners (U.S. EPA 1997a). This method is likely to be revised to include the capability to detect all 209 PCB congeners. Currently, only a few laboratories have the capability or expertise to perform congener analyses. Both NOAA (MacLeod et al., 1985; NOAA, 1989b) and the EPA Narragansett Research Laboratory conduct PCB congener analyses. Some states currently conduct both congener and Aroclor analysis; however, most states routinely perform only Aroclor analysis. Analytical methods for congener analysis are discussed in the following references: Cogliano, 1998; Huckins et al., 1988; Kannan et al., 1989; Lake et al., 1995; MacLeod et al., 1985; Maack and Sonzogni, 1988; Mes and Weber, 1989; NOAA, 1989b; Skerfving et al., 1994; Smith et al., 1990; Tanabe et al., 1987; U.S. EPA, 1996.

For the purposes of conducting a risk assessment to determine whether tissue residues exceed potential levels of public health concern in fish and shellfish monitoring programs, analysis of PCB congener or Aroclor equivalents is acceptable. However, because of their lower cost, Aroclor analyses may be the more cost-effective method to use if a large number of samples are analyzed for PCB contamination.

States are encouraged to develop the capability to perform PCB congener analysis. When congener analysis is conducted, at a minimum the 18 congeners recommended by NOAA (shown in Table 4-7) should be analyzed and summed to determine a total PCB concentration according to the approach used by NOAA (1989b). States may wish to consider including additional congeners based on site-specific considerations. PCB congeners of potential environmental importance identified by McFarland and Clarke (1989) and dioxin-like congeners identified by Van den Berg et al. (1998) also are listed in Table 4-7. Lake et al. (1995) and Oliver and Niimi (1988) included more than 80 congeners in their analyses of PCB patterns in water, sediment, and aquatic organisms. A recent study conducted by the DDNREC (Greene, 1999) analyzed for 75 congeners in

Table 4-7. Polychlorinated Biphenyl (PCB) Congeners Recommended for Quantitation as Potential Target Analytes

PCB Congener ^{a,b}	NOAA ^c	McFarland and Clarke (1989)		Dioxin-Like PCBs ^f
		Highest priority ^d	Second priority ^e	
2,4' diCB	8			
2,2',5 triCB	18		18	
2,4,4' triCB	28		37	
3,4,4' triCB				
2,2',3,5' tetraCB	44		44	
2,2',4,5' tetraCB	52	77	49	77
2,2',5,5' tetraCB	66		52	81
2,3',4,4' tetraCB	77		70	
2,3',4',5 tetraCB			74	
2,4,4',5 tetraCB			81	
3,3',4,4' tetraCB				
3,4,4',5 tetraCB				
2,2',3,4,5' pentaCB		87		
2,2',3,4',5 pentaCB	101	90	114	105
2,2',4,5,5' pentaCB	105	101	119	114
2,3,3',4,4' pentaCB	118	105	123	118
2,3,4,4',5 pentaCB	126	118		123
2,3',4,4',5 pentaCB		126		126
2,3',4,4',6 pentaCB				
2',3,4,4',5 pentaCB				
3,3',4,4',5 pentaCB				
2,2',3,3',4,4' hexaCB	128	128		
2,2',3,4,4',5' hexaCB	138	138	151	156
2,2',3,5,5',6 hexaCB	153	153	157	157
2,2',4,4',5,5' hexaCB	169	156	158	167
2,3,3',4,4',5 hexaCB		169	167	169
2,3,3',4,4',5 hexaCB			168	
2,3,3',4,4',6 hexaCB				
2,3',4,4',5,5' hexaCB				
2,3',4,4',5',6 hexaCB				
3,3',4,4',5,5' hexaCB				
2,2',3,3',4,4',5 heptaCB	170	170		
2,2',3,4,4',5,5' heptaCB	180	180	187	189
2,2',3,4,4',5',6 heptaCB	187	183	189	
2,2',3,4,4',6,6' heptaCB		184	201	
2,2',3,4',5,5',6 heptaCB		195		
2,3,3',4,4',5,5' heptaCB				
2,2',3,3',4,4',5,6 octaCB				
2,2',3,3',4,5',6,6' octaCB				
2,2',3,3',4,4',5,5',6 nonaCB		206		
2,2',3,3',4,4',5,5',6,6' decaCB		209		

^a Congeners recommended for quantitation, from dichlorobiphenyl (diCB) through decachlorobiphenyl (decaCB).

^b Congeners are identified in each column by their International Union of Pure and Applied Chemistry (IUPAC) number, as referenced in Ballschmitter and Zell (1980) and Mullin et al. (1984).

^c EPA recommends that these 18 congeners be summed to determine total PCB concentration (NOAA, 1989b).

^d PCB congeners having highest priority for potential environmental importance based on potential for toxicity, frequency of occurrence in environmental samples, and relative abundance in animal tissues.

^e Congeners having second priority for potential environmental importance based on potential for toxicity, frequency of occurrence in environmental samples, and relative abundance in animal tissues.

^f Van den Berg et al., 1998.

fish tissue. Of the 75 congeners, 40 were detected in every fish sample and 20 other congeners were detected in at least half the samples. The DDNREC concluded that a comprehensive target congener list is needed to account for total PCBs in environmental samples because most of the congeners contributed less than 5 percent of the total PCBs.

The EPA Office of Water recommends that PCBs be analyzed as either congeners or Aroclors, with total PCB concentrations reported as the sum of the individual congeners or the sum of the individual Aroclors. If a congener analysis is conducted, the 12 dioxin-like congeners identified in Table 4-7 may be evaluated separately as part of the dioxin risk (see Section 4.3.7). The recommendation is intended to allow states flexibility in PCB analysis and to encourage the continued development of reliable databases of PCB congener and Aroclor equivalents concentrations in fish and shellfish tissue in order to increase our understanding of the mechanisms of action and toxicities of these chemicals. The rationale for, and the uncertainties of, this recommended approach are discussed further in Section 5.3.2.6.

4.3.7 Dioxins and Dibenzofurans

Note: At this time, EPA's Office of Research and Development is reevaluating the potency of dioxins and dibenzofurans. Information provided here as well as information in Section 5.3.2.7 related to calculating TEQs and SVs for dioxins/furans has been modified since the second edition of this Volume 1 guidance was published, but is subject to change pending the results of this reevaluation.

The polychlorinated dibenzo-p-dioxins (PCDDs) and polychlorinated dibenzofurans (PCDFs) are included as target analytes primarily because of the extreme potency of 2,3,7,8-tetrachlorodibenzo-p-dioxin (2,3,7,8-TCDD). Extremely low doses of this homologue have been found to elicit a wide range of toxic responses in animals, including carcinogenicity, teratogenicity, fetotoxicity, reproductive dysfunction, and immunotoxicity (U.S. EPA, 1987d). This compound is the most potent animal carcinogen evaluated by EPA, and EPA has determined that there is sufficient evidence to conclude that 2,3,7,8-TCDD is a probable human carcinogen (B2) (HEAST, 1997). Concern over the health effects of 2,3,7,8-TCDD is increased because of its persistence in the environment and its high potential to bioaccumulate (U.S. EPA, 1987d). As of 1998, the TEF value for 1,2,3,7,8-PeCDD was changed from 0.5 to 1.0, giving 1,2,3,7,8-PeCDD and 2,3,7,8-TCDD the same toxicity equivalency factor (Van den Berg et al., 1998). 1,2,3,7,8-PeCDD is also one of the congeners that is bioaccumulated by fish (U.S. EPA, 1992c, 1992d).

Because dioxin/furan contamination is found in proximity to industrial sites (e.g., bleached kraft paper mills or facilities handling 2,4,5-trichlorophenoxyacetic acid [2,4,5-T], 2,4,5-trichlorophenol [2,4,5-TCP], and/or silvex), and municipal or industrial combustors and incinerators (U.S. EPA, 1987d), it is recommended that each state agency responsible for monitoring include these compounds as target analytes on a site-specific basis based on the presence of potential sources and

results of any environmental (water, sediment, soil, air) monitoring performed in areas adjacent to these sites. All states should maintain a current awareness of potential dioxin/furan contamination, including contamination from the 12 coplanar PCBs that exhibit dioxin-like effects.

Fifteen dioxin and dibenzofuran congeners have been included in two major fish contaminant monitoring programs; however, one congener, 2,3,7,8-TCDD, has been included in six national monitoring programs (Appendix E). Six dioxin congeners and nine dibenzofuran congeners were measured in fish tissue samples in the EPA National Study of Chemical Residues in Fish. The various dioxin congeners were detected at 32 to 89 percent of the 388 sites surveyed, while the furan congeners were detected at 1 to 89 percent of the 388 sites surveyed (U.S. EPA, 1992c, 1992d). As shown in Table 4-8, the dioxin/furan congeners detected at more than 50 percent of the sites included four CDD compounds and three CDF compounds: 1,2,3,4,6,7,8 HpCDD (89 percent), 2,3,7,8 TCDF (89 percent), 2,3,7,8 TCDD (70 percent), 1,2,3,6,7,8 HxCDD (69 percent), 2,3,4,7,8 PeCDF (64 percent), 1,2,3,4,6,7,8 HpCDF (54 percent), and 1,2,3,7,8 PeCDD (54 percent). The most frequently detected CDD/CDF compounds (1,2,3,4,6,7,8-HpCDD and 2,3,7,8-TCDF) were also detected at the highest concentrations—249 ppt and 404 ppt (wet weight), respectively. The mean concentrations of these two compounds were considerably lower, at 10.5 and 13.6 ppt, respectively. The dioxin congener (2,3,7,8-TCDD) believed to be one of the two most toxic congeners to mammals was detected at 70 percent of the sites at a maximum concentration of 204 ppt and a mean concentration of 6.8 ppt. The other toxic congener, 1,2,3,7,8-PeCDD, was detected at 54 percent of the sites at a maximum and mean concentration of 53.95 and 2.38 ppt, respectively.

The NSCRF data showed that pulp and paper mills using chlorine bleach pulp were the dominant source of 2,3,7,8-TCDD and 2,3,7,8-TCDF and that these sites had the highest median 2,3,7,8-TCDD concentrations (5.66 ppt), compared to other source categories studied, including refinery/other industrial sites (1.82 ppt), industrial/urban sites (1.40 ppt), Superfund sites (1.27 ppt), and background sites (0.5 ppt). Source categories that had the highest 2,3,7,8-TCDD concentrations in fish also had the highest TEQ values. It should be noted that OCDD and OCDF were not analyzed in fish tissues because the TEFs were zero for these compounds at the initiation of the NSCRF study. In 1989, TEFs for OCDD and OCDFs were given a TEF value of 0.001. Therefore, TEQ values presented in the NSCRF report may be underreported for samples collected at sites with sources of OCDD/OCDF contamination (e.g., wood preservers) (U.S. EPA, 1992, 1992d). It is noted that the latest TEFs for OCDD and OCDF are 0.0001 (Van den Berg et al., 1998) (see Table 5-6).

In 1993, 20 states had issued 67 fish advisories for dioxins/furans (Figure 4-4) (RTI, 1993). As of 1998, there were 59 advisories in effect in 19 states for this chemical contaminant (Figure 4-4) (U.S. EPA, 1999c). In addition, three states (Maine, New Jersey, and New York) had dioxin advisories in effect for all coastal marine waters (U.S. EPA, 1999c).

Table 4-8. Summary of Dioxins/Furans Detected in Fish Tissue as Part of the EPA National Study of Chemical Residues in Fish^a

Congener	% Sites where detected	Maximum	Mean	Standard deviation	Median
Dioxins					
2,3,7,8-TCDD	70	203.6	6.89	19.41	1.38
1,2,3,7,8-PeCDD	54	53.95	2.38	4.34	0.93
1,2,3,4,7,8-HxCDD	32	37.56	1.67	2.39	1.24
1,2,3,6,7,8-HxCDD	69	100.9	4.30	9.25	1.32
1,2,3,7,8,9-HxCDD	38	24.76	1.16	1.74	0.69
1,2,3,4,6,7,8-HpCDD	89	249.1	10.52	25.30	2.83
Furans					
2,3,7,8-TCDF	89	403.9	13.61	40.11	2.97
1,2,3,7,8-PeCDF	47	120.3	1.71	7.69	0.45
2,3,4,7,8-PeCDF	64	56.37	3.06	6.47	0.75
1,2,3,4,7,8-HxCDF	42	45.33	2.35	4.53	1.42
1,2,3,6,7,8-HxCDF	21	30.86	1.74	2.34	1.42
1,2,3,7,8,9-HxCDF	1	0.96 ^b	1.22	0.41	1.38
2,3,4,6,7,8-HxCDF	32	19.3	1.24	1.51	0.98
1,2,3,4,6,7,8-HpCDF	54	58.3	1.91	4.41	0.72
1,2,3,4,7,8,9-HpCDF	4	2.57	1.24	0.33	1.30
EPA-TEQ ^c	NA	213	11.1	23.8	2.80

^a Concentrations are given in picograms per gram (pg/g) or parts per trillion (ppt) by wet weight. The mean, median, and standard deviation were calculated using one-half the detection limit for samples that were below the detection limit. In cases where multiple samples were analyzed per site, the value used represents the highest concentration.

^b Detection limits were higher than the few quantified values for 1,2,3,4,7,8,9-HpCDF and 1,2,3,7,8,9-HxCDF. Maximum values listed are measured values.

^c This EPA study used TEF-89 toxicity weighting values but did not analyze concentrations of octachlorodibenzo-*p*-dioxin or octachlorodibenzofurans in fish tissues; therefore, the TEQ value does not include these two compounds or the 12 coplanar PCB congeners.

- EPA = U.S. Environmental Protection Agency
- HpCDD = Heptachlorodibenzo-*p*-dioxin
- HpCDF = Heptachlorodibenzofuran
- HxCDD = Hexachlorodibenzo-*p*-dioxin
- HxCDF = Hexachlorodibenzofuran
- NA = Not applicable
- PeCDD = Pentachlorodibenzo-*p*-dioxin
- PeCDF = Pentachlorodibenzofuran
- TCDD = Tetrachlorodibenzo-*p*-dioxin
- TCDF = Tetrachlorodibenzofuran
- TEQ = Toxicity equivalency concentration.

Source: U.S. EPA, 1992c and 1992d.

4. TARGET ANALYTES



Figure 4-4. States issuing fish and shellfish advisories for dioxin/furans.

Dioxins/furans should be considered for analysis primarily in suburban/urban and industrial watersheds at sites of pulp and paper mills using a chlorine bleaching process and at industrial sites where the following organic compounds have been or are currently produced: herbicides (containing 2,4,5-trichlorophenoxy acids and 2,4,5-trichlorophenol), silvex, hexachlorophene, pentachlorophenol, and PCBs as well as at sites of municipal and industrial waste incinerators and combustors (U.S. EPA, 1987d). EPA recommends that all of the 17 2,3,7,8-substituted tetra- through octachlorinated dioxin and dibenzofuran congeners shown in Table 4-9 as well as the 12 dioxin-like PCB congeners shown in Table 4-7 be included as target analytes.

Table 4-9. Dibenzo-p-Dioxins and Dibenzofurans Recommended for Analysis as Target Analytes

Dioxins	Furans
2,3,7,8-TCDD	2,3,7,8-TCDF
1,2,3,7,8-PeCDD	1,2,3,7,8-PeCDF 2,3,4,7,8-PeCDF
1,2,3,4,7,8-HxCDD	1,2,3,4,7,8-HxCDF
1,2,3,6,7,8-HxCDD	1,2,3,6,7,8-HxCDF
1,2,3,7,8,9-HxCDD	1,2,3,7,8,9-HxCDF 2,3,4,6,7,8-HxCDF
1,2,3,4,6,7,8-HpCDD	1,2,3,4,6,7,8-HpCDF 1,2,3,4,7,8,9-HpCDF
OCDD	OCDF

Source: Van den Berg et al., 1998.

4.4 TARGET ANALYTES UNDER EVALUATION

At present, the EPA Office of Water is evaluating one metal (lead) for possible inclusion as a recommended target analyte in state fish and shellfish contaminant monitoring programs. A toxicologic profile for this metal and the status of the evaluation are provided in this section. Other contaminants will be evaluated and may be recommended as target analytes as additional toxicologic data become available.

Note: Any time a state independently deems that an analyte currently under evaluation and/or other contaminants are of public health concern within its jurisdiction, the state should include these contaminants in its fish and shellfish contaminant monitoring program.

4.4.1 Lead

Lead is derived primarily from the mining and processing of limestone and dolomite deposits, which are often sources of lead, zinc, and copper (May and McKinney, 1981). It is also found as a minor component of coal. Historically, lead has had a number of industrial uses, including use in paints, in solder used in plumbing and food cans, and as a gasoline additive. In the past, the primary

source of lead in the environment was the combustion of gasoline; however, use of lead in U.S. gasoline has fallen sharply in recent years due to an EPA phase-down program to minimize the amount of lead in gasoline over time. By 1988, the total lead usage in gasoline had been reduced to less than 1 percent of the amount used in the peak year of 1970 (ATSDR, 1997). At present, lead is used primarily in batteries, electric cable coverings, ammunition, electrical equipment, and sound barriers. Currently, the major points of entry of lead into the environment are from industrial processes, including metals processing, waste disposal and recycling, and chemical manufacturing and from the leachates of landfills (ATSDR, 1997; May and McKinney, 1981).

Lead has been included in five national monitoring programs (Appendix E). Lead has been shown to bioaccumulate, with the organic forms, such as tetraethyl lead, appearing to have the greatest potential for bioaccumulation in fish tissues. High concentrations of lead have been found in marine bivalves and finfish from both estuarine and marine waters (NOAA, 1987, 1989a). In 1984 and 1985, the U.S. Fish and Wildlife Service collected 315 composite samples of whole fish from 109 stations nationwide as part of the National Contaminant Biomonitoring Program (Schmitt and Brumbaugh, 1990). The authors reported that the maximum, geometric mean, and 85th percentile concentrations for lead were 4.88, 0.11, and 0.22 ppm (wet weight), respectively. Lead concentrations in freshwater fish declined significantly from a geometric mean concentration of 0.28 ppm in 1976 to 0.11 ppm in 1984. This trend has been attributed primarily to reductions in the lead content of U.S. gasoline (Schmitt and Brumbaugh, 1990). Kidwell et al. (1995) conducted an analysis of lead levels in tissues from bottom-feeding and predatory fish using the 1984-1985 data from the NCBP study. These authors reported that the mean lead tissue concentrations of 0.18 ± 0.37 ppm in bottom feeders and 0.15 ± 0.43 ppm in predator fish were not significantly different.

In 1993, three states (Massachusetts, Missouri, and Tennessee) and the U.S. territory of American Samoa had fish advisories for lead contamination (RTI, 1993). As of 1998, there were 10 advisories in effect in four states (Hawaii, Louisiana, Missouri, and Ohio) and the U.S. territory of American Samoa for this heavy metal (U.S. EPA, 1999c).

Lead is particularly toxic to children and fetuses. Subtle neurobehavioral effects (e.g., fine motor dysfunction, impaired concept formation, and altered behavior profile) occur in children exposed to lead at concentrations that do not result in clinical encephalopathy (ATSDR, 1997). A great deal of information on the health effects of lead has been obtained through decades of medical observation and scientific research. By comparison to most other environmental toxicants, the degree of uncertainty about the health effects of lead is quite low. It appears that some of these effects, particularly changes in the levels of certain blood enzymes and in aspects of children's neurobehavioral development, may occur at blood lead levels so low as to be essentially without a threshold. EPA's Reference Dose (RfD) Work Group discussed inorganic lead (and lead compounds) in 1985 and considered it inappropriate to develop an RfD for inorganic lead (IRIS, 1999). Lead and its inorganic compounds have been classified as probable human

carcinogens (B2) by EPA (IRIS, 1999). However, EPA has not derived a quantitative estimate of carcinogenic risk from oral exposure to lead because age, health, nutritional status, body burden, and exposure duration influence the absorption, release, and excretion of lead. In addition, current knowledge of lead pharmacokinetics indicates that an estimate derived by standard procedures would not truly describe the potential risk (IRIS, 1999).

Because of the lack of quantitative health risk assessment information for oral exposure to inorganic lead, the EPA Office of Water has not included lead as a recommended target analyte in fish and shellfish contaminant monitoring programs at this time. **Note:** Because of the observation of virtually no-threshold neurobehavioral developmental effects of lead in children, states should include lead as a target analyte in fish and shellfish contaminant programs if there is any evidence that this metal may be present at detectable levels in fish or shellfish in their jurisdictional waters.

SECTION 5

SCREENING VALUES FOR TARGET ANALYTES

For the purpose of this guidance document, screening values are defined as concentrations of target analytes in fish or shellfish tissue that are of potential public health concern and that are used as threshold values against which levels of contamination in similar tissue collected from the ambient environment can be compared. Exceedance of these SVs should be taken as an indication that more intensive site-specific monitoring and/or evaluation of human health risk should be conducted.

The EPA-recommended risk-based method for developing SVs (U.S. EPA, 1989d) is described in this section. This method is considered to be appropriate for protecting the health of fish and shellfish consumers for the following reasons (Reinert et al., 1991):

- It gives full priority to protection of public health.
- It provides a direct link between fish consumption rate and risk levels (i.e., between dose and response).
- It generally leads to conservative estimates of increased risk.
- It is designed for protection of consumers of locally caught fish and shellfish, including susceptible populations such as sport and subsistence fishers who are at potentially greater risk than the general adult population because they tend to consume greater quantities of fish and because they frequently fish the same sites repeatedly.

At this time, the EPA Office of Water is recommending use of this method because it is the basis for developing current water quality criteria. A detailed discussion of the flexibility of the EPA risk-based method and the use of EPA's SVs as compared to FDA action levels is provided in Section 1.2. Further discussion of the EPA Office of Water risk-based approach, including a detailed description of the four steps involved in risk assessment (hazard identification, dose-response assessment, exposure assessment, and risk characterization) is provided in the second guidance document in this series, *Volume 2: Risk Assessment and Fish Consumption Limits*.

5.1 GENERAL EQUATIONS FOR CALCULATING SCREENING VALUES

Risk-based SVs are derived from the general model for calculating the effective ingested dose of a chemical m (E_m) (U.S. EPA, 1989d):

5. SCREENING VALUES FOR TARGET ANALYTES

$$E_m = (C_m \cdot CR \cdot X_m) / BW \quad (5-1)$$

where

E_m = Effective ingested dose of chemical m in the population of concern averaged over a 70-yr lifetime (mg/kg-d)

C_m = Concentration of chemical m in the edible portion of the species of interest (mg/kg; ppm)

CR = Mean daily consumption rate of the species of interest by the general population or subpopulation of concern averaged over a 70-yr lifetime (kg/d)

X_m = Relative absorption coefficient, or the ratio of human absorption efficiency to test animal absorption efficiency for chemical m (dimensionless)

BW = Mean body weight of the general population or subpopulation of concern (kg).

Using this model, the SV for the chemical m (SV_m) is equal to C_m when the appropriate measure of toxicologic potency of the chemical m (P_m) is substituted for E_m . Rearrangement of Equation 5-1, with these substitutions, gives

$$SV_m = (P_m \cdot BW) / (CR \cdot X_m) \quad (5-2)$$

where

P_m = Toxicologic potency for chemical m ; the effective ingested dose of chemical m associated with a specified level of health risk as estimated from dose-response studies; **dose-response variable**.

In most instances, relative absorption coefficients (X_m) are assumed to be 1.0 (i.e., human absorption efficiency is assumed to be equal to that of the test animal), so that

$$SV_m = (P_m \cdot BW) / CR \quad (5-3)$$

However, if X_m is known, Equation 5-2 should be used to calculate SV_m .

Dose-response variables for noncarcinogens and carcinogens are defined in Sections 5.1.1 and 5.1.2, respectively. These variables are based on an assessment of the occurrence of a critical toxic or carcinogenic effect via a specific route of exposure (i.e., ingestion, inhalation, dermal contact). Oral dose-response variables for the recommended target analytes are given in Appendix G. Because of the fundamental differences between the noncarcinogenic and carcinogenic dose-response variables used in the EPA risk-based method, SVs

must be calculated separately for noncarcinogens and potential carcinogens as shown in the following subsections.

5.1.1 Noncarcinogens

The dose-response variable for noncarcinogens is the **reference dose**. The RfD is an estimate of a daily exposure to the human population (including sensitive subpopulations) that is likely to be without appreciable risk of deleterious effects during a lifetime. The RfD is derived by applying uncertainty or modifying factors to a subthreshold dose (i.e., lowest observed adverse effects level [LOAEL] if the no observed adverse effect level [NOAEL] is indeterminate) observed in chronic animal bioassays. These uncertainty or modifying factors range from 1 to 10 for each factor and are used to account for uncertainties in:

- Sensitivity differences among human subpopulations
- Interspecies extrapolation from animal data to humans
- Short-term to lifetime exposure extrapolation from less-than-chronic results on animals to humans when no long-term human data are available
- Deriving an RfD from a LOAEL instead of a NOAEL
- Incomplete or inadequate toxicity or pharmacokinetic databases.

The uncertainty (UF) and modifying (MF) factors are multiplied to obtain a final UF•MF value. This factor is divided into the NOAEL or LOAEL to derive the RfD (Barnes and Dawson, 1988; U.S. EPA, 1989d).

The following equation should be used to calculate SVs for noncarcinogens:

$$SV_n = (RfD \cdot BW)/CR \quad (5-4)$$

where

SV_n = Screening value for a noncarcinogen (mg/kg; ppm)
RfD = Oral reference dose (mg/kg-d)

and BW and CR are defined as in Equation 5-1.

5.1.2 Carcinogens

According to *The Risk Assessment Guidelines of 1986* (U.S. EPA, 1987f), the default model for low-dose extrapolation of carcinogens is a version (GLOBAL 86) of the linearized multistage no-threshold model developed by Crump et al. (1976). This extrapolation procedure provides an upper 95 percent bound risk estimate (referred to as a $q1^*$), which is considered by some to be a conservative estimate of cancer risk. Other extrapolation procedures may be used when justified by the data.

Screening values for carcinogens are derived from: (1) a carcinogenicity potency factor or **cancer slope factor**, which is generally an upper bound risk estimate; and (2) a **risk level** (RL), an assigned level of maximum acceptable individual

lifetime risk (e.g., $RL = 10^{-5}$ for a level of risk not to exceed one excess case of cancer per 100,000 individuals exposed over a 70-yr lifetime) (U.S. EPA, 1997b). The following equation should be used to calculate SVs for carcinogens:

$$SV_c = [(RL / CSF) \cdot BW] / CR \quad (5-5)$$

where

SV_c = Screening value for a carcinogen (mg/kg; ppm)
RL = Maximum acceptable risk level (dimensionless)
CSF = Oral cancer slope factor (mg/kg-d)⁻¹

and BW and CR are defined as in Equation 5-1.

5.1.3 Recommended Values for Variables in Screening Value Equations

The default values for variables used in Equations 5-4 and 5-5 to calculate SVs are based on assumptions for the general adult population. These default values are consistent with values included in the *Methodology for Deriving Ambient Water Quality Criteria for the Protection of Human Health (2000)* (EPA-822-B-00-004). For risk management purposes (e.g., to protect sensitive populations such as pregnant and nursing women), states may choose to use alternative values for consumption rates, etc. different from those recommended in this section.

5.1.3.1 Dose-Response Variables—

EPA has developed oral RfDs and/or CSFs for all of the recommended target analytes in Section 4 (see Appendix G). These are maintained in the EPA Integrated Risk Information System (IRIS, 1999), an electronic database containing health risk and EPA regulatory information on approximately 400 different chemicals. IRIS is available online at:

<http://www.epa.gov/iris/subst/index.html>

The IRIS RfDs and CSFs are reviewed regularly and updated as necessary when new or more reliable information on the toxic or carcinogenic potency of chemicals becomes available.

When IRIS values for oral RfDs and CSFs are available, they should be used to calculate SVs for target analytes from Equations 5-4 and 5-5, respectively. It is important that the most current IRIS values for oral RfDs and CSFs be used to calculate SVs for target analytes unless otherwise recommended.

In cases where IRIS values for oral RfDs or CSFs are not available for calculating SVs for target analytes, estimates of these variables may be derived from the most recent water quality criteria (U.S. EPA, 1992e) according to procedures described in U.S. EPA (1991a, p. IV-12), or from the Classification

5. SCREENING VALUES FOR TARGET ANALYTES

List of Chemicals Evaluated for Carcinogenicity Potential (U.S. EPA 1999b) from the Office of Pesticide Programs Health Effects Division.

5.1.3.2 Body Weight and Consumption Rate—

Values for the variables BW and CR in Equations 5-4 and 5-5 are given in Table 5-1 for various subpopulations including recreational and subsistence fishers. **Note:** In this third edition of this document, EPA’s Office of Water uses a BW of 70 kg, a default CR of 17.5 g/d to calculate the SV for the general populations and recreational fishers, and a default CR of 142.4 g/d to calculate the SV for subsistence fishers. The CR values have been revised since the release of the previous edition.

Table 5-1. Recommended Values for Mean Body Weights (BWs) and Fish Consumption Rates (CRs) for Selected Subpopulations

Variable	Recommended value	Subpopulation
BW	70 kg	All adults (U.S. EPA, 1999a)
	78 kg	Adult males (U.S. EPA, 1985b, 1990a)
	65 kg	Adult females (U.S. EPA, 1985b, 1990a)
	12 kg	Children <3 yr (U.S. EPA, 1985b, 1990a)
	17 kg	Children 3 to <6 yr (U.S. EPA, 1985b, 1990a)
	25 kg	Children 6 to <9 yr (U.S. EPA, 1985b, 1990a)
	36 kg	Children 9 to <12 yr (U.S. EPA, 1985b, 1990a)
	51 kg	Children 12 to <15 yr (U.S. EPA, 1985b, 1990a)
	61 kg	Children 15 to <18 yr (U.S. EPA, 1985b, 1990a)
CR^a	17.5 g/d (0.0175 kg/d)	Estimate of the 90th percentile of recreational or sport fishers (USDA/ARS, 1998) and of the average consumption of uncooked fish and shellfish from estuarine and fresh waters by recreational fishers (U.S. EPA, 2000c)
	142.4 g/d (0.1424 kg/d)	Estimate of the 99th percentile of subsistence fishers (USDA/ARS, 1998) and of the average consumption of uncooked fish and shellfish from estuarine and fresh waters by subsistence fishers (U.S. EPA, 2000c)

^a These are recommended default consumption rates only. **Note:** When local consumption rate data are available for recreational and subsistence fishers, they should be used to calculate SVs for noncarcinogens and carcinogens by subsistence fishers, as described in Sections 5.1.1 and 5.1.2, respectively.

The default CR of 6.5 g/d used in the previous edition of Volume I was based on data from a fish consumption survey conducted in 1973 and 1974 by the National Purchase Diaries and funded by the Tuna Institute. This value represented the estimated mean per capita freshwater/estuarine finfish and shellfish consumption rate for the general U.S. population (Jacobs et al., 1998). This value has been revised based on new data from the combined 1994, 1995, and 1996 Continuing Survey of Food Intake by Individuals (CSFII) survey (USDA/ARS, 1998). The

5. SCREENING VALUES FOR TARGET ANALYTES

CSFII survey is a national food consumption survey conducted by the U.S. Department of Agriculture, consisting of multistage, stratified-cluster area probability samples from all states except Alaska and Hawaii.

These data are collected over 3 consecutive days. On the first day of the survey, participants give information to an in-home interviewer, and on the second and third days, data are taken from self-administered dietary records. Meals consumed both at home and away from home are recorded. Average daily individual consumptions of fish in a given fish-by-habitat category were calculated by summing the amount of fish eaten by the individual across 3 reporting days for all fish-related food codes in a given fish-by-habitat category. The total individual consumption was then divided by three to obtain an average daily consumption rate. The 3-day individual food consumption data collection period is one during which a majority of sampled individuals did not consume any finfish or shellfish. The nonconsumption of finfish or shellfish by a majority of individuals, combined with consumption data from high-end consumers, resulted in a wide range of observed fish consumption rates. This range of fish consumption data would tend to produce distributions of fish consumption with larger variances than would be associated with a longer survey period, such as 30 days. The larger variances would reflect greater dispersion, which results in larger upper-percentile estimates, as well as upper confidence intervals associated with parameter estimates. It follows that estimates of the upper percentiles (90th and 99th percentiles) of per capita fish consumption based on 3 days of data will be conservative with regard to risk (U.S. EPA, 1998a).

If states and tribes do not have site-specific fish consumption information concerning their recreational and subsistence fishers, it is EPA's preference that they use as fish intake assumptions the default values from the most recent 1994-1996 CSFII study (USDA/ARS, 1998). The fish consumption default values of 17.5 g/d for the general adult population and recreational fishers and 142.4 g/d for subsistence fishers used in this document are representative of fish intake for these different population groups. These values are based on risk management decisions that EPA has made after evaluating numerous fish consumption surveys (U.S. EPA, 2000c). These default values represent the uncooked weight intake of freshwater/estuarine finfish and shellfish. EPA recognizes the data gaps and uncertainties associated with the analysis of the 1994-1996 CSFII survey conducted in the process of making its default consumption rate recommendations. The estimated mean of freshwater/estuarine fish ingestion for adults is 7.50 g/d, and the median is 0 g/d. The estimated 90th percentile is 17.53 g/d; the estimated 95th percentile is 49.59 g/d; and the estimated 99th percentile is 142.41 g/d. The median value of 0 g/d may reflect the portion of individuals in the population who never eat fish as well as the limited reporting period (2 days) over which intake was actually measured. By applying as a default consumption rate the 17.5-g/d value for the general adult population, EPA intends to select a consumption rate that is protective of the majority of the population (the 90th percentile of consumers and nonconsumers according to the 1994-1996 CSFII survey data). EPA further considers this rate to be indicative of the average consumption among recreational fishers based on

5. SCREENING VALUES FOR TARGET ANALYTES

averages in the studies reviewed (U.S. EPA, 2000c). Similarly, EPA believes that the assumption of 142.4 g/d is within the range of average consumption estimates for subsistence fishers based on the studies reviewed. Experts at a 1992 National Water Quality Workshop acknowledged, however, that the national survey high-end values are representative of average rates for highly exposed groups such as subsistence fishers, specific ethnic groups, or other high-risk populations. EPA is aware that some local and regional studies indicate greater fish consumption among Native Americans, Pacific Asian Americans, and other subsistence consumers and recommends the use of those studies in appropriate cases. States and tribes have the flexibility to choose fish consumption rates higher than an average value for these populations groups. If a state has not identified a separate well-defined population of high-end consumers and believes that the national data from the 1994-1996 CSFII are representative, they may choose these consumption rates.

With respect to consumption rates, EPA recommends that states always evaluate any type of consumption pattern they believe could reasonably be occurring at a site. Evaluating additional consumption rates involves calculating additional SVs only and does not add to sampling or analytical costs.

EPA has published a review and analysis of survey methods that can be used by states to determine fish and shellfish consumption rates of local populations (U.S. EPA, 1992b, 1998b). States should consult these documents to ensure that appropriate values are selected to calculate SVs for site-specific exposure scenarios.

For any given population, there can be a sensitive subpopulation composed of individuals who may be at higher-than-average risk due to their increased exposure or their increased sensitivity to a contaminant or both. For Native American subsistence fishers, there are several exposure issues of concern that should be addressed as part of a comprehensive exposure assessment:

- **Consumption rates and dietary preferences.** Harris and Harper (1997) surveyed traditional tribal members in Oregon with a subsistence lifestyle and determined a consumption rate of 540 g/d, which included fresh, dried, and smoked fish. They also confirmed that the parts of the fish (heads, fins, tails, skeleton, and eggs) eaten by this group were not typically eaten by other groups. Another study conducted of four tribes in the Northwest that also surveyed tribal members in Oregon but did not target subsistence fishers, reported a 99th percentile ingestion rate of 390 g/d for tribal members (CRITFC, 1994). These consumption rates are much higher than the default consumption rates provided in this document for subsistence fishers and emphasize the need for identifying the consumption rate of the Native American subsistence population of concern.
- **Community characteristics** - It is important to consider family-specific fishing patterns in any exposure scenario, and attention should be paid to the role of the fishing family with respect to the tribal distribution of fish, the

5. SCREENING VALUES FOR TARGET ANALYTES

sharing ethic, and providing fish for ceremonial religious events. Entire communities are exposed if fish are contaminated, and the community contaminant burden as a whole must be considered, not just the maximally exposed individual.

- **Multiple contaminant exposure** - Multiple contaminant exposure is significant for Native American subsistence fishers. A large number of contaminants are often detected in fish tissues and their combined risk associated with the higher consumption rates and dietary preferences for certain fish parts could be very high even if individual contaminants do not exceed the EPA reference dose (Harper and Harris, 1999).
- **Other exposure pathways** - For Native American subsistence fishers, overall exposure to a contaminant may be underestimated if it fails to take into account nonfood uses of fish and other animal parts that may contribute to overall exposure, such as using teeth and bones for decorations and whistles, animal skins for clothing, and rendered fish belly fat for body paint (Harper and Harris, 1999). If other wildlife species (e.g., feral mammals, turtles, waterfowl) that also live in or drink from the contaminated waterbody are eaten, or if the contaminated water is used for irrigation of crops or for livestock watering or human drinking water, the relative source contribution of these other pathways of exposure must also be considered. As with fish and wild game, plants are used by Native Americans for more than just nutrition. Daily cleaning, preparation, and consumption of plants and crafting of plant materials into household goods occurs throughout the year (Harris and Harper, 1997).

As in the general population, increased sensitivity to a chemical contaminant for Native Americans can result from factors such as an individual's underlying health status and medications, baseline dietary composition and quality, genetics, socioeconomic status, access to health care, quality of replacement protein, age, gender, pregnancy, and lactation. These factors are only partially considered in the uncertainty factor(s) used to develop the RfD (Harper and Harris, 1999).

Other important issues that need to be considered concern risk characterization and risk management. For Native American subsistence fishers, the use of an acceptable risk level of 1 in 100,000 (10^{-5}) may not be acceptable to all tribes. Each tribe has the right to decide for themselves what an acceptable level of risk is, and, in some cases, it may be zero risk (zero discharge) to protect cultural resources and uses. Ecological well-being or health is another key issue. Human and ecological health are connected in many ways and the ripple effects are often not recognized. For example, human health may be affected by injury to the environment, which affects the economy and the culture (Harper and Harris, 1999).

Native American subsistence fishers should be treated as a special high-risk group of fish consumers distinct from fishers in the general population and

5. SCREENING VALUES FOR TARGET ANALYTES

distinct even from other Native American fish consumers living in more suburbanized communities. Table 5-2 compares fish consumption rates for various fisher populations within the general population and in several surveys of specific Native American tribal populations. EPA currently recommends default fish consumption rates of 17.5 g/d for the general and recreational fishers and 142.4 g/d for subsistence fishers. However, the tribal population fish consumption studies show that some Native American tribal members living in river-based communities (CRITFC, 1994) eat from 3 to 22 times more fish (from 59 g/d up to 390 g/d) than do recreational fishers, but that traditional Native American subsistence fishing families may eat up to 30 times more fish, almost 1.2 lb/d (540 g/d) (Harris and Harper, 1997). The fish consumption rate from Harris and Harper (1997) for Native American subsistence fishers is also 3.8 times higher than the EPA default consumption rate for subsistence fishers (142.4 g/d) in the general population. The difference in fish consumption is due to the fact that the Native American subsistence fisher's lifestyle is not the same as a recreational fisher's lifestyle with additional fish consumption added, nor is it the same as the "average" Native American tribal member living in a fairly suburbanized tribal community. In addition to exposures from direct consumption of contaminated fish, Native American subsistence fishers also receive more exposure to the water and sediments associated with catching and preparing fish and possibly from drinking more unfiltered river water than more suburbanized tribal community members as well. The Native American subsistence fishing population should be treated as a separate group with a unique lifestyle, distinct from recreational and subsistence fishers in the general U.S. population and also distinct from other Native American fisher populations.

5.1.3.3 Risk Level (RL)—

In this guidance document, EPA's Office of Water uses an RL of 10^{-5} to calculate screening values for the general adult population. However, states have the flexibility to choose to use an appropriate RL value typically ranging from 10^{-4} to 10^{-7} . This is the range of risk levels employed in various U.S. EPA programs. Selection of the appropriate RL is a risk management decision that is made by the state.

5.2 SCREENING VALUES FOR TARGET ANALYTES

Target analyte SVs, and the dose-response variables used to calculate them, are given in Tables 5-3 and 5-4. The SVs are provided as default values for the states to use when site-specific information on variables such as consumption rates are not available for local recreational or subsistence fisher populations.

5. SCREENING VALUES FOR TARGET ANALYTES

Table 5-2. Fish Consumption Rates for Various Fisher Populations

Source	Recreational Fishers (g/d)	Subsistence Fishers (g/d)	Native American Subsistence Fishers (g/d)	Native Americans (g/d)	Basis for Consumption Rate
U.S. EPA	17.5 ^a	142.4 ^a	70 (mean) ^b 170 (95 th percentile) ^b	NA	Fish consumption rate from 1994 and 1996 Continuing Survey of Food Intake by Individuals (CSFII)
Harris and Harper (1997)	NA	NA	540 (fresh, smoked and dried)	NA	Surveyed members of the Confederated Tribes of the Umatilla Indian Reservation
CRITFC (1994)	NA	NA	NA	59 (mean) 170 (95 th percentile) 390 (99 th percentile)	Surveyed members of the Umatilla, Nez Perce, Yakama, and Warm Springs Tribes
Toy et al. (1996)	NA	NA	NA	53 (median, males) 34 (median, females) 66 (median, males) 25 (median, females)	Surveyed members of the Tulalip Tribe Surveyed members of the Squaxin Island Tribe

^a These values were revised in this 3rd edition of Volume 1 of this series (USDA/ARS, 1998)

^b These values are from EPA's Exposure Factors Handbook (U.S. EPA, 1997b)

These SVs were calculated from Equations 5-4 or 5-5 using the following values for BW, CR, and RL and the most current IRIS values for oral RfDs and CSFs (IRIS, 1999) unless otherwise noted:

- **For noncarcinogens:**

BW = 70 kg, average adult body weight

CR = 17.5 g/d (0.0175 kg/d), estimate of average consumption of uncooked fish and shellfish from estuarine and fresh waters by recreational fishers, or

= 142.4 g/d (0.1424 kg/d), estimate of average consumption of uncooked fish and shellfish from estuarine and freshwaters by subsistence fishers.

- **For carcinogens:**

BW and CR, as above

RL = 10⁻⁵, a risk level corresponding to one excess case of cancer per 100,000 individuals exposed over a 70-yr lifetime.

If both oral RfD and CSF values are available for a given target analyte, SVs for both noncarcinogenic and carcinogenic effects are listed in Table 5-2 for recreational fishers and Table 5-3 for subsistence fishers. Unless otherwise indicated,

5. SCREENING VALUES FOR TARGET ANALYTES

Table 5-3. Dose-Response Variables and Recommended Screening Values (SVs) for Target Analytes - Recreational Fishers^a

Target analyte	Noncarcinogens RfD (mg/kg-d)	Carcinogens CSF (mg/kg-d) ⁻¹	SV ^b (ppm)	
			Noncarcinogens ^b	Carcinogens ^b (RL=10 ⁻⁵)
Metals				
Arsenic (inorganic) ^c	3 x 10 ⁻⁴	1.5	1.2	0.026
Cadmium	1 x 10 ⁻³	NA	4.0	-
Mercury (methylmercury) ^d	1 x 10 ⁻⁴	NA	0.4	-
Selenium	5 x 10 ⁻³	NA	20	-
Tributyltin ^e	3 x 10 ⁻⁴	NA	1.2	-
Organochlorine Pesticides				
Total chlordane (sum of cis- and trans-chlordane, cis- and trans-nonachlor, and oxychlordane) ^f	5 x 10 ⁻⁴	0.35	2.0	0.114
Total DDT (sum of 4,4'- and 2,4'- isomers of DDT, DDE, and DDD) ^g	5 x 10 ⁻⁴	0.34	2.0	0.117
Dicofol ^h	4 x 10 ⁻⁴	NA ⁱ	1.6	2.5
Dieldrin	5 x 10 ⁻⁵	16	0.2	2.50 x 10 ⁻³
Endosulfan (I and II) ^j	6 x 10 ⁻³	NA	24	-
Endrin	3 x 10 ⁻⁴	NA	1.2	-
Heptachlor epoxide	1.3 x 10 ⁻⁵	9.1	5.2 x 10 ⁻²	4.39 x 10 ⁻³
Hexachlorobenzene	8 x 10 ⁻⁴	1.6	3.2	2.50 x 10 ⁻²
Lindane (g-hexachlorocyclohexane; g-HCH) ^k	3 x 10 ⁻⁴	1.3	1.2	3.07 x 10 ⁻²
Mirex	2 x 10 ⁻⁴	NA ^l	0.8	-
Toxaphene ^{im}	2.5 x 10 ⁻⁴	1.1	1.0	3.63 x 10 ⁻²
Organophosphate Pesticides				
Chlorpyrifos ⁿ	3 x 10 ⁻⁴	NA	1.2	-
Diazinon ^o	7 x 10 ⁻⁴	NA	2.8	-
Disulfoton	4 x 10 ⁻⁵	NA	0.16	-
Ethion	5 x 10 ⁻⁴	NA	2.0	-
Terbufos ^p	2 x 10 ⁻⁵	NA	0.08	-
Chlorophenoxy Herbicides				
Oxyfluorfen ^q	3 x 10 ⁻³	7.32 x 10 ⁻²	12	5.46 x 10 ⁻¹
PAHs^r	NA	7.3	-	5.47 x 10 ⁻³
PCBs				
Total PCBs ^s	2 x 10 ⁻⁵	2.0	0.08	0.02
Dioxins/furans^t	NA	1.56 x 10 ⁵	-	2.56 x 10 ⁻⁷

NA = Not available in EPA's Integrated Risk Information System (IRIS, 1999).

DDD = p,p'-dichlorodiphenyldichloroethane

DDT = p,p'-dichlorodiphenyltrichloroethane

DDE = p,p'-dichlorodiphenyldichloroethylene

PAH = Polycyclic aromatic hydrocarbon

PCB = Polychlorinated biphenyl

RfD = Oral reference dose (mg/kg-d)

CSF = Cancer slope factor (mg/kg-d)⁻¹

5. SCREENING VALUES FOR TARGET ANALYTES

Table 5-3. (continued)

- ^a Based on fish consumption rate of 17.5 g/d, 70kg body weight and, for carcinogens, 10⁻⁵ risk level and 70-yr lifetime. Unless otherwise noted, values listed are the most current oral RfDs and CSF in EPA's IRIS database (IRIS, 1999).
- ^b The shaded screening value (SV) is the recommended SV for each target analyte. States should note that the screening values listed may be below analytical detection limits achievable for some of the target analytes. Please see Table 8-4 for detection limits.
- ^c Total inorganic arsenic rather than total arsenic should be determined.
- ^d Because most mercury in fish and shellfish tissue is present primarily as methylmercury (NAS, 1991; Tollefson, 1989) and because of the relatively high cost of analyzing for methylmercury, it is recommended that total mercury be analyzed and the conservative assumption be made that all mercury is present as methylmercury. This approach is deemed to be most protective of human health and most cost-effective. The National Academy of Sciences conducted an independent assessment of the RfD for methylmercury. They concluded that "On the basis of its evaluation, the committee's consensus is that the value of EPA's current RfD for methylmercury, 0.1 µg/kg per day, is a scientifically justifiable level for the protection of human health".
- ^e The RfD value listed is for tributyltin oxide (IRIS, 1999).
- ^f The RfD and CSF values listed are derived from studies using technical-grade chlordane (IRIS, 1999) for the *cis*- and *trans*-chlordane isomers or the major chlordane metabolite, oxychlordane, or for the chlordane impurities *cis*- and *trans*-nonachlor. It is recommended that total chlordane be determined by summing the concentrations of *cis*- and *trans*-chlordane, *cis*- and *trans*-nonachlor, and oxychlordane.
- ^g The RfD value listed is for DDT. The CSF value (0.34) is for total DDT sum of DDT, DDE and DDD; the CSF value for DDD is 0.24. It is recommended that the total concentration of DDT include the 2,4'- and 4,4'-isomers of DDT and its metabolites, DDE and DDD.
- ^h The RfD value is from Office of Pesticide Programs Reregistration Eligibility Decision (RED) for Dicofol (EPA, 1998c).
- ⁱ The CSF for dicofol was withdrawn from IRIS pending further review by the CRAVE Agency Work Group (IRIS, 1999).
- ^j The RfD value listed is from the Office of Pesticide Program's Reference Dose Tracking Report (U.S. EPA, 1997).
- ^k IRIS (1999) has not provided a CSF for lindane. The CSF value listed for lindane was calculated from the water quality criteria (0.063 mg/L) (U.S. EPA, 1992f).
- ^l No CSF or cancer classification is available for mirex. This compound is undergoing further review by the CRAVE Agency Work Group (IRIS, 1999).
- ^m The RfD value has been agreed upon by the Office of Pesticide Programs and the Office of Water.
- ⁿ Because of the potential for adverse neurological developmental effects from chlorpyrifos, EPA recommends the use of a Population Adjusted Dose (PAD) of 3 x 10⁻⁵ for infants, children under the age of 6 years, and women ages 13 to 50 years (U.S. EPA, 2000b).
- ^o The RfD value is from a memorandum dated April 1, 1998, Diazinon:-Report of the Hazard Identification Assessment Review Committee. HED Doc. No. 012558.
- ^p The RfD value listed is from a memorandum dated September 25, 1997; Terbufos-FQPA Requirement- Report of the Hazard Identification Review.
- ^q The CSF value is from the Office of Pesticide Programs List of Chemicals Evaluated for Carcinogenic Potential (U.S. EPA, 1999b).
- ^r The CSF value listed is for benzo[a]pyrene. Values for other PAHs are not currently available in IRIS (1999). It is recommended that tissue samples be analyzed for benzo[a]pyrene and 14 other PAHs, and that the order-of-magnitude relative potencies given for these PAHs (Nisbet and LaGoy, 1992; U.S. EPA, 1993c) be used to calculate a potency equivalency concentration (PEC) for each sample (see Section 5.3.2.4).
- ^s Total PCBs may be determined as the sum of congeners or Aroclors. The RfD is based on Aroclor 1254 and should be applied to total PCBs. The CSF is based on a carcinogenicity assessment of Aroclors 1260, 1254, 1242, and 1016. The CSF presented is the upper-bound slope factor for food chain exposure. The central estimate is 1.0 (IRIS, 1999).
- ^t The CSF value listed is for 2,3,7,8-tetrachlorodibenzo-p-dioxin (TCDD) (HEAST, 1997). It is recommended that the 17 2,3,7,8-substituted tetra- through octa-chlorinated dibenzo-p-dioxins and dibenzofurans and the 12 dioxin-like PCBs be determined and a toxicity-weighted total concentration be calculated for each sample, using the method for estimating toxicity equivalency concentrations (TEQs) (Van den Berg et al., 1998).

5. SCREENING VALUES FOR TARGET ANALYTES

Table 5-4. Dose-Response Variables and Recommended Screening Values (SVs) for Target Analytes - Subsistence Fishers^a

Target analyte	Noncarcinogens RfD (mg/kg-d)	Carcinogens CSF (mg/kg-d) ⁻¹	SV ^b (ppm)	
			Noncarcinogens ^b	Carcinogens ^b (RL=10 ⁻⁵)
Metals				
Arsenic (inorganic) ^c	3 x 10 ⁻⁴	1.5	0.147	3.27 x 10 ⁻³
Cadmium	1 x 10 ⁻³	NA	0.491	-
Mercury (methylmercury) ^d	1 x 10 ⁻⁴	NA	0.049	-
Selenium	5 x 10 ⁻³	NA	2.457	-
Tributyltin ^e	3 x 10 ⁻⁴	NA	0.147	-
Organochlorine Pesticides				
Total chlordane (sum of cis- and trans-chlordane, cis- and trans-nonachlor, and oxychlordane) ^f	5 x 10 ⁻⁴	0.35	0.245	1.40 x 10 ⁻²
Total DDT (sum of 4,4'- and 2,4'- isomers of DDT, DDE, and DDD) ^g	5 x 10 ⁻⁴	0.34	0.245	1.44 x 10 ⁻²
Dicofol ^h	4 x 10 ⁻⁴	NA ⁱ	0.196	-
Dieldrin	5 x 10 ⁻⁵	16	0.024	3.07 x 10 ⁻⁴
Endosulfan (I and II) ^j	6 x 10 ⁻³	NA	2.949	-
Endrin	3 x 10 ⁻⁴	NA	0.147	-
Heptachlor epoxide	1.3 x 10 ⁻⁵	9.1	6.39 x 10 ⁻³	5.40 x 10 ⁻⁴
Hexachlorobenzene	8 x 10 ⁻⁴	1.6	0.393	3.07 x 10 ⁻³
Lindane (γ-hexachlorocyclohexane; γ-HCH) ^k	3 x 10 ⁻⁴	1.3	0.147	3.78 x 10 ⁻³
Mirex	2 x 10 ⁻⁴	NA ^l	0.098	-
Toxaphene ^{i,m}	2.5 x 10 ⁻⁴	1.1	0.122	4.46 x 10 ⁻³
Organophosphate Pesticides				
Chlorpyrifos ⁿ	3 x 10 ⁻⁴	NA	0.147	-
Diazinon ^o	7 x 10 ⁻⁴	NA	0.344	-
Disulfoton	4 x 10 ⁻⁵	NA	0.019	-
Ethion	5 x 10 ⁻⁴	NA	0.245	-
Terbufos ^p	2 x 10 ⁻⁵	NA	0.009	-
Chlorophenoxy Herbicides				
Oxyfluorfen ^q	3 x 10 ⁻³	7.32 x 10 ⁻²	1.474	6.71 x 10 ⁻²
PAHs^r	NA	7.3	-	6.73 x 10 ⁻⁴
PCBs				
Total PCBs ^s	2 x 10 ⁻⁵	2.0	9.83 x 10 ⁻³	2.45 x 10 ⁻³
Dioxins/furans^t	NA	1.56 x 10 ⁵	-	3.15 x 10 ⁻⁸

NA = Not available in EPA's Integrated Risk Information System (IRIS, 1999).

DDD = p,p'-dichlorodiphenyldichloroethane

DDT = p,p'-dichlorodiphenyltrichloroethane

DDE = p,p'-dichlorodiphenyldichloroethylene

PAH = Polycyclic aromatic hydrocarbon

PCB = Polychlorinated biphenyl

RfD = Oral reference dose (mg/kg-d)

CSF = Cancer slope factor (mg/kg-d)⁻¹

5. SCREENING VALUES FOR TARGET ANALYTES

Table 5-4. (continued)

- ^a Based on fish consumption rate of 142.4 g/d, 70kg body weight and, for carcinogens, 10⁻⁵ risk level and 70-yr lifetime. Unless otherwise noted, values listed are the most current oral RfDs and CSF in EPA's IRIS database (IRIS, 1999)
- ^b The shaded screening value (SV) is the recommended SV for each target analyte. States should note that the screening values listed may be below analytical detection limits achievable for some of the target analytes. Please see Table 8-4 for detection limits.
- ^c Total inorganic arsenic rather than total arsenic should be determined.
- ^d Because most mercury in fish and shellfish tissue is present primarily as methylmercury (NAS, 1991; Tollefson, 1989) and because of the relatively high cost of analyzing for methylmercury, it is recommended that total mercury be analyzed and the conservative assumption be made that all mercury is present as methylmercury. This approach is deemed to be most protective of human health and most cost-effective. The National Academy of Sciences conducted an independent assessment of the RfD for methylmercury. They concluded that "On the basis of its evaluation, the committee's consensus is that the value of EPA's current RfD for methylmercury, 0.1µg/kg per day, is a scientifically justifiable level for the protection of human health".
- ^e The RfD value listed is for tributyltin oxide (IRIS, 1999).
- ^f The RfD and CSF values listed are derived from studies using technical-grade chlordane (IRIS, 1999) for the *cis*- and *trans*-chlordane isomers or the major chlordane metabolite, oxychlordane, or for the chlordane impurities *cis*- and *trans*-nonachlor. It is recommended that total chlordane be determined by summing the concentrations of *cis*- and *trans*-chlordane, *cis*- and *trans*-nonachlor, and oxychlordane.
- ^g The RfD value listed is for DDT. The CSF value (0.34) is for total DDT sum of DDT, DDE and DDD; the CSF value for DDD is 0.24. It is recommended that the total concentration of DDT include the 2,4'- and 4,4'-isomers of DDT and its metabolites, DDE and DDD.
- ^h The RfD value is from Office of Pesticide Programs Reregistration Eligibility Decision (RED) for Dicofol (EPA, 1998c).
- ⁱ The CSF for dicofol was withdrawn from IRIS pending further review by the CRAVE Agency Work Group (IRIS, 1999).
- ^j The RfD value listed is from the Office of Pesticide Program's Reference Dose Tracking Report (U.S. EPA, 1997).
- ^k IRIS (1999) has not provided a CSF for lindane. The CSF value listed for lindane was calculated from the water quality criteria (0.063 mg/L) (U.S. EPA, 1992f).
- ^l No CSF or cancer classification is available for mirex. This compound is undergoing further review by the CRAVE Agency Work Group (IRIS, 1999)
- ^m The RfD value has been agreed upon by the Office of Pesticide Programs and the Office of Water.
- ⁿ Because of the potential for adverse neurological developmental effects from chlorpyrifos, EPA recommends the use of a Population Adjusted Dose (PAD) of 3 x 10⁻⁵ for infants, children under the age of 6 years, and women ages 13 to 50 years (U.S. EPA, 2000b).
- ^o The RfD value is from a memorandum dated April 1, 1998, Diazinon:-Report of the Hazard Identification Assessment Review Committee. HED Doc. No. 012558.
- ^p The RfD value listed is from a memorandum dated September 25, 1997; Terbufos-FQPA Requirement- Report of the Hazard Identification Review.
- ^q The CSF value is from the Office of Pesticide Programs List of Chemicals Evaluated for Carcinogenic Potential (U.S. EPA, 1999b).
- ^r The CSF value listed is for benzo[a]pyrene. Values for other PAHs are not currently available in IRIS (1999). It is recommended that tissue samples be analyzed for benzo[a]pyrene and 14 other PAHs, and that the order-of-magnitude relative potencies given for these PAHs (Nisbet and LaGoy, 1992; U.S. EPA, 1993c) be used to calculate a potency equivalency concentration (PEC) for each sample (see Section 5.3.2.4).
- ^s Total PCBs may be determined as the sum of congeners or Aroclors. The RfD is based on Aroclor 1254 and should be applied to total PCBs. The CSF is based on a carcinogenicity assessment of Aroclors 1260, 1254, 1242, and 1016. The CSF presented is the upper-bound slope factor for food chain exposure. The central estimate is 1.0 (IRIS, 1999).
- ^t The CSF value listed is for 2,3,7,8-tetrachlorodibenzo-p-dioxin (TCDD) (HEAST, 1997). It is recommended that the 17 2,3,7,8-substituted tetra- through octa-chlorinated dibenzo-p-dioxins and dibenzofurans and the 12 dioxin-like PCBs be determined and a toxicity-weighted total concentration be calculated for each sample, using the method for estimating toxicity equivalency concentrations (TEQs) (Van den Berg et al., 1998).

5. SCREENING VALUES FOR TARGET ANALYTES

the lower of the two SVs (generally, the SV for carcinogenic effects) should be used for the respective fisher population. EPA recommends that the SVs in the shaded boxes (Tables 5-3 and 5-4) be used by states when making the decision to implement Tier 2 intensive monitoring. However, states may choose to adjust these SVs for specific target analytes for the protection of sensitive populations (e.g., pregnant women, nursing mothers, and children or for recreational or subsistence fishers based on site-specific consumption rates). EPA recognizes that states may use higher CRs that are more appropriate for recreational and subsistence fishers in calculating SVs for use in their jurisdictions rather than the EPA default values of 17.5 g/d CR for recreational fishers used to calculate the SVs shown in Table 5-3 and the 142.4 g/d CR for subsistence fishers used to calculate the SVs shown in Table 5-4.

Note: States should use the same SV for a given target analyte in both screening and intensive studies. Therefore, it is critical that states clearly define their program objectives and accurately characterize the target fish-consuming population(s) of concern to ensure that appropriate SVs are selected. If the selected analytical methodology is not sensitive enough to reliably quantitate target analytes at or below selected SVs (see Section 8.2.2 and Table 8-4), program managers must determine appropriate fish consumption guidance based on the lowest detectable concentrations or provide justification for adjusting SVs to values at or above achievable method detection limits. It should be emphasized that when SVs are below method detection limits, the failure to detect a target analyte cannot be assumed to indicate that there is no cause for concern for human health effects.

States should recognize the importance of ensuring that the analytical method selected for quantification of any target analyte must have a method detection limit (MDL) lower than the risk-based screening values calculated using the EPA methodology for noncarcinogenic and carcinogenic effects of the target analyte. If the method detection limit for a specific target analyte is higher than the target analyte SV, the following procedure is recommended as a means to reduce the problem of interpreting data results for chemicals that fall in this category. For example, if fish tissue residue values for several replicate samples are above the MDL while other data values are reported as below the method detection limit (<MDL) including not detected (e.g., no observed response), the state may make a risk management decision to use a value of one-half the MDL as the residue concentration in their risk assessment for those data below the MDL rather than using a value of zero. In this way, the calculated mean target analyte concentration for a group of replicate samples may be higher than the SV. If all of the replicate samples from a particular monitoring site are below the MDL or are not detected, the state may choose to use one-half MDL value for all not detected values rather than a value of zero. The use of one-half MDL rather than zero for these data (< MDL) is a risk management policy decision that should be made by the state.

For noncarcinogens, adjusted SVs should be calculated from Equation 5-4 using appropriate alternative values of BW and/or CR. For carcinogens, adjusted SVs

should be calculated from Equation 5-5 using an RL ranging from 10^{-4} to 10^{-7} and/or sufficiently protective alternative values of BW and CR. Examples of SVs calculated for selected populations of concern and for RL values ranging from 10^{-4} to 10^{-7} are given in Table 5-5.

The need to accurately characterize the target fisher population of interest in order to establish sufficiently protective SVs cannot be overemphasized. For example, the recommended consumption rate of 142.4 g/d for subsistence fishers may be an underestimate of consumption rate and exposures for some subsistence populations such as Native American subsistence fishers (see Section 5.1.3.2). In a recent study of a Native American subsistence fishing population, an average daily consumption rate for these subsistence fishers was estimated to be 540 g/d (Harris and Harper, 1997). Using this average consumption rate and an estimated average body weight of 70 kg, the SV for cadmium (RfD = 1×10^{-3} mg/kg/d) is, from Equation 5-4,

$$SV = (0.001 \text{ mg/kg-d} \cdot 70 \text{ kg}) / (0.540 \text{ kg/d}) = 0.129 \text{ mg/kg (ppm)}. \quad (5-7)$$

This value is almost four times lower than the SV of 0.491 ppm for cadmium based on the EPA default consumption rate of 142.4 g/d for subsistence fishers, as shown in Table 5-4.

5.3 COMPARISON OF TARGET ANALYTE CONCENTRATIONS WITH SCREENING VALUES

As noted previously, the same SV for a specific target analyte should be used in both the screening and intensive studies. The measured concentrations of target analytes in fish or shellfish tissue should be compared with their respective SVs in both screening and intensive studies to determine the need for additional monitoring and risk assessment.

Recommended procedures for comparing target analyte concentrations with SVs are provided below. Related guidance on data analysis is given in Section 9.1.

5.3.1 Metals

5.3.1.1 Arsenic—

Most of the arsenic present in fish and shellfish tissue is organic arsenic, primarily pentavalent arsenobetaine, which has been shown in numerous studies to be metabolically inert and nontoxic (Brown et al., 1990; Cannon et al., 1983; Charbonneau et al., 1978; Bos et al., 1985; Kaise et al. 1985; Luten et al., 1982; Sabbioni et al., 1991; Siewicki, 1981; Bryce et al., 1982; Vahter et al., 1983; Yamauchi et al., 1986). Inorganic arsenic, which is of concern for human health effects (ATSDR, 1998a; WHO, 1989), is generally found in seafood at concentra-

5. SCREENING VALUES FOR TARGET ANALYTES

Table 5-5. Example Screening Values (SVs) for Various Target Populations and Risk Levels (RLs)^a

Chemical	Target population ^b	CR ^c	BW	RfD	CSF	RL	SV (ppm)
Noncarcinogens							
Chlorpyrifos	Recreational fisher	17.5	70	3×10^{-4}	—	—	1.2
	Children (<6 yr)	6.5	17 ^d	3×10^{-5e}	—	—	0.078
	Subsistence fisher	142.4	70	3×10^{-4}	—	—	0.147
Cadmium	Recreational fisher	17.5	70	1×10^{-3}	—	—	4.0
	Children	6.5	17 ^d	1×10^{-3}	—	—	2.6
	Subsistence fisher	142.4	70	1×10^{-3}	—	—	0.491
Carcinogens							
Lindane	Recreational fisher	17.5	70	—	1.3	10^{-4}	3.07×10^{-1}
					1.3	10^{-5}	3.07×10^{-2}
					1.3	10^{-6}	3.07×10^{-3}
					1.3	10^{-7}	3.07×10^{-4}
	Children	6.5	17 ^d	—	1.3	10^{-4}	1.98×10^{-1}
					1.3	10^{-5}	1.98×10^{-2}
					1.3	10^{-6}	1.98×10^{-3}
					1.3	10^{-7}	1.98×10^{-4}
	Subsistence fisher	142.4	70	—	1.3	10^{-4}	3.78×10^{-2}
					1.3	10^{-5}	3.78×10^{-3}
					1.3	10^{-6}	3.78×10^{-4}
					1.3	10^{-7}	3.78×10^{-5}
Toxaphene	Recreational fisher	17.5	70	—	1.1	10^{-4}	3.63×10^{-1}
					1.1	10^{-5}	3.63×10^{-2}
					1.1	10^{-6}	3.63×10^{-3}
					1.1	10^{-7}	3.63×10^{-4}
	Children	6.5	17 ^d	—	1.1	10^{-4}	2.35×10^{-1}
					1.1	10^{-5}	2.35×10^{-2}
					1.1	10^{-6}	2.35×10^{-3}
					1.1	10^{-7}	2.35×10^{-4}
	Subsistence fisher	142.5	70	—	1.1	10^{-4}	4.6×10^{-2}
					1.1	10^{-5}	4.6×10^{-3}
					1.1	10^{-6}	4.6×10^{-4}
					1.1	10^{-7}	4.6×10^{-5}

CR = Mean daily fish or shellfish consumption rate (uncooked weight), averaged over a 70-yr lifetime for the population of concern (g/d).

BW = Mean body weight, estimated for the population of concern (kg).

RfD = Oral reference dose for noncarcinogens (mg/kg-d).

CSF = Oral slope factor for carcinogens (mg/kg-d)⁻¹.

RL = Maximum acceptable risk level for carcinogens (dimensionless).

^a See Equations 5-4 and 5-5.

^b See Tables 5-1, 5-2, 5-3 and 5-4 for information on target populations.

^c To calculate SVs, the CRs given in this table must be divided by 1,000 to convert g/d to kg/d.

^d BW used is for children 3 to <6 yr (see Table 5-1).

^e Because of the potential for adverse neurological developmental effects, EPA recommends the use of a Population Adjusted Dose for chlorpyrifos of 3×10^{-5} mg/kg-d for infants, children to the age of 6, and women ages 13 to 50 years (U.S. EPA, 2000b).

tions ranging from <1 to 20 percent of the total arsenic concentration (Edmonds and Francesconi, 1993; Nraigu and Simmons, 1990). It is recommended that, in both screening and intensive studies, total inorganic arsenic tissue concentrations be determined for comparison with the recommended SV for chronic oral exposure. This approach is more rigorous than the current FDA-recommended method of analyzing for total arsenic and estimating inorganic arsenic concentrations based on the assumption that 10 percent of the total arsenic in fish tissue is in the inorganic form (U.S. FDA, 1993). Although the cost of analysis for inorganic arsenic (see Table 8-5) may be three to five times greater than for total arsenic, the increased cost is justified to ensure that the most accurate data are obtained for quantitative assessment of human health risks.

5.3.1.2 Cadmium, Mercury, and Selenium—

For cadmium, mercury, and selenium, the total metal tissue concentration should be determined for comparison with the appropriate target population SV.

Because most mercury in fish and shellfish tissue is present as methylmercury (Kannan et al., 1998; NAS, 1991; Tollefson, 1989), and because of the relatively high analytical cost for methylmercury, it is recommended that total mercury be determined and the conservative assumption be made that all mercury is present as methylmercury. The determination of methylmercury in fish tissue is not recommended even though methylmercury is the compound of greatest concern for human health (NAS, 1991; Tollefson, 1989) and the recommended SVs are for methylmercury (see Tables 5-3 and 5-4). This approach is deemed to be most protective of human health and most cost-effective.

5.3.1.3 Tributyltin—

Tissue samples should be analyzed specifically for tributyltin for comparison with the recommended target population SVs for this compound (see Tables 5-3 and 5-4).

5.3.2 Organics

For each of the recommended organic target analytes that are single compounds, the determination of tissue concentration and comparison with the appropriate SV is straightforward. However, for those organic target analytes that include a parent compound and structurally similar compounds or metabolites (i.e., total chlordane, total DDT, endosulfan I and II) or that represent classes of compounds (i.e., PAHs, PCBs, dioxins/furans, or toxaphene), additional guidance is necessary to ensure that a consistent approach is used to determine appropriate target analyte concentrations for comparison with recommended SVs.

5.3.2.1 Chlordane—

The SVs for total chlordane are derived from technical-grade chlordane. Oral cancer slope factors are not available in IRIS (1999) for *cis*- and *trans*-chlordane, *cis*- and *trans*-nonachlor, and oxychlordane. At this time, as a conservative approach, EPA recommends that, in both screening and intensive studies, the concentrations of all chlordane constituents (*cis*- and *trans*-chlordane, *cis*- and *trans*-nonachlor) and the metabolite of chlordane (oxychlordane) be determined and summed to give a total chlordane concentration for comparison with the recommended SVs (see Tables 5-3 and 5-4).

5.3.2.2 DDT—

DDT and its metabolites (i.e., the 4,4'- and 2,4'-isomers of DDE and DDD) are all potent toxicants, DDE isomers being the most prevalent in the environment. As a conservative approach, EPA recommends that, in both screening and intensive studies, the concentrations of 4,4'- and 2,4'-DDT and their 4,4' and 2,4'-DDE and DDD metabolites be determined and a total DDT concentration be calculated for comparison with the recommended SVs for total DDT (see Tables 5-3 and 5-4).

5.3.2.3 Endosulfan—

Endosulfan collectively refers to two stereoisomers designated I and II. At this time, for both screening and intensive studies, EPA recommends that the concentrations of the two endosulfan constituents (endosulfan I and II) be determined and summed to give a total endosulfan concentration for comparison with the recommended SVs for total endosulfan.

5.3.2.4 Toxaphene—

The SVs for toxaphene are derived from technical-grade toxaphene, a mixture of approximately 670 chlorinated camphenes (ATSDR, 1996). At this time, determination of total toxaphene is recommended rather than individual congener analysis. Research is currently under way to determine the relative health risks of the toxaphene congeners. In the future, it may be possible to develop a congener-specific quantitative risk assessment approach for toxaphene similar to that for PCBs and dioxins/furans. The total toxaphene concentration should be analyzed for comparison with the recommended SVs for toxaphene (see Tables 5-3 and 5-4).

5.3.2.5 PAHs—

Although several PAHs have been classified as B2 carcinogens (probable human carcinogens), benzo[a]pyrene is the only PAH for which a CSF is currently available in IRIS (1999). As a result, EPA quantitative risk estimates for PAH mixtures have often assumed that all carcinogenic PAHs are equipotent to benzo[a]pyrene. The EPA Office of Health and Environmental Assessment has

5. SCREENING VALUES FOR TARGET ANALYTES

issued guidance for quantitative risk assessment of PAHs (Nisbet and LaGoy, 1992; U.S. EPA, 1993c) in which an estimated order of potential potency for 14 PAHs relative to benzo[a]pyrene is recommended, as shown in Table 5-6. Based on this guidance, EPA recommends that, in both screening and intensive studies, tissue samples be analyzed for the PAHs shown in Table 5-6 and that a potency-weighted total concentration be calculated for each sample for comparison with the recommended SVs for benzo[a]pyrene (see Tables 5-3 and 5-4). This potency equivalency concentration should be calculated using the following equation:

$$PEC = \sum_i (RP_i \cdot C_i) \quad (5-8)$$

where

- RP_i = Relative potency for the ith PAH (from Table 5-6)
- C_i = Concentration of the ith PAH.

Table 5-6. Toxicity Equivalency Factors for Various PAHs

Compound	Toxicity Equivalency Factor (TEF)
Dibenz[<i>a,h</i>]anthracene	5
Benzo[<i>a</i>]pyrene	1
Benz[<i>a</i>]anthracene	0
Benzo[<i>b</i>]fluoranthene	0.1
Benzo[<i>k</i>]fluoranthene	0.1
Indeno[1,2,3- <i>cd</i>]pyrene	0.1
Anthracene	0.01
Benzo[<i>g,h,i</i>]perylene	0.01
Chrysene	0.01
Acenaphthene	0.001
Acenaphthylene	0.001
Fluoranthene	0.001
Fluorene	0.001
Phenanthrene	0.001
Pyrene	0.001

Source: Nisbet and LaGoy (1992).

5.3.2.6 PCBs—

Using the approach for PCB analysis recommended by the EPA Office of Water (see Section 4.3.6), total PCB concentrations may be determined as the sum of Aroclor equivalents in screening studies. For intensive studies, the total PCB concentration should be determined as the sum of PCB congeners or the sum of homologue groups. The total PCB concentration should be compared with the recommended SVs for PCBs (see Tables 5-3 and 5-4). The EPA Office of Water recognizes the potential problems associated with PCB congener analysis (i.e.,

standard methods are not yet available but are under development, relatively high analytical cost, and limited number of qualified laboratories), but is recommending these methods for intensive studies because Aroclor analysis does not adequately represent bioconcentrated PCB mixtures found in fish tissue. EPA has developed a draft method for selected PCB congeners (Method 1668) (U.S. EPA, 1997a). This method is being tested and may be revised to include all PCB congeners. Currently, Method 680 is available for PCB homologue analysis.

5.3.2.7 Dioxins and Dibenzofurans—

Note: At this time, EPA's Office of Research and Development is reevaluating the potency of dioxins/furans. Consequently, the following recommendation may change pending the results of this reevaluation.

It is recommended in both screening and intensive studies that the 17 2,3,7,8-substituted tetra- through octa-chlorinated PCDDs and PCDFs and the 12 coplanar congeners with dioxin-like effects be determined and that a toxicity-weighted total concentration be calculated for each sample for comparison with the recommended SVs for 2,3,7,8-TCDD (see Tables 5-3 and 5-4).

The method for estimating total TEQ (Van den Berg et al., 1998) should be used to estimate TCDD equivalent concentrations according to the following equation:

$$TEQ = \sum_i (TEF_i \cdot C_i) \quad (5-9)$$

where

TEF_i = Toxicity equivalency factor for the i th congener (relative to 2,3,7,8-TCDD)

C_i = Concentration of the i th congener.

TEFs for the 2,3,7,8-substituted tetra- through octa-PCDDs and PCDFs and the 12 dioxin-like PCBs are shown in Table 5-7. Note: TEFs for five congeners have changed over those TEFs recommended by Barnes and Bellin (1989).

5. SCREENING VALUES FOR TARGET ANALYTES

Table 5-7. Toxicity Equivalency Factors (TEFs) for Tetra- through Octa-Chlorinated Dibenzo-p-Dioxins and Dibenzofurans and Dioxin-Like PCBs

Analyte	Old TEF-89	TEF-98
Dioxins^a		
2,3,7,8-TCDD	1.00	1.00
1,2,3,7,8-PeCDD	0.50	1.00*
1,2,3,4,7,8-HxCDD	0.10	0.10
1,2,3,6,7,8-HxCDD	0.10	0.10
1,2,3,7,8,9-HxCDD	0.10	0.10
1,2,3,4,6,7,8-HpCDD	0.01	0.01
OCDD	0.001	0.0001*
Furans^a		
2,3,7,8-TCDF	0.10	0.10
1,2,3,7,8-PeCDF	0.05	0.05
2,3,4,7,8-PeCDF	0.50	0.50
1,2,3,4,7,8-HxCDF	0.10	0.10
1,2,3,6,7,8-HxCDF	0.10	0.10
1,2,3,7,8,9-HxCDF	0.10	0.10
2,3,4,6,7,8-HxCDF	0.10	0.10
1,2,3,4,6,7,8-HpCDF	0.01	0.01
1,2,3,4,7,8,9-HpCDF	0.01	0.01
OCDF	0.001	0.0001*
PCBs		
3,3',4,4'-TetraCB (77)	0.0005	0.0001*
3,4,4',5-TetraCB (81)	not available	0.0001*
2,3,3',4,4'-PentaCB (105)	0.0001	0.0001
2,3,4,4',5-PentaCB (114)	0.0005	0.0005
2,3',4,4',5-PentaCB (118)	0.0001	0.0001
2',3,4,4',5-PentaCB (123)	0.0001	0.0001
3,3',4,4',5-PentaCB (126)	0.1	0.1
2,3,3',4,4',5-HexaCB (156)	0.0005	0.0005
2,3,3',4,4',5'-HexaCB (157)	0.0005	0.0005
2,3,4,4',5,5'-HexaCB (167)	0.00001	0.00001
3,3',4,4',5,5'-HexaCB (169)	0.01	0.01
2,3,3',4,4',5,5--HexaCB (189)	0.0001	0.0001

Sources: Barnes and Bellin, 1989; Van den Berg et al., 1998.

*Note: TEF-98 value changed from TEF-89 value.

^aTEFs for all non-2,3,7,8-substituted congeners are zero.

SECTION 6

FIELD PROCEDURES

This section provides guidance on sampling design of screening and intensive studies and recommends field procedures for collecting, preserving, and shipping samples to a processing laboratory for target analyte analysis. Planning and documentation of all field procedures are emphasized to ensure that collection activities are cost-effective and that sample integrity is preserved during all field activities. This section also describes the implications that result when deviations occur in the recommended study design. Some of the deviations in study design most likely to occur include the use of unequal numbers of fish in composite samples, unequal numbers of replicate samples collected at different stations, and sizes of fish within a composite sample exceeding the recommendation for composite samples.

6.1 SAMPLING DESIGN

Prior to initiating a screening or intensive study, the program manager and field sampling staff should develop a detailed sampling plan. As described in Section 2, there are seven major parameters that must be specified prior to the initiation of any field collection activities:

- Site selection
- Target species (and size class)
- Target analytes
- Target analyte screening values
- Sampling times
- Sample type
- Replicate samples.

In addition, personnel roles and responsibilities in all phases of the fish and shellfish sampling effort should be defined clearly. All aspects of the final sampling design for a state's fish and shellfish contaminant monitoring program should be documented clearly by the program manager in a Work/QA Project Plan (see Appendix I). Routine sample collection procedures should be prepared as standard operating procedures (U.S. EPA, 1984b) to document the specific methods used by the state and to facilitate assessment of final data quality and comparability.

The seven major parameters of the sampling plan should be documented on a sample request form prepared by the program manager for each sampling site. The sample request form should provide the field collection team with readily available information on the study objective, site location, site name/number, target species and alternate species to be collected, target analytes to be evaluated, anticipated sampling dates, sample type to be collected, number and

size range of individuals to be collected for each composite sample, sampling method to be used, and number of replicates to be collected. An example of a sample request form is shown in Figure 6-1. The original sample request form should be filed with the program manager and a copy kept with the field logbook. The seven major parameters that must be specified in the sampling plan for screening and intensive studies are discussed in Sections 6.1.1 and 6.1.2, respectively.

6.1.1 Screening Studies (Tier 1)

The primary aim of screening studies is to identify frequently fished sites where commonly consumed fish and shellfish species are chemically contaminated and may pose a risk to human health. Ideally, screening studies should include all waterbodies where commercial, recreational, or subsistence fishing and shellfish harvesting are practiced.

6.1.1.1 Site Selection—

Sampling sites should be selected to identify extremes of the bioaccumulation spectrum, ranging from presumed undisturbed reference sites to sites where existing data (or the presence of potential pollutant sources) suggest significant chemical contamination. Where resources are limited, states initially should target those harvest sites suspected of having the highest levels of contamination and of posing the greatest potential health risk to local fish and shellfish consumers. Screening study sites should be located in frequently fished areas near

- Point source discharges such as
 - Industrial or municipal discharges
 - Combined sewer overflows (CSOs)
 - Urban storm drains
- Nonpoint source inputs such as
 - Landfills, Resource Conservation and Recovery Act (RCRA) sites, or Superfund Comprehensive Environmental Response, Compensation, and Liability Act (CERCLA) sites
 - Areas of intensive agricultural, silvicultural, or resource extraction activities or urban land development
 - Areas receiving inputs through multimedia mechanisms such as hydrogeologic connections or atmospheric deposition (e.g., areas affected by acid rain impacts, particularly lakes with pH <6.0 since elevated mercury concentrations in fish have been reported for such sites)
- Areas acting as potential pollutant sinks where contaminated sediments accumulate and bioaccumulation potential might be enhanced (i.e., areas where water velocity slows and organic-rich sediments are deposited)
- Areas where sediments are disturbed by dredging activities

Sample Request Form	
Project Objective <input type="checkbox"/> Screening Study	<input type="checkbox"/> Intensive Study
Sample Type <input type="checkbox"/> Fish fillets only <input type="checkbox"/> Shellfish (edible portions) <i>(Specify portions if other than whole _____)</i> <input type="checkbox"/> Whole fish or portions other than fillet <i>(Specify tissues used if other than whole _____)</i>	<input type="checkbox"/> Fish fillets only <input type="checkbox"/> Shellfish (edible portions) <i>(Specify portions if other than whole _____)</i> <input type="checkbox"/> Whole fish or portions other than fillet <i>(Specify tissues used if other than whole _____)</i>
Target Contaminants <input type="checkbox"/> All target contaminants <input type="checkbox"/> Additional contaminants <i>(Specify _____)</i>	<input type="checkbox"/> Contaminants exceeding screening study SVs <i>(Specify _____)</i>
INSTRUCTIONS TO SAMPLE COLLECTION TEAM	
Project Number: _____ Site (Name/Number): _____ County/Parish: _____ Lat./Long.: _____ Target Species: _____ Alternate Species: <i>(in order of preference)</i> <input type="checkbox"/> Freshwater _____ <input type="checkbox"/> Estuarine _____ _____ Proposed Sampling Dates: _____ Proposed Sampling Method: _____ <input type="checkbox"/> Electrofishing <input type="checkbox"/> Mechanical grab or tongs <input type="checkbox"/> Seining <input type="checkbox"/> Biological dredge <input type="checkbox"/> Trawling <input type="checkbox"/> Hand collection <input type="checkbox"/> Other <i>(Specify _____)</i>	
Number of Sample Replicates: <input type="checkbox"/> No field replicates (1 composite sample only) <input type="checkbox"/> _____ field replicates <i>(Specify number for each target species)</i>	
Number of Individuals per Composite: _____ Fish per composite Shellfish per composite <i>(specify number to obtain 200 grams of tissue)</i>	

Figure 6-1. Example of a sample request form.

- Unpolluted areas that can serve as reference sites for subsequent intensive studies or as "green areas" that states can designate for unrestricted consumption (see Appendix B). **Note:** Michigan sampled lakes that were in presumed unpolluted areas but discovered mercury contamination in fish from many of these areas and subsequently issued a fish consumption advisory for all of its inland lakes.

The procedures required to identify candidate screening sites near significant point source discharges are usually straightforward. It is often more difficult, however, to identify clearly defined candidate sites in areas affected by pollutants from nonpoint sources. For these sites, assessment information summarized in state Section 305(b) reports should be reviewed before locations are selected. State 305(b) reports are submitted to the EPA Assessment and Watershed Protection Division biennially and provide an inventory of the water quality in each state. The 305(b) reports often contain Section 319 nonpoint source assessment information that may be useful in identifying major sources of nonpoint source pollution to state waters. States may also use a method for targeting pesticide hotspots in estuarine watersheds that employs pesticide use estimates from NOAA's National Coastal Pollutant Discharge Inventory (Farrow et al., 1989).

It is important for states to identify and document at least a few unpolluted sites, particularly for use as reference sites in subsequent monitoring studies. Verification that targeted reference sites show acceptably low concentrations of contaminants in fish or shellfish tissues also provides at least partial validation of the methods used to select potentially contaminated sites. Clear differences between the two types of sites support the site-selection methodology and the assumptions about primary sources of pollution.

In addition to the intensity of subsistence, sport, or commercial fishing, factors that should be evaluated (Versar, 1982) when selecting fish and shellfish sampling sites include

- Proximity to water and sediment sampling sites
- Availability of data on fish or shellfish community structure
- Bottom condition
- Type of sampling equipment
- Accessibility of the site.

The most important benefit of locating fish or shellfish sampling sites near sites selected for water and sediment sampling is the possibility of correlating contaminant concentrations in different environmental compartments (water, sediment, and fish). Selecting sampling sites in proximity to one another is also more cost-effective in that it provides opportunities to combine sampling trips for different matrices.

Availability of data on the indigenous fish and shellfish communities should be considered in final site selection. Information on preferred feeding areas and

migration patterns is valuable in locating populations of the target species (Versar, 1982). Knowledge of habitat preference provided by fisheries biologists or commercial fishermen may significantly reduce the time required to locate a suitable population of the target species at a given site.

Bottom condition is another site-specific factor that is closely related to the ecology of a target fish or shellfish population (Versar, 1982). For example, if only soft-bottom areas are available at an estuarine site, neither oysters (*Crassostrea virginica*) nor mussels (*Mytilus edulis* and *M. californianus*) would likely be present because these species prefer hard substrates. Bottom condition also must be considered in the selection and deployment of sampling equipment. Navigation charts provide depth contours and the locations of large underwater obstacles in coastal areas and larger navigable rivers. Sampling staff might also consult commercial fishers familiar with the candidate site to identify areas where the target species congregates and the appropriate sampling equipment to use.

Another factor closely linked to equipment selection is the accessibility of the sampling site. For some small streams or land-locked lakes (particularly in mountainous areas), it is often impractical to use a boat (Versar, 1982). In such cases the sampling site should have good land access. If access to the site is by land, consideration should be given to the type of vegetation and local topography that could make transport of collection equipment difficult. If access to the sampling site is by water, consideration should be given to the location of boat ramps and marinas and the depth of water required to deploy the selected sampling gear efficiently and to operate the boat safely. Sampling equipment and use are discussed in detail in Section 6.2.1.

The selection of each sampling site must be based on the best professional judgment of the field sampling staff. Once the site has been selected, it should be plotted and numbered on the most accurate, up-to-date map available. Recent 7.5-minute (1:24,000 scale) maps from the U.S. Geologic Survey or blue line maps produced by the U.S. Army Corps of Engineers are of sufficient detail and accuracy for sample site mapping. The type of sampling to be conducted, water depth, and estimated time to the sampling site from an access point should be noted. The availability of landmarks for visual or range fixes should be determined for each site, and biological trawl paths (or other sampling gear transects) and navigational hazards should be indicated. Additional information on site-positioning methods, including Loran-C, VIEWNAV, TRANSIT (NAVSAT), GEOSTAR, and the NAVSTAR Global Positioning System (GPS), is provided in Battelle (1986), Tetra Tech (1986), and Puget Sound Estuary Program (1990a).

Each sampling site must be described accurately because state fish and shellfish contaminant monitoring data may be stored in a database available to users nationwide (see Section 9.2). For example, a sampling site may be defined as a 2-mile section of river (e.g., 1 mile upstream and 1 mile downstream of a reference point) or a 2-mile stretch of lake or estuarine/marine shoreline (U.S. EPA, 1990d). Each sampler should provide a detailed description of each site

using a 7.5-minute USGS map to determine the exact latitude and longitude coordinates for the reference point of the site. This information should be documented on the sample request form and field record sheets (see Section 6.2.3).

One additional consideration associated with sample site selection is whether the sampling area includes waters inhabited by threatened or endangered species. If such waterbodies are to be monitored, the state must obtain a permit from the U.S. Fish and Wildlife Service (USFWS) if their sampling effort could potentially impact a freshwater species (U.S. DOI, 1999) or from the National Marine Fisheries Service (NMFS) if their sampling effort could potentially impact any marine or anadromous species (U.S. DOC, 1999a, 1999b) covered under the Endangered Species Act (ESA) of 1973.

A species is listed under one of two categories, endangered or threatened, depending on its status and the degree of threat it faces. An endangered species is one that is in danger of extinction throughout all or a significant portion of its range. A threatened species is one that is likely to become endangered in the foreseeable future. The U.S. Fish and Wildlife Service maintains a list of all plant and animal species native to the United States that are candidates or proposed for possible addition to the Federal List. A complete listing of the current status of all threatened and endangered species as well as information about each USFWS region is available on-line on the USFWS website at <http://endangered.fws.gov/wildlife.html>

Species information is also available by USFWS region having primary responsibility for that species. The seven major USFWS regions with their respective states are shown in Figure 6-2. States can obtain additional information by contacting the specific USFWS regional office and talking with the regional liaison for endangered species.

Freshwater Threatened and Endangered Species

State conservation agencies typically have cooperative agreements in place with the U.S. Fish and Wildlife Service. Under these agreements, any qualified employee of the state agency may take those endangered species covered by the cooperative agreement for conservation programs. Such taking of these species may be done provided it does not result in the following:

- Death or permanent disabling of the specimen
- Removal of the specimen from the state where the taking occurred
- Introduction of the specimen so taken, or of any progeny derived from the specimen, into an area beyond the historical range of the species
- Holding of the specimen in captivity for a period of more than 45 consecutive days.

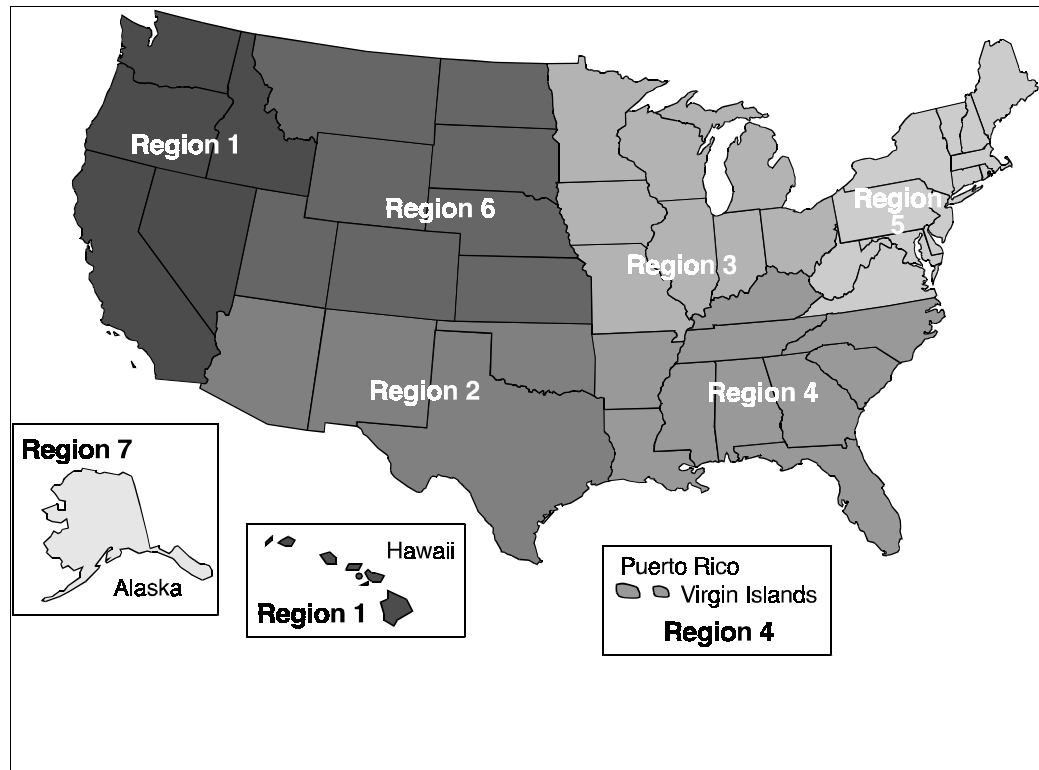

Figure 6-2. U.S. Fish and Wildlife Service Regions.

Additionally, any employee of a state conservation agency that is operating a conservation program with the USFWS (in accordance with section 6(c) of the Endangered Species Act) may take those threatened species of wildlife that are covered by an approved cooperative agreement to carry out conservation programs.

State agencies involved in designing and conducting fish sampling programs in freshwater systems may need to sample fish for human health risk assessments from areas inhabited by threatened or endangered species. In some of these waterbodies under study, threatened or endangered species may be collected incidental to the primary sampling objective. In these cases, the state agency involved in the primary sampling needs to check with the state conservation agency to determine whether a cooperative agreement between the state and the USFWS is in effect. Any questions about the permits for incidental taking of endangered or threatened species resulting from fish sampling programs should be reviewed with the appropriate USFWS regional endangered species liaison officer. If appropriate, the state must apply to the USFWS for an Incidental Take Permit (U.S. DOI, 1999). States are required to submit information on USFWS Form 3-200 with all of the following information provided as part of the permit application:

- A complete description of the sampling activity sought to be authorized
- The common and scientific names of the species sought to be covered by the permit, as well as the number, age, and sex of such species, if known.

The application must also include a conservation plan that specifies

- The impact that will likely result from such incidental taking
- What steps the applicant will take to monitor, minimize, and mitigate such impacts, the funding that will be available to implement such steps, and the procedures to be used to deal with unforeseen circumstances
- What alternative actions to such incidental taking the applicant considered and the reasons why such alternatives are not proposed to be used
- Such other measures that the Director may require as being necessary or appropriate for purposes of the plan.

The completed application should be submitted to

U.S. Fish and Wildlife Service
Ecological Services/Endangered Species Permits
Attention: Regional Permit Coordinator
(see addresses below for each of the seven USFWS regional offices)

Region 1
Pacific Region
Eastside Federal Complex
911 NE 11th Avenue
Portland, OR 97232-4181

Region 2
Southwest Region
P.O. Box 1306
Albuquerque, NM 87103-1306

Region 3
Great Lakes and Big Rivers Region
1 Federal Drive
BHW Federal Building
Fort Snelling, MN 55111

Region 4
Southeast Region
1875 Century Boulevard, Suite 400
Atlanta, GA 30345-3319

Region 5
Northeast Region
300 Westgate Center Drive
Hadley, MA 01035-9589

Region 6
Mountain Prairie Region
134 Union Boulevard
Lakewood, CO 80228

Region 7
Alaska Region
300 Vintage Boulevard, Suite 201
Juneau, AK 99801-7125

States should expect to wait from 3 to 6 months to obtain such a permit and should plan and schedule their permit application submission accordingly.

Marine or Anadromous Threatened and Endangered Species

Each state that intends to sample fish as part of their tissue residue monitoring program and might collect endangered or threatened marine or anadromous species incidental to the purpose of their monitoring effort, must apply to the NMFS for an Incidental Take Permit (U.S. DOC, 1999a). Application forms and detailed instructions for completing these permit applications are available for downloading on the Internet at url:

http://www.nmfs.noaa.gov/prot_res/PR3/Permits/ESAPermit.html. Users should click on <<Incident Take of Listed Species>> under Activity Category and select the PDF or HTML instructions.

States are required to submit information about the following:

- Type of permit
- Date of application
- Name, address, telephone, and fax number of the applicant
- A description of the endangered or threatened species, by common and scientific name, and a description of the status distribution, seasonal distribution, habitat needs, feeding habits, and other biological requirements of the affected species
- A detailed description of the proposed sampling activity, including
 - Anticipated dates and duration of sampling activity
 - Specific location of the activity (latitude and longitude coordinates)
 - An estimate of the total level of activity expected to be conducted

The application must also include a conservation plan based on the best scientific and commercial data available, which specifies

- Anticipated impact of the proposed activity on the listed species, including
 - Estimated number of animals of the listed species and, if applicable, the subspecies or population group and range
 - Type of anticipated taking, such as harassment, predation, competition for space and food, etc.
 - Effects of the take on the listed species, such as descaling, altered spawning activities, potential for mortality

- Anticipated impact of the proposed activity on the habitat of the species and the likelihood of restoration of the affected habitat
- Steps that will be taken to monitor, minimize, and mitigate such impacts, including
 - Specialized equipment, methods of conducting activities, or other means.
 - Detailed monitoring plans
 - Funding available to implement measures taken to monitor, minimize, and mitigate impacts.
- Alternative actions to such taking that were considered and the reasons why those alternatives are not being used.
- A list of all sources of data used in preparation of the plan, including reference reports, environmental assessments and impact statements, and personal communications with recognized experts on the species or activity who may have access to data not published in the current literature.

The application may be submitted electronically if possible (either by e-mail or by mailing a diskette), but one signed original of the complete application must be sent to

Chief, Endangered Species Division
National Marine Fisheries Service, F/PR3
1315 East-West Highway
Silver Spring, Maryland 20910
Telephone (301) 713-1401, Fax (301) 713-0376

States should expect to wait from 3 to 6 months to obtain such a permit and should plan and schedule their permit application submission accordingly.

Threatened or Endangered Sea Turtles

States planning on sampling fish in marine waters inhabited by threatened or endangered species of sea turtles must apply to the NMFS for a Sea Turtle Incidental Take Permit (U.S. DOC, 1999b).

Application forms and detailed instructions for completing these permit applications are available for downloading on the Internet at http://www.nmfs.noaa.gov/prot_res/PR3/Permits/ESAPermit.html.

States are required to submit a cover letter including information on the following:

- Type of permit
- Date of application

- Name, address, telephone, and fax number of the applicant
- A description of each endangered or threatened sea turtle species impacted by the activity, by common and scientific name, and a description of the status, geographic distribution, seasonal distribution, habitat needs, feeding habits, and other biological requirements of the affected species
- A detailed description of the proposed sampling activity (fishery season), including
 - Anticipated dates and duration of sampling activity
 - Specific location of the activity (latitude and longitude coordinates) and fishery effort in that area
 - Other relevant information (e.g., gear description.)

The application must also submit a Conservation Plan based on the best scientific and commercial data available. The Conservation Plan must emphasize techniques, gear types, and general practices to mitigate takes. The Conservation Plan may involve development of new gear types or modification of fishing practices and include the following information

- Anticipated impact of the activity on the listed species of sea turtle, including
 - Estimated number of animals of the listed species impacted, their geographic range, and, if applicable, the subspecies or population group,
 - Type of anticipated taking, such as capture, harassment, predation, competition for space and food, nature of injury
 - Effects of the impact on the listed species, such as descaling, altered reproductive activities, potential for mortality, effects of repeated submergence
- Anticipated impact of the proposed activity on the habitat of the species and the likelihood of restoration of the affected habitat
- Steps that will be taken to monitor, minimize, and mitigate such impacts, including
 - Detailed monitoring plans (e.g., observer programs)
 - Detailed enforcement plans (e.g., monitoring Turtle Excluder Device compliance)
 - Specialized equipment, methods of conducting activities, or other mitigation techniques.
 - Detailed funding plan to implement measures taken to monitor, minimize, and mitigate impacts.
- Alternatives to the activity considered and the reasons why those alternatives are not being used.

- A list of all sources of data used in preparation of the plan, including reference reports, environmental assessments and impact statements, and personal communications with recognized experts on the species or activity who may have access to data not published in the current literature.
- Other measures the Assistant Administrator of NMFS may require as necessary or appropriate for the purposes of the plan.

The following criteria are considered for permit issuance:

- Status of the stock and/or species to be incidentally taken
- Likely direct and indirect impacts of the activity on sea turtles
- Availability and effectiveness of monitoring and enforcement programs
- Public comments received during the 30-day public notice and comment period
- Adequate funding for the Conservation Plan
- The fact that taking will not appreciably reduce the likelihood of survival and recovery of the species in the wild.

An issued permit would

- Require regular reporting and rights of inspection
- Identify species and number of animals allowed to be taken incidentally
- Specify the authorized method of incidental taking
- Require procedures for captured sea turtles (i.e., resuscitation techniques, disposal)
- Potentially impose administrative fees
- Establish duration of the permit
- Specify any other terms or conditions that the Assistant Administrator of NMFS identifies as necessary or appropriate
- The application may be submitted electronically if possible (either by e-mail or by mailing a diskette), but one signed original of the complete application must be sent to

Chief, Endangered Species Division
National Marine Fisheries Service, F/PR
1315 East-West Highway
Silver Spring, Maryland 20910
Telephone (301) 713-1401, Fax (301) 713-0376

States should expect to wait from 3 to 6 months to obtain such a permit and should plan and schedule their permit application submission accordingly.

6.1.1.2 Target Species and Size Class Selection—

After reviewing information on each sampling site, the field collection staff should identify the target species that are likely to be found at the site. Target species recommended for screening studies in freshwater systems are shown in Tables 3-1, 3-2, and 3-4. Tables 3-10 through 3-16 list recommended species for estuarine/marine areas. In freshwater ecosystems, one bottom-feeding and one predator fish species should be collected. In estuarine/marine ecosystems, either one bivalve species and one finfish species or two finfish species should be collected. Second- and third-choice target species should be selected in the event that the recommended target species are not collected at the site. The same criteria used to select the recommended target species (Section 3.2) should be used to select alternate target species. In all cases, the primary selection criterion should be that the target species is commonly consumed locally and is of harvestable size.

EPA recognizes that resource limitations may influence the sampling strategy selected by a state. If monitoring resources are severely limited, precluding performance of any Tier 2 intensive studies (Phase I and Phase II), EPA recommends three sampling options to states for collecting additional samples during the screening studies. These options are:

1. Collecting one composite sample for each of three size (age) classes of each target species
2. Collecting replicate composite samples for each target species
3. Collecting replicate composite samples for each of three size (age) classes of each target species.

Option 1 (single composite analysis for each of three size classes) provides additional information on size-specific levels of contamination that may allow states to issue an advisory for only the most contaminated size classes while allowing other size classes of the target species to remain open to fishing. The state could analyze the composite sample from the largest size class first. If any SVs are exceeded, analysis of the smaller size class composite samples could be conducted. This option, however, does not provide any additional information for estimating the variability of the contamination level in any specific size class. To obtain information for estimating the variability of the contamination level in the target species, states could separately analyze each individual fish specimen in

any composite that exceeded the SVs. **Note:** This option of analyzing individual fish within a composite sample is more resource-intensive with respect to analytical costs but is currently used by some Great Lakes states.

Option 2 (replicate analyses of one size class) provides additional statistical power that would allow states to estimate the variability of contamination levels within the one size class sampled; however, it does not provide information on size-specific contamination levels.

Option 3 (replicate analyses of three size classes) provides both additional information on size-specific contamination levels and additional statistical power to estimate the variability of the contaminant concentrations in each of three size classes of the target species. If resources are limited, the state could analyze the replicate samples for the largest size class first; if the SVs are exceeded, analysis of the smaller size class composite samples could then be conducted.

Note: The correlation between increasing size (age) and contaminant tissue concentration observed for some freshwater finfish species (Voiland et al., 1991) may be much less evident in estuarine/marine finfish species (G. Pollock, California Environmental Protection Agency, personal communication, 1993). The movement of estuarine and marine species from one niche to another as they mature may change their exposure at a contaminated site. Thus, size-based sampling in estuarine/marine systems should be conducted only when it is likely to serve a potential risk management outcome.

6.1.1.3 Target Analyte Selection—

All 25 recommended target analytes listed in Table 4-1 should be considered for inclusion in screening studies unless reliable historic tissue, sediment, or pollutant source data indicate that an analyte is not present at a level of concern for human health. Additional regional or site-specific target analytes should be included in screening studies when there is indication or concern that such contaminants are a potential health risk to local fish or shellfish consumers. Historic data on water, sediment, and tissue contamination and priority pollutant scans from known point source discharges or nonpoint source monitoring should be reviewed to determine whether analysis of additional analytes is warranted.

6.1.1.4 Target Analyte Screening Values—

To enhance national consistency in screening study data, states should use the target analyte screening values listed in Tables 5-3 and 5-4 to evaluate tissue contaminant data. Specific methods used to calculate SVs for noncarcinogenic and carcinogenic target analytes, including examples of SVs calculated for selected subpopulations, are given in Sections 5.1 and 5.2. If target analytes different from those default SVs shown in Tables 5-3 and 5-4 are included in a screening study, these calculation procedures should be used to estimate SVs based on typical exposure assumptions for the fish-consuming public for the

additional compounds. **Note:** If the state chooses to use a different risk level or consumption rate to address site-specific considerations, the corresponding SVs should be calculated prior to initiation of chemical analyses to ensure that the detection limits of the analytical procedures are sufficiently low to allow reliable quantitation at or below the chosen SV. If analytical methodology is not sensitive enough to reliably quantitate target analytes at or below selected SVs (see Sections 5.2 and 8.2.2 and Table 8-4), program managers must determine appropriate fish consumption guidance based on lowest detectable concentrations or provide justification for adjusting SVs to values at or above achievable method detection limits. It should be emphasized that when SVs are below method detection limits, the failure to detect a target analyte cannot be assumed to indicate that there is no cause for concern for human health effects.

6.1.1.5 Sampling Times—

If program resources are sufficient, biennial screening of waterbodies is recommended where commercial, recreational, or subsistence harvesting is commonly practiced (as identified by the state). Data from these screenings can then be used in the biennial state 305(b) reports to document the extent of support of Clean Water Act goals. If biennial screening is not possible, then waterbodies should be screened at least once every 5 years.

Selection of the most appropriate sampling period is very important, particularly when screening studies may be conducted only once every 2 to 5 years. **Note:** For screening studies, sampling should be conducted during the period when the target species is most frequently harvested (U.S. EPA, 1989d; Versar, 1982).

In fresh waters, as a general rule, the most desirable sampling period is from late summer to early fall (i.e., August to October) (Phillips, 1980; Versar, 1982). The lipid content of many species (which represents an important reservoir for organic pollutants) is generally highest at this time. Also, water levels are typically lower during this time, thus simplifying collection procedures. This late summer to early fall sampling period should not be used, however, if (1) it does not coincide with the legal harvest season of the target species or (2) the target species spawns during this period. **Note:** If the target species can be legally harvested during its spawning period, however, then sampling to determine contaminant concentrations should be conducted during this time.

A third exception to the late summer to early fall sampling recommendation concerns monitoring for the organophosphate pesticides. Sampling for these compounds should be conducted during late spring or early summer within 1 to 2 months following pesticide application because these compounds are degraded and metabolized relatively rapidly compared to organochlorine pesticides. **Note:** The target species should be sampled during the spring only if the species can be legally harvested at this time.

In estuarine and coastal waters, the most appropriate sampling time is during the period when most fish are caught and consumed (usually summer for recreational and subsistence fishers). For estuarine/marine shellfish (bivalve molluscs and crustaceans), two situations may exist. The legal harvesting season may be strictly controlled for fisheries resource management purposes or harvesting may be open year round. In the first situation, shellfish contaminant monitoring should be conducted during the legal harvest period. In the second situation, monitoring should be conducted to correspond to the period when the majority of harvesting is conducted during the legal season. state staff may have to consider different sampling times for target shellfish species if differences in the commercial and recreational harvesting period exist.

Ideally, the sampling period selected should avoid the spawning period of the target species, including the period 1 month before and 1 month after spawning, because many aquatic species are subject to stress during spawning. Tissue samples collected during this period may not always be representative of the normal population. For example, feeding habits, body fat (lipid) content, and respiration rates may change during spawning and may influence pollutant uptake and clearance. Collecting may also adversely affect some species, such as trout or bass, by damaging the spawning grounds. Most fishing regulations protect spawning periods to enhance propagation of important fishery species. Species-specific information on spawning periods and other life history factors is available in numerous sources (e.g., Carlander, 1969; Emmett et al., 1991; Pflieger, 1975; Phillips, 1980). In addition, digitized life history information is available in many states through the Multistate Fish and Wildlife Information Systems (1990) on the web at <http://fwie.fw.vt.edu>.

Exceptions to the recommended sampling periods for freshwater and estuarine/marine habitats will be determined by important climatic, regional, or site-specific factors that favor alternative sampling periods. For many states, budgetary constraints may require that most sampling be conducted during June, July, and August when temporary help or student interns are available for hire. The actual sampling period and the rationale for its selection should be documented fully and the final data report should include an assessment of sampling period effects on the results.

6.1.1.6 Sample Type—

Composite samples of fish fillets or of the edible portions of shellfish are recommended for analysis of target analytes in screening studies (U.S. EPA 1987b; 1989d). For health risk assessments, the recommended composite sample type for chemical analysis should be based on both the study objectives and the sample type consumed by the target population of concern. For example, using skinless fillets for assessing mercury exposures for members of the general population and most recreational fishers is most conservative. Because mercury is differentially concentrated in muscle tissue, leaving the skin on the fish fillet actually results in a lower mercury concentration per gram of skin-

on fillet than per gram of skin-off fillet (Gutenmann and Lisk, 1991). In addition, few consumers in the general population eat the skin of the fish, which justifies its removal for analysis, particularly when monitoring concerns are directed solely at mercury contamination. Analysis of skinless fillets may also be more appropriate for some target species such as catfish and other scaleless finfish species. In contrast, using whole fish with skin-on as the sample type for assessing PCBs, dioxins/furans, or organochlorine pesticide exposures in populations of Native Americans, Asian Americans, Caribbean-Americans, or other ethnic groups that consume whole fish in a stew or soup is warranted because these contaminants accumulate in fatty tissues of the fish. Cooking the whole fish to make a stew or soup releases the PCBs, dioxins/furans, or organochlorine contaminants into the broth; thus, the whole fish should be analyzed to mirror the way the consumer prepares the fish. Similarly, using skin-on fillets with belly-flap included for most other scaled fish to evaluate PCB, dioxin/furan, or organochlorine pesticide exposures in the general fishing population or among recreational fishers is appropriate since this is a standard filleting method (see Sections 7.2.2.6 and 7.2.2.7). This method also allows for the inclusion of the fatty belly flap tissue and skin in which organochlorines, PCBs, and dioxins/furans concentrate and takes into account the fact that some consumers may not neatly trim the more highly contaminated fatty tissue from the edible muscle fillet tissue.

For shellfish samples, the recommended composite sample type for chemical analysis also should be based on both the study objectives and the sample type consumed by the target population at risk. The specific tissues considered to be edible will vary among target shellfish species (see Section 7.2.4.4) based on local consumer preference. For example, several states (Maine, Massachusetts, New Hampshire, New Jersey and New York) have issued advisories for a variety of contaminants (PCBs, dioxins/furans, or cadmium) in specific glands or tissues of crustaceans such as lobsters and crabs. Some consumers of lobsters, *Homarus americanus*, enjoy eating the tomalley (digestive gland of the lobster), which has been shown to contain higher concentrations of chemical contaminants than the claw, leg, or tail meat typically consumed by members of the general population. For this reason, the tomalley should be analyzed separately if the target population consumes this organ so that a determination can be made as to whether contaminant concentrations in the tomalley only, or in the claw, leg, and tail meat are above levels of human health concern. Similarly, for the blue crab, *Callinectes sapidus*, as well as other crab species, the hepatopancreas (digestive gland) is consumed by some individuals and has also been found to contain higher concentrations of contaminants than claw, leg, or body muscle tissue. If the target population of concern consumes the hepatopancreas, then to best evaluate the risk of consumption from this tissue, it should be analyzed separately from the claw, leg, and body muscle tissue. A precise description of the sample type (including the number and size of the individual crustaceans in the composite) should be documented in the program record for each target species.

A similar situation exists with respect to selection of the appropriate sample type for bivalve molluscs. For example, while most individuals in the general population consume whole oysters (e.g., *Crassostrea virginica* or *C. gigas*), clams (e.g., *Mercenaria mercenaria*) or mussels (e.g., *Mytilus edulis* or *M. californianus*), only the adductor muscle tissue is typically consumed of the scallops (*Aropecten irradians* or *A. gibbus*). For bivalves in general, the adductor muscle is typically less contaminated than gill, mantle, and digestive organ tissues primarily due to the filter-feeding nature of these animals. Therefore, the adductor muscle of scallops should be analyzed separately for the general population. If the whole body of the scallop is to be consumed as part of a stew or soup by the target population of concern, the state should also conduct analysis of the whole body of the scallop as part of a risk assessment. A precise description of the sample type (including the number and size of the individual bivalves in the composite) should be documented in the program record for each target species.

For freshwater turtles also, the study objectives and sample type consumed by the target population at risk must be of primary consideration. However, EPA recommends use of individual turtle samples rather than composite samples for evaluating turtle tissue contamination. As with shellfish, the tissues of freshwater turtles considered to be edible vary based on the dietary and culinary practices of local populations (see Section 7.2.3.3). For example, New York and Minnesota have advisories for snapping turtles that recommend that consumers who wish to eat turtle meat should trim away all fat and discard the liver and eggs of the turtle (if they are still in the female's body cavity) prior to cooking. These three tissues (fat, liver, and eggs) have been shown to accumulate extremely high concentrations of a variety of contaminants in comparison to muscle tissue (Bishop et al., 1996; Bonin et al. 1995; Bryan et al., 1987; Hebert et al., 1993; Olafsson et al., 1983; 1987; Ryan et al., 1986; and Stone et al., 1980). States should consider monitoring pollutant concentrations in all three tissues in addition to muscle tissue. If residue analysis reveals the presence of high concentrations of contaminants in liver, eggs, and fatty tissue, but not in the muscle tissue, then the state can make the general recommendation to consumers to discard the three most lipophilic tissues to reduce the risk of exposure. This action is most useful when such lipophilic contaminants such as dioxins/furans, PCBs, and organochlorine pesticides are the contaminants involved.

Note: Composite samples are homogeneous mixtures of samples from two or more individual organisms of the same species collected at a particular site and analyzed as a single sample. Because the costs of performing individual chemical analyses are usually higher than the costs of sample collection and preparation, composite samples are most cost-effective for estimating average tissue concentrations of target analytes in target species populations. Besides being cost-effective, composite samples also ensure adequate sample mass to allow analyses for all recommended target analytes. A disadvantage of using composite samples, however, is that extreme contaminant concentration values for individual organisms are lost.

In screening studies, EPA recommends that states analyze one composite sample for each of two target species at each screening site. Organisms used in a composite sample

- Must all be of the same species
- Should satisfy any legal requirements of harvestable size or weight, or at least be of consumable size if no legal harvest requirements are in effect
- Should be of similar size so that the smallest individual in a composite is no less than 75 percent of the total length (size) of the largest individual
- Should be collected at the same time (i.e., collected as close to the same time as possible but no more than 1 week apart) [**Note:** This assumes that a sampling crew was unable to collect all fish needed to prepare the composite sample on the same day. If organisms used in the same composite are collected on different days (no more than 1 week apart), they should be processed within 24 hours as described in Section 7.2 except that individual fish may have to be filleted and frozen until all the fish to be included in the composite are delivered to the laboratory. At that time, the composite homogenate sample may be prepared.]
- Should be collected in sufficient numbers to provide a 200-g composite homogenate sample of edible tissue for analysis of recommended target analytes.

Individual organisms used in composite samples must be of the same species because of the significant species-specific bioaccumulation potential. Accurate taxonomic identification is essential in preventing the mixing of closely related species with the target species. **Note:** Individuals from different species should not be used in a single composite sample (U.S. EPA, 1989d, 1990d).

For cost-effectiveness, EPA recommends that states collect only one size class for each target species and focus on the larger individuals commonly harvested by the local population. Ideally, each composite sample for a specific species should contain the same number of individual fish and the individuals within each target species composite should be of similar size within a target size range so that the composite samples for a particular species are comparable over a wide geographic area. This is particularly important when states want to compare data on an individual species that might be used to establish a statewide advisory.

For persistent chlorinated organic compounds (e.g., DDT, dioxin, PCBs, and toxaphene) and methylmercury, the larger (older) individuals within a population are generally the most contaminated (Phillips, 1980; Voiland et al., 1991). As noted earlier, this correlation between increasing size and increasing contaminant concentration is most striking in freshwater finfish species but is less evident in estuarine and marine species. Size is used as a surrogate for age, which

provides some estimate of the total time the individual organism has been at risk of exposure. Therefore, the primary target size range ideally should include the larger individuals harvested at each sampling site. In this way, the states will maximize their chances of detecting high levels of chemical contamination in the single composite sample collected for each target species. If this ideal condition cannot be met, the field sampling team should retain individuals of similar length that fall within a secondary target size range.

Individual organisms used in composite samples should be of similar size (WDNR, 1988). **Note:** Ideally, for fish or shellfish, the total length (or size) of the smallest individual in any composite sample should be no less than 75 percent of the total length (or size) of the largest individual in the composite sample (U.S. EPA, 1990d). For example, if the largest fish is 200 mm, then the smallest individual included in the composite sample should be at least 150 mm. In the California Mussel Watch Program, a predetermined size range (55 to 65 mm) for the target bivalves (*Mytilus californianus* and *M. edulis*) is used as a sample selection criterion at all sampling sites to reduce size-related variability (Phillips, 1988). Similarly, the Texas Water Commission (1990) specifies the target size range for each of the recommended target fish species collected in the state's fish contaminant monitoring program.

Individual organisms used in a composite sample ideally should be collected at the same time so that temporal changes in contaminant concentrations associated with the reproduction cycle of the target species are minimized.

Each composite sample should contain 200 g of tissue so that sufficient material will be available for the analysis of all recommended target analytes. A larger composite sample mass may be required when the number of target analytes is increased to address regional or site-specific concerns. However, the tissue mass may be reduced in the **Tier 2** intensive studies (Phase I and II) when a limited number of specific analytes of concern have been identified (see Section 7.2.2.9). Given the variability in size among target species, only approximate ranges can be suggested for the number of individual organisms to collect to achieve adequate mass in screening studies (U.S. EPA, 1989d; Versar, 1982). For fish, 3 to 10 individuals should be collected for a composite sample for each target species; for shellfish, 3 to 50 individuals should be collected for a composite sample. In some cases, however, more than 50 small shellfish (e.g., mussels, shrimp, crayfish) may be needed to obtain the recommended 200-g sample mass. **Note:** The same number of individuals should be used in each composite sample for a given target species at each sampling site.

Deviations from the recommended study design have implications that may make the statistical analyses more complicated. The statistical methods for analyzing composite samples are made tractable and easier-to-use by simplifying the study design. Using equal numbers of fish in replicate composite samples is one way to do this. For example, with equal numbers of fish, the arithmetic average of the replicate composite measurements is an unbiased estimator of the population

mean. When unequal numbers are used, the arithmetic average is no longer unbiased. Instead, a weighted average of the composite measurements is calculated, where the weight for each composite reflects the number of fish it is made up of. Oftentimes fish are lost or damaged prior to compositing. When several fish are damaged or lost, the allocation of the remaining fish to composites may be reconfigured to allow equal numbers of fish in composites. If this is not possible, care should be taken to adjust the statistical procedures to account for the unequal allocations.

The use of sizes of fish exceeding the size range recommended for compositing may introduce more variability. If it is the size range within each composite that is broadened (e.g., 100-200 mm instead of 150-200 mm), the variability within the composite may increase. If additional composites are made with fish exceeding the recommended size ranges (e.g., adding composites of fish of size 300-450 mm when the target size is no more than 250 mm), this may increase the variability between composites of different size ranges. Overall inferences made from composites of different size ranges will have increased variability associated with them (e.g., wider confidence intervals).

Differences in the numbers of replicates at different sampling locations may complicate any comparisons to be made between locations or overall conclusions to be obtained by combining the results from different sampling locations. As with unequal numbers of fish in composites, unequal numbers of replicate samples complicate the statistical calculations. The appropriate weighted estimates should be used when combining information from different sampling locations. Consider, for instance, a state that monitors five lakes each year. If the state uses the same target fish species, the same number of fish per composite and the same size ranges, the overall mean level of contamination will be a straightforward average over the five locations if the same number of replicates are used at each location. However, if unequal numbers of replicates are used, the information contributed by each location is not the same and must be weighted accordingly.

As alluded to above, one limitation of using composite samples is that information on extreme levels of chemical contamination in individual organisms is lost. Therefore, EPA recommends that the residual individual homogenates be saved to allow for analyses of individual specimens if resources permit (Versar, 1982). Analysis of individual homogenates allows states to estimate the underlying population variance which, as described in Section 6.1.2.6, facilitates sample size determination for the intensive studies. Furthermore, individual homogenates may also be used to provide materials for split and spike samples for routine QC procedures either for composites or individual organisms (see Section 8.3). The circumstances in which the analysis of individual fish samples might be preferred over the analysis of composite samples is described in more detail in Appendix C.

Recommended sample preparation procedures are discussed in Section 7.2.

6.1.1.7 Replicate Samples—

The collection of sufficient numbers of individual organisms from a target species at a site to allow for the independent preparation of more than one composite sample (i.e., sample replicates) is strongly encouraged but is **option** in screening studies. If resources and storage are available, single replicate (i.e., duplicate) composite samples should be collected at a minimum of 10 percent of the screening sites (U.S. EPA, 1990d). The collection and storage of replicate samples, even if not analyzed at the time due to inadequate resources, allow for followup QC checks. These sites should be identified during the planning phase and sample replication specifications noted on the sample request form. If replicate field samples are to be collected, states should follow the guidance provided in Section 6.1.2.7. **Note:** Additional replicates must be collected at each site for each target species if statistical comparisons with the target analyte SVs are required in the state monitoring programs. The statistical advantages of replicate sampling are discussed in detail in Section 6.1.2.7.

6.1.2 Intensive Studies (Tier 2)

The primary aim of intensive studies is to characterize the magnitude and geographic extent of contamination in harvestable fish and shellfish species at those screening sites where concentrations of target analytes in tissues were found to be above selected SVs. Intensive studies should be designed to verify results of the screening study, to identify specific fish and shellfish species and size classes for which advisories should be issued, and to determine the geographic extent of the fish contamination. In addition, intensive studies should be designed to provide data for states to tailor their advisories based on the consumption habits or sensitivities of specific local fish-consuming subpopulations.

State staff should plan the specific aspects of field collection activities for each intensive study site after a thorough review of the aims of intensive studies (Section 2.2) and the fish contaminant data obtained in the screening study. All the factors that influence sample collection activities should be considered and specific aspects of each should be documented clearly by the program manager on the sample request form for each site.

6.1.2.1 Site Selection—

Intensive studies should be conducted at all screening sites where the selected SV for one or more target analytes was exceeded. The field collection staff should review a 7.5-minute (1:24,000 scale) USGS hydrologic map of the study site and all relevant water, sediment, and tissue contaminant data. The site selection factors evaluated in the screening study (Section 6.1.1.1) must be reevaluated before initiating intensive study sampling.

States should conduct **Tier 2** intensive studies in two phases if program resources allow. **Phase I intensive studies** should be more extensive investigations of the magnitude of tissue contamination at suspect screening sites. **Phase II intensive studies** should define the geographic extent of the contamination around these suspect screening sites in a variety of size (age) classes for each target species. The field collection staff must evaluate the accessibility of these additional sites and develop a sampling strategy that is scientifically sound and practicable.

Selection of Phase II sites may be quite straightforward where the source of pollutant introduction is highly localized or if site-specific hydrologic features create a significant pollutant sink where chemically contaminated sediments accumulate and the bioaccumulation potential might be enhanced (U.S. EPA, 1986d). For example, upstream and downstream water quality and sediment monitoring to bracket point source discharges, outfalls, and regulated disposal sites showing contaminants from surface runoff or leachate can often be used to characterize the geographic extent of the contaminated area. Within coves or small embayments where streams enter large lakes or estuaries, the geographic extent of contamination may also be characterized via multilocational sampling to bracket the areas of concern. Such sampling designs are clearly most effective where the target species are sedentary or of limited mobility (Gilbert, 1987). In addition, the existence of barriers to migration, such as dams, should be taken into consideration.

Site selection considerations should also include the number of samples necessary to characterize different waterbody types (lakes, rivers, estuaries, and coastal marine waters) based on both the hydrodynamics of the waterbody type including waterbody size as well as the inherent migratory nature of the species under consideration. Typically, as the size of a waterbody increases (from small lakes to larger lakes to Great Lakes or from streams, to rivers, to estuaries, to coastal marine waters), the number of samples that need to be collected to maintain a selected statistical power (i.e., 70 percent) as well as the number of sampling stations needed to define the area that should be under advisory both increase. For example, fish inhabiting relatively small lakes are likely to be exposed to a relatively homogeneous aquatic environment of contaminant concentrations. In a riverine, estuarine, or coastal situation, however, the hydrodynamics of the ecosystem can greatly affect the magnitude and nature of contamination in the water that fish encounter as they move up and downstream of areas with distinct nonpoint and point source inputs of contamination. Thus, the amount of time that any fish spends exposed to the contamination may be highly variable as compared to the relatively homogeneous exposures that might occur in smaller, less hydrologically dynamic lake ecosystems.

Overlaid on the hydrodynamic differences of each type of ecosystem and the spatial distribution of both nonpoint and point sources of pollution that can be encountered in larger ecosystems are the inherent behavioral differences in fish and shellfish species with respect to the size of their home range as well as to whether, at some time or times in their life cycle, they migrate widely to other

more or less contaminated areas. Consider the bluegill sunfish, a common inhabitant of small lakes and creeks. The home range for this species is typically less than 0.25 acres (~1,000 m²) in lakes and does not exceed 28 m in streams (Carlander, 1969; Hardy, 1978). Smallmouth bass, a riverine species, have a home range of 500 to 4,500 m², but typically migrate up to 45 km (28 miles) (Reid and Rabeni, 1989; Todd and Rabeni, 1989). In contrast, many Great Lake fish species, as well as riverine, estuarine, and marine species migrate considerable distances during spawning periods. Several Great Lakes species also move upstream considerable distances into tributary rivers to spawn. Lake trout in the Great Lakes have been found to migrate up to 300 km (186 miles) with larger fish migrating 300 miles (483 km) (Daly et al., 1962; Mills, 1971; Willers, 1991). For many marine species, estuaries are the spawning areas for the adults and nursery areas for the developing juveniles, who eventually travel offshore as adults and return again to the estuaries to spawn. For these species, migratory or seasonal movements both from inshore to offshore areas and north and south migrations along the coasts can take place. Obviously, the number of samples needed to define an area under advisory for bluegill sunfish inhabiting a relatively homogeneous environment with respect to contaminant concentrations is quite different from that required for the more mobile species like the smallmouth bass and lake trout.

For shellfish, similar considerations are necessary. Bivalve molluscs like the oyster or mussel cement themselves to hard substrate as young spat and are unable to move away from pollution effects once they have settled out of the water column. Although clams and scallop species are slightly more mobile, they also typically stay in the general area in which they first settled out of the water column. For crustaceans like the blue crab and lobsters, however, movements both into and out of estuaries as well as into deeper water offshore are possible. As the complexity of the hydrodynamics of an ecosystem increases and the mobility of the target species increases, so too does the number of samples and the number of sampling stations required to delineate the area where contaminated individuals may be encountered by the fishing public.

6.1.2.2 Target Species and Size Class Selection—

Whenever possible, the target species found in the screening study to have elevated tissue concentrations of one or more of the target analytes should be resampled in the intensive study. Recommended target species for freshwater sites are listed in Tables 3-1, 3-2, and 3-4; target species for estuarine/marine waters are listed in Tables 3-10 through 3-12 for Atlantic Coast estuaries, in Table 3-13 for Gulf Coast estuaries, and in Tables 3-14 through 3-16 for Pacific Coast estuaries. If the target species used in the screening study are not collected in sufficient numbers, alternative target species should be selected using criteria provided in Section 3.2. The alternative target species should be specified on the sample request form.

For Phase I intensive studies, states should collect replicate composite samples of one size class for each target species and focus sampling on larger individuals commonly harvested by the local population (as appropriate). If contamination of this target size class is high, Phase II studies should include collection of replicate composite samples of three size classes within each target species.

EPA recognizes that resource limitations may influence the sampling strategy selected by a state. If monitoring resources are limited for intensive studies, states may determine that it is more resource-efficient to collect replicate composite samples of three size classes (as recommended for Phase II studies) during Phase I sampling rather than revisit the site at a later time to conduct Phase II intensive studies. In this way, the state may save resources by reducing field sampling costs associated with Phase II intensive studies.

By sampling three size (age) classes, states collect data on the target species that may provide them with additional risk management options. If contaminant concentrations are positively correlated with fish and shellfish size, frequent consumption of smaller (less contaminated) individuals may be acceptable even though consumption of larger individuals may be restricted by a consumption advisory. In this way, states can tailor an advisory to protect human health and still allow restricted use of the fishery resource. Many Great Lakes states have used size (age) class data to allow smaller individuals within a given target species to remain fishable while larger individuals are placed under an advisory.

6.1.2.3 Target Analyte Selection—

Ideally, Phase I intensive studies should include only those target analytes found in the screening study to be present in fish and shellfish tissue at concentrations exceeding selected SVs (Section 5.2). Phase II studies should include only those target analytes found in Phase I intensive studies to be present at concentrations exceeding SVs. In most cases, the number of target analytes evaluated in Phase I and II intensive studies will be significantly smaller than the number evaluated in screening studies.

6.1.2.4 Target Analyte Screening Values—

Target analyte SVs used in screening studies should also be used in Phase I and II intensive studies. Specific methods used to calculate SVs for noncarcinogenic and carcinogenic target analytes, including examples of SVs calculated for various exposure scenarios, are given in Section 5.1.

6.1.2.5 Sampling Times—

To the extent that program resources allow, sampling in intensive studies should be conducted during the same period or periods during which screening studies were conducted (i.e., when the target species are most frequently harvested for consumption) and should be conducted preferably within 1 year of the screening

studies. In some cases, it may be best to combine Phase I and Phase II sampling to decrease both the time required to obtain adequate data for issuance of specific advice relative to species, size classes, and geographic extent and/or the monitoring costs entailed in revisiting the site (see Section 6.1.2.2).

States should follow the general guidance provided in Section 6.1.1.5 for recommended sampling times. The actual sampling period and rationale for its selection should be documented fully for Phase I and II studies.

6.1.2.6 Sample Type—

Composite samples of fish fillets or the edible portions of shellfish are recommended for analysis of target analytes in intensive studies. The general guidance in Section 6.1.1.6 should be followed to prepare composite samples for each target species. In addition, separate composite samples may be prepared for selected size (age) classes within each target species, particularly in Phase II studies after tissue contamination has been verified in Phase I studies. Because the number of replicate composite samples and the number of fish and shellfish per composite required to test whether the site-specific mean contaminant concentration exceeds the selected SV are intimately related, both will be discussed in the next section.

Note: The same number of individual organisms should be used to prepare all replicate composite samples for a given target species at a given site. If this number is outside the recommended range, documentation should be provided.

Recommended sample preparation procedures are discussed in Section 7.2.

States interested in analyzing target analyte residues in individual fish or shellfish samples should review information presented in Appendix C.

6.1.2.7 Replicate Samples—

In intensive studies (Phases I and II), EPA recommends that states analyze replicate composite samples of each target species at each sampling site.

Replicate composite samples should be as similar to each other as possible. In addition to being members of the same species, individuals within each composite should be of similar length (size) (see Section 6.1.1.6). The relative difference between the average length (size) of individuals within any composite sample from a given site and the average of the average lengths (sizes) of individuals in all composite samples from that site should not exceed 10 percent (U.S. EPA, 1990d). To determine this, states should first calculate the average length of the target species fish constituting each composite replicate sample from a site. Then, states should take the average of these averages for the site. In the following example, the average of the average lengths of individuals (± 10 percent) in five replicate composite samples is calculated to be 310 (± 31) mm.

<u>Replicate</u>	<u>Average Length of Individual Fish in Composite Sample (mm)</u>
1	300
2	320
3	330
4	280
5	320

Average of the average length ($\pm 10\%$) = 310 (± 31) mm.

Therefore, the acceptable range for the average length of individual composite samples is 279 to 341 mm, and the average length of individual fish in each of the five replicate composites shown above falls within the acceptable average size range.

All replicate composite samples for a given sampling site should be collected within no more than 1 week of each other so that temporal changes in target analyte concentrations associated with the reproductive cycle of the target species are minimized.

6.1.2.7.1 Guidelines for Determining Sample Sizes—This section provides general guidelines for estimating the number of replicate composite samples per site (n) and the number of individuals per composite (m) required to test the null hypothesis that the mean target analyte concentration of replicate composite samples at a site is equal to the SV versus the alternative hypothesis that the mean target analyte concentration is greater than the SV. These guidelines are applicable to any target species and any target analyte.

Note: It is not possible to recommend a single set of sample size requirements (e.g., number of replicate composite samples per site and the number of individuals per composite sample) for all fish and shellfish contaminant monitoring studies. Rather, EPA presents a more general approach to sample size determination that is both scientifically defensible and cost-effective. At each site, states must determine the appropriate number of replicate composite samples and of individuals per composite sample based on

- Site-specific estimations of the population variance of the target analyte concentration
- Fisheries management considerations
- Statistical power consideration.

If the population variance of the target analyte concentrations at a site is small, fewer replicate composite samples and/or fewer individuals per composite sample may be required to test the null hypothesis of interest with the desired statistical

power. In this case, using sample sizes that are larger than required to achieve the desired statistical power would not be cost-effective.

Alternatively, suppose EPA recommended sample sizes based on an analyte concentration with a population variance that is smaller than that of the target analyte. In this case, the EPA-recommended sample size requirements may be inadequate to test the null hypothesis of interest at the statistical power level selected by the state. Therefore, EPA recommends an approach that provides the flexibility to sample less in those waters where the target analyte concentrations are less variable, thereby reserving sampling resources for those site-specific situations where the population variance of the target analyte tissue concentration is greater.

EPA recommends the following statistical model, which assumes that z_i is the contaminant concentration of the i th replicate composite sample at the site of interest where $i=1,2,3,\dots,n$ and, furthermore, that each replicate composite sample is comprised of m individual fish fillets of equal mass. Let \bar{z} be the mean target analyte concentration of observed replicate composite samples at a site. Ignoring measurement error, the variance of \bar{z} is

$$\text{Var}(\bar{z}) = \sigma^2/(nm) \quad (6-1)$$

where

- σ^2 = Population variance
- n = Number of replicate composite samples
- m = Number of individual samples in each composite sample.

To test the null hypothesis that the mean target analyte concentration across the n replicate composite samples is equal to the SV versus the alternative hypothesis that the mean target analyte concentration is greater than the SV, the estimate of the $\text{Var}(\bar{z})$, s^2 , is

$$s^2 = [\sum(z_i - \bar{z})^2] / [n(n - 1)] \quad (6-2)$$

where the summation occurs over the n composite samples. Under the null hypothesis, the following statistic

$$(\bar{z} - \text{SV}) / s \quad (6-3)$$

has a Student-t distribution with $(n - 1)$ degrees of freedom (Cochran, 1977; Kish, 1965). The degrees of freedom are one less than the number of composite samples.

Note: Use of a single composite sample precludes estimating the variability of the mean target analyte concentration. The estimator s^2 can only be calculated with at least two (but preferably three or more) replicate composite samples.

An optimal sampling design would specify the minimum number of replicate composite samples (n) and of individuals per composite (m) required to detect a minimum difference between the selected SV and the mean target analyte concentration of replicate composite samples at a site. Design characteristics necessary to estimate the optimal sampling design include

- Minimum detectable difference between the site-specific mean target analyte concentration and the selected SV
- Power of the hypothesis test (i.e., the probability of detecting a true difference when one exists)
- Level of significance (i.e., the probability of rejecting the null hypothesis of no difference between the site-specific mean target analyte concentration and the SV when a difference does not exist)
- Population variance, σ^2 (i.e., the variance in target analyte concentrations among individuals from the same species, which the statistician often must estimate from prior information)
- Cost components (including fixed costs and variable sample collection, preparation, and analysis costs).

In the absence of such design specifications, guidance for selecting the number of replicate composite samples at each site and the number of fish per composite sample is provided. This guidance is based on an investigation of the precision of the estimate of σ^2/nm and of statistical power.

Note: Under optimal field and laboratory conditions, at least two replicate composite samples are required at each site for variance estimation. To minimize the risk of a destroyed or contaminated composite sample precluding the site-specific statistical analysis, a **minimum** of three replicate composite samples should be collected at each site if possible. Because three replicate composite samples provide only two degrees of freedom for hypothesis testing, additional replicate composite samples are recommended.

The stability of the estimated standard error of \bar{z} must also be considered because this estimated standard error is the denominator of the statistic for testing the null hypothesis of interest. A measure of the stability of an estimate is its statistical precision. The assumption is made that the z_i 's come from a normal distribution, and then the standard error of $\hat{\sigma}^2 / nm$ is defined as a product of $\hat{\sigma}^2$ and a function of n (the number of replicate composite samples) and m (the number of fish per composite). A fortunate aspect of composite sampling is that the composite target analyte concentrations tend to be normally distributed via the Central Limit Theorem. This formulation is used to determine which combinations of n and m are associated with a more precise estimate of σ^2/nm .

Modifying Cochran (1963) to reflect the normality assumption and the sampling design of n replicate composite samples and m fish per composite sample, the function of n and m of interest is shown in square brackets:

$$se \left(\frac{\hat{\sigma}}{nm} \right) = \sigma^2 \left[\frac{2}{n^2 m^2 (n-1)} \right]^{1/2} \quad (6-4)$$

Table 6-1 provides values of this function for various combinations of m and n. The data presented in Table 6-1 suggest that, as either n or m increases, the standard error of $\hat{\sigma}^2 / nm$ decreases. The advantage of increasing the number of replicate composite samples can be described in terms of this standard error. For example, the standard error of $\hat{\sigma}^2 / nm$ from a sample design of five replicate composite samples and six fish per composite (0.024) will be more than 50 percent smaller than that from a sample design of three replicate composite samples and six fish per composite (0.056). In general, holding the number of fish per composite fixed, the standard error of $\hat{\sigma}^2 / nm$ estimated from five replicate samples will be about 50 percent smaller than that estimated from three replicate samples.

Table 6-1. Values of $\left[\frac{2}{n^2 m^2 (n-1)} \right]^{1/2}$ for Various Combinations of n and m

No. of replicate composite samples (n)	Number of fish per composite sample (m)									
	3	4	5	6	7	8	9	10	12	15
3	0.111	0.083	0.067	0.056	0.048	0.042	0.037	0.033	0.028	0.022
4	0.068	0.051	0.041	0.034	0.029	0.026	0.023	0.020	0.017	0.014
5	0.047	0.035	0.028	0.024	0.020	0.018	0.016	0.014	0.012	0.009
6	0.035	0.026	0.021	0.018	0.015	0.013	0.012	0.011	0.009	0.007
7	0.027	0.021	0.016	0.014	0.012	0.010	0.009	0.008	0.007	0.005
10	0.016	0.012	0.009	0.008	0.007	0.006	0.005	0.005	0.004	0.003
15	0.008	0.006	0.005	0.004	0.004	0.003	0.003	0.003	0.002	0.002

The data in Table 6-1 also suggest that greater precision in the estimated standard error of \bar{z} is gained by increasing the number of replicate samples (n) than by increasing the number of fish per composite (m). If the total number of individual fish caught at a site, for example, is fixed at 50 fish, then, with a design of 10 replicate samples of 5 fish each, the value of the function of n and m in Table 6-1 is 0.009; with 5 replicate samples of 10 fish each, the value is 0.014. Thus, there is greater precision in the estimated standard error of \bar{z} associated with the first design as compared with the second design.

Two assumptions are made to examine the statistical power of the test of the null hypothesis of interest. First, it is assumed that the true mean of the site-specific composite target analyte concentrations (μ) is either 10 percent, 25 percent, or 50 percent higher than the screening value. Second, it is presumed that a factor similar to a coefficient of variation, the ratio of the estimated population standard deviation to the screening value (i.e., σ/SV), is 50, 75 or 100 percent. Nine

scenarios result from joint consideration of these two assumptions. The power of the test of the null hypothesis that the mean composite target analyte concentration at a site is equal to the SV versus the alternative hypothesis that the mean target analyte concentration is greater than the SV is estimated under each set of assumptions. Estimates of the statistical power for six of the nine scenarios are shown in Table 6-2.

Power estimates for the three scenarios where the true mean of the site-specific composite target analyte concentration was assumed to be only 10 percent higher than the screening value are not presented. The power to detect this small difference was very poor: for 242 of the resulting 270 combinations of n and m , the power was less than 50 percent.

Several observations can be made concerning the data in Table 6-2. **Note:** The statistical power increases as either n (number of replicate composite samples) or m (number of fish per composite) increases. However, greater power is achieved by increasing the number of replicate composite samples as opposed to increasing the number of fish per composite. Furthermore, if the number of replicate composite samples per site and the number of fish per composite are held constant, then, as the ratio of the estimated population standard deviation to the SV increases (i.e., σ/SV), the statistical power decreases. Higher variability in the true population of target analyte concentration in fish will require more samples to detect a difference between the mean target analyte concentration and the SV.

States may use these tables as a starting point for setting the number of replicate composite samples per site and the number of fish per composite in their fish and shellfish contaminant monitoring studies. The assumption regarding the ratio of the estimated population standard deviation to the SV presented in Sections A and D of Table 6-2 is unrealistic for some fish and shellfish populations. Data in Sections C through F, which reflect more realistic assumptions concerning the estimated population standard deviation, show that states will be able to detect only large differences between the site-specific mean target analyte concentrations and the selected SV. Specifically, if the assumed ratio of the estimated population standard deviation to the SV is 1.0, using five replicate composite samples and six to seven fish per composite sample, the power to detect a 50 percent increase over the SV is between 70 and 80 percent. However, when the number of fish per composite increases to 8 to 10, the power increases by about 10 percentage points. In comparison, the power to detect a 25 percent increase over the SV is less than 50 percent.

Table 6-2 shows that a statistical power level of (at least) 70 percent is attainable for moderate values of m and n , as long as the ratio σ/SV is not large and/or the desired detectable difference between the target analyte concentration and the SV is not too small.

Table 6-2. Estimates of Statistical Power of Hypothesis of Interest Under Specified Assumptions

No. of Replicate Composite Samples (n)	Number of Fish Per Composite (m)									
	3	4	5	6	7	8	9	10	12	15
A. Ratio of $\sigma/SV = 0.5$ and $\mu = 1.5 \times SV$:										
3	5	6	7	8	9	9	9	9	9	9
4	8	9	9	9	9	9	9	9	9	9
5	9	9	9	9	9	9	9	9	9	9
6	9	9	9	9	9	9	9	9	9	9
7	9	9	9	9	9	9	9	9	9	9
8	9	9	9	9	9	9	9	9	9	9
9	9	9	9	9	9	9	9	9	9	9
10	9	9	9	9	9	9	9	9	9	9
15	9	9	9	9	9	9	9	9	9	9
B. Ratio of $\sigma/SV = 0.75$ and $\mu = 1.5 \times SV$:										
3	-	-	-	-	5	6	6	7	7	8
4	-	6	7	7	8	8	9	9	9	9
5	6	7	8	8	9	9	9	9	9	9
6	7	8	9	9	9	9	9	9	9	9
7	8	9	9	9	9	9	9	9	9	9
8	8	9	9	9	9	9	9	9	9	9
9	9	9	9	9	9	9	9	9	9	9
10	9	9	9	9	9	9	9	9	9	9
15	9	9	9	9	9	9	9	9	9	9
C. Ratio of $\sigma/SV = 1.0$ and $\mu = 1.5 \times SV$:										
3	-	-	-	-	-	-	-	-	5	6
4	-	-	-	5	6	6	7	7	8	8
5	-	5	6	7	7	8	8	8	9	9
6	5	6	7	8	8	8	9	9	9	9
7	6	7	8	8	9	9	9	9	9	9
8	7	8	8	9	9	9	9	9	9	9
9	7	8	9	9	9	9	9	9	9	9
10	8	8	9	9	9	9	9	9	9	9
15	9	9	9	9	9	9	9	9	9	9
D. Ratio of $\sigma/SV = 0.5$ and $\mu = 1.25 \times SV$:										
3	-	-	-	-	-	-	-	-	5	6
4	-	-	-	5	6	6	7	7	8	8
5	-	5	6	7	7	8	8	8	9	9
6	5	6	7	8	8	8	9	9	9	9
7	6	7	8	8	9	9	9	9	9	9
8	7	8	8	9	9	9	9	9	9	9
9	7	8	9	9	9	9	9	9	9	9
10	8	8	9	9	9	9	9	9	9	9
15	9	9	9	9	9	9	9	9	9	9
E. Ratio of $\sigma/SV = 0.75$ and $\mu = 1.25 \times SV$:										
3	-	-	-	-	-	-	-	-	-	-
4	-	-	-	-	-	-	-	-	-	6
5	-	-	-	-	-	-	5	5	6	7
6	-	-	-	-	5	6	6	7	7	8
7	-	-	5	5	6	6	7	7	8	9
8	-	-	5	6	7	7	8	8	8	9
9	-	5	6	7	7	8	8	8	9	9
10	-	6	6	7	8	8	8	9	9	9
15	6	7	8	9	9	9	9	9	9	9

Table 6-2. (continued)

No. of Replicate Composite Samples (n)	Number of Fish Per Composite (m)									
	3	4	5	6	7	8	9	10	12	15
F. Ratio of $\sigma/SV = 1.0$ and $\mu = 1.25 \times SV$:										
3	-	-	-	-	-	-	-	-	-	-
4	-	-	-	-	-	-	-	-	-	-
5	-	-	-	-	-	-	-	-	-	5
6	-	-	-	-	-	-	-	-	5	6
7	-	-	-	-	-	-	5	5	6	7
8	-	-	-	-	-	5	5	6	7	7
9	-	-	-	-	5	5	6	6	7	8
10	-	-	-	5	5	6	6	7	8	8
15	-	5	6	5	7	8	8	8	9	9

-: Power less than 50 percent. 7: Power between 70 and 80 percent.
5: Power between 50 and 60 percent. 8: Power between 80 and 90 percent
6: Power between 60 and 70 percent. 9: Power greater than 90 percent

One final note on determining the number of replicate composite samples per site and the number of fish per composite should be emphasized. According to Section 6.1.2.3, Phase I intensive studies will focus on those target analytes that exceeded the selected SV used in the screening study. Thus, multiple target analytes may be under investigation during Phase I intensive studies, and the population variances of these analytes are likely to differ. **Note:** States should use the target analyte that exhibits the largest population variance when selecting the number of replicate composite samples per site and the number of fish per composite. This conservative approach supports use of the data in Section B of Table 6-2 where the ratio of σ/SV is twice that of the data in Section A. States may estimate population variances from historic fish contaminant data or from composite data as described by U.S. EPA (1989d). This estimate of σ^2 can be used to determine whether the sampling design (i.e., number of replicate composite samples [n] and number of individuals per composite [m]) should be modified to achieve a desired statistical power.

Table 6-3 summarizes some observed ratios (σ/SV) of selected target analytes. These values were estimated from composite samples of siscowet trout and lake trout collected and analyzed by the Great Lakes Indian Fish and Wildlife Commission in a study funded by the Administration for Native Americans.

Table 6-3. Observed Ratios (σ/SV) of Selected Target Analytes

Target Species	Observed σ/SV (Mean)		
	Total PCB SV=0.02 ppm	Toxaphene SV=0.0363 ppm	Heptachlor Epoxide SV=0.00439 ppm
Siscowet trout	4.08 (1.01)	7.07 (2.18)	0.68 (0.01)
Lake trout	10.70 (0.47)	3.01 (0.38)	0.93 (0.007)

Source: Personal communication, Kory Groetsch, Great Lakes Indian Fish and Wildlife Commission, Odana, WI, with Elvessa Aragon, Research Triangle Institute, Research Triangle Park, NC, May 10, 2000.

SV = EPA default value for recreational fishers.

Consider a study of heptachlor epoxide concentrations in lake trout. The observed ratio (σ/SV) is close to 1.0 and the observed mean is approximately $1.5 \times SV$. To determine the appropriate values of n and m , we look at Section C of Table 6-2. To achieve statistical power between 80 and 90 percent, the combination of n and m that requires the smallest number of individual fish is $n=10$ and $m=3$. Ten replicate composite samples, each with three fish, will provide between 80 and 90 percent power for detecting a mean heptachlor epoxide concentration that is higher than the SV , if the difference truly exists. Other combinations of n and m might be more desirable. For instance, if the cost of analyzing composite samples is much higher than the cost of compositing individual fish, a combination that yields fewer replicate composite samples (say, $n=5$ and $m=8$, or $n=6$ and $m=6$) may be chosen. For siscowet trout, the observed ratio (σ/SV) is close to 0.75 while the observed mean is approximately $2.25 \times SV$. A comparison of the combinations of n and m in Sections B and E (for $\sigma/SV = 0.75$) shows that higher values of n and m are required to detect a difference at the same level of statistical power. For instance, in Section B, where $\mu = 1.5 \times SV$, the smallest number of individual fish needed to achieve 80 to 90 percent power is given by $n=7$ and $m=3$. In Section E, where $\mu=1.25 \times SV$, the combination of $n=15$ and $m=5$ achieves 80 to 90 percent power. For the same level of power and the same σ/SV , detecting a larger difference between the SV and the true mean concentration requires larger sample sizes (n or m or both).

After states have implemented their fish and shellfish contaminant monitoring program, collected data on cost and variance components, and addressed other design considerations, they may want to consider using an optimal composite sampling protocol as described in Rohlf et al. (1991) for refining their sampling design. An optimal sampling design is desirable because it detects a specified minimum difference between the site-specific mean contaminant concentration and the SV at minimum cost.

6.1.2.7.2 Comparison of Target Analyte Concentrations with Screening Values for Issuing Fish Advisories—Using the statistical model described in Section 6.1.2.7.1, target analyte concentrations from replicate composite samples at a particular site can be compared to screening values using a t-test. Assume that z_i is the contaminant concentration of the i th replicate composite sample at the site of interest where $i=1,2,3,\dots,n$ and, furthermore, that each replicate composite sample comprises m individual fish fillets of equal mass. To test the null hypothesis that the mean target analyte concentration across the n replicate composite samples is equal to the SV versus the alternative hypothesis that the mean target analyte concentration is greater than the SV , perform the following steps:

1. Calculate \bar{z} , the mean target analyte concentration of observed replicate composite samples at a site:

$$\bar{z} = \sum z_i / n$$

where the summation occurs over the n composite samples.

2. Calculate the estimate of the $\text{Var}(\bar{z})$, s^2 :

$$s^2 = [\sum(z_i - \bar{z})^2] / [n(n - 1)]$$

where the summation occurs over the n composite samples.

3. Calculate the test statistic:

$$t_c = (\bar{z} - \text{SV}) / s$$

4. The null hypothesis of no difference is rejected in favor of the alternative hypothesis of exceedance if

$$t_c > t_{\alpha, n-1}$$

where $t_{\alpha, n-1}$ is the tabulated value of the Student-t distribution corresponding to level of significance α and n-1 degrees of freedom. Note that the inequality is in one direction (>) since it is **exceedance** of the SV that is of interest.

When several sites are sampled and/or fish of different size ranges are collected, it is important to conduct the test separately at each site and for each size range. Combining sites or size ranges introduces variance components that are not accounted for in this procedure. The variance estimate may be larger with the additional sources of variability, and more replicate samples may be needed to detect a significant overall exceedance of the SV.

Example

Samples of siscowet trout were collected by the Great Lakes Indian Fish and Wildlife Commission and composited according to the guidelines discussed in this document. Composites of 12 fish were prepared, and four replicate samples of each of four size classes were analyzed for total mercury, PCBs, and a suite of chlorinated pesticides. Following is a summary of the test for exceedance of the SV for hexachlorobenzene (SV=0.025 ppm) based on the recreational fish consumption default value.

At the 5 percent level of significance the critical value of the Student-t distribution with three degrees of freedom is 2.353. All of the test statistic values are less than the critical value. The mean levels of hexachlorobenzene in the four size ranges of siscowet trout are less than the SV, so no fish advisory is needed.

Size Range (in.)	No. of Replicate Samples (n)	No. of Fish per Composite (m)	Composite Measurements of HCB (ppm)	Mean (Estimated Standard Deviation)	Test Statistic
17.0-18.0	4	12	0.00419 0.00507 0.00483 0.00405	4.53×10^{-3} (2.46×10^{-4})	-83.21
19.5-20.5	4	12	0.00604 0.00780 0.00925 0.00990	8.25×10^{-3} (8.57×10^{-4})	-19.54
22.0-23.0	4	12	0.01800 0.01808 0.01868 0.02389	1.97×10^{-2} (1.42×10^{-3})	-3.73
24.5-25.5	4	12	0.01050 0.00960 0.00850 0.01090	9.88×10^{-3} (5.33×10^{-4})	-28.37

HCb=Hexachlorobenzene.

6.1.2.7.3 Comparison of Target Analyte Concentrations with Screening Values for Rescinding Fish Advisories—The comparison of mean target analyte concentrations to the screening values must be statistically based when considering rescinding a fish advisory. Statistical tests are constructed to control the Type I and Type II errors. The Type I error is defined as rejecting the null hypothesis (based on the evidence from the data) even though it is really true. The Type II error is defined as failing to reject the null hypothesis even though it is really false. In the context of the null and alternative hypotheses presented in the previous section, the Type I error is concluding that the mean target analyte concentration exceeds the SV when in fact it does not. The state concludes that there is a need to issue a fish advisory and proceeds to issue one, albeit unnecessarily. The Type II error is concluding that the mean target analyte concentration tissue residue level does not exceed the SV when in fact it does. The state decides that the mean target analyte concentration is no longer endangering the public health, so the fish advisory is rescinded. The implications of such errors may be costly; a Type II error in this case will put the public at risk without their knowledge. The Type I error is controlled by setting the level of significance to a small value, and the Type II error is controlled by increasing the power of the test. Both error types can be controlled simultaneously by increasing the sample sizes (n or m or both).

There are two basic statistical questions that must be answered before a fish advisory is rescinded:

- Is the screening value still being exceeded?
- If the screening value is no longer being exceeded, can the target analyte concentrations be expected to remain below the screening value?

The first question may be answered with the t-test described in the previous section. The second question may be answered by monitoring the target analyte concentrations long enough to observe a downward trend or a constant trend below the screening value. The simple approach would be to obtain replicate composite samples each year and test for exceedance of the screening value. (Section 6.1.1.5 recommends that screening be done biennially or at least once every 5 years. "Year" then signifies the years when screening is performed.) If the screening value is no longer being exceeded in year X, the state should continue obtaining replicate samples for at least one more year. The state should then test the differences between the tissue residue levels at years X-1, X, and X+1. Significant differences between the levels, especially between years X-1 and X, as well as between years X-1 and X+1, allows verification that the decrease in the target analyte concentration below the screening value at year X was not by chance. Appendix N discusses some statistical methods for comparing samples at different time points.

It is recommended that the yearly studies be as similar in study design as possible. Introducing changes in the study design will add more sources of variability and may necessitate increasing the number of replicate samples or accounting for the additional variance components in the statistical methods used.

6.1.2.7.4 Issuing Statewide Advisories—In addition to issuing fish consumption advisories for individual waterbodies, 18 states have also issued blanket statewide advisories for certain types of waterbodies within their jurisdictions (U.S. EPA, 1999c). States have issued statewide advisories for their freshwater lakes and/or rivers and their coastal waters, which can include estuaries and/or coastal marine waters. States often issue statewide advisories for certain waterbody types to warn the public of the potential for widespread contamination of certain species of fish or shellfish in these waterbodies. In these cases, the state has typically found a level of contamination of a specific pollutant in a particular fish species over a relatively wide geographic area that warrants advising the public of the situation. A state often issues a statewide advisory when, for example, it has many lakes that need to be monitored but has limited resources to collect fish (can sample only four or five lakes per year). If the state has even 100 lakes that need monitoring at the level of resources available, it could take 10 to 20 years to adequately monitor all 100 lakes. As an alternative, some states monitor a small percentage of their lakes and, based on the level of contamination found, many have determined that a statewide advisory should be issued to be conservative with respect to protection of public health. Methylmercury, because it is dispersed and transported via the atmosphere, is the leading pollutant responsible for the issuance of statewide advisories in 15 states, although PCBs, dioxins/furans, cadmium, chlordane, mirex, and DDT are also responsible for statewide advisories in a smaller number of states. Assuming that the levels of contamination are determined based on the fish compositing guidelines in this document, the biggest question is determining which waterbodies to monitor. Finding a "representative" sample of waterbodies is a daunting task since there are many different ways to determine representativeness: size of waterbody,

species of interest, dynamics of dispersion of pollutants of interest, or geographical location. Taking a simple random sample of lakes may not achieve sufficient coverage, whereas taking a stratified random sample approach may require more lakes be sampled than can be afforded. A conservative approach may be to look at the "worst case scenario". States may decide to sample the lakes that are believed to have the highest levels of pollutants, based on historical contaminant data, current water and sediment sampling results, or other variables. Another approach would be to select one or two of the factors described above ("representativeness"), stratify the lakes according to these factors, and select a random sample within each stratum. The set of factors for stratification may change every few years or so if it is deemed that some other factors are becoming more indicative of the levels of contamination.

6.2 SAMPLE COLLECTION

Sample collection activities should be initiated in the field only after an approved sampling plan has been developed. This section discusses recommended sampling equipment and its use, considerations for ensuring preservation of sample integrity, and field recordkeeping and chain-of-custody procedures associated with sample processing, preservation, and shipping.

6.2.1 Sampling Equipment and Use

In response to the variations in environmental conditions and target species of interest, fisheries biologists have had to devise sampling methods that are intrinsically selective for certain species and sizes of fish and shellfish (Versar, 1982). Although this selectivity can be a hindrance in an investigation of community structure, it is not a problem where tissue contaminant analysis is of concern because tissue contaminant data can best be compared only if factors such as differences in taxa and size are minimized.

Collection methods can be divided into two major categories, active and passive. Each collection method has advantages and disadvantages. Various types of sampling equipment, their use, and their advantages and disadvantages are summarized in Table 6-4 for fish and in Table 6-5 for shellfish. **Note:** Either active or passive collection methods may be used as long as the methods selected result in collection of a representative fish sample of the type consumed by local sport and subsistence fishers.

A basic checklist of field sampling equipment and supplies is shown in Table 6-6. Safety considerations associated with the use of a boat in sample collection activities are summarized in Table 6-7.

6.2.1.1 Active Collection—

Active collection methods employ a wide variety of sampling techniques and devices. Devices for fish sampling include electroshocking units, seines, trawls,

Table 6-4. Summary of Fish Sampling Equipment

Device	Use	Advantages	Disadvantages
ACTIVE METHODS			
Electrofishing	Shallow rivers, lakes, and streams.	Most efficiency nonselection method. Minimal damage to fish. Adaptable to a number of sampling conditions (e.g., boat, wading, shorelines). Particularly useful at sites where other active methods cannot be used (e.g., around snags and irregular bottom contours).	Nonselective—stuns or kills most fish. Cannot be used in brackish, salt, or extremely soft water. Requires extensive operator training. DANGEROUS when not used properly.
Seines	Shallow rivers, lakes, and streams. Shoreline areas of estuaries.	Relatively inexpensive and easily operated. Mesh size selection available for target species.	Cannot be used in deep water or over substrates with an irregular contour. Not completely efficient as fish can evade the net during seining operation.
Trawls	Various sizes can be used from boats in moderate to deep open bodies of water (10 to >70 m depths).	Effective in deep waters not accessible by other methods. Allows collection of a large number of samples.	Requires boat and trained operators.
Angling	Generally species selective involving use of hook and line.	Most selective method. Does not require use of large number of personnel or expensive equipment.	Inefficient and not dependable.
Purchasing specimens from commercial fishers	Only in areas where target species are commercially harvested.	Most cost-effective and efficient means of obtaining commercially valuable species from harvested waters.	Limited use; commercially harvested areas may not include sampling sites chosen for fish contaminant monitoring. The field collection staff should accompany the commercial fishers and should remove the required samples from the collection device. This will ensure the proper handling of the specimens and accurate recording of the collection time and sampling location.
PASSIVE METHODS			
Gill nets	Lakes, rivers, and estuaries. Where fish movement can be expected or anticipated.	Effective for collecting pelagic fish species. Relatively easy to operate. Requires less fishing effort than active methods. Selectivity can be controlled by varying mesh size.	Not effective for bottom-dwelling fish or populations that do not exhibit movement patterns. Nets prone to tangling or damage by large and sharp spined fish. Gill nets will kill captured specimens, which, when left for extended periods, may undergo physiological changes.
Trammel nets	Lakes, rivers, and estuaries. Where fish movement can be expected or anticipated. Frequently used where fish may be scared into the net.	Slightly more efficient than a straight gill net.	(Same as for gill nets.) Tangling problems may be more severe. Method of scaring fish into net requires more personnel or possibly boats in deep water areas.
Hoop, Fyke and Pound Nets	Shallow rivers, lakes, and estuaries when currents are present or when movements of fish are predictable. Frequently used in commercial operations.	Unattended operation. Very efficient in regard to long-term return and expended effort. Particularly useful in areas where active methods are impractical.	Inefficient for short term. Difficult to set up and maintain.
D-Traps	Used for long-term capture of slow-moving fish, particularly bottom species. Can be used in all environments.	Easy to operate and set. Unattended operation. Particularly useful for capturing bottom-dwelling organisms in deep waters or other types of inaccessible areas. Relatively inexpensive—often can be hand made.	Efficiency is highly variable. Not effective for pelagic fish or fish that are visually oriented. Less efficient for all species when water is clear rather than turbid. Not a good choice for a primary sampling technique, but available as backup for other methods.

Source: Versar, 1982.

Table 6-5. Summary of Shellfish Sampling Equipment

Device	Use	Advantages	Disadvantages
ACTIVE METHODS			
Seines	Shallow shoreline areas of estuaries.	Relatively inexpensive and easily operated. Mesh size selection available for target crustacean species (e.g., shrimp and crabs).	Cannot be used in deep water or over substrates with an irregular contour. Not completely efficient as crustaceans can evade the net during seining operation.
Trawls	Various sizes can be used from boats in moderate to deep open bodies of water (10 to >70 m depths).	Effective in deeper waters not accessible by other methods. Allows collection of a large number of samples.	Requires boat and trained operators.
Mechanical grabs Double-pole-operated grab buckets	Used from boat or pier. Most useful in shallow water areas less than 6 m deep including lakes, rivers, and estuaries.	Very efficiency means of sampling bivalves (e.g., clams and oysters) that are located on or buried in bottom sediments.	At depths greater than 6 m, the pole-operated devices become difficult to operate manually.
Tongs or double-handled grab sampler	Most useful in shallow water, lakes, rivers, and estuaries. Generally used from a boat.	Very efficient means of sampling oysters, clams, and scallops. Collection of surrounding or overlying sediments is not required and the jaws are generally open baskets. This reduces the weight of the device and allows the washing of collected specimens to remove sediments.	At depths greater than 6 m, the pole-operated devices become difficult to operate manually.
Line or cable-operated grab buckets			
Ekman grab	Used from boat or pier to sample soft to semisoft substrates.	Can be used in water of varying depths in lakes, rivers, and estuaries.	Possible incomplete closure of jaws can result in sample loss. Must be repeatedly retrieved and deployed. Grab is small and is not particularly effective in collecting large bivalves (clams and oysters).
Petersen grab	Deep lakes, rivers, and estuaries for sampling most substrates.	Large sample is obtained; grab can penetrate most substrates.	Grab is heavy, may require winch for deployment. Possible incomplete closure of jaws can result in sample loss. Must be repeatedly retrieved and deployed.
Ponar grab	Deep lakes, rivers, and estuaries for sampling sand, silt, or clay substrates.	Most universal grab sampler. Adequate on most substrates. Large sample is obtained intact.	Possible incomplete closure of jaws can result in sample loss. Must be repeatedly retrieved and deployed.
Orange peel grab	Deep lakes, rivers, and estuaries for sampling most substrates.	Designed for sampling hard substrates.	Grab is heavy, may require winch for deployment. Possible incomplete closure of jaws can result in sample loss. Must be repeatedly retrieved and deployed. Grab is small and not particularly effective in collecting large bivalves (clams and oysters).
Biological or hydraulic dredges	Dragged along the bottom of deep waterbodies to collect large stationary invertebrates.	Qualitative sampling of large area of bottom substrate and benthic community. Length of tows can be relatively short if high density of shellfish exists in sampling area.	If the length of the tow is long, it is difficult to pinpoint the exact location of the sample collection area. Because of the scouring operation of the dredge, bivalve shells may be damaged. All bivalve specimens should be inspected and individuals with cracked or damaged shells should be discarded.

(continued)

Table 6-5. (continued)

Device	Use	Advantages	Disadvantages
ACTIVE METHODS (continued)			
Scoops, shovels	Used in shallow waters accessible by wading or SCUBA equipment for collection of hard clams (<i>Mercenaria mercenaria</i>) or soft-shell clam (<i>Mya arenaria</i>).	Does not require a boat; sampling can be done from shore.	Care must be taken not to damage the shells of bivalves while digging in substrate.
Scrapers	Used in shallow waters accessible by wading or SCUBA equipment for collection of oysters (<i>Crassostrea virginica</i>) or mussels (<i>Mytilus sp.</i>).	Does not require a boat; sampling can be done from shore.	Care must be taken not to damage shells of bivalves while removing them from hard substrate.
Rakes	Used in shallow waters accessible by wading or can be used from a boat.	Does not require a boat; sampling can be done close to shore. Can be used in soft sediments to collect clams or scallops and can also be used to dislodge oysters or mussels that are attached to submerged objects such as rocks and pier pilings.	Care must be taken not to damage the shells of the bivalves while raking or dislodging them from the substrate.
Purchasing specimens from commercial fishers	Only in areas where target species are commercially harvested.	Most cost-effective and efficient means of obtaining bivalves for pollutant analysis from commercially harvested waters.	Limited use; commercially harvested areas may not include sampling sites chosen for shellfish contaminant monitoring. The field collection staff should accompany the commercial fishers and should remove the required samples from the collection device. This will ensure the proper handling of the specimens and accurate recording of the exact collection time and sampling location.
PASSIVE METHODS			
D-traps	Used for capture of slow-moving crustaceans (crabs and lobsters) that move about on or just above the substrate.	Can be used in a variety of environments. Particularly useful for capturing bottom-dwelling organisms in deep water or other inaccessible areas. Relatively inexpensive, can be hand made.	Catch efficiency is highly variable. Not a good choice for a primary sampling technique, but valuable as a backup for other methods.

**Table 6-6. Checklist of Field Sampling Equipment and Supplies
for Fish and Shellfish Contaminant Monitoring Programs**

- Boat supplies
 - Fuel supply (primary and auxiliary supply)
 - Spare parts repair kit
 - Life preservers
 - First aid kit (including emergency phone numbers of local hospitals, family contacts for each member of the sampling team)
 - Spare oars
 - Nautical charts of sampling site locations

 - Collection equipment (e.g., nets, traps, electroshocking device)

 - Recordkeeping/documentation supplies
 - Field logbook
 - Sample request forms
 - Specimen identification labels
 - Chain-of-Custody (COC) Forms and COC tags or labels
 - Indelible pens

 - Sample processing equipment and supplies
 - Holding trays
 - Fish measuring board (metric units)
 - Calipers (metric units)
 - Shucking knife
 - Balance to weigh representative specimens for estimating tissue weight (metric units)
 - Aluminum foil (extra heavy duty)
 - Freezer tape
 - String
 - Several sizes of plastic bags for holding individual or composite samples
 - Resealable watertight plastic bags for storage of Field Records, COC Forms, and Sample Request Forms

 - Sample preservation and shipping supplies
 - Ice (wet ice, blue ice packets, or dry ice)
 - Ice chests
 - Filament-reinforced tape to seal ice chests for transport to the central processing laboratory
-
-

Table 6-7. Safety Considerations for Field Sampling Using a Boat

- Field collection personnel **should not** be assigned to duty alone in boats.
 - Life preservers should be worn at all times by field collection personnel near the water or on board boats.
 - If electrofishing is the sampling method used, there must be two shutoff switches--one at the generator and a second on the bow of the boat.
 - All deep water sampling should be performed with the aid of an experienced, licensed boat captain.
 - All sampling during nondaylight hours, during severe weather conditions, or during periods of high water should be avoided or minimized to ensure the safety of field collection personnel.
 - All field collection personnel should be trained in CPR, water safety, boating safety, and first aid procedures for proper response in the event of an accident. Personnel should have local emergency numbers readily available for each sampling trip and know the location of the hospitals or other medical facilities nearest each sampling site.
-

and angling equipment (hook and line). Rotenone, a chemical piscicide, has been used extensively to stun fish prior to their collection with seines, trawls, or other sampling devices. Rotenone has not been found to interfere with the analysis of the recommended organic target analytes (see Table 4-1) when the recommended analysis procedures are used. See Section 8 for additional information on appropriate analysis methods for the recommended organic target analytes. Devices for shellfish sampling include seines, trawls, mechanical grabs (e.g., pole- or cable-operated grab buckets and tongs), biological and hydraulic dredges, scoops and shovels, rakes, and dip nets. Shellfish can also be collected manually by SCUBA divers. Although active collection requires greater fishing effort, it is usually more efficient than passive collection for covering a large number of sites and catching the relatively small number of individuals needed from each site for tissue analysis (Versar, 1982). Active collection methods are particularly useful in shallow waters (e.g., streams, lake shorelines, and shallow coastal areas of estuaries).

One aspect of sample collection that is of paramount importance is that the sampling team must ensure the collection of live, intact fish and shellfish for use in sample analysis for human risk assessment. It is highly desirable to collect live, intact fish and shellfish that have not been mutilated by the collection gear and that do not have any skin, shell, or carapace lacerations or fin deterioration that would allow body fluids to leak out of the specimen or contaminants to pass into the specimen after collection. For example, some fish collected by electroshocking methods may have ruptured organs due to the electroshocking procedure. Fish that are found floating dead at a site should not be used for sample analysis for human risk assessments. For these reasons, EPA recommends that any specimens that show any skin, shell, or carapace lacerations or fin deterioration of any kind not used for chemical analysis.

Active collection methods have distinct disadvantages for deep water sampling. They require more field personnel and more expensive equipment than passive collection methods. This disadvantage may be offset by coordinating sampling efforts with commercial fishing efforts. Purchasing fish and shellfish from commercial fishers using active collection devices is acceptable; however, field sampling staff should accompany the commercial fishers during the collection operation to ensure that samples are collected and handled properly and to verify the sampling site location. The field sampling staff then remove the target species directly from the sampling device and ensure that sample collection, processing, and preservation are conducted as prescribed in sample collection protocols, with minimal chance of contamination. This is an excellent method of obtaining specimens of commercially important target species, particularly from the Great Lakes and coastal estuarine areas (Versar, 1982). More detailed descriptions of active sampling devices and their use are provided in Battelle (1975), Bennett, et al., (1970), Gunderson and Ellis (1986), Hayes (1983), Mearns and Allen (1978), Pitt (1981), Puget Sound Estuary Program (1990b), Versar (1982), and Weber (1973).

6.2.1.2 Passive Collection—

Passive collection methods employ a wide array of sampling devices for fish and shellfish, including gill nets, fyke nets, trammel nets, hoop nets, pound nets, and d-traps. Passive collection methods generally require less fishing effort than active methods but are usually less desirable for shallow water sample collection because of the ability of many species to evade these entanglement and entrapment devices. These methods normally yield a much greater catch than would be required for a contaminant monitoring program and are time consuming to deploy. In deep water, however, passive collection methods are generally more efficient than active methods. Crawford and Luoma (1993) caution that passive collection devices (e.g., gill nets) should be checked frequently to ensure that captured fish do not deteriorate prior to removal from the sampling device. Versar (1982, 1984) and Hubert (1983) describe passive sampling devices and their use in more detail. It is highly desirable to collect live, intact fish that have not been mutilated by the collection gear and that do not have any skin lacerations or fin deterioration. For these reasons, EPA recommends that fish captured in passive collection devices not remain in the water for more than 24 hours after the passive collection device is first deployed and that specimens that show any skin or fin deterioration or external lacerations of any kind not used for chemical analysis.

Purchasing fish and shellfish from commercial fishers using passive collection methods is acceptable; however, field sampling staff should accompany the fishers during both the deployment and collection operations to ensure that samples are collected and handled properly and to verify the sampling site location. The field sampling staff can then ensure that sample collection, processing, and preservation are conducted as prescribed in sample collection protocols, with minimal chance of contamination.

6.2.2 Preservation of Sample Integrity

The primary QA consideration in sample collection, processing, preservation, and shipping procedures is the preservation of sample integrity to ensure the accuracy of target analyte analyses. Sample integrity is preserved by prevention of loss of contaminants already present in the tissues and prevention of extraneous tissue contamination (Smith, 1985).

Loss of contaminants already present in fish or shellfish tissues can be prevented in the field by ensuring that the skin on fish specimens has not been lacerated by the sampling gear or that the carapace of crustaceans or shells of bivalves have not been cracked during sample collection resulting in loss of tissues and/or fluids that may contain contaminants. Once the samples have reached the laboratory, further care must be taken during thawing (if specimens are frozen) to ensure that all liquids from the thawed specimens are retained with the tissue sample as appropriate (see Sections 7.2.2, 7.2.3, and 7.2.4).

Sources of extraneous tissue contamination include contamination from sampling gear, grease from ship winches or cables, spilled engine fuel (gasoline or diesel), engine exhaust, dust, ice chests, and ice used for cooling. All potential sources of contamination in the field should be identified and appropriate steps taken to minimize or eliminate them. For example, during sampling, the boat should be positioned so that engine exhausts do not fall on the deck. Ice chests should be scrubbed clean with detergent and rinsed with distilled water after each use to prevent contamination. To avoid contamination from melting ice, samples should be placed in waterproof plastic bags (Stober, 1991). Sampling equipment that has obviously been contaminated by oils, grease, diesel fuel, or gasoline should not be used. All utensils or equipment that will be used directly in handling fish or shellfish (e.g., fish measuring board or calipers) should be cleaned in the laboratory prior to each sampling trip, rinsed in acetone and pesticide-grade hexane, and stored in aluminum foil until use (Versar, 1982). Between sampling sites, the field collection team should clean each measurement device by rinsing it with ambient water and rewrapping it in aluminum foil to prevent contamination.

Note: Ideally, all sample processing (e.g., resections) should be performed at a sample processing facility under cleanroom conditions to reduce the possibility of sample contamination (Schmitt and Finger, 1987; Stober, 1991). However, there may be some situations in which state staff find it necessary to fillet finfish or resect edible turtle or shellfish tissues in the field prior to packaging the samples for shipment to the processing laboratory. This practice should be avoided whenever possible. If states find that filleting fish or resecting other edible tissues must be performed in the field, a clean area should be set up away from sources of diesel exhaust and areas where gasoline, diesel fuel, or grease are used to help reduce the potential for surface and airborne contamination of the samples from PAHs and other contaminants. Use of a mobile laboratory or use of a portable resection table and enclosed hood would provide the best environment for sample processing in the field. General guidance for conducting sample

processing under cleanroom conditions is provided in Section 7.2.1. States should review this guidance to ensure that procedures as similar as possible to those recommended for cleanroom processing are followed. If sample processing is conducted in the field, a notation should be made in the field records and on the sample processing record (see Figure 7-2). Procedures for laboratory processing and resection are described in Section 7.2. Procedures for assessing sources of sample contamination through the analyses of field and processing blanks are described in Section 8.3.3.6.

6.2.3 Field Recordkeeping

Thorough documentation of all field sample collection and processing activities is necessary for proper interpretation of field survey results. For fish and shellfish contaminant studies, it is advisable to use preprinted waterproof data forms, indelible ink, and writing implements that can function when wet (Puget Sound Estuary Program, 1990b). When multicopy forms are required, no-carbon-required (NCR) paper is recommended because it allows information to be forwarded on the desired schedule and retained for the project file at the same time.

Four separate preprinted sample tracking forms should be used for each sampling site to document field activities from the time the sample is collected through processing and preservation until the sample is delivered to the processing laboratory. These are

- Field record form
- Sample identification label
- Chain-of-custody (COC) label or tag
- COC form.

6.2.3.1 Field Record Form—

The following information should be included on the field record for each sampling site in both **Tier 1** screening (Figures 6-3 and 6-4) and **Tier 2** intensive studies as appropriate (Figures 6-5 and 6-6):

- Project number
- Sampling date and time (give date in a Year 2000 compliant format [YYYYMMDD] and specify convention used for time, e.g., 24-h clock)
- Sampling site location (including site name and number, county/parish, latitude/longitude, waterbody name/segment number, waterbody type, and site description)
- Sampling depth (specify units of depth)
- Collection method
- Collectors' names and signatures
- Agency (including telephone number and address)

Field Record for Fish Contaminant Monitoring Program — Screening Study

Project Number: _____ Sampling Date and Time: _____

SITE LOCATION _____

Site Name/Number: _____

County/Parish: _____ Lat./Long.: _____

Waterbody Name/Segment Number: _____

Waterbody Type: RIVER LAKE ESTUARY

Site Description: _____

Collection Method: _____

Collector Name: _____
(print and sign)

Agency: _____ Phone: (____) _____

Address: _____

FISH COLLECTED _____

Bottom Feeder—Species Name: _____

Composite Sample #: _____ Number of Individuals: _____

Fish #	Length (mm)	Sex	Fish #	Length (mm)	Sex
001	_____	___	006	_____	___
002	_____	___	007	_____	___
003	_____	___	008	_____	___
004	_____	___	009	_____	___
005	_____	___	010	_____	___

Minimum size _____ x 100 = _____ >75% Composite mean length _____ mm

Maximum size _____

Notes (e.g., morphological anomalies): _____

Predator—Species Name: _____

Composite Sample #: _____ Number of Individuals: _____

Fish #	Length (mm)	Sex	Fish #	Length (mm)	Sex
001	_____	___	006	_____	___
002	_____	___	007	_____	___
003	_____	___	008	_____	___
004	_____	___	009	_____	___
005	_____	___	010	_____	___

Minimum size _____ x 100 = _____ ≥ 75% Composite mean length _____ mm

Maximum size _____

Notes (e.g., morphological anomalies): _____

Figure 6-3. Example of a field record for fish contaminant monitoring program—screening study.

Field Record for Shellfish Contaminant Monitoring Program — Screening Study

Project Number: _____ Sampling Date and Time: _____

SITE LOCATION

Site Name/Number: _____

County/Parish: _____ Lat./Long.: _____

Waterbody Name/Segment Number: _____

Waterbody Type: RIVER LAKE ESTUARY

Site Description: _____

Collection Method: _____

Collector Name: _____
(print and sign)

Agency: _____ Phone: (____) _____

Address: _____

SHELLFISH COLLECTED

Bivalve Species Name: _____

Composite Sample #: _____ Number of Individuals: _____

Bivalve #	Size (mm)	Bivalve #	Size (mm)	Bivalve #	Size (mm)
001	_____	018	_____	035	_____
002	_____	019	_____	036	_____
003	_____	020	_____	037	_____
004	_____	021	_____	038	_____
005	_____	022	_____	039	_____
006	_____	023	_____	040	_____
007	_____	024	_____	041	_____
008	_____	025	_____	042	_____
009	_____	026	_____	043	_____
010	_____	027	_____	044	_____
011	_____	028	_____	045	_____
012	_____	029	_____	046	_____
013	_____	030	_____	047	_____
014	_____	031	_____	048	_____
015	_____	032	_____	049	_____
016	_____	033	_____	050	_____
017	_____	034	_____		

Minimum size _____ x 100 = _____ ≥ 75% Composite mean size _____ mm

Maximum size _____

Notes (e.g., morphological anomalies): _____

Figure 6-4. Example of a field record for shellfish contaminant monitoring program—screening study.

Field Record for Fish Contaminant Monitoring Program — Intensive Study

Project Number: _____ Sampling Date and Time: _____

SITE LOCATION

Site Name/Number: _____

County/Parish: _____ Lat./Long.: _____

Waterbody Name/Segment Number: _____

Waterbody Type: RIVER LAKE ESTUARY

Site Description: _____

Collection Method: _____

Collector Name: _____
(print and sign)

Agency: _____ Phone: (____) _____

Address: _____

FISH COLLECTED

Species Name: _____ **Replicate Number:** _____

Composite Sample #: _____ Number of Individuals: _____

Fish #	Length (mm)	Sex (M, F, or I)	Fish #	Length (mm)	Sex (M, F, or I)
001	_____	___	006	_____	___
002	_____	___	007	_____	___
003	_____	___	008	_____	___
004	_____	___	009	_____	___
005	_____	___	010	_____	___

Minimum length _____ x 100 = _____ % Composite mean length _____ mm

Maximum length _____

Notes (e.g., morphological anomalies): _____

Species Name: _____ **Replicate Number:** _____

Composite Sample #: _____ Number of Individuals: _____

Fish #	Length (mm)	Sex (M, F, or I)	Fish #	Length (mm)	Sex (M, F, or I)
001	_____	___	006	_____	___
002	_____	___	007	_____	___
003	_____	___	008	_____	___
004	_____	___	009	_____	___
005	_____	___	010	_____	___

Minimum length _____ x 100 = _____ ≥ 75% Composite mean length _____ mm

Maximum length _____

Notes (e.g., morphological anomalies): _____

page 1 of 2

Figure 6-5. Example of a field record for fish contaminant monitoring program—intensive study.

Field Record for Fish Contaminant Monitoring Program — Intensive Study (con.)

Project Number: _____ Sampling Date and Time: _____

SITE LOCATION:

Site Name/Number: _____

County/Parish: _____ Lat./Long.: _____

FISH COLLECTED

Species Name: _____ **Replicate Number:** _____

Composite Sample #: _____ Number of Individuals: _____

Fish #	Length (mm)	Sex (M, F, or I)	Fish #	Length (mm)	Sex (M, F, or I)
001	_____	_____	006	_____	_____
002	_____	_____	007	_____	_____
003	_____	_____	008	_____	_____
004	_____	_____	009	_____	_____
005	_____	_____	010	_____	_____

Minimum length _____ x 100 = _____ % Composite mean length _____ mm

Maximum length _____

Notes (e.g., morphological anomalies): _____

Species Name: _____ **Replicate Number:** _____

Composite Sample #: _____ Number of Individuals: _____

Fish #	Length (mm)	Sex (M, F, or I)	Fish #	Length (mm)	Sex (M, F, or I)
001	_____	_____	006	_____	_____
002	_____	_____	007	_____	_____
003	_____	_____	008	_____	_____
004	_____	_____	009	_____	_____
005	_____	_____	010	_____	_____

Minimum length _____ x 100 = _____ % Composite mean length _____ mm

Maximum length _____

Notes (e.g., morphological anomalies): _____

Species Name: _____ **Replicate Number:** _____

Composite Sample #: _____ Number of Individuals: _____

Fish #	Length (mm)	Sex (M, F, or I)	Fish #	Length (mm)	Sex (M, F, or I)
001	_____	_____	006	_____	_____
002	_____	_____	007	_____	_____
003	_____	_____	008	_____	_____
004	_____	_____	009	_____	_____
005	_____	_____	010	_____	_____

Minimum length _____ x 100 = _____ ≥ 75% Composite mean length _____ mm

Maximum length _____

Notes (e.g., morphological anomalies): _____

page 2 of 2

Figure 6-5. (continued)

Field Record for Shellfish Contaminant Monitoring Program — Intensive Study

Project Number: _____ Sampling Date and Time: _____

SITE LOCATION

Site Name/Number: _____

County/Parish: _____ Lat./Long.: _____

Waterbody Name/Segment Number: _____

Waterbody Type: RIVER LAKE ESTUARY

Site Description: _____

Collection Method: _____

Collector Name: _____
(print and sign)

Agency: _____ Phone: (____) _____

Address: _____

SHELLFISH COLLECTED

Species Name: _____ Replicate Number: _____

Composite Sample #: _____ Number of Individuals: _____

Shellfish #	Size (mm)	Sex	Shellfish #	Size (mm)	Sex	Shellfish #	Size (mm)	Sex
001	_____	_____	018	_____	_____	035	_____	_____
002	_____	_____	019	_____	_____	036	_____	_____
003	_____	_____	020	_____	_____	037	_____	_____
004	_____	_____	021	_____	_____	038	_____	_____
005	_____	_____	022	_____	_____	039	_____	_____
006	_____	_____	023	_____	_____	040	_____	_____
007	_____	_____	024	_____	_____	041	_____	_____
008	_____	_____	025	_____	_____	042	_____	_____
009	_____	_____	026	_____	_____	043	_____	_____
010	_____	_____	027	_____	_____	044	_____	_____
011	_____	_____	028	_____	_____	045	_____	_____
012	_____	_____	029	_____	_____	046	_____	_____
013	_____	_____	030	_____	_____	047	_____	_____
014	_____	_____	031	_____	_____	048	_____	_____
015	_____	_____	032	_____	_____	049	_____	_____
016	_____	_____	033	_____	_____	050	_____	_____
017	_____	_____	034	_____	_____			

Minimum size _____ x 100 = _____ ≥ 75% Composite mean size _____ mm

Maximum size _____

Notes (e.g., morphological anomalies): _____

Figure 6-6. Example of a field record for shellfish contaminant monitoring program—intensive study.

- Species collected (including species common and scientific name, composite sample number, individual specimen number, number of individuals per composite sample, number of replicate samples, total length/size [mm], sex [male, female, indeterminate])

Note: States should specify a unique numbering system to track samples for their own fish and shellfish contaminant monitoring programs.

- Percent difference in size between the smallest and largest specimens to be composited (smallest individual length [or size] divided by the largest individual length [or size] x 100; should be ≥ 75 percent) and mean composite length or size (mm)
- Notes (including visible morphological abnormalities, e.g., fin erosion, skin ulcers, cataracts, skeletal and exoskeletal anomalies, neoplasms, or parasites).

6.2.3.2 Sample Identification Label—

A sample identification label should be completed in indelible ink for each individual fish or shellfish specimen after it is processed to identify each sample uniquely (Figure 6-7). The following information should be included on the sample identification label:

- Species scientific name or code number
- Total length/size of specimen (mm)
- Specimen number
- Sample type: F (fish fillet analysis only)
 S (shellfish edible portion analysis only)
 W (whole fish analysis)
 O (other fish tissue analysis)

Species Name or Code					Sample Type		
Total Length or Size (mm)			Sampling Site (name/number)				
Specimen Number						Sampling Date (YYYYMMDD)	
<input type="text"/>	<input type="text"/>	<input type="text"/>	<input type="text"/>	<input type="text"/>	<input type="text"/>	<input type="text"/>	<input type="text"/>
						Time (24-h clock)	

Figure 6-7. Example of a sample identification label.

- Sampling site—waterbody name and/or identification number
- Sampling date/time (give date in a Year 2000 compliant format [YYYYMMDD] and specify convention for time, e.g., 24-h clock).

A completed sample identification label should be taped to each aluminum-foil-wrapped specimen and the specimen should be placed in a waterproof plastic bag.

6.2.3.3 Chain-of-Custody Label or Tag—

A COC label or tag should be completed in indelible ink for each individual fish specimen. The information to be completed for each fish is shown in Figure 6-8.

Project Number		Collection Agency (name, address, phone)			
Sampling Site (name and/or ID number)			Sampler (name and signature)		
Composition Number/Specimen Number(s)		Chemical Analyses <input type="checkbox"/> All target analytes <input type="checkbox"/> Others (specify) _____		Study Type	
Sampling Date (YYYYMMDD) Time (24-h clock)				Screening	Intensive
					Phase I <input type="checkbox"/>
					Phase II <input type="checkbox"/>
Species Name or Code		Processing		Type of Ice	
		Whole Body	Resection	Wet	Dry
Comments					

Figure 6-8. Example of a chain-of-custody tag or label.

After all information has been completed, the COC label or tag should be taped or attached with string to the outside of the waterproof plastic bag containing the individual fish sample. Information on the COC label/tag should also be recorded on the COC form (Figure 6-9).

Because of the generally smaller size of shellfish, several individual aluminum-foil-wrapped shellfish specimens (within the same composite sample) may be placed in the same waterproof plastic bag. A COC label or tag should be completed in indelible ink for each shellfish composite sample. If more than 10 individual

Chain-of-Custody Record										
Project Number		Collecting Agency (name, address, phone)				Sampling Date		Chemical Analyses All Target Contaminants Specific Contaminants Only (Specify)		
Samplers (print and sign)					Container _____ of _____					
Composite Number	Specimen Nos.	Sampling Time	Study Type		Sampling Site (name/number)				Comments	
			Scr	Int						

Delivery Shipment Record		Deliver/Ship to: (name, address and phone)				Date/Time Shipped:	
Delivery Method <input type="checkbox"/> Hand carry <input type="checkbox"/> Shipped							
Relinquished by: (signature)		Date / Time	Received by: (signature)		Relinquished by: (signature)	Date / Time	Received by: (signature)
Relinquished by: (signature)		Date / Time	Received for Central Processing Laboratory by: (signature)		Date / Time	Remarks:	

Laboratory Custody:			
Released Name/Date	Received Name/Date	Purpose	Location

Figure 6-9. Example of a chain-of-custody record form.

shellfish are to be composited, several waterproof plastic bags may have to be used for the same composite. It is important not to place too many individual specimens in the same plastic bag to ensure proper preservation during shipping, particularly during summer months. Information on the COC label/tag should also be recorded on the COC form (Figure 6-9).

6.2.3.4 Chain-of-Custody Form—

A COC form should be completed in indelible ink for each shipping container (e.g., ice chest) used. Information recommended for documentation on the COC form (Figure 6-9) is necessary to track all samples from field collection to receipt at the processing laboratory. In addition, this form can be used for tracking samples through initial laboratory processing (e.g., resection) as described in Section 7.2.

Prior to sealing the ice chest, one copy of the COC form and a copy of the field record sheet should be sealed in a resealable waterproof plastic bag. This plastic bag should be taped to the inside cover of the ice chest so that it is maintained with the samples being tracked. Ice chests should be sealed with reinforced tape for shipment.

6.2.3.5 Field Logbook—

In addition to the four sample tracking forms discussed above, the field collection team should document in a field logbook any additional information on sample collection activities, hydrologic conditions (e.g., tidal stage), weather conditions, boat or equipment operations, or any other unusual activities observed (e.g., dredging) or problems encountered that would be useful to the program manager in evaluating the quality of the fish and shellfish contaminant monitoring data.

6.3 SAMPLE HANDLING

6.3.1 Sample Selection

6.3.1.1 Species Identification—

As soon as fish, shellfish, and turtles are removed from the collection device, they should be identified by species. Nontarget species or specimens of target species that do not meet size requirements (e.g., juveniles) should be returned to the water. Species identification should be conducted only by experienced personnel knowledgeable of the taxonomy of species in the waterbodies included in the contaminant monitoring program. Taxonomic keys, appropriate for the waters being sampled, should be consulted for species identification. Because the objective of both the screening and intensive monitoring studies is to determine the magnitude of contamination in specific fish, shellfish, and turtle species, it is necessary that all individuals used in a composite sample be of a single species.

Note: Correct species identification is important and different species should never be combined in a single composite sample.

When sufficient numbers of the target species have been identified to make up a composite sample, the species name and all other appropriate information should be recorded on the field record forms (Figures 6-3 through 6-6).

Note: EPA recommends that, when turtles are used as the target species, target analyte concentrations be determined for each turtle rather than for a composite turtle sample.

6.3.1.2 Initial Inspection and Sorting—

Individual fish of the selected target species should be rinsed in ambient water to remove any foreign material from the external surface. Large fish should be stunned by a sharp blow to the base of the skull with a wooden club or metal rod. This club or rod should be used solely for the purpose of stunning fish, and care should be taken to keep it reasonably clean to prevent contamination of the samples (Versar, 1982). Small fish may be placed on ice immediately after capture to stun them, thereby facilitating processing and packaging procedures. Once stunned, individual specimens of the target species should be grouped by species and general size class and placed in clean holding trays to prevent contamination. All fish should be inspected carefully to ensure that their skin and fins have not been damaged by the sampling equipment, and damaged specimens should be discarded (Versar, 1982).

Freshwater turtles should be rinsed in ambient water and their external surface scrubbed if necessary to remove any foreign matter from their carapace and limbs. Each turtle should be inspected carefully to ensure that the carapace and extremities have not been damaged by the sampling equipment, and damaged specimens should be discarded (Versar, 1982). Care should be taken when handling large turtles, particularly snapping turtles; many can deliver severe bites. Particularly during procedures that place fingers or hands within striking range of the sharp jaws, covering the turtle's head, neck, and forelimbs with a cloth towel or sack and taping it in place is often sufficient to prevent injury to the field sampling crew (Frye, 1994).

After inspection, each turtle should be placed individually in a heavy burlap sack or canvas bag tied tightly with a strong cord and then placed in an ice-filled cooler. Placing turtles on ice will slow their metabolic rate, making them easier to handle.

Note: It is recommended that each turtle be analyzed as an individual sample, especially if the target turtle species is not abundant in the waterbody being sampled or if the collected individuals differ greatly in size or age. Analysis of individual turtles can provide an estimate of the maximum contaminant concentrations to which recreational or subsistence fishers are exposed. Target analyte concentrations in composite samples represent averages for a specific target species population. The use of these values in risk assessment is appropriate if the objective is to estimate the average concentration to which consumers of the target species are exposed over a long period of time. The use of long exposure periods (e.g., 70 years) is typical for the assessment of

carcinogenic effects, which may be manifest over an entire lifetime (see Volume II of this guidance series). Noncarcinogenic effects, on the other hand, may cause acute health effects over a relatively short period of time (e.g., hours or days) after consumption. The maximum target analyte contaminant concentration may be more appropriate than the average target analyte concentration for use with noncarcinogenic target analytes (U.S. EPA, 1989d). This is especially important for those target analytes for which acute exposures to very high concentrations may be toxic to consumers.

Stone et al. (1980) reported extremely high concentrations of PCBs in various tissues of snapping turtles from a highly contaminated site on the Hudson River. Contaminant analysis of various turtle tissues showed mean PCB levels of 2,991 ppm in fatty tissue, 66 ppm in liver tissue, and 29 ppm in eggs as compared to 4 ppm in skeletal muscle. Clearly, inclusion of the fatty tissue, liver, and eggs with the muscle tissues as part of the edible tissues will increase observed residue concentrations over those detected in muscle tissue only. States interested in using turtles as target species should review Appendix C for additional information on the use of individual samples in contaminant monitoring programs.

Bivalves (oysters, clams, scallops, and mussels) adhering to one another should be separated and scrubbed with a nylon or natural fiber brush to remove any adhering detritus or fouling organisms from the exterior shell surfaces (NOAA, 1987). All bivalves should be inspected carefully to ensure that the shells have not been cracked or damaged by the sampling equipment and damaged specimens should be discarded (Versar, 1982). Crustaceans, including shrimp, crabs, crayfish, and lobsters, should be inspected to ensure that their exoskeletons have not been cracked or damaged during the sampling process, and damaged specimens should be discarded (Versar, 1982). After shellfish have been rinsed, individual specimens should be grouped by target species and placed in clean holding trays to prevent contamination.

A few shellfish specimens may be resected (edible portions removed) to determine wet weight of the edible portions. This will provide an estimate of the number of individuals required to ensure that the recommended sample weight (200 g) is attained. **Note:** Individuals used to determine the wet weight of the edible portion should not be used for target analyte analyses.

6.3.1.3 Length or Size Measurements—

Each fish within the selected target species should be measured to determine total body length (mm). To be consistent with the convention used by most fisheries biologists in the United States, maximum body length should be measured as shown in Figure 6-10. The maximum body length is defined as the length from the anterior-most part of the fish to the tip of the longest caudal fin ray (when the lobes of the caudal fin are compressed dorsoventrally) (Anderson and Gutreuter, 1983).

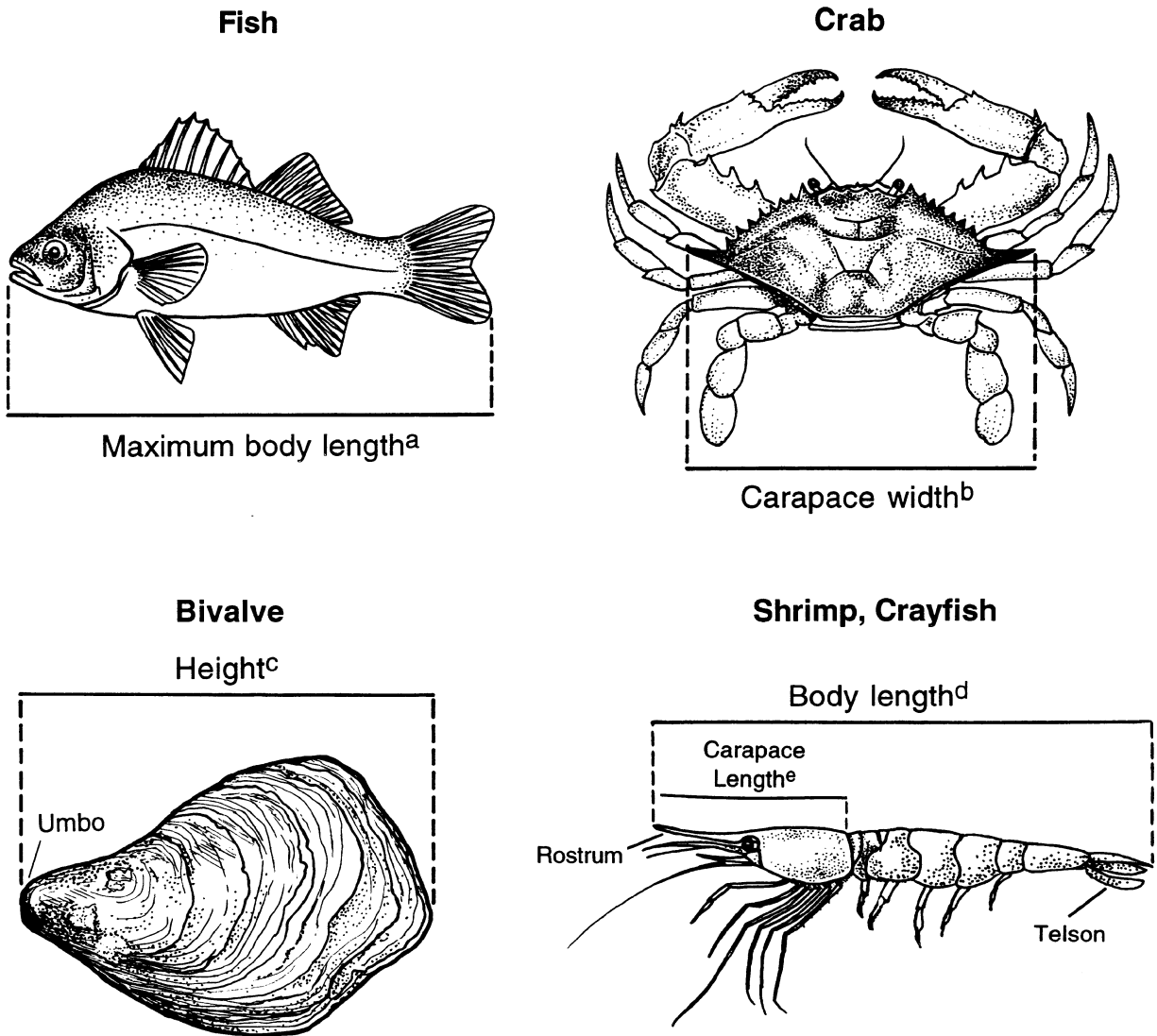

- ^a Maximum body length is the length from the anterior-most part of the fish to the tip of the longest caudal fin ray (when the lobes of the caudal fin are compressed dorsoventrally (Anderson and Gutreuter, 1983).
- ^b Carapace width is the lateral distance across the carapace (from tip of spine to tip of spine (U.S. EPA, 1990c).
- ^c Height is the distance from the umbo to the anterior (ventral) shell margin (Galtsoff, 1964).
- ^d Body length is the distance from the tip of the rostrum to the tip of the telson (Texas Water Commission, 1990).
- ^e Carapace length is distance from top of rostrum to the posterior margin of the carapace.

Figure 6-10. Recommended measurements of body length and size for fish, shellfish, and turtles.

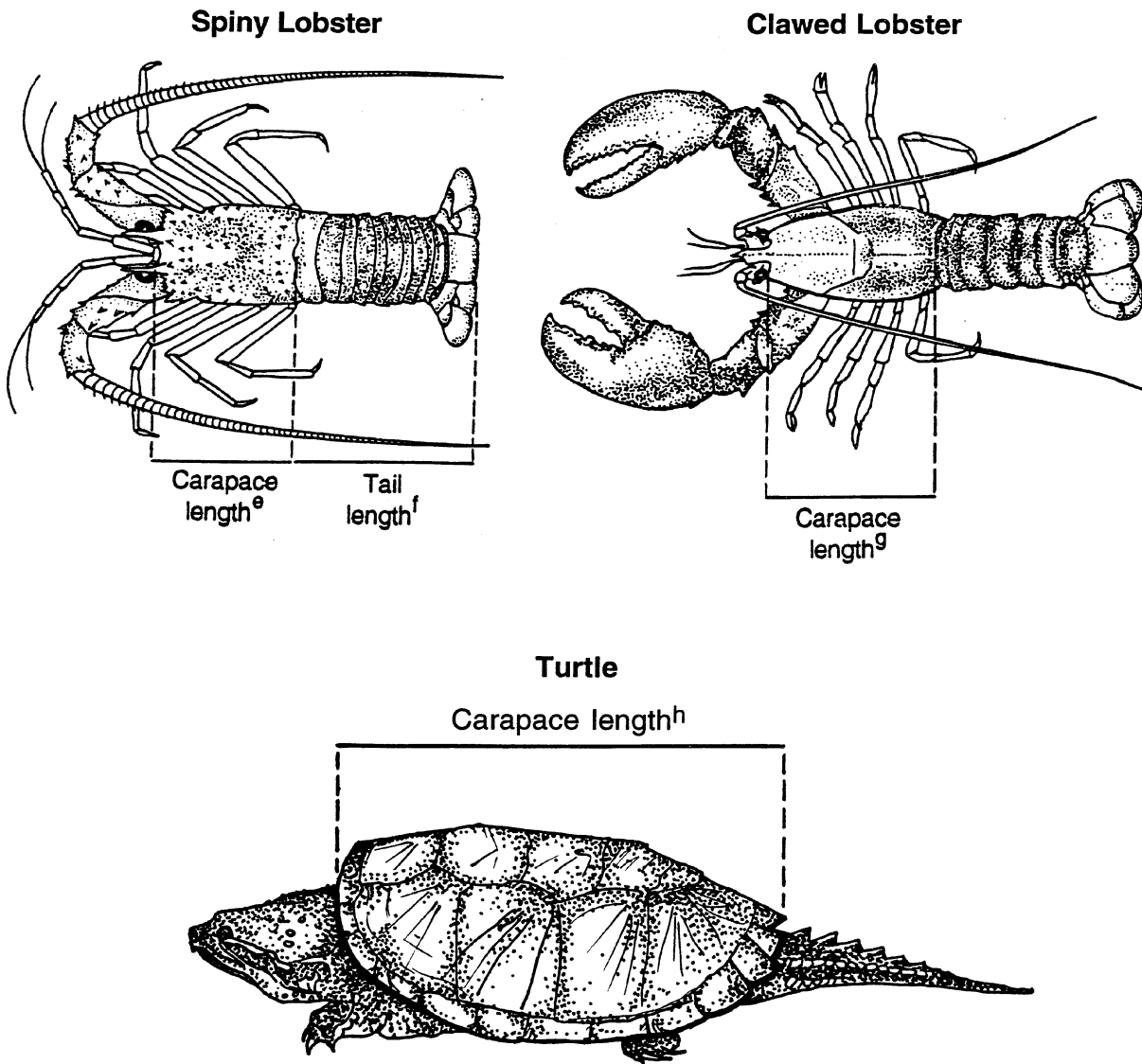

- ^e Carapace length is the distance from the anterior-most edge of the groove between the horns directly above the eyes, to the rear edge of the top part of the carapace as measured along the middorsal line of the back (Laws of Florida Chapter 46-24.003).
- ^f Tail length is the distance measured lengthwise along the top middorsal line of the entire tail to rear-most extremity (this measurement shall be conducted with the tail in a flat straight position with the tip of the tail closed) (Laws of Florida Chapter 46-24.003).
- ^g Carapace length is the distance from the rear of the eye socket to the posterior margin of the carapace (New York Environmental Conservation Law 13-0329.5.a and Massachusetts General Laws Chapter 130).
- ^h Carapace length is the straight-line distance from the anterior margin to the posterior margin of the shell (Conant and Collins, 1991).

Figure 6-10. (continued)

Each turtle within the selected target species should be measured to determine total carapace length (mm). To be consistent with the convention used by most herpetologists in the United States, carapace length should be measured as shown in Figure 6-10. The maximum carapace length is defined as the straight line distance from the anterior edge of the carapace to the posterior edge of the carapace (Conant and Collins, 1991).

For shellfish, each individual specimen should be measured to determine the appropriate body size (mm). As shown in Figure 6-9, the recommended body measurements differ depending on the type of shellfish being collected. Height is a standard measurement of size for oysters, mussels, clams, scallops, and other bivalve molluscs (Abbott, 1974; Galtsoff, 1964). The height is the distance from the umbo to the anterior (ventral) shell margin. For crabs, the lateral width of the carapace is a standard size measurement (U.S. EPA, 1990c); for shrimp and crayfish, the standard measurement of body size is the length from the rostrum to the tip of the telson (Texas Water Commission, 1990); and for lobsters, two standard measurements of body size are commonly used. For clawed and spiny lobsters, the standard size is the length of the carapace. For spiny lobsters, the length of the tail is also used as a standard size measurement.

6.3.1.4 Sex Determination (Optional)—

An experienced fisheries biologist can often make a preliminary sex determination for fish by visual inspection. The body of the fish should not be dissected in the field to determine sex; sex can be determined through internal examination of the gonads during laboratory processing (Section 7.2.2.4).

An experienced herpetologist can often make a preliminary sex determination of a turtle by visual inspection in the field. The plastron (ventral portion of the carapace) is usually flatter in the female and the tail is less well developed than in the male. The plastron also tends to be more concave in the male (Holmes, 1984). For the common snapping turtle (*Chelydra serpentina*), the cloaca of the female is usually located inside or at the perimeter of the carapace, while the cloaca of the male extends slightly beyond the perimeter of the carapace. The carapace of the turtle should never be resected in the field to determine sex; sex can be determined through internal examination of the gonads during laboratory processing (Section 7.2.3.4.). For shellfish, a preliminary sex determination can be made by visual inspection only for crustaceans. Sex cannot be determined in bivalve molluscs without shucking the bivalves and microscopically examining gonadal material. Bivalves should not be shucked in the field to determine sex; sex determination through examination of the gonads can be performed during laboratory processing if desired (Section 7.2.4.2).

6.3.1.5 Morphological Abnormalities (Optional)—

If resources allow, states may wish to consider documenting external gross morphological conditions in fish from contaminated waters. Severely polluted

aquatic habitats have been shown to produce a higher frequency of gross pathological disorders than similar, less polluted habitats (Krahn et al., 1986; Malins et al., 1984, 1985; Mix, 1986; Sinderman, 1983; and Sinderman et al., 1980).

Sinderman et al. (1980) reviewed the literature on the relationship of fish pathology to pollution in marine and estuarine environments and identified four gross morphological conditions acceptable for use in monitoring programs:

- Fin erosion
- Skin ulcers
- Skeletal anomalies
- Neoplasms (i.e., tumors).

Fin erosion is the most frequently observed gross morphological abnormality in polluted areas and is found in a variety of fishes (Sinderman, 1983). In demersal fishes, the dorsal and anal fins are most frequently affected; in pelagic fishes, the caudal fin is primarily affected.

Skin ulcers have been found in a variety of fishes from polluted waters and are the second most frequently reported gross abnormality. Prevalence of ulcers generally varies with season and is often associated with organic enrichment (Sinderman, 1983).

Skeletal anomalies include abnormalities of the head, fins, gills, and spinal column (Sinderman, 1983). Skeletal anomalies of the spinal column include fusions, flexures, and vertebral compressions.

Neoplasms or tumors have been found at a higher frequency in a variety of polluted areas throughout the world. The most frequently reported visible tumors are liver tumors, skin tumors (i.e., epidermal papillomas and/or carcinomas), and neurilemmomas (Sinderman, 1983).

The occurrence of fish parasites and other gross morphological abnormalities that are found at a specific site should be noted on the field record form. States interested in documenting morphological abnormalities in fish should review the protocols for fish pathology studies recommended in the Puget Sound Estuary Program (1990c) and those described by Goede and Barton (1990).

6.3.2 Sample Packaging

6.3.2.1 Fish—

After initial processing to determine species, size, sex, and morphological abnormalities, each fish should be individually wrapped in extra heavy duty aluminum foil. Spines on fish should be sheared to minimize punctures in the aluminum foil packaging (Stober, 1991). The sample identification label shown in Figure 6-7 should be taped to the outside of each aluminum foil package, each individual fish should be placed into a waterproof plastic bag and sealed, and the

COC tag or label should be attached to the outside of the plastic bag with string or tape. All of the packaged individual specimens in a composite sample should be kept together (if possible) in one large waterproof plastic bag in the same shipping container (ice chest) for transport. Once packaged, samples should be cooled on ice immediately.

6.3.2.2 Turtles—

After initial processing to determine the species, size (carapace length), and sex, each turtle should be placed on ice in a separate burlap or canvas bag and stored on ice for transport to the processing laboratory. A completed sample identification label (Figure 6-7) should be attached with string around the neck or one of the turtle's extremities and the COC tag or label should be attached to the outside of the bag with string or tape. **Note:** Bagging each turtle should not be undertaken until the specimen has been sufficiently cooled to induce a mild state of torpor, thus facilitating processing. The samplers should work rapidly to return each turtle to the ice chest as soon as possible after packaging as the turtle may suddenly awaken as it warms thus becoming a danger to samplers (Frye, 1994). As mentioned in Section 6.3.1, states should analyze turtles individually rather than compositing samples. This is especially important when very few specimens are collected at a sampling site or when specimens of widely varying size or age are collected.

Note: When a large number of individual specimens in the same composite sample are shipped together in the same waterproof plastic bag, the samples must have adequate space in the bag to ensure that contact with ice can occur, thus ensuring proper preservation during shipping. This is especially important when samples are collected during hot weather and/or when the time between field collection and delivery to the processing laboratory approaches the maximum shipping time (Table 6-8).

6.3.2.3 Shellfish—

After initial processing to determine species, size, sex, and morphological abnormalities, each shellfish specimen should be wrapped individually in extra heavy duty aluminum foil. A completed sample identification label (Figure 6-7) should be taped to the outside of each aluminum foil package. **Note:** Some crustacean species (e.g., blue crabs and spiny lobsters) have sharp spines on their carapace that might puncture the aluminum foil wrapping. Carapace spines should never be sheared off because this would destroy the integrity of the carapace. For such species, one of the following procedures should be used to reduce punctures to the outer foil wrapping:

- Double-wrap the entire specimen in extra heavy duty aluminum foil.
- Place clean cork stoppers over the protruding spines prior to wrapping the specimen in aluminum foil.

Table 6-8. Recommendations for Preservation of Fish, Shellfish, and Turtle Samples from Time of Collection to Delivery at the Processing Laboratory

Sample type	Number per composite	Container	Preservation	Maximum shipping time
Fish^a				
Whole fish (to be filleted)	3-10	Extra heavy duty aluminum foil wrap of each fish. ^b Each fish is placed in a waterproof plastic bag.	Cool on wet ice or blue ice packets (preferred method) or Freeze on dry ice only if shipping time will exceed 24 hours	24 hours 48 hours
Whole fish	3-10	Same as above.	Cool on wet ice or blue ice packets or Freeze on dry ice	24 hours 48 hours
Shellfish^a				
Whole shellfish (to be resected for edible tissue)	3-50 ^c	Extra heavy duty aluminum foil wrap of each specimen. ^b Shellfish in the same composite sample may be placed in the same waterproof plastic bag.	Cool on wet ice or blue ice packets (preferred method) or Freeze on dry ice if shipping time will exceed 24 hours	24 hours 48 hours
Whole shellfish	3-50 ^c	Same as above.	Cool on wet ice or blue ice packets or Freeze on dry ice	24 hours 48 hours
Whole turtles (to be resected for edible tissue)	1 ^d	Heavy burlap or canvas bags.	Cool on wet ice or blue ice packets (preferred method) or Freeze on dry ice if shipping time to exceed 24 hours	24 hours 48 hours

^a Use only individuals that have attained at least legal harvestable or consumable size.

^b Aluminum foil should not be used for long-term storage of any sample (i.e., whole organisms, fillets, or homogenates) that will be analyzed for metals.

^c Species and size dependent. For very small shellfish species, more than 50 individuals may be required to achieve the 200-g composite sample mass recommended for screening studies.

^d Turtles should be analyzed as individual rather than as composite samples.

- Wrap the spines with multiple layers of foil before wrapping the entire specimen in aluminum foil.

All of the individual aluminum-foil-wrapped shellfish specimens (in the same composite sample) should be placed in the same waterproof plastic bag for transport. In this case, a COC tag or label should be completed for the composite sample and appropriate information recorded on the field record sheet and COC form. The COC label or tag should then be attached to the outside of the plastic

bag with string or tape. For composite samples containing more than 10 shellfish specimens or especially large individuals, additional waterproof plastic bags may be required to ensure proper preservation. Once packaged, composite samples should be cooled on ice immediately. **Note:** When a large number of individual specimens in the same composite sample are shipped together in the same waterproof plastic bag, the samples must have adequate space in the bag to ensure that contact with ice can occur; thus ensuring proper preservation during shipping. This is especially important when samples are collected during hot weather and/or when the time between field collection and delivery to the processing laboratory approaches the maximum shipping time (Table 6-8).

6.3.3 Sample Preservation

The type of ice to be used for shipping should be determined by the length of time the samples will be in transit to the processing laboratory and the sample type to be analyzed (Table 6-8).

6.3.3.1 Fish, Turtles, or Shellfish To Be Resected—

Note: Ideally fish, turtles, and shellfish specimens should not be frozen prior to resection if analyses will include edible tissue only because freezing may cause some internal organs to rupture and contaminate fillets or other edible tissues (Stober, 1991; U.S. EPA, 1986b). Wet ice or blue ice (sealed prefrozen ice packets) is recommended as the preservative of choice when the fish fillet, turtle meat, or shellfish edible portions are the primary tissues to be analyzed. Samples shipped on wet or blue ice should be delivered to the processing laboratory within 24 hours (Smith, 1985; U.S. EPA, 1990d). If the shipping time to the processing laboratory will exceed 24 hours, dry ice should be used.

Note: One exception to the use of dry ice for long-term storage is if fish or shellfish are collected as part of extended offshore field surveys. States involved in these types of field surveys may employ shipboard freezers to preserve samples for extended periods rather than using dry ice. Ideally, all fish should be resected in cleanrooms aboard ship prior to freezing.

6.3.3.2 Fish, Turtles, or Shellfish for Whole-Body Analysis—

At some sites, states may deem it necessary to collect fish, turtles, or shellfish for whole-body analysis if a local subpopulation of concern typically consumes whole fish, turtles, or shellfish. If whole fish, turtles, or shellfish samples are to be analyzed, either wet ice, blue ice, or dry ice may be used; however, if the shipping time to the processing laboratory will exceed 24 hours, dry ice should be used.

Dry ice requires special packaging precautions before shipping by aircraft to comply with U.S. Department of Transportation (DOT) regulations. The *Code of Federal Regulations* (49 CFR 173.217) classifies dry ice as Hazard Class 9 UN1845 (Hazardous Material). These regulations specify the amount of dry ice

that may be shipped by air transport and the type of packaging required. For each shipment by air exceeding 5 pounds of dry ice per package, advance arrangements must be made with the carrier. Not more than 441 pounds of dry ice may be transported in any one cargo compartment on any aircraft unless the shipper has made special written arrangements with the aircraft operator.

The regulations further specify that the packaging must be designed and constructed to permit the release of carbon dioxide gas to prevent a buildup of pressure that could rupture the package. If samples are transported in a cooler, several vent holes should be drilled to allow carbon dioxide gas to escape. The vents should be near the top of the vertical sides of the cooler, rather than in the cover, to prevent debris from falling into the cooler. Wire screen or cheesecloth should be installed in the vents to keep foreign materials from contaminating the cooler. When the samples are packaged, care should be taken to keep these vents open to prevent the buildup of pressure.

Dry ice is exempted from shipping certification requirements if the amount is less than 441 pounds and the package meets design requirements. The package must be marked "Carbon Dioxide, Solid" or "Dry Ice" with a statement indicating that the material being refrigerated is to be used for diagnostic or treatment purposes (e.g., frozen tissue samples).

6.3.4 Sample Shipping

The fish, turtle, and shellfish samples should be hand-delivered or shipped to the processing laboratory as soon as possible after collection. The time the samples were collected and time of their arrival at the processing laboratory should be recorded on the COC form (Figure 6-9).

If the sample is to be shipped rather than hand-delivered to the processing laboratory, field collection staff must ensure the samples are packed properly with adequate ice layered between samples so that sample degradation does not occur. In addition, a member of the field collection staff should telephone ahead to the processing laboratory to alert them to the anticipated delivery time of the samples and the name and address of the carrier to be used. Field collection staff should avoid shipping samples for weekend delivery to the processing laboratory unless prior plans for such a delivery have been agreed upon with the processing laboratory staff.

SECTION 7

LABORATORY PROCEDURES I — SAMPLE HANDLING

This section provides guidance on laboratory procedures for sample receipt, chain-of-custody, processing, distribution, analysis, and archiving. Planning, documentation, and quality assurance and quality control of all laboratory activities are emphasized to ensure that (1) sample integrity is preserved during all phases of sample handling and analysis, (2) chemical analyses are performed cost-effectively and meet program data quality objectives, and (3) data produced by different states and regions are comparable.

Laboratory procedures should be documented in a Work/QA Project Plan (U.S. EPA, 1980b) as described in Appendix I. Routine sample processing and analysis procedures should be prepared as standard operating procedures (SOPs) (U.S. EPA, 1984b).

7.1 SAMPLE RECEIPT AND CHAIN-OF-CUSTODY

Fish, shellfish, and turtle samples may be shipped or hand-carried from the field according to one or more of the following pathways:

- From the field to a state laboratory for sample processing and analysis
- From the field to a state laboratory for sample processing and shipment of composite sample aliquots to a contract laboratory for analysis
- From the field to a contract laboratory for sample processing and analysis.

Sample processing and distribution for analysis ideally should be performed by one processing laboratory. Transportation of samples from the field should be coordinated by the sampling team supervisor and the laboratory supervisor responsible for sample processing and distribution (see Section 6.3.4). An accurate written custody record must be maintained so that possession and treatment of each sample can be traced from the time of collection through analysis and final disposition.

Fish, shellfish, and turtle samples should be brought or shipped to the sample processing laboratory in sealed containers accompanied by a copy of the sample request form (Figure 6-1), a chain-of-custody form (Figure 6-9), and the field records (Figures 6-3 through 6-6). Each time custody of a sample or set of samples is transferred, the Personnel Custody Record of the COC form must be completed and signed by both parties. Corrections to the COC form should be made in indelible ink by drawing a single line through the original entry, entering

7. LABORATORY PROCEDURES I — SAMPLE HANDLING

the correct information and the reason for the change, and initialing and dating the correction. The original entry should never be obscured.

When custody is transferred from the field to the sample processing laboratory, the following procedure should be used:

- Note the shipping time. If samples have been shipped on wet or blue ice, check that the shipping time has not exceeded 24 hours.
- Check that each shipping container has arrived undamaged and that the seal is intact.
- Open each shipping container and remove the copy of the sample request form, the COC form, and the field records.
- Note the general condition of the shipping container (samples iced properly with no leaks, etc.) and the accompanying documentation (dry, legible, etc.).
- Locate individuals in each composite sample listed on the COC form and note the condition of their packaging. Individual specimens should be properly wrapped and labeled. Note any problems (container punctured, illegible labels, etc.) on the COC form.
- If individuals in a composite are packaged together, check the contents of each composite sample container against the field record for that sample to ensure that the individual specimens are properly wrapped and labeled. Note any discrepancies or missing information on the COC form.
- Initial the COC form and record the date and time of sample receipt.
- Enter the following information for each composite sample into a permanent laboratory record book and, if applicable, a computer database:
 - Sample identification number (specify conventions for the composite sample number and the specimen number) **Note:** EPA recommends processing and analysis of turtles as individual samples.
 - Receipt date (use Year 2000 compliant format [YYYYMMDD])
 - Sampling date (use Year 2000 compliant format [YYYYMMDD])
 - Sampling site (name and/or identification number)
 - Fish, turtle, and shellfish species (scientific name or code number)
 - Total length of each fish, carapace length of each turtle, or size of each shellfish (mm)

- If samples have been shipped on wet or blue ice, distribute them immediately to the technician responsible for resection (see Section 7.2). See Section 7.2.3 for the procedure for processing turtle samples as individual samples. If samples have been shipped on dry ice, they may be distributed immediately to the technician for processing or stored in a freezer at ≤ -20 °C for later processing. Once processed, fillets or edible portions of fish, turtles, or shellfish or tissue homogenates, should be stored according to the procedures described in Section 7.2 and in Table 7-1. **Note:** Holding times in Table 7-1 are maximum times recommended for holding samples from the time they are received at the laboratory until they are analyzed. These holding times are based on guidance that is sometimes administrative rather than technical in nature; there are no promulgated holding time criteria for tissues (U.S. EPA, 1995i). If states choose to use longer holding times, they must demonstrate and document the stability of the target analyte residues over the extended holding times.

7.2 SAMPLE PROCESSING

This section includes recommended procedures for preparing composite homogenate samples of fish fillets and edible portions of shellfish and individual samples of edible portions of freshwater turtles as required in screening and intensive studies. Recommended procedures for preparing whole fish composite homogenates are included in Appendix J for use by states in assessing the potential risk to local subpopulations known to consume whole fish or shellfish.

7.2.1 General Considerations

All laboratory personnel performing sample processing procedures (see Sections 7.2.2, 7.2.3, and 7.2.4) should be trained or supervised by an experienced fisheries biologist. Care must be taken during sample processing to avoid contaminating samples. Schmitt and Finger (1987) have demonstrated that contamination of fish flesh samples is likely unless the most exacting clean dissection procedures are used. Potential sources of contamination include dust, instruments, utensils, work surfaces, and containers that may contact the samples. All sample processing (i.e., filleting, removal of other edible tissue, homogenizing, compositing) should be done in an appropriate laboratory facility under cleanroom conditions (Stober, 1991). Cleanrooms or work areas should be free of metals and organic contaminants. Ideally, these areas should be under positive pressure with filtered air (HEPA filter class 100) (California Department of Fish and Game, 1990). Periodic wipe tests should be conducted in clean areas to verify the absence of significant levels of metal and organic contaminants. All instruments, work surfaces, and containers used to process samples must be of materials that can be cleaned easily and that are not themselves potential sources of contamination. More detailed guidance on establishing trace metal cleanrooms is provided in U.S. EPA (1995a).

7. LABORATORY PROCEDURES I — SAMPLE HANDLING

Table 7-1. Recommendations for Container Materials, Preservation, and Holding Times for Fish, Shellfish, and Turtle Tissues from Receipt at Sample Processing Laboratory to Analysis

Analyte	Matrix	Sample container	Storage	
			Preservation	Holding time ^a
Mercury	Tissue (fillets and edible portions, homogenates)	Plastic, borosilicate glass, quartz, PTFE	Freeze at ≤ -20 °C	28 days ^b
Other metals	Tissue (fillets and edible portions, homogenates)	Plastic, borosilicate glass, quartz, PTFE	Freeze at ≤ -20 °C	6 months ^c
Organics	Tissue (fillets and edible portions, homogenates)	Borosilicate glass, PTFE, quartz, aluminum foil	Freeze at ≤ -20 °C	1 year ^d
Metals and organics	Tissue (fillets and edible portions, homogenates)	Borosilicate glass, quartz, PTFE	Freeze at ≤ -20 °C	28 days (for mercury); 6 months (for other metals); and 1 year (for organics)
Lipids	Tissue (fillets and edible portions, homogenates)	Plastic, borosilicate glass, quartz, PTFE	Freeze at ≤ -20 °C	1 year

PTFE = Polytetrafluoroethylene (Teflon).

^a Maximum holding times recommended by EPA (1995i).

^b This maximum holding time is also recommended by the Puget Sound Estuary Program (1990e). The California Department of Fish and Game (1990) and the USGS National Water Quality Assessment Program (Crawford and Luoma, 1993) recommend a maximum holding time of 6 months for all metals, including mercury.

^c This maximum holding time is also recommended by the California Department of Fish and Game (1990), the 301(h) monitoring program (U.S. EPA, 1986b), and the USGS National Water Quality Assessment Program (Crawford and Luoma, 1993). The Puget Sound Estuary Program (1990e) recommends a maximum holding time of 2 years.

^d This maximum holding time is also recommended by the Puget Sound Estuary Program (1990e). The California Department of Fish and Game (1990) and the USGS National Water Quality Assessment Program (Crawford and Luoma, 1993) recommend a more conservative maximum holding time of 6 months. U.S. EPA (1995b) recommends a maximum holding time of 1 year at ≤ -10 °C for dioxins/furans.

To avoid cross-contamination, all equipment used in sample processing (i.e., resecting, homogenizing, and compositing) should be cleaned thoroughly before each composite sample is prepared. Verification of the efficacy of cleaning procedures should be documented through the analysis of processing blanks or rinsates (see Section 8.3.3.6).

Because sources of organic and metal contaminants differ, it is recommended that duplicate samples be collected, if time and funding permit, when analyses of both organics and metals are required (e.g., for screening studies). One sample can then be processed and analyzed for organics and the other can be processed independently and analyzed for metals (Batelle, 1989; California Department of Fish and Game, 1990; Puget Sound Estuary Program, 1990c, 1990d). If fish are of adequate size, separate composites of individual fillets may be prepared and

analyzed independently for metals and organics. If only one composite sample is prepared for the analyses of metals and organics, the processing equipment must be chosen and cleaned carefully to avoid contamination by both organics and metals.

Suggested sample processing equipment and cleaning procedures by analysis type are discussed in Sections 7.2.1.1 through 7.2.1.3. Other procedures may be used if it can be demonstrated, through the analysis of appropriate blanks, that no contamination is introduced (see Section 8.3.3.6).

7.2.1.1 Samples for Organics Analysis—

Equipment used in processing samples for organics analysis should be of stainless steel, anodized aluminum, borosilicate glass, polytetrafluoroethylene (PTFE), ceramic, or quartz. Polypropylene and polyethylene (plastic) surfaces, implements, gloves, and containers are a potential source of contamination by organics and should not be used. If a laboratory chooses to use these materials, there should be clear documentation that they are not a source of contamination. Filleting should be done on glass or PTFE cutting boards that are cleaned properly between fish or on cutting boards covered with heavy duty aluminum foil that is changed after each filleting. Tissue should be removed with clean, high-quality, corrosion-resistant stainless steel or quartz instruments or with knives with titanium blades and PTFE handles (Lowenstein and Young, 1986). Fillets or tissue homogenates may be stored in borosilicate glass, quartz, or PTFE containers with PTFE-lined lids or in heavy duty aluminum foil (see Table 7-1).

Prior to preparing each composite sample, utensils and containers should be washed with detergent solution, rinsed with tap water, soaked in pesticide-grade isopropanol or acetone, and rinsed with organic-free, distilled, deionized water. Work surfaces should be cleaned with pesticide-grade isopropanol or acetone, washed with distilled water, and allowed to dry completely. Knives, fish scalers, measurement boards, etc., should be cleaned with pesticide-grade isopropanol or acetone followed by a rinse with contaminant-free distilled water between each fish sample (Stober, 1991).

7.2.1.2 Samples for Metals Analysis—

Equipment used in processing samples for metals analyses should be of quartz, PTFE, ceramic, polypropylene, or polyethylene. The predominant metal contaminants from stainless steel are chromium and nickel. If these metals are not of concern, the use of high-quality, corrosion-resistant stainless steel for sample processing equipment is acceptable. Quartz utensils are ideal but expensive. For bench liners and bottles, borosilicate glass is preferred over plastic (Stober, 1991). Knives with titanium blades and PTFE handles are recommended for performing tissue resections (Lowenstein and Young, 1986). Borosilicate glass bench liners are recommended. Filleting may be done on glass or PTFE cutting boards that are cleaned properly between fish or on cutting

boards covered with heavy duty aluminum foil that is changed after each fish. Fillets or tissue homogenates may be stored in plastic, borosilicate glass, quartz, or PTFE containers (see Table 7-1).

Prior to preparing each composite sample, utensils and containers should be cleaned thoroughly with a detergent solution, rinsed with tap water, soaked in acid, and then rinsed with metal-free water. Quartz, PTFE, glass, or plastic containers should be soaked in 50 percent HNO₃, for 12 to 24 hours at room temperature. **Note:** Chromic acid should not be used for cleaning any materials. Acids used should be at least reagent grade. Stainless steel parts may be cleaned as stated for glass or plastic, omitting the acid soaking step (Stober, 1991).

7.2.1.3 Samples for Both Organics and Metals Analyses—

As noted above, several established monitoring programs, including the Puget Sound Estuary Program (1990c, 1990d), the NOAA Mussel Watch Program (Battelle, 1989), and the California Mussel Watch Program (California Department of Fish and Game, 1990), recommend different procedures for processing samples for organics and metals analyses. However, this may not be feasible if fish are too small to allow for preparing separate composites from individual fillets or if resources are limited. If a single composite sample is prepared for the analyses of both organics and metals, precautions must be taken to use materials and cleaning procedures that are noncontaminating for both organics and metals.

Quartz, ceramic, borosilicate glass, and PTFE are recommended materials for sample processing equipment. If chromium and nickel are not of concern, high-quality, corrosion-resistant stainless steel utensils may be used. Knives with titanium blades and PTFE handles are recommended for performing tissue resections (Lowenstein and Young, 1986). Borosilicate glass bench liners are recommended. Filleting should be done on glass or PTFE cutting boards that are cleaned properly between fish or on cutting boards covered with heavy duty aluminum foil that is changed after each filleting. Fillets or tissue homogenates should be stored in clean borosilicate glass, quartz, or PTFE containers with PTFE-lined lids.

Prior to preparing each composite sample, utensils and containers should be cleaned thoroughly with a detergent solution, rinsed with tap water, soaked in 50 percent HNO₃, for 12 to 24 hours at room temperature, and then rinsed with organics- and metal-free water. **Note:** Chromic acid should not be used for cleaning any materials. Acids used should be at least reagent grade. Stainless steel parts may be cleaned using this recommended procedure with the acid soaking step method omitted (Stober, 1991).

Aliquots of composite homogenates taken for metals analysis (see Section 7.3.1) may be stored in plastic containers that have been cleaned according to the

procedure outlined above, with the exception that aqua regia must not be used for the acid soaking step.

7.2.2 Processing Fish Samples

Processing in the laboratory to prepare fish fillet composite homogenate samples for analysis (diagrammed in Figure 7-1) involves

- Inspecting individual fish
- Weighing individual fish
- Removing scales and/or otoliths for age determination (optional)
- Determining the sex of each fish (optional)
- Examining each fish for morphological abnormalities (optional)
- Scaling all fish with scales (leaving belly flap on); removing skin of scaleless fish (e.g., catfish)
- Filleting (resection)
- Weighing fillets
- Homogenizing fillets
- Preparing a composite homogenate
- Preparing aliquots of the composite homogenate for analysis
- Distributing frozen aliquots to one or more analytical laboratories.

Whole fish should be shipped or brought to the sample processing laboratory from the field on wet or blue ice within 24 hours of sample collection. Fillets should be resected within 48 hours of sample collection. Ideally, fish should not be frozen prior to resection because freezing may cause internal organs to rupture and contaminate edible tissue (Stober, 1991; U.S. EPA, 1986b). However, if resection cannot be performed within 48 hours, the whole fish should be frozen at the sampling site and shipped to the sample processing laboratory on dry ice. Fish samples that arrive frozen (i.e., on dry ice) at the sample processing laboratory should be placed in a ≤ -20 °C freezer for storage until filleting can be performed. The fish should then be partially thawed prior to resection. **Note:** If the fillet tissue is contaminated by materials released from the rupture of the internal organs during freezing, the state may eliminate the fillet tissue as a sample or, alternatively, the fillet tissues should be rinsed in contaminant-free, distilled deionized

7. LABORATORY PROCEDURES I — SAMPLE HANDLING

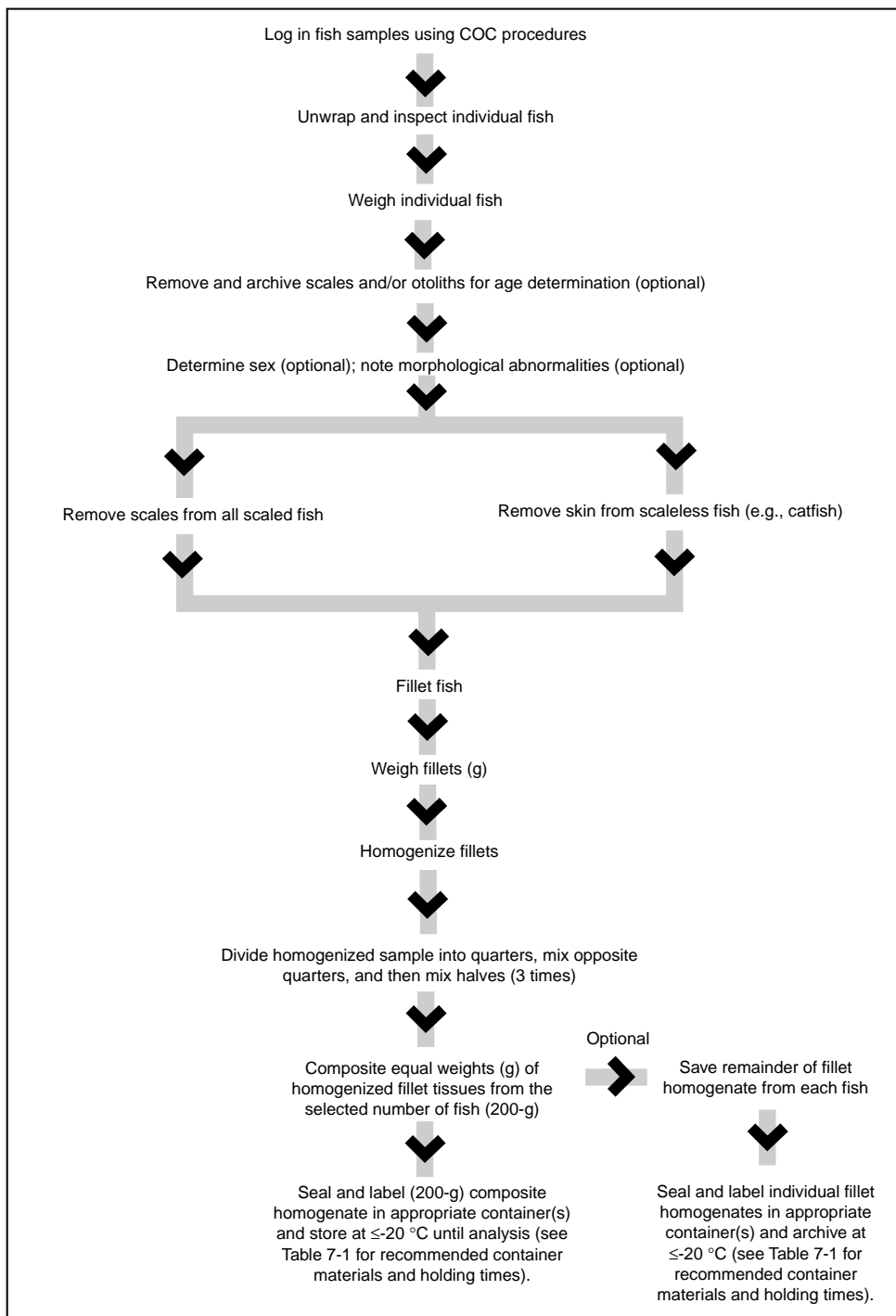

COC = Chain of custody.

Figure 7-1. Preparation of fish fillet composite homogenate samples.

water and blotted dry. Regardless of the procedure selected, a notation should be made in the sample processing record.

Sample processing procedures are discussed in the following sections. Data from each procedure should be recorded directly in a bound laboratory notebook or on forms that can be secured in the laboratory notebook. A sample processing record for fish fillet composites is shown in Figure 7-2.

7.2.2.1 Sample Inspection—

Individual fish received for filleting should be unwrapped and inspected carefully to ensure that they have not been compromised in any way (i.e., not properly preserved during shipment). Any specimen deemed unsuitable for further processing and analysis should be discarded and identified on the sample processing record.

7.2.2.2 Sample Weighing—

A wet weight should be determined for each fish. All samples should be weighed on balances that are properly calibrated and of adequate accuracy and precision to meet program data quality objectives. Balance calibration should be checked at the beginning and end of each weighing session and after every 20 weighings in a weighing session.

Fish shipped on wet or blue ice should be weighed directly on a foil-lined balance tray. To prevent cross contamination between individual fish, the foil lining should be replaced after each weighing. Frozen fish (i.e., those shipped on dry ice) should be weighed in clean, tared, noncontaminating containers if they will thaw before the weighing can be completed. **Note:** Liquid from the thawed whole fish sample will come not only from the fillet tissue but from the gut and body cavity, which are not part of the final fillet sample. Consequently, inclusion of this liquid with the sample may result in an overestimate of target analyte and lipid concentrations in the fillet homogenate. Nevertheless, it is recommended, as a conservative approach, that all liquid from the thawed whole fish sample be kept in the container as part of the sample.

All weights should be recorded to the nearest gram on the sample processing record and/or in the laboratory notebook.

7.2.2.3 Age Determination (Optional)—

Age provides a good indication of the duration of exposure to pollutants (Versar, 1982). A few scales or otoliths (Jearld, 1983) should be removed from each fish and delivered to a fisheries biologist for age determination. For most warm water inland gamefish, 5 to 10 scales should be removed from below the lateral line and behind the pectoral fin. On soft-rayed fish such as trout and salmon, the scales should be taken just above the lateral line (WDNR, 1988). For catfish and other

Sample Processing Record for Fish Contaminant Monitoring Program — Fish Fillet Composites

Project Number: _____ Sampling Date and Time: _____

STUDY PHASE: Screening Study ; Intensive Study: Phase I Phase II

SITE LOCATION

Site Name/Number: _____

County/Parish: _____ Lat./Long.: _____

Waterbody Name/Segment Number: _____ Waterbody Type: _____

Sample Type (bottom feeder, predator, etc.) _____ **Species Name:** _____

Composite Sample #: _____ Replicate Number: _____ Number of Individuals: _____

Fish #	Weight (g)	Scales/Otoliths Removed (✓)	Sex (M,F)	Resection Performed (✓)	First Fillet (F1) or Combined Fillets (C)			Second Fillet (F2)		
					Weight (g)	Homogenate Prepared (✓)	Wt. of Homog. for Composite (g)	Weight (g)	Homogenate Prepared (✓)	Wt. of Homog. for Composite (g)
001	_____	_____	_____	_____	_____	_____	_____	_____	_____	_____
002	_____	_____	_____	_____	_____	_____	_____	_____	_____	_____
003	_____	_____	_____	_____	_____	_____	_____	_____	_____	_____
004	_____	_____	_____	_____	_____	_____	_____	_____	_____	_____
005	_____	_____	_____	_____	_____	_____	_____	_____	_____	_____
006	_____	_____	_____	_____	_____	_____	_____	_____	_____	_____
007	_____	_____	_____	_____	_____	_____	_____	_____	_____	_____
008	_____	_____	_____	_____	_____	_____	_____	_____	_____	_____
009	_____	_____	_____	_____	_____	_____	_____	_____	_____	_____
010	_____	_____	_____	_____	_____	_____	_____	_____	_____	_____
Analyst	_____	_____	_____	_____	_____	_____	_____	_____	_____	_____
Date	_____	_____	_____	_____	_____	_____	_____	_____	_____	_____
Total Composite Weight (g)					(F1 or C) _____	(F2) _____				

Notes: _____

Figure 7-2. Sample processing record for fish contaminant monitoring program—fish fillet composites.

scaleless fish, the pectoral fin spines should be clipped and saved (Versar, 1982). The scales, spines, or otoliths may be stored by sealing them in small envelopes (such as coin envelopes) or plastic bags labeled with, and cross-referenced by, the identification number assigned to the tissue specimen (Versar, 1982). Removal of scales, spines, or otoliths from each fish should be noted (by a check mark) on the sample processing record.

7.2.2.4 Sex Determination (Optional)—

Fish sex should be determined before filleting. To determine the sex of a fish, an incision should be made on the ventral surface of the body from a point immediately anterior to the anus toward the head to a point immediately posterior to the pelvic fins. If necessary, a second incision should be made on the left side of the fish from the initial point of the first incision toward the dorsal fin. The resulting flap should be folded back to observe the gonads. Ovaries appear whitish to greenish to golden brown and have a granular texture. Testes appear creamy white and have a smooth texture (Texas Water Commission, 1990). The sex of each fish should be recorded on the sample processing form.

7.2.2.5 Assessment of Morphological Abnormalities (Optional)—

Assessment of gross morphological abnormalities in finfish is optional. This assessment may be conducted in the field (see Section 6.3.1.5) or during initial inspection at the processing laboratory prior to filleting. States interested in documenting morphological abnormalities should consult Sinderman (1983) and review recommended protocols for fish pathology studies used in the Puget Sound Estuary Program (1990c) and those described by Goede and Barton (1990).

7.2.2.6 Scaling or Skinning—

To control contamination, separate sets of utensils and cutting boards should be used for skinning or scaling fish and for filleting fish. Fish with scales should be scaled and any adhering slime removed prior to filleting. Fish without scales (e.g., catfish) should be skinned prior to filleting. These fillet types are recommended because it is believed that they are most representative of the edible portions of fish prepared and consumed by sport anglers. However, it is the responsibility of each program manager, in consultation with state fisheries experts, to select the fillet or sample type most appropriate for each target species based on the dietary customs of local populations of concern.

A fish is scaled by laying it flat on a clean glass or PTFE cutting board or on one that has been covered with heavy duty aluminum foil and removing the scales and adhering slime by scraping from the tail to the head using the blade edge of a clean stainless steel, ceramic, or titanium knife. Cross-contamination is controlled by rinsing the cutting board and knife with contaminant-free distilled water between fish. If an aluminum-foil-covered cutting board is used, the foil should be

changed between fish. The skin should be removed from fish without scales by loosening the skin just behind the gills and pulling it off between knife blade and thumb or with pliers as shown in Figure 7-3.

Once the scales and slime have been scraped off or the skin removed, the outside of the fish should be washed with contaminant-free distilled water and it should be placed on a second clean cutting board for filleting.

7.2.2.7 Filleting—

Filleting should be conducted only by or under the supervision of an experienced fisheries biologist. If gloves are worn, they should be talc- or dust-free, and of noncontaminating materials. Prior to filleting, hands should be washed with Ivory soap and rinsed thoroughly in tap water, followed by distilled water (U.S. EPA, 1991d). Specimens should come into contact with noncontaminating surfaces only. Fish should be filleted on glass or PTFE cutting boards that are cleaned properly between fish or on cutting boards covered with heavy duty aluminum foil that is changed between fish (Puget Sound Estuary Program, 1990d, 1990e). Care must be taken to avoid contaminating fillet tissues with material released from inadvertent puncture of internal organs. **Note:** If the fillet tissue is contaminated by materials released from the inadvertent puncture of the internal organs during resection, the state may eliminate the fillet tissue as a sample or, alternatively, the fillet tissue should be rinsed in contaminant-free, deionized distilled water and blotted dry. Regardless of the procedure selected, a notation should be made in the sample processing record.

Ideally, fish should be filleted while ice crystals are still present in the muscle tissue. Therefore, if fish have been frozen, they should not be allowed to thaw completely prior to filleting. Fish should be thawed only to the point where it becomes possible to make an incision into the flesh (U.S. EPA, 1991d).

Clean, high-quality stainless steel, ceramic, or titanium utensils should be used to remove one or both fillets from each fish, as necessary. The general procedure recommended for filleting fish is illustrated in Figure 7-3 (U.S. EPA, 1991d).

The belly flap should be included in each fillet. Any dark muscle tissue in the vicinity of the lateral line should not be separated from the light muscle tissue that constitutes the rest of the muscle tissue mass. Bones still present in the tissue after filleting should be removed carefully (U.S. EPA, 1991d).

If both fillets are removed from a fish, they can be combined or kept separate for duplicate QC analysis, analysis of different analytes, or archival of one fillet. Fillets should be weighed (either individually or combined, depending on the analytical requirements) and the weight(s) recorded to the nearest gram on the sample processing record.

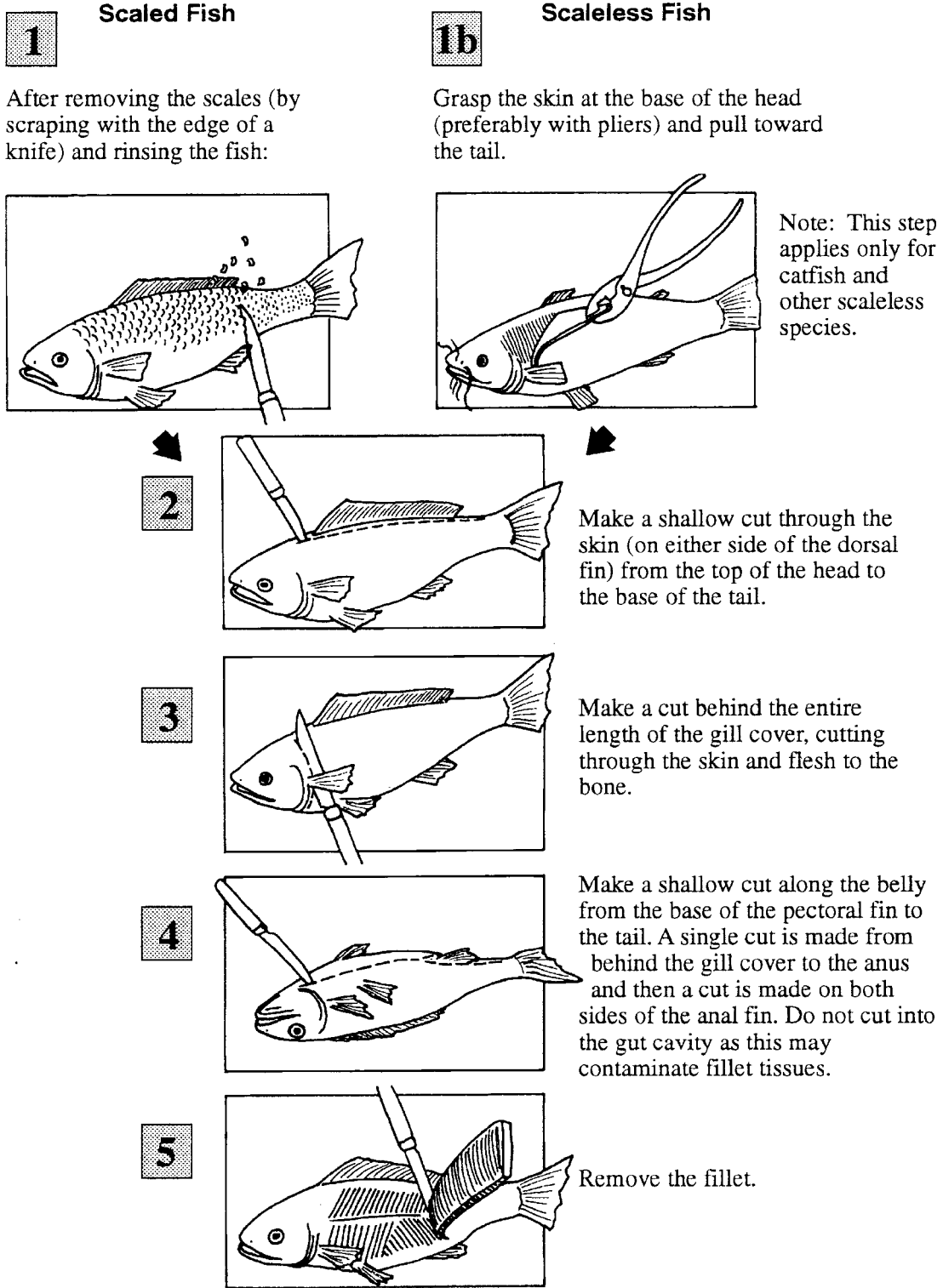

Source: U.S. EPA, 1991d.

Figure 7-3. Illustration of basic fish filleting procedure.

If fillets are to be homogenized immediately, they should be placed in a properly cleaned glass or PTFE homogenization container. If samples are to be analyzed for metals only, plastic homogenization containers may be used. To facilitate homogenization, it may be necessary or desirable to chop each fillet into smaller pieces using a titanium or stainless steel knife prior to placement in the homogenization container.

If fillets are to be homogenized later, they should be wrapped in heavy duty aluminum foil and labeled with the sample identification number, the sample type (e.g., "F" for fillet), the weight (g), and the date of resection. If composite homogenates are to be prepared from only a single fillet from each fish, fillets should be wrapped separately and the designation "F1" and "F2" should be added to the sample identification number for each fillet. The individual fillets from each fish should be kept together. All fillets from a composite sample should be placed in a plastic bag labeled with the composite identification number, the individual sample identification numbers, and the date of resection and stored at ≤ -20 °C until homogenization.

7.2.2.8 Preparation of Individual Homogenates—

To ensure even distribution of contaminants throughout tissue samples and to facilitate extraction and digestion of samples, the fillets from individual fish must be ground and homogenized prior to analysis. The fillets from an individual fish may be ground and homogenized separately or combined, depending on the analytical requirements and the sample size.

Fish fillets should be ground and homogenized using an automatic grinder or high-speed blender or homogenizer. Large fillets may be cut into 2.5-cm cubes with high-quality stainless steel or titanium knives or with a food service band saw prior to homogenization. Parts of the blender or homogenizer used to grind the tissue (i.e., blades, probes) should be made of tantalum or titanium rather than stainless steel. Stainless steel blades and/or probes have been found to be a potential source of nickel and chromium contamination (due to abrasion at high speeds) and should be avoided.

Grinding and homogenization of tissue is easier when it is partially frozen (Stober, 1991). Chilling the grinder/blender briefly with a few chips of dry ice will also help keep the tissue from sticking to it (Smith, 1985).

The fillet sample should be ground until it appears to be homogeneous. The ground sample should then be divided into quarters, opposite quarters mixed together by hand, and the two halves mixed together. The grinding, quartering, and hand-mixing steps should be repeated at least two more times. If chunks of tissue are present at this point, the grinding and homogenization should be repeated. **Note:** Skin-on fillets are the fish fillet sample type recommended for use in state fish contaminant monitoring programs. However, skin-on fillets of some finfish species are especially difficult to homogenize completely. No chunks

of tissue or skin should remain in the sample homogenate because these may not be extracted or digested efficiently and could bias the analytical results. If complete homogenization of skin-on fillets for a particular target species is a chronic problem or if local consumers are likely to prepare skinless fillets of the species, the state should consider analyzing skinless fillet samples. If the sample is to be analyzed for metals only, the ground tissue may be mixed by hand in a polyethylene bag (Stober, 1991). The preparation of each individual homogenate should be noted (marked with a check) on the sample processing record. At this time, individual homogenates may be either processed further to prepare composite homogenates or frozen separately and stored at ≤ -20 °C (see Table 7-1).

7.2.2.9 Preparation of Composite Homogenates—

Composite homogenates should be prepared from equal weights of individual homogenates. The same type of individual homogenate (i.e., either single fillet or combined fillet) should always be used in a given composite sample.

If individual homogenates have been frozen, they should be thawed partially and rehomogenized prior to weighing and compositing. Any associated liquid should be kept as a part of the sample. The weight of each individual homogenate used in the composite homogenate should be recorded, to the nearest gram, on the sample processing record.

Each composite homogenate should be blended as described for individual homogenates in Section 7.2.2.8. The composite homogenate may be processed immediately for analysis or frozen and stored at ≤ -20 °C (see Table 7-1).

The remainder of each individual homogenate should be archived at ≤ -20 °C with the designation "Archive" and the expiration date recorded on the sample label. The location of the archived samples should be indicated on the sample processing record under "Notes."

It is essential that the weights of individual homogenates yield a composite homogenate of adequate size to perform all necessary analyses. Weights of individual homogenates required for a composite homogenate, based on the number of fish per composite and the weight of composite homogenate recommended for analyses of all screening study target analytes (see Table 4-1), are given in Table 7-2. The total composite weight required for intensive studies may be less than that for screening studies if the number of target analytes is reduced significantly.

The recommended sample size of 200 g for screening studies is intended to provide sufficient sample material to (1) analyze for all recommended target analytes (see Table 4-1) at appropriate detection limits; (2) meet minimum QC requirements for the analyses of laboratory duplicate, matrix spike, and matrix spike duplicate samples (see Sections 8.3.3.4 and 8.3.3.5); and (3) allow for

Table 7-2. Weights (g) of Individual Homogenates Required for Screening Study Composite Homogenate Sample^{a,b}

Number of fish per sample	Total composite weight		
	100 g (minimum)	200 g (recommended)	500 g (maximum)
3	33	67	167
4	25	50	125
5	20	40	100
6	17	33	84
7	14	29	72
8	13	25	63
9	11	22	56
10	10	20	50

^a Based on total number of fish per composite and the total composite weight required for analysis in screening studies. The total composite weight required in intensive studies may be less if the number of target analytes is reduced significantly.

^b Individual homogenates may be prepared from one or both fillets from a fish. A composite homogenate should be prepared only from individual homogenates of the same type (i.e., **either** from individual homogenates each prepared from a single fillet **or** from individual homogenates each prepared from both fillets).

reanalysis if the QC control limits are not met or if the sample is lost. However, sample size requirements may vary among laboratories and the analytical methods used. Each program manager must consult with the analytical laboratory supervisor to determine the actual weights of composite homogenates required to analyze for all selected target analytes at appropriate detection limits.

7.2.3 Processing Turtle Samples

Processing in the laboratory to prepare individual turtle homogenate samples for analysis (diagrammed in Figure 7-4) involves

- Inspecting individual turtles
- Weighing individual turtles
- Removing edible tissues
- Determining the sex of each turtle (optional)
- Determining the age of each turtle (optional)
- Weighing edible tissue or tissues
- Homogenizing tissues
- Preparing individual homogenate samples
- Preparing aliquots of the individual homogenates for analysis
- Distributing frozen aliquots to one or more analytical laboratories.

7. LABORATORY PROCEDURES I — SAMPLE HANDLING

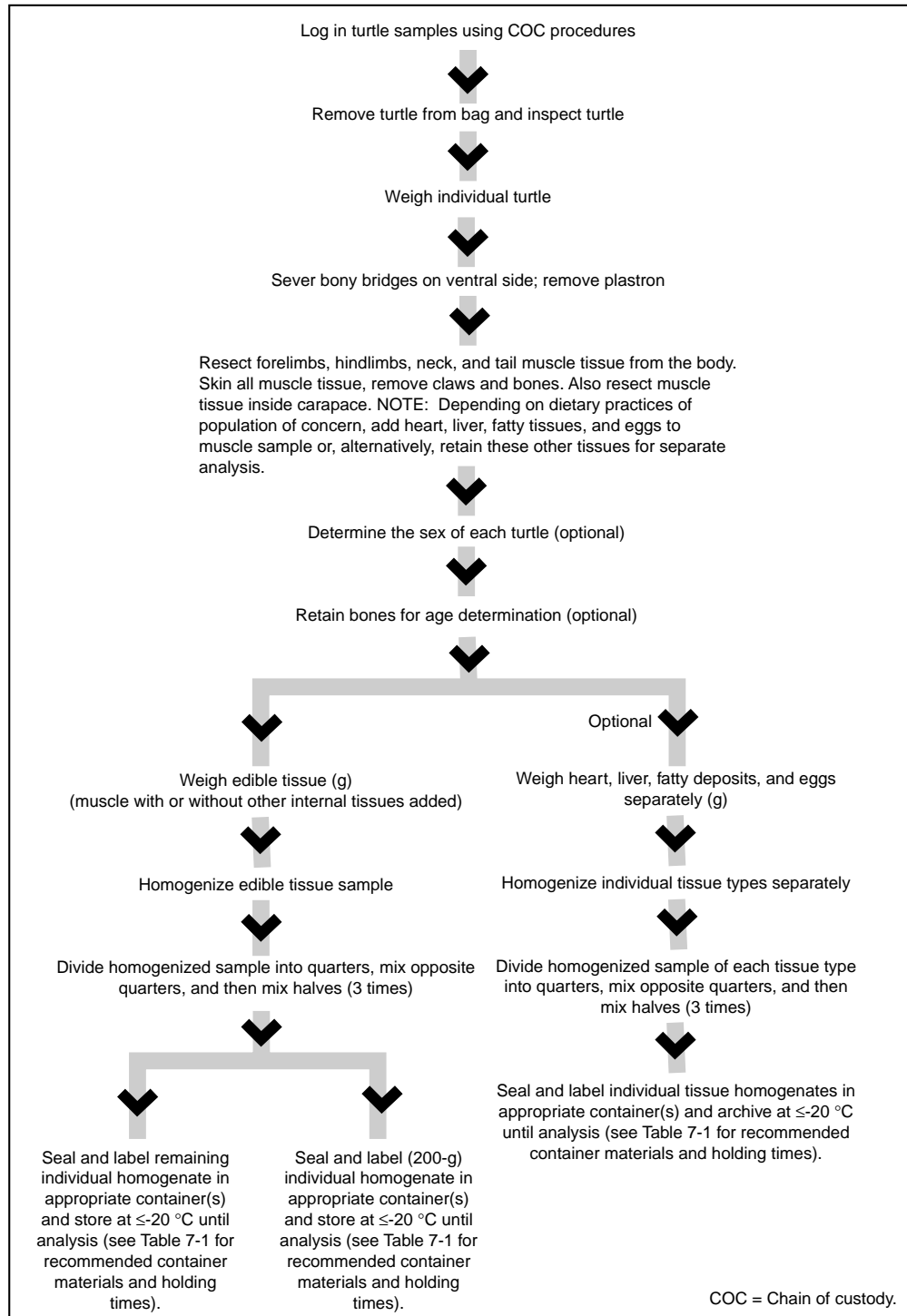

Figure 7-4. Preparation of individual turtle homogenate samples.

Whole turtles should be shipped or brought to the sample processing laboratory from the field on wet or blue ice within 24 hours of sample collection. The recommended euthanizing method for turtles is freezing (Frye, 1994) and a minimum of 48 hours or more may be required for large specimens. Turtles that arrive on wet or blue ice or frozen (i.e., on dry ice) at the sample processing laboratory should be placed in a ≤ -20 °C freezer for storage until resection can be performed. If rupture of internal organs is noted for an individual turtle, the specimen may be eliminated as a sample or, alternatively, the edible tissues should be rinsed in distilled deionized water and blotted dry.

Sample processing procedures are discussed in the following sections. Data from each procedure should be recorded directly in a bound laboratory notebook or on forms that can be secured in the laboratory notebook. A sample processing record for individual turtle samples is shown in Figure 7-5.

7.2.3.1 Sample Inspection—

Turtles received for resection should be removed from the canvas or burlap collection bags and inspected carefully to ensure that they have not been compromised in any way (i.e., not properly preserved during shipment). Any specimen deemed unsuitable for further processing and analysis should be discarded and identified on the sample processing record.

7.2.3.2 Sample Weighing—

A wet weight should be determined for each turtle. All samples should be weighed on balances that are properly calibrated and of adequate accuracy and precision to meet program data quality objectives. Balance calibration should be checked at the beginning and end of each weighing session and after every 20 weighings in a weighing session.

Turtles euthanized by freezing should be weighed in clean, tared, noncontaminating containers if they will thaw before the weighing can be completed. **Note:** Liquid from the thawed whole turtle sample will come not only from the muscle tissue but from the gut and body cavity, which may not be part of the desired edible tissue sample. Consequently, inclusion of this liquid with the sample may result in an overestimate of target analyte and lipid concentrations in the edible tissue homogenate. Nevertheless, it is recommended, as a conservative approach, that all liquid from the thawed whole turtle be kept in the container as part of the sample.

All weights should be recorded to the nearest gram on the sample processing record and/or in the laboratory notebook.

Sample Processing Record for Turtle Contaminant Monitoring Program — Individual Samples

Project Number: _____ Sampling Date and Time: _____

STUDY PHASE: Screening Study ; Intensive Study: Phase I Phase II

SITE LOCATION

Site Name/Number: _____

County/Parish: _____ Lat./Long.: _____

Waterbody Name/Segment Number: _____ Waterbody Type: _____

Sample Type (bottom feeder, predator, etc.) _____ Species Name: _____

Composite Sample #: _____ Replicate Number: _____ Number of Individuals: _____

Turtle #	Weight (g)	Carapace Length (mm)	Sex (M,F)	Resection Performed (✓)	Tissue Type Used	Tissue Weight (g)	Homogenate Prepared (✓)
001	_____	_____	_____	_____	_____	_____	_____
002	_____	_____	_____	_____	_____	_____	_____
003	_____	_____	_____	_____	_____	_____	_____
004	_____	_____	_____	_____	_____	_____	_____
005	_____	_____	_____	_____	_____	_____	_____
006	_____	_____	_____	_____	_____	_____	_____
007	_____	_____	_____	_____	_____	_____	_____
008	_____	_____	_____	_____	_____	_____	_____
009	_____	_____	_____	_____	_____	_____	_____
010	_____	_____	_____	_____	_____	_____	_____
Analyst	_____	_____	_____	_____	_____	_____	_____
Date	_____	_____	_____	_____	_____	_____	_____
Total Composite Weight (g)						_____	

Notes: Define tissues used in edible sample; indicate whether fatty tissues, liver, heart, eggs, or other tissues are being analyzed individually or with muscle tissue as part of the edible sample.

Figure 7-5. Sample processing record for a contaminant monitoring program—individual turtle samples.

7.2.3.3 Removal of Edible Tissues—

Edible portions of a turtle should consist only of those tissues that the population of concern might reasonably be expected to eat. Edible tissues should be clearly defined in site-specific sample processing protocols. A brief description of the edible portions used should also be provided on the sample processing record. General procedures for removing edible tissues from a turtle are illustrated in Appendix K.

Resection should be conducted only by or under the supervision of an experienced fisheries biologist. If gloves are worn, they should be talc- or dust-free and of noncontaminating materials. Prior to resection, hands should be washed with soap and rinsed thoroughly in tap water, followed by distilled water (U.S. EPA, 1991d). Specimens should come into contact with noncontaminating surfaces only. Turtles should be resected on glass or PTFE cutting boards that are cleaned properly between each turtle or on cutting boards covered with heavy duty aluminum foil that is changed between each turtle (Puget Sound Estuary Program, 1990d, 1990e). A turtle is resected by laying it flat on its back and removing the plastron by severing the two bony ridges between the forelimbs and hindlimbs. Care must be taken to avoid contaminating edible tissues with material released from the inadvertent puncture of internal organs.

Ideally, turtles should be resected while ice crystals are still present in the muscle tissue. Thawing of frozen turtles should be kept to a minimum during tissue removal to avoid loss of liquids. A turtle should be thawed only to the point where it becomes possible to make an incision into the flesh (U.S. EPA, 1991d).

Clean, high-quality stainless steel, ceramic, or titanium utensils should be used to remove the muscle tissue and, depending on dietary or culinary practices of the population of concern, some of the other edible tissues from each turtle. The general procedure recommended for resecting turtles is illustrated in Figure 7-6.

Skin on the forelimbs, hindlimbs, neck, and tail should be removed. Claws should be removed from the forelimbs and hindlimbs. Bones still present in the muscle tissue after resection should be removed carefully (U.S. EPA, 1991d) and may be used in age determination (see Section 7.2.3.5).

To control contamination, separate sets of utensils and cutting boards should be used for skinning muscle tissue and resecting other internal tissues from the turtle (e.g., heart, liver, fatty deposits, and eggs). These other tissue types are recommended for inclusion with the muscle tissue as part of the edible tissue sample because it is believed that they are most representative of the edible portions of turtles that are prepared and consumed by sport anglers and subsistence fishers. Alternatively, states may choose to analyze some of these other lipophilic tissues separately. It is the responsibility of each program manager, in consultation with state fisheries experts, to select the tissue sample

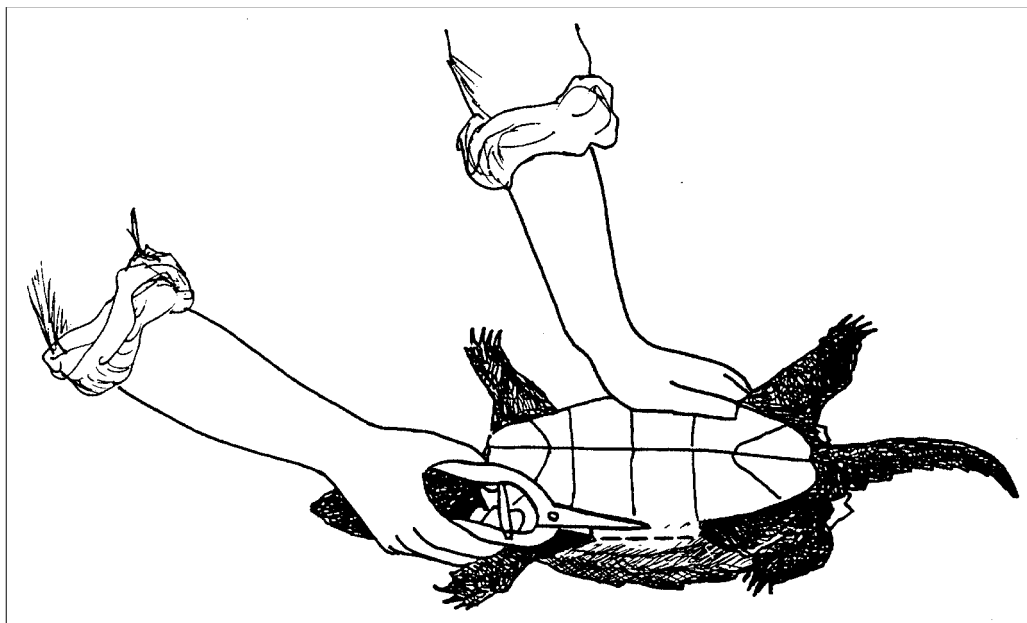

Figure 7-6. Illustration of basic turtle resection procedure.

type most appropriate for each target species based on the dietary customs of local populations of concern.

The edible turtle tissues should be weighed and the weight recorded to the nearest gram on the sample processing record. If the state elects to analyze the heart, liver, fatty deposits, or eggs separately from the muscle tissue, these other tissues should be weighed separately and the weights recorded to the nearest gram in the sample processing record.

If the tissues are to be homogenized immediately, they should be placed in a properly cleaned glass or PTFE homogenization container. If samples are to be analyzed for metals only, plastic homogenization containers may be used. To facilitate homogenization, it may be necessary or desirable to chop each of the large pieces of muscle tissue into smaller pieces using a titanium or stainless steel knife prior to placement in the homogenization container.

If the tissues are to be homogenized later, they should be wrapped in heavy duty aluminum foil and labeled with the sample identification number, the sample type (e.g., "M" for muscle, "E" for eggs, or "FD" for fatty deposits), the weight (g), and the date of resection. The individual muscle tissue samples from each turtle should be packaged together and given an individual sample identification number. The date of resection should be recorded and the sample should be stored at $\leq -20^{\circ}\text{C}$ until homogenization. **Note:** State staff may determine that the most appropriate sample type is muscle tissue only, with internal organ tissues analyzed separately (liver, heart, fatty deposits, or eggs). Alternatively, state staff may determine that the most appropriate sample type is muscle tissue with several other internal organs included as the turtle tissue sample. This latter

sample type typically will provide a more conservative estimate of contaminant residues, particularly with respect to lipophilic target analytes (e.g., PCBs, dioxins, and organochlorine pesticides).

7.2.3.4 Sex Determination (Optional)—

Turtle sex should be determined during resection if it has not already been determined in the field. Once the plastron is removed, the ovaries or testes can be observed posterior and dorsal to the liver. Each ovary is a large egg-filled sac containing yellow spherical eggs in various stages of development (Ashley, 1962) (see Appendix K). Each testes is a spherical organ, yellowish in color, attached to the ventral side of each kidney. The sex of each turtle should be verified and recorded on the sample processing form.

7.2.3.5 Age Determination (Optional)—

Age provides a good indication of the duration of exposure to pollutants (Versar, 1982). Several methods have been developed for estimating the age of turtles (Castanet, 1994; Frazer et al., 1993; Gibbons, 1976). Two methods are appropriate for use in contaminant monitoring programs where small numbers of animals of a particular species are to be collected and where the animals must be sacrificed for tissue residue analysis. These methods include (1) the use of external annuli (scute growth marks) on the plastron and (2) the use of growth rings on the bones.

The surface of epidermal keratinous scutes on the plastron of turtle shells develops successive persistent grooves or growth lines during periods of slow or arrested growth (Zangerl, 1969). Because these growth rings are fairly obvious, they have been used extensively for estimating age in various turtle species (Cagle, 1946, 1948, 1950; Gibbons, 1968; Legler, 1960; Sexton, 1959). This technique is particularly useful for younger turtles where the major growth rings are more definitive and clear cut than in older individuals (Gibbons, 1976). However, a useful extension of the external annuli method is presented by Sexton (1959) showing that age estimates can be made for adults on which all annuli are not visible. This method involves visually examining the plastron of the turtle during the resection or tagging the plastron with the sample identification number of the turtle and retaining it for later analysis.

The use of bone rings is the second method that may be used to estimate age in turtles (Enlow and Brown, 1969; Peabody, 1961). Unlike the previous visual method, this method requires that the bones of the turtle be removed during resection and retained for later analysis. The growth rings appear at the surface or inside primary compacta of bone tissues. There are two primary methods for observing growth marks: either directly at the surface of the bone as in flat bones using transmitted or reflected light or inside the long bones using thin sections (Castanet, 1994; Dobie, 1971; Galbraith and Brooks, 1987; Hammer, 1969; Gibbons, 1976; Mattox, 1935; Peabody, 1961). The methods of preparation of

whole bones and histological sections of fresh material for growth mark determinations are now routinely performed. Details of these methods can be found in Castanet (1974 and 1987), Castanet et al. (1993), and Zug et al. (1986). State staff interested in using either of these methods for age determination of turtles should read the review articles by Castanet (1994) and Gibbons (1976) for discussions of the advantages and disadvantages of each method, and the associated literature cited in these articles on turtle species of particular interest within their jurisdictions.

7.2.3.6 Preparation of Individual Homogenates—

To ensure even distribution of contaminants throughout tissue samples and to facilitate extraction and digestion of samples, the edible tissues from individual turtles must be ground and homogenized prior to analysis. The various tissues from an individual turtle may be ground and homogenized separately, or combined, depending on the sampling program's definition of edible tissues.

Turtle tissues should be ground and homogenized using an automatic grinder or high-speed blender or homogenizer. Large pieces of muscle or organ tissue (e.g., liver or fatty deposits) may be cut into 2.5-cm cubes with high-quality stainless steel or titanium knives or with a food service band saw prior to homogenization. Parts of the blender or homogenizer used to grind the tissue (i.e., blades, probes) should be made of tantalum or titanium rather than stainless steel. Stainless steel blades and/or probes have been found to be a potential source of nickel and chromium contamination (due to abrasion at high speeds) and should be avoided.

Grinding and homogenization of tissue is easier when it is partially frozen (Stober, 1991). Chilling the grinder/blender briefly with a few chips of dry ice will also help keep the tissue from sticking to it (Smith, 1985).

The tissue sample should be ground until it appears to be homogeneous. The ground sample should then be divided into quarters, opposite quarters mixed together by hand, and the two halves mixed together. The grinding, quartering, and hand-mixing steps should be repeated at least two more times. If chunks of tissue are present at this point, the grinding and homogenization should be repeated. No chunks of tissue should remain because these may not be extracted or digested efficiently and could bias the analytical results. This is particularly true when lipophilic tissues (e.g., fatty deposits, liver, or eggs) are not completely homogenized throughout the sample. Portions of the tissue sample that retain unhomogenized portions of tissues may exhibit higher or lower residues of target analytes than properly homogenized samples.

If the sample is to be analyzed for metals only, the ground tissue may be mixed by hand in a polyethylene bag (Stober, 1991). The preparation of each individual homogenate should be noted (marked with a check) on the sample processing record. At this time, individual homogenates may be frozen separately and stored at ≤ -20 °C (see Table 7-1).

The remainder of each individual homogenate should be archived at ≤ -20 °C with the designation "Archive" and the expiration date recorded on the sample label. The location of the archived samples should be indicated on the sample processing record under "Notes."

It is essential that the weight of individual homogenate samples is of adequate size to perform all necessary analyses. The recommended sample size of 200 g for screening studies is intended to provide sufficient sample material to (1) analyze for all recommended target analytes (see Table 4-1) at appropriate detection limits; (2) meet minimum QC requirements for the analyses of laboratory duplicate, matrix spike, and matrix spike duplicate samples (see Sections 8.3.3.4 and 8.3.3.5); and (3) allow for reanalysis if the QC control limits are not met or if the sample is lost. However, sample size requirements may vary among laboratories and the analytical methods used. Each program manager must consult with the analytical laboratory supervisor to determine the actual weights of homogenates required to analyze for all selected target analytes at appropriate detection limits. The total sample weight required for intensive studies may be less than that for screening studies if the number of target analytes is reduced significantly.

7.2.4 Processing Shellfish Samples

Laboratory processing of shellfish to prepare edible tissue composite homogenates for analysis (diagrammed in Figure 7-7) involves

- Inspecting individual shellfish
- Determining the sex of each shellfish (optional)
- Examining each shellfish for morphological abnormalities (optional)
- Removing the edible parts from each shellfish in the composite sample (3 to 50 individuals, depending upon the species)
- Combining the edible parts in an appropriate noncontaminating container
- Weighing the composite sample
- Homogenizing the composite sample
- Preparing aliquots of the composite homogenate for analysis
- Distributing frozen aliquots to one or more analytical laboratories.

Sample aliquotting and shipping are discussed in Section 7.3; all other processing steps are discussed in this section. Shellfish samples should be processed following the general guidelines in Section 7.2.1 to avoid contamination. In

7. LABORATORY PROCEDURES I — SAMPLE HANDLING

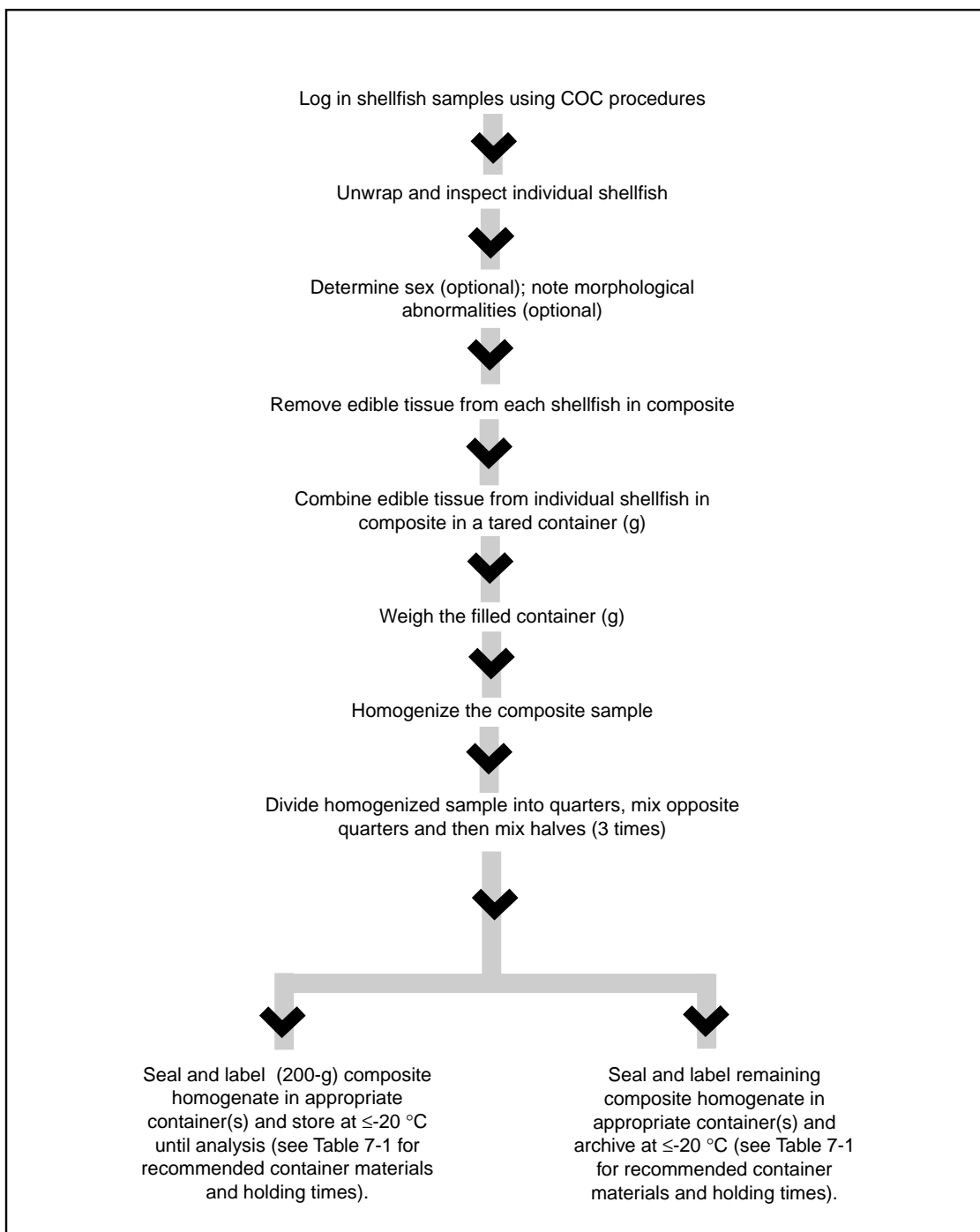

COC = Chain of custody.

Figure 7-7. Preparation of shellfish edible tissue composite homogenate samples.

particular, it is recommended that separate composite homogenates be prepared for the analysis of metals and organics if resources allow. A sample processing record for shellfish edible tissue composite samples is shown in Figure 7-8.

Shellfish samples should be shipped or brought to the sample processing laboratory either on wet or blue ice (if next-day delivery is assured) or on dry ice (see Section 6.3.3). Shellfish samples arriving on wet ice or blue ice should have edible tissue removed and should be frozen to $\leq -20^{\circ}\text{C}$ within 48 hours after collection. Shellfish samples that arrive frozen (i.e., on dry ice) at the processing laboratory should be placed in a $\leq -20^{\circ}\text{C}$ freezer for storage until edible tissue is removed.

7.2.4.1 Sample Inspection—

Individual shellfish should be unwrapped and inspected carefully to ensure that they have not been compromised in any way (i.e., not properly preserved during shipment). Any specimen deemed unsuitable for further processing and analysis should be discarded and identified on the sample processing record.

7.2.4.2 Sex Determination (Optional)—

The determination of sex in shellfish species is impractical if large numbers of individuals of the target species are required for each composite sample.

For bivalves, determination of sex is a time-consuming procedure that must be performed after shucking but prior to removal of the edible tissues. Once the bivalve is shucked, a small amount of gonadal material can be removed using a Pasteur pipette. The gonadal tissue must then be examined under a microscope to identify egg or sperm cells.

For crustaceans, sex also should be determined before removal of the edible tissues. For many species, sex determination can be accomplished by visual inspection. Sexual dimorphism is particularly striking in many species of decapods. In the blue crab, *Callinectes sapidus*, the female has a broad abdomen suited for retaining the maturing egg mass or sponge, while the abdomen of the male is greatly reduced in width. For shrimp, lobsters, and crayfish, sexual variations in the structure of one or more pair of pleopods are common. States interested in determining the sex of shellfish should consult taxonomic keys for specific information on each target species.

7.2.4.3 Assessment of Morphological Abnormalities (Optional)—

Assessment of gross morphological abnormalities in shellfish is optional. This assessment may be conducted in the field (see Section 6.3.1.5) or during initial inspection at the processing laboratory prior to removal of the edible tissues. States interested in documenting morphological abnormalities should consult Sinderman and Rosenfield (1967), Rosen (1970), and Murchelano (1982) for

7. LABORATORY PROCEDURES I — SAMPLE HANDLING

Sample Processing Record for Shellfish Contaminant Monitoring Program — Edible Tissue Composites

Project Number: _____ Sampling Date and Time: _____

STUDY PHASE: Screening Study ; Intensive Study: Phase I Phase II

SITE LOCATION
 Site Name/Number: _____
 County/Parish: _____ Lat./Long.: _____
 Waterbody Name/Segment Number: _____ Waterbody Type: _____

SHELLFISH COLLECTED
 Species Name: _____
 Description of Edible Tissue _____
 Composite Sample #: _____ Number of Individuals: _____

Shellfish #	Included in Composite (✓)	Shellfish #	Included in Composite (✓)	Shellfish #	Included in Composite (✓)
001	_____	018	_____	035	_____
002	_____	019	_____	036	_____
003	_____	020	_____	037	_____
004	_____	021	_____	038	_____
005	_____	022	_____	039	_____
006	_____	023	_____	040	_____
007	_____	024	_____	041	_____
008	_____	025	_____	042	_____
009	_____	026	_____	043	_____
010	_____	027	_____	044	_____
011	_____	028	_____	045	_____
012	_____	029	_____	046	_____
013	_____	030	_____	047	_____
014	_____	031	_____	048	_____
015	_____	032	_____	049	_____
016	_____	033	_____	050	_____
017	_____	034	_____		

Preparation of Composite:
 Weight of container + shellfish _____ g
 Weight of container (tare weight) _____ g
 Total weight of composite _____ g + _____ = _____
of specimens Average weight of specimen

Notes: _____

Analyst _____ Date _____

Figure 7-8. Sample processing record for shellfish contaminant monitoring program—edible tissue composites.

detailed information on various pathological conditions in shellfish and review recommended protocols for pathology studies used in the Puget Sound Estuary Program (1990c).

7.2.4.4 Removal of Edible Tissue—

Edible portions of shellfish should consist only of those tissues that the population of concern might reasonably be expected to eat. Edible tissues should be clearly defined in site-specific sample processing protocols. A brief description of the edible portions used should also be provided on the sample processing record. General procedures for removing edible tissues from a variety of shellfish are illustrated in Appendix L.

Thawing of frozen shellfish samples should be kept to a minimum during tissue removal to avoid loss of liquids. Shellfish should be rinsed well with organics- and metal-free water prior to tissue removal to remove any loose external debris.

Bivalve molluscs (oysters, clams, mussels, and scallops) typically are prepared by severing the adductor muscle, prying open the shell, and removing the soft tissue. The soft tissue includes viscera, meat, and body fluids (Smith, 1985). Byssal threads from mussels should be removed with a knife before shucking and should not be included in the composite sample.

Edible tissue for **crabs** typically includes all leg and claw meat, back shell meat, and body cavity meat. Internal organs generally are removed. Inclusion of the hepatopancreas should be determined by the eating habits of the local population or subpopulations of concern. If the crab is soft-shelled, the entire crab should be used in the sample. Hard- and soft-shelled crabs must not be combined in the same composite (Smith, 1985).

Typically, **shrimp** and **crayfish** are prepared by removing the cephalothorax and then removing the tail meat from the shell. Only the tail meat with the section of intestine passing through the tail muscle is retained for analysis (Smith, 1985). Edible tissue for **lobsters** typically includes the tail and claw meat. If the tomalley (hepatopancreas) and gonads or ovaries are consumed by local populations of concern, these parts should also be removed and analyzed separately (Duston et al., 1990).

7.2.4.5 Sample Weighing—

Edible tissue from all shellfish in a composite sample (3 to 50 individuals) should be placed in an appropriate preweighed and labeled noncontaminating container. The weight of the empty container (tare weight) should be recorded to the nearest gram on the sample processing record. All fluids accumulated during removal of edible tissue should be retained as part of the sample. As the edible portion of each shellfish is placed in the container, it should be noted on the sample processing record. When the edible tissue has been removed from all shellfish

in the composite, the container should be reweighed and the weight recorded to the nearest gram on the sample processing record. The total composite weight should be approximately 200 g for screening studies. If the number of target analytes is significantly reduced in intensive studies, a smaller composite homogenate sample may suffice (see Section 7.2.2.9). At this point, the composite sample may be processed for analysis or frozen and stored at $\leq -20^{\circ}\text{C}$ (see Table 7-1).

7.2.4.6 Preparation of Composite Homogenates—

Composite samples of the edible portions of shellfish should be homogenized in a grinder, blender, or homogenizer that has been cooled briefly with dry ice (Smith, 1985). For metals analysis, tissue may be homogenized in 4-oz polyethylene jars (California Department of Fish and Game, 1990) using a Polytron equipped with a titanium generator. If the tissue is to be analyzed for organics only, or if chromium and nickel contamination are not of concern, a commercial food processor with stainless steel blades and glass container may be used. The composite should be homogenized to a paste-like consistency. Larger samples may be cut into 2.5-cm cubes with high-quality stainless steel or titanium knives before grinding. If samples were frozen after dissection, they can be cut without thawing with either a knife-and-mallet or a clean bandsaw. The ground samples should be divided into quarters, opposite quarters mixed together by hand, and the two halves mixed together. The quartering and mixing should be repeated at least two more times until a homogeneous sample is obtained. No chunks should remain in the sample because these may not be extracted or digested efficiently. At this point, the composite homogenates may be processed for analysis or frozen and stored at $\leq -20^{\circ}\text{C}$ (see Table 7-1).

7.3 SAMPLE DISTRIBUTION

The sample processing laboratory should prepare aliquots of the composite homogenates for analysis, distribute the aliquots to the appropriate laboratory (or laboratories), and archive the remainder of each composite homogenate.

7.3.1 Preparing Sample Aliquots

Note: Because lipid material tends to migrate during freezing, frozen composite homogenates must be thawed and rehomogenized before aliquots are prepared (U.S. EPA, 1991d). Samples may be thawed overnight in an insulated cooler or refrigerator and then homogenized. Recommended aliquot weights and appropriate containers for different types of analyses are shown in Table 7-3. The actual sample size required will depend on the analytical method used and the laboratory performing the analysis. Therefore, the exact sample size required for each type of analysis should be determined in consultation with the analytical laboratory supervisor.

Table 7-3. Recommended Sample Aliquot Weights and Containers for Various Analyses

Analysis	Aliquot weight (g)	Shipping/storage container
Metals	1-5	Polystyrene, borosilicate glass, or PTFE jar with PTFE-lined lid
Organics	20-50	Glass or PTFE jar with PTFE-lined lid
Dioxins/furans	20-50	Glass or PTFE jar with PTFE-lined lid

PTFE = Polytetrafluoroethylene (Teflon).

The exact quantity of tissue required for each digestion or extraction and analysis should be weighed and placed in an appropriate container that has been labeled with the aliquot identification number, sample weight (to the nearest 0.1 g), and the date aliquots were prepared (Stober, 1991). The analytical laboratory can then recover the entire sample, including any liquid from thawing, by rinsing the container directly into the digestion or extraction vessel with the appropriate solvent. It is also the responsibility of the processing laboratory to provide a sufficient number of aliquots for laboratory duplicates, matrix spikes, and matrix spike duplicates so that the QC requirements of the program can be met (see Sections 8.3.3.4 and 8.3.3.5), and to provide extra aliquots to allow for reanalysis if the sample is lost or if QC control limits are not met.

It is essential that accurate records be maintained when aliquots are prepared for analysis. Use of a carefully designed form is recommended to ensure that all the necessary information is recorded. An example of a sample aliquot record is shown in Figure 7-9. The composite sample identification number should be assigned to the composite sample at the time of collection (see Section 6.2.3.1) and carried through sample processing (plus "F1," "F2," or "C" if the composite homogenate is comprised of individual or combined fillets). The aliquot identification number should indicate the analyte class (e.g., MT for metals, OR for organics, DX for dioxins) and the sample type (e.g., R for routine sample; RS or a routine sample that is split for analysis by a second laboratory; MS1 and MS2 for sample pairs, one of which will be prepared as a matrix spike). For example, the aliquot identification number may be WWWW-XX-YY-ZZZ, where WWWW is a 5-digit sample composite identification number, XX indicates individual (F1 or F2) or combined (C) fillets, YY is the analyte code, and ZZZ is the sample type.

Blind laboratory duplicates should be introduced by preparing two separate aliquots of the same composite homogenate and labeling one aliquot with a "dummy" composite sample identification. However, the analyst who prepares the laboratory duplicates must be careful to assign a "dummy" identification number that has not been used for an actual sample and to indicate clearly on the

Fish and Shellfish Monitoring Program Sample Aliquot Record						
Aliquot prepared by _____		(name)		Date _____	Time _____	
Comments _____						
Samples from:						
Project No. _____		Site # _____		<input type="checkbox"/> Screening study	Intensive study	<input type="checkbox"/> Phase I <input type="checkbox"/> Phase II
Composite Sample ID	Analyte Code __ __		Analyte Code __ __		Analyte Code __ __	
	Aliquot ID	Aliquot Weight (g)	Aliquot ID	Aliquot Weight (g)	Aliquot ID	Aliquot Weight (g)
Archive Location:	Analyze for: _____		Analyze for: _____		Analyze for: _____	
	Ship to: _____		Ship to: _____		Ship to: _____	

Figure 7-9. Example of a fish and shellfish monitoring program sample aliquot record.

7-31

7. LABORATORY PROCEDURES I — SAMPLE HANDLING

processing records that the samples are blind laboratory duplicates. The analytical laboratory should not receive this information.

When the appropriate number of aliquots of a composite sample have been prepared for all analyses to be performed on that sample, the remainder of the composite sample should be labeled with "ARCHIVE" and the expiration date and placed in a secure location at ≤ -20 °C in the sample processing laboratory. The location of the archived samples should be indicated on the sample aliquot record. Unless analyses are to be performed immediately by the sample processing laboratory, aliquots for sample analysis should be frozen at ≤ -20 °C before they are transferred or shipped to the appropriate analytical laboratory.

7.3.2 Sample Transfer

The frozen aliquots should be transferred on dry ice to the analytical laboratory (or laboratories) accompanied by a sample transfer record such as the one shown in Figure 7-10. Further details on federal regulations for shipping biological specimens in dry ice are given in Section 6.3.3.2. The sample transfer record may include a section that serves as the analytical laboratory COC record. The COC record must be signed each time the samples change hands for preparation and analysis.

SECTION 8

LABORATORY PROCEDURES II — SAMPLE ANALYSES

Sample analyses may be conducted by one or more state or private contract laboratories. Because of the toxicity of dioxins/furans and the difficulty and cost of these analyses, relatively few laboratories currently have the capability of performing them. Table 8-1 lists contract laboratories experienced in dioxin/furan analyses. This list is provided for information purposes only and is not an endorsement of specific laboratories.

8.1 RECOMMENDED ANALYTES

8.1.1 Target Analytes

All recommended target analytes listed in Table 4-1 should be included in screening studies unless reliable historic tissue, sediment, or pollutant source data indicate that an analyte is not present at a level of concern for human health. Additional target analytes should be included in screening studies if states have site-specific information (e.g., historic tissue or sediment data, discharge monitoring reports from municipal and industrial sources) that these contaminants may be present at levels of concern for human health.

Intensive studies should include only those target analytes found to exceed screening values in screening studies (see Section 5.2).

8.1.2 Lipid

A lipid analysis should also be performed and reported (as percent lipid by wet weight) for each composite tissue sample in both screening and intensive studies. This measurement is necessary to ensure that gel permeation chromatography columns are not overloaded when used to clean up tissue extracts prior to analysis of organic target analytes. In addition, because bioconcentration of nonpolar organic compounds is dependent upon lipid content (i.e., the higher the lipid content of the individual organism, the higher the residue in the organism), lipid analysis is often considered essential by users of fish and shellfish monitoring data. Consequently, it is important that lipid data are obtained for eventual inclusion in a national database of fish and shellfish contaminant data.

8. LABORATORY PROCEDURES II — SAMPLE ANALYSES

Table 8-1. Contract Laboratories Conducting Dioxin/Furan Analyses In Fish and Shellfish Tissues^a

Alta Analytical Laboratory ^b 5070 Robert J. Matthews Parkway, Suite 2 Eldorado Hills, CA 95762 916/933-1640 FAX: 916/933-0940 Bill Luksemburg	Pace Analytical Services ^b 7726 Moller Road Indianapolis, IN 46268 317/875-5894 FAX: 317/872-6189 Mick Mayse
Battelle-Columbus Laboratories ^b 505 King Avenue Columbus, OH 43201 614/424-7379 Karen Riggs	Triangle Laboratories ^b Alston Technical Park 801 Capitola Drive Durham, NC 27713 919/544-5729 FAX: 919/544-5491 Phil Albro
Midwest Research Institute ^b 425 Volker Boulevard Kansas City, MO 64110 816/753-7600, ext. 1160/1557 FAX: 816/753-8240 John Stanley/Tom Sack e-mail: JStanley@mriresearch.org tsack@mriresearch.org	Wellington Environmental Consultants ^b 398 Laird Road Guelph, Ontario N1G 3X7 Canada 519/822-2436 Judy Sparling/Brock Chittin/Colleen Tashiro
New York State Department of Health ^b Wadsworth Center Empire State Plaza P.O. Box 509 Albany, NY 12201-0509 518/473-3378 FAX: 518/473-2895 Patrick O'Keefe	Wright State University ^b 175 Brehm Laboratory 3640 Colonel Glen Highway Dayton, OH 45435 937/775-2202 FAX: 937/775-3122 Thomas Tiernan/Garrett Van Ness
Pacific Analytical, Inc. ^b 6349 Paseo Del Argo Carlsbad, CA 92009 760/438-3100 FAX: 760/931-9479 Bruce Colby	Quanterra Environmental Services Knoxville Laboratory 5815 Middlebrook Pike Knoxville, TN 37921 423/588-6401 FAX: 423/584-4315 David Thal/Tom Yoder
Axys Analytical Services ^b P.O. Box 2219 2045 Mills Road Sidney, BC V8L 3 Canada 250/656-0881; Toll Free 1-888-373-0881 Coreen Hamilton/Dale Hover/Laurie Phillips	

^a This list should not be construed as an endorsement by EPA of these laboratories, but is provided for information purposes only.

^b Laboratory participating in Method 1613 interlaboratory (round-robin) dioxin study (May 1991).

Note: Because the concentrations of contaminants, particularly nonpolar organics, are often correlated with the percentage of lipid in a tissue sample, contaminant data are often normalized to the lipid concentration before statistical analyses are performed. This procedure can, in some instances, improve the power of the statistical tests. States wishing to examine the relationship between contaminant concentrations and percentage of lipid should refer to Hebert and Keenleyside (1995) for a discussion of the possible statistical approaches.

8.2 ANALYTICAL METHODS

This section provides guidance on selecting methods for analysis of recommended target analytes. Analytical methods should include appropriate procedures for sample preparation (i.e., for digestion of samples to be analyzed for metals and for extraction and extract cleanup of samples to be analyzed for organics).

8.2.1 Lipid Method

It is recommended that a gravimetric method be used for lipid analysis. This method is easy to perform and is commonly used by numerous laboratories, employing various solvent systems such as chloroform/methanol (Bligh and Dyer, 1959), petroleum ether (California Department of Fish and Game, 1990; U.S. FDA, 1990), and dichloromethane (NOAA, 1993a; Schmidt et al., 1985). The results of lipid analyses may vary significantly (i.e., by factors of 2 or 3), however, depending on the solvent system used for lipid extraction (Randall et al., 1991; D. Swackhamer, University of Minnesota, personal communication, 1993; D. Murphy, Maryland Department of the Environment, Water Quality Toxics Division, personal communication, 1993). Therefore, to ensure consistency of reported results among fish contaminant monitoring programs, it is recommended that dichloromethane be used as the extraction solvent in all lipid analyses.

In addition to the effect of solvent systems on lipid analysis, other factors can also increase the inter- and intralaboratory variation of results if not adequately controlled (Randall et al., 1991). For example, high temperatures have been found to result in decomposition of lipid material and, therefore, should be avoided during extraction. Underestimation of total lipids can also result from denaturing of lipids by solvent contaminants, lipid decomposition from exposure to oxygen or light, and lipid degradation from changes in pH during cleanup. Overestimation of total lipids may occur if a solvent such as alcohol is used, which results in substantial coextraction of nonlipid material. It is essential that these potential sources of error be considered when conducting and evaluating results of lipid analyses.

8.2.2 Target Analyte Methods

EPA has published interim procedures for sampling and analysis of priority pollutants in fish tissue (U.S. EPA, 1981); however, official EPA-approved methods are available only for the analysis of low parts-per-billion concentrations of some metals in fish and shellfish tissues (U.S. EPA, 1991g). Because of the lack of official EPA-approved methods for all recommended target analytes, and to allow states and Regions flexibility in developing their analytical programs, specific analytical methods for recommended target analytes in fish and shellfish monitoring programs are not included in this guidance document.

Note: A performance-based analytical program is recommended for the analysis of target analytes. This recommendation is based on the assumption that the analytical results produced by different laboratories and/or different methods will be comparable if appropriate QC procedures are implemented within each laboratory and if comparable analytical performance on round-robin comparative analyses of standard reference materials or split sample analyses of field samples can be demonstrated. This approach is intended to allow states to use cost-effective procedures and to encourage the use of new or improved analytical methods without compromising data quality. Performance-based analytical programs currently are used in several fish and shellfish monitoring programs, including the NOAA Status and Trends Program (Battelle, 1989b; Cantillo, 1991; NOAA, 1987), the EPA Environmental Monitoring and Assessment Program (EMAP) (U.S. EPA, 1991e), and the Puget Sound Estuary Program (1990d, 1990e).

Analytical methods used in fish and shellfish contaminant monitoring programs should be selected using the following criteria:

- Technical merit—Methods should be technically sound; they should be specific for the target analytes of concern and based on current, validated analytical techniques that are widely accepted by the scientific community.
- Sensitivity—Method detection and quantitation limits should be sufficiently low to allow reliable quantitation of the target analytes of concern at or below selected screening values. Ideally, the method detection limit (in tissue) should be at least five times lower than the selected SV for a given target analyte (Puget Sound Estuary Program, 1990e).
- Data quality—The accuracy and precision should be adequate to ensure that analytical data are of acceptable quality for program objectives.
- Cost-efficiency—Resource requirements should not be unreasonably high.

A review of current EPA guidance for chemical contaminant monitoring programs and of analytical methods currently used or recommended in several of these programs (as shown in Table 8-2) indicates that a limited number of analytical

Table 8-2. Current References for Analytical Methods for Contaminants in Fish and Shellfish Tissues

-
-
- Analytical Chemistry of PCBs (Erickson, 1991)
 - Analytical Methods for Pesticides and Plant Growth Regulators, Vol. 11 (Zweig and Sherma, 1980)
 - Analytical Procedures and Quality Assurance Plan for the Determination of Mercury in Fish (U.S. EPA, 1989a)
 - Analytical Procedures and Quality Assurance Plan for the Determination of Xenobiotic Chemical Contaminants in Fish (U.S. EPA, 1989c)
 - Analytical Procedures and Quality Assurance Plan for the Determination of PCDD/PCDF in Fish (U.S. EPA, 1989b)
 - Arsenic Speciation by Coupling High-Performance Liquid Chromatography with Inductively Coupled Plasma Mass Spectrometry (Demesmay et al., 1994)
 - Assessment and Control of Bioconcentratable Contaminants in Surface Water (U.S. EPA, 1991a).
 - Bioaccumulation Monitoring Guidance: 4. Analytical Methods for U.S. EPA Priority Pollutants and 301(h) Pesticides in Tissues from Marine and Estuarine Organisms (U.S. EPA, 1986a)
 - Determination of Arsenic Species by High-Performance Liquid Chromatography - Inductively Coupled Plasma Mass Spectrometry (Beauchemin et al., 1989)
 - Determination of Arsenic Species in Fish by Directly Coupled High-Performance Liquid Chromatography-Inductively Coupled Plasma Mass Spectrometry (Branch et al., 1994)
 - The quantitation of butyltin and cyclohexyltin compounds in the marine environment of British Columbia. *Appl. Organometal. Chem.* 4:581-590 (Cullen et al., 1990)
 - Determination of Butyltin, Methyltin and Tetraalkyltin in Marine Food Products with Gas Chromatography-Atomic Absorption Spectrometry (Forsyth and Cleroux, 1991)
 - Determination of Tributyltin Contamination in Tissues by Capillary Column Gas Chromatography-Flame Photometric Detection with Confirmation by Gas Chromatography-Mass Spectroscopy (Wade et al., 1988)
 - Determination of Tributyltin in Tissues and Sediments by Graphite Furnace Atomic Absorption Spectrometry (Stephenson and Smith, 1988)
 - Environmental Monitoring and Assessment Program Near Coastal Virginian Province Quality Assurance Project Plan (Draft) (U.S. EPA, 1991e)
 - Guidelines for Studies of Contaminants in Biological Tissues for the National Water-Quality Assessment Program (Crawford and Luoma, 1993)
 - Interim Methods for the Sampling and Analysis of Priority Pollutants in Sediments and Fish Tissue (U.S. EPA, 1981)
 - Laboratory Quality Assurance Program Plan (California Department of Fish and Game, 1990)
 - Methods for Organic Analysis of Municipal and Industrial Wastewater (40 CFR 136, Appendix A).
 - Methods for the Chemical Analysis of Water and Wastes (U.S. EPA, 1979b)
 - Methods for the Determination of Metals in Environmental Samples (U.S. EPA, 1991g)
 - Official Methods of Analysis of the Association of Official Analytical Chemists (Williams, 1984)
 - Pesticide Analytical Manual (PAM Vols. I and II) (U.S. FDA, 1990)
 - Puget Sound Estuary Program Plan (1990d, 1990e)
 - Quality Assurance/Quality Control (QA/QC) for 301(h) Monitoring Programs: Guidance on Field and Laboratory Methods (U.S. EPA, 1987e)
-

(continued)

8. LABORATORY PROCEDURES II — SAMPLE ANALYSES

Table 8-2 (continued)

-
-
- Sampling and Analytical Methods of the National Status and Trends Program National Benthic Surveillance and Mussel Watch Projects 1984-92. Volume II. Comprehensive Descriptions of Complementary Measurements (NOAA, 1993a)
 - Sampling and Analytical Methods of the National Status and Trends Program National Benthic Surveillance and Mussel Watch Projects 1984-92. Volume III. Comprehensive Descriptions of Elemental Analytical Methods (NOAA, 1993b)
 - Sampling and Analytical Methods of the National Status and Trends Program National Benthic Surveillance and Mussel Watch Projects 1984-92. Volume IV. Comprehensive Descriptions of Trace Organic Analytical Methods (NOAA, 1993c)
 - Separation of Seven Arsenic Compounds by High-performance Liquid Chromatography with On-line Detection by Hydrogen-Argon Flame Atomic Absorption Spectrometry and Inductively Coupled Plasma Mass Spectrometry (Hansen et al., 1992)
 - Speciation of Selenium and Arsenic in Natural Waters and Sediments by Hydride Generation Followed by Atomic Absorption Spectroscopy (Crecelius et al., 1986)
 - Standard Analytical Procedures of the NOAA National Analytical Facility (Krahn et al., 1988; MacLeod et al., 1985)
 - Standard Methods for the Examination of Water and Wastewater (Greenburg et al., 1992)
 - Test Methods for the Chemical Analysis of Municipal and Industrial Wastewater (U.S. EPA, 1982)
 - Test Methods for the Evaluation of Solid Waste, Physical/Chemical Methods (SW-846) (U.S. EPA, 1986d)
 - U.S. EPA Contract Laboratory Program Statement of Work for Inorganic Analysis (U.S. EPA, 1991b)
 - U.S. EPA Contract Laboratory Program Statement of Work for Organic Analysis (U.S. EPA, 1991c)
 - U.S. EPA Method 1613B: Tetra- through Octa-Chlorinated Dioxins and Furans by Isotope Dilution HRGC/HRMS (U.S. EPA, 1995b)
 - U.S. EPA Method 1625: Semivolatile Organic Compounds by Isotope Dilution GC/MS (40 CFR 136, Appendix A)
 - U.S. EPA Method 1631: Mercury in Water by Oxidation, Purge and Trap, and Cold Vapor Atomic Fluorescence Spectrometry (U.S. EPA, 1995c)
 - U.S. EPA Method 1632: Determination of Inorganic Arsenic in Water by Hydride Generation Flame Atomic Absorption (U.S. EPA, 1995d)
 - U.S. EPA Method 1637: Determination of Trace Elements in Ambient Waters by Chelation Preconcentration with Graphite Furnace Atomic Absorption (U.S. EPA, 1995e)
 - U.S. EPA Method 1638: Determination of Trace Elements in Ambient Waters by Inductively Coupled Plasma-Mass Spectrometry (U.S. EPA, 1995f)
 - U.S. EPA Method 1639: Determination of Trace Elements in Ambient Waters by Stabilized Temperature Graphite Furnace Atomic Absorption (U.S. EPA, 1995g)
 - U.S. EPA Method 625: Base/Neutrals and Acids by GC/MS (40 CFR 136, Appendix A).
 - U.S. EPA Method 8290: Polychlorinated Dibenzodioxins (PCDDs) and Polychlorinated Dibenzofurans (PCDFs) by High Resolution Gas Chromatography/High Resolution Mass Spectrometry (HRGC/HRMS) (U.S. EPA, 1990b)
 - U.S. EPA Method 1668: Draft Method 1668 Toxic Polychlorinated Biphenols by Isotope Dilution High Gas Chromatography/High Resolution Mass Spectrometry (U.S. EPA, 1997a)
-
-

8. LABORATORY PROCEDURES II — SAMPLE ANALYSES

techniques are most commonly used for the determination of the recommended target analytes. These techniques are listed in Table 8-3. As shown in Table 8-4, analytical methods employing these techniques have typically achievable detection and/or quantitation limits that are well below the recommended SVs for most target analytes, with the possible exception of dieldrin, heptachlor epoxide, toxaphene, PCBs, and dioxins/furans. Recommended procedures for determining method detection and quantitation limits are given in Section 8.3.3.3.

If lower SVs are used in a study (e.g., for susceptible populations), it is the responsibility of program managers to ensure that the detection and quantitation limits of the analytical methods are sufficiently low to allow reliable quantitation of target analytes at or below these SVs. If analytical methodology is not sensitive enough to reliably quantitate target analytes at or below selected SVs (e.g., dieldrin, heptachlor epoxide, toxaphene, PCBs, dioxins/furans), program managers must determine appropriate fish consumption guidance based on lowest detectable concentrations or provide justification for adjusting SVs to values at or above achievable method detection limits. It should be emphasized that when SVs are below detection limits, the failure to detect a target analyte cannot be assumed to mean that there is no cause for concern for human health effects.

The analytical techniques identified in Table 8-3 are recommended for use in state fish and shellfish contaminant monitoring programs. However, alternative techniques may be used if acceptable detection limits, accuracy, and precision can be demonstrated. **Note:** Neither rotenone, the most widely used piscicide in the United States, nor its biotransformation products (e.g., rotenolone, 6',7'-dihydro-6',7'-dihydroxyrotenone, 6',7'-dihydro-6',7'-dihydroxyrotenolone) would be expected to interfere with the analyses of organic target analytes using the recommended gas chromatographic methods of analysis. Furthermore, rotenone has a relatively short half-life in water (3.7, 1.3, and 5.2 days for spring, summer, and fall treatments, respectively) (Dawson et al., 1991) and does not bioaccumulate significantly in fish (bioconcentration factor= 26 in fish carcass) (Gingerich and Rach, 1985), so that tissue residues should not be significant.

Laboratories should select analytical methods for routine analyses of target analytes that are most appropriate for their programs based on available resources, experience, program objectives, and data quality requirements. A recent evaluation of current methods for the analyses of organic and trace metal target analytes in fish tissue provides useful guidance on method selection, validation, and data reporting procedures (Capuzzo et al., 1990).

The references in Table 8-2 should be consulted in selecting appropriate analytical methods. **Note:** Because many laboratories may have limited experience in determining inorganic arsenic, a widely accepted method for this analysis is included in Appendix H.

8. LABORATORY PROCEDURES II — SAMPLE ANALYSES

Table 8-3. Recommended Analytical Techniques for Target Analytes

Target analyte	Analytical technique
Metals	
Arsenic (inorganic)	HAA, or HPLC with ICP-MS
Cadmium	GFAA or ICP ^a
Mercury	CVAA
Selenium	GFAA, ICP, or HAA ^{a,b}
Tributyltin	GFAA or GC/FPD ^c
Organics	
PAHs	GC/MS or HRGC/HRMS ^d
PCBs	
Total Aroclors	GC/ECD ^{e,f,g,h}
Non-ortho coplanar PCBs	HRGC/HRMS ⁱ
Other congeners/homologs	HRGC/LRMS
Organochlorine pesticides	GC/ECD ^{f,g}
Organophosphate pesticides	GC/MS, GC/FPD, or GC/NPD ^j
Chlorophenoxy herbicides	GC/ECD ^{f,g}
Dioxins/dibenzofurans	HRGC/HRMS ^{k,l}

CVAA	= Cold vapor atomic absorption spectrophotometry.
GC/ECD	= Gas chromatography/electron capture detection.
GC/FPD	= Gas chromatography/flame photometric detection.
GC/MS	= Gas chromatography/mass spectrometry.
GC/NPD	= Gas chromatography/nitrogen-phosphorus detection.
GFAA	= Graphite furnace atomic absorption spectrophotometry.
HAA	= Hydride generation atomic absorption spectrophotometry.
HPLC	= High-performance liquid chromatography.
HRGC/HRMS	= High-resolution gas chromatography/high-resolution mass spectrometry.
ICP	= Inductively coupled plasma emission spectrometry.
ICP-MS	= Inductively coupled plasma mass spectrometry.
LRMS	= Low resolution mass spectrometry.
PAHs	= Polycyclic aromatic hydrocarbons.
PCBs	= Polychlorinated biphenyls.

^a Atomic absorption methods require a separate determination for each element, which increases the time and cost relative to the broad-scan ICP method. However, GFAA detection limits are typically more than an order of magnitude lower than those achieved with ICP.

^b Use of HAA can lower detection limits for selenium by a factor of 10-100 (Crecelius, 1978; Skoog, 1985).

^c GC/FPD is specific for tributyltin and the most widely accepted analytical method. GFAA is less expensive (see Table 8-5) but is not specific for tributyltin. Depending on the extraction scheme, mono-, di-, and tetrabutyltin and other alkyltins may be included in the analysis. Contamination of samples with tin may also be a potential problem, resulting in false positives (E. Crecelius, Battelle Pacific Northwest Laboratories, Marine Sciences Laboratory, Sequim, WA, personal communication, 1999).

^d GC/MS is also recommended for base/neutral organic target analytes (except organochlorine pesticides and PCBs) that may be included in a study. Detection limits of less than 1 ppb can be achieved for PAHs using HRGC/HRMS. It is recommended that, in both screening and intensive studies, tissue samples be analyzed for benzo[a]pyrene and 14 other PAHs and that the relative potencies given for these PAHs (Nesbit and LaGoy, 1992; U.S. EPA, 1993c) be used to calculate PEC for each sample for comparison with the recommended SV for benzo[a]pyrene (see Section 5.3.2.4).

^e Analysis of total PCBs, as the sum of PCB congeners or sum of Aroclors, is recommended for conducting human health risk assessments for PCBs. A standard method for Aroclor analyses is available (EPA Method 608). EPA is currently testing a draft method (1668) for PCB congener analysis; however, it has not been finalized.

(continued)

8. LABORATORY PROCEDURES II — SAMPLE ANALYSES

Table 8-3 (continued)

- ^f GC/ECD does not provide definitive compound identification, and false positives due to interferences are commonly reported. Confirmation by an alternative GC column phase (with ECD), or by GC/MS with selected ion monitoring, is required for positive identification of PCBs, organochlorine pesticides, and chlorophenoxy herbicides.
- ^g GC/MS with selected ion monitoring may be used for quantitative analyses of these compounds if acceptable detection limits can be achieved.
- ^h PCB congener analysis using capillary GC columns is recommended (NOAA, 1989b; Dunn et al., 1984; Schwartz et al., 1984; Mullin et al., 1984; Stalling et al., 1987). An enrichment step, employing an activated carbon column, may also be required to separate and quantify coeluting congeners or congeners present at very low concentrations (Smith, 1981; Schwartz et al., 1993).
- ⁱ Includes PCBs -77, -81, -126 and -169.
- ^j Some of the chlorinated organophosphate pesticides (e.g., chlorpyrifos) may be analyzed by GC/ECD (USGS, 1987).
- ^k The analysis of the 1,2,3,7,8-substituted congeners of tetra- through octa-chlorinated dibenzo-*p*-dioxins (PCDDs) and dibenzofurans (PCDFs) using isotope dilution is recommended.
- ^l Because of the toxicity of dioxins/furans and the difficulty and cost of these analyses, relatively few laboratories currently have the capability of performing these analyses. Contract laboratories experienced in conducting dioxin/furan analyses are listed in Table 8-1.

8. LABORATORY PROCEDURES II — SAMPLE ANALYSES

Table 8-4. Range of Detection and Quantitation Limits of Current Analytical Methods for Recommended Target Analytes^a

Target analyte	Recreational SV	Subsistence SV ^b	Range of detection limits	Range of quantitation limits
Metals				
Arsenic (inorganic)	26 ppb	3.27 ppb	5-50 ppb ^c ; 50-100 ppb ^d	5-25 ppb
Cadmium	4,000 ppb	491 ppb	5-46 ppb ^e , 400 ppb ^f	5-500 ppb
Mercury	400 ppb	49 ppb	1.3-100 ppb ^g	2-10 ppb
Selenium	20,000 ppb	2,457 ppb	17-150 ppb ^c ; 20 ppb ^h , 600 ppb ^f	20-600 ppb
Tributyltin	1,200 ppb	147 ppb	2.5 ppb ^e ; 2-5 ppb ⁱ	2-10 ppb
Organochlorine Pesticides^j				
Chlordane (total)	—	—		
<i>cis</i> -Chlordane	114 ppb	14 ppb	1-5 ppb	2-20 ppb ^{j,k}
<i>trans</i> -Chlordane			1-5 ppb	2-15 ppb
<i>cis</i> -Nonachlor			1-5 ppb	2-15 ppb
<i>trans</i> -Nonachlor			1-7 ppb	2-15 ppb
Oxychlordane			1-5 ppb	2-15 ppb
DDT (total)	117 ppb	14.4 ppb		
4,4'-DDT			0.1-13 ppb	2-20 ppb
2,4'-DDT			0.1-10 ppb	2-15 ppb
4,4'-DDD			0.1-10 ppb	2-15 ppb
2,4'-DDD			0.1-10 ppb	2-15 ppb
4,4'-DDE			0.1-38 ppb	2-15 ppb ^{j,k}
2,4'-DDE			0.1-10 ppb	2-15 ppb
Dicofol	1,600 ppb	196 ppb	1-5 ppb	2-10 ppb
Dieldrin	2.50 ppb	0.307 ppb	0.1-5 ppb	2-15 ppb
Endosulfan (total)	24,000 ppb	2,949 ppb	5-70 ppb	10-70 ppb
Endosulfan I			5-10 ppb	2-15 ppb
Endosulfan II			5-70 ppb	10-70 ppb
Endrin	1,200 ppb	147 ppb	0.1-15 ppb	2-15 ppb ^{j,k}
Heptachlor epoxide	4.39 ppb	0.54 ppb	0.1-5 ppb	2-15 ppb ^{j,k}
Hexachlorobenzene	25 ppb	3.07 ppb	0.1-2 ppb	2-15 ppb ^{j,k}
Lindane	30 ppb	3.78 ppb	0.1-5 ppb	2-15 ppb ^{j,k}
Mirex	800 ppb	98 ppb	0.1-5 ppb	2-15 ppb ^{j,k}
Toxaphene	36 ppb	4.46 ppb	3-100 ppb	60-153 ppb
Organophosphate Pesticides^j				
Chlorpyrifos	18,000 ppb	147 ppb	2-5 ppb	2-15 ppb ^k
Diazinon	4,200 ppb	344 ppb	2-5 ppb	2-15 ppb
Disulfoton	240 ppb	19 ppb	2-5 ppb	2-15 ppb
Ethion	3,000 ppb	245 ppb	2-5 ppb	2-15 ppb
Terbufos	120 ppb	9 ppb	2-5 ppb	2-15 ppb
Chlorophenoxy Herbicides				
Oxyfluorfen	546 ppb	679 ppb	10-20 ppb	20-200 ppb
PAHs^l				
	5.47 ppb	0.67 ppb	1-10 ppt	2-20 ppt
PCBs total				
(sum of Aroclors) ^j	20 ppb	2.45 ppb	—	—
Non-ortho coplanar PCBs ^k			(20-62 ppb) ^m	(110-170 ppb) ^m
Other congeners/ homologues ⁿ			2-5 ppt	2-10 ppt
Other congeners/ homologues ⁿ			2-5 ppb	10 ppb
Dioxins/furans^k (total)				
	0.256 ppt	0.031 ppt	1.0 ppt	5-10 ppt
TCDD/TCDF			0.1 ppt	0.5 ppt
PeCDD/PeCDF			0.5 ppt	2.5 ppt
HxCDD/HxCDF			0.5 ppt	2.5 ppt
HpCDD/HpCDF			0.5 ppt	2.5 ppt
OCDD/OCDF			1.0 ppt	5 ppt

PAHs = Polycyclic aromatic hydrocarbons. PCBs = Polychlorinated biphenyls. SV = Screening value (wet weight).

(continued)

8. LABORATORY PROCEDURES II — SAMPLE ANALYSES

Table 8-4. (continued)

- ^a Target analyte concentrations are given based on wet weight of fish tissue.
- ^b From Tables 5-2 and 5-3. SVs shown here are for fish consumers using RfDs or CSFs available in the EPA IRIS (1999) database and assuming a consumption rate (CR) for recreational fishers of 12 g/d and for subsistence fishers of 124 g/d, average adult body weight (BW) = 72 kg, lifetime (70-yr) exposure, and, for carcinogens, a risk level (RL) = 10^{-5} . **Note:** Increasing CR, decreasing BW, and/or using an RL $<10^{-5}$ will decrease the SV. Program managers must ensure that detection and quantitation limits of analytical methods are sufficient to allow reliable quantitation of target analytes at or below selected SVs. If analytical methodology is not sensitive enough to reliably quantitate target analytes at or below selected SVs (e.g., inorganic arsenic, dieldrin, heptachlor epoxide, toxaphene, PCBs, dioxins/furans), the program managers must determine appropriate fish consumption guidance based on lowest detectable concentrations or provide justification for adjusting SVs to values at or above achievable method detection or quantitation limits. It should be emphasized that when SVs are below method detection limits, the failure to detect a target analyte cannot be assumed to indicate that there is no cause for concern for human health effects.
- ^c Analysis by hydride generation atomic absorption spectrophotometry (HAA) with preconcentration (E. Crecelius, Battelle Pacific Northwest Laboratories, Marine Sciences Laboratory, Sequim, WA, personal communication, July 1999).
- ^d Analysis by high-performance liquid chromatography/mass spectrometry (HPLC/MS) (E. Crecelius, Battelle Pacific Northwest Laboratories, Marine Sciences Laboratory, Sequim, WA, personal communication, July 1999).
- ^e Analysis by graphite furnace atomic absorption spectrophotometry (GFAA). **Note:** This method is not specific for tributyltin. Depending on the extraction procedure, mono-, di-, and tetrabutyltin may also be included in the analysis. Also, this method does not distinguish between butyltins and other alkyltins (E. Crecelius, Battelle Pacific Northwest Laboratories, Marine Sciences Laboratory, Sequim, WA, personal communication, July 1999).
- ^f Analysis by inductively coupled plasma atomic emission spectrophotometry (ICP).
- ^g Analysis by cold vapor atomic absorption spectrophotometry (CVAA).
- ^h Analysis by HAA.
- ⁱ Analysis by gas chromatography/flame photometric detection (GC/FPD) (E. Crecelius, Battelle Pacific Northwest Laboratories, Marine Sciences Laboratory, Sequim, WA, personal communication, July 1999).
- ^j Analysis by gas chromatography/electron capture detection (GC/ECD), except where otherwise noted.
- ^k Analysis by high-resolution GC/high-resolution mass spectrometry (HRGC/HRMS).
- ^l Analysis by gas chromatography/mass spectrometry. Detection limits of less than 1 ppb can be achieved using high-resolution gas chromatography/mass spectrometry (HRGC/HRMS).
- ^m Values in parentheses represent ranges for individual Aroclors.
- ⁿ Analysis by high-resolution GC/low resolution mass spectrometry (HRGC/LRMS).

An additional resource for method selection is the EPA Environmental Monitoring Methods Index System (EMMI), an automated inventory of information on environmentally significant analytes and methods for their analysis (U.S. EPA, 1991f). The EMMI database includes information on more than 4,000 analytes from over 80 regulatory and nonregulatory lists and more than 900 analytical methods in a variety of matrices, including tissue. This searchable database provides a comprehensive cross-reference between analytes and analytical methods with detailed information on each analytical method, including sponsoring organization, sample matrix, and estimates of detection limits, accuracy, and precision.

EMMI is available from the EPA Sample Control Center for all EPA personnel and from National Technical Information Service (NTIS) for all other parties. EMMI is also available through the EPA Local Area Network (LAN).

The private sector may purchase EMMI Version 2.0 through the:

National Technical Information Service (NTIS)
5285 Port Royal Road
Springfield, VA 22161
USA
Phone: (703) 605-6000
Fax: (703) 605-6900
Rush Orders: (800) 553-NTIS
Online Orders: <http://www.ntis.gov>

The order number is PB97-5026371NC for a single user, PB97-5026451NC for a five-user LAN package, and PB97-5026521NC for an unlimited user LAN package. Further information may be obtained by contacting:

EMMI User Support
Tech Calls
EPA Assistant Administrator for Water
Office of Science and Technology
(703) 461-2104
Alexandria, VA 22313

Because chemical analysis is frequently one of the most expensive components of a sampling and analysis program, the selection of an analytical method often will be influenced by its cost. In general, analytical costs increase with increased sensitivity (i.e., lower detection limits) and reliability (i.e., accuracy and precision). Analytical costs will also be dependent on the number of samples to be analyzed, the requested turnaround time, the number and type of analytes requested, the level of QC effort, and the amount of support documentation requested (Puget Sound Estuary Program, 1990d). However, differences in protocols, laboratory experience, and pricing policies of laboratories often introduce large variation into analytical costs. Approximate costs per sample for the analysis of target analytes by the recommended analytical techniques are provided in Table 8-5.

8.3 QUALITY ASSURANCE AND QUALITY CONTROL CONSIDERATIONS

Quality assurance and quality control must be integral parts of each chemical analysis program. The QA process consists of management review and oversight at the planning, implementation, and completion stages of the analytical data collection activity to ensure that data provided are of the quality required. The QC process includes those activities required during data collection to produce the data quality desired and to document the quality of the collected data.

During the planning of a chemical analysis program, QA activities focus on defining data quality criteria and designing a QC system to measure the quality of data being generated. During the implementation of the data collection effort, QA activities ensure that the QC system is functioning effectively and that the

8. LABORATORY PROCEDURES II — SAMPLE ANALYSES

Table 8-5. Approximate Range of Costs per Sample for Analysis of Recommended Target Analytes^a

Target analyte	Approximate cost range (1999 \$)
Metals^b	
Arsenic (inorganic) ^c	200 - 400
Cadmium	55 - 60
Mercury (total)	45 - 60
Selenium	35 - 60
Tributyltin ^d	200 - 400
Organochlorine pesticides^{e,f}	285 - 500
Organophosphate pesticides^g	250 - 500
Chlorophenoxy herbicides^h	250 - 500
PAHsⁱ	250 - 525
PCBs	
Total Aroclors ^e	210 - 500
Non-ortho coplanar PCBs ^j	1,000 - 2,000
Other congeners/homologs ^k	800 - 1,000
Dioxins/furans^l	
TCDD/TCDF only	600 - 1,000
TCDD/TCDF through OCDD/OCDF isomers	800 - 1,600
2,3,7,8-substituted dioxins/furans	1,000 - 2,000
Lipid	30 - 40

OCDD = Octachlorodibenzo-*p*-dioxin.

PCBs = Polychlorinated biphenyls.

OCDF = Octachlorodibenzofuran.

TCDD = 2,3,7,8-Tetrachlorodibenzo-*p*-dioxin.

PAHs = Polycyclic aromatic hydrocarbons.

TCDF = 2,3,7,8-Tetrachlorodibenzofuran.

^a These costs include sample digestion or extraction and cleanup, but not sample preparation (i.e., resection, grinding, homogenization, compositing). Estimated cost of sample preparation for a composite homogenate of five fish is \$200 to \$500.

^b Analysis of inorganic arsenic by hydride generation atomic absorption spectroscopy (HAA) or high-performance liquid chromatography-inductively coupled plasma mass spectrometry (HPLC-ICP/MS). Analysis of cadmium by graphite furnace atomic absorption spectrophotometry (GFAA). Analysis of selenium by GFAA or HAA. Analysis of mercury by cold vapor atomic absorption spectrophotometry (CVAA). Analysis of tributyltin by GFAA or gas chromatography/flame photometric detection (GC/FPD).

^c Estimated costs are for total inorganic arsenic. Estimated cost of analysis by HAA is \$200. Estimated cost of analysis by HPLC-ICP/MS is \$400.

^d Estimated cost of analysis by GFAA is \$200. Estimated cost of analysis by GC/FPD is \$400. **Note:** Analysis by GFAA is not specific for tributyltin. Depending on the extraction procedure, other butyl- and alkyltin species may be detected.

^e Analysis by gas chromatography/electron capture detection (GC/ECD).

^f Estimated costs are for analysis of all recommended target analyte organochlorine pesticides (see Table 4-1).

^g Analysis by GC/FPD or gas chromatography/nitrogen-phosphorus detection (GC/NPD). Some of the chlorinated organophosphate pesticides (e.g., chlorpyrifos) may be analyzed as organochlorine pesticides by GC/ECD (USGS, 1987).

^h Analysis by GC/ECD.

ⁱ Costs are for analysis by gas chromatography/mass spectrometry (GC/MS) or gas chromatography/flame ionization detection (GC/FID). Cost for analysis by high-resolution gas chromatography/high resolution mass spectrometry (HRGC/HRMS) is approximately \$1,000 per sample.

^j Analysis by HRGC/HRMS.

^k Analysis by HRGC/low resolution mass spectrometry (LRMS).

deficiencies uncovered by the QC system are corrected. After the analytical data are collected, QA activities focus on assessing the quality of data obtained to determine its suitability to support decisions for further monitoring, risk assessments, or issuance of advisories.

The purpose of this section is to describe the general QA and QC requirements for chemical analysis programs.

8.3.1 QA Plans

Each laboratory performing chemical analyses in fish and shellfish contaminant monitoring programs must have an adequate QA program (U.S. EPA, 1984b). The QA program should be documented fully in a QA plan or in a combined Work/QA Project Plan (U.S. EPA, 1980b). (See Appendix I.) Each QA and QC requirement or procedure should be described clearly. Documentation should clearly demonstrate that the QA program meets overall program objectives and data quality requirements. The QA guidelines in the Puget Sound Estuary Program (1990d, 1990e), the NOAA Status and Trends Program (Battelle, 1989b; Cantillo, 1991; NOAA, 1987), the EPA 301(h) Monitoring Programs (U.S. EPA, 1987e), the EPA EMAP Near Coastal (EMAP-NC) Program (U.S. EPA, 1991e), and the EPA Contract Laboratory (CLP) Program (U.S. EPA, 1991b, 1991c) are recommended as a basis for developing program-specific QA programs. Additional method-specific QC guidance is given in references in Table 8-2.

8.3.2 Method Documentation

Methods used routinely for the analyses of contaminants in fish and shellfish tissues must be documented thoroughly, preferably as formal standard operating procedures (U.S. EPA, 1984b). Recommended contents of an analytical SOP are shown in Figure 8-1. Analytical SOPs must be followed exactly as written. A published method may serve as an analytical SOP only if the analysis is performed exactly as described. Any significant deviations from analytical SOPs must be documented in the laboratory records (signed and dated by the responsible person) and noted in the final data report. Adequate evidence must be provided to demonstrate that an SOP deviation did not adversely affect method performance (i.e., detection or quantitation limits, accuracy, precision). Otherwise, the effect of the deviation on data quality must be assessed and documented and all suspect data must be identified.

8.3.3 Minimum QA and QC Requirements for Sample Analyses

The guidance provided in this section is derived primarily from the protocols developed for the Puget Sound Estuary Program (1990d, 1990e). These protocols have also provided the basis for the EPA EMAP-NC QA and QC requirements (U.S. EPA, 1991e). QA and QC recommendations specified in this document are intended to provide a uniform performance standard for all analytical protocols used in state fish and shellfish contaminant monitoring

8. LABORATORY PROCEDURES II — SAMPLE ANALYSES

- | | |
|---|---|
| <ul style="list-style-type: none">• Scope and application• Method performance characteristics (accuracy, precision, method detection and quantitation limits) for each analyte• Interferences• Equipment, supplies, and materials• Sample preservation and handling procedures• Instrument calibration procedures• Sample preparation (i.e., extraction, digestion, cleanup) procedures | <ul style="list-style-type: none">• Sample analysis procedures• Quality control procedures• Corrective action procedures• Data reduction and analysis procedures (with example calculations)• Recordkeeping procedures (with standard data forms, if applicable)• Safety procedures and/or cautionary notes• Disposal procedures• References |
|---|---|

Figure 8-1. Recommended contents of analytical standard operating procedures (SOPs).

programs and to enable an assessment of the comparability of results generated by different laboratories and different analytical procedures. These recommendations are intended to represent minimum QA and QC procedures for any given analytical method. Additional method-specific QC procedures should always be followed to ensure overall data quality.

For sample analyses, minimum QA and QC requirements consist of (1) initial demonstration of laboratory capability and (2) routine analyses of appropriate QA and QC samples to demonstrate continued acceptable performance and to document data quality.

Initial demonstration of laboratory capability (prior to analysis of field samples) should include

- Instrument calibration
- Documentation of detection and quantitation limits
- Documentation of accuracy and precision
- Analysis of an accuracy-based performance evaluation sample provided by an external QA program.

Ongoing demonstration of acceptable laboratory performance and documentation of data quality should include

- Routine calibration and calibration checks
- Routine assessment of accuracy and precision
- Routine monitoring of interferences and contamination
- Regular assessment of performance through participation in external QA interlaboratory comparison exercises, when available.

The QA and QC requirements for the analyses of target analytes in tissues should be based on specific performance criteria (i.e., warning or control limits) for data quality indicators such as accuracy and precision. **Warning limits** are numerical criteria that serve to alert data reviewers and data users that data quality may be questionable. A laboratory is not required to terminate analyses when a warning limit is exceeded, but the reported data may be qualified during subsequent QA review. **Control limits** are numerical data criteria that, when exceeded, require

8. LABORATORY PROCEDURES II — SAMPLE ANALYSES

suspension of analyses and specific corrective action by the laboratory before the analyses may resume.

Typically, warning and control limits for accuracy are based on the historical mean recovery plus or minus two or three standard deviation units, respectively. Warning and control limits for precision are typically based on the historical standard deviation or coefficient of variation (or mean relative percent difference for duplicate samples) plus two or three standard deviation units, respectively. Procedures incorporating control charts (ASTM, 1976; Taylor, 1985) and/or tabular presentations of historical data should be in place for routine monitoring of analytical performance. Procedures for corrective action in the event of excursion outside warning and control limits should also be in place.

The results for the various QC samples analyzed with each batch of samples should be reviewed by qualified laboratory personnel immediately following the analysis of each sample batch to determine when warning or control limits have been exceeded. When established control limits are exceeded, appropriate corrective action should be taken and, if possible, all suspect samples reanalyzed before resuming routine analyses. If reanalyses cannot be performed, all suspect data should be identified clearly. **Note:** For the purposes of this guidance manual, a batch is defined as any group of samples from the same source that is processed at the same time and analyzed during the same analytical run.

Recommended QA and QC samples (with definitions and specifications), frequencies of analyses, control limits, and corrective actions are summarized in Table 8-6.

Note: EPA recognizes that resource limitations may prevent some states from fully implementing all recommended QA and QC procedures. Therefore, as additional guidance, the minimum numbers of QA and QC samples recommended for routine analyses of target analytes are summarized in Table 8-7. It is the responsibility of each program manager to ensure that the analytical QC program is adequate to meet program data quality objectives for method detection limits, accuracy, precision, and comparability.

Recommended QA and QC procedures and the use of appropriate QA and QC samples are discussed in Sections 8.3.3.2 through 8.3.3.8. Recommended procedures for documenting and reporting analytical and QA and QC data are given in Section 8.4. Because of their importance in assessing data quality and interlaboratory comparability, reference materials are discussed separately in the following section.

Table 8-6. Recommended Quality Assurance and Quality Control Samples

Sample type (definition; specifications)	Objective	Recommended frequency of analysis ^a	Recommended control limits ^b	Recommended corrective action
External Calibration				
<p>Calibration standards (3-5 standards over the expected range of sample target analyte concentrations, with the lowest concentration standard at or near the MDL; see Section 8.3.3.2.1)</p>	<p>Full calibration: Establish relationship between instrument response and target analyte concentration. Used for organics analysis by GC/ECD and for metals analysis.</p>	<p>Instrument/method-dependent; follow manufacturer's recommendations or procedures in specific analytical protocols. At a minimum, perform a 3-point calibration each time an instrument is set up for analysis, after each major equipment change or disruption, and when routine calibration check exceeds specific control limits.</p>	<p><i>Organics:</i> RSD of RFs of calibration standards $\leq 20\%$. <i>Metals:</i> %R of all calibration standards = 95-105.</p>	<p>Determine cause of problem (e.g., instrument instability or malfunction, contamination, inaccurate preparation of calibration standards) and take appropriate corrective action. Recalibrate and reanalyze all suspect samples or flag all suspect data.</p>
Internal Standard Calibration				
<p>Instrument internal standards (e.g., 2,2'-difluorobiphenyl) (see Section 8.3.3.2.1 for definition)</p>	<p>Full calibration: Determine RRFs of organic target analytes for quantitative analysis. Required for internal calibration of GC/MS systems. Optional calibration technique for GC/ECD.</p>	<p>In every calibration standard, sample, and blank analyzed; added to final sample extract. Internal standard calibration performed at same frequency recommended for external calibration.</p>	<p>RSD of RRFs of calibration standards $\leq 30\%$.</p>	<p>Determine cause of problem (e.g., instrument instability or malfunction, contamination, inaccurate preparation of internal standards or calibration standards) and take appropriate corrective action. Recalibrate and reanalyze all suspect samples or flag all suspect data.</p>
Calibration Verification				
<p>Calibration check standards (minimum of one mid-range standard prepared independently from initial calibration standards; an instrument internal standard must be added to each calibration check standard when internal standard calibration is being used; see Section 8.3.3.2.1)</p>	<p>Verify calibration.</p>	<p><i>Organics (GC/MS):</i> After initial calibration or recalibration. At beginning and end of each work shift, and once every 12 h (or every 10-12 analyses, whichever is more frequent). <i>Organics (GC/ECD):</i> After initial calibration or recalibration. At beginning and end of each work shift, and once every 6 h (or every 6 samples, whichever is less frequent). <i>Metals:</i> After initial calibration or recalibration. Every 10 samples or every 2 h, whichever is more frequent.</p>	<p><i>Organics:</i> Percent difference between the average RF (or RRF) from initial calibration and the RF (or RRF) from the calibration check $\leq 25\%$. <i>Mercury:</i> %R = 80-120. <i>Other Metals:</i> %R = 90-110.</p>	<p>Determine cause of problem (e.g., instrument instability or malfunction, contamination, inaccurate preparation of calibration standards) and take appropriate corrective action. Recalibrate and reanalyze all suspect samples or flag all suspect data.</p>

(continued)

8. LABORATORY PROCEDURES II — SAMPLE ANALYSES

Table 8-6. (continued)

Sample type (definition; specifications)	Objective	Recommended frequency of analysis ^a	Recommended control limits ^b	Recommended corrective action
Method Detection Limit Determination				
Spiked matrix samples (analyte-free tissue samples to which known amounts of target analytes have been added; one spike for each target analyte at 3-5 times the estimated MDL; see Section 8.3.3.3.1)	Establish or confirm MDL for analyte of interest (Keith, 1991a; Keith et al., 1983).	Seven replicate analyses prior to use of method for routine analyses, and after any significant change to a method currently in use. Reevaluation of MDL annually.	Determined by program manager.	Redetermine MDL.
Accuracy and Precision Assessment				
Reference materials^c (see Section 8.3.3.1 for definitions) (SRMs or CRMs, prepared from actual contaminated fish or shellfish tissue if possible, covering the range of expected target analyte concentrations.)	Assess method performance (initial method validation and routine accuracy assessment).	<i>Method validation:</i> As many as required to assess accuracy (and precision) of method before routine analysis of samples (i.e., when using a method for the first time or after any method modification). <i>Routine accuracy assessment:</i> one (preferably blind) per 20 samples or one per batch, whichever is more frequent.	<i>Organics:</i> Measured value <95% confidence intervals, if certified. Otherwise, %R = 70-130. ^d <i>Metals:</i> %R = 85-115. ^d <i>Organics:</i> Measured value <95% confidence intervals, if certified. Otherwise, %R = 70-130. ^d <i>Metals:</i> %R = 85-115. ^d	NA Determine cause of problem (e.g., inaccurate calibration, contamination), take appropriate corrective action, and reanalyze all suspect samples or flag all suspect data.
Laboratory control samples (Accuracy-based samples consisting of fish or shellfish tissue homogenates spiked with target analytes of interest; may be SRMs or CRMs; sometimes referred to as QC samples. When available, CRMs are recommended for routine use as laboratory control samples; see Appendix M)	Assess method performance (initial method validation and routine accuracy assessment). Used for initial accuracy assessment only if reference materials prepared from actual contaminated fish or shellfish are not available.	<i>Method validation:</i> As many as required to assess accuracy (and precision) of method before routine analysis of samples (i.e., when using a method for the first time or after any method modification). <i>Routine accuracy assessment:</i> One per 20 samples or one per batch, whichever is more frequent.	Determined by program manager. <i>Organics:</i> %R = 70-130. ^d <i>Metals:</i> %R = 85-115. ^d	NA Determine cause of problem (e.g., inaccurate calibration, inaccurate preparation of control samples), take appropriate corrective action, and reanalyze all suspect samples or flag all suspect data. Zero percent recovery requires rejection of all suspect data.

(continued)

8. LABORATORY PROCEDURES II — SAMPLE ANALYSES

Table 8-6. (continued)

Sample type (definition; specifications)	Objective	Recommended frequency of analysis ^a	Recommended control limits ^b	Recommended corrective action
Matrix spikes (composite tissue homogenates of field samples to which known amounts of target analytes have been added; 0.5 to 5 times the concentration of the analyte of interest or 5 times the MQL)	Assess matrix effects and accuracy (%R) routinely.	One per 20 samples or one per batch, whichever is more frequent.	<i>Organics:</i> %R \geq 50 with good precision. <i>Metals:</i> %R = 75-125.	Determine cause of problem (e.g., incomplete extraction or digestion, contamination), take appropriate corrective action, and reanalyze all suspect samples or flag all suspect data. Zero percent recovery requires rejection of all suspect data.
Matrix spike replicates (replicate aliquots of matrix spike samples; 0.5 to 5 times the concentration of the analyte of interest or 5 times the MQL)	Assess method precision routinely.	One duplicate per 20 samples or one per batch, whichever is more frequent.	<i>Organics:</i> A difference of no more than a factor of 2 among replicates (i.e., approximately 50% coefficient of variation). Note: Pooling of variances in duplicate analyses from different sample batches is recommended for estimating the standard deviation or coefficient of variation of replicate analyses. <i>Metals:</i> IRPDI \leq 20 for duplicates.	Determine cause of problem (e.g., incomplete extraction or digestion, contamination, instrument instability or malfunction), take appropriate corrective action, and reanalyze all suspect samples or flag all suspect data.
Laboratory replicates^c (replicate aliquots of composite tissue homogenates of field samples)	Assess method precision routinely.	One blind duplicate sample per 20 samples or one per batch, whichever is more frequent.	<i>Organics:</i> A difference of no more than a factor of 2 among replicates (i.e., approximately 50% coefficient of variation). Note: Pooling of variances in duplicate analyses from different sample batches is recommended for estimating the standard deviation or coefficient of variation of replicate analyses. <i>Metals:</i> IRPDI \leq 20 for duplicates.	Determine cause of problem (e.g., composite sample not homogeneous, instrument instability or malfunction), take appropriate corrective action, and reanalyze all suspect samples or flag all suspect data.
Analytical Replicates (replicate aliquots of final sample extract or digestate)	Assess analytical precision.	Duplicate injections for all metal analyses. ^f	Determined by program manager. ^g	Determine cause of problem (e.g., instrument instability or malfunction), take appropriate corrective action, and reanalyze sample.

(continued)

8. LABORATORY PROCEDURES II — SAMPLE ANALYSES

Table 8-6. (continued)

Sample type (definition; specifications)	Objective	Recommended frequency of analysis ^a	Recommended control limits ^b	Recommended corrective action
Field replicates (replicate composite tissue samples)	Assess total variability (i.e., population variability, field or sampling variability, and analytical method variability).	<i>Screening studies:</i> OPTIONAL ; if program resources allow, a minimum of one blind replicate (i.e., duplicate) for each primary target species at 10 percent of screening sites. ⁹ <i>Intensive studies:</i> Blind replicate samples for each target species (and size, age or sex class, if appropriate) at each sampling site. Number of replicates determined by program manager (see Section 6.1.2.7).	Determined by program manager. ⁹	Determined by program manager.
Contamination Assessment				
Blanks (field, method, processing, bottle, reagent) (see Section 8.3.3.6 for definitions)	Assess contamination from equipment, reagents, etc.	One field blank per sampling site. One method blank per 20 samples or one per batch, whichever is more frequent. At least one processing blank per study. At least one bottle blank per lot or per batch of samples, whichever is more frequent. One reagent blank prior to use of a new batch of reagent and whenever method blank exceeds control limits.	Concentration of any analyte <MDL or MQL, as determined by program manager.	Determine cause of problem (e.g., contaminated reagents, equipment), remove sources of contamination, and reanalyze all suspect samples or flag all suspect data.
Routine Monitoring of Method Performance for Organic Analyses				
Surrogate spikes (see Section 8.3.3.7.1 for definition)	Assess method performance and estimate recovery of organic target analytes analyzed by GC/MS. Determine RRFs of organic target analytes quantitated by isotope dilution techniques.	In every calibration standard, sample, and blank analyzed for organics by isotope dilution GC/MS; added to samples prior to extraction.	Determined by program manager.	Determine cause of problem (e.g., incomplete extraction or digestion, contamination, inaccurate preparation of internal standard), take appropriate corrective action, and reanalyze all suspect samples or flag all suspect data.
Prepared from isotopically labeled target analytes				

(continued)

8. LABORATORY PROCEDURES II — SAMPLE ANALYSES

Table 8-6. (continued)

Sample type (definition; specifications)	Objective	Recommended frequency of analysis ^a	Recommended control limits ^b	Recommended corrective action
Prepared from other surrogate compounds	Assess method performance and estimate the recovery of organic target analytes analyzed by GC/MS or GC/ECD.	In every calibration standard, sample, and blank analyzed for organics, unless isotope dilution technique is used: <i>Semivolatiles:</i> 3 for neutral fraction 2 for acid fraction <i>Volatiles:</i> 3 <i>Pesticides/PCBs:</i> 1 Added to samples prior to extraction.	Determined by program manager according to most recent EPA CLP guidelines. ^h	Determine cause of problem (e.g., incomplete extraction or digestion, contamination, inaccurate preparation of surrogates), take appropriate corrective action, and reanalyze all suspect samples or flag all suspect data.
External QA Assessment				
Accuracy-based performance evaluation samples (QA samples from NOAA interlaboratory comparison program; see Section 8.3.3.8.1)	Initial demonstration of laboratory capability. Ongoing demonstration of laboratory capability.	Once prior to routine analysis of field samples (blind). One exercise (four to six samples) per year (blind).	<i>Organics:</i> %R=70-130. ^d <i>Metals:</i> %R=85-115. ^d Determined by NOAA. Based on consensus value of all participating laboratories.	Determine cause of problem and reanalyze sample. Do not begin analysis of field samples until performance evaluation sample results are acceptable. Determine cause of problem. Do not continue analysis of field samples until laboratory capability is clearly demonstrated.

(continued)

Table 8-6. (continued)

Sample type (definition; specifications)	Objective	Recommended frequency of analysis ^a	Recommended control limits ^b	Recommended corrective action
Split samples (laboratory replicates analyzed by different laboratories; see Section 8.3.3.8.2)	Assess interlaboratory comparability.	5-10% of composite homogenates split between states and/or Regions that routinely share monitoring results, or as determined by program managers. ^g	Determined by program managers.	Review sampling and analytical methods. Identify sources of noncomparability. Standardize and validate methods to document comparability.
CLP = Contract laboratory program. CRM = Certified reference material (see Section 8.3.3.1).		NA = Not applicable. NOAA = National Oceanic and Atmospheric Administration.	RPD = Relative percent difference (see Section 8.3.3.5). RRF = Relative response factor (see Section 8.3.3.2.1).	
GC/ECD = Gas chromatography/electron capture detection.		PCBs = Polychlorinated biphenyls. QA = Quality assurance. %R = Percent recovery (see Sections 8.3.3.4 and 8.3.3.7.1).	RSD = Relative standard deviation (see Section 8.3.3.5). SRM = Standard reference material (see Section 8.3.3.1).	
GC/MS = Gas chromatography/mass spectrometry. MDL = Method detection limit (see Section 8.3.3.3.1). MQL = Method quantitation limit (see Section 8.3.3.3.2).		RF = Response factor (see Section 8.3.3.2.1).		

^a Recommended frequencies are based primarily on recommendations in U.S. EPA (1986d, 1987e, 1989c, 1991b, 1991c), Puget Sound Estuary Program (1990d, 1990e), and Battelle (1989b).

^b From Puget Sound Estuary Program (1990d, 1990e) action limits, except where otherwise noted. **Note:** Individual programs may require more stringent control limits. It is the responsibility of each program manager to set control limits that will ensure that the measurement data meet program data quality objectives.

^c As available (see Table 8-8 and Appendix M).

^d From U.S.EPA (1991e).

^e Sometimes referred to as analytical replicates (e.g., in Puget Sound Estuary Program, 1990d).

^f From U.S. EPA (1987e).

^g Recommended by EPA for this guidance document.

^h From U.S. EPA (1991b, 1991c).

Table 8-7. Minimum Recommended QA and QC Samples for Routine Analysis of Target Analytes^a

Sample Type	Target analyte	
	Metals	Organics
Accuracy-based performance evaluation sample ^b	Once prior to routine analysis of field samples, plus one exercise (four to six samples) per year.	Once prior to routine analysis of field samples, plus one exercise (four to six samples) per year.
Method blank	1	1
Laboratory duplicate	1	1
Matrix spike/matrix spike replicate	1	1
Laboratory control sample (SRM or CRM, if available)	1	1
Calibration check standard	2 ^c	2 ^c
Surrogate spike (isotopically labeled target analyte or other surrogate compound added prior to extraction)	NA	Each sample
Instrument (injection) internal standard; added prior to injection	NA	Each calibration or calibration check standard and each sample or blank analyzed by GC/MS ^d

CRM = Certified reference material (see Section 8.3.3.1).
 GC/MS = Gas chromatography/mass spectroscopy.
 NA = Not applicable.

QA = Quality assurance.
 QC = Quality control.
 SRM = Standard reference material (see Section 8.3.3.1).

^a Unless otherwise specified, the number given is the recommended number of QC samples per 20 samples or per batch, whichever is more frequent. Additional method-specific QC requirements should always be followed provided these minimum requirements have been met.

^b QA samples from National Oceanic and Atmospheric Administration interlaboratory comparison program (see Section 8.3.3.8.1).

^c One every 10 samples (plus one at beginning and end of each analytical run).

^d Optional for analyses by GC/electron capture detection (ECD), GC/flame ionization detection (FID), or GC with other nonspecific detectors.

8.3.3.1 Reference Materials—

The appropriate use of reference materials is an essential part of good QA and QC practices for analytical chemistry. The following definitions of reference materials (Puget Sound Estuary Program, 1990d) are used in this guidance document:

- A **reference material** is any material or substance of which one or more properties have been sufficiently well established to allow its use for instrument calibration, method evaluation, or characterization of other materials.
- A **certified reference material (CRM)** is a reference material of which the value(s) of one or more properties has (have) been certified by a variety of technically valid procedures. CRMs are accompanied by or traceable to a certificate or other documentation that is issued by the certifying organization (e.g., U.S. EPA, NIST, National Research Council of Canada [NRCC]).
- A **standard reference material (SRM)** is a CRM issued by the NIST.

Reference materials may be used to (1) provide information on method accuracy and, when analyzed in replicate, on precision, and (2) obtain estimates of intermethod and/or interlaboratory comparability. An excellent discussion of the use of reference materials in QA and QC procedures is given in Taylor (1985). The following general guidelines should be followed to ensure proper use of reference materials (NOAA, 1992):

- When used to assess the accuracy of an analytical method, the matrix of the reference material should be as similar as possible to that of the samples of interest. If reference materials in matrices other than fish or shellfish tissue are used, possible matrix effects should be addressed in the final data analysis or interpretation.
- Concentrations of reference materials should cover the range of possible concentrations in the samples of interest. **Note:** Because of a lack of low- and high-concentration reference materials for most analytes in fish and shellfish tissue matrices, potential problems at low or high concentrations often cannot be documented.
- Reference materials should be analyzed prior to beginning the analyses of field samples to assess laboratory capability and regularly thereafter to detect and document any changes in laboratory performance over time. Appropriate corrective action should be taken whenever changes are observed outside specified performance limits (e.g., accuracy, precision).
- If possible, reference material samples should be introduced into the sample stream as double blinds, that is, with identity and concentration unknown to the analyst. However, because of the limited number of certified fish and

8. LABORATORY PROCEDURES II — SAMPLE ANALYSES

shellfish tissue reference materials available, the results of analyses of these materials may be biased by an analyst's increasing ability to recognize these materials with increased use.

- Results of reference material analyses are essential to assess interlaboratory or intermethod comparability. However, the results of sample analyses should not be corrected based on percent recoveries of reference materials. Final reported results should include both uncorrected sample results and percent recoveries of reference materials.

Sources of reference materials for the analysis of priority pollutants and selected related compounds in fish and shellfish tissues are given in Appendix M. Available marine or estuarine tissue reference materials that may be appropriate for use by analytical laboratories in fish and shellfish contaminant monitoring programs are given in Table 8-8.

8.3.3.2 Calibration and Calibration Checks—

General guidelines for initial calibration and routine calibration checks are provided in this section. Method-specific calibration procedures are included in the references in Table 8-2. It is the responsibility of each program manager to ensure that proper calibration procedures are developed and followed for each analytical method to ensure the accuracy of the measurement data.

All analytical instruments and equipment should be maintained and calibrated properly to ensure optimum operating conditions throughout a measurement program. Calibration and maintenance procedures should be performed according to SOPs based on the manufacturers' specifications and the requirements of specific analytical procedures. Calibration procedures must include provisions for documenting calibration frequencies, conditions, standards, and results to describe adequately the calibration history of each measurement system. Calibration records should be inspected regularly to ensure that these procedures are being performed at the required frequency and according to established SOPs. Any deficiencies in the records or deviations from established procedures should be documented and appropriate corrective action taken.

Calibration standards of known and documented accuracy must be used to ensure the accuracy of the analytical data. Each laboratory should have a program for verifying the accuracy and traceability of calibration standards against the highest quality standards available. If possible, NIST-SRMs or other certified reference standards should be used for calibration standards (see Section 8.3.3.4 and Appendix M). A log of all calibration materials and standard solutions should be maintained. Appropriate storage conditions (i.e., container specifications, shelf-life, temperature, humidity, light condition) should be documented and maintained.

8. LABORATORY PROCEDURES II — SAMPLE ANALYSES

Table 8-8. Fish and Shellfish Tissue Reference Materials

Identification code	Analytes	Source	Matrix
DOLT-1	Elements	NRCC	Dogfish liver (freeze-dried)
DORM-1	Elements	NRCC	Dogfish muscle (freeze-dried)
LUTS-1	Elements	NRCC	Non-defatted lobster hepatopancreas
TORT-1	Elements	NRCC	Lobster hepatopancreas
GBW-08571	Elements	NRCCRM	Mussel tissue (freeze-dried)
GBW-08572	Elements	NRCCRM	Prawn tissue
MA-A-1/OC	Organic compounds	IAEA	Copepod homogenate (freeze-dried)
MA-A-3/OC	Organic compounds	IAEA	Shrimp homogenate (freeze-dried)
MA-B-3/OC	Organic compounds	IAEA	Fish tissue (freeze-dried)
MA-M-2/OC	Organic compounds	IAEA	Mussel tissue
MA-A-1/TM	Elements	IAEA	Copepod homogenate (freeze-dried)
MA-A-2/TM	Elements	IAEA	Fish flesh homogenate
MA-B-3/TM	Elements	IAEA	Fish tissue (freeze-dried)
MA-B-3/RN	Isotopes	IAEA	Fish tissue (freeze-dried)
IAEA-350	Elements	IAEA	Tuna homogenate (freeze-dried)
IAEA-351	Organic compounds	IAEA	Tuna homogenate (freeze-dried)
IAEA-352	Isotopes	IAEA	Tuna homogenate (freeze-dried)
CRM-278	Elements	BCR	Mussel tissue (freeze-dried)
CRM-422	Elements	BCR	Cod muscle (freeze-dried)
EPA-FISH	Pesticides	EPA1	Fish tissue
EPA-SRS903	Chlordane	EPA2	Fish tissue
EPA-0952	Mercury	EPA1	Fish tissue
EPA-2165	Mercury	EPA1	Fish tissue
RM-50	Elements	NIST	Albacore tuna (freeze-dried)
SRM-1566a	Elements	NIST	Oyster tissue (freeze-dried)
SRM-1974	Organic compounds	NIST	Mussel tissue (frozen)
SRM-2974	Organic compounds	NIST	Mussel tissue (freeze-dried)
NIES-6	Elements	NIES	Mussel tissue

Sources:

- BCR = Community Bureau of Reference, Commission of the European Communities, Directorate General for Science, Research and Development, 200 rue de la Loi, B-1049 Brussels, Belgium.
- EPA = U.S. Environmental Protection Agency, Quality Assurance Branch, EMSL-Cincinnati, Cincinnati, OH, 45268, USA. (EPA1: Material available from Supelco, Inc., Supelco Park, Bellefonte, PA, 16823-0048, USA. EPA2: Material available from Fisher Scientific, 711 Forbes Ave., Pittsburgh, PA 15219.)
- IAEA = International Atomic Energy Agency, Analytical Quality Control Service, Laboratory Seibersdorf, P. O. Box 100, A-1400 Vienna, Austria.
- NRCCRM = National Research Center for CRMs, Office of CRMs, No. 7, District 11, Hepingjie, Chaoyangqu, Beijing, 100013, China.
- NRCC = National Research Council of Canada, Institute for Environmental Chemistry, Marine Analytical Chemistry Standards Program, Division of Chemistry, Montreal Road, Ottawa, Ontario K1A 0R9, Canada.
- NIST = National Institute of Standards and Technology, Office of Standard Reference Materials, Gaithersburg, MD, 20899, USA.
- NIES = National Institute for Environmental Studies, Yatabe-machi, Tsukuba, Ibaraki, 305, Japan.

8.3.3.2.1 Initial and routine calibration

Prior to beginning routine analyses of samples, a minimum of three (and preferably five) calibration standards should be used to construct a calibration curve for each target analyte, covering the normal working range of the instrument or the expected target analyte concentration range of the samples to be analyzed. The lowest-concentration calibration standard should be at or near the estimated method detection limit (see Section 8.3.3.3.1). Calibration standards should be prepared in the same matrix (i.e., solvent) as the final sample extract or digestate. Criteria for acceptable calibration (e.g., acceptable limits for r^2 , slope, intercept, percent recovery, response factors) should be established for each analytical method. If these control limits are exceeded, the source of the problem (e.g., inaccurate standards, instrument instability or malfunction) should be identified and appropriate corrective action taken. No analyses should be performed until acceptable calibration has been achieved and documented.

In addition to the initial calibration, an established schedule for the routine calibration and maintenance of analytical instruments should be followed, based on manufacturers' specifications, historical data, and specific procedural requirements. At a minimum, calibration should be performed each time an instrument is set up for analysis, after any major disruption or failure, after any major maintenance, and whenever a calibration check exceeds the recommended control limits (see Table 8-6).

Two types of calibration procedures are used in the analytical methods recommended for the quantitation of target analytes: external calibration and internal standard calibration.

External calibration

In external calibration, calibration standards with known concentrations of target analytes are analyzed, independent of samples, to establish the relationship between instrument response and target analyte concentration. External calibration is used for the analyses of metals and, at the option of the program manager, for the analyses of organics by gas chromatography/electron capture detection (GC/ECD), gas chromatography/flame ionization detection (GC/FID), or GC methods using other nonspecific detectors.

External calibration for metals analysis is considered acceptable if the percent recovery of all calibration standards is between 95 and 105 percent; external calibration for organic analyses is considered acceptable if the relative standard deviation (RSD) of the response factors (RFs) is ≤ 20 percent (see Table 8-6). If these limits are exceeded, the initial calibration should be repeated.

Internal standard calibration

Calibration of GC/mass spectrometry (MS) systems used for the analysis of organic target analytes requires the addition of an **internal standard** to each calibration standard and determination of the response of the target analyte of interest relative to that of the internal standard. Internal standard calibration may also be used with nonspecific detector GC methods such as GC/ECD and GC/FID. Internal standards used to determine the relative response factors (RRFs) are termed instrument or injection internal standards (Puget Sound Estuary Program, 1990d; U.S. EPA, 1991e). The addition of instrument internal standards to both calibration standards and sample extracts ensures rigorous quantitation, particularly accounting for shifts in retention times of target analytes in complex sample extracts relative to calibration standards. Recommended instrument internal standards for semivolatile organic compounds are included in analytical methods for these compounds (see references in Table 8-2).

The RRF for each target analyte is calculated for each calibration standard as follows:

$$RRF_t = (A_t) (C_{is}) / (A_{is}) (C_t) \quad (8-1)$$

where

- A_t = Measured response (integrated peak area) for the target analyte
- C_{is} = Concentration of the instrument internal standard in the calibration standard
- A_{is} = Measured response (integrated peak area) for the instrument internal standard
- C_t = Concentration of the target analyte in the calibration standard.

If the RSD of the average RRF_t for all calibration standards ($\overline{RRF_t}$) is ≤ 30 percent, RRF_t can be assumed to be constant across the working calibration range and RRF_t can be used to quantitate target analyte concentrations in the samples as follows:

$$C_t \text{ (ppm or ppb, wet weight)} = (A_t) (C_{is}) (V_e) / (A_{is}) (\overline{RRF_t}) (W) \quad (8-2)$$

where

- C_t = Concentration of the target analyte in the sample
- C_{is} = Concentration of the instrument internal standard in the sample extract
- V_e = Volume of the final sample extract (mL)
- W = Weight of sample extracted (g)

and A_t , A_{is} , and \overline{RRF}_t are defined as in Equation (8-1).

If the RSD of \overline{RRF}_t for all calibration standards is >30 percent, the initial calibration should be repeated (see Table 8-6).

8.3.3.2.2 Routine calibration checks

After initial calibration has been achieved and prior to the routine analyses of samples, the accuracy of the calibration should be verified by the analysis of a calibration check standard. A **calibration check standard** is a mid-range calibration standard that has been prepared independently (i.e., using a different stock) from the initial calibration standards. When internal standard calibration is being used, an instrument internal standard must be added to each calibration check standard.

Routine calibration checks should be conducted often enough throughout each analysis run to ensure adequate maintenance of instrument calibration (see Table 8-6). A calibration check should always be performed after analyzing the last sample in a batch and at the end of each analysis run.

If a calibration check does not fall within specified calibration control limits, the source of the problem should be determined and appropriate corrective action taken (see Table 8-6). After acceptable calibration has been reestablished, all suspect analyses should be repeated. If resources permit, it is recommended that all samples after the last acceptable calibration check be reanalyzed. Otherwise, the last sample analyzed before the unacceptable calibration check should be reanalyzed first and reanalysis of samples should continue in reverse order until the difference between the reanalysis and initial results is within the control limits specified in Table 8-6. If reanalysis is not possible, all suspect data (i.e., since the last acceptable calibration check) should be identified clearly in the laboratory records and the data report.

8.3.3.2.3 Calibration range and data reporting

As noted in Section 8.3.2.1, the lowest-concentration calibration standard should be at or near the method detection limit. The highest-concentration calibration standard should be selected to cover the full range of expected concentrations of the target analyte in fish and shellfish tissue samples. If a sample concentration occurs outside the calibration range, the sample should be diluted or concentrated as appropriate and reanalyzed or the calibration range should be extended. Extremely high concentrations of organic compounds may indicate that the extraction capabilities of the method have been saturated and extraction of a smaller sample or modification of the extraction procedure may be required.

All reported concentrations must be within the upper limit of the demonstrated working calibration range. Procedures for reporting data, with appropriate

qualifications for data below method detection and quantitation limits, are given in Section 8.3.3.3.3.

8.3.3.3 Assessment of Detection and Quantitation Limits—

It is the responsibility of each laboratory to determine appropriate detection and quantitation limits for each analytical method for each target analyte in a fish or shellfish tissue matrix. When available scientific literature demonstrates that the selected SVs are analytically attainable, the laboratory is responsible for ensuring that these limits are sufficiently low to allow reliable quantitation of the analyte at or below the selected SVs (see Section 5.2). Detection and quantitation limits must be determined prior to the use of any method for routine analyses and after any significant changes are made to a method during routine analyses. Several factors influence achievable detection and quantitation limits regardless of the specific analytical procedure. These include amount of sample available, matrix interferences, and stability of the instrumentation. The limits of detection given in Table 8-4 are considered to be representative of typically attainable values. Depending upon individual laboratory capabilities and fish tissue matrix properties, it should be noted that SVs for some recommended target analytes (e.g., inorganic arsenic, dieldrin, heptachlor epoxide, toxaphene, PCBs, and dioxins/furans) may not always be analytically attainable quantitation limits. In these instances, all historic and current data on contaminant sources and on water, sediment, and fish and shellfish contaminant tissue data should be reviewed to provide additional information that could aid in the risk assessment process and in making risk management decisions.

The EPA has previously issued guidance on detection limits for trace metal and organic compounds for analytical methods used in chemical contaminant monitoring programs (U.S. EPA, 1985a). However, at present there is no clear consensus among analytical chemists on a standard procedure for determining and reporting the limits of detection and quantitation of analytical procedures. Furthermore, detection and quantitation limits reported in the literature are seldom clearly defined. Reported detection limits may be based on instrument sensitivity or determined from the analyses of method blanks or low-level matrix spikes; quantitation limits may be determined from the analyses of method blanks or low-level matrix spikes (Puget Sound Estuary Program, 1990d).

8.3.3.3.1 Detection limits

The EPA recommends that the method detection limit (MDL) defined below and determined according to 40 CFR 136, Appendix B, be used to establish the limits of detection for the analytical methods used for analyses of all target analytes:

- **Method Detection Limit:** The minimum concentration of an analyte in a given matrix (i.e., fish or shellfish tissue homogenates for the purposes of this guidance) that can be measured and reported with 99 percent confidence that the concentration is greater than zero. The MDL is determined by multiplying

8. LABORATORY PROCEDURES II — SAMPLE ANALYSES

the appropriate (i.e., n-1 degrees of freedom) one-sided 99 percent Student's t-statistic ($t_{0.99}$) by the standard deviation (**S**) obtained from a minimum of seven replicate analyses of a **spiked matrix sample** containing the analyte of interest at a concentration three to five times the estimated MDL (Glaser et al., 1981; 40 CFR 136, Appendix B):

$$\text{MDL} = (t_{0.99}) (S). \quad (8-3)$$

It is important to emphasize that all sample processing steps of the analytical method (e.g., digestion, extraction, cleanup) must be included in the determination of the MDL.

In addition to the MDL, three other types of detection limits have been defined by the American Chemical Society Committee on Environmental Improvement (Keith, 1991a):

- **Instrument Detection Limit (IDL):** The smallest signal above background noise that an instrument can detect reliably.
- **Limit of Detection (LOD):** The lowest concentration that can be determined to be statistically different from a method blank at a specified level of confidence. The recommended value for the LOD is three times the standard deviation of the blank in replicate analyses, corresponding to a 99 percent confidence level.
- **Reliable Detection Limit (RDL):** The concentration level of an analyte in a given matrix at which a detection decision is extremely likely. The RDL is generally set higher than the MDL. When $\text{RDL}=\text{MDL}$, the risk of a false positive at 3σ from zero is <1 percent, whereas the corresponding risk of a false negative is 50 percent. When $\text{RDL}=2\text{MDL}$, the risk of either a false positive or a false negative at 3σ from zero is <1 percent.

Each of these estimates has its practical limitations. The IDL does not account for possible blank contaminants or matrix interferences. The LOD accounts for blank contaminants but not for matrix effects or interferences. In some instances, the relatively high value of the MDL or RDL may be too stringent and result in the rejection of valid data; however, these are the only detection limit estimates that account for matrix effects and interferences and provide a high level of statistical confidence in sample results. The MDL is the recommended detection limit in the EPA EMAP-NC Program (U.S. EPA, 1991e).

The MDL, expressed as the concentration of target analyte in fish tissue, is calculated from the measured MDL of the target analyte in the sample extract or digestate according to the following equation:

$$\text{MDL}_{\text{tissue}} \text{ (ppm or ppb)} = (\text{MDL}_{\text{extract}} \cdot V) / W \quad (8-4)$$

where

V = Final extract or digestate volume, after dilution or concentration (mL)
W = Weight of sample digested or extracted (g).

Equation 8-4 clearly illustrates that the MDL in tissue may be improved (reduced) by increasing the sample weight (W) and/or decreasing the final extract or digestate volume (V).

The initial MDL is a statistically derived empirical value that may differ in actual samples depending on several factors, including sample size, matrix effects, and percent moisture. Therefore, it is recommended that each laboratory reevaluate annually all MDLs for the analytical methods used for the sample matrices typically encountered (U.S. EPA, 1991e).

Experienced analysts may use their best professional judgment to adjust the measured MDL to a lower "typically achievable" detection limit (Puget Sound Estuary Program, 1990e; U.S. EPA, 1985a) or to derive other estimates of detection limits. For example, EPA recommends the use of lower limits of detection (LLDs) for GG/MS methods used to analyze organic pollutants in bioaccumulation monitoring programs (U.S. EPA, 1986a). Estimation of the LLD for a given analyte involves determining the noise level in the retention window for the quantitation mass of the analyte for at least three field samples in the sample set being analyzed. The LLD is then estimated as the concentration corresponding to the signal required to exceed the average noise level observed by at least a factor of 2. Based on the best professional judgment of the analyst, this LLD is applied to samples in the set with comparable or lower interference; samples with significantly higher interferences (i.e., by at least a factor of 2) are assigned correspondingly higher LLDs. LLDs are greater than IDLs but usually are less than the more rigorously defined MDLs. Thus, data quantified between the LLD and the MDL have a lower statistical confidence associated with them than data quantified above the MDL. However, these data are considered valid and useful in assessing low-level environmental contamination.

If estimates of detection limits other than the MDL are developed and used to qualify reported data, they should be clearly defined in the analytical SOPs and in all data reports, and their relationship to the MDL should be clearly described.

8.3.3.3.2 Quantitation limits

In addition to the MDL, a method quantitation limit (MQL), or minimum concentration allowed to be reported at a specified level of confidence without qualifications, should be derived for each analyte. Ideally, MQLs should account for matrix effects and interferences. The MQL can be greater than or equal to the MDL. At present, there is no consistent guidance in the scientific literature for determining MQLs; therefore, it is not possible to provide specific recommendations for determining these limits at this time.

The American Chemical Society Committee on Environmental Improvement (Keith, 1991b; Keith et al., 1983) has defined one type of quantitation limit:

- **Limit of Quantitation (LOQ):** The concentration above which quantitative results may be obtained with a specified degree of confidence. The recommended value for the LOQ is 10 times the standard deviation of a method blank in replicate analyses, corresponding to an uncertainty of ± 30 percent in the measured value ($10\sigma \pm 3\sigma$) at the 99 percent confidence level.

The LOQ is the recommended quantitation limit in the EPA EMAP-NC Program (U.S. EPA, 1991e). However, the LOQ does not account for matrix effects or interferences.

The U.S. EPA (1986d) has defined another type of quantitation limit:

- **Practical Quantitation Limit (PQL):** The lowest concentration that can be reliably reported within specified limits of precision and accuracy under routine laboratory operating conditions.

The Puget Sound Estuary Program (1990d) and the National Dioxin Study (U.S. EPA, 1987d) used a PQL based on the lowest concentration of the initial calibration curve (C, in $\mu\text{g}/\text{mL}$), the amount of sample typically analyzed (W, in g), and the final extract volume (V, in mL) of that method:

$$\text{PQL } (\mu\text{g} / \text{g}[\text{ppm}]) = \frac{C (\mu\text{g} / \text{mL}) \cdot V(\text{mL})}{W (\text{g})} \quad (8-5)$$

However, this PQL is also applicable only to samples without substantial matrix effects or interferences.

A reliable detection limit (RDL) equal to 2 MDL may also be used as an estimate of the MQL (see Section 8.3.3.3.1). The RDL accounts for matrix effects and provides a high level of statistical confidence in analytical results.

Analysts must use their expertise and professional judgment to determine the best estimate of the MQL for each target analyte. MQLs, including the estimated degree of confidence in analyte concentrations above the quantitation limit, should be clearly defined in the analytical SOPs and in all data reports.

8.3.3.3.3 Use of detection and quantitation limits in reporting data

The analytical laboratory does not have responsibility or authority to censor data. Therefore, all data should be reported with complete documentation of limitations and problems. Method detection and quantitation limits should be used to qualify reported data for each composite sample as follows (Keith, 1991b):

8. LABORATORY PROCEDURES II — SAMPLE ANALYSES

- "Zero" concentration (no observed response) should be reported as not detected (ND) with the MDL noted, e.g., "ND(MDL=X)".
- Concentrations below the MDL should be reported with the qualification that they are below the MDL.
- Concentrations between the MDL and the MQL should be reported with the qualification that they are below the quantitation limit.
- Concentrations at or above the MQL may be reported and used without qualification.

The use of laboratory data for comparing target analyte concentrations to SVs in screening and intensive studies is discussed in Sections 9.1.1 and 9.1.2.

8.3.3.4 Assessment of Method Accuracy—

The accuracy of each analytical method should be assessed and documented for each target analyte of interest, in a fish or shellfish tissue matrix, prior to beginning routine analyses and on a regular basis during routine analyses.

Method accuracy may be assessed by analysis of appropriate reference materials (i.e., SRMs or CRMs prepared from actual contaminated fish or shellfish tissue, see Table 8-8, **laboratory control samples** (i.e., accuracy-based samples consisting of fish and shellfish tissue homogenates spiked with compounds representative of the target analytes of interest), and/or **matrix spikes**. If possible, laboratory control samples should be SRMs or CRMs. **Note:** Only the analysis of fish or shellfish tissue SRMs or CRMs prepared from actual contaminated fish or shellfish tissue allows rigorous assessment of total method accuracy, including the accuracy with which an extraction or digestion procedure isolates the target analyte of interest from actual contaminated fish or shellfish. The analysis of spiked laboratory control samples or matrix spikes provides an assessment of method accuracy including sample handling and analysis procedures but does not allow rigorous assessment of the accuracy or efficiency of extraction or digestion procedures for actual contaminated fish or shellfish. Consequently, these samples should not be used for the primary assessment of total method accuracy unless SRMs or CRMs prepared from actual contaminated fish or shellfish tissue are not available.

The concentrations of target analytes in samples used to assess accuracy should fall within the range of concentrations found in the field samples; however, this may not always be possible for reference materials or laboratory control samples because of the limited number of these samples available in fish and shellfish tissue matrices (see Table 8-8). Matrix spike samples should be prepared using spike concentrations approximately equal to the concentrations found in the unspiked samples. An acceptable range of spike concentrations is 0.5 to 5 times

8. LABORATORY PROCEDURES II — SAMPLE ANALYSES

the expected sample concentrations (U.S. EPA, 1987e). Spikes should always be added to the sample homogenates prior to digestion or extraction.

Accuracy is calculated as percent recovery from the analysis of reference materials, or laboratory control samples, as follows:

$$\% \text{ Recovery} = 100 (M/T) \quad (8-6)$$

where

M = Measured value of the concentration of target analyte
T = "True" value of the concentration of target analyte.

Accuracy is calculated as percent recovery from the analysis of matrix spike samples as follows:

$$\% \text{ Recovery} = [(M_s - M_u)/T_s] \times 100 \quad (8-7)$$

where

M_s = Measured concentration of target analyte in the spiked sample
M_u = Measured concentration of target analyte in the unspiked sample
T_s = "True" concentration of target analyte added to the spiked sample.

When sample concentrations are less than the MDL, the value of one-half the MDL should be used as the concentration of the unspiked sample (M_u) in calculating spike recoveries.

8.3.3.4.1 Initial assessment of method accuracy

As discussed above, method accuracy should be assessed initially by analyzing appropriate SRMs or CRMs that are prepared from actual contaminated fish or shellfish tissue. The number of reference samples required to be analyzed for the initial assessment of method accuracy should be determined by each laboratory for each analytical procedure with concurrence of the program manager. If such SRMs or CRMs are not available, laboratory control samples or matrix spikes may be used for initial assessment of method accuracy.

8.3.3.4.2 Routine assessment of method accuracy

Laboratory control samples and matrix spikes should be analyzed for continuous assessment of accuracy during routine analyses. It is recommended that one laboratory control sample and one matrix spike sample be analyzed with every 20 samples or with each sample batch, whichever is more frequent (Puget Sound Estuary Program, 1990d, 1990e). Ideally, CRMs or SRMs should also be analyzed at this recommended frequency; however, limited availability and cost of these materials may make this impractical.

For organic compounds, isotopically labeled or surrogate recovery standards that must be added to each sample to monitor overall method performance also provide an assessment of method accuracy (see Section 8.3.3.7.1).

Percent recovery values for spiked samples must fall within established control limits (see Table 8-6). If the percent recovery falls outside the control limit, the analyses should be discontinued, appropriate corrective action taken, and, if possible, the samples associated with the spike reanalyzed. If reanalysis is not possible, all suspect data should be clearly identified.

Note: Reported data should not be corrected for percent recoveries. Recovery data should be reported for each sample to facilitate proper evaluation and use of analytical results.

Poor performance on the analysis of reference materials or poor spike recovery may be caused by inadequate mixing of the composite homogenate sample before aliquotting, inconsistent digestion or extraction procedures, matrix interferences, or instrumentation problems. If replicate analyses are acceptable (see Section 8.3.3.5), matrix interferences or loss of target analytes during sample preparation are indicated. To check for loss of target analytes during sample preparation, a step-by-step examination of the procedure using spiked blanks should be conducted. For example, to check for loss of metal target analytes during digestion, a postdigestion spike should be prepared and analyzed and the results compared with those from a predigestion spike. If the results are significantly different, the digestion technique should be modified to obtain acceptable recoveries. If there is no significant difference in the results of pre- and postdigestion spikes, the sample should be diluted by at least a factor of 5 and reanalyzed. If spike recovery is still poor, then the method of standard additions or use of a matrix modifier is indicated (U.S. EPA, 1987e).

8.3.3.5 Assessment of Method Precision—

The precision of each analytical method should be assessed and documented for each target analyte prior to the performance of routine analyses and on a regular basis during routine analysis.

Precision is defined as the agreement among a set of replicate measurements without assumption of knowledge of the true value. Method precision (i.e., total variability due to sample preparation and analysis) is estimated by means of the analyses of duplicate or replicate tissue homogenate samples containing concentrations of the target analyte of interest above the MDL. All samples used for assessment of total method precision must be carried through the complete analytical procedure, including extraction or digestion.

The most commonly used estimates of precision are the relative standard deviation or coefficient of variation (CV) for multiple samples, and the relative percent

difference (RPD) when only two samples are available. These are defined as follows:

$$\text{RSD} = \text{CV} = 100 S/\bar{x}_i \quad (8-8)$$

where

S = Standard deviation of the x_i measurements
 \bar{x}_i = Arithmetic mean of the x_i measurements

and

$$\text{RPD} = 100 \{(x_1 - x_2)/[(x_1 + x_2)/2]\} . \quad (8-9)$$

8.3.3.5.1 Initial assessment of method precision

Method precision should be assessed prior to routine sample analyses by analyzing replicate samples of the same reference materials, laboratory control samples, and/or matrix spikes that are used for initial assessment of method accuracy (see Section 8.3.3.4.1). The number of replicates required to be analyzed for the initial assessment of method precision should be determined by each laboratory for each analytical procedure with concurrence of the program manager. Because precision may be concentration-dependent, initial assessments of precision across the estimated working range should be obtained.

8.3.3.5.2 Routine assessment of method precision

Ongoing assessment of method precision during routine analysis should be performed by analyzing replicate aliquots of tissue homogenate samples taken prior to sample extraction or digestion (i.e., **laboratory replicates**) and **matrix spike replicates**. Matrix spike concentrations should approximate unspiked sample concentrations; an acceptable range for spike concentrations is 0.5 to 5 times the sample concentrations (U.S. EPA, 1987e).

For ongoing assessment of method precision, it is recommended that one laboratory duplicate and one matrix spike duplicate be analyzed with every 20 samples or with each sample batch, whichever is more frequent. In addition, it is recommended that a **laboratory control sample** be analyzed at the above frequency to allow an ongoing assessment of method performance, including an estimate of method precision over time. Specific procedures for estimating method precision by laboratory and/or matrix spike duplicates and laboratory control samples are given in ASTM (1983). This reference also includes procedures for estimating method precision from spike recoveries and for testing for significant change in method precision over time.

Precision estimates obtained from the analysis of laboratory duplicates, matrix spike duplicates, and repeated laboratory control sample analyses must fall within

specified control limits (see Table 8-6). If these values fall outside the control limits, the analyses should be discontinued, appropriate corrective action taken, and, if possible, the samples associated with the duplicates reanalyzed. If reanalysis is not possible, all suspect data should be clearly identified.

Unacceptable precision estimates derived from the analysis of duplicate or replicate samples may be caused by inadequate mixing of the sample before aliquotting; inconsistent contamination; inconsistent digestion, extraction, or cleanup procedures; or instrumentation problems (U.S. EPA, 1987e).

8.3.3.5.3 Routine assessment of analytical precision

The analysis of replicate aliquots of final sample extracts or digestates (**analytical replicates**) provides an estimate of analytical precision only; it does not provide an estimate of total method precision. For organic target analytes, analytical replicates may be included at the discretion of the program manager or laboratory supervisor. For the analysis of target metal analytes by graphite furnace atomic absorption spectrophotometry (GFAA) and cold vapor atomic absorption spectrophotometry (CVAA), it is recommended that duplicate injections of each sample be analyzed and the mean concentration be reported. The RPD should be within control limits established by the program manager or laboratory supervisor, or the sample should be reanalyzed (U.S. EPA, 1987e).

8.3.3.5.4 Assessment of overall variability

Estimates of the overall variability of target analyte concentrations in a sample fish or shellfish population and of the sampling and analysis procedures can be obtained by collecting and analyzing **field replicates**. Replicate field samples are optional in screening studies; however, if resources permit, it is recommended that duplicate samples be collected at 10 percent of the screening sites as a minimal QC check. Analysis of replicate field samples provides some degree of variability in that the samples themselves are typically collected and exposed to the same environmental conditions and contaminants. There are many points of potential dissimilarity between samples of the type described here; however, this variability is reduced when well-homogenized composite samples are analyzed. In intensive studies, replicate samples should be collected at each sampling site (see Section 6.1.2.7). Although the primary purpose of replicate field samples in intensive studies is to allow more reliable estimates of the magnitude of contamination, extreme variability in the results of these samples may also indicate that sampling and/or analysis procedures are not adequately controlled.

8.3.3.6 Routine Monitoring of Interferences and Contamination—

Because contamination can be a limiting factor in the reliable quantitation of target contaminants in tissue samples, the recommendations for proper materials and handling and cleaning procedures given in Sections 6.2.2 and 7.2 should be followed carefully to avoid contamination of samples in the field and laboratory.

8. LABORATORY PROCEDURES II — SAMPLE ANALYSES

Many metal contamination problems are due to airborne dust. High zinc blanks may result from airborne dust or galvanized iron, and high chromium and nickel blanks often indicate contamination from stainless steel. Mercury thermometers should not be used in the field because broken thermometers can be a source of significant mercury contamination. In the laboratory, samples to be analyzed for mercury should be isolated from materials and equipment (e.g., polarographs) that are potential sources of mercury contamination. Cigarette smoke is a source of cadmium. Consequently, care should be taken to avoid the presence of cigarette smoke during the collection, handling, processing, and analysis of samples for cadmium. In organic analyses, phthalates, methylene chloride, and toluene are common laboratory contaminants that are often detected in blanks at concentrations above the MDL (U.S. EPA, 1987e).

Cross-contamination between samples should be avoided during all steps of analysis of organic contaminants by GC-based methods. Injection micro-syringes must be cleaned thoroughly between uses. If separate syringes are used for the injection of solutions, possible differences in syringe volumes should be assessed and, if present, corrected for. Particular care should be taken to avoid carryover when high- and low-level samples are analyzed sequentially. Analysis of an appropriate method blank may be required following the analysis of a high-level sample to assess carryover (U.S. EPA, 1987e).

To monitor for interferences and contamination, the following blank samples should be analyzed prior to beginning sample collection and analyses and on a routine basis throughout each study (U.S. EPA, 1987e):

- **Field blanks** are rinsates of empty field sample containers (i.e., aluminum foil packets and plastic bags) that are prepared, shipped, and stored as actual field samples. Field blanks should be analyzed to evaluate field sample packaging materials as sources of contamination. Each rinsate should be collected and the volume recorded. The rinsate should be analyzed for target analytes of interest and the total amount of target analyte in the rinsate recorded. It is recommended that one field blank be analyzed with every 20 samples or with each batch of samples, whichever is more frequent.
- **Processing blanks** are rinsates of utensils and equipment used for dissecting and homogenizing fish and shellfish. Processing blanks should be analyzed, using the procedure described above for field blanks, to evaluate the efficacy of the cleaning procedures used between samples. It is recommended that processing blanks be analyzed at least once at the beginning of a study and preferably once with each batch of 20 or fewer samples.
- **Bottle blanks** are rinsates of empty bottles used to store and ship sample homogenates. Bottle blanks should be collected after the bottles are cleaned prior to use for storage or shipment of homogenates. They should be analyzed, using the procedure described above for field blanks, to evaluate their potential as sources of contamination. It is recommended that one bottle

8. LABORATORY PROCEDURES II — SAMPLE ANALYSES

blank be analyzed for each lot of bottles or with each batch of 20 or fewer samples, whichever is more frequent.

- **Method blanks** are samples of extraction or digestion solvents that are carried through the complete analytical procedure, including extraction or digestion; they are also referred to as **procedural blanks**. Method blanks should be analyzed to evaluate contaminants resulting from the total analytical method (e.g., contaminated glassware, reagents, solvents, column packing materials, processing equipment). It is recommended that one method blank be analyzed with every 20 samples or with each batch of samples, whichever is more frequent.
- **Reagent blanks** are samples of reagents used in the analytical procedure. It is recommended that each lot of analytical reagents be analyzed for target analytes of interest prior to use to prevent a potentially serious source of contamination. For organic analyses, each lot of alumina, silica gel, sodium sulfate, or Florasil used in extract drying and cleanup should also be analyzed for target analyte contamination and cleaned as necessary. Surrogate mixtures used in the analysis of organic target analytes have also been found to contain contaminants and the absence of interfering impurities should be verified prior to use (U.S. EPA, 1987e).

Because the contamination in a blank sample may not always translate into contamination of the tissue samples, analysts and program managers must use their best professional judgment when interpreting blank analysis data. Ideally, there should be no detectable concentration of any target analyte in any blank sample (i.e., the concentration of target analytes in all blanks should be less than the MDL). However, program managers may set higher control limits (e.g., \leq MQL) depending on overall data quality requirements of the monitoring program. If the concentration of a target analyte in any blank is greater than the established control limit, all steps in the relevant sample handling, processing, and analysis procedures should be reviewed to identify the source of contamination and appropriate corrective action should be taken. If there is sufficient sample material, all samples associated with the unacceptable blank should be reanalyzed. If reanalysis is not possible, all suspect data should be identified clearly.

Note: Analytical data should not be corrected for blank contamination by the reporting laboratory; however, blank concentrations should always be reported with each associated sample value.

8.3.3.7 Special QA and QC Procedures for the Analysis of Organic Target Analytes—

8.3.3.7.1 Routine monitoring of method performance

To account for losses during sample preparation (i.e., extraction, cleanup) and to monitor overall method performance, a standard compound that has chemical and physical properties as similar as possible to those of the target analyte of interest should be added to each sample prior to extraction and to each calibration standard. Such compounds may be termed **surrogate recovery standards**. A stable, **isotopically labeled analog of the target analyte** is an ideal surrogate recovery standard for GC/MS analysis.

If resources permit, an isotope dilution GC/MS technique such as EPA Method 1625 (40 CFR 136, Appendix A) is recommended for the analysis of organic target analytes for which isotopically labeled analogs are available. In this technique, RRFs used for quantitation may be calculated from measured isotope ratios in calibration standards and not from instrument internal standards. However, an instrument internal standard still must be added to the final sample extract prior to analysis to determine the percent recoveries of isotopically labeled recovery standards added prior to extraction. Thus, in isotope dilution methods, instrument internal standards may be used only for QC purposes (i.e., to assess the quality of data) and not to quantify analytes. Control limits for the percent recovery of each isotopically labeled recovery standard should be established by the program manager, consistent with program data quality requirements. Control limits for percent recovery and recommended corrective actions given in EPA Method 1625 (40 CFR 136, Appendix A) should be used as guidance.

If isotopically labeled analogs of target analytes are not available or if the isotope dilution technique cannot be used (e.g., for chlorinated pesticides and PCBs analyzed by GC/ECD), other surrogate compounds should be added as recovery standards to each sample prior to extraction and to each calibration standard. These surrogate recovery standards should have chemical and physical properties similar to the target analytes of interest and should not be expected to be present in the original samples. Recommended surrogate recovery standards are included in the methods referenced in Table 8-2 and in EMMI (U.S. EPA, 1991f).

Samples to which surrogate recovery standards have been added are termed **surrogate spikes**. The percent recovery of each surrogate spike (% R_s) should be determined for all samples as follows:

$$\% R_s = 100 (C_m/C_a) \quad (8-10)$$

where

- % R_s = Surrogate spike percent recovery
- C_m = Measured concentration of surrogate recovery standard

C_a = Actual concentration of surrogate recovery standard added to the sample.

Control limits for the percent recovery of each surrogate spike should be established by the program manager consistent with program data quality requirements. The control limits in the most recent EPA CLP methods (U.S. EPA, 1991c) are recommended for evaluating surrogate recoveries.

Note: Reported data should not be corrected for percent recoveries of surrogate recovery standards. Recovery data should be reported for each sample to facilitate proper evaluation and use of the analytical results.

8.3.3.7.2 Other performance evaluation procedures

The following additional procedures are required to evaluate the performance of GC-based analytical systems prior to the routine analysis of field samples (U.S. EPA, 1989c; U.S. EPA, 1991c). It is the responsibility of each program manager to determine specific evaluation procedures and control limits appropriate for their data quality requirements.

Evaluation of the GC system

GC system performance should be evaluated by determining the number of theoretical plates of resolution and the relative retention times of the internal standards.

Column Resolution: The number of theoretical plates of resolution, N , should be determined at the time the calibration curve is generated (using chrysene- d_{10}) and monitored with each sample set. The value of N should not decrease by more than 20 percent during an analysis session. The equation for N is given as follows:

$$N = 16 (RT/W)^2 \quad (8-11)$$

where

RT = Retention time of chrysene- d_{10} (s)

W = Peak width of chrysene- d_{10} (s).

Relative Retention Time: Relative retention times of the internal standards should not deviate by more than ± 3 percent from the values calculated at the time the calibration curve was generated.

If the column resolution or relative retention times are not within the specified control limits, appropriate corrective action (e.g., adjust GC parameters, flush GC column, replace GC column) should be taken.

Evaluation of the MS system

The performance of the mass spectrometer should be evaluated for sensitivity and spectral quality.

Sensitivity: The signal-to-noise value should be at least 3.0 or greater for m/z 198 from an injection of 10 ng decafluorotriphenylphosphine (DFTPP).

Spectral Quality: The intensity of ions in the spectrum of a 50-ng injection of DFTPP should meet the following criteria (U.S. EPA, 1991c):

<u>m/z</u>	<u>Criteria</u>
51	30-80% mass 198
68	<2% mass 69
69	present
70	<2% mass 69
127	25-75% mass 198
197	<1% mass 198
198	base peak, 100% relative abundance
199	5-9% mass 198
275	10-30% mass 198
365	>0.75% mass 198
441	present and <mass 443
442	40-110% mass 198
443	15-24% mass 442

If the control limits for sensitivity or spectral quality are not met, appropriate corrective action (e.g., clean MS, retune MS) should be taken.

Evaluation of cleanup columns

Because the fatty content of many tissue samples may overload the cleanup columns, these columns should be calibrated and monitored regularly to ensure that target analytes are consistently collected in the proper fraction. Gel permeation columns should be monitored by visual inspection (for column discoloration, leaks, cracks, etc.) and by measurement of flow rate, column resolution, collection cycle, and method blanks (see Section 8.3.3.6). Silica gel columns should be evaluated by their ability to resolve cholesterol from a selected target analyte.

8.3.3.8 External QA Assessment of Analytical Performance—

Participation in an external QA program by all analytical laboratories in state fish and shellfish consumption advisory programs is strongly recommended for several reasons:

- To demonstrate laboratory capability prior to conducting routine analyses of field samples
- To provide an independent ongoing assessment of each laboratory's capability to perform the required analyses
- To enhance the comparability of data between states and Regions.

Two types of external QA programs are recommended: **round-robin interlaboratory comparisons** (often referred to as **interlaboratory calibration programs**) and **split-sample interlaboratory comparisons**.

8.3.3.8.1 Round-robin analysis interlaboratory comparison program

At present, the only external round-robin QA program available for analytical laboratories conducting fish and shellfish tissue analyses for environmental pollutants is administered by NOAA in conjunction with its National Status and Trends (NS&T) Program (Cantillo, 1991). This QA program has been designed to ensure proper documentation of sampling and analysis procedures and to evaluate both the individual and collective performance of participating laboratories. Recently, NOAA and EPA have agreed to conduct the NS&T Program and the EMAP-NC Program as a coordinated effort. As a result, EMAP-NC now cosponsors and cooperatively funds the NS&T QA Program, and the interlaboratory comparison exercises include all EMAP-NC laboratories (U.S. EPA, 1991e).

Note: Participation in the NS&T QA program by all laboratories performing chemical analyses for state fish and shellfish contaminant monitoring programs is recommended to enhance the credibility and comparability of analytical data among the various laboratories and programs.

Each laboratory participating in the NS&T QA program is required to demonstrate its analytic capability prior to the analysis of field samples by the blind analysis of a fish and shellfish tissue sample that is uncompromised, homogeneous, and contains the target analytes of interest at concentrations of interest. A laboratory's performance generally will be considered acceptable if its reported results are within ± 30 percent (for organics) and ± 15 percent (for metals) of the actual or certified concentration of each target analyte in the sample (U.S. EPA, 1991e). If any of the results exceed these control limits, the laboratory will be required to repeat the analysis until all reported results are within the control limits. Routine analysis of field samples will not be allowed until initial demonstration of laboratory capability is acceptable.

Following the initial demonstration of laboratory capability, each participating laboratory is required to participate in one intercomparison exercise per year as a continuing check on performance. This intercomparison exercise includes both organic and inorganic (i.e., trace metals) environmental and standard reference

samples. The organic analytical intercomparison program is coordinated by NIST, and the inorganic analytical intercomparison program is coordinated by the NRCC. Sample types and matrices vary yearly. Performance evaluation samples used in the past have included accuracy-based solutions, sample extracts, and representative matrices (e.g., tissue or sediment samples). Laboratories are required to analyze the performance evaluation samples blind and to submit their results to NIST or NRCC, as instructed. Individual laboratory performance is evaluated against the consensus values (i.e., grand means) of the results reported by all participating laboratories. Laboratories that fail to achieve acceptable performance must take appropriate corrective action. NIST and NRCC will provide technical assistance to participating laboratories that have problems with the intercomparison analyses. At the end of each calendar year, the results of the intercomparison exercises are reviewed at a workshop sponsored by NIST and NRCC. Representatives from each laboratory are encouraged to participate in these workshops, which provide an opportunity for discussion of analytical problems encountered in the intercomparison exercises.

Note: Nonprofit laboratories (e.g., EPA and other federal laboratories, state, municipal, and nonprofit university laboratories) may participate in the NS&T QA program at no cost on a space-available basis. The cost of participation in the NIST Intercomparison Exercise Program for Organic Contaminants in the Marine Environment is \$2,500 for private laboratories within and outside the United States. This cost covers samples for one exercise per year. Samples may be obtained directly from NIST by contacting Ms. Michele Shantz, NIST, 100 Bureau Drive, Stop 8392, Gaithersburg, MD 20899-8392; Tel: 301-975-3106, FAX: 301-997-0685. Trace inorganic samples are available directly from NRCC by contacting Mr. Scott Willis, NRCC, Ottawa, Ontario, Canada K1A029, e-mail: scott.willie@NRC.CA, Tel: 613-993-4969.

To obtain additional information about participation in the NS&T QA program, contact Dr. Adriana Cantillo, QA Manager, NOAA/National Status and Trends Program, NYSCI1, 1305 East West Highway, Silver Spring, MD 20910; Tel: 301-713-3028, ext. 147, FAX: 301-713-4388.

8.3.3.8.2 Split sample analysis interlaboratory comparison programs

Another useful external QA procedure for assessing interlaboratory comparability of analytical data is a split-sample analysis program in which a percentage (usually 5 to 10 percent) of all samples analyzed by each state or Region are divided and distributed for analyses among laboratories from other states or Regions. Because actual samples are used in a split-sample analysis program, the results of the split-sample analyses provide a more direct assessment of the comparability of the reported results from different states or Regions.

The NS&T QA program does not include an interlaboratory split-sample analysis program. However, it is recommended that split-sample analysis programs be established by states and/or Regions that routinely share results.

8.4 Documentation and Reporting of Data

The results of all chemical analyses must be documented adequately and reported properly to ensure the correct evaluation and interpretation of the data.

8.4.1 Analytical Data Reports

The documentation of analytical data for each sample should include, at a minimum, the following information:

- Study identification (e.g., project number, title, phase)
- Description of the procedure used, including documentation and justification of any deviations from the standard procedure
- Method detection and quantitation limits for each target analyte
- Method accuracy and precision for each target analyte
- Discussion of any analytical problems and corrective action taken
- Sample identification number
- Sample weight (wet weight)
- Final dilution volume/extract volume
- Date(s) of analysis
- Identification of analyst
- Identification of instrument used (manufacturer, model number, serial number, location)
- Summary calibration data, including identification of calibration materials, dates of calibration and calibration checks, and calibration range(s); for GC/MS analyses, include DFTPP spectra and quantitation report
- Reconstructed ion chromatograms for each sample analyzed by GC/MS
- Mass spectra of detected target compounds for each sample analyzed by GC/MS
- Chromatograms for each sample analyzed by GC/ECD and/or GC/FID
- Raw data quantitation reports for each sample

8. LABORATORY PROCEDURES II — SAMPLE ANALYSES

- Description of all QC samples associated with each sample (e.g., reference materials, field blanks, rinsate blanks, method blanks, duplicate or replicate samples, spiked samples, laboratory control samples) and results of all QC analyses. QC reports should include quantitation of all target analytes in each blank, recovery assessments for all spiked samples, and replicate sample summaries. Laboratories should report all surrogate and matrix spike recovery data for each sample; the range of recoveries should be included in any reports using these data.
- Analyte concentrations with reporting units identified (as ppm or ppb wet weight, to two significant figures unless otherwise justified). **Note:** Reported data should not be recovery- or blank-corrected.
- Lipid content (as percent wet weight)
- Specification of all tentatively identified compounds (if requested) and any quantitation data.
- Data qualifications (including qualification codes and their definitions, if applicable, and a summary of data limitations).

To ensure completeness and consistency of reported data, standard forms should be developed and used by each laboratory for recording and reporting data from each analytical method. Standard data forms used in the EPA Contract Laboratory Program (U.S. EPA, 1991b, 1991c) may serve as useful examples for analytical laboratories.

All analytical data should be reviewed thoroughly by the analytical laboratory supervisor and, ideally, by a qualified chemist who is independent of the laboratory. In some cases, the analytical laboratory supervisor may conduct the full data review, with a more limited QA review provided by an independent chemist. The purpose of the data review is to evaluate the data relative to data quality specifications (e.g., detection and quantitation limits, precision, accuracy) and other performance criteria established in the Work/QA Project Plan. In many instances, it may be necessary to qualify reported data values; qualifiers should always be defined clearly in the data report. Recent guidance on the documentation and evaluation of trace metals data collected for Clean Water Act compliance monitoring (U.S. EPA, 1995h) provides additional useful information on data review procedures.

8.4.2 Summary Reports

Summaries of study data should be prepared for each target species at each sampling site. Specific recommendations for reporting data for screening and intensive studies are given in Section 9.2.

SECTION 9

DATA ANALYSIS AND REPORTING

This section provides guidance on (1) analysis of laboratory data for both screening and intensive studies that should be included in state data reports, (2) data reporting requirements for both state-conducted screening and intensive studies, and (3) data reporting requirements for a national data repository for state-collected fish tissue data housed within the National Listing of Fish and Wildlife Advisories (NLFWA) database.

All data analysis and reporting procedures should be documented fully as part of the Work/QA Project Plan for each study, prior to initiating the study (see Appendix I). All routine data analysis and reporting procedures should be described in standard operating procedures. In particular, the procedures to be used to determine if the concentration of a target analyte in fish or shellfish tissue differs significantly from the selected screening value must be clearly documented.

9.1 DATA ANALYSIS

9.1.1 Screening Studies

The primary objective of **Tier 1** screening studies is to assist states in identifying potentially contaminated harvest areas where further investigation of fish and shellfish contamination may be warranted. The criteria used to determine whether the measured target analyte concentration in a fish or shellfish tissue composite sample is different from the SV (greater than or less than) should be clearly documented. If a reported target analyte concentration exceeds the SV in the screening study, a state should initiate a **Tier 2, Phase I**, intensive study (see Section 6.1.2.1) to verify the level of contamination in the target species. Because of resource limitations, some states may choose to conduct a risk assessment using screening study data; however, this approach is not recommended because a valid statistical analysis cannot be performed on a single composite sample. If a reported analyte concentration is close to the SV but does not exceed the SV, the state should reexamine historic data on water, sediment, and fish tissue contamination at the site and evaluate data on laboratory performance. If these data indicate that further examination of the site is warranted, the state should initiate a **Tier 2, Phase I**, intensive study to verify the magnitude of the contamination.

Because replicate composite samples are not required as part of a screening study, estimating the variability of the composite target analyte concentration at any site is precluded. The following procedure is recommended for use by states for analysis of the individual target analyte concentration for each composite sample from reported laboratory data (see Section 8.3.3.3)

- A datum reported below the method detection limit, including a datum reported as not detected (i.e., ND, no observed response) should be assigned a value of one-half the MDL or zero.
- A datum reported between the MDL and the method quantitation limit should be assigned a value of the MDL plus one-half the difference between the MQL and the MDL.
- A datum reported at or above the MQL should be used as reported.

This approach is similar to that published in 40 CFR Parts 122, 123, 131, and 132—Proposed Water Quality Guidance for the Great Lakes System.

If resources permit and replicate composite samples are collected at a suspected site of contamination, then a state may conduct a statistical analysis of differences between the mean target analyte concentration and the SV, as described in Section 9.1.2.

9.1.2 Intensive Studies

The primary objectives of **Tier 2** intensive studies are to confirm the findings of the screening study by assessing the magnitude and geographic extent of the contamination in various size classes of selected target species. The EPA Office of Water recommends that states collect replicate composite samples of three size classes of each target species in the study area to verify whether the mean target analyte concentration of replicate composite samples for any size class exceeds the SV for any target analyte identified in the screening study. The statistical approach for this comparison is described in Section 6.1.2.7.

The following procedure is recommended for use by states in calculating the mean arithmetic target analyte concentration from reported laboratory data (see Section 8.3.3.3.3).

- Data reported below the MDL, including data reported as not detected (i.e., ND, no observed response) should be assigned a value of one-half the MDL.
- Data reported between the MDL and the MQL should be assigned a value of the MDL plus one-half the difference between the MQL and the MDL.
- Data reported at or above the MQL should be used as reported.

This approach is similar to that published in 40 CFR Parts 122, 123, 131, and 132—Proposed Water Quality Guidance for the Great Lakes System.

Secondary objectives that may be assessed as part of **Tier 2** intensive studies

can include defining the geographical region where fish contaminant concentrations exceed screening values; identifying geographical distribution of contaminant concentrations; and, in conjunction with historical data or future data collection, assessing changes in fish contaminant concentrations over time. The statistical considerations involved in comparing fish contaminant levels measured at different locations or times are discussed in Appendix N.

State staff should consult a statistician in interpreting intensive study tissue residue results to determine the need for additional monitoring, risk assessment, and issuance of a fish or shellfish consumption advisory. Additional information on risk assessment, risk management, and risk communication procedures will be provided in later volumes in this guidance series (see Section 1.4).

9.2 DATA REPORTING

9.2.1 State Data Reports

State data reports should be prepared by the fish contaminant monitoring program manager responsible for designing the screening and intensive studies. Summaries of **Tier 1** screening study data should be prepared for each target species sampled at each screening site. For **Tier 2** intensive studies (**Phase I** and **Phase II**), data reports should be prepared for each target species (by size class, as appropriate) at each sampling site within the waterbody under investigation (see Section 6.1.2). Screening and intensive study data reports should include, at a minimum, the information shown in Figure 9-1.

9.2.2 Reports to the National Fish Tissue Residue Data Repository (NFTRDR)

The EPA Office of Science and Technology within the Office of Water has established the NFTRDR, which is housed within the NLFWA database. This repository is a collection of fish and shellfish contaminant monitoring data gathered by various state, federal, and local agencies for advisory purposes. The objectives of the repository are to:

- Facilitate the exchange of fish and shellfish contaminant monitoring data nationally by improving the comparability and integrity of state data
- Encourage greater cooperation among regional and state fish advisory programs
- Assist states in their fish tissue data collection efforts by providing ongoing technical assistance.

The NLFWA database now contains a facility for storing fish tissue residue data as well as for documenting and mapping active and rescinded fish consumption advisories. Since 1996, a stand-alone version of the NLFWA database has been available for Internet downloads. Internet WEB-based tools have recently been developed to support queries and interactive mapping of both the general advisory information as well as fish tissue residue data. Internet-based tools are also being

<ul style="list-style-type: none"> • Study identification (e.g., project number, title, and study type) • Program manager • Sampling site name • Latitude (decimal degrees preferred) • Longitude (decimal degrees preferred) • Type of waterbody (lake, river, estuary, etc.) • Name of waterbody • Sampling date (e.g., YYYYMMDD, Year 2000 compliant format) • Sampling time (e.g., HH, MM in a 24-h format) • Sampling gear type used (e.g., dredge, seine, trawl, gill net) • Sampling depth (feet or meters) • Standard common name of target species (preferably name sanctioned by American Fisheries Society for inland waters or by NOAA for coastal waters) • Composite sample numbers • Number of individuals in each composite sample • Number of replicate composite samples • Predominant characteristics of specimens used in each composite sample <ul style="list-style-type: none"> - Predominant life stage of individuals in composite - Predominant sex of individuals in composite (if applicable) - Average age of individuals in composite (if applicable) - Average body length (cm) - Description of edible portion (tissue type) • Analytical methods used (including method for lipid analysis) • Method detection and quantitation limits for each target analyte analyzed 	<ul style="list-style-type: none"> • Sample cleanup procedures (e.g., additional steps taken to further purify the sample extracts or digestates) • Data qualifiers (e.g., additional qualifying information about the measurement) • Percent lipid (wet weight basis) in each composite sample • For each target analyte in each composite sample: <ul style="list-style-type: none"> - Total wet weight of composite sample (g) used in analysis - Measured concentration (wet weight basis) as reported by the laboratory (see Section 8.3.3.3.3) - Units of measurement for target analyte concentration (e.g., ppm) - Evaluation of laboratory performance (i.e., description of all QA and QC samples associated with the sample(s) and results of all QA and QC analyses) • In screening studies with only one composite sample for each target species, the state should provide for each target analyte a comparison of reported concentration with selected SV (see Section 4 tables) and indication of whether SV was exceeded for recreational or subsistence fishers (see Section 9.1.1). • In intensive studies, for each target analyte in each set of replicate composite samples, the state should provide <ul style="list-style-type: none"> - Range of target analyte concentrations for each set of replicate composite samples - Mean (arithmetic) target analyte concentration for each set of replicate composite samples (see Section 9.1.2) - Standard deviation of mean target analyte concentration - Comparison of target analyte arithmetic mean concentration with selected SV (see Section 5) and indication of whether SV was exceeded for recreational or subsistence fishers
--	--

Figure 9-1. Recommended data reporting requirements for screening and intensive studies.

developed as a way for state agencies to add fish advisory and contaminant monitoring data to the NLFWA database and may be developed to perform some types of standard data analysis on the fish tissue residue data.

EPA has recently developed an Internet-based data entry facility for the NLFWA using some of the data elements included in Figure 9-1. This Internet-based data entry facility is housed within the EPA's NLFWA database and allows states to archive fish advisory information as well as fish tissue residue data generated through their fish contaminant monitoring programs. States may prepare their own data tables and arrange to transfer these to EPA to be formatted and reviewed before entry into the repository. The information in the NFTRDR can be organized into three different tables (STATIONS, SAMPLES, and RESULTS tables) using such readily available PC relational database packages as ACCESS (Figure 9-2). If states submit their monitoring data in other file formats (e.g., spreadsheet files or ASCII files exported from other in-house database systems), a short data dictionary (metadata) file should be included (ASCII, Wordperfect, or WORD format) clearly documenting the meaning of all data fields and any codes, abbreviations, or measurement units used in the files.

State, regional, and local agency staff may obtain further information on the new Internet WEB-based database EPA now has available by contacting:

U.S. Environmental Protection Agency
Office of Science and Technology
National Fish and Wildlife Contamination Program-4305
1200 Pennsylvania Avenue, NW
Washington, DC 20460
PHONE: 202-260-7301
FAX: 202-260-9830

Jeffrey D. Bigler
U.S. Environmental Protection Agency-4305
1200 Pennsylvania Avenue, NW
Washington, DC 20460
PHONE: 202-260-1305
E-MAIL: bigler.jeff@epa.gov

Fish Tissue Chemical Residue Data Tables: STATIONS, SAMPLES and RESULTS	
The STATIONS table includes basic locational data.	
Field name	Field description
STATION_ID	Waterbody, Station or Monitoring Site Identifier. This field becomes a database key field. Each record must have a unique STATION_ID.
STATE	State 2-character postal code abbreviation.
WATERBODY (or SITENAME)	A short caption to identify the waterbody or sampling station.
LOCATION	Additional descriptive information on the waterbody or station location.
ADVNUM	If the waterbody or site is associated with an advisory (active or rescinded), include the number assigned to this advisory in the current National Listing of Fish and Wildlife Advisories (NLFWA) database.
COUNTY	County name.
LAT	Station latitude. A format in decimal degrees is preferred.
LNG	Station longitude. A format in decimal degrees is preferred.
The SAMPLES table includes data on the type of tissue sample collected.	
Field name	Field description
SAMPLE_ID	An identifier to each specific fish tissue sample from a waterbody or station. This is used as a database key, so each record must have a unique SAMPLE_ID
STATION_ID	Waterbody, Station or Monitoring Site Identifier as defined in the STATIONS table.
SAMPLE_DATE	The date the sample was collected in the field. Give date in a Year 2000 compliant format (YYYYMMDD).
FISH_SPECIES	Fish species names. Standard English common names as established by the American Fisheries Society for inland waters or NOAA for coastal water are preferred.
SAMPLE_TYPE	How the sample was prepared (e.g., fillet with skin-on or skin-off, whole fish). In the NUMBER_OF_FISH field below, multiple fish in a sample indicate a composite sample.
LENGTH	The length of the sample fish. For composites, an average length should be given.
LENGTH_UNIT	Length units of fish (cm or inches)
WEIGHT	Specimen or composite weight used for residue analysis.
WEIGHT_UNIT	Weight units (usually in grams).
LIPID	Percent extractable lipids.
NUMBER_OF_FISH	Number of fish (specimens) in sample. Number greater than a value of 1 indicates a composite sample.
The RESULTS table includes chemical-specific tissue sample concentrations.	
Field name	Field description
SAMPLE_ID	An identifier to each specific fish tissue sample from a waterbody or station. This is used as a database key, so each record must have a unique SAMPLE_ID
PARAMETER	Chemical name. File should specify all acronyms or abbreviations used.
DETECTION_INFO	A caption to document detection limit information (e.g., "less than detection limit").
RESULT	A number representing the concentration of a chemical (or the detection limit).
RESULT_UNIT	Units associated with concentration (e.g., "ppm").

Figure 9-2. Key information fields for the National Fish Tissue Residue Data Repository.

SECTION 10

LITERATURE CITED

- Abbott, R.T. 1974. *American Seashells—The Marine Molluscs of the Atlantic and Pacific Coasts of North America*. 2nd Edition. Van Nostrand Reinhold Company, New York, NY.
- Agocs, M.M., R.A. Etzel, R.G. Parrish, D.C. Paschal, P.R. Campagna, D.S. Cohon, E.M. Kilbourne, and J.L. Hesse. 1990. Mercury exposure from interior latex paint. *New England Journal of Medicine* 323(16):1096-1101.
- Amato, J.R., D.I. Mount, E.J., Durhan, et al. 1992. An example of the identification of diazinon as a primary toxicant in an effluent. *Environ. Toxic. Chem.* 11:209-216.
- Anderson, R.O., and S.J. Gutreuter. 1983. Length, weight, and associated structural indices. pp. 283-300. In: *Fisheries Techniques*. L.A. Nielson and D.L. Johnson (eds). American Fisheries Society, Bethesda, MD.
- Ashley, L.M. 1962. *Laboratory Anatomy of the Turtle*. W.C. Brown Company, Dubuque, IA.
- ASTER, 1995. Ecotoxicity profile: Arsenic. Office of Research and Development, National Health and Environmental Effects Research Laboratory, U.S. Environmental Protection Agency, Duluth, MN.
- ASTM (American Society for Testing and Materials). 1976. *ASTM Manual on Presentation of Data and Control Chart Analysis*. ASTM STP-ILSD. Committee E-11, Philadelphia, PA.
- ASTM (American Society for Testing and Materials). 1983. *Standard Practice for Intralaboratory Quality Control Procedures and a Discussion on Reporting Low-Level Data*. D4210-83. Committee D-19, Philadelphia, PA.
- ATSDR (Agency for Toxic Substances and Disease Registry). 1991. *Toxicological Profile for Dieldrin*. U.S. Department of Health and Human Services, Public Health Service, Atlanta, GA.
- ATSDR (Agency for Toxic Substances and Disease Registry). 1992. *Toxicological Profile for Tin and Tin Compounds*. U. S. Department of Health and Human Services, Public Health Service, Atlanta, GA.

- ATSDR (Agency for Toxic Substances and Disease Registry). 1995. *Toxicological Profile for Polycyclic Aromatic Hydrocarbons*. U.S. Department of Health and Human Services, Public Health Service, Atlanta, GA.
- ATSDR (Agency for Toxic Substances and Disease Registry). 1996. *Toxicological Profile for Toxaphene*. U.S. Department of Health and Human Services, Public Health Service, Atlanta, GA.
- ATSDR (Agency for Toxic Substances and Disease Registry). 1997. *Toxicological Profile for Lead*. U.S. Department of Health and Human Services, Public Health Service, Atlanta, GA.
- ATSDR (Agency for Toxic Substances and Disease Registry). 1998a. *Toxicological Profile for Arsenic*. U.S. Department of Health and Human Services, Public Health Service, Atlanta, GA.
- ATSDR (Agency for Toxic Substances and Disease Registry). 1998b. *Toxicological Profile for Selected PCBs*. U.S. Department of Health and Human Services, Public Health Service, Atlanta, GA.
- ATSDR (Agency for Toxic Substances and Disease Registry). 1998c. *Toxicological Profile for Endosulfan (Draft)*. U.S. Department of Health and Human Services, Public Health Service, Atlanta, GA.
- Bache, C.A., W.H. Gutenmann, and D.J. Lisk. 1971. Residues of total mercury and methylmercuric salts in lake trout as a function of age. *Science* 172:951.
- Bahnick, D., C. Sauer, B. Butterworth, and D.W. Kuehl. 1994. A national study of mercury contamination of fish. IV: Analytical methods and results. *Chemosphere* 29(3):537-546.
- Ballschmitter, K., and M. Zell. 1980. Analysis of polychlorinated biphenyls (PCBs) by glass capillary gas chromatography, composition of technical Aroclor- and Clophen-PCB mixtures. *Fresenius Anal. Chem.* 302:20-31.
- Barnes, D.G., and J.S. Bellin. 1989. *Interim Procedures for Estimating Risks Associated with Exposures to Mixtures of Chlorinated Dibenzo-p-Dioxins and -Dibenzofurans (CDDs and CDFs)*. Risk Assessment Forum, U.S. Environmental Protection Agency, Washington, DC.
- Barnes, D.G., and M. Dourson. 1988. Reference dose (RfD): Description and use in health risk assessments. *Regulatory Toxicology and Pharmacology*. 8:471-486.
- Barron, M.G., S. M. Plakas, and P.C. Wilga. 1991. Chlorpyrifos pharmacokinetics and metabolism following intravascular and dietary administration in channel catfish. *Toxicol. Appl. Pharmacol.* 108:474-482.

- Battelle Memorial Institute. 1975. *Environmental Impact Monitoring of Nuclear Power Plants: Source Book of Monitoring Methods*. Volume 2. Atomic Industrial Forum, Inc., Washington, DC.
- Battelle Memorial Institute. 1989. *Work/Quality Assurance Project Plan for the National Status and Trends Mussel Watch Program. Collection of Bivalve Molluscs and Superficial Sediments for Coastal U.S. Atlantic and Pacific Locations and Analyses for Organic Chemicals and Toxic Trace Elements*. Prepared for U.S. Department of Commerce, National Oceanic and Atmospheric Administration by Battelle Ocean Sciences, Duxbury, MA.
- Battelle New England Marine Research Laboratory. 1986. *Phase II Mussel Watch Field Manual*. NOAA Contract No. 50-DGNC-5-0263. Prepared for U.S. Department of Commerce, National Oceanic and Atmospheric Administration by Battelle Ocean Sciences, Duxbury, MA.
- Beauchemin, D., K.W.M. Siu, J.W. McLaren, and S.S. Berman. 1989. Determination of arsenic species by high-performance liquid chromatography-inductively coupled plasma mass spectrometry. *Journal of Analytical Atomic Spectrometry* 4 (3):285-289.
- Benkert, K.A. 1992. *Contaminant Assessment of Biota and Sediments in the Albemarle-Pamlico Region*. Contract 40190-0-6823. Prepared for U.S. Fish and Wildlife Service, Raleigh, NC.
- Bennett, G.W. 1970. *Management of Lakes and Ponds*. Van Nostrand Reinhold Company, New York, NY.
- Besser, J.M., J.P. Giesy, R.W. Brown, J.M. Buell, and G.A. Dawson. 1996. Selenium bioaccumulation and hazards in a fish community affected by coal fly ash effluent. *Ecotox. and Environ. Safety* 35:7-15.
- Bishop, C.A., P. Ng, R.J. Norstrom, R.J. Brooks, and K. E. Pettit. 1996. Temporal and geographic variation of organochlorine residues in eggs of the common snapping turtle (*Chelydra serpentina serpentina*) (1981-1991) and comparisons to trends in the herring gull (*Larus argentatus*) in the Great Lakes basin in Ontario, Canada. *Arch. Environ. Contam. Toxicol.* 31: 512-524.
- Bligh, E.G., and W.J. Dyer. 1959. A rapid method of total lipid extraction and purification. *Can. J. Biochem. Physiol.* 37:911-917.
- Bloom, N.S. 1992. On the chemical form of mercury in edible fish and marine invertebrate tissue. *Can. J. Fish. Aquat. Sci.* 49(5):1010-1017.

- Bonin, J., L. DesGranges, C.A. Bishop, J. Rodrigue, A. Gendron, and J.E. Elliot. 1995. Comparative study of contaminants in the mudpuppy (*Amphibia*) and the common snapping turtle (*Reptilia*), St. Lawrence River, Canada. *Arch. Environ. Contam. Toxicol.* 28:184-194.
- Borneff, J., and H. Kunte. 1965. Carcinogenic substances in water and soil. Part XVII. Concerning the origin and estimation of the polycyclic aromatic hydrocarbons in water. *Arch. Hyg. (Berlin)* 149:226-243.
- Bos, P.M.J., J.M. Cardinaals, W.M.F. Jongen, and P. Hagel. 1985. Genotoxicity testing of arsenobetaine, the predominant form of arsenic in marine fishery products. *Food and Chem. Toxicol.* 23(7):669.
- Branch, S., L. Ebdon, and P. O'Neill. 1994. Determination of arsenic species in fish by directly coupled high-performance liquid chromatography-inductively coupled plasma mass spectrometry. *J. Anal. Atomic Spec.* 9:33.
- Broutman, M.A., and D.L. Leonard. 1988. *The Quality of Shellfish Growing Waters in the Gulf of Mexico*. Strategic Assessment Branch, National Oceanic and Atmospheric Administration, U.S. Department of Commerce, Rockville, MD.
- Brown, R.M., D. Newton, C.J. Pickford, et al. 1990. Human metabolism of arsenobetaine ingested with fish. *Hum. Exp. Toxicol.* 9:41-46.
- Bryan, A.M., W.B. Stone, and P.G. Olafsson. 1987. Disposition of toxic PCB congeners in snapping turtle eggs: expressed as toxic equivalents of TCDD. *Bull. Environ. Contam. Toxicol.* 39(5):791-796.
- Bryce, F., S.M. Charbonneau, E. Sandi, and G.K. Tam. 1982. Excretion of a single oral dose of fish-arsenic in man. *Bull. Environ. Contam. Toxicol.* 28(6):669-673.
- Burkhard, L.P., and J.J. Jensen. 1993. Identification of ammonia, chlorine and diazinon as toxicants in a municipal effluent. *Arch. of Environ. Chem.* 25:506-515.
- Cagle, F.R. 1946. The growth of the slider turtle, *Pseudemys scripta elegans*. *Am. Midl. Nat.* 35:685-729.
- Cagle, F.R. 1948. Growth of turtles in Lake Glendale, Illinois. *Copeia* 3:197-203.
- Cagle, F.R. 1950. The life history of the slider turtle, *Pseudemys scripta troostii* (Holbrook). *Ecol. Monogr.* 20:31-54.

- California Department of Fish and Game. 1990. *Laboratory Quality Assurance Program Plan*. Environmental Services Division, Sacramento, CA.
- Cannon, J.R., J.B. Saunders, and R.F. Toia. 1983. Isolation and preliminary toxicological evaluation of arsenobetaine—the water-soluble arsenical constituent from the hepatopancreas of the western rock lobster. *Sci. Total Environ.* 31:181-185.
- Cantillo, A.Y. 1991. Reference materials for marine science. *Sea Tech.* May:45-47.
- Capuzzo, J.M., J.W. Farrington, G.T. Wallace, and A.E. McElroy. 1990. *Chemical Contaminants in Fish and Shellfish: Development of Uniform Testing and Reporting Standards*. Project No. NA89-EA-D-00014. Prepared for National Oceanic and Atmospheric Administration. Woods Hole Oceanographic Institution, Woods Hole, MA.
- Carlander, K.D. 1969. *Handbook of Freshwater Fishes of the United States and Canada*. 3rd Ed. Iowa State University Press, Ames, IA.
- Castanet, J. 1974. Etude histologique des marques squelettiques de croissance chez *Vipera aspis* (L.) (Ophidia, Viperidae). *Zool Scr* 3:137-151.
- Castanet, J. 1987. La squelettechronologie chez les reptiles. III. Applications. *Ann Sci Nat Zool Paris* 8:157-172.
- Castanet, J. 1994. Age estimation and longevity in reptiles. *Gerontology* 40:174-192.
- Castanet, J., H. Francillon-Vieillot, F.J. Meunier, and A. de Ricqlès. 1993. Bone and individual aging. In *Bone, Volume 7 - Bone Growth*. B.K. Hall (ed.). CRC Press, Boca Raton, Florida. pp. 245-283.
- Charbonneau, S.M., K. Spencer, F. Bryce, and E. Sandi. 1978. Arsenic excretion by monkeys dosed with arsenic-containing fish or with inorganic arsenic. *Bull. Environ. Contam. Toxicol.* 20(4):470-477.
- Cochran, W.G. 1963. *Sampling Techniques*. John Wiley & Sons, New York, NY.
- Cochran, W.G. 1977. *Sampling Techniques*. John Wiley & Sons, New York, NY.
- Cogliano, J.V. 1998. Assessing cancer risks from environmental PCBs. *Environ. Health Perspec.* 106 (6):317-323.
- Conant, R., and J.T. Collins. 1991. *A Field Guide to Reptiles and Amphibians of Eastern/Central North America*. 2nd Edition. Peterson Field Guide Series. Houghton Mifflin Company, Boston, MA.

- Crawford, J.K., and S.N. Luoma. 1993. *Guidelines for Studies of Contaminants in Biological Tissues for the National Water-Quality Assessment Program*. USGS Open-File Report 92-494. U.S. Geological Survey, Lemoyne, PA.
- Creclius, E.D. 1978. Modification of the arsenic speciation technique using hydride generation. *Anal. Chem* 50(6):826-827.
- Creclius, E.A., N.S. Bloom, C.E. Cowan, and E.A. Jenne. 1986. *Speciation of Selenium and Arsenic in Natural Waters and Sediments. Vol. 2: Arsenic Speciation*. EPRI report #EA-4641.
- Creclius, E.A. 1999. Battelle Pacific NW Labs, Sequim, WA. Personal communication.
- Crump, K.S., D.G. Hoel, C.H. Langley, and R. Peto. 1976. Fundamental carcinogenic processes and their implications for low dose risk assessment. *Cancer Res.* 36:2973-2979.
- Cullen, W.R., and K.J. Reimer. 1989. Arsenic speciation in the environment. *Chem. Rev.* 89:713-764.
- Cullen, W.R., G.K. Eigendorf, B.U. Nwata, and A. Takatsu. 1990. The quantitation of butyltin and cyclohexyltin compounds in the marine environment of British Columbia. *Appl. Organometal. Chem.* 4:581-590.
- Cunningham, P.A. 1979. The use of bivalve molluscs in heavy metal pollution research: In *Marine Pollution: Functional Responses*. W.B. Vernberg, F.P. Thurberg, A. Calabrese and F.J. Vernberg (eds.). Academic Press, New York, NY.
- Cunningham, P.A. 1998. Summary of state responses to the 1997 Listing of Fish and Wildlife Advisories (LFWA) questionnaire. Prepared for the Office of Science and Technology, Office of Water, Washington DC. March 1998.
- Cunningham, P.A., J.M. McCarthy, and D. Zeitlin. 1990. *Results of the 1989 Census of State Fish/Shellfish Consumption Advisory Programs*. Prepared for Assessment and Watershed Protection Division, Office of Water Regulations and Standards, U.S. Environmental Protection Agency. Research Triangle Institute, Research Triangle Park, NC.
- Cunningham, P.A., and E. Sullivan. 1999. Summary of state responses to the 1998 National Listing of Fish and Wildlife Advisories (NLFWA) questionnaire. Prepared for the Office of Science and Technology, Office of Water, Washington DC. June 1999.

- Cunningham, P.A., and C.O. Whitaker. 1989. *A Survey of the Status of Biomonitoring in State NPDES and Nonpoint Source Monitoring Programs*. Prepared for the Office of Policy, Planning, and Evaluation, U.S. Environmental Protection Agency. Research Triangle Institute, Research Triangle Park, NC.
- Czapla, T.C., M.E. Pattillo, D.M. Nelson, and M.E. Monaco. 1991. *Distribution and Abundance of Fishes and Invertebrates in Central Gulf of Mexico Estuaries*. ELMR Report No. 7. Strategic Assessment Branch, National Oceanic and Atmospheric Administration, U.S. Department of Commerce, Rockville, MD.
- Daly, R., V.A. Hacker, and L. Wiegart. 1962. *The Lake Trout—Its Life History, Ecology, and Management*. Wisconsin Conservation Department Publication 233. Madison, Wisconsin.
- Dawson, V.K., W.H. Gingerich, R.A. Davis, and P.A. Gilderhus. 1991. Rotenone persistence in freshwater ponds: Effects of temperature and sediment adsorption. *North American Journal of Fisheries Management* 11:226-231.
- Demesmay, C., M. Olle, and M. Porthault. 1994. Arsenic speciation by coupling high-performance liquid chromatography with inductively coupled plasma mass spectrometry. *Presenius J. Anal. Chem.* 348:205-210.
- Dobie, J.L. 1971. Reproduction and growth in the alligator snapping turtle, *Macrolemys temmincki* (Troost). *Copeia* 4:645-658.
- Driscoll, C.T., C. Yan, C.L. Scholfield, R. Munson, and J. Holsapple. 1994. The mercury cycle and fish in the Adirondack lakes. *Environ. Sci. Technol.* 28 (3):136-143.
- Dunn, W.J., III, D.L. Stallings, T.R. Schwartz, J.W. Hogan, J.D. Petty, E. Johanson, and S. Wold. 1984. Pattern recognition for classification and determination of polychlorinated biphenyls in environmental samples. *Anal. Chem.* 56:1308-1313.
- Durfee, R.L., G. Contos, F.C. Whitmore, J.D. Borden, E.E. Hackman, and R.A. Westin. 1976. *PCBs in the United States; Industrial Use and Environmental Distributions*. Office of Toxic Substances, U.S. Environmental Protection Agency, Washington, DC.
- Duston, N.M., C.A. Batdorf, and J.P. Schwartz. 1990. *Progress Report: Metal Concentrations in Marine Fish and Shellfish from Boston and Salem Harbors, and Coastal Massachusetts*. Executive Office of Environmental Affairs, Department of Fisheries, Wildlife, and Environmental Law Enforcement, Division of Marine Fisheries, Salem, MA.

- Ebdon, L., K. Evans, and S. Hill. 1989. The accumulation of organotins in adult and seed oysters from selected estuaries prior to the introduction of U.K. regulations governing the use of tributyltin-based antifouling paints. *Sci. Total Environ.* 83(1-2):63-84.
- Edmonds, J.S., and K.A. Francesconi. 1987. Transformations of arsenic in the marine environment. *Experientia* 43:553-557.
- Edmonds, J.S., and K.A. Francesconi. 1993. Arsenic in seafoods: Human health aspects and regulations. *Mar. Pollution Bull.* 26(12):665-674.
- Eisler, R. 1986. *Polychlorinated Biphenyl Hazards to Fish, Wildlife and Invertebrates: A Synoptic Review*. U.S. Fish and Wildlife Services Biol. Rep. 85(1.7). Patuxent Wildlife Research Center, Laurel, MD. 72 pp.
- Eisler, R. 1987. *Polycyclic Aromatic Hydrocarbon Hazards to Fish, Wildlife and Invertebrates: A Synoptic Review*. U.S. Fish and Wildlife Services Biol. Rep. 85 (1.14). Patuxent Wildlife Research Center, Laurel MD. 134 pp.
- Eisler, R. 1988. Arsenic Hazards to Fish, Wildlife, and Invertebrates: A Synoptic Review. Biological Report 85 (1.12), Contaminant Hazard Reviews, Report No. 12. Fish and Wildlife Service, U.S. Department of the Interior, Laurel, MD.
- Eisler, R. 1989. *Tin Hazards to Fish, Wildlife, and Invertebrates: A Synoptic Review. Contaminant Hazard Reviews. Report #15*. Fish and Wildlife Service, U.S. Department of the Interior, Laurel, MD.
- Emmett, R.L., S.A. Hinton, S.L. Stone, and M.E. Monaco. 1991. *Distribution and Abundance of Fishes and Invertebrates in West Coast Estuaries. Volume II: Life History Summaries*. ELMR Report No. 8. Strategic Assessment Division, National Oceanic and Atmospheric Administration, Rockville, MD.
- Enlow, D.H., and S.O. Brown. 1969. The bone of reptiles. In *Biology of the Reptilia*. C. Gans (ed.). Academic Press, New York. Volume 1, pp. 45-80.
- Erickson, M.D. (ed.). 1991. *Analytical Chemistry of PCBs*. OCLC No. 24542805. Lewis Publishers, Boca Raton, FL.
- Fairey, R., K. Taberski, S. Lamerdin, and M. Petreas. 1997. Organochlorines and other environmental contaminants in muscle tissues of sportfish collected in San Francisco Bay. *Mar. Pollution Bull.* 34(12):1058-1071.
- Frag, A.M., D.F. Woodward, J. N. Goldstein, W. Brumbaugh, and J.S. Meyer. 1998. Concentrations of metals associated with mining waste in sediments, biofilm, benthic macroinvertebrates, and fish from the Coeur D'Alene River Basin, Idaho. *Arch. Environ. Contam. Toxicol.* 34:119-127.

- Farrow, D.R., A.S. Pait, and D.J. Basta. 1989. Targeting pesticide hotspots in estuarine watersheds. In: *Coastal Zone '89, Proceedings of the Sixth Symposium on Coastal and Ocean Management*, Charleston, SC.
- Farm Chemicals Handbook*. 1989. Meister Publishing Company, Willoughby, OH.
- Forsyth, D.S., and C. Cleroux. 1991. Determination of butyltin, methyltin and tetraalkyltin in marine food products with gas chromatography-atomic absorption spectrometry. *Talanta* 38(9):951-957.
- Frazer, N.B., J.L. Greene, and J.W. Gibbons. 1993. Temporal variation in growth rate and age at maturity of male painted turtles, *Chrysemys picta*. *Am. Midl. Nat.* 130:314-324.
- Friberg, L., and D. Vostal (eds.). 1972. *Mercury in the Environment*. The Chemical Rubber Company, CRC Press, Cleveland, OH.
- Frost, D.V. 1967. Arsenicals in biology—retrospect and prospect. *Fed. Proc.* 26:194-208.
- Frye, F.L. 1994. *Reptile Clinician's Handbook: A Compact Clinical and Surgical Reference*. Krieger Publishing Company, Malabar, FL.
- Galbraith, D.A., and R.J. Brooks. 1987. Addition of annual growth lines in adult snapping turtles, *Chelydra serpentina*. *J. Herpetol.* 21:359-363.
- Galtsoff, P.S. 1964. *The American Oyster (Crassostrea virginica Gmelin)*. Fishery Bulletin of the Fish and Wildlife Service, Volume 64. U.S. Department of the Interior, Washington, DC.
- Gardner, A.M., and K.D. White. 1990. Polychlorinated dibenzofurans in the edible portion of selected fish. *Chemosphere* 21 (1-2):215-222.
- George, G. 1987. The current status of the alligator snapping turtle, *Macrolemys temmincki*, with a review of its natural history. In: *Proc. 11th Inter. Herpetol. Symp.* Rosenberg, M. (ed.). pp 75-81.
- Gibbons, J.W. 1968. Population structure and survivorship in the painted turtle, *Chrysemys picta*. *Copeia* 2:260-268.
- Gibbons, J.W. 1976. Aging phenomena in reptiles. In *Special Review of Experimental Aging Research*. M.F. Elias, B.E. Eleftheriou, and P.K. Elias (eds.). Experimental Aging Research, Bar Harbor, Maine. pp. 454-475.
- Gibbons, J.W. 1988. The management of amphibians, reptiles and small mammals in North America: The need for an environmental attitude

- adjustment. *Proc. Symp: Management of Amphibians, Reptiles and Small Mammals in North America*. July 19-21, 1988. Flagstaff, AZ. pp. 4-10.
- Gilbert, R.O. 1987. *Statistical Methods for Environmental Pollution Monitoring*. Van Nostrand Reinhold Company, New York, NY. 320 pp.
- Gingerich, W.H., and J.J. Rach. 1985. Uptake, biotransformation, and elimination of rotenone by bluegills (*Lepomis macrochirus*). *Aquatic Toxicol.* 6:179-196.
- Glaser, J.A., D.L. Forest, G.D. McKee, S. Quave, and W.L. Budde. 1981. Trace analyses for wastewaters. *Environ. Sci. Technol.* 15:1425-1450.
- Glass, G.E., J.A. Sorenson, K.W. Schmidt, and G.R. Rapp. 1990. New source identification of mercury contamination in the Great Lakes. *Environ. Sci. Technol.* 24:1059-1069.
- Goede, R.W., and B.A. Barton. 1990. Organismic indices and an autopsy-based assessment as indicators of health and condition of fish. pp. 93-108. In: *American Fisheries Society Symposium, 8. Biological Indicators of Stress in Fish*. S.M. Adams (ed.) American Fisheries Society, Bethesda, MD.
- Goldstein, R.M., M.E. Brigham, and J.C. Stauffer. 1996. Comparison of mercury concentrations in liver muscle, whole bodies, and composites of fish from the Red River of the North. *Can. J. Fish. Aquat. Sci.* 53: 244-252.
- Golub, M.S., J.M. Donald, and J.A. Reyes. 1991. Reproductive toxicity of commercial PCB Mixtures: LOAELS and NOAELS from animal studies. *Environ. Health Perspect.* 94:245-253.
- Greene, R.W. 1992. *Comparison of Aroclor and Chlorobiphenyl Content in Striped Bass from the Lower Delaware River*. Delaware Department of Natural Resources and Environmental Control, Dover, DE.
- Greene, R.W. 1999. *Chemical Contaminants in Finfish from the Chesapeake and Delaware Canal and Implications to Human Health Risk*. Delaware Department of Natural Resources and Environmental Control, Dover, DE.
- Greenburg, A.E., L.S. Clesceri, and A.D. Eaton (eds.). 1992. *Standard Methods for the Examination of Water and Wastewater*. 18th edition. American Public Health Association and American Water Works Association, Washington, DC. 1268 pp.
- Grimmer, G., H. Bohnke, and H. Borwitzky. 1978. Profile analysis of polycyclic aromatic hydrocarbons in sewage sludge by gas chromatography. *Fresenius Z. Anal. Chem.* 289:91-95.

- Gunderson, D.R., and I.E. Ellis. 1986. Development of a plumb staff beam trawl for sampling demersal fauna. *Fisheries Rev.* 4:35-41.
- Hammer, D.A. 1969. Parameters of a marsh snapping turtle population Lacreek Refuge, South Dakota. *J. Wildl. Manag.* 33:996-1005.
- Hansen, S.H., E.H. Larsen, G. Pritzi, and C. Cornett. 1992. Separation of seven arsenic compounds by high-performance liquid chromatography with on-line detection by hydrogen-argon flame atomic absorption spectrometry and inductively coupled plasma mass spectrometry. *J. Analy. Atomic Spectrom.* 7:629.
- Hardy, J.D., Jr. 1978. *Development of Fishes of the Mid-Atlantic Bight. Volume III Aphredoderidae through Rachycentridae.* U.S. Fish and Wildlife Service, Washington, DC.
- Harris, S.G., and B.L. Harper. 1997. A Native American exposure scenario. *Risk Analysis* 17(6):789-795.
- Harper, B.L., and S.G. Harris. 1999. *Tribal Technical Issues in Risk Reduction Through Fish Advisories.* Joint EPA/American Fisheries Society Meeting. October 15-17, Alexandria, VA.
- Hayes, M.L. 1983. Active capture techniques. In: *Fisheries Techniques.* L.A. Nielsen and D.L. Johnson (eds.). American Fisheries Society, Bethesda, MD. pp. 123-146.
- Hayes, W.J., and E.R. Laws. 1991. *Handbook of Pesticide Toxicology, Vols. 1-3.* Academic Press, Inc., San Diego.
- HEAST (Health Effects Assessment Summary Tables). 1997. *Health Effects Summary Tables.* EPA 540-R-97-036. Office of Solid Waste and Emergency Response, U.S. Environmental Protection Agency, Cincinnati, OH.
- Hebert, C.E., V. Glooschenko, G.D. Haffner, and R. Lazar. 1993. Organic contaminants in snapping turtle (*Chelydra serpentina*) populations from southern Ontario, Canada. *Arch. Environ. Contam. Toxicol.* 24:35-43.
- Hebert, C.E., and K.A. Keenleyside. 1995. To normalize or not to normalize? Fat is the question. *Environ. Toxicol. Chem.* 14(5):801-807.
- Helwig, D.D., and M.E. Hora. 1983. Polychlorinated biphenyl, mercury and cadmium concentrations in Minnesota snapping turtles. *Bull. Contamin. Toxicol.* 30:186-190.

- Henry, K.S., K. Kannan, B.W. Nagy, N.R. Kevern, J.J. Zabik, and J.P. Giesy. 1998. Concentrations and Hazard Assessment of Organochlorine Contaminants and Mercury in Smallmouth Bass from a Remote Lake in the Upper Peninsula of Michigan. *Arch. Environ. Contam. Toxicol.* 34:81-96.
- Hesse, J. 1991. Michigan Department of Public Health. Personal communication.
- Hesse, J.L. 1976. Polychlorinated biphenyl usage and sources of loss to the environment. In: *National Conference on Polychlorinated Biphenyls*. J.L. Buckley et al. (eds.). QV 633 N277c 1975. U.S. Environmental Protection Agency, Washington, DC.
- Hodges, L. 1977. *Environmental Pollution*. Holt, Rinehart and Winston, New York, NY.
- Holder, J.W. 1986. *The Assessment of the Carcinogenicity of Dicofol (Kelthane), DDT, DDE, and DDD (TDE)*. EPA-600/6-86/001. Carcinogen Assessment Group. U.S. Environmental Protection Agency, Office of Pesticide Programs, Washington, DC.
- Holmes, D.D. 1984. *Clinical Laboratory Animal Medicine—An Introduction*. The Iowa State University Press, Ames, IA.
- Hora, M.E. 1981. Reduction of polychlorinated biphenyl (PCB) concentrations in carp (*Cyprinus carpio*) fillets through skin removal. *Bull. Environ. Contamin. Toxicol.* 26: 364-366.
- HSDB (Hazardous Substance Data Bank). 1999. National Library of Medicine. Toxicology Information Program, Bethesda, MD. Please note that 1999 is the year that HSDB was searched and is not necessarily the year that the HSDB file was updated for the specific information. In some cases, the HSDB file update may have occurred many years earlier.
- Hubert, W.A. 1983. Passive capture techniques. pp. 95-122. In: *Fisheries Techniques*. L.A. Nielsen and D.L. Johnson (eds.). American Fisheries Society, Bethesda, MD.
- Huckins, J.N., T.R. Schwartz, J.D. Petty, and L.M. Smith. 1988. Determination, fate, and potential significance of PCBs in fish and sediment with emphasis on selected AHH-inducing congeners. *Chemosphere* 17(10):1995-2016.
- Hueter, R.E., W.G. Fong, G. Henderson, et al. 1995. Methylmercury concentration in shark muscle by species, size, and distribution of sharks in Florida Coastal waters. In: Pocella D.B., and B. Wheatley (eds).

- Mercury as a Global Pollutant*. Proceedings of the Third International Conference, British Columbia, Canada, July 1994. Kluwer Academic Publishers, Boston, MA. pp. 893-399.
- IARC (International Agency for Research on Cancer). 1987. *IARC Monographs on the Evaluation of the Carcinogenic Risk of Chemicals to Humans*. Supplement 7. World Health Organization, Lyon, France.
- IRIS (Integrated Risk Information System). 1999. U.S. Environmental Protection Agency, Washington, DC. <http://www.epa.gov/iris> (Please note that 1999 is the year that IRIS was searched and is not the year that the IRIS file was updated for the specific chemical. In some cases, the IRIS file update may have occurred many years earlier).
- Jacobs, H.L., H.D. Kahn, K.A. Stralka, and B. Phan. 1998. Estimates of per capita fish consumption in the U.S. based on the continuing survey of food intake by individuals (CSFII). *Risk Anal.* 18(3): 283-291.
- Jacobson, S.W., G.G. Fein, J.L. Jacobson, P.M. Schwartz, and J.K. Douter. 1985. The effects of intrauterine PCB exposure on visual recognition memory. *Child Dev.* 56:853-60.
- Jacobson, J.L., S.W. Jacobson, and H.E. Humphrey. 1990. Effects of in utero exposure to polychlorinated biphenyls and related contaminants on cognitive functioning in young children. *J. Pediatrics* 116(1):38-45.
- Jansson, B., and U. Widequist. 1983. Identification of toxaphene (PCC) and chlordane in biological samples by NCI mass spectrometry. *Inter. J. Environ. Analy. Chem.* 13:309-322.
- Jearld, A. 1983. Age determination. In: *Fisheries Techniques*. L.A. Nielsen and D. Johnson (eds.). American Fisheries Society, Bethesda, MD. pp. 301-324.
- Johnson, M.G. 1987. Trace element loadings to sediments of fourteen Ontario lakes and correlation in fish. *Can. J. Fish Aquat. Sci.* 44:3-13.
- Jury, SH., J.D. Field, S.L. Stone, D.M. Nelson, and M.E. Monaco. 1994. *Distribution and Abundance of Fishes and Invertebrates in North Atlantic Estuaries*. ELMR Rep. No. 13. NOAA/NOS Strategic Environmental Assessments Division, Silver Spring, MD.
- Kaise, T., S. Watanabe, and K. Itoh. 1985. The acute toxicity of arsenobetaine. *Chemosphere* 14:1327-1332.
- Kaiser, K.L.E. 1978. The rise and fall of mirex. *Environ. Sci. Technol.* 12:520-528.

- Kannan, N., S. Tanabe, M. Ono, and R. Tatsukawa. 1989. Critical evaluation of polychlorinated biphenyl toxicity in terrestrial and marine mammals: increasing impact of non-ortho and mono-ortho coplanar polychlorinated biphenyls from land to ocean. *Arch. Environ. Contam. Toxicol.* 18(6):850-857.
- Kannan, K., R.G. Smith Jr., R.F. Lee, H.L. Windom, P.T. Heitmuller, J.M. Macauley, J.K. Summers. 1998. Distribution of total mercury and methyl mercury in water, sediment, and fish from south Florida estuaries. *Arch. Environ. Contam. Toxicol.* 34:109-118.
- Keith, L.H. 1991a. Report Results Right! Part 1. *Chemtech* June:352-356.
- Keith, L.H. 1991b. Report Results Right! Part 2. *Chemtech* August:486-489.
- Keith, L.H., W. Crommett, J. Deegan, Jr., R.A. Libby, J.K. Taylor, and G. Wentler. 1983. Principles of environmental analysis. *Analy. Chem.* 55:1426-1435.
- Kidwell, J.M., L.J. Phillips, and G. F. Birchard. 1995. Comparative analyses of contaminant levels in bottom feeding and predatory fish using the National Contaminant Biomonitoring Program Data. *Bull. Environ. Contamin. Tox.* 54:919-923.
- Kimbrough, R.D., and A.A. Jensen. 1989. *Topics in Environmental Health: Halogenated Biphenyls, Terphenyls, Naphthalenes, Dibenzodioxins and Related Products*. Vol. 4, 2nd Edition. Elsevier, North Holland, NY.
- Kish, L. 1965. *Survey Sampling*. John Wiley & Sons, New York, NY.
- Klaassen, C.D., M.D. Amdur, and J. Doull (eds.). 1986. *Casarett and Doull's Toxicology, The Basic Science of Poisons*. 3rd edition. MacMillan Publishing Co., New York, NY.
- Klaassen C.D. (ed.). 1996. *Casarett and Doull's Toxicology, The Basic Science of Poisons*. 5th edition. McGraw-Hill, New York.
- Korach, K.S. P. Sarver, K. Chae, J.A. McLachlan, and J.D. McKinney. 1988. Estrogen receptor-binding activity of polychlorinated hydroxybiphenyls: conformationally restricted structural probes. *Mol. Pharmacol.* 33:120-126.
- Krahn, M.M., L.D. Rhodes, M.S. Myers, L.K. Moore, W.D. MacLeod, and D.C. Malins. 1986. Associations between metabolites of aromatic compounds in bile and the occurrence of hepatic lesions in English sole (*Parophrys vetulus*) from Puget Sound, Washington. *Arch. Environ. Contam. Toxicol.* 15:61-67.

- Krahn, M.M., C.A. Wigren, R.W. Pearce, L.K. Moore, R.G. Bogar, W.D. MacLeod, Jr., S.L. Chan, and D.W. Brown. 1988. *Standard Analytical Procedures for the NOAA National Analytical Facility. New HPLC Cleanup and Revised Extraction Procedures for Organic Contaminants*. NOAA Tech. Memo NMFS F/NWC-153. National Oceanic and Atmospheric Administration, U.S. Department of Commerce, Northwest and Alaska Fisheries Center, Seattle, WA. 52 pp.
- Kubiak, T.J., H.J. Harris, L.M. Smith, T.R. Schwartz, D.L. Stalling, J.A. Trick, L. Sileo, D.E. Docherty, and T.C. Erdman. 1989. Microcontaminants and reproductive impairment of the Forster's tern on Green Bay, Lake Michigan—1983. *Arch. Environ. Contam. Toxicol.* 18(5):706-727.
- Kuehl, D.W., B. Butterworth, and P.J. Marquis. 1994. A national study of chemical residues in fish III: Study results. *Chemosphere* 29 (3): 523-535.
- Kurland, L.T., S.N. Faro, and H. Siedler. 1960. Minamata Disease: The outbreak of a neurological disorder in Minamata, Japan, and its relationship to the ingestion of seafood contaminated by mercuric compounds. *World Neurol.* 1:370-391.
- Kutz, F.W., S.C. Strassman, C. R. Stroup, U.C. Carra, C.C. Leininger, D.L. Watts, and C.M. Sparacino. 1985. The human body burden of mirex in the southeastern United States. *Toxicol. Environ. Health* 15:385-394.
- Lake, J.L., R. McKinney, C.A. Lake, F.A. Osterman, and J. Heltshe. 1995. Comparisons of patterns of polychlorinated biphenyls congeners in water, sediment, and indigenous organisms from New Bedford Harbor, Massachusetts. *Arch. Environ. Contamin. Toxicol.* 29(2):207-220.
- Lamb, T., J.W. Bickham, J.W. Gibbons, M.J. Smolen, and S. McDowell. 1991. Genetic damage in a population of slider turtles (*Trachemys scripta*) inhabiting a radioactive reservoir. *Arch. Environ. Contam. Toxicol.* 20:138-142.
- Legler, J.M. 1960. Natural history of the ornate box turtle, *Terrapene ornata ornata* Agassiz, University of Kansas. *Publ. Mus. Nat. Hist.* 11:527-669.
- Leonard, D.L., M.A. Broutman, and K. E. Harkness. 1989. *The Quality of Shellfish Growing Waters on the East Coast of the United States*. Strategic Assessment Branch, National Oceanic and Atmospheric Administration, U.S. Department of Commerce, Rockville, MD.
- Leonard, D.L., and E.A. Slaughter. 1990. *The Quality of Shellfish Growing Waters on the West Coast of the United States*. Strategic Assessment Branch, National Oceanic and Atmospheric Administration, U.S. Department of Commerce, Rockville, MD.

- Li, M. 1975. Pollution in nation's estuaries originating from the agricultural use of pesticides. In: *Estuarine Pollution Control and Assessment*. Office of Water Planning and Standards, U.S. Environmental Protection Agency, Washington, DC. pp. 451-466.
- Lonky, E., J. Reihman, T. Darvill, J. Mather, and H. Daly. 1996. Neonatal behavioral assessment scale performance in humans influenced by maternal consumption of environmentally contaminated Lake Ontario fish. *J. Great Lakes Res.* 22(2):198-212.
- Lowe, T.P., T.W. May, W.G. Brumbaugh, and D.A. Kane. 1985. National Contaminant Biomonitoring Program: Concentrations of seven elements in freshwater fish, 1978-1981. *Arch. Environ. Contam. and Toxicol.* 14:363-388.
- Lowenstein, G.G., and D.R. Young. 1986. *National Status and Trends Program for Marine Environmental Quality, Benthic Surveillance Project: Cycle III Field Manual*. NOAA Tech. Memorandum NOS OMA 28. National Oceanic and Atmospheric Administration, U.S. Department of Commerce, Rockville, MD.
- Luten, J.R., G. Riekwel-Booy, and A. Rauchbaar. 1982. Occurrence of arsenic in plaice (*Pleuronectes platessa*), nature of organoarsenic compound present and its excretion by man. *Environ. Health Perspect.* 45:165-170.
- Maack, L., and W.C. Sonzogni. 1988. Analysis of polychlorobiphenyl congeners in Wisconsin fish. *Arch. Environ. Toxicol.* 17(6):711-719.
- MacKenzie, M.J., and J.V. Hunter. 1979. Sources and fates of aromatic compounds in urban stormwater runoff. *Environ. Sci. and Technol.* 13(2):179-183.
- MacLeod W., Jr., D. Brown, A. Friedman, O. Maynes, and R. Pierce. 1985. *Standard Analytical Procedures of the NOAA National Analytical Facility, 1984-85, Extractable Toxic Organic Compounds*. NOAA Technical Memorandum NMFS F/NWC-64. Prepared for the National Status and Trends Program, National Oceanic and Atmospheric Administration, U.S. Department of Commerce, Rockville, MD.
- Malins, D.C., B.B. McCain, D.W. Brown, S.L. Chan, M.S. Myers, J.T. Landahl, P.G. Prohaska, A.J. Friedman, L.D. Rhodes, D.G. Burrows, W.D. Gronlund, and H.O. Hodgins. 1984. Chemical pollutants in sediments and diseases of bottom-dwelling fish in Puget Sound, WA. *Environ. Sci. Technol.* 18:705-713.

- Malins, D.C., M.M. Krahn, M.S. Myers, L.D. Rhodes, D.W. Brown, C.A. Krone, B.B. McCain, and S.L. Chan. 1985. Toxic chemicals in sediments and biota from a creosote-polluted harbor: Relationships with hepatic neoplasms and other hepatic lesions in English sole (*Parophrys vetulus*). *Carcinogenesis* 6:1463-1469.
- Marsh, D.O. 1987. Dose-response relationships in humans: Methyl mercury epidemics in Japan and Iraq. In: *The Toxicity of Methyl Mercury*. C.U. Eccles and Z. Annau (eds). Johns Hopkins University Press, Baltimore, MD.
- Marsh, D.O., T.W. Clarkson, C. Cox, G.J. Meyers, L. Amin-Zaki, and S. Al-Tikriti. 1987. Fetal methylmercury poisoning: relationship between concentration in single strands of maternal hair and child effects. *Arch. Neurol.* 44:1017-1022.
- Martin, R.C., D.G. Dixon, R.J. Maguire, P.V. Hodson, and R. J. Tkacz. 1989. Acute toxicity, uptake, depuration, and tissue distribution of tri-n-butyltin in rainbow trout *Salmo gairdneri*. *Aquatic Toxicol.* 15:37-52.
- May, T.W., and G.L. McKinney. 1981. Cadmium, lead, mercury, arsenic and selenium concentrations in freshwater fish, 1976-1977—National Pesticide Monitoring Program. *Pesticides Monitoring Journal* 15(1):14-38
- McConnell, E.E. 1980. In: *Topics in Environmental Health: Halogenated Biphenyls, Terphenyls, Naphthalenes, Dibenzodioxins and Related Products*. R.D. Kimbrough (ed.). Elsevier, North Holland, New York, NY. pp. 109-150.
- McFarland, V.A., and J.U. Clarke. 1989. Environmental occurrence, abundance, and potential toxicity of polychlorinated biphenyl congeners: considerations for a congener-specific analysis. *Environ. Health Perspect.* 81:225-239.
- Mearns, A.J., and M.J. Allen. 1978. *Use of Small Trawls in Coastal Biological Surveys*. Final Report. Prepared for Corvallis Environmental Research Laboratory, Office of Research and Development, U.S. Environmental Protection Agency, Corvallis, OR. Southern California Coastal Water Research Project, El Segundo, CA.
- The Merck Index. 1989. *An Encyclopedia of Chemicals, Drugs, and Biologicals*. 11th Edition. S.Budavari, ed., Merck and Company, Inc., Rahway, NJ.
- Mes, J., and D. Weber. 1989. Non-ortho-chlorine substituted coplanar polychlorinated biphenyl congeners in Canadian adipose tissue, breast milk, and fatty foods. *Chemosphere* 19(8-9):1357-1365.

- Miller, G.T. 1979. *Living in the Environment*. Wadsworth Publishing Company, Belmont, CA.
- Mills, D. 1971. *Salmon and Trout: A Resource, its Ecology, Conservation, and Management*. Oliver and Boyd Publishers, Edinburgh, Canada.
- Minnesota Department of Health. 1994. Minnesota Fish Consumption Advisory. Minneapolis, MN.
- Mix, M.C. 1986. Cancerous diseases in aquatic animals and their association with environmental pollutants: A critical literature review. *Mar. Environ. Res.* 20:1-141.
- Monaco, M.E., D.M. Nelson, T.C. Czaplak, and M.E. Patillo. 1989. *Distribution and Abundance of Fishes and Invertebrates in Texas Estuaries*. ELMR Report No. 3. Strategic Assessment Branch, National Oceanic and Atmospheric Administration, U.S. Department of Commerce, Rockville, MD.
- Monaco, M.E., D.M. Nelson, R.L. Emmett, and S.A. Hinton. 1990. *Distribution and Abundance of Fishes and Invertebrates in West Coast Estuaries. Volume I: Data Summaries*. ELMR Report No. 4. Strategic Assessment Branch, National Oceanic and Atmospheric Administration, U.S. Department of Commerce, Rockville, MD.
- Moore, J.W., and Ramamoorthy, S. 1984. *Organic Chemicals in Natural Waters*. Springer-Verlag, New York, NY. 289 pp.
- Morris, C.R., and J.R.P. Cabral (eds.). 1986. Hexachlorobenzene: Proceedings of an international symposium. *IARC Scientific Publication No. 77*. World Health Organization, Lyon, France.
- Mullin, M.D., C.M. Pochini, S. McCrindle, M. Romkes, S.H. Safe, and L.M. Safe. 1984. High-resolution PCB analysis: Synthesis and chromatographic properties of all 209 PCB congeners. *Environ. Sci. Technol.* 18:468-476.
- Multistate Fish and Wildlife Information Systems. 1990. *Second Annual Progress Report (July 1-July 30, 1990)*. Department of Fisheries and Wildlife, Virginia Polytechnical Institute, Blacksburg, VA.
- Murchelano, R.A. 1982. Some pollution-associated diseases and abnormalities of marine fish and shellfish: A perspective for the New York Bight. In: *Ecological Stress and the New York Bight: Science and Management*. G.F. Mayer (ed.). Estuarine Research Federation, Columbia, SC. pp. 327-346.

- Murphy, D. 1993. Maryland Department of Environment, Water Quality, Toxic Division. Personal communication.
- NAS (National Academy of Sciences). 1976. *Selenium*. Committee on Medical and Biologic Effects of Environmental Pollutants, National Research Council, Washington, DC.
- NAS (National Academy of Sciences). 1977. *Arsenic*. Committee on Medical and Biologic Effects of Environmental Pollutants, National Research Council, Washington, DC.
- NAS (National Academy of Sciences). 1991. *Seafood Safety*. Committee on Evaluation of the Safety of Fishing Products, National Academy Press, Washington, DC.
- NAS (National Academy of Sciences). 2000. *Toxicological Effects of Methylmercury*. National Research Council, Washington, DC.
- National Marine Fisheries Service. 1987. *Marine Recreational Fishery Statistics Survey, Pacific Coast, 1986*. Current Fishery Statistics Number 8393. National Oceanic and Atmospheric Administration, U.S. Department of Commerce, Rockville, MD.
- NCI (National Cancer Institute). 1978. *Bioassay of Dicofol for Possible Carcinogenicity*. NCI Carcinogenesis Technical Report Series #90. Rockville, MD.
- Neff, J.M. 1979. *Polycyclic Aromatic Hydrocarbons in the Aquatic Environment: Sources, Fates and Biological Effects*. Applied Science Publishers, Ltd, London, England.
- Neff, J.M. 1985. Polycyclic aromatic hydrocarbons. In: *Fundamentals of Aquatic Toxicology*. G.M. Rand and S.R. Petrocelli (eds.). Hemisphere Publishing Corporation, Washington, DC.
- Nelson, J.M. (ed.). 1992. *Distribution and Abundance of Fishes and Invertebrates in Gulf of Mexico Estuaries, Vol. 1: Data Summaries*. ELMR Rep. No. 10. NOAA/NOS Strategic Environmental Assessments Division, Rockville, MD.
- Nelson, D.M., M.E. Monaco, E.A. Irlandi, L.R. Settle, and L. Coston-Clements. 1991. *Distribution and Abundance of Fishes and Invertebrates in Southeast Estuaries*. ELMR Report No. 9. Strategic Assessment Division, National Oceanic and Atmospheric Administration, U.S. Department of Commerce, Rockville, MD.

- NESCAUM (Northeast States and Eastern Canadian Provinces). 1998. *Mercury Study, A Framework for Action*. Boston, MA.
- Neumann, C.M., K.W. Kaufman, and D.J. Gilroy. 1997. Methylmercury in Fish from Owyhee Reservoir in Southeast Oregon: Scientific Uncertainty and Fish Advisories. *Sci. Total Environ.*:205-214.
- New York State Department of Health. 1994. *Health Advisory—Chemicals in Sportfish and Game 1994-1995*. #40820042. Division of Environmental Health Assessments, Albany, NY.
- Nicholls, T.P., R. Perry, and J.N. Lester. 1979. The influence of heat treatment on the metallic and polycyclic aromatic hydrocarbon content of sewage sludge. *Sci. Total Environ.* 12:137-150.
- Niimi, A.J. 1987. Biological half-lives of chemicals in fishes. *Rev. Environ. Contam. Toxicol.* 99:1-46. Springer-Verlag, New York, NY.
- Nimmo, D.R. 1985. Pesticides. In: *Fundamentals of Aquatic Toxicology*, G.M. Rand and S.R. Petrocelli (eds.). Hemisphere Publishing Corporation, Washington, DC.
- Nisbet, I.C.T., and P.K. LaGoy. 1992. Toxic equivalency factors (TEFs) for polycyclic aromatic hydrocarbons (PAHs). *Reg. Toxicol. Pharmacol.* 16:290-300.
- NOAA (National Oceanic and Atmospheric Administration). 1987. *National Status and Trends Program for Marine Environmental Quality—Progress Report: A Summary of Selected Data on Chemical Contaminants in Tissues Collected During 1984, 1985 and 1986*. NOAA Technical Memorandum NOS OMA 38. U.S. Department of Commerce, Rockville, MD.
- NOAA (National Oceanic and Atmospheric Administration). 1989a. *National Status and Trends Program for Marine Environmental Quality - Progress Report: A Summary of Selected Data on Tissue Contamination from the First Three Years (1986-1988) of the Mussel Watch Project*. NOAA Technical Memorandum NOS OMA 49. U.S. Department of Commerce, Rockville, MD.
- NOAA (National Oceanic and Atmospheric Administration). 1989b. *Standard Analytical Procedures of the NOAA National Analytical Facility*. 2nd ed. NOAA Tech. Mem. NMFS F/NWC-92, 1985-86. National Status and Trends Program, U.S. Department of Commerce, Rockville, MD.

- NOAA (National Oceanic and Atmospheric Administration). 1992. *Standard and Reference Materials for Marine Science*. Third Edition. U.S. Department of Commerce, Rockville, Maryland.
- NOAA (National Oceanic and Atmospheric Administration). 1993a. *Sampling and Analytical Methods of the National Status and Trends Program, National Benthic Surveillance and Mussel Watch Projects 1984-1992. Volume II. Comprehensive Descriptions of Complementary Measurements*. NOAA Technical Memorandum NOS ORCA 71. Coastal Monitoring and Bioeffects Assessment Division, Office of Ocean Resources Conservation and Assessment, National Ocean Service, Silver Spring, MD. July.
- NOAA (National Oceanic and Atmospheric Administration). 1993b. *Sampling and Analytical Methods of the National Status and Trends Program, National Benthic Surveillance and Mussel Watch Projects 1984-1992. Volume III. Comprehensive Descriptions of Elemental Analytical Methods*. NOAA Technical Memorandum NOS ORCA 71. Coastal Monitoring and Bioeffects Assessment Division, Office of Ocean Resources Conservation and Assessment, National Ocean Service, Silver Spring, MD. July.
- NOAA (National Oceanic and Atmospheric Administration). 1993c. *Sampling and Analytical Methods of the National Status and Trends Program, National Benthic Surveillance and Mussel Watch Projects 1984-1992. Volume IV. Comprehensive Descriptions of Trace Organic Analytical Methods*. NOAA Technical Memorandum NOS ORCA 71. Coastal Monitoring and Bioeffects Assessment Division, Office of Ocean Resources Conservation and Assessment, National Ocean Service, Silver Spring, MD. July.
- Norstrom, R.J. 1988. In: *Hazards, Decontamination and Replacement of Polychlorinated Biphenyls*. J.P. Crine (ed.). Plenum Publishing Corporation, New York, NY.
- NPCA (National Paint and Coatings Association). 1988. Annual Report. Washington, DC.
- Nriagu, J.O., and M.S. Simmons (eds.). 1990. *Food Contamination from Environmental Sources*. J. Wiley and Sons, New York, NY.
- Olafsson, P.G., A.M. Bryan, B. Bush, and W. Stone. 1983. Snapping turtles—A biological screen for PCBs. *Chemosphere* 12 (11/12):1525-1532.
- Olafsson, P.G., A.M. Bryan, and W. Stone. 1987. PCB congener specific analysis: A critical evaluation of toxic levels in biota. *Chemosphere* 16 (10-12):2585-2593.

- Oliver, B.G., and A.J. Niimi. 1988. Trophodynamic analysis of polychlorinated biphenyl congeners and other chlorinated hydrocarbons in the Lake Ontario ecosystem. *Environ. Sci. Technol.* 22(4):388-397.
- Patillo, M.E., T.E. Czaplá, D.M. Nelson, and M.E. Monaco. 1997. *Distribution and Abundance of Fishes and Invertebrates in Gulf of Mexico Estuaries. Volume II: Species Life History Summaries.* ELHR Report No. 14. NOAA/NOS Strategic Environmental Assessments Division, Silver Spring, MD.
- Peabody, F.E. 1961. Annual growth zones in vertebrates (living and fossil). *J. Morphol.* 108:11-62.
- Penrose, W.R. 1974. Arsenic in the marine and aquatic environments: Analysis, occurrence and significance. *C.R.C. Crit. Rev. in Environ. Contam.* 4:465-482.
- Pflieger, W.H. 1975. *The Fishes of Missouri.* Missouri Department of Conservation, Jefferson City, MO.
- Phillips, D.J.H. 1980. *Quantitative Aquatic Biological Indicators.* Pollution Monitoring Series. Applied Science Publishers Ltd, London, England.
- Phillips, P.T. 1988. *California State Mussel Watch—Ten Year Data Summary (1977-1987) Water Quality Monitoring Report No. 87-3.* State Water Resources Control Board, Division of Water Quality, Sacramento, CA.
- Pillay, K.K.S., C.C. Thomas, and J.W. Kaminski. 1969. Neutron activation analysis of the selenium content of fossil fuels. *Nucl. Appl. Technol.* 7:478-483.
- Piotrowski, J.K., and M.J. Inskip. 1981. *Health Effects of Mercury; A Technical Report (1981).* MARC Report Number 24. Chelsea College, University of London. 82 pp.
- Pitt, T.K., R. Wells, and W.D. McKone. 1981. A critique of research otter trawl surveys by the St. John's Research and Resource Services. *Canadian Fish Aquatic Sci. Spec. Publ.* 58:42-61.
- Poland, A., and J.C. Knutson. 1982. 2,3,7,8-Tetrachlorodibenzo-*p*-dioxin and related halogenated aromatic hydrocarbons: Examination of the mechanism of toxicity. *Annu. Rev. Pharmacol. Toxicol.* 22:517-554.
- Pollock, G. 1993. California Environmental Protection Agency. Personal communication.

- Pritchard, P.C.H. 1989. *The Alligator Snapping Turtle: Biology and Conservation*. Milwaukee Public Museum, Milwaukee, WI. 104 pp.
- Puget Sound Estuary Program. 1990a (revised). Recommended protocols for station positioning in Puget Sound. In: *Recommended Protocols and Guidelines for Measuring Selected Environmental Variables in Puget Sound*. Prepared by PTI Environmental Services, Bellevue, WA. Region 10, U.S. Environmental Protection Agency, Seattle, WA. (Looseleaf)
- Puget Sound Estuary Program. 1990b (revised). Recommended protocols for sampling soft-bottom demersal fishes by beach seine and trawl in Puget Sound. In: *Recommended Protocols and Guidelines for Measuring Selected Environmental Variables in Puget Sound*. Prepared by PTI Environmental Services, Bellevue, WA. Region 10, U.S. Environmental Protection Agency, Seattle, WA. (Looseleaf)
- Puget Sound Estuary Program. 1990c (revised). Recommended protocols for fish pathology studies in Puget Sound. In: *Recommended Protocols and Guidelines for Measuring Selected Environmental Variables in Puget Sound*. Prepared by PTI Environmental Services, Bellevue, WA. Region 10, U.S. Environmental Protection Agency, Seattle, WA. (Looseleaf)
- Puget Sound Estuary Program. 1990d (revised). Recommended guidelines for measuring organic compounds in Puget Sound sediments and tissue samples. In: *Recommended Protocols and Guidelines for Measuring Selected Environmental Variables in Puget Sound*. Prepared by PTI Environmental Services, Bellevue, WA. Region 10, U.S. Environmental Protection Agency, Seattle, WA. (Looseleaf)
- Puget Sound Estuary Program. 1990e (revised). Recommended protocols for measuring metals in Puget Sound water, sediment, and tissue samples. In: *Recommended Protocols and Guidelines for Measuring Selected Environmental Variables in Puget Sound*. Prepared by PTI Environmental Services, Bellevue, WA. Region 10, U.S. Environmental Protection Agency, Seattle, WA. (Looseleaf)
- Randall, R.C., H. Lee II, R.J. Ozretich, J.L. Lake, and R.J. Pruell. 1991. Evaluation of selected lipid methods for normalizing pollutant bioaccumulation. *Environ. Toxicol. Chem.* 10:1431-1436.
- Rappe, C., H.R. Buser, D.L. Stalling, L.M. Smith, and R.C. Dougherty. 1981. Identification of polychlorinated dibenzofurans in environmental samples. *Nature* 292:524-526.
- Reed, M.S., and C.F. Rabeni. 1989. Characteristics of an unexploited smallmouth bass population in a Missouri Ozark stream. *Am. J. Fish. Man.* 9:420-426.

- Reinert, R.E., B.A. Knuth, M.A. Kamrin, and Q.J. Stober. 1991. Risk assessment, risk management, and fish consumption advisories in the United States. *Fisheries* (6):5-12.
- Robinson, J.C., W.S. Pease, D.S. Albright, et al. 1994. *Pesticides in the Home and Community: Health Risks and Policy Alternatives. California Policy Seminar Report*. Center for Occupational and Environmental Health, School of Public Health, University of California, Berkeley, CA.
- Rohlf, F.J., H.R. Akcakaya, and S.P. Ferraro. 1991. *Optimizing Composite Sampling Protocols*. Contract 68-CO-0051. Prepared for the U.S. Environmental Protection Agency. Applied Biomathematics, Corvallis, OR.
- Rosen, B. 1970. Shell disease of aquatic crustaceans. pp. 409-415. In: *A Symposium of Diseases of Fish and Shellfishes*. S.F. Sniezko (ed.). Amer. Fish. Soc. Spec. Publ. No. 5. American Fisheries Society, Washington, DC.
- RTI (Research Triangle Institute). 1993. *National Listing of State Fish and Shellfish Consumption Advisories and Bans*. Prepared for Office of Science and Technology, U.S. Environmental Protection Agency. Research Triangle Park, NC.
- Ryan, J.J., P.Y. Lau, and J.A. Hardy. 1986. 2,3,7,8, Tetrachlorodibenzo-p-dioxin and related dioxans and furans in snapping turtle (*Chelydra serpentina*) tissues from the upper St. Lawrence River. *Chemosphere* 15 (5):537-548.
- Rylander, L., U. Stromberg, and L. Hagmar. 1998. Agreement between reported fish consumption obtained by two interviews and its impact on the results in a reproduction study. *European J. Epidemiol.* 14(1):93-97.
- Sabbioni, E., M. Fischbach, G. Pozzi, R. Pietra, M. Gallorini, and J.L. Piette. 1991. Cellular retention, toxicity and carcinogenic potential of seafood arsenic. I. Lack of cytotoxicity and transforming activity of arsenobetaine in the BAL3/3T3 cell line. *Carcinogenesis* 12:1287-1291.
- Safe, S. 1985. *CRC Critical Reviews in Toxicology. Polychlorinated Biphenyls (PCBs) and Polybrominated Biphenyls (PBBs): Biochemistry, Toxicology and Mechanism of Action*. CRC Press, Cleveland, OH.
- Safe, S. 1990. Polychlorinated biphenyls (PCBs), dibenzo-p-dioxins (PCDDs), dibenzofurans (PCDFs), and related compounds: Environmental and mechanistic considerations which support the development of toxic equivalency factors (TEFs). *Critical Reviews in Toxicology* 21(1):51-88.

- Safe, S., B. Astroff, M. Harris, T. Zacharewski, R. Dickerson, M. Romkes, and L. Biegel. 1991. 2,3,7,8-Tetrachlorodibenzo-p-dioxin and related compounds as antiestrogens: Characterization and mechanism of action. *Pharmacology and Toxicology* 69:400-409.
- Saleh, M.A. 1991. Toxaphene: Chemistry, biochemistry, toxicity, and environmental fate. *Rev. Environ. Contam. Toxicol.* 118:1-66.
- Sax, I.N. 1984. *Dangerous Properties of Industrial Materials*. 6th Edition. Van Nostrand Reinhold Company, New York, NY.
- Schmitt, C.J., and W.G. Brumbaugh. 1990. National Contaminant Biomonitoring Program: Concentrations of arsenic, cadmium, copper, lead, mercury, selenium, and zinc in U.S. freshwater fish, 1978-1984. *Arch. Environ. Contam. Toxicol.* 19:731-747.
- Schmitt, C.J., and S.E. Finger. 1987. The effects of sample preparation on measured concentrations of eight elements in edible tissues of fish from streams contaminated by lead mining: *Arch. Environ. Contam. Toxicol.* 16:185-207.
- Schmitt, C.J., M.A. Ribick, J.K. Ludke, and T.W. May. 1983. *National Pesticide Monitoring Program: Organochlorine Residues in Freshwater Fish, 1976-1979*. Resource Publication 152. Fish and Wildlife Service, U.S. Department of the Interior, Washington, DC.
- Schmitt, C.J., J.L. Zajicek, and P.H. Peterman. 1990. National Contaminant Biomonitoring Program: Residues of organochlorine chemicals in U.S. freshwater fish, 1976-1984. *Arch. Environ. Contam. Toxicol.* 19:748-781.
- Schmitt, C.J., J.L. Zajicek, and M.A. Ribick. 1985. National Pesticide Monitoring Program: Residues of organochlorine chemicals in freshwater fish, 1980-1981. *Arch. Environ. Contam. Toxicol.* 14:225-260.
- Schwartz, T.R., R.D. Campbell, D.L. Stalling, R.L. Little, J.D. Petty, J.W. Hogan, and E.M. Kaiser. 1984. Laboratory data base for isomer-specific determination of polychlorinated biphenyls. *Anal. Chem.* 56:1303-1308.
- Schwartz, T.R., D.L. Stalling, and C.L. Rice. 1987. Are polychlorinated biphenyl residues adequately described by Aroclor mixture equivalents? Isomer-specific principal components analysis of such residues in fish and turtles. *Environ. Sci. Technol.* 21(1):72-76.
- Schwartz, T.R., D.E. Tilitt, K.P. Feltz, and P.H. Peterman. 1993. Determination of mono- and non-O, Omin-chlorine substituted polychlorinated biphenyls in Aroclors and environmental samples. *Chemosphere* 26(8):1443-1461.

- Scott, D.E., F.W. Whicker, and J.W. Gibbons. 1986. Effect of season on the retention of ¹³⁷Cs and ⁹⁰Sr by the yellow-bellied slider turtle (*Pseudemys scripta*). *Can. J. Zool.* 64:2850-2853
- Sexton, O.J. 1959. A method of estimating the age of painted turtles for use in demographic studies. *Ecology* 40:716-718.
- Shain, W., B. Bush, and R. Seegal. 1991. Neurotoxicity of polychlorinated biphenyls: structure-activity relationship of individual congeners. *Toxicol. Appl. Pharmacol.* 111:33-42.
- Sheffy, T.B. 1987. *A Review of Mercury in Wisconsin's Environment. Recommendations for Studying and Identifying the Cause of the Problem.* Bureau of Air Management, Wisconsin Department of Natural Resources, Madison, WI.
- Short, J.W., and F.P. Thrower. 1987a. Accumulations of butyltins in muscle tissue of chinook salmon reared in sea pens treated with tri-n-butyltin. *Aquaculture* 61:181-192.
- Short, J.W., and F.P. Thrower. 1987b. Toxicity of tri-n-butyltin to chinook salmon, *Oncorhynchus tshawytscha*, adapted to seawater. *Aquaculture* 61:193-200.
- Siewicki, T.C. 1981. Tissue retention of arsenic in rats fed witch flounder or cacodylic acid. *J. Nutr.* 111:602-609.
- Sinderman, C.J. 1983. An examination of some relationships between pollution and disease. *Rapp. P. V. Reun. Cons. Int. Explor. Mer.* 182:37-43.
- Sinderman, C.J., F.B. Bang, N.O. Christensen, V. Dethlefsen, J.C. Harshbarger, J.R. Mitchell, and M.F. Mulcahy. 1980. The role and value of pathology in pollution effects monitoring programs. *Rapp. P. V. Reun. Cons. Int. Explor. Mer.* 179:135-151.
- Sinderman, C.J., and A. Rosenfield. 1967. Principal diseases of commercially important marine bivalve mollusca and crustacea. *Fish. Bull.* 66:335-385.
- Skerfving, S. B.G. Svensson, L. Asplund, and L. Hagmar. 1994. Exposure to mixtures and congeners of polychlorinated biphenyls. *Clinical Chemistry*, 40(7):1409-1415.
- Skerfving, S. 1988. Mercury in women exposed to methylmercury through fish consumption, and in their newborn babies and breast milk. *Bull. Environ. Contam. Toxicol.* 41:475-482.

- Skoog, D.A. 1985. *Principles of Instrumental Analysis*. 3rd ed. Saunders Press, Philadelphia, PA. pp. 270-277, 282-284, 303-304.
- Sloan, K., and J.E. Lovich. 1995. Exploitation of the alligator snapping turtle, *Macrolemys temminckii*, in Louisiana: A case study. *Chelonian Conserv. Biol.* 1(3):221-222.
- Smith, L.M. 1981. Carbon dispersed on glass fibers as an adsorbent for contaminant enrichment and fractionation. *Anal. Chem.* 53:2152-2154.
- Smith, R.L. 1985. *Guidance on Sampling Aquatic Organisms for Tissue Analyses during FY 1986*. Environmental Services Division, Region 3, U.S. Environmental Protection Agency, Philadelphia, PA.
- Smith, L.M., T.R. Schwartz, and K. Feltz. 1990. Determination and occurrence of AHH-active polychlorinated biphenyls, 2,3,7,8-tetrachloro-p-dioxin and 2,3,7,8-tetrachlorodibenzofuran in Lake Michigan sediment and biota, the question of their relative toxicological significance. *Chemosphere* 21(9):1063-1085.
- Smith, R.A., R.B. Alexander, and M.G. Wolman. 1987. Water quality trends in the nation's rivers. *Science* 235:1607-1615.
- Spry, D.S., and J.G. Wiener. 1991. Metal availability and toxicity to fish in low-alkalinity lakes: a critical review. *Environ. Pollut.* 71(2-4):243-304.
- Stalling, D.L., T.R. Schwartz, W.J. Dunn III, and S. Wold. 1987. Classification of polychlorinated biphenyl residues. *Anal. Chem.* 59:1853-1859.
- Stegeman, J.J., and J.J. Lech. 1991. Cytochrome P-450 monooxygenase systems in aquatic species: carcinogen metabolism and biomarkers for carcinogen and pollutant exposure. *Environ. Health Perspect.* 90:101-109.
- Stephenson, M.D., and D.R. Smith. 1988. Determination of tributyltin in tissues and sediments by graphite furnace atomic absorption spectrometry. *Anal. Chem.* 60:696-698.
- Stober, Q.J. 1991. *Guidelines for Fish Sampling and Tissue Preparation for Bioaccumulative Contaminants*. Environmental Services Division, Region 4, U.S. Environmental Protection Agency, Athens, GA.
- Stone, W.B., E. Kiviat, and S.A. Butkas. 1980. Toxicants in snapping turtles. *New York Fish and Game J.* 27 (1):39-50.

- Stone, S.L., T.A. Lowery, J.D. Field, C.D. Williams, D.M. Nelson, S.H. Jury, M.E. Monaco, and L. Andreasen. 1994. *Distribution and Abundance of Fishes and Invertebrates in Mid-Atlantic Estuaries*. ELMR Rep. No. 12. NOAA/NOS Strategic Environmental Assessments Division, Silver Spring, MD.
- Swackhamer, D. 1993. University of Minnesota. Personal communication.
- Tanabe, S., N. Kannan, A. Subramanian, S. Watanabe, and R. Tatsukawa. 1987. *Environ. Poll.* 47:147-163.
- Taylor, J.K. 1985. *Standard Reference Materials: Handbook for SRM Users*. NBS Special Publication 260-100. Center for Analytical Chemistry, U.S. Department of Commerce, National Bureau of Standards, Gaithersburg, MD.
- Tetra Tech. 1986. *Evaluation of Survey Positioning Method for Near-Shore and Estuarine Waters*. Prepared for Office of Marine and Estuarine Protection, U.S. Environmental Protection Agency. Bellevue, WA.
- Tetra Tech. 1995. *Assessing Human Health Risks from Chemically Contaminated Fish in the Lower Columbia River*. Draft report prepared for the Lower Columbia Bi-State Program. Redmond, WA.
- Texas Water Commission. 1990. *Texas Tissue Sampling Guidelines*. Texas Water Commission, Austin, TX.
- Tilson, H.A., J.L. Jacobson, and W.J. Rogan. 1990. Polychlorinated biphenyls and the developing nervous systems: Cross-species comparisons. *Neurotox. Teratol.* 12:239-248.
- Todd, B. L., and C.F. Rabeni. 1989. Movement and habitat use by stream-dwelling smallmouth bass. *Transact. Am. Fish. Soc.* 118 (3):229-242.
- Tollefson, Linda. 1989. Methylmercury in fish: Assessment of risk for U.S. consumers. In: *The Risk Assessment of Environmental and Human Health Hazards: A Textbook of Case Studies*. Dennis J. Paustenback (ed.). John Wiley & Sons, New York, NY.
- Toy, K.A., N.L. Polissar, S. Liao, and G.D. Mittelstaedt. 1996. *A Fish Consumption Survey of the Tulalip and Squaxin Island Tribes of the Puget Sound Region*. Tulalip Tribes, Department of Environment, Marysville, WA.
- Tsuda, T., H. Nakanishi, S. Aoki, and J. Takebayashi. 1988. Bioconcentration and metabolism of butyltin compounds in carp. *Water Res.* 22:647-651.

- Tsuda, T., M. Kojima, H. Harada, et al. 1997. Acute toxicity, accumulation and excretion of organophosphorous insecticides and their oxidation products in killifish. *Chemosphere* 35: 939-49, 1997.
- USDA/ARS (U.S. Department of Agriculture, Agricultural Research Service). 1998. *1994-1996 Continuing Survey of Foods Intakes by Individuals and 1994-1996 Diet and Health Knowledge Survey*. CD-ROM, accession number PB-98-500457. (Available from the National Technical Information Service, 5285 Port Royal Road, Springfield, VA 22161. Phone: 203-487-4650.)
- U.S. DOC (Department of Commerce). 1999a. *General Endangered and Threatened Marine Species, Permits for Incidental Taking of Species*. 50 CFR Part 222, Section 222.307. National Marine Fisheries Service, Washington, DC.
- U.S. DOC (Department of Commerce). 1999b. *General Endangered and Threatened Marine Species, Permits for Listed Species of Sea Turtles Involving the US Fish and Wildlife Service*. 50 CFR Part 222, Section 222.309. National Marine Fisheries Service, Washington, DC.
- U.S. DOI (Department of the Interior). 1999. *Endangered and Threatened Wildlife and Plants. Permits for Scientific Purposes, Enhancement of Propagation or Survival, or for Incidental Taking*. 50 CFR Part 17, Section 17.22. Fish and Wildlife Service, Washington, DC.
- U.S. EPA (U.S. Environmental Protection Agency). 1978. *Metal Bioaccumulation in Fish and Aquatic Invertebrates*. EPA-600/3-78-103. Environmental Research Laboratory, Office of Research and Development, Springfield, VA.
- U.S. EPA (U.S. Environmental Protection Agency). 1979a. *Health Assessment Document for Cadmium*. EPA-600/8-79-003. Environmental Standards and Criteria, Office of Research and Development, Research Triangle Park, NC.
- U.S. EPA (U.S. Environmental Protection Agency). 1979b. *Methods for the Chemical Analysis of Water and Wastes*. EPA-600/4-79-020. Environmental Monitoring and Support Laboratory, Cincinnati, OH.
- U.S. EPA (U.S. Environmental Protection Agency). 1980a. *Ambient Water Quality Criteria for Endrin*. EPA-440/5-80-047. Office of Water Regulations and Standards, Washington, DC.
- U.S. EPA (U.S. Environmental Protection Agency). 1980b. *Interim Guidelines and Specifications for Preparing Quality Assurance Project Plans*. QAMS-005/80. Quality Assurance Management Staff, Washington, DC.

- U.S. EPA (U.S. Environmental Protection Agency). 1981. *Interim Methods for the Sampling and Analysis of Priority Pollutants in Sediments and Fish Tissue*. EPA-600/4-81-055. Environmental Monitoring and Support Laboratory, Cincinnati, OH.
- U.S. EPA (U.S. Environmental Protection Agency). 1982a. *Methods for the Chemical Analysis of Municipal and Industrial Wastewater*. EPA-600/4-82-057. Environmental Monitoring and Support Laboratory, Cincinnati, OH.
- U.S. EPA (U.S. Environmental Protection Agency). 1982b. Arsenic. In: *Intermedia Priority Pollutant Guidance Documents*. Office of Pesticides and Toxic Substances, Washington, DC.
- U.S. EPA (U.S. Environmental Protection Agency). 1983a. *Analyses of the Risks and Benefits of Seven Chemicals Used for Subterranean Termite Control*. EPA-540/9-83-005. Office of Pesticide Programs, Washington, DC.
- U.S. EPA (U.S. Environmental Protection Agency). 1984a. Internal memorandum from G. LaRocca to B. Burnam et al., August 16, 1984. Office of Pesticide Programs, Washington, DC.
- U.S. EPA (U.S. Environmental Protection Agency). 1984b. *Policy and Program Requirements to Implement the Quality Assurance Program*. EPA Order 5360.1. Quality Assurance Management Staff, Washington, DC.
- U.S. EPA (U.S. Environmental Protection Agency). 1985a. *Bioaccumulation Monitoring Guidance: 3. Recommended Analytical Detection Limits*. EPA-503/6-90-001. Office of Marine and Estuarine Protection, Washington, DC.
- U.S. EPA (U.S. Environmental Protection Agency). 1985b. *Development of Statistical Distribution for Ranges of Standard Factors Used in Exposure Assessment*. EPA-600/8-85-010. Office of Health and Environmental Assessment, Washington, DC.
- U.S. EPA (U.S. Environmental Protection Agency). 1985c. *Guidance for the Registration of Pesticide Products Containing Lindane as the Active Ingredient*. EPA-540/RS-86-121. Office of Pesticide Programs, Washington, DC.
- U.S. EPA (U.S. Environmental Protection Agency). 1985d. *Pesticide Fact Sheet—Terbufos*. Office of Pesticides and Toxic Substances, Office of Pesticide Programs, Washington, DC.

- U.S. EPA (U.S. Environmental Protection Agency). 1986a. *Bioaccumulation Monitoring Guidance: 4. Analytical Methods for U.S. EPA Priority Pollutants and 301(h) Pesticides in Tissues from Marine and Estuarine Organisms*. EPA-503/6-90-002. Office of Marine and Estuarine Protection, Washington, DC.
- U.S. EPA (U.S. Environmental Protection Agency). 1986b. *Pesticide Fact Sheet—Diazinon*. Office of Pesticides and Toxic Substances, Office of Pesticide Programs, Washington, DC.
- U.S. EPA (U.S. Environmental Protection Agency). 1986c. *Research and Development Methodology for Evaluating Potential Carcinogenicity in Support of Reportable Quality Adjustments to CERCLA Section 102*. OHEA-C-073 Draft. Carcinogen Assessment Group Office of Environmental Assessment, Washington, DC.
- U.S. EPA (U.S. Environmental Protection Agency). 1986d. *Test Methods for the Evaluation of Solid Waste, Physical/Chemical Methods*. SW-846; 3rd Edition (with 1990 updates). Office of Solid Waste and Emergency Response, Washington, DC.
- U.S. EPA (U.S. Environmental Protection Agency). 1987a. *Bioaccumulation Monitoring Guidance: 2. Selection of Target Species and Review of Available Data*. EPA-430/9-86-005. Office of Marine and Estuarine Protection, Washington, DC.
- U.S. EPA (U.S. Environmental Protection Agency). 1987b. *Bioaccumulation Monitoring Guidance: 5. Strategies for Sample Replication and Compositing*. EPA-430/9-87-003. Office of Marine and Estuarine Protection, Washington, DC.
- U.S. EPA (U.S. Environmental Protection Agency). 1987c. *Cadmium Health Advisory Draft*. Office of Drinking Water, Washington, DC.
- U.S. EPA (U.S. Environmental Protection Agency). 1987d. *National Dioxin Study. Tiers 3, 5, 6, and 7*. EPA-440/4-87-003. Office of Water Regulations and Standards, Washington, DC.
- U.S. EPA (U.S. Environmental Protection Agency). 1987e. *Quality Assurance/Quality Control (QA/QC) for 301(h) Monitoring Programs: Guidance on Field and Laboratory Methods*. EPA-430/9-86-004. Office of Marine and Estuarine Protection, Washington, DC.
- U.S. EPA (U.S. Environmental Protection Agency). 1987f. *The Risk Assessment Guidelines of 1986*. EPA/600/8-87/045. Office of Health and Environmental Assessment, Washington, DC.

- U.S. EPA (U.S. Environmental Protection Agency). 1988a. *Drinking Water Criteria Document for Polychlorinated Biphenyls (PCBs)*. ECAO-CIN-414. Prepared by Environmental Criteria and Assessment Office for Office of Drinking Water, Washington, DC.
- U.S. EPA (U.S. Environmental Protection Agency). 1988b. *Pesticide Fact Sheet: Tributyltin (Antifouling Paints)*. Number 143. September 23, 1988. Office of Pesticides and Toxic Substances, Office of Pesticide Programs, Washington, DC.
- U.S. EPA (U.S. Environmental Protection Agency). 1989a. *Analytical Procedures and Quality Assurance Plan for the Determination of Mercury in Fish*. Draft. Environmental Research Laboratory, Duluth MN.
- U.S. EPA (U.S. Environmental Protection Agency). 1989b. *Analytical Procedures and Quality Assurance Plan for the Determination of PCDD/PCDF in Fish*. EPA-600/3-90-022. Environmental Research Laboratory, Duluth, MN.
- U.S. EPA (U.S. Environmental Protection Agency). 1989c. *Analytical Procedures and Quality Assurance Plan for the Determination of Xenobiotic Chemical Contaminants in Fish*. EPA-600/3-90-023. Environmental Research Laboratory, Duluth, NM.
- U.S. EPA (U.S. Environmental Protection Agency). 1989d. *Assessing Human Health Risks from Chemically Contaminated Fish and Shellfish: A Guidance Manual*. EPA-503/8-89-002. Office of Water Regulations and Standards, Office of Marine and Estuarine Protection, Washington, DC.
- U.S. EPA (U.S. Environmental Protection Agency). 1989e. *Pesticide Fact Sheet—Ethion*. Office of Pesticides and Toxic Substances, Office of Pesticide Programs, Washington, DC.
- U.S. EPA (U.S. Environmental Protection Agency). 1990a. *Exposure Factors Handbook*. EPA 600/8-89/043. Office of Health and Environmental Assessment, Washington, DC.
- U.S. EPA (U.S. Environmental Protection Agency). 1990b. *Test Methods for Evaluating Solid Waste, Physical/Chemical Methods*. SW-846, 3rd edition, proposed Update II. Office of Solid Waste and Emergency Response, Washington, DC.
- U.S. EPA (U.S. Environmental Protection Agency). 1990c. *Tetrachlorodibenzo-p-Dioxins and-Dibenzofurans in Edible Fish Tissue at Selected Sites in Arkansas and Texas*. Water Quality Management Branch and Surveillance Branch, Region 6, Dallas, TX.

- U.S. EPA (U.S. Environmental Protection Agency). 1990d. *Work Plan for FY 91 Regional Ambient Fish Tissue Monitoring Program Activity No. ELR 80*. Environmental Monitoring and Compliance Branch, Region 7, Kansas City, KS.
- U.S. EPA (U.S. Environmental Protection Agency). 1991a. *Assessment and Control of Bioconcentratable Contaminants in Surface Waters*. Draft. Office of Research and Development, Washington, DC.
- U.S. EPA (U.S. Environmental Protection Agency). 1991b. *Contract Laboratory Program Statement of Work for Inorganic Analysis, Multi-Media, Multi-Concentration*. SOW 788, July. Washington, DC.
- U.S. EPA (U.S. Environmental Protection Agency). 1991c. *Contract Laboratory Program Statement of Work for Organic Analysis*. Washington, DC.
- U.S. EPA (U.S. Environmental Protection Agency). 1991d. *Environmental Monitoring and Assessment Program (EMAP) Near Coastal Program Laboratory Methods for Filleting and Compositing Fish for Organic and Inorganic Contaminant Analyses*. Draft. Office of Research and Development, Environmental Research Laboratory, Narragansett, RI.
- U.S. EPA (U.S. Environmental Protection Agency). 1991e. *Environmental Monitoring and Assessment Program (EMAP) Near Coastal Virginian Province Quality Assurance Project Plan*. Draft. Office of Research and Development, Environmental Research Laboratory, Narragansett, RI.
- U.S. EPA (U.S. Environmental Protection Agency). 1991f. *Environmental Monitoring Methods Index, Version 1.0 Software, User's Manual, EMMI User Support*. Office of Water, Sample Control Center, Alexandria, VA.
- U.S. EPA (U.S. Environmental Protection Agency). 1991g. *Methods for the Determination of Metals in Environmental Samples*. EPA-600/4-91/010. Environmental Monitoring Systems Laboratory, Office of Research and Development, Cincinnati, OH.
- U.S. EPA (U.S. Environmental Protection Agency). 1991h. *National Bioaccumulation Study*. Draft. Office of Water Regulations and Standards, Washington, DC.
- U.S. EPA (U.S. Environmental Protection Agency). 1992a. *Classification List of Chemicals Evaluated for Carcinogenicity Potential*. Office of Pesticide Programs, Washington, DC.
- U.S. EPA (U.S. Environmental Protection Agency). 1992b. *Consumption Surveys for Fish and Shellfish: A Review and Analysis of Survey Methods*. EPA-822/R-92-001. Office of Water, Washington, DC.

- U.S. EPA (U.S. Environmental Protection Agency). 1992c. *National Study of Chemical Residues in Fish*. Volume I. EPA-823/R-92-008a. Office of Science and Technology, Washington, DC.
- U.S. EPA (U.S. Environmental Protection Agency). 1992d. *National Study of Chemical Residues in Fish*. Volume II. EPA-823/R-92-008b. Office of Science and Technology, Washington, DC.
- U.S. EPA (U.S. Environmental Protection Agency). 1992e. *304(a) Criteria and Related Information for Toxic Pollutants*. Spreadsheet. Water Quality Standards Unit, Water Management Division, Region 4, Atlanta, GA.
- U.S. EPA (U.S. Environmental Protection Agency). 1993a. *Fate One Liner Database*. Office of Pesticide Programs, Washington, DC.
- U.S. EPA (U.S. Environmental Protection Agency). 1993b. Notice of receipt of requests for amendments to delete uses in certain pesticide registration. *Federal Register* 58(220):60630-60631.
- U.S. EPA (U.S. Environmental Protection Agency). 1993c. *Provisional Guidance for Quantitative Risk Assessment of Polycyclic Aromatic Hydrocarbons*. EPA/600/R-93/089. Environmental Criteria and Assessment Office, Office of Health and Environmental Assessment, Cincinnati, OH.
- U.S. EPA (U.S. Environmental Protection Agency). 1993d. *Reference Dose Tracking Report*. Office of Pesticide Programs, Health Effects Division, Washington, DC.
- U.S. EPA (U.S. Environmental Protection Agency). 1993e. *Workshop Report on Developmental Neurotoxic Effects Associated with Exposure to PCBs*. September 14-15, 1992, Research Triangle Park, NC. Risk Assessment Forum, Washington, DC.
- U.S. EPA (U.S. Environmental Protection Agency). 1994. *Endangered and Threatened Wildlife and Plants*. 50 CFR 17.11 and 17.12. June 30.
- U.S. EPA (U.S. Environmental Protection Agency). 1995a. *Guidance on Establishing Trace Metal Clean Rooms in Existing Facilities*. Draft. EPA 821-B-95-001. Office of Water, Engineering and Analysis Division, Washington, DC.
- U.S. EPA (U.S. Environmental Protection Agency). 1995b. *Method 1613b. Tetra- through Octa-Chlorinated Dioxins and Furans by Isotope Dilution HRGC/HRMS*. Final Draft. Office of Water, Office of Science and Technology, Washington, DC.

- U.S. EPA (U.S. Environmental Protection Agency). 1995c. *Method 1631: Mercury in Water by Oxidation, Purge and Trap, and Cold Vapor Atomic Fluorescence Spectrometry*. Draft. EPA 821-R-95-027. Office of Water, Engineering and Analysis Division, Washington, DC.
- U.S. EPA (U.S. Environmental Protection Agency). 1995d. *Method 1632: Determination of Inorganic Arsenic in Water by Hydride Generation Flame Atomic Absorption*. Draft. EPA 821-R-95-028. Office of Water, Engineering and Analysis Division, Washington, DC.
- U.S. EPA (U.S. Environmental Protection Agency). 1995e. *Method 1637: Determination of Trace Elements in Ambient Waters by Chelation Preconcentration with Graphite Furnace Atomic Absorption*. EPA 821-R-95-030. Office of Water, Engineering and Analysis Division, Washington, DC.
- U.S. EPA (U.S. Environmental Protection Agency). 1995f. *Method 1638: Determination of Trace Elements in Ambient Waters by Inductively Coupled Plasma-Mass Spectrometry*. Office of Water, Engineering and Analysis Division, Washington, DC.
- U.S. EPA (U.S. Environmental Protection Agency). 1995g. *Method 1639: Determination of Trace Elements in Ambient Waters by Stabilized Temperature Graphite Furnace Atomic Absorption*. EPA 321-R-95-032. Office of Water, Engineering and Analysis Division, Washington, DC.
- U.S. EPA (U.S. Environmental Protection Agency). 1995h. *Guidance on the Documentation and Evaluation of Trace Metals Data Collected for Clean Water Act Compliance Monitoring*. EPA 821-B-95-002. Office of Water, Engineering and Analysis Division, Washington, DC.
- U.S. EPA (U.S. Environmental Protection Agency). 1995i. *QA/QC Guidance for Sampling and Analysis of Sediments, Water, and Tissues for Dredged Material Evaluations—Chemical Evaluations*. EPA 823-B-95-001. Office of Water, Washington, DC, and Department of the Army, U.S. Army Corps of Engineers, Washington, DC.
- U.S. EPA (U.S. Environmental Protection Agency). 1995j. *Health Effects Document for Terbufos*. Office of Pesticide Programs, Washington, DC.
- U.S. EPA (U.S. Environmental Protection Agency). 1996. *PCBs: Cancer Dose-Response Assessment and Application to Environmental Mixtures*. EPA/6001P-96/00F. National Center for Environmental Assessment, Office of Research and Development, Washington, DC.

- U.S. EPA (U.S. Environmental Protection Agency). 1997a. *Draft Method 1668 Toxic Polychlorinated Biphenols by Isotope Dilution High Gas Chromatography/High Resolution Mass Spectrometry*. Office of Water, Washington, DC. March.
- U.S. EPA (U.S. Environmental Protection Agency). 1997b. *Exposure Factors Handbook, Volume 1, General Factors*. EPA/600/P-95/002Fa. Office of Research and Development, Washington, DC. August.
- U.S. EPA (Environmental Protection Agency). 1997c. *Mercury Study Report to Congress*. EPA-452R-96-001a and b. Office of Air Quality Planning and Standards and Office of Research and Development.
- U.S. EPA (Environmental Protection Agency). 1998a. *Daily average per capita fish consumption estimates based on the combined USDA 1989, 1990, and 1991 continuing survey of food intakes by individuals (CSFII)*. Volume I: Uncooked Fish Consumption National Estimates. Office of Science and Technology, Washington, DC (unpublished report).
- U.S. EPA (U.S. Environmental Protection Agency). 1998b. *Guidance for Conducting Fish and Wildlife Surveys*. EPA-823-B-98-007, November. Office of Water, Washington, DC.
- U.S. EPA (U.S. Environmental Protection Agency). 1998c. *Reregistration Eligibility Decision (RED). Dicofol*. Office of Pesticide Programs and Toxic Substances, Washington, DC.
- U.S. EPA (Environmental Protection Agency) 1998d. *Health Effects Test Guidelines, OPPTS 870.1000. Acute Toxicity Testing - Background: Prevention, Pesticides and Toxic Substances*. EPA-712-C-98-189. Office of Pesticide Programs, Washington, DC.
- U.S. EPA (U.S. Environmental Protection Agency). 1998e. Memorandum dated September 24, 1998. *Reused Oxyfluofen (Goal) Quantitative Risk Assessment (Q1) based on CD-1 male mouse dietary study with 3/4's Interspecies Scaling Factor*. HRD Doc. No. 012879.
- U.S. EPA (U.S. Environmental Protection Agency). 1999a. *National Listing of Fish and Wildlife Advisories database-1998*. Office of Science and Technology, Office of Water, Washington DC.
- U.S. EPA (U.S. Environmental Protection Agency). 1999b. *Classification List of Chemicals Evaluated for Carcinogenicity Potential*. Office of Pesticide Programs and Toxic Substances, Washington, DC.

- U.S. EPA (Environmental Protection Agency), 1999c. *EPA Fact Sheet -Update: National Listing of Fish and Wildlife Advisories*. EPA-823-F-99-005. Office of Water, Washington DC.
- U.S. EPA (Environmental Protection Agency). 1999d. *The National Survey of Mercury Concentrations in Fish - Database Summary 1990-1995*. EPA-823-R-99-014. Office of Water, Washington, DC.
- U.S. EPA (U.S. Environmental Protection Agency). 2000a. *Guidance for Assessing Chemical Contaminant Data for Use in Fish Advisories—Risk Assessment and Fish Consumption Limits*. Volume 2. 3rd Edition. EPA 823-B-00-008. Office of Water, Washington, DC.
- U.S. EPA (Environmental Protection Agency). 2000b. *Revised Human Health Risk Assessment for Chlorpyrifos*. Office of Pesticide Programs, Washington, DC.
- U.S. EPA (Environmental Protection Agency). 2000c. *Estimated Per Capita Fish Consumption in the United States*. EPA-821-R-00-025. Office of Science and Technology, Washington, DC.
- U.S. FDA (Food and Drug Administration). 1990. *Pesticide Analytical Manual, Volumes I and II*. Report No. FDA/OM0-90/15A. U.S. Department of Health and Human Services, Washington, DC.
- U.S. FDA (Food and Drug Administration). 1993. *Guidance Document for Arsenic in Shellfish*. Center for Food Safety and Applied Nutrition, Washington, DC. January.
- U.S. FDA (Food and Drug Administration). 1998. *Action Levels for Poisonous or Deleterious Substances in Human Food and Animal Feed. Industry Activities*. Staff Booklet. Washington, DC.
- U.S. FWS (Fish and Wildlife Service). 1994. *Endangered Species Database*. December 1994.
- USGS (U.S. Geological Survey). 1987. Methods for the determination of organic substances in water and fluvial sediments. Chapter A3. In: *Techniques of Water-Resources Investigations of the United States Geological Survey*. R.L. Wershaw, M.J. Fishman, R.R. Grable, and L.E. Lowe (eds). Books and Open-File Reports Section, Denver, CO.
- Vahter, M., and J. Envall. 1983. In vivo reduction of arsenate in mice and rabbits. *Environ. Res.* 32:14-24.
- Vahter, M., E. Marafante, and L. Dencker. 1983. Metabolism of arsenobetaine in mice, rats and rabbits. *Sci. Total Environ.* 30:197-211.

- Vallee, B.L., D.D. Ulmer, and W.E.C. Wacker. 1960. Arsenic toxicology and biochemistry. *Arch. Ind. Health* 21:132-151.
- Van den Berg, M., L. Birnbaum, A.T.C. Bosveld, et al. 1998. Toxic equivalency factors (TEFs) for PCBs, PCDDs, PCDFs for human and wildlife *Environ. Health Perspect.* 106(12):775-792.
- Varanasi, U., and D.J. Gmur. 1980. Metabolic activation and covalent binding of benzo[a]pyrene to deoxyribonucleic acid catalyzed by liver enzymes of marine fish. *Biochem. Pharmacol.* 29:753-762.
- Varanasi, U., and D.J. Gmur. 1981. In vivo metabolism of naphthalene and benzo[a]pyrene of flatfish. In: *Chemical Analysis and Biological Fate: Polynuclear Aromatic Hydrocarbons*. M. Cooke and A.J. Dennis (eds.). Fifth International Symposium, Columbus, OH, Battelle Press. pp. 367-376.
- Varanasi, U., W.L. Reichert, J.E. Stein, et al. 1985. Bioavailability and biotransformation of aromatic hydrocarbons in benthic organisms exposed to sediment from an urban estuary. *Environ. Sci. Technol.* 19:836-841.
- Versar, Inc. 1982. *Sampling Protocols for Collecting Surface Water, Bed Sediment, Bivalves and Fish for Priority Pollutant Analysis—Final Draft Report*. EPA Contract 68-01-6195. Prepared for Office of Water Regulations and Standards, U.S. Environmental Protection Agency. Springfield, VA.
- Versar, Inc. 1984. *Sampling Guidance Manual for the National Dioxin Study—Final Draft Report*. EPA Contract 68-01-6160. Prepared for Office of Water Regulations and Standards, U.S. Environmental Protection Agency. Springfield, VA.
- Voiland, M.P., K.L. Gall, D.J. Lisk, and D.B. MacNeill. 1991. Effectiveness of recommended fat-trimming procedures on the reduction of PCB and Mirex levels in Brown trout (*Salmo trutta*) from Lake Ontario. *J. Great Lakes Res.* 17(4):454-460.
- Wade, T.L., B. Garcia-Romero, and J.M. Brooks. 1988. Tributyltin contamination of bivalves from U.S. coastal estuaries. *Env. Sci. Technol.* 22:1488-1492.
- Walsh, P.R., R.A. Duce, and J.L. Fasching. 1979. Considerations of the enrichment, sources, and flux of arsenic in the troposphere. *J. Geophys Res.* 84(C4):1719-1726.
- Wanderstock, J., W. Iskat, W. Gutenmann, and D. Lisk. 1971. Effect of several cooking methods on concentration of DDT residues in lake trout and coho salmon. *New York Fish and Game J.* 18:70-72.

- Wania, F., and D. Mackay. 1993. Global fractionation and cold condensation of low volatility organochlorine compounds in polar regions. *Ambio* 22:10-18.
- Wania, F., and D. Mackay. 1996. Tracking the distribution of persistent organic pollutants. *Environ. Sci. Technol.* 30(9):390A-396A.
- Ward, G.S., G.C. Cramm, P.R. Parrish, H. Trachman, and A. Slesinger. 1981. Bioaccumulation and chronic toxicity of bis(tributyltin) oxide (TBTO): tests with a saltwater fish. In: *Aquatic Toxicology and Hazard Assessment*. D.R. Branson and K.L. Dickson (eds.). American Society of Testing and Materials, Publication No. ASTM STP 737, Philadelphia, PA. pp. 183-200.
- Ware, G.W. 1978. *The Pesticide Book*. W.H. Freeman and Company, San Francisco, CA.
- WDNR (Wisconsin Department of Natural Resources). 1988. *Fish Contaminant Monitoring Program—Field and Laboratory Guidelines*. Report No. 1005.1. Madison, WI.
- Weber, C.I. (ed.) 1973. *Biological Field and Laboratory Methods for Measuring the Quality of Surface Waters and Effluents*. EPA/670/4-73-001. Office of Research and Development, U.S. Environmental Protection Agency, Cincinnati, OH.
- WHO (World Health Organization). 1976. *Environmental Health Criteria. 1. Mercury*. Geneva, Switzerland.
- WHO (World Health Organization). 1989. *Toxicological Evaluation of Certain Food Additives and Contaminants. Arsenic*. WHO Food Additive Series, 24, pp. 155-162, Cambridge University Press, Cambridge.
- WHO (World Health Organization). 1990. *Environmental Health Criteria 101: Methylmercury*. Geneva, Switzerland.
- WHO (World Health Organization). 1999. *Concise International Chemical Assessment. Document Number 14: Tributyltin Oxide*. Geneva, Switzerland.
- Willers, W. 1991. *Trout Biology*. Lyons and Burford, New York, NY.
- Wiener, J.G. 1987. Metal contamination of fish in low-pH lakes and potential implications for piscivorous wildlife. *Trans N. Am. Wildl. Nat. Res. Conf.* 52:654-657.

- Williams, S. (ed.). 1984. *Official Methods of Analysis of the Association of Official Analytical Chemists*. Fourteenth edition. The Association of Official Analytical Chemists, Inc., Arlington, VA.
- Williams, C.D., D.M. Nelson, M.E. Monaco, S.L. Stone, C. Iancu, L. Coston-Clements, L.R. Settle, and E.A. Irlandi. 1990. *Distribution and Abundance of Fishes and Invertebrates in Eastern Gulf of Mexico Estuaries*. ELMR Report No. 6. Strategic Assessment Branch, National Oceanic and Atmospheric Administration, U.S. Department of Commerce, Rockville, MD.
- Wolf, R.J., and R.J. Walker. 1987. Economies in Alaska: Productivity, geography, and development impacts. *Arctic Anthropol.* 24:56-81.
- Wood, J.M. 1974. Biological cycles for toxic elements in the environment. *Science* 183:1049-1052.
- Woolson, E.A. (ed.). 1975. *Arsenical pesticides*. Am. Chem. Soc. Symp. Ser. 7. 176 pp.
- Worthing, C.R. 1991. *The Pesticide Manual: A World Compendium*. 9th edition. British Crop Protection Council, Croydon, England.
- Wynder, E.L., and D. Hoffman. 1959. A study of tobacco carcinogenesis. VII. The role of higher polycyclic hydrocarbons. *Cancer* 12:1079-1086.
- Yamauchi, H., T. Kaise, and Y. Yamamura. 1986. Metabolism and excretion of orally administered arsenobetaine in the hamster. *Bull. Environ. Contam. Toxicol.* 36:350-355.
- Zabik, M., C. Hoojjat, and D. Weaver. 1979. Polychlorinated biphenyls, dieldrin, and DDT in lake trout cooked by broiling, roasting, or microwave. *Bull. Environ. Contamin. Toxicol.* 21:136-143.
- Zabik, M.E., M.J. Zabik, and H. Humphrey. 1994. *Assessment of Contaminants in Five Species of Great Lakes Fish at the Dinner Table*. Final Report to the Great Lakes Protection Fund, Chicago, Illinois. March 1994.
- Zabik, M.E., M.J. Zabik, A.M. Booren, M. Nettles, J.H. Song, R. Welch and H. Humphrey. 1995b. Pesticides and total polychlorinated biphenyls in chinook salmon and carp harvested from the Great Lakes: Effects of skin-on and skin-off processing and selected cooking methods. *J. Agric. Food Chem.* 43:993-1001.
- Zabik, M.E., A.M. Booren, M.J. Zabik, R. Welch, and H. Humphrey. 1996. Pesticide residues, PCBs and PAHs in baked, charbroiled, salt boiled, and smoked Great Lakes lake trout. *Food Chem.* 55 (3): 231-239.

- Zabik, M.E., and M.J. Zabik. 1995. Tetrachlorodibenzo-p-dioxin residue reduction by cooking/processing of fish fillets harvested from the Great Lakes. *Bull. Environ. Contam. Toxicol.* 55:264-269.
- Zabik, M.E., and M.J. Zabik. 1996. Influence of processing on environmental contaminants in foods. *Food Tech.* 50: 225-229.
- Zangerl, R. 1969. The turtle shell. In *Biology of the Reptilia*. C. Gans (ed.). Academic Press, New York. Volume 1, pp. 311-339.
- Zarogian, G.E., and G.L. Hoffman. 1982. Arsenic uptake and loss in the American oyster, *Crassostrea virginica*. *Environ. Monitor. Assess.* 1:345-358.
- Zug, G.R., A.H. Wynn, and C. Ruckdeschel. 1986. Age determination of loggerhead sea turtles, *Caretta caretta*, by incremental growth marks in the skeleton. *Smithson. Contrib. Zool.* 427:1-34.
- Zweig, G., and J. Sherma (eds.). 1980. *Updated General Techniques and Additional Pesticides. Volume 11. In: Analytical Methods for Pesticides and Plant-Growth Regulators.* Academic Press, New York, NY.

APPENDIX A

1993 FISH CONTAMINANT WORKGROUP

A. 1993 FISH CONTAMINANT WORKGROUP

These individuals representing EPA Headquarters, EPA Regions, State and Federal agencies, Native American groups and others provided technical information, reviews, and recommendations throughout the preparation of the first edition of this document. Participation in the review process does not imply concurrence by these individuals with all concepts and methods described in this document.

A.1 EPA Headquarters Staff

Charles Abernathy	EPA/Office of Water
Thomas Armitage	EPA/Office of Water
Jeffrey Bigler	EPA/Office of Water (Workgroup Chairman)
Carin Bisland	EPA/Office of Water
Dennis Borum	EPA/Office of Water
Robert Cantilli	EPA/Office of Water
Julie Du	EPA/Office of Water
Richard Hoffman	EPA/Office of Water
Clyde Houseknecht	EPA/Office of Water
Henry Kahn	EPA/Office of Water
Amal Mahfouz	EPA/Office of Water
Michael Kravitz	EPA/Office of Water
Elizabeth Southerland	EPA/Office of Water
Margaret Stasikowski	EPA/Office of Water
Irene Suzukida-Horner	EPA/Office of Water
Elizabeth Tam	EPA/Office of Water
William Telliard	EPA/Office of Water
Charles White	EPA/Office of Water
Jennifer Orme Zavala	EPA/Office of Water
Tina Levine	EPA/Office of Pesticide Programs
Michael Metzger	EPA/Office of Pesticide Programs
Richard Whiting	EPA/Office of Pesticide Programs
Jacqueline Moya	EPA/Office of Health and Environmental Assessment

A.2 Other EPA Office Staff

David DeVault	EPA/Great Lakes National Program Office
Brian Melzian	EPA/Office of Reserach and Development- Narragansett, RI
John Paul	EPA/Office of Research and Development- Narragansett, RI
Dennis McMullen	EPA/Environmental Monitoring and Systems Laboratory-Cincinnati, OH
Laurence Burkhard	EPA/Office of Research and Development- Duluth, MN

Michael Dourson	EPA/Office of Health and Environmental Assessment-Cincinnati, OH
Donald Klemm	EPA/Office of Health and Environmental Assessment-Cincinnati, OH

A.3 EPA Regional Staff

Charles Kanetsky	Region 3
Jerry Stober	Region 4
Peter Redmon	Region 5
Diane Evans	Region 6
Philip Crocker	Region 7
Bruce Herbold	Region 9

A.4 Other Federal Agency Staff

Michael Bolger	FDA
Leon Sawyer	FDA
Lee Barclay	FWS
Frank De Luise	FWS
Donald Steffeck	FWS
Jerry Schulte	ORSANCO
Adriana Cantillo	NOAA
Maxwell Eldridge	NOAA
Betty Hackley	NOAA
Alicia Jarboe	NOAA
Bruce Morehead	NOAA
Don Dycus	TVA
J. Kent Crawford	USGS

A.5 State Agency Staff

Robert Cooner	Alabama
Brian Hughes	Alabama
William Keith	Arkansas
Thomas McChesney	Arkansas
Randall Mathis	Arkansas
Gerald Pollock	California
Robert McConnell	Colorado
Richard Greene	Delaware
Eldert Hartwig	Florida
Randall Manning	Georgia
Robert Flentge	Illinois
C. Lee Bridges	Indiana
Emelise Cormier	Louisiana
Albert Hindrichs	Louisiana
Elaine Sorbet	Louisiana

Deirdre Murphy	Maryland
Jack Schwartz	Massachusetts
John Hesse	Michigan
Richard Powers	Michigan
Lisa Williams	Michigan
Pamela Shubat	Minnesota
Alan Buchanan	Missouri
David Tunink	Nebraska
Donald Normandeau	New Hampshire
Paul Hauge	New Jersey
Lawrence Skinner	New York
Ken Eagleson	North Carolina
Jay Sauber	North Carolina
Luanne Williams	North Carolina
Michael Ell	North Dakota
Martin Schock	North Dakota
Abul Anisuzzaman	Ohio
Gene Foster	Oregon
Barbara Britton	Texas
Peter Sherertz	Virginia
Ram Tripathi	Virginia
Jim Amrhein	Wisconsin
Bruce Baker	Wisconsin

A.6 Other Organizations

James Wiener	American Fisheries Society
Deborah Schwackhamer	University of Minnesota
Alvin Braswell	North Carolina State Museum of Natural Science
J. Whitfield Gibbons	University of Georgia Savannah River Ecology Laboratory

APPENDIX B

SCREENING VALUES FOR DEFINING GREEN AREAS

APPENDIX B

Recommendations for Designating Areas of Unrestricted Fish Consumption as Part of State Fish Advisory Programs

Fish consumption advisories issued across the United States have increased over the past 5 years from 1,266 advisories in 1993 to 2,506 advisories in 1998. Many states are now advising their citizens either (1) not to consume any fish or any fish of a specific species or specific size class from specified waterbodies, or (2) to restrict their consumption of these fish to a specified number of meals per time interval (such as one meal per week or two meals per month). This comes at a time when the health benefits of consuming fish have also become widely recognized (Burr et al., 1989; Dolecek and Granditis, 1991; Kimbrough, 1991; Knapp and Fitzgerald, 1989; Kromhout, 1993; Kromhout et al., 1985; McVeigh, 1990; Norell et al., 1986; Shekelle et al., 1985; Simopoulous, 1991). In an attempt to promote consumption of fish with relatively low body burdens of chemical contaminants as part of a healthy diet, some states have defined certain waterbodies as containing fish that are safe for "unrestricted consumption." These areas that are identified as safe for unrestricted fish consumption are often referred to as "green" areas. The U.S. Environmental Protection Agency (EPA) National Fish and Wildlife Contamination Program is recommending that states develop an approach for designating and communicating the location of these safe fishing areas to the fish-consuming public. This risk management tool encourages both fishing as a recreational activity and the consumption of fish that are low in chemical contaminant residues, high in protein, and low in fat content.

This green area concept, already in use in several U.S. states and Canadian provinces, would enable states, territories, and tribes to define areas where fish tissue monitoring data and appropriate risk assessments have determined that fish may be safely consumed at unrestricted levels (as defined by the state) from a particular waterbody or waterbodies in a particular watershed. The green areas concept is in contrast to the more traditionally issued fish advisory that discourages fish consumption from specified waterbodies altogether or advises reduced consumption of fish. These green areas may comprise watersheds that are relatively undeveloped from an industrial and agricultural perspective, such as wilderness areas, or areas that border county, state, or national forests or preserves. One cautionary note with regard to waterbodies in very remote areas must be made, however. Several studies have monitored what were perceived as pristine watersheds and unexpectedly found elevated chemical contamination in fish tissues at levels of potential human health concern (Datta et al., 1999; Grieb et al., 1990; Henry et al., 1998; Sorensen et al., 1990; Swackhamer and Hites, 1998). Although these waterbodies were removed from direct industrial point source discharges and agricultural nonpoint source pollution, several chemical contaminants such as mercury, toxaphene, and PCBs, can be transported in the atmosphere from highly contaminated areas and be deposited relatively long distances from the actual pollutant sources. This atmospheric transportation of

some chemical contaminants has resulted in the issuance of statewide freshwater advisories for mercury in 10 states (U.S. EPA, 2000).

Most states sample fish from a variety of waters during their annual fish monitoring programs. Not all waterbodies sampled are found to be contaminated to such a degree that issuance of advisories is necessary. It is those waterbodies containing fish with lower chemical residues (below human health screening values) that would potentially fall under the broad category of green areas. Within the green areas, however, there need to be criteria for distinguishing those waterbodies that are only slightly below the human health levels of concern from those that are truly pristine with respect to chemical contaminant levels in fish tissues. Once these green areas have been identified, states can use appropriate information on fish-consuming populations to establish appropriate consumption information.

To designate a waterbody as a green area where unrestricted fish consumption (as defined by the state) is sanctioned, EPA recommends that a state

- Collect a variety of fish species in the waterbody under review for green area status, but particularly target those species that are generally consumed by the local recreational or subsistence fishers using the waterbody.
- Assess levels of contamination for all of the 25 target analytes identified in this guidance document in the sampled fish tissue that are likely to impact that waterbody and compare residue levels to selected human health screening values.
- Conduct a risk assessment of the resulting chemical analysis data to determine whether the waterbody can be designated a green area and to more clearly define “unrestricted consumption” for the fish-consuming population given the specific levels of contamination for each of the target analytes found
- Clearly define for and communicate to the fish-consuming public the definition of “unrestricted consumption” based on the specific assumption used in the risk assessment procedure for the green area waters so that all segments of the fish-consuming public including sensitive populations (e.g., pregnant women/fetuses, nursing mothers, and children) understand the limitations of this unrestricted consumption status.

EPA suggests that the states follow the guidance in this volume for designing a monitoring program (Sections 2, 3, and 6), including the selection and sampling of appropriate target species in adequate numbers and of appropriate size classes. Two distinct screening values are available to the states based on different consumption rates of two distinct fisher populations: recreational fishers and subsistence fishers. State-collected information from creel surveys or interviews with these two distinct populations is most desirable for use in deriving

screening values. (See U.S. EPA, 1998, *Guidance for Conducting Fish and Wildlife Consumption Surveys* for further information.) If local information on these fisher populations is not available, states may use the EPA default consumption rate values of 17.5 g/d and 142.4 g/d for recreational and subsistence populations, respectively, to calculate screening values.

Table B-1 summarizes the screening values (SVs) that states may choose to use to initially identify green areas. Screening values for the 25 target analytes are provided for both recreational and subsistence fishers based on the EPA default consumption rates (see Tables 5-3 and 5-4 in Section 5.2 for additional information on calculating screening values.) These calculated SVs for each of the target analytes should not be exceeded in fish tissues for the respective target fish-consuming population. The SVs listed in the table for target analytes such as inorganic arsenic, chlordane, DDT, dieldrin, heptachlor epoxide, hexachlorobenzene, lindane, toxaphene, oxyfluorfen, and PCBs that have both noncancer and cancer health endpoints are represented by the more conservative or protective of the two calculated SVs.

One concern states must address relates to the detection limit of the analytical method selected for chemical analysis of each target analyte in fish tissue samples. Just because an analyte cannot be detected in fish tissue, does not ensure that the area is safe for unrestricted consumption. For some of the target analytes, especially those calculated using subsistence consumption rates, the SVs are at or below the detection limit for even the most state-of-the-art residue analysis methods (see Table B-1). Thus, the analytical result of a sample being less than the mean detection limit for a particular analyte will not provide the state with adequate information about the actual contaminant level to accurately determine the meal size and meal frequency that can safely be consumed.

States in many cases have been forced by limited monitoring resources to target the collection and analysis of fish tissues to those waterbodies deemed most likely to be contaminated by chemical pollutants. Unlike sampling to determine whether a fish consumption advisory should be issued for a chemical contaminant, which requires only that one chemical be found in exceedance of a human health SV, sampling and analysis to determine green area status must confirm that there are no chemical contaminants in exceedance of the selected human health SVs. It is also important that the state directly monitor the contaminant tissue levels of the various chemical contaminants of concern in fish tissue rather than rely on indirect methods such as measuring water or sediment contaminant levels to estimate the level of fish tissue contamination in a particular waterbody.

EPA further recommends that states clearly define for the fish-consuming population the meaning of "unrestricted consumption." For example, a state may choose a green area designation for their jurisdictional waters that are primarily used by recreational fishers. These waters must then not exceed SVs for

Table B-1. Screening Values for Defining Green Areas Based on Recreational or Subsistence Use of the Waterbody (ppm)

Target Analyte	SV Based on Recreational Fisher Consumption	SV Based on Subsistence Fisher Consumption	Analytical Detection Limits
Arsenic (inorganic)	0.026	3.87×10^{-3} ^a	0.005
Cadmium	4	0.58	0.005
Mercury	0.4	5.8×10^{-2}	0.001
Selenium	20	2.9	0.017
Tributyltin	1.2	0.17	0.002
Chlordane (Total)	0.114	0.016	0.001
DDT (Total)	0.117	0.017	1×10^{-4}
Dicofol	1.6	0.23	0.001
Dieldrin	2.5×10^{-3}	3.07×10^{-4} ^a	1×10^{-4}
Endosulfan (I and II)	24	2.949	0.005
Endrin	1.2	0.147	1×10^{-4}
Heptachlor epoxide	4.39×10^{-3}	5.40×10^{-4} ^a	1×10^{-4}
Hexachlorobenzene	2.50×10^{-2}	3.07×10^{-3}	1×10^{-4}
Lindane	3.07×10^{-2}	3.78×10^{-3}	1×10^{-4}
Mirex	0.8	0.098	1×10^{-4}
Toxaphene	3.63×10^{-2}	4.46×10^{-3} ^a	0.003
Chlorpyrifos	1.2	1.147	0.002
Diazinon	2.8	0.344	0.002
Disulfoton	0.16	0.019	0.002
Ethion	2	0.245	0.002
Terbufos	0.08	0.009	0.002
Oxyfluorfen	0.546	0.067	0.010
PAHs	5.47×10^{-3}	6.73×10^{-4}	1×10^{-6}
PCBs (Total)			
Sum of Aroclors ^a	0.02	2.45×10^{-3} ^a	0.020
Non-ortho coplanar PCBs			2×10^{-6}
Other congeners/ homologues			0.002
Dioxins/Furans	2.56×10^{-7} ^a	3.15×10^{-8} ^a	1×10^{-6}

^a Target analyte (total)s for which the analytical detection limit is likely to be at or above the calculated SV depending on the analytical method selected. States must ensure that the analytical method chosen provides detection limits lower than the selected SVs for all 25 target analytes for designation of green area waters.

recreational fishers and the state must define “unrestricted consumption” for the consumer. For example, the state’s green areas may be defined as areas from which fish consumers may safely eat four 8-ounce fish meals per month (or approximately one fish meal per week) without any additional health risks. This definition must be clearly communicated, particularly to members of high-end fish-consuming groups such as some Native Americans, certain ethnic groups, and subsistence fishers as well as to sensitive populations (pregnant women/fetuses, nursing women and children). The state should clearly define for the public both the **meal size** and **meal frequency** used in their green area designations so that high-end fish consumers do not erroneously assume that the unrestricted consumption designation that is protective of recreational fishers based on their consumption rate is also protective of subsistence fishers. In addition, the state should provide the fish-consuming public with information on the types of fish samples (whole fish, skin-on fillets, skin-off fillets, or other sample types) used to establish the green area designation. Because skinning, trimming, and certain cooking procedures also help reduce chemical residues in fish tissues (EPA, 1999) (see Volume 2 of this series, Appendix C—Dose Modification Due to Food Preparation), the state should also provide information on these procedures particularly to fisher populations who consume whole fish or portions of the fish other than the standard fillet. If the green area concept is to be effective in promoting fishing and the consumption of fish, it is essential that the fish-consuming public be given adequate information to understand the definition of unrestricted fish consumption from these green areas.

One approach is to communicate these locations to the public in fishing brochures annually distributed as part of the existing fish advisory programs. In addition to publishing this information in state fishing brochures, EPA anticipates making this information a new choice of advisory designations available to the states and tribes for incorporation into the National Listing of Fish and Wildlife Advisories (NLFWA) database. EPA realizes that this new designation will be successful only if the states and tribes receive guidance and the information is presented in an easily implemented format.

In addition to implementation of green areas within their jurisdictions, states are also encouraged to initiate or expand the use of general fish consumption guidance for all fish. Several states provide advise on catching, cleaning, cooking, and consumption of fish species. In some jurisdictions, states have issued unlimited consumption or restricted consumption advisories for smaller size classes of those species that are particularly popular with consumers. In this way, the state is still encouraging the recreational aspects of fishing and continued consumption of smaller-sized fish within a given species that typically contain lower residues of chemical contaminants. As a result, the public is encouraged to enjoy both the sport of fishing and the health benefits of eating fish within the specific consumption guidance provided by the state.

References

- Burr, M.L., A.M. Fehily, J.F. Gilbert, S. Rogers, R.M. Holliday, P.M. Sweetnam, P.C. Elwood, and N.M. Deadman. 1989. Effects of changes in fat, fish, and fibre intakes on death and myocardial reinfarction: Diet and Reinfarction Trial (DART). *Lancet* 2 (8666):757-761.
- Datta, S., K. Ohyama, D.Y. Dunlap, and F. Matsumura. 1999. Evidence for organochlorine contamination in tissues of salmonids in Lake Tahoe. *Ecotoxicol. and Environ. Safety* 42: 94-101.
- Dolecek, T.A., and G. Granditis. 1991. Dietary polyunsaturated fatty acids and mortality in the Multiple Risk Factor Intervention Trial (MRFIT). *World Rev. Nutr. Diet* 66:205-216.
- Grieb, T.M., C.T. Driscoll, S.P. Gloss, C.L. Schofield, G.L. Bowie, and D.B. Porcella. 1990. Factors affecting mercury accumulation in fish in the Upper Michigan Peninsula. *Environ. Toxicol. Chem.* 9:919-930.
- Henry, K.S., K. Kannan, B.W. Nagy, N.R. Kevern, M.J. Zabik, and J.P. Giesy. 1998. Concentrations and hazard assessment of organochlorine contaminants and mercury in smallmouth bass from a remote lake in the Upper Peninsula of Michigan. *Arch. Environ. Contam Toxicol.* 34:81-86.
- Kimbrough, R.D. 1991. Consumption of fish: Benefits and perceived risk. *J. Toxicol. Environ. Health* 33 (1):81-91.
- Knapp, H.R., and G.A. Fitzgerald. 1989. The antihypertensive effects of fish oil. A controlled study of polyunsaturated fatty acid supplements in essential hypertension. *N. Engl. J. Med.* 320 (16):1037-1043.
- Kromhout, D. 1993. Epidemiological aspects of fish in the diet. *Proc. Nutr. Soc.* 52 (3):437-439.
- Kromhout, D., E.B. Bosschieter, and C.dL. Coulander. 1985. The inverse relation between fish consumption and 20-year mortality from coronary heart disease. *N. Engl. J. Med.* 312 (19):1205-1209.
- McVeigh, G. 1990. Arthritis and diet: a new look. *Prevention* 42 (10):40-45.
- Norell, S.E., A. Ahlbom, M. Feychting, and N.L. Pedersen. 1986. Fish consumption and mortality from coronary heart disease. *Br Med. J. (Clin. Res. Ed.)* 293(6544):426.

Shekelle, R.B., L. Missell, O. Paul, A. M. Shryock, and J. Stamler. 1985. Fish consumption and mortality from coronary heart disease (letter). *N. Engl. J. Med.* 313 (13):820

Simopoulos, A.P. 1991. Omega-3 fatty acids in health and disease and in growth and development. *Am. J. of Clin. Nutr.* 54(3):438-463.

Sorensen, J.A., G.E. Glass, K.W. Schmidt, J.K. Huber, and G.R. Rapp Jr. 1990. Airborne mercury deposition and watershed characteristics in relation to mercury concentrations in water, sediments, plankton, and fish of eighty northern Minnesota lakes. *Environ. Sci. Technol.* 24:1716-1727.

Swackhamer, D.L., and R.A. Hites. 1988. Occurrence and bioaccumulation of organochlorine compounds in fishes from Siskiwit Lake, Isle Royale, Lake Superior. *Environ. Sci. Technol.* 22:543-548.

U.S. EPA (Environmental Protection Agency). 1998. *Guidance for Conducting Fish and Wildlife Consumption Surveys*. EPA-823-B-98-007. Office of Water, Washington, DC.

U.S. EPA (Environmental Protection Agency). 2000. *Guidance for Assessing Chemical Contaminant Data for Use in Fish Advisories—Risk Assessment and Fish Consumption Limits*. Volume 2. 3rd Edition, EPA-823-B-99-009. Office of Water, Washington, DC.

APPENDIX C

USE OF INDIVIDUAL SAMPLES IN FISH CONTAMINANT MONITORING PROGRAMS

APPENDIX C

USE OF INDIVIDUAL SAMPLES IN FISH CONTAMINANT MONITORING PROGRAMS

The use of composite samples is often the most cost-effective method for estimating average tissue concentrations of analytes in target species populations to assess chronic human health risks. However, there are some situations in which individual sampling can be more appropriate from both ecological and risk assessment perspectives. Individual sampling provides a direct measure of the range and variability of contaminant levels in target fish populations. Information on maximum contaminant concentrations in individual fish is useful in evaluating acute human health risks. Estimates of the variability of contaminant levels among individual fish can be used to ensure that studies meet desired statistical objectives. For example, the population variance of a contaminant can be used to estimate the sample size needed to detect statistically significant differences in the mean contaminant concentration compared to the contaminant screening values. Finally, the analysis of individual samples may be desirable, or necessary, when the objective is to minimize the impacts of sampling on certain vulnerable target populations, such as predators in headwater streams and aquatic turtles, and in cases where the cost of collecting enough individuals for a composite sample is excessive.

Analyzing individual fish incurs additional expenses, particularly when one considers that a number of individual analyses are required to achieve measurements of a reasonable statistical power. However, the recommendation that states archive the individual fish homogenates from which composite samples are prepared for both screening and intensive studies (see Section 6.1.1.6) would make it possible to perform individual analyses where needed without incurring additional sampling costs.

Individual analysis is especially well-suited for intensive studies, in which results from multiple stations and time periods are to be compared. The remainder of this appendix discusses how the sampling design might be affected by analyzing individual rather than composite samples and how contaminant data from individuals versus composites might be used in risk assessments.

C.1 SAMPLING DESIGN

There are seven major components of the sampling design for a fish or shellfish monitoring program: site selection, target species, target analytes, target analyte screening values (SVs), sampling time, sampling type and size class, and repli-

cate samples. Of these, only the number of replicate samples and possibly the target species would be expected to differ if individual samples were analyzed rather than composites. Target species becomes a limiting factor when individuals of the target species are not large enough to provide adequate tissue mass for all the required chemical analyses.

The five factors that determine the optimal number of fish or shellfish to analyze are presented in Section 6.1.2.7. Briefly, the five factors are

- Cost components
- Minimum detectable difference between measured site-specific mean target analyte concentration and SV
- Level of significance
- Population variance
- Power of the hypothesis test.

Each of these characteristics will be examined in detail for the collection and analysis of individual samples.

C.1.1 Cost Components

The cost of obtaining contaminant data from individual fish or shellfish is compared to the cost of obtaining contaminant data from composite samples in Table C-1. These costs are dependent on the separate costs of collecting, preparing, and analyzing the samples.

Table C-1. Relative Cost of Obtaining Contaminant Data from Individual Versus Composite Samples

Cost component	Relative cost	
	Composite samples	Individual samples
Collection	Moderate to high	Low to moderate
Preparation	Very low to moderate	Very low to low
Analysis	Low to moderate	Moderate to high

Typically, the cost of collecting individual samples will be less than that of collecting composite samples when the target species is scarce or difficult to capture. The cost of collecting individuals may not be a factor if the sample collection method used typically allows for the collection of a large number of individuals in a short period of time. In some situations, seines or gill nets might have this characteristic. Also, in estuaries, coastal water, or large lakes where productivity is high, the additional cost of collecting large numbers of individuals for composite sampling may be minimal compared to the effort expended for collecting individual samples.

The cost of preparing individual samples for analysis is typically lower than either the costs of collection or analysis. Generally, the cost of preparing composite samples for analysis will be greater than that of preparing individual samples. Sample preparation procedures can range in complexity from the grinding of whole fish to delicate and time-consuming operations to resect specific tissues. Costs of composite sampling depend largely on the number of individuals required per composite sample and the number of replicate composite samples required to achieve the desired statistical power; however, these costs can be somewhat controlled (see Section 6.1.2.7).

The cost of analyzing individual samples is also typically higher than the cost of analyzing composite samples. The cost differential between the two approaches is directly correlated to the cost for the analysis of a single sample. For some intensive studies, the number of target analytes exceeding the SV is small, so few analyses are required. In these cases, the relative costs between the two approaches may not differ greatly if the number of samples analyzed using the two different approaches is similar (e.g., three to five samples). A sampling design with such a small number of individual samples would be appropriate only if the expected mean target analyte concentration was much greater than the SV.

C.1.2 Minimum Detectable Difference

The difference between the mean target analyte concentration at a site and the SV will not often be known before the screening study has been performed. The minimum detectable difference between the mean concentration and the SV will depend on the level of significance (see Section C.1.3), population variance (Section C.1.4), and the number of replicates collected. In practice, the sample size is often determined by establishing the minimum detectable difference prior to the study according to the objectives of the project. For an SV that has not been multiplied by an uncertainty factor, the cost of detecting a 10 percent difference may be warranted. The issue of minimum detectable difference is discussed in greater detail in Section C.1.5.

C.1.3 Level of Significance

The level of significance (LS) refers to the probability of incorrectly rejecting the null hypothesis that there is no difference between the mean target analyte concentration and the SV. This probability is also called Type I error. The LS can be thought of as the chance of a "false positive" or of detecting a difference that does not exist. The LS affects the sampling design by modifying the required power (thus impacting the sample size) of the statistical test to detect a significant difference between the mean target analyte concentration and the SV (see Section C.1.5). A typical LS used in biological sampling is 0.05. In some cases, an LS other than 0.05 could be appropriate. If the ramifications of a statistically significant difference are severe, a more conservative LS (e.g., 0.01) might be used. On the other hand, if the statistical test is being conducted to identify

whether additional sampling should be performed (i.e., a screening survey), then a less conservative LS (e.g., 0.10) might be used.

C.1.4 Population Variance

The variability in target analyte concentrations within a given fish or shellfish population is a critical factor in determining how many individual samples to collect and analyze. The population variance directly affects the power of the statistical test to detect a significant difference between the mean target analyte concentration and the SV (see Section C.1.5) by impacting the sample size. The population variance may not be known prior to sampling, but it can be estimated from similar data sets from the same target species, which could in many cases be obtained by analyzing individual fish homogenates if these have been archived as recommended in Section 6.1.1.6. In using historical data to estimate population variance, it is important to consider contaminant data only from individual fish or shellfish of the same species. By its very nature, a data set consisting of replicate composite samples tends to smooth out the variability inherent in a group of individual organisms. An extreme example of this phenomenon was presented by Fabrizio et al. (1995) in a study on procedures for compositing fish samples. They used computer simulations to predict PCB concentrations in composite samples of striped bass that had previously been analyzed individually. The predicted variance in these concentrations in the composite samples was approximately 20 percent of the variance obtained from individual analyses.

C.1.5 Power of Statistical Test

Another critical factor in determining the sample size is the power of the statistical test, that is, the probability of detecting a true difference between the mean target analyte concentration and the SV. Because of its profound influence on sample size, it is the power of the test that may ultimately control whether the objectives of the survey are met. The effect of joint consideration of the desired power, the population variance, and the minimum detectable difference on the sample size is described by the following formula (Steel and Torrie, 1980):

$$n = \frac{(Z_{\alpha} + Z_{\beta})^2 2\sigma^2}{\delta^2}$$

where

- n = sample size
- Z_{α} = Z statistic for Type I error (α)
- Z_{β} = Z statistic for Type II error (β)
- σ^2 = population variance (estimated from historical data)
- δ = minimum detectable difference between mean target analyte concentration and SV.

Recall that the Type I error is equal to the LS, and the value is generally between 0.01 and 0.10. Type II error is the probability of accepting the null hypothesis (that there is no difference between the mean target population concentration and the SV) when it is actually false. This type of error can be thought of as the chance of a "false negative," or not detecting a difference that does in fact exist. The complement of Type II error ($1-\beta$) is the power of the statistical test.

The above equation for determining sample size was solved for powers ranging from 0.5 to 0.9 (50 to 90 percent; Figure C-1) assuming an LS of 0.05. The values for σ (standard deviation) and δ were set relative to the SV. A similar exercise was performed in Section 6.1.2.7 and two examples were provided. In example A, both the standard deviation and minimum detectable difference were set to 0.5 SV. Example A corresponds to a ratio of 1 on the x-axis of Figure C-1. Applying example A to the collection of individual fish, the recommended sample size would range from approximately 6 individual samples for a power of 50 percent to 18 individual samples for a power of 90 percent (Figure C-1). In example B, the standard deviation was set to 1.0 SV, while the minimum detectable difference was kept at 0.5 SV. Example B corresponds to a ratio of 2 on the x-axis of Figure C-1. Applying example B to the collection of individual samples, the sample size would have to be almost 40 individual samples to achieve even a modest statistical power (i.e., 70 percent).

It is common to set the power of the statistical test to at least 80 percent (Fairweather, 1991). Figure C-1 indicates that, to achieve a statistical power of 80 percent using the variability assumptions in examples A and B, 13 and 50 fish would have to be collected, respectively. The estimated sample sizes for individual fish or shellfish is similar to those calculated for composite samples (see Section 6.1.2.7). For example A as applied to composite samples, 12 to 18 fish would have to be collected. For example B as applied to composite samples, 30 to 50 fish would have to be collected. Thus, the cost of collecting the fish to achieve a power of 80 percent would not be significantly different for composite versus individual samples (see Section C.1.1). The number of analyses, however, would be considerably less for composite samples (3 to 10 analyses of composite samples versus 13 or 50 analyses of individual samples).

Figure C-1 also indicates that 10 or fewer individual fish or shellfish should be analyzed only if the ratio of the standard deviation to the minimum detectable difference is 0.85 or less. For ratios less than 0.5, the effect of sample size on the statistical power is minor. If the expected mean target analyte concentration is many times greater than the SV, it may not be necessary to allocate resources toward the collection and analysis of more than a minimum number (e.g., three to five samples) of individual fish or shellfish.

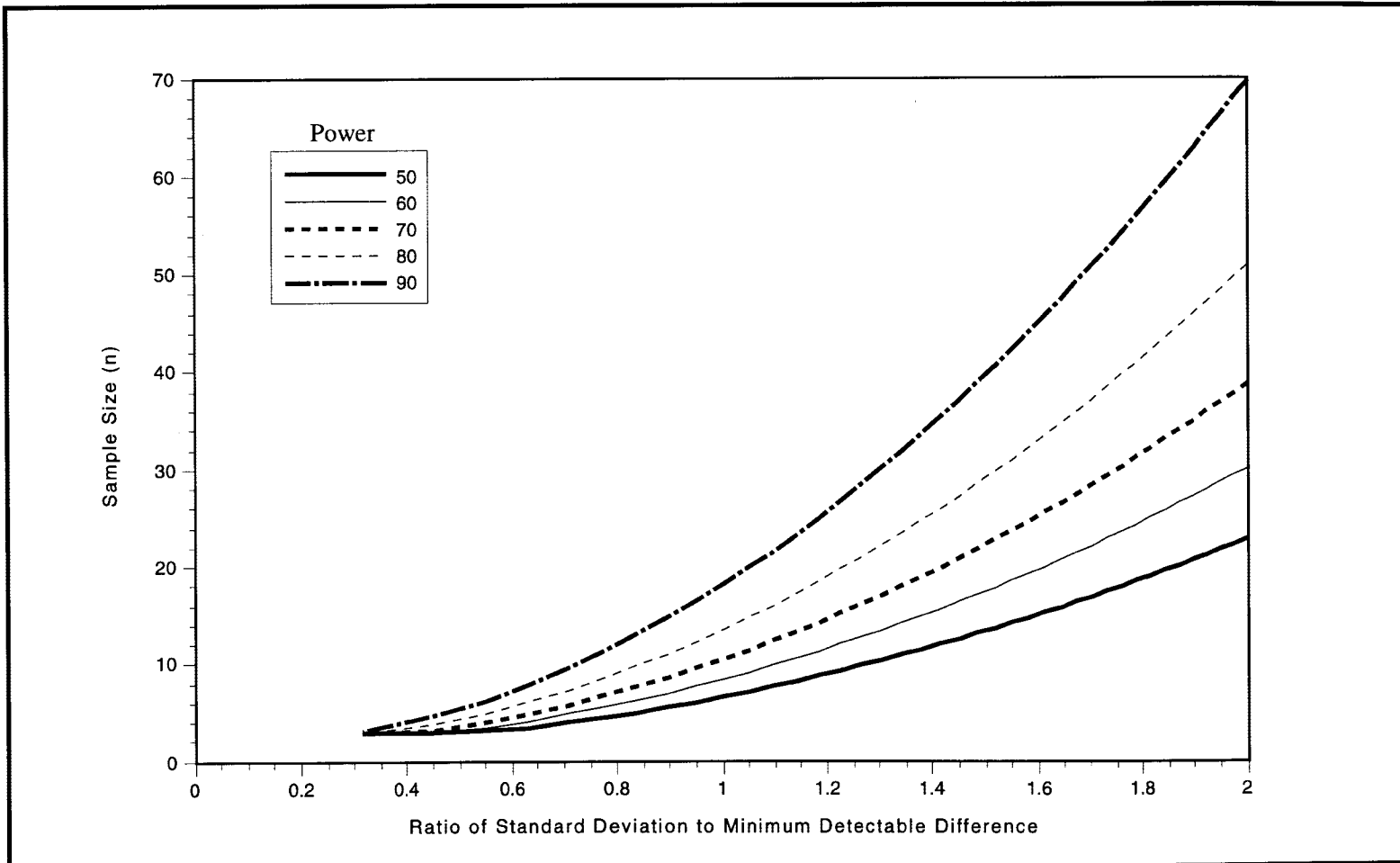

Figure C-1. Recommended sample sizes to achieve various statistical powers.

C.2 USE OF CONTAMINANT DATA FROM INDIVIDUAL FISH/SHELLFISH IN RISK ASSESSMENTS

Target analyte concentrations in composite samples represent averages for specific target species populations. The use of these values in risk assessments is appropriate if the objective is to estimate the average concentration to which consumers of the target species might be exposed over a long period of time. The use of long exposure durations (e.g., 30 to 70 years) is typical of the assessment of carcinogenic target analytes, the health effects of which may be manifested over an entire lifetime (see Volume 2 of this series). Target analytes that produce noncarcinogenic effects, on the other hand, may cause acute effects to human health over a relatively short period of time on the order of hours or days. The use of average contaminant concentrations derived from the analysis of composite samples may not be protective against acute health effects because high concentrations in an individual organism may be masked by lower concentrations in other individuals in the composite sample. Contaminant data from individual samples permits the use of alternative estimates of contaminant concentration for a group of fish or shellfish (e.g., maximum). Therefore, the decision whether to collect and analyze individual fish or shellfish may depend on the target analytes included in the monitoring program.

EPA has recommended that 25 target analytes be included in screening studies (see Section 4). All of the target analytes except PCBs, PAHs, and dioxins/furans have reference doses for noncarcinogenic health effects, although the carcinogenic risk is likely to be greater than the noncarcinogenic risk for eight other target analytes (see Tables 5-2 and 5-3). EPA's reassessment of the health effects of 2,3,7,8-TCDD (dioxin) indicated that this chemical may also pose a significant noncarcinogenic health risk in some cases (U.S. EPA, 1994).

C.3 EXAMPLE CASE STUDY

The presentation of a case study will illustrate some of the sample size and data interpretation issues discussed in Sections C.1 and C.2, respectively. A State has prepared a composite sample of target species A from a particular waterbody of concern. This composite sample was analyzed for all 25 target analytes listed in Table 4-1. Of the 25 target analytes, only cadmium was detected at a concentration exceeding the state selected SV (10 ppm) for cadmium. Cadmium was detected at 20 ppm, twice the SV calculated for cadmium. Because the SV for at least one target analyte was exceeded, an intensive study was warranted. The state decided to collect and analyze individual fish in the intensive study for the following reasons: (1) the cost of collecting individual fish is less than the cost of collecting fish for composites, (2) the analytical costs for analyzing cadmium are relatively low (<\$50 sample), and (3) the cadmium concentrations in individual fish should more accurately reflect the potential acute (noncarcinogenic) health risk from cadmium than the mean cadmium concentration derived from composite samples.

The first issue the state must decide is how many individual fish to collect and analyze. The important factors in this decision are the minimum detectable difference the state wishes to test and the variability in cadmium concentrations within the target species population. The first factor can be obtained from the results of the screening survey. The state wishes to test whether the difference between the concentration detected in the single composite sample (20 ppm) and the selected SV (10 ppm) is significant. This assumes that the mean cadmium concentration for the individual is also 20 ppm. The expected standard deviation (8 ppm) was obtained from a previous investigation performed on individuals of the target species and was equal to 0.8 of the SV (10 ppm). Using Figure C-1, it can be seen that, for a ratio of standard deviation ($0.8 \times \text{SV}$) to detectable difference ($1.0 \times \text{SV}$) of 0.8, the sample size necessary to achieve a statistical power of 80 percent would be eight fish.

The state determines that the mean cadmium concentration of eight individual fish of the target species is 30 ppm and the standard deviation is equal to the predicted value of 8 ppm. The state performs a *t*-test to determine if the mean concentration is significantly greater than the SV. As described in Section 6.1.2.7, the statistic

$$(\text{mean} - \text{SV})/\text{standard deviation}$$

has a *t*-distribution with $n-1$ degrees of freedom. For this example, the *t* statistic is 2.5 $[(30-10)/8]$ with 7 degrees of freedom. This value exceeds the critical *t*-statistic (1.895) for a one-tailed LS of 0.05. Therefore, the state determines that the mean cadmium concentration for these eight individual fish of the target species is significantly greater than the SV and a risk assessment is performed.

C.4 REFERENCES

- Fabrizio, M.C., A.M. Frank, and J.F. Savino. 1995. Procedures for formation of composite samples from segmented populations. *Environmental Science and Technology* 29(5):1137-1144.
- Fairweather, P.G. 1991. Statistical power and design requirements for environmental monitoring. *Aust. J. Freshwater Res.* 42:555-567.
- Steel, R.G.D., and J.H. Torrie. 1980. *Principles and Procedures of Statistics. A Biometrical Approach*. Second Edition. McGraw-Hill Book Company. New York, NY. 633 pp.
- U.S. EPA (U.S. Environmental Protection Agency). 1994. *Health Assessment for 2,3,7,8-TCDD and Related Compounds*. Public Review Draft. EPA/600/EP-92/001.

APPENDIX D

FISH AND SHELLFISH SPECIES FOR WHICH STATE CONSUMPTION ADVISORIES HAVE BEEN ISSUED

APPENDIX D

FISH AND SHELLFISH SPECIES FOR WHICH STATE CONSUMPTION ADVISORIES HAVE BEEN ISSUED

FRESHWATER FINFISH SPECIES FOR WHICH STATE CONSUMPTION ADVISORIES HAVE BEEN ISSUED

1993 and 1998 (**Bold type**)

1998 only (Normal type)

1993 only (*Italic type*)

- AL **fish species (unspecified), catfish (unspecified), bigmouth buffalo, brown bullhead, channel catfish, white bass**
smallmouth buffalo, channel catfish, largemouth bass, spotted bass, striped bass, crappie, king mackerel
- AK **no consumption advisories**
- AS fish species (unspecified), shellfish (unspecified)
- AZ **fish species (unspecified)**
largemouth bass, yellow bullhead, channel catfish, black crappie, bluegill sunfish, green sunfish, redear sunfish
- AR **fish species (unspecified)**
bass (unspecified), black bass, largemouth bass, bowfin, buffalo, catfish (unspecified), blue catfish, channel catfish, flathead catfish, crappie, freshwater drum, gar, pickerel, redhorse, sucker, sunfish
- CA **goldfish, Sacramento blackfish, brown bullhead, crappie (unspecified), hitch, largemouth bass, smallmouth bass, channel catfish, white catfish, trout (unspecified), rainbow trout, croaker (unspecified), orangemouth corvina, sargo, tilapia (unspecified), fish species (unspecified)**
brown trout, bullhead (unspecified), white crappie, black crappie, carp (unspecified), corbina, striped bass, kelp bass, gobies, queenfish, rockfish, sculpin, shark, shellfish (unspecified), surfperch
squawfish, sucker (unspecified)

-
- CO **rainbow trout, yellow perch, northern pike, walleye, smallmouth bass, largemouth bass, black crappie, kokanee salmon, channel catfish, fish species (unspecified)**
bullhead, common carp, crappie (unspecified), brown trout
trout (unspecified)
- CT **common carp, fish species (unspecified)**
largemouth bass, smallmouth bass, striped bass, bluefish, bullhead, catfish (unspecified), American eel, chain pickerel, trout (unspecified)
- DE **white catfish, channel catfish, fish species (unspecified)**
striped bass, white perch, carp (unspecified), largemouth bass, catfish (unspecified)
- DC **American eel**
carp (unspecified), catfish (unspecified)
channel catfish, common carp
- FL **largemouth bass, gar, bowfin, warmouth sunfish, yellow bullhead, Mayan cichlid, oscar, spotted sunfish**
gafftopsail catfish, jack crevalle, ladyfish, Spanish mackerel, king mackerel, spotted sea trout, shark
- GA **common carp, largemouth bass, catfish (unspecified), fish species (unspecified)**
hybrid bass, redeye bass, shoal bass, spotted bass, striped bass, Suwannee bass, white bass, bowfin, smallmouth buffalo, bullhead (unspecified), brown bullhead, spotted bullhead, yellow bullhead, channel catfish, flathead catfish, white catfish, black crappie, Atlantic croaker, black drum, red drum, flounder, striped mullet, silver perch, chain pickerel, grayfin redhorse, silver redhorse, spotted sea trout, greater jumprock sucker, spotted sucker, sunfish, redbreast sunfish, rainbow trout, walleye, clams, blue crab, mussels, oysters, shrimp
- GU **no consumption advisories**
- HI all fish species (unspecified), shellfish (unspecified)
- ID smallmouth bass, catfish (unspecified), black crappie, white crappie, yellow perch
- IL **lake trout, coho salmon, chinook salmon, brown trout, common carp, catfish (unspecified), channel catfish, shovelnose sturgeon, bluegill, freshwater drum, largemouth bass, spotted bass, alewife**
white bass, blue catfish, black crappie, white crappie, yellow perch, sauger, smelt
bigmouth buffalo, flathead catfish, smallmouth buffalo, crappie (unspecified)
-

-
- IN **fish species (unspecified), common carp, catfish (unspecified), coho salmon, brown trout, lake trout, chinook salmon, channel catfish**
largemouth bass, rock bass, smallmouth bass, spotted bass, striped bass, hybrid striped bass, white bass, yellow bass, bloater, bowfin, bigmouth buffalo, black buffalo, smallmouth buffalo, bullhead (unspecified), black bullhead, yellow bullhead, carp (unspecified), carpsucker, quillback carpsucker, river carpsucker, flathead catfish, creek chub, black crappie, white crappie, freshwater drum, round goby, northern hogsucker, paddlefish, yellow perch, northern pike, redhorse (unspecified), black redhorse, golden redhorse, river redhorse, shorthead redhorse, silver redhorse, sauger, gizzard shad, shovelnose sturgeon, blue sucker, longnose sucker, spotted sucker, white sucker, bluegill sunfish, green sunfish, longear sunfish, brook trout, rainbow trout, steelhead trout, walleye, whitefish (unspecified), lake whitefish
- IA **common carp, fish species (unspecified)**
quillback carpsucker
channel catfish, carpsucker (unspecified)
- KS **buffalo (unspecified), common carp, freshwater drum, carpsucker (unspecified)**
blue catfish, channel catfish, flathead catfish, bullhead catfish, shovelnose sturgeon
catfish (unspecified), sturgeon (unspecified)
- KY **channel catfish, paddlefish, white bass, common carp, fish species (unspecified)**
largemouth bass
- LA **bass (unspecified), fish species (unspecified)**
largemouth bass, spotted bass, striped bass, white bass, bowfin, bigmouth buffalo, carp (unspecified), channel catfish, flathead catfish, crappie, black crappie, white crappie, freshwater drum, gar, king mackerel, shad, shellfish (unspecified), bluegill sunfish, redear sunfish
- ME **fish species (unspecified)**
striped bass, bluefish, American lobster, freshwater fish, cold water fish, warm water fish
- MD **channel catfish, American eel, black crappie, common carp**
bullhead (unspecified), sunfish (unspecified)
-

- MA brown trout, yellow perch, white sucker, American eel, smallmouth bass, largemouth bass, lake trout, channel catfish, brown bullhead, common carp, white catfish, fish species (unspecified)**
bottom fish, bass (unspecified), yellow bullhead, black crappie, flounder, white perch, scup, chain pickerel, bivalves (unspecified), lobster (unspecified), American lobster, tautog
- MI common carp, rock bass, yellow perch, largemouth bass, smallmouth bass, walleye, northern pike, muskellunge, white bass, longnose sucker, white perch, brown bullhead, bullhead (unspecified), bluegill, brown trout, siscowet trout, lake trout, coho salmon, chinook salmon, splake, catfish (unspecified), rainbow trout, sucker (unspecified), gizzard shad, freshwater drum, white sucker, lake whitefish**
fish species (unspecified), yellow bullhead, burbot, quillback carpsucker, channel catfish, black crappie, white crappie, redhorse, smelt, lake sturgeon
crappie (unspecified), sauger, carpsucker (unspecified), sturgeon (unspecified), brook trout
- MN yellow perch, brown bullhead, black bullhead, yellow bullhead, quillback carpsucker, brown trout, brook trout, lake trout, chinook salmon, ciscowet, walleye, northern pike, muskellunge, splake, smallmouth bass, largemouth bass, rock bass, white bass, rainbow trout, white sucker, bluegill, black crappie, white crappie, shorthead redhorse, silver redhorse, common carp, smallmouth buffalo, sauger, bigmouth buffalo, channel catfish, lake whitefish, freshwater drum, pumpkinseed, lake herring, flathead catfish, bowfin, siscowet trout**
bass (unspecified), burbot, carp (unspecified), cisco, crappie (unspecified), redhorse, golden redhorse, coho salmon, lake sturgeon
tullibee, redhorse sucker, chub bloater
- MS fish species (unspecified), catfish (unspecified)**
largemouth bass, spotted bass, king mackerel
buffalo (unspecified)
- MO sturgeon (unspecified),, buffalo (unspecified), sucker (unspecified), paddlefish, catfish (unspecified), redhorse, freshwater drum**
carp (unspecified), fish species (unspecified), sunfish
common carp, channel catfish, flathead catfish
- MT fish species (unspecified), largemouth bass, smallmouth bass, burbot, black crappie, yellow perch, northern pike, kokanee salmon, white sucker, brook trout, brown trout, bull trout, cutthroat trout, lake trout, rainbow trout, walleye, lake whitefish, mountain whitefish**

-
- NE **common carp, channel catfish**
largemouth bass, catfish (unspecified), northern pike, fish species (unspecified)
- NV **fish species (unspecified)**
- NH freshwater fish (unspecified), largemouth bass, bluefish, American lobster
fish species (unspecified)
- NJ **striped bass, American eel, white perch, white catfish, fish species (unspecified)**
largemouth bass, bluefish, chain pickerel, blue crab, crustaceans (unspecified), American lobster, molluscs (unspecified)
- NM **white crappie, channel catfish, common carp, brown trout, river carpsucker, kokanee salmon, largemouth bass, bluegill, white bass, white sucker, yellow perch, black bullhead, black crappie, bass (unspecified), crappie (unspecified), rainbow trout, longnose dace, walleye, northern pike, bullhead (unspecified), black bass**
smallmouth bass, spotted bass
trout (unspecified), carpsucker (unspecified)
- NY **common carp, lake trout, brown trout, yellow perch, smallmouth bass, splake, American eel, goldfish, striped bass, white perch, bluefish, largemouth bass, brown bullhead, white catfish, walleye, rainbow smelt, tiger muskellunge, white sucker, chinook salmon, coho salmon, rainbow trout**
fish species (unspecified), sportfish (unspecified), channel catfish, Atlantic needlefish, blue crab, American lobster, brook trout
northern pike
- NC **largemouth bass, fish species (unspecified)**
bowfin, common carp, catfish (unspecified), white catfish, black crappie, white crappie, green sunfish, redear sunfish
- ND **walleye, white bass, yellow perch, northern pike, bigmouth buffalo, common carp, crappie (unspecified), white sucker, channel catfish, goldeye, sauger, smallmouth bass**
largemouth bass, brown bullhead, black crappie, white crappie, paddlefish, bluegill, brown trout, rainbow trout
bullhead (unspecified), chinook salmon, carpsucker (unspecified), sunfish (unspecified)

-
- OH **common carp, catfish (unspecified), white bass, sucker (unspecified), fish species (unspecified)**
largemouth bass, rock bass, smallmouth bass, spotted bass, hybrid striped bass, brown bullhead, yellow bullhead, channel catfish, flathead catfish, white crappie, freshwater drum, white perch, chinook salmon, coho salmon, sauger, white sucker, lake trout, steelhead trout, walleye
- OK **largemouth bass**
catfish (unspecified)
channel catfish, fish species (unspecified)
- OR **fish species (unspecified), crayfish**
largescale sucker, brown trout, black crappie, squawfish, largemouth bass, smallmouth bass, common carp, peamouth chub
- PA **white sucker, white perch, common carp, American eel, channel catfish, goldfish, largemouth bass, quillback carpsucker, white bass, lake trout, walleye, smallmouth bass, shorthead redhorse, sucker (unspecified), fish species (unspecified)**
spotted bass, hybrid striped bass, bowfin, flathead catfish, crappie, freshwater drum, muskellunge, northern pike, coho salmon, sauger, sunfish, bluegill, brown trout, rainbow trout, lake whitefish
green sunfish
- PR **no fish consumption advisories**
- RI **striped bass**
fish species (unspecified), bluefish
- SC **fish species (unspecified)**
largemouth bass, bowfin, catfish (unspecified), channel catfish, bluegill sunfish, redear sunfish
shellfish (unspecified)
- SD **no fish consumption advisories**
- TN **catfish (unspecified), largemouth bass, common carp, striped bass, sauger, white bass, smallmouth buffalo, fish species (unspecified)**
hybrid striped bass, redbreast sunfish
crappie (unspecified), rainbow trout
- TX **catfish (unspecified), fish species (unspecified)**
largemouth bass, hybrid striped bass, white bass, freshwater drum, king mackerel, crab (unspecified), blue crab
-

-
- UT **fish species (unspecified)**
- VT **brown trout, lake trout**
fish species (unspecified)
walleye
- VA **fish species (unspecified)**
smallmouth bass, striped bass, white bass, common carp, channel catfish,
flathead catfish
- VI **no fish consumption advisories**
- WA bottomfish species (unspecified), common carp, rockfish, shellfish
(unspecified), crab (unspecified), sucker, bridgelip sucker, lake whitefish,
mountain whitefish
no fish consumption advisories in 1993
- WV **channel catfish, common carp, sucker (unspecified), fish species
(unspecified)**
bottomfish species (unspecified), non-sportfish (unspecified), largemouth
bass, smallmouth bass, hybrid striped bass, white bass, flathead catfish,
freshwater drum, sauger
brown bullhead
- WI **coho salmon, chinook salmon, common carp, catfish (unspecified),
splake, rainbow trout, lake trout, brown trout, siscowet trout, northern
pike, white bass, white sucker, walleye, yellow perch, muskellunge,
flathead catfish, freshwater drum, channel catfish, bullhead
(unspecified), bluegill, black crappie, crappie (unspecified), rock bass,
smallmouth bass, redhorse (unspecified), largemouth bass, lake
sturgeon, buffalo (unspecified), fish species (unspecified)**
bigmouth buffalo, brown bullhead, carp (unspecified), chub, lake herring,
white perch, northern redhorse, sauger, sheepshead, smelt, green sunfish,
pumpkinseed, lake whitefish, panfish species (unspecified)
brook trout
- WY **no fish consumption advisories**

**ESTUARINE/MARINE FISH AND SHELLFISH SPECIES FOR WHICH STATE
CONSUMPTION ADVISORIES HAVE BEEN ISSUED**

1993 and 1998 (**Bold type**)

1998 only (Normal type)

1993 only (*Italic type*)

- AL king mackerel
no consumption advisories in 1993
- AK **no consumption advisories**
- AS **fish and shellfish species (unspecified)**
- CA **white croaker, black croaker, corbina, surfperch, queenfish, sculpin, rockfish, kelp bass, striped bass, fish and shellfish species (unspecified)**
bullhead, croaker (unspecified), gobies, shark
- CT **striped bass, bluefish**
- DE fish species (unspecified), striped bass, channel catfish, white catfish, white perch, carp, catfish (unspecified), largemouth bass
no consumption advisories in 1993
- DC no consumption advisories in 1998
channel catfish, American eel
- FL **shark (unspecified)**
gafftopsail catfish, crevalle jack, ladyfish, king mackerel, Spanish mackerel, spotted sea trout, yellow bullhead, gar, warmouth sunfish, bowfin
- GA Atlantic croaker, black drum, red drum, flounder, silver perch, spotted sea trout, clams, blue crab, mussels, oysters
no consumption advisories in 1993
- GU **no consumption advisories**
- HI fish and shellfish species (unspecified)
no consumption advisories in 1993
- LA **fish and shellfish species (unspecified)**
king mackerel
- ME striped bass, bluefish, American lobster,
no consumption advisories in 1993
- MD **channel catfish, American eel**

-
- MA **American eel, flounder, American lobster, bivalves (unspecified), fish species (unspecified)**
bottomfish (unspecified), scup, tautog
- MS king mackerel
no consumption advisories in 1993
- NH bluefish, American lobster
no consumption advisories in 1993
- NJ **striped bass, bluefish, American eel, white perch, white catfish, blue crab**
American lobster
fish and shellfish species (unspecified)
- NY **American eel, striped bass, bluefish, white perch, white catfish, rainbow smelt, Atlantic needlefish, blue crab**
American lobster, fish species (unspecified), largemouth bass, smallmouth bass, common carp, goldfish, walleye
- NC **fish species except herring, shad, striped bass, and shellfish species (unspecified)**
- OR **no consumption advisories**
- PA **white perch, channel catfish, American eel**
- PR **no consumption advisories**
- RI **striped bass, bluefish**
- SC bluegill, bowfin, largemouth bass
fish and shellfish species (unspecified)
- TX **blue crab, catfish (unspecified), fish species (unspecified)**
crab (unspecified), king mackerel
- VA no consumption advisories
fish species (unspecified)
- VI **no consumption advisories**
- WA bottomfish species (unspecified), rockfish, shellfish (unspecified), crab (unspecified)
no consumption advisories in 1993

SOURCES

RTI (Research Triangle Institute). 1993. *National Listing of State Fish and Shellfish Consumption Advisories and Bans*. (Current as of July 22, 1993.) Research Triangle Park, NC.

U.S. EPA (Environmental Protection Agency). 1999. *National Listing of Fish and Wildlife Consumption Advisories Database*. Office of Water. Washington, DC.

APPENDIX E

TARGET ANALYTES ANALYZED IN NATIONAL OR REGIONAL MONITORING PROGRAMS

Table E-1. Target Analytes Analyzed in National or Regional Monitoring Programs Reviewed by the 1993 Fish Contaminant Workgroup

Analyte	Monitoring program							
	a	b	c ¹	d	e	f	g	h
Metals								
Aluminum (Al)				●				●
Antimony (Sb)	●			●				●
Arsenic (As) (total)	●		●	●		●		●
Barium (Ba)								●
Beryllium (Be)	●							●
Cadmium (Cd)	●		●	●		●		●
Chromium (Cr)	●		●	●				●
Copper (Cu)	●		●	●		●		●
Cyanide	●							
Iron (Fe)				●				●
Lead (Pb)	●		●	●		●		●
Manganese (Mn)			●	●				●
Mercury (Hg)	●	●	●	●		●		●
Methylmercury	●							
Molybdenum								●
Nickel (Ni)	●			●				●
Selenium (Se)	●			●		●		●
Silicon (Si)				●				
Silver (Ag)	●			●				●
Thallium (Tl)	●			●				
Tin (Sn)				●				
Tributyltin								
Vanadium								●
Zinc (Zn)	●			●		●		●
Pesticides								
Aldrin	●		●	●		●	●	
Butachlor								●
Chlordane (cis & trans)	●	●	●	● ²		●	●	●
Chlorpyrifos		●						
Danitol							●	

(continued)

Table E-1. (continued)

Analyte	Monitoring program							
	a	b	c ¹	d	e	f	g	h
DCPA (chlorthal)						●		
DDT (total)			●	●		●		
2,4'-DDD (2,4'-TDE)			●	●		●		●
4,4'-DDD (4,4'-TDE)	●		●	●		●	●	●
2,4'-DDE			●	●		●		●
4,4'-DDE	●	●	●	●		●	●	●
2,4'-DDT			●	●		●		●
4,4'-DDT	●		●	●		●	●	●
Demeton	●							
Dicofol		●					●	●
Dieldrin	●	●	●	●		●	●	●
Diphenyl disulfide		●						
Endosulfan								
α-Endosulfan (endosulfan I)	●							
β-Endosulfan (endosulfan II)	●							
Endosulfan sulfate	●							
Endrin	●	●	●			●		●
Endrin aldehyde	●							
Ethyl-p-nitrophenylphenylphosphorothioate (EPN)							●	
Fonofos								
Guthion	●							
Heptachlor	●	●	●	●		●	●	●
Heptachlor epoxide	●	●		●		●	●	●
Hexachlorocyclohexane (HCH) also known as Benzene hexachloride (BHC)								
α-Hexachlorocyclohexane	●	●	●			●	●	●
β-Hexachlorocyclohexane	●		●				●	●
δ-Hexachlorocyclohexane	●		●					●
γ-Hexachlorocyclohexane (lindane)	●	●	●	●		●	●	●
Technical-hexachlorocyclohexane							●	
Hexachlorophene							●	
Isopropalin		●						●
Kepone								●

(continued)

Table E-1. (continued)

Analyte	Monitoring program							
	a	b	c ¹	d	e	f	g	h
Malathion	●							
Methoxychlor	●	●	●					●
Mirex	●	●	●	●		●	●	●
Nitrofen		●						
cis-Nonachlor		●				●		●
trans-Nonachlor		●		●		●		●
Oxychlorane		●				●		●
Parathion	●							
Toxaphene (mixture)	●		●			●	●	
Triazine herbicides								
Trichloronate								●
Trifluralin		●						●
Base/Neutral Organic Compounds								
Acenaphthene	●			●				●
Acenaphthylene	●			●				●
Anthracene	●			●				●
Benzidine	●							
Benzo(a)anthracene	●			●				●
Benzo(a)pyrene	●			●				●
Benzo(e)pyrene				●				
Benzo(b)fluoranthene	●			●				●
Benzo(k)fluoranthene	●			●				●
Benzo(g,h,i)perylene	●			●				●
Benzyl butyl phthalate	●							
Biphenyl		●		●				
4-Bromophenyl ether	●							
bis(2-Chloroethoxy)methane	●							
bis(2-Chloroethyl)ether	●							
bis(2-Chloroisopropyl)ether	●							
bis(2-Ethylhexyl)phthalate (BEHP)							●	
Chlorinated benzenes								
2-Chloronaphthalene	●							

(continued)

Table E-1. (continued)

Analyte	Monitoring program							
	a	b	c ¹	d	e	f	g	h
4-Chlorophenyl ether	●							
Chrysene	●			●				●
Dibenzo(a,h)anthracene	●			●				●
Di-n-butyl phthalate	●							
1,2-Dichlorobenzene	●							
1,3-Dichlorobenzene	●							
1,4-Dichlorobenzene	●							
3,3'-Dichlorobenzidine	●						●	
Diethyl phthalate	●							
2,6-Dimethylnaphthalene				●				●
2,3,5-Trimethylnaphthalene				●				
Dimethyl phthalate	●							
2,4-Dinitrotoluene	●							
2,6-Dinitrotoluene	●							
Di-n-octyl phthalate	●							
1,2-Diphenylhydrazine	●							
bis(2-Ethylhexyl) phthalate	●							
Fluoranthene	●			●				●
Fluorene	●			●				●
Heptachlorostyrene			●					
Hexachlorostyrene			●					
Hexachlorobenzene	●	●	●	●		●	●	●
Hexachlorobutadiene	●	●						
Hexachlorocyclopentadiene	●							●
Hexachloroethane	●							
Indeno(1,2,3-cd)pyrene	●			●				
Isophorone	●							
4,4'-Methylene bis(N,N'-dimethyl)aniline							●	
1-Methylnaphthalene				●				
2-Methylnaphthalene				●				
1-Methylphenanthrene				●				
Naphthalene	●			●				●

(continued)

Table E-1. (continued)

Analyte	Monitoring program							
	a	b	c ¹	d	e	f	g	h
Nitrobenzene	●							
N-Nitroso-di-n-butylamine							●	
N-Nitrosodimethylamine	●							
N-Nitrosodiphenylamine	●							
N-Nitrosodipropylamine	●							
Octachlorostyrene		●	●					●
PAHs (polycyclic aromatic hydrocarbons)								
PBBs (polybrominated biphenyls)			●					
PCBs (polychlorinated biphenyls)		●	●	●				●
Aroclor 1016 (mixture)	●						●	
Aroclor 1221 (mixture)	●						●	
Aroclor 1232 (mixture)	●						●	
Aroclor 1242 (mixture)	●					●	●	
Aroclor 1248 (mixture)	●					●	●	
Aroclor 1254 (mixture)	●					●	●	
Aroclor 1260 (mixture)	●					●	●	
Selected individual congeners				●				
Pentachloroanisole (PCA)		●				●		●
Pentachlorobenzene		●					●	●
Pentachloronitrobenzene (PCNB)		●						●
Pentachlorophenyl methyl ether								
Pentachlorophenyl methyl sulfide								
Pentachlorostyrene			●					
Perthane		●						●
Perylene				●				
Phenanthrene	●			●				●
Pyrene	●			●				●
Terphenyl			●					
1,2,3,4-Tetrachlorobenzene		●						●
1,2,3,5-Tetrachlorobenzene		●						●
1,2,4,5-Tetrachlorobenzene		●					●	●
1,2,3-Trichlorobenzene		●						

(continued)

Table E-1. (continued)

Analyte	Monitoring program							
	a	b	c ¹	d	e	f	g	h
1,2,4-Trichlorobenzene	●	●						●
1,3,5-Trichlorobenzene		●						●
Triphenyl phosphate								●
Dioxins								
1,2,3,7,8-Pentachlorodibenzodioxin (PeCDD)		●						●
2,3,7,8-Tetrachlorodibenzodioxin (TCDD)	●	●	●		●		●	●
1,2,3,4,6,7,8-Heptachlorodibenzodioxin (HpCDD)		●						●
1,2,3,4,7,8-Hexachlorodibenzodioxin (HxCDD)		●						●
1,2,3,6,7,8-Hexachlorodibenzodioxin (HxCDD)		●						●
1,2,3,7,8,9-Hexachlorodibenzodioxin (HxCDD)		●						●
Dibenzofurans								
1,2,3,4,6,7,8-Heptachlorodibenzofuran (HpCDF)		●						●
1,2,3,4,7,8,9-Heptachlorodibenzofuran (HpCDF)		●						●
1,2,3,4,7,8-Hexachlorodibenzofuran (HxCDF)		●						●
1,2,3,6,7,8-Hexachlorodibenzofuran (HxCDF)		●						●
1,2,3,7,8,9-Hexachlorodibenzofuran (HxCDF)		●						●
2,3,4,6,7,8-Hexachlorodibenzofuran (HxCDF)		●						●
1,2,3,7,8-Pentachlorodibenzofuran (PeCDF)		●						●
2,3,4,7,8-Pentachlorodibenzofuran (PeCDF)		●						●
2,3,7,8-Tetrachlorodibenzofuran (TCDF)		●						●
Acidic Organic Compounds								
Chlorinated phenols								
4-Chloro-3-cresol	●							
2-Chlorophenol	●							
2,4-Dichlorophenol	●							
2,4-Dimethylphenol	●							
4,6-Dinitro-2-cresol	●							
2,4-Dinitrophenol	●							
2-Nitrophenol	●							
4-Nitrophenol	●							
Pentachlorophenol (PCP)	●							●

(continued)

Table E-1. (continued)

Analyte	Monitoring program							
	a	b	c ¹	d	e	f	g	h
Phenol	●							
2,4,6-Trichlorophenol	●							
Volatile Organic Compounds								
Acrolein	●							
Acrylonitrile	●							
Benzene	●							
Bromodichloromethane	●							
Bromoform	●							
Bromomethane	●							
Carbon tetrachloride	●							
Chlorobenzene	●							
Chloroethane	●							
2-Chloroethylvinyl ether	●							
Chloroform	●							
Chloromethane	●							
Dibromochloromethane	●							
1,1-Dichloroethane	●							
1,2-Dichloroethane	●							
1,1-Dichloroethene	●							
trans-1,2-Dichloroethene	●							
1,2-Dichloropropane	●							
cis-1,3-Dichloropropene	●							
trans-1,3-Dichloropropene	●							
Ethylbenzene	●							
Methylene chloride	●							
1,1,2,2-Tetrachloroethane	●							
Tetrachloroethene	●							
Toluene	●							
1,1,1-Trichloroethane	●							
1,1,2-Trichloroethane	●							
Trichloroethene	●							
Vinyl chloride	●							

(continued)

Table E-1. (continued)

-
-
- ¹ Contaminants listed were monitored by at least one Great Lakes state. NOTE: Contaminants monitored exclusively by the Canadian Province of Ontario were not included.
- ² Only the *cis*-isomer is monitored.
- ^a 301(h) Monitoring Program. Source: U.S. EPA. 1985. *Bioaccumulation Monitoring Guidance: 1. Estimating the Potential for Bioaccumulation of Priority Pollutants and 301(h) Pesticides Discharged into Marine and Estuarine Waters*. EPA 503/3-90-001. Office of Marine and Estuarine Protection, Washington, DC.
- ^b National Study of Chemical Residues in Fish. Source: U.S. EPA. 1992. *National Study of Chemical Residues in Fish*. Volumes I and II. EPA 823/R-92-008a and 008b. Office of Science and Technology, Washington, DC.
- ^c Great Lakes Sport Fish Contaminant Advisory Program. Source: Hesse, J. L. 1990. *Summary and Analyses of Existing Sportfish Consumption Advisory Programs in the Great Lakes Basin—the Great Lakes*. Fish Consumption Advisory Task Force, Michigan Department of Health, Lansing, MI.
- ^d NOAA Status and Trends Program. Source: NOAA. 1989. *National Status and Trends Program for Marine Environmental Quality--Progress Report: A Summary of Selected Data on Tissue Contamination from the First Three Years (1986-1988) of the Mussel Watch Project*. NOAA Technical Memorandum NOS OMA 49. U.S. Department of Commerce, Rockville, MD.
- ^e EPA National Dioxin Study. Source: U.S. EPA. 1987. *National Dioxin Study. Tiers 3, 5, 6 and 7*. EPA 440/4-87-003. Office of Water Regulations and Standards, Washington, DC.
- ^f U.S. Fish and Wildlife Service National Contaminant Biomonitoring Program. Sources: C. J. Schmitt, J. L. Zajicek, and P. H. Peterman. 1990. National Contaminant Biomonitoring Program: Residues of organochlorine chemicals in U.S. freshwater fish, 1976-1984. *Arch. Environ. Contam. Toxicol.* 19:748-781; and T. P. Lowe, T. W. May, W. G. Brumbaugh, and D. A. Kane. 1985. National Contaminant Biomonitoring Program: Concentrations of seven elements in freshwater fish, 1978-1981. *Arch. Environ. Contam. Toxicol.* 14:363-388.
- ^g U.S. EPA. 1991. *Assessment and Control of Bioconcentratable Contaminants in Surface Waters*. Draft. Office of Water, Office of Research and Development, Washington, DC.
- ^h U.S. Geological Survey National Water-Quality Assessment Program. Source: J.K. Crawford and S.N. Luoma. 1993. *Guidelines for Studies of Contaminants in Biological tissues for the National Water-Quality Assessment Program*. USGS Open-File Report 92-494. U.S. Geological Survey, Lemoyne, PA.

APPENDIX F

PESTICIDES AND HERBICIDES RECOMMENDED AS TARGET ANALYTES

Table F-1. Pesticides and Herbicides Recommended as Target Analytes

Pesticide	Family	Use	Registration	EPA toxicity class ^a	EPA carcinogenicity classification ^b
Metal Containing Pesticides					
Arsenicals (including arsenic acid, arsenic trioxide, copper acetoarsenite, lead arsenate, calcium arsenate, sodium arsenite)	Inorganic arsenicals	A variety of inorganic arsenic compounds are used as herbicides, fungicides, insecticides and rodenticides, but registered uses of some were superseded because of their hazard to man and other nontarget species (<i>Farm Chemicals Handbook</i> , 1989)	Some inorganic arsenic compound registrations have been canceled; others are under restricted use application and others are in special review (U.S. EPA, 1993)	I	A
Tributyltins (tribylytin oxide)	Organotins	A variety of organotin compounds are used as wood preservatives, antifoulants, biocides, and disinfectants (<i>Farm Chemicals Handbook</i> , 1989)	Some organotin compounds have been actively registered since the mid-1960s. Several registrations have been canceled or manufacturers discontinued production (U.S. EPA, 1988a)	II	D
Organochlorines					
Chlordane	Chlorinated cyclodiene	Termite control. Historically used for control of fire ants, cutworms, grasshoppers, and on other insects on corn, grapes, strawberries, and other crops and as a dip for nonfood roots and tips of plants (Hartley and Kidd, 1987).	In March 1978, EPA issued a cancellation proceeding on chlordane, allowing only limited use on certain crops and pests until July 1983, but no use thereafter except for underground termite control (43 FR 12372). All uses were canceled in 1988.	II	B2
DDT	Chlorinated hydrocarbon	Insecticide	All uses in U.S. were canceled as of January 1, 1973, except for emergency public health uses.	III	B2
Dicofol	Chlorinated hydrocarbon	Miticide/pesticide on many fruit, vegetable, ornamental, and field crops. Used to control mites on cotton and citrus (80%). Other uses include control of mites on ornamental plants, fruits, and vegetables. Most of the usage is in California and Florida (U.S. EPA, 1998b).	Active registration since 1957. ^c	III	C ^d
Dieldrin	Chlorinated cyclodiene	Formerly used to control locusts, tropical disease carriers (e.g., mosquitoes), and termites, use as wood preservative, and moth proofing for woolen clothes and carpets (Worthing, 1991).	All uses on food products were suspended in 1974 (ATSDR, 1993). All registered uses in the U.S. were canceled in 1985.	II	B2
Endosulfan (I and II)	Chlorinated bicyclid sulfite	Insecticide and acaricide on citrus, deciduous, small fruits, coffee, tea, fiber crops, forage crops, forest, grains, nuts, oil crops, tobacco, ornamentals, and vegetables (ATSDR, 1999).	Active registration since 1954. ^c	I	E ^e

See notes and references at end of table.

(continued)

Table F-1. (continued)

Pesticide	Family	Use	Registration	EPA toxicity class ^a	EPA carcinogenicity classification ^b
Endrin	Chlorinated cyclodiene	Historically used to control cotton bollworms, as a foliar treatment for citrus, potatoes, small grains, apple orchards, sugarcane, and as flower and bark treatment on trees. Endrin has also been used to control populations of birds and rodents (U.S. EPA, 1980).	In 1964, endrin persistence in soils led to cancellation of its use on tobacco (U.S. EPA, 1980). By 1979, specified uses on cotton, small grains, apple orchards, sugarcane and ornamentals were also restricted (44 FR 43632). All uses in the U.S. were canceled in 1984 (U.S. EPA, 1984a).	I	D
Heptachlor epoxide	Chlorinated cyclodiene	Heptachlor epoxide is an oxidation product of heptachlor. It is a contaminant of both heptachlor and chlordane. Heptachlor was widely used as a termiticide and insecticide, primarily for ant control (Hodges, 1977). Chlordane was widely used for termite control as well as for control of fire ants, cutworms, grasshoppers and other insects (Hartley and Kidd, 1987).	Restrictions on heptachlor were first instituted in 1978 and heptachlor has not been sold in the U.S. since August 1987 (ATSDR, 1987).	NA	B2
Hexachlorobenzene	Chlorinated benzene	Primary use prior to 1985 was as a fungicide seed protectant in small grain crops, particularly wheat.	Registration for all uses was canceled in 1984 (Morris and Cabral, 1986).	IV	B2
Lindane (γ -hexachloro-cyclohexane)	Chlorinated hydrocarbon	Seed treatments, soil treatments for tobacco transplants, foliage applications on fruit and nut trees, vegetables, and wood and timber protection (ATSDR, 1998).	Active registration. Use of lindane in smoke fumigation devices for indoor domestic purposes was banned in 1985 (48 FR 48512, 50 FR 5424). Use in dog dips permitted only for veterinary use (U.S. EPA, 1985a). Application permitted only under supervision of certified applicator (U.S. EPA, 1985a). ^c	II	B2 ^e
Mirex	Chlorinated cyclodiene	Historically used primarily in fire ant control in southeastern states (Kutz et al., 1985) and was used industrially as a fire retardant and polymerizing agent in plastics under the name dechlorane (ATSDR, 1995).	Registration for all uses on field crops was canceled in 1977 (41 FR 56703) (NAS, 1978).	II	B2 ^f
Toxaphene	Chlorinated camphene	Historically used extensively on cotton (<i>Farm Chemicals Handbook</i> , 1989).	Registration for all uses was canceled in 1982 (47 FR 53784) and uses were canceled in 1990 (55 FR 31164-31174).	II	B2

See notes and references at end of table.

(continued)

Table F-1. (continued)

Pesticide	Family	Use	Registration	EPA toxicity class ^a	EPA carcinogenicity classification ^b
Organophosphates					
Chlorpyrifos	Heterocyclic organothio-phosphate	Insecticide primarily used to control soil and foliar insect pests on cotton, peanuts, and sorghum (Worthing, 1983; U.S. EPA, 1986a). In addition, it is used to control root-infesting and boring insects on a variety of fruits (e.g., citrus crops, apples, bananas, peaches, grapes, nectarines), nuts (e.g., almonds, walnuts), vegetables (e.g., beans, broccoli, brussel sprouts, cauliflower, soybeans, cabbage, peas) and field crops (e.g., alfalfa and corn) (U.S. EPA, 1986a) and to control ticks on cattle and sheep (Thomson, 1985). As a household insecticide it has been used to control ants, cockroaches, fleas, and mosquitoes (Worthing, 1983) and is registered for use in controlling subsurface termites in California (U.S. EPA, 1983).	Active registration since 1965 (U.S. EPA, 1984b). ^c Use patterns will change by the end of 2001. Virtually all residential use will end, as will use on tomatoes. Use on apples and grapes will be substantially reduced (U.S. EPA, 2000).	II	E ^g
Diazinon	Heterocyclic organothio-phosphate	Insecticide and nematicide for control of soil insects and pests of fruits, vegetables, tobacco, forage, field crops, range, pasture, grasslands, and ornamentals. Used to control cockroaches and other household insects; and grubs and nematodes in turf; as a seed treatment and for fly control (<i>Farm Chemicals Handbook</i> , 1989).	Active registration since 1952 (U.S. EPA, 1986b). ^c	II	Not likely ^e
Disulfoton	Aliphatic organothio-phosphate	Systemic insecticide and acaricide on grain, nut, cole, and root crops; pome, strawberry, and pineapple fruits; forage, field and vegetable crops, sugarcane, seed crops, forest plantings, ornamentals and potted plants (houseplants) (U.S. EPA, 1984c).	Active registration since 1958 (U.S. EPA, 1984c). ^c	I	E ^e
Ethion	Organothio-phosphate	Insecticide (nonsystemic) for control of leaf-feeding insects, mites, and scale insects. Citrus accounts for 86%-89% of total pounds of ethion used in the U.S. with the remaining 11%-14% applied to cotton, a variety of fruit trees, nut trees, and vegetables (U.S. EPA, 1989).	Active registration since 1965 (U.S. EPA, 1989). ^c	II	E ^e

See notes and references at end of table.

(continued)

Table F-1. (continued)

Pesticide	Family	Use	Registration	EPA toxicity class ^a	EPA carcinogenicity classification ^b
Terbufos	Organothiophosphate	Systemic insecticide and nematicide on corn, sugar beets, and grain sorghum (U.S. EPA, 1985c).	Active since 1974; however, granular end-use products containing 15% or more terbufos were classified as "Restricted Use" after September 1985 (U.S. EPA, 1985c; 1985b). ^c	I	E ^e
Chlorophenoxy Herbicides					
Oxyfluorfen	Diphenyl ether	Pre- and postemergence herbicide for a wide spectrum of annual broadleaf weeds and grasses in apples, artichokes, corn, cotton, tree fruit, grapes, nuts, spearmint, peppermint, certain topical plantation, and ornamental crops (<i>Farm Chemicals Handbook</i> , 1989)	Active since 1979. ^c	IV	C ^e

^a Designations are from EPA (1998a):

- I = Oral LD₅₀ up to and including 50 mg/kg in laboratory animals.
- II = Oral LD₅₀ >50 through 500 mg/kg in laboratory animals.
- III = Oral LD₅₀ >500 through 5,000 mg/kg in laboratory animals.
- IV = Oral LD₅₀ >5,000 mg/kg in laboratory animals.
- NA = No value available.

^b Designations are from IRIS (1999) unless otherwise noted: NA = not available; A = human carcinogen; B1, B2 = probable human carcinogen; C = possible human carcinogen; D = not classifiable as to human carcinogenicity; E = evidence of noncarcinogenicity for humans.

^c This pesticide has an active registration for agricultural use. The EPA Office of Pesticide Programs is responsible for registration and reregistration of pesticides. The 1988 Amendment of FIFRA requires EPA to reregister each "registered pesticide containing any active ingredient contained in any pesticide first registered before November 1, 1984, except for any pesticide as to which the Administration has determined, after November 1, 1984 . . . that—(1) there are no outstanding data requirements; and (2) the requirements of section 3(c)(5) have been satisfied" (U.S. EPA, 1988b). The Agency will review all relevant data submitted by the registrant for each pesticide reregistration and will use the data to conduct a risk assessment. Any subsequent regulatory action will be based on the results of the risk assessment. If the data submitted are incomplete at the predetermined review time, the pesticide may be suspended. Under the provisions of the Food Quality Protection Act of 1996, all pesticides with active registrations are undergoing review to determine if restrictions on their use are necessary for the protection of the health of infants and children. Contact EPA for further information on the status of the review process for specific pesticides.

^d EPA carcinogenicity classification based on Reregistration Eligibility Decision (RED) Dicofol (U.S. EPA, 1998b).

^e EPA carcinogenicity classification based on List of Chemicals Evaluated for Carcinogenic Potential (U.S. EPA, 1999).

^f EPA carcinogenicity classification based on HEAST, (1997).

^g EPA carcinogenicity classification based on Revised Human Health Risk Assessment for Chlorpyrifos (U.S. EPA 2000).

Note: The potential human toxicity of currently regulated pesticides is undergoing assessment as a result of provisions of the Food Quality Protection Act (1996). Consult EPA for the latest assessment information on the Internet at: <http://www.epa.gov/oppsrrd1/op/status.htm>.

Table F-1. (continued)

References:

- ATSDR (Agency for Toxic Substances and Disease Registry). 1987. *Draft Toxicological Profile for Heptachlor*. U.S. Public Health Service, Washington, DC.
- ATSDR (Agency for Toxic Substances and Disease Registry). 1993. *Toxicological Profile for Aldrin/Dieldrin (Update)*. U.S. Public Health Service, Washington, DC.
- ATSDR (Agency for Toxic Substances and Disease Registry). 1995. *Toxicological Profile for Mirex/Chlordecone*. U.S. Public Health Service, Washington, DC.
- ATSDR (Agency for Toxic Substances and Disease Registry). 1998. *Toxicological Profile for Alpha-, Beta-, Gamma-, and Delta-Hexachlorocyclohexane (Update)*. U.S. Public Health Service, Washington, DC.
- ATSDR (Agency for Toxic Substances and Disease Registry). 1999. *Draft Toxicological Profile for Endosulfan*. U.S. Public Health Service, Washington, DC.
- Farm Chemicals Handbook*. 1989. Meister Publishing Company, Willoughby, OH.
- Hartley, D., and H. Kidd (eds.). 1987. *Agrochemicals Handbook*. Royal Society of Chemistry, Nottingham, England.
- Hodges, L. 1977. *Environmental Pollution*. Holt, Rinehart and Winston, New York, NY.
- IRIS (Integrated Risk Information System). 1999. U.S. Environmental Protection Agency, Duluth, MN.
- Kutz, F.W., S.C. Strassman, C.R. Stroup, J.C. Carra, C.C. Leininger, D.L. Watts, and C.M. Sparacino. 1985. The human body burden of mirex in the southeastern United States. *J. Toxicol. and Environ. Health* 15:385-394.
- Morris, C.R., and J.R.P. Cabral (eds.). 1986. Hexachlorobenzene: Proceedings of an International Symposium. *IARC Scientific Publication No. 77*. World Health Organization, Lyon, France.
- NAS (National Academy of Sciences). 1978. *Kepon/Mirex/Hexachlorocyclopentadiene: An Environmental Assessment*. National Academy of Sciences, National Research Council, Washington, DC.
- Thomson, W.T. 1985. *Agricultural Chemicals Book I - Insecticide*, 1985 revision. Thomas Publication, Davis, CA.
- U.S. EPA (U.S. Environmental Protection Agency). 1980. *Ambient Water Quality Criteria for Endrin*. EPA-440/5-80-047. Office of Water Regulations and Standards, Washington, DC.
- U.S. EPA (U.S. Environmental Protection Agency). 1983. *Analyses of the Risks and Benefits of Seven Chemicals Used for Subterranean Termite Control*. EPA-540/9-83-005. Office of Pesticide Programs, Washington, DC.
- U.S. EPA (U.S. Environmental Protection Agency). 1984a. Internal memorandum from G. LaRocca to B. Burnam et al., August 16, 1984. Office of Pesticide Programs, Washington, DC.
- U.S. EPA (U.S. Environmental Protection Agency). 1984b. *Pesticide Fact Sheet—Chlorpyrifos*. Office of Pesticides and Toxic Substances, Office of Pesticide Programs, Washington, DC.
- U.S. EPA (U.S. Environmental Protection Agency). 1984c. *Pesticide Fact Sheet—Disulfoton*. Office of Pesticides and Toxic Substances, Office of Pesticide Programs, Washington, DC.
- U.S. EPA (U.S. Environmental Protection Agency). 1985a. *Guidance for the Registration of Pesticide Products Containing Lindane as the Active Ingredient*. EPA-540/RS-86-121. U.S. EPA Office of Pesticide Programs. Washington, DC.
- U.S. EPA (U.S. Environmental Protection Agency). 1985b. *Suspended, Cancelled, and Restricted Pesticides*. U.S. EPA Office of Pesticides and Toxic Substances, Washington, DC.
- U.S. EPA (U.S. Environmental Protection Agency). 1985c. *Pesticide Fact Sheet—Terbufos*. Office of Pesticides and Toxic Substances, Office of Pesticide Programs, Washington, DC.
- U.S. EPA (U.S. Environmental Protection Agency). 1986a. *Ambient Water Quality Criteria for Chlorpyrifos*. EPA-440/5-86-005. Office of Water Regulations and Standards, Washington, DC.
- U.S. EPA (U.S. Environmental Protection Agency). 1986b. *Pesticide Fact Sheet—Diazinon*. Office of Pesticides and Toxic Substances, Office of Pesticide Programs, Washington, DC.

Table F-1. (continued)

-
- U.S. EPA (U.S. Environmental Protection Agency). 1988a. *Pesticide Fact Sheet—Tributyltin Antifouling Paint*. Office of Pesticides and Toxic Substances, Office of Pesticide Programs, Washington, DC.
- U.S. EPA (U.S. Environmental Protection Agency). 1988b. *The Federal Insecticide, Fungicide, and Rodenticide Act as Amended*. EPA-540/09-89-012. Office of Pesticide Programs, Washington, DC.
- U.S. EPA (U.S. Environmental Protection Agency). 1989. *Pesticide Fact Sheet—Ethion*. Office of Pesticides and Toxic Substances, Office of Pesticide Programs, Washington, DC.
- U.S. EPA (U.S. Environmental Protection Agency). 1990. *Suspended, Cancelled, and Restricted Pesticides*. Document 20T-1002, Office of Pesticides and Toxic Substances, Washington, DC.
- U.S. EPA (U.S. Environmental Protection Agency). 1993. *Status of Pesticides in Reregistration and Special Review. Prevention, Pesticides and Toxic Substances*. EPA 738-R-93-009. Washington, DC.
- U.S. EPA (U.S. Environmental Protection Agency). 1998a. *Health Effects Test Guidelines*, OPPTS 870.1000. *Acute Toxicity Testing—Background: Prevention, Pesticides and Toxic Substances*. EPA-712-C-98-189. Washington, DC.
- U.S. EPA (U.S. Environmental Protection Agency). 1998b. *Reregistration Eligibility Decision for Dicofol*. Office of Pesticide Programs, Washington, DC.
- U.S. EPA (U.S. Environmental Protection Agency). 1999. *List of Chemicals Evaluated for Carcinogenic Potential*. Office of Pesticide Programs, Health Effects Division, Washington, DC.
- U.S. EPA (U.S. Environmental Protection Agency). 2000. *Revised Human Health Risk Assessment for Chlorpyrifos*. Office of Pesticide Programs, Washington, DC.
- Worthing, C.R. 1991. *The Pesticide Manual: A World Compendium*. 9th edition. British Crop Protection Council, Croydon, England.

APPENDIX G

TARGET ANALYTE DOSE-RESPONSE VARIABLES AND ASSOCIATED INFORMATION

Table G-1. Target Analyte Dose-Response Variables and Associated Information

Target analyte	Noncarcinogens		Carcinogens		
	RfD ^a (degree of confidence; uncertainty factor)	Critical toxic effect	CSF ^b (discussion of confidence)	Critical carcinogenic effect ^c	EPA carcinogenicity classification ^d
Metals					
Arsenic (inorganic)	3 × 10 ⁻⁴ (medium; 3)	Hyperpigmentation, keratosis and possible vascular complications in humans	1.5	—	A
Cadmium	1 × 10 ⁻³ (high; 10)	Significant proteinuria in humans	NA	—	B1
Mercury (as methylmercury)	1 × 10 ^{-4e} (medium; 10)	Developmental neurological abnormalities in human infants	NA	—	C
Selenium ^f	5 × 10 ⁻³ (high; 3)	Selenosis in humans	NA	—	D
Tributyltin ^g	3 × 10 ⁻⁴ (high; 100)	Immunotoxicity in rats	NA	—	D
Organochlorine Pesticides					
Chlordane (sum of <i>cis</i> - and <i>trans</i> -chlordane, <i>cis</i> - and <i>trans</i> -nonachlor, and oxychlordane) ^h	5 × 10 ⁻⁴ (medium; 300)	Hepatic necrosis in mice	0.35 (Adequate number of animals observed. CSF is the geometric mean of CSFs for five data sets).	Hepatocellular carcinomas in 5 strains of mice (male and female)	B2
DDT (sum of 4,4'- and 2,4'- isomers of DDT, DDE, and DDD) ⁱ	5 × 10 ⁻⁴ (medium; 100)	Liver lesions in rats	0.34 (CSF is geometric mean of CSFs from 10 data sets).	DDT: Liver tumors in seven studies in various mouse strains and three studies in three rat strains	B2

See notes and references at end of table.

(continued)

Table G-1. (continued)

Target analyte	Noncarcinogens		Carcinogens		
	RfD ^a (degree of confidence; uncertainty factor)	Critical toxic effect	CSF ^b (discussion of confidence)	Critical carcinogenic effect ^c	EPA carcinogenicity classification ^d
Dicofol	4 x 10 ^{-4j} (NA, 300)	Inhibition of ACTH stimulated release of cortisol in both sexes in 1-yr dog feeding study.	NA	—	C ^k
Dieldrin	5 x 10 ⁻⁵ (medium; 100)	Liver lesions (focal proliferation and focal hyperplasia) in one strain of female rats	16 (CSF is the geometric mean of CSFs from 13 data sets. Individual CSFs ranged within a factor of 8.)	Liver carcinomas in five strains of mice (male and female)	B2
Endosulfan (sum of endosulfan I and II)	6 x 10 ⁻³ (medium; 100)	Decreased body weight gain in male and female rat and progressive glomerulonephrosis and blood vessel aneurysms in one strain of male rats	NA	—	E ^l
Endrin	3 x 10 ⁻⁴ (medium; 100)	Mild histological lesions in livers, occasional convulsions in dogs (both sexes)	NA	—	D
Heptachlor epoxide	1.3 x 10 ⁻⁵ (low; 1000)	Increased liver-to-body weight ratios in male and female dogs	9.1 (Adequate number of animals observed in both studies, but survival in one study was low. This CSF is consistent with CSF = 5.8 for one strain of seven rats.)	Hepatocellular carcinomas in two strains of mice (male and female)	B2

See notes and references at end of table.

(continued)

Table G-1. (continued)

Target analyte	Noncarcinogens		Carcinogens		
	RfD ^a (degree of confidence; uncertainty factor)	Critical toxic effect	CSF ^b (discussion of confidence)	Critical carcinogenic effect ^c	EPA carcinogenicity classification ^d
Hexachlorobenzene	8 × 10 ⁻⁴ (medium; 100)	Liver effects (hepatic centrilobular basophilic chromogenesis) in one strain of rats (both sexes)	1.6 (Significant increases in malignant tumors observed among an adequate number of animals observed for their lifetime.)	Hepatocellular carcinomas in one strain of rats (females only)	B2
Lindane (γ-HCH)	3 × 10 ⁻⁴ (medium; 1,000)	Liver and kidney toxicity (liver hypertrophy, kidney tubular degeneration, hyaline droplets, tubular distension, interstitial nephritis, and basophilic tubules) in both sexes of one strain of rats	1.3 ^m	—	B2/C ¹
Mirex	2 × 10 ⁻⁴ (high; 300)	Liver cytomegaly, fatty metamorphosis, angiectasis and thyroid cystic follicles in one strain of rats.	NA	—	B2 ^m
Toxaphene	2.5 × 10 ⁻⁴ⁿ (NA, 1,000)	Slight liver degeneration—granularity and vacuolization of hepatocytes.	1.1 (Adequate number of animals observed. A dose-response effect was seen in a study with three non-zero dose levels.)	Hepatocellular carcinomas and neoplastic nodules in one strain of mice (males only)	B2

See notes and references at end of table.

(continued)

Table G-1. (continued)

Target analyte	Noncarcinogens		Carcinogens		
	RfD ^a (degree of confidence; uncertainty factor)	Critical toxic effect	CSF ^b (discussion of confidence)	Critical carcinogenic effect ^c	EPA carcinogenicity classification ^d
<u>Organophosphate Pesticides</u>					
Chlorpyrifos	3 x 10 ⁻⁴ ° (NA, 10)	Decreased plasma ChE activity observed in various animal feeding studies.	NA	—	E°
Diazinon	7 x 10 ⁻⁴ ^p (NA, 30)	Inhibition of plasma ChE observed in 90-d rat feeding study.	NA	—	Not likely E ¹
Disulfoton	4 x 10 ⁻⁵ (medium, 100)	ChE inhibition and degeneration of the optic nerve observed in 2-yr rat feeding study.	NA	—	E ¹
Ethion	5 x 10 ⁻⁴ (medium, 100)	Plasma ChE inhibition (in 21-d human feeding study) and inhibition of brain ChE observed in 90-d dog feeding study.	NA	—	E ¹
Terbufos	2 x 10 ⁻⁵ ^q (NA, 300)	Inhibition of plasma ChE observed in 28-d dog feeding study.	NA	—	E ¹
<u>Chlorophenoxy Herbicides</u>					
Oxyfluorfen	3 x 10 ⁻³ (high, 100)	Increased absolute liver weight and nonneoplastic lesions observed in 20-mo mouse feeding study.	7.32 x 10 ⁻²¹	Evidence of carcinogenicity (liver tumors) in mice.	C ¹

See notes and references at end of table.

(continued)

Table G-1. (continued)

Target analyte	Noncarcinogens		Carcinogens		
	RfD ^a (degree of confidence; uncertainty factor)	Critical toxic effect	CSF ^b (discussion of confidence)	Critical carcinogenic effect ^c	EPA carcinogenicity classification ^d
PAHs^f					
Benzo[a]pyrene	NA	—	7.3 (Data less than optimal, but acceptable. Four data sets used from two different studies using two different species (rats and mice; both sexes) to derive geometric mean of four calculated slope factors.)	Squamous cell carcinoma of the forestomach in one strain of mice (both sexes). Forestomach, larynx, and esophagus papillomas and carcinomas in one strain of rats (both sexes)	B2
PCBs					
Total PCBs (sum of Aroclors)	2×10^{-5} ^g (medium; 300)	Ocular exudate, inflamed, prominent Meibomian glands, distorted growth of fingernails, and toenails, decreased antibody response to sheep erythrocytes in monkey clinical and immunologic studies	2.0 ^h (Adequate number of animals observed for their normal lifespan. Only one non-zero test dose used.)	Trabecular carcinomas/adenocarcinomas, neoplastic nodules in one strain of rats (females only)	B2
Dioxins/furans					
	NA	—	1.56×10^{5u}	NA	B2 ^u

NA = Not available in IRIS (1992).

PAHs = Polycyclic aromatic hydrocarbons.

PCBs = Polychlorinated biphenyls.

DDT = p,p'-Dichlorodiphenyl trichloroethane.

DDD = p,p'-Dichlorodiphenyl dichloroethylene.

DDE = p,p'-Dichlorodiphenyl trichloroethane.

Table G-1. (continued)

- ^a RfD = Oral reference dose (mg/kg-d); from IRIS (1999) unless otherwise noted (see Section 5.1.1).
- ^b CSF = Oral cancer slope factor (mg/kg-d)⁻¹; from IRIS (1999) unless otherwise noted (see Section 5.1.2).
- ^c The critical effect is the effect observed in oral dose response studies used to determine the CSF.
- ^d Except where noted, all EPA carcinogenicity classifications are taken from IRIS (1999):
- A = Human carcinogen based on sufficient evidence from epidemiologic studies.
 - B1 = Probable human carcinogen based on limited evidence of carcinogenicity to humans.
 - B2 = Probable human carcinogen based on sufficient evidence in animals and inadequate or no data in humans.
 - C = Possible human carcinogen based on limited evidence of carcinogenicity in animals in the absence of human data.
 - D = Not classifiable based on lack of data or inadequate evidence of carcinogenicity from human or animal data.
 - E = No evidence of carcinogenicity for humans (no evidence of carcinogenicity in at least two adequate animal tests in different species or in both epidemiologic and animal studies).
- ^e The RfD for methylmercury should be considered an interim value. The National Academy of Sciences (NAS) conducted an independent assessment of the RfD and concluded, "On the basis of its evaluation, the committee consensus is that the value of EPA's current RfD for a scientifically justifiable level for the protection of human health." (NAS 2000).
- ^f The evidence of carcinogenicity for various selenium compounds in animals and mutagenicity studies is conflicting and difficult to interpret. However, evidence for selenium sulfides is sufficient for a B2 classification (IRIS, 1999).
- ^g The oral RfD and cancer classification are for tributyltin oxide (IRIS, 1999).
- ^h The RfD and CSF values listed are derived from studies using technical-grade chlordane (IRIS, 1999) for the *cis*- and *trans*-chlordane isomers or the major chlordane metabolite, oxychlordane, or for the chlordane impurities *cis*- and *trans*-nonachlor. It is recommended that the total chlordane concentration be determined by summing the individual concentrations of *cis*- and *trans*-chlordane, *cis*- and *trans*-nonachlor, and oxychlordane.
- ⁱ The RfD value listed is for DDT. The CSF value is for total DDT (sum of DDT, DDE, and DDD) or DDE; the CSF value for DDD is 0.24. The U.S. EPA Carcinogenicity Assessment Group recommended the use of CSF = 0.34 for any combination of DDT, DDE, DDD, and dicofol (Holder, 1986). It is recommended that the total concentration of the 2,4'- and 4,4'-isomers of DDT and its metabolites, DDE and DDD, be determined.
- ^j The RfD value is from a memorandum dated December 12, 1997. Dicofol: Report of the Hazard Identification Assessment Review Committee. HED Document No. 012439 (U.S. EPA, 1997b).
- ^k EPA carcinogenicity classification based on Reregistration Eligibility Decision (RED) Dicofol (U.S. EPA, 1998b).
- ^l EPA carcinogenicity classification based on U.S. EPA, (1999).
- ^m EPA CSF based on HEAST (1997).
- ⁿ Reference dose information is taken from the Office of Pesticide Programs Reference Dose Tracking Report (U.S. EPA, 1997a).
- ^o Oral RfD based on the Revised Human Health Risk Assessment for Chlorpyrifos (U.S. EPA, 2000).
- ^p The RfD value is from a memorandum dated April 1, 1998, Diazinon: Report of the Hazard Identification Assessment Review Committee. HED Doc. No. 012558 (U.S. EPA, 1998a).
- ^q The RfD value listed is from a memorandum dated September 25, 1997; Terbufos-FQPA Requirement- Report of the Hazard Identification Review. (U.S. EPA, 1997c).

Table G-1. (continued)

- ^r This CSF is for benzo[a]pyrene (IRIS, 1999). There are no other RfDs or CSFs listed for other PAHs in IRIS (1999). It is recommended that, tissue samples be analyzed for benzo[a]pyrene and 14 other PAHs (Nisbet and LaGoy, 1992; U.S. EPA, 1993) and that the order-of-magnitude relative potencies given for these PAHs be used to calculate a potency equivalency concentration (PEC) for each sample for comparison with the recommended SV for benzo[a]pyrene (see Section 5.3.2.4).
- ^s This RfD for PCBs is based on the chronic toxicity of Aroclor 1254 (IRIS, 1999).
- ^t This CSF is based on a carcinogenicity assessment of Aroclor 1260, 1254, 1242, and 1016. The CSF represented is the upper bound slope factor for food chain exposure. The central estimate is 1.0 (IRIS, 1999).
- ^u The CSF value listed is for 2,3,7,8-tetrachlorodibenzo-p-dioxin 2,3,7,8-TCDD (HEAST, 1997). It is recommended that, in both screening and intensive studies, the 17 tetra- through octa-chlorinated dibenzo-p-dioxins (PCDDs) and dibenzofurans (PCDFs) and the 12 dioxin-like PCBs be determined and a toxicity-weighted total concentration be calculated for each sample for comparison with the recommended SV, using the method for estimating Toxicity Equivalency Concentration (TEQ) (Van den Berg et al., 1998).

References:

- HEAST. 1997. *Health Effects Summary Tables*. Office of Emergency and Remedial Response, U.S. Environmental Protection Agency, Washington, DC.
- Holder, J.W. 1986. *The Assessment of the Carcinogenicity of Dicofol (Kelthane), DDT, DDE, and DDD (TDE)*. EPA-600/6-86/001. Carcinogenicity Assessment Group, Office of Pesticide Programs, U.S. Environmental Protection Agency, Washington, DC.
- IRIS (Integrated Risk Information System). 1999. U.S. Environmental Protection Agency, Duluth, MN.
- NAS (National Academy of Sciences). 2000. *Toxicological Effects of Methylmercury*. National Research Council, Washington, DC.
- Nisbet and LaGoy. 1992. Toxic equivalency factors (TEFs) for polycyclic aromatic hydrocarbons (PAHs). *Reg. Toxicol. Pharmacol.* 16:290-300.
- U.S. EPA (U.S. Environmental Protection Agency). 1993. *Provisional Guidance for Quantitative Risk Assessment of Polycyclic Aromatic Hydrocarbons*. EPA/600/R-93/089. Environmental Criteria and Assessment Office, Office of Health and Environmental Assessment, Cincinnati, OH.
- U.S. EPA (U.S. Environmental Protection Agency). 1997a. *Reference Dose Tracking Report*. Office of Pesticide Programs, Health Effects Division, Washington, DC.
- U.S. EPA (U.S. Environmental Protection Agency). 1997b. Memorandum dated December 12, 1997. *Dicofol: Report of the Hazard Identification Assessment Review Committee*. HED DOC No. 012439. Office of Pesticide Programs, Health Effects Division, Washington, DC.
- U.S. EPA (U.S. Environmental Protection Agency). 1997c. *Terbufos-FQPA Requirement—Report of the Hazardous Assessment Identification Review*. Office of Pesticide Programs, Washington, DC.
- U.S. EPA (U.S. Environmental Protection Agency). 1998a. Memorandum dated April 1, 1998. *Diazinon: Report of the Hazard Identification Assessment Review Committee*. HED DOC No. 012558. Office of Pesticide Programs, Health Effects Division, Washington, DC.
- U.S. EPA (U.S. Environmental Protection Agency). 1998b. *Reregistration Eligibility Decision for Dichofol*. Office of Pesticide Programs and Toxic Substances, Washington, DC.
- U.S. EPA (U.S. Environmental Protection Agency). 1999. *Classification List of Chemical Evaluated for Carcinogenicity Potential*. Office of Pesticide Programs, Washington, DC.
- U.S. EPA (U.S. Environmental Protection Agency). 2000. *Revised Human Health Risk Assessment for Chlorpyrifos*. Office of Pesticide Programs, Washington, DC.
- Van den Berg, et al. 1998. Toxic equivalency factors (TEFs) for PCBs, PCDDs, PCDFs for human and wildlife. *Environ. Health Perspec.* 106(12):775-792.

(continued)

APPENDIX H

A RECOMMENDED METHOD FOR INORGANIC ARSENIC ANALYSIS

Extracted from:

Creelius, E.A., N.S. Bloom, C.E. Cowan, and E.A. Jenne. 1986. *Speciation of Selenium and Arsenic in Natural Waters and Sediments*. Volume 2: Arsenic Speciation, Section 2, in EPRI report #EA-4641, Vol. 2, pp. 2-1 to 2-28.

APPENDIX H

A RECOMMENDED METHOD FOR INORGANIC ARSENIC ANALYSIS

Note: EPA is currently revising Method 1632: Determination inorganic arsenic in water by hydride generation flame atomic absorption to include fish tissue.

Section 2

DETERMINATION OF ARSENIC SPECIES IN LIMNOLOGICAL SAMPLES BY HYDRIDE GENERATION ATOMIC ABSORPTION SPECTROSCOPY

INTRODUCTION

This section describes the analytical methods used to determine the arsenic species in waters and sediments. Also, sample storage tests were conducted to select methods of storing and shipping environmental samples that would minimize changes in speciation. Based on results of previous studies we selected hydride generation coupled with atomic absorption spectroscopy as the method of quantification of arsenic. In this technique arsenate, arsenite, methylarsonic acid, and dimethylarsinic acid are volatilized from solution at a specific pH after reduction to the corresponding arsines with sodium borohydride (1). The volatilized arsines are then swept onto a liquid nitrogen cooled chromatographic trap, which upon warming, allows for a separation of species based on boiling points. The released arsines are swept by helium carrier gas into a quartz cuvette burner cell (2), where they are decomposed to atomic arsenic. Arsenic concentrations are determined by atomic absorption spectroscopy. Strictly speaking, this technique does not determine the species of inorganic arsenic but rather the valence states of arsenate (V) and arsenite (III). The actual species of inorganic arsenic are assumed to be those predicted by the geochemical equilibrium model described in Section 1 of this report.

EXPERIMENTAL SECTION

Apparatus

The apparatus needed for the volatilization, separation and quantitation of arsenic species is shown schematically in Figure 2-1-a. Briefly, it consists of a reaction vessel, in which arsenic compounds are reduced to volatile arsines, a liquid nitrogen cooled gas chromatographic trap, and a H-2 flame atomic absorption detector.

Reaction Vessel. The reaction vessel is made by grafting a side-arm inlet onto a 30-ml "Midget Impinger" (Ace Glass #7532-20), as illustrated in Figure 2-1-b. The 8-mm diameter side arm may then be sealed with a silicone rubber-stopper type septum (Ace Glass #9096-32) to allow the air-free injection of sodium borohydride. The standard impinger assembly is replaced with a 4-way Teflon stopcock impinger (Laboratory Data control #700542) to allow rapid and convenient switching of the helium from the purge to the analysis mode of operation.

GC Trap. The low temperature GC trap is constructed from a 6 mm o.d. borosilicate glass U-tube about 30-cm long with a 2-cm radius of bend (or similar dimensions to fit into a tall widemouth Dewar flask. Before packing the trap, it is silanized to reduce the number of active adsorption sites on the glass. This is accomplished using a standard glass silanizing compound such as Sylon-Ct® (Supelco Inc.). The column is half-packed with 15% OV-3 on Chromasorb® WAW-DMCS (45-60

mesh). A finer mesh size should not be used, as the restriction of the gas flow is sufficient to overpressurize the system. After packing, the ends of the trap are plugged with silanized glass wool.

The entire trap assembly is then preconditioned as follows: The input side of the trap (nonpacked side) is connected via silicone rubber tubing to helium at a flow rate of $40\text{-ml} \cdot \text{min}^{-1}$ and the whole assembly is placed into an oven at 175°C for 2 hours. After this time, two $25\text{-}\mu\text{l}$ aliquots of GC column conditioner (Silyl-8®, Supelco Inc.) are injected by syringe through the silicone tubing into the glass tubing. The column is then left in the oven with helium flowing through it for 24 hours. This process, which further neutralizes active adsorption sites and purges the system of foreign volatiles, may be repeated whenever anomalous peaks are observed to show broadening.

Once the column is conditioned, it is evenly wrapped with about 1.8 m of nichrome wire (22 gauge) the ends of which are affixed to crimp on electrical contacts. The wire-wrapped column is then coated about 2-mm thick all over with silicone rubber caulking compound and allowed to dry overnight. The silicone rubber provides an insulating layer which enhances peak separation by providing a longer temperature ramp time.

The unpacked side of the column is connected via silicone rubber tubing to the output from the reaction vessel. The output side of the trap is connected by a nichrome-wire wrapped piece of 6-mm diameter borosilicate tubing to the input of the flame atomizer. It is very important that the system be heated everywhere ($\sim 80^{\circ}\text{C}$) from the trap to the atomizer to avoid the condensation of water. Such condensation can interfere with the determination of dimethylarsine. All glass-to-glass connections in the system are made with silicone rubber sleeves.

Atomizer. The eluted arsines are detected by flame atomic absorption, using a special atomizer designed by Andreae (2). This consists of a quartz cross tube as shown in Figure 2-1-c. Air is admitted into one of the 6-mm o.d. side tubes (optimal flows are given in Table 2-1), while a mixture of hydrogen and the carrier gas from the trap is admitted into the other. This configuration is superior to that in which the carrier gas is mixed with the air (Andreae, personal communication 1983) due to the reduction of flame noise and possible extinguishing of the flame by microexplosions when H_2 is generated in the reaction vessel. To light the flame, all of the gases are turned on, and a flame brought to the ends of the quartz cuvette. At this point a flame will be burning out of the ends of the tube. After allowing the quartz tube to heat up (~ 5 minutes) a flat metal spatula is put smoothly first over one end of the tube, and then the other. An invisible air/hydrogen flame should now be burning in the center of the cuvette. This may be checked by placing a mirror near the tube ends and checking for water condensation. Note that the flame must be burning only inside the cuvette for precise, noise-free operation of the detector.

Precision and sensitivity are affected by the gas flow rates and these must be individually optimized for each system, using the figures in Table 2-1 as an initial guide. We have observed that as the O_2/H_2 ratio goes up, the sensitivity increases and the precision decreases. As this system is inherently very sensitive, adjustments are made to maximize precision.

Detector. Any atomic absorption unit may serve as a detector, once a bracket has been built to hold the quartz cuvette burner in the wave path. This work has been done using a Perkin-Elmer Model 5000® spectrophotometer with electrodeless discharge arsenic lamp. An analytical wavelength of 197.3 nm and slit width of 0.7 nm (low) are used throughout. This wavelength has been shown to have a longer linear range, though about half the sensitivity of the 193.7 nm line (2). Background

correction is not used as it increases the system noise and has never been found necessary on the types of sample discussed in this paper.

Standards and Reagents

Arsenite (As(III)) Standards. A 1000 • mg l⁻¹ stock solution is made up by the dissolution of 1.73 grams of reagent grade NaAsO₂ in 1.0-liter deionized water containing 0.1% ascorbic acid. This solution is kept refrigerated in an amber bottle. A 1.0 mg • l⁻¹ working stock solution is made by dilution with 0.1% ascorbic acid solution and stored as above. Under these conditions this solution has been found stable for at least one year.

Further dilutions of As(III) for analysis, or of samples to be analyzed for As(III), are made in filtered Dungeness River water. It has been observed both here and elsewhere (Andreae 1983) that deionized water can have an oxidizing potential that causes a diminished As(III) response at low levels (1 µg l⁻¹ and less). Dilute As(III) standards are prepared daily.

Arsenate (As(V)) Standards. To prepare a 1000 mg • l⁻¹ stock solution, 4.16 g of reagent grade Na₂HASO₄ • 7H₂O are dissolved in 1.0 liter of deionized water. Working standards are prepared by serial dilution with deionized water and prepared monthly.

Monomethylarsonate (MMA) Standards. To prepare a stock solution of 1000 mg • l⁻¹, 3.90 g of CH₃AsO(ONa)₂ • 6H₂O is dissolved in 1.0 liter of deionized water. Working standards are prepared by serial dilution with deionized water. Dilute standards are prepared weekly.

Dimethylarsinate (DMA) Standards. To prepare a stock solution of 1000mg l⁻¹, 2.86 g of reagent grade (CW3)2AsO₂Na 3H₂O (cacodylic acid, sodium salt) is dissolved in 1.0 liter deionized water. Dilute standards are handled as for MMA.

6M Hydrochloric Acid. Equal volumes of reagent grade concentrated HCl and deionized water are combined to give a solution approximately 6M in HCl.

Tris Buffer. 394 g of Tris HCl (tris (hydroxymethyl) aminomethane hydrochloride) and 2.5 g of reagent grade NaOH are dissolved in deionized water to make 1.0 liter. This solution is 2.5 M in tris and 2.475 M in HCl, giving a pH of about 6.2 when diluted 50-fold with deionized water.

Sodium Borohydride Solution. Four grams of >98% NaBH₄ (previously analyzed and found to be low in arsenic) are dissolved in 100 ml of 0.02 M NaOH solution. This solution is stable 8-10 hours when kept covered at room temperature. It is prepared daily.

Phosphoric Acid Leaching Solution. To prepare 1.0 liter of 0.10 M phosphoric acid solution, 6.8 ml of reagent grade 85% H₃PO₄ are dissolved in deionized water.

Trisodium Phosphate Leaching Solution. To prepare 1.0 liter of 0.10 M trisodium phosphate solution, 6.8 ml of 85% H₃PO₄ and 12 g of reagent grade NaOH are dissolved in deionized water.

Acid Digestion Mixture. With constant stirring, 200 ml of concentrated reagent grade H₂SO₄ are slowly added to 800 ml concentrated HNO₃.

METHODS

Total Arsenic Determination

An aqueous sample (5-30 ml) is placed into the reaction vessel and 1.0 ml of 6M HCl is added. The 4-way valve is put in place and turned to begin purging the vessel. The G.C. trap is lowered into a Dewar flask containing liquid nitrogen (LN_2) and the flask topped off with LN_2 to a constant level. A 2.0-ml aliquot of NaBH_4 solution is then introduced through the silicone rubber septum with a disposable 3-ml hypodermic syringe and the timer turned on. The NaBH_4 is slowly added over a period of about 1 minute, being careful that the H_2 liberated by the reduction of water does not overpressurize the system or foam the contents out of the reaction vessel.

After purging the vessel for 8 minutes, the stopcock is turned to pass helium directly to the G.C. trap. In rapid order, the LN_2 flask is removed, the trap heating coil is turned on, and the chart recorder is turned on. The arsines are eluted in the order: AsH_3 , CH_3AsH_2 , $(\text{CH}_3)_2\text{AsH}$ according to their increasing boiling points given in Table 2.2 (1).

Arsenic (III) Determination

The same procedure as above is used to determine arsenite, except that the initial pH is buffered at about 5 to 7 rather than <1 , so as to isolate the arsenous acid by its pK_a (1). This is accomplished by the addition of 1.0 ml of Tris buffer to a 5- to 30-ml aliquot of unacidified sample. (If the sample is acidic or basic, it must be neutralized first, or the buffer will be exhausted.) For the As(III) procedure, 1.0 ml of NaBH_4 is added in a single short (~10 seconds) injection, as the rapid evolution of H_2 does not occur at this pH.

Small, irreproducible quantities of organic arsines may be released at this pH and should be ignored. The separation of arsenite, however, is quite reproducible and essentially 100% complete. As(V) is calculated by subtracting the As(III) determined in this step from the total inorganic arsenic determined on an aliquot of the same sample previously.

SEDIMENTS

Total Inorganic Arsenic

A 1.00-g aliquot of freeze-dried and homogenized sediment is placed into a 100-ml snap-cap volumetric flask. Five milliliters of deionized water is added to form a slurry and then 7 ml of the acid digestion mixture is added. After 5 minutes, the caps are replaced and the flasks heated at 80 to 90°C for 2 hours. Upon cooling the samples are diluted to the mark with deionized water, shaken, and allowed to settle overnight. An appropriate-sized aliquot of the supernatant liquid (25-100 μl) is added to 20 ml of deionized water and run as for total arsenic.

Leachable Arsenite

An aliquot (~1-2 g) of fresh or freshly thawed wet homogeneous sediment is weighed to the nearest 10 mg directly into a 40-ml acid-cleaned Oak Ridge type centrifuge tube. To this is added 25 ml of 0.10 M H_3PO_4 solution and the tubes are agitated with the lids on. Periodic agitation is maintained

for 18 to 24 hours, at which time the tubes are centrifuged for 30 minutes at 2500 RPM. Twenty milliliter aliquots of the supernatant liquid are removed by pipetting into cleaned polyethylene vials and saved in the refrigerator until analysis. Analysis should be accomplished within the next couple days.

For analysis, an appropriate-sized aliquot (10-100 μ l) is added to 20 ml of well-characterized filtered river water (or other nonoxidizing/nonreducing water). Enough 1.0 M NaOH solution is added to approximately naturalize the H_3PO_4 (1/3 the volume of the sample aliquot), and then 1.0 ml of Tris buffer is added. The sample is then analyzed as for As(III).

Leachable Arsenate, MMA and DMA

An aliquot (~1-2 g) of wet sediment is weighed into a centrifuge tube, as above. To this are added 25 ml of 0.1 M Na_3PO_4 solution, and the tubes agitated periodically for 18 to 24 hours. After centrifugation the supernatant liquid (dark brown due to released humic materials) is analyzed as for total arsenic using an appropriate-sized aliquot in 20 ml of deionized water. The total inorganic arsenic in this case should be only As(V), as As(III) is observed to not be released at this pH. No pre-neutralization of the sample is necessary as the HCl added is well in excess of the sample alkalinity.

Interstitial Water Analysis

Interstitial water samples may be treated just as ordinary water, except that as they are quite high in arsenic, usually an aliquot of 100 to 1000 μ l diluted in deionized water or river water is appropriate in most cases.

Storage Experiments

Storage experiments designed to preserve the original arsenic speciation of samples were carried out for a wide variety of conditions. For water samples, 30-ml and 60-ml polyethylene bottles pre-cleaned in 1 M HCl were used.

Conditions of temperature ranging from 20°C to -196°C were assessed, as well as preservation with HCl and ascorbic acid. Storage tests were carried out over a period of one month for water samples.

The stability of the As(III)/As(V) ratio in interstitial water at room temperature, in the presence of air was carried out over a 24-hour period to determine the feasibility of the field collection of interstitial water.

Because of the time-consuming nature of sediment analysis, a two-point storage test was carried out with triplicate samples analyzed for two sediments at two temperatures (0°C and -18°C). Mud samples were stored in polyethylene vials and analyzed at time zero and one month.

RESULTS AND DISCUSSION

Data Output

Using the procedures outlined above, and a mixed standard containing As(V), MMA, and DMA, standard curves were prepared for each of the arsines generated. A typical chromatogram from this procedure is illustrated in Figure 2.2. Under the conditions described in this paper, the elution times for the various arsines are as follows: AsH₃, 24 ± 2 s; CH₃AsH₂, 53 ± 2 s; and (CH₃)₂AsH, 66 ± 2 s. Notice that the peaks are broadened and that the sensitivity decreases as the boiling point of the compound increases. The small amount of signal after the DMA peak is probably a higher boiling impurity in the DMA, or some DMA that is lagging in the system during elution. We had previously noted much larger, multiple peaks in this region when water was allowed to condense between the trap and the detector. Such peaks were effectively eliminated and the DMA peak sharpened with the addition of the heating coil between the trap and the detector.

The typical standard curves in Figure 2.3 are prepared from the mean of two determinations at each concentration. Arsenic peak-height response appears to be linear to at least 600 mau (milliabsorbance units), which is the full scale setting used on our chart recorder. Andreae (3) shows that arsenic response is extremely nonlinear above this for the peak height mode, and recommends the use of peak area integration to increase the linear range. We have chosen to simply use a small enough sample aliquot to remain within 600 mau.

As arsenic response is quite sensitive to the H₂/O₂ ratio in the flame, it is necessary to restandardize the instrument whenever it is set up. Usually, however, the response is quite constant and stable over the entire day.

Precision, Accuracy, and Detection Limits

Precision and accuracy are the greatest and the detection limits the lowest for inorganic arsenic. The precision and accuracy of the inorganic arsenic determination is illustrated at two concentrations in Table 2-3. The standard seawater, NASS-1 (National Research Council of Canada) was run in 5.0-ml aliquots and the "standard river water" (National Bureau of Standards) was run in 100- μ l aliquots. In either case, both the precision (RSD) and accuracy were about 5%. Precision begins to decrease, as the boiling point of the compound increases, as is illustrated in Table 2-4, for spiked river water. No standard reference material has been found for the organic species.

The detection limit of this technique has not been explored to the extreme as the usual environmental sample benefits from less, not more sensitivity. For a chart recorder expansion of 600 mau full scale, and the parameters given in the text, and for a 30-ml sample aliquot, the following approximate detection limits are found: As(V), 0.006 $\mu\text{g} \cdot \text{l}^{-1}$ (twice the standard deviation of the blank); As(III) 0.003 $\mu\text{g} \cdot \text{l}^{-1}$ (0.5 chart units); MMA, 0.010 $\mu\text{g} \cdot \text{l}^{-1}$ as As (0.5 chart units); DMA, 0.012 $\mu\text{g} \cdot \text{l}^{-1}$ as As (0.5 chart units). For As(III), MMA and DMA, no contribution to the blank has been found due to reagents, except for the As(III) present in the river water used as a dilutant. As for As(V) a small contribution is found, mostly from the NaBH₄, and to a smaller extent from H₃PO₄. These may be minimized by selecting reagent lots of reagents found to be low in arsenic.

Water Storage Experiments

From the many experiments undertaken to determine a storage regime for arsenic species, the following general conclusion can be made: Almost any storage scheme will preserve the total arsenic, MMA, and DMh concentrations of river water in the $\mu \cdot 1^{-1}$ range. This is illustrated in the Figures 2-4a-p, where the final concentration of these parameters was within $\pm 20\%$ of the initial in all cases. The noise in the data is due mostly to the day-to-day analytical variability, which has been observed to be about twice that of same-day replicate analysis. On the other hand, these data also show that it is very difficult to preserve the original As(III)/As(V) ratio in samples, even for a short time. Two major observations are made: first, river water (Oungeness River water) tends to spontaneously reduce As(V) to As(III), even though the water has been filtered to 0.4 μ , thus removing most living creatures. This is also curious, as the natural equilibrium As(III)/As(V) ratio is about 0.2 in Dungeness River water. It is surmised that dissolved organic materials in the water are responsible for its reducing properties, a conclusion that is supported by work involving the reduction of Hg(II) to Hg(0) by humic acids (Bloom, unpublished work). The second observation is that the freezing of water inexplicably, but reproducibly causes the oxidation of As(III) to As(V) (Figure 2-4-g, i), except in the case of very rapid freezing by immersion in LN₂ (Figure 2-4-m, o).

In light of these observations, the following storage regimes are recommended for arsenic in aqueous solution:

1. If only total inorganic arsenic plus MMA and DMA are to be determined, the sample should be stored at 0 to 4°C in polyethylene bottles until analysis. No chemical preservative is needed or desired and the analysis should be carried out as soon as possible.
2. If the As(III)/As(V) ratio is to be maintained, the sample must be quick-frozen to -196°C in liquid nitrogen, and then stored at at least -80°C until analysis. Note that Figure 4-k shows that even in the case of rapid freezing to -196°C, followed by storage at -18°C, a definite oxidation of As(III) to As(V) was observed.

A convenient and safe way to quick-freeze samples is to place 55 ml of sample into a 60-ml narrow-mouth polyethylene bottle, screw on the cap (which has a 2 mm diameter hole) tightly, and drop into a Dewar flask full of liquid nitrogen. These bottles have been shown not to crack if less than 58 ml of water is placed in them, and not to float in the LN₂ if more than 50 ml is placed in them. After returning to the laboratory, the bottles may be placed into a low temperature freezer until analysis. Note of caution, if a small hole is not placed in the lid of the bottles, which are frozen in liquid nitrogen, the bottles may explode when removed from the liquid nitrogen.

Determination of Arsenic Species in Sediments

Two procedures were investigated in the determination of arsenic in sediments. One, a wet-acid digestion was used to determine total arsenic. The second was a mild, pH-selective leach to remove various arsenic species intact.

Total Arsenic. In applying the hot HNO₃/H₂SO₄ digestion to standard sediments and air particulate matter, good agreement was attained between the established values and the measured values (Table 2-5). Also, in the case of estuarine and riverine sediments collected in the Puget Sound area, there was good agreement between X-ray fluorescence spectroscopy and tffis method (Table 2-6). In either case, all observed arsenic was in the inorganic form.

However, when Lake Washington sediment spiked with inorganic as well as organic forms was analyzed by this method, the following was observed:

1. All of the MMA was recovered as MMA.
2. All of the inorganic arsenic was recovered as inorganic arsenic.
3. None of the DMA was recovered, but an unidentified higher boiling peak was generated.

This peak is clearly illustrated in Figure 2-5. Even after the above samples were redigested to near-dryness (white fumes) in HNO_3 plus HClO_4 , the same results were obtained. Therefore, at this point we recommend no hydride generation method to determine total arsenic in sediments, though this may be achieved using either neutron activation analysis or X-ray fluorescence spectroscopy. On the other hand, since no organic forms have been detected in any natural sediment and since both MMA and DMA give observable peaks if they are present, it is safe to assume as a general guideline that if only an inorganic arsenic peak is generated by a given sample, then it probably represents close to the total arsenic content of the sample.

Arsenic Speciation of Sediments. Maher (4) has shown that various arsenic species that may be removed from solids at different pH values. This approach was tested on a sample of spiked Lake Washington mud, over a wide range of pH using phosphate buffers. The results of these experiments, shown as arsenic recovered versus pH for all four species, are illustrated in Figure 2-6. Notice that the maximum recovery of As(III) occurs at about pH = 2.8 and that the maximum for As(V), MMA and DMA occur at pH >12. From these data, the two convenient buffers of 0.1 M H_3PO_4 (pH = 1.5) and Na_3PO_4 (pH = 12) were chosen to selectively extract the arsenic species from sediments. Samples extracted with H_3PO_4 (final pH = 2.3) are analyzed only for As(III) whereas those extracted with Na_3PO_4 (final pH = 11.9) are analyzed only for total As, which gives As(V), MMA and DMA, as As(III) is not extracted at this pH. On untested sediment types it would be wise to test this relationship to be sure it holds true before instituting an analytical regime.

Recovery of arsenic species from spiked Lake Washington mud is illustrated in Table 2-7. The calculated spike was added to the mud, which was then aged 14 days at 4°C before analysis. All analysis were carried out in quintuplicate. The yields are good and within the day-to-day variability for the respective species.

The values of the above analysis were then taken as the time zero values, and the mud divided and stored in one of two ways. Three aliquots each of Lake Washington mud (LWM) and spiked LWM were placed into polyethylene bottles and frozen at -18°C, while three aliquots were kept refrigerated at 0 to 4°C. After 30 days these samples were analyzed for arsenic species, the results of which are shown in Table 2-8. These data indicate that small changes in the concentrations of the various species may be occurring, with significant decreases (20-30%) in the organic species being seen. These changes are small enough, however, that if the samples were analyzed as soon as possible after collection, they should not be of great importance.

Interstitial Water. Interstitial water is collected from mud by pressure filtration under nitrogen. An aliquot (~100 g) of mud is placed into a plastic pressure filtration vessel with 1.0 μ acid-cleaned filter, and tapped down to remove air bubbles. The system is pressurized to 75 psi, and after discarding the first 1 to 2 ml of filtrate, the interstitial water is collected into a 30-ml polyethylene bottle under nitrogen. The As(III) stability curve in Figure 2-7 was generated on a sample in contact with air. Within 5 minutes, the sample had changed from colorless to brown, indicating that Fe(II)

had oxidized to Fe(III), and precipitated as colloidal Fe(OH)₃. If an aliquot of sediment is filtered under nitrogen and then frozen at -196°C, as for water samples, within 5 to 10 minutes, minimal changes in the As(III)/As(V) ratio should have taken place.

Using the above technique, a sample of spiked, Lake Washington sediment was analyzed for interstitial water arsenic speciation 30 days after spiking with arsenic. This data is presented in Table 2-9 and shows that the distribution coefficients (K_d) of the various species between the solid and aqueous phases increase in the following order: DMA << MMA < As(III) < As(V). In fact, a sizable fraction (4.3%) of the DMA is in the interstitial water in a given sample, a fact which is important considering the intimate interaction of the interstitial water and living creatures.

Interlaboratory Comparison

An interlaboratory comparison exercise was conducted between Battelle-Northwest (BNW) and Dr. M.O. Andreae of Florida State University (FSU) to demonstrate the effectiveness of the sample storage and shipping procedure and verify the accuracy of the analytical technique for determination of arsenic species in fresh water. Three samples were prepared as follows: (1) Dungeness River water (DRW) was filtered, (2) filtered DRW was spiked with nominally 0.45 µg L⁻¹ of As (V) and 2 µg L⁻¹ each of DMA and MMA, and (3) coal fly ash, standard reference material NBS-1633, was leached with DRW then filtered. All solutions were frozen immediately after preparation in liquid nitrogen then transferred and stored at -80°C. Samples were shipped on dry ice. Samples were analyzed at BNW and FSU the same week approximately two months after preparation. The results in Table 2-10 show good agreement between these two laboratories even for concentrations below 0.1 µg L⁻¹. We believe this interlaboratory exercise has demonstrated that these storage and shipping procedures are appropriate for freshwater samples and the analytical method used for arsenic speciation is sensitive and accurate for concentrations of inorganic arsenic greater than approximately 0.05 and for organic arsenic concentrations greater than 0.2 µg L⁻¹.

Precision for Sediments and Water

The precision or reproducibility for replicate analyses of arsenic species in field samples is shown in Table 2-11. Collection of these field samples is described in Section 3 of this report. The sediment was analyzed for leachable As (III) and As (V). Interstitial water and water from Hyco Reservoir were also analyzed for As (III) and (V). The results indicate that the relative standard deviations (RSD) for arsenic (III) and (V) in sediment are approximately 20% while the RSD for these species in interstitial water and in the water column are approximately 15% and 7%.

CONCLUSIONS AND RECOMMENDATIONS FOR FURTHER WORK

Arsenic speciation of a variety of materials in the limnological environment is simply and reproducibly achieved using selective hydride generation/low-temperature trapping techniques in conjunction with atomic absorption detection. The most difficult problem is the unambiguous determination of total arsenic in solids by this technique. Other related techniques that might be investigated include dry ashing, lithium metaborate fusion, and graphite furnace atomic absorption. An alternate method is to analyze select samples by X-ray fluorescence spectrometry.

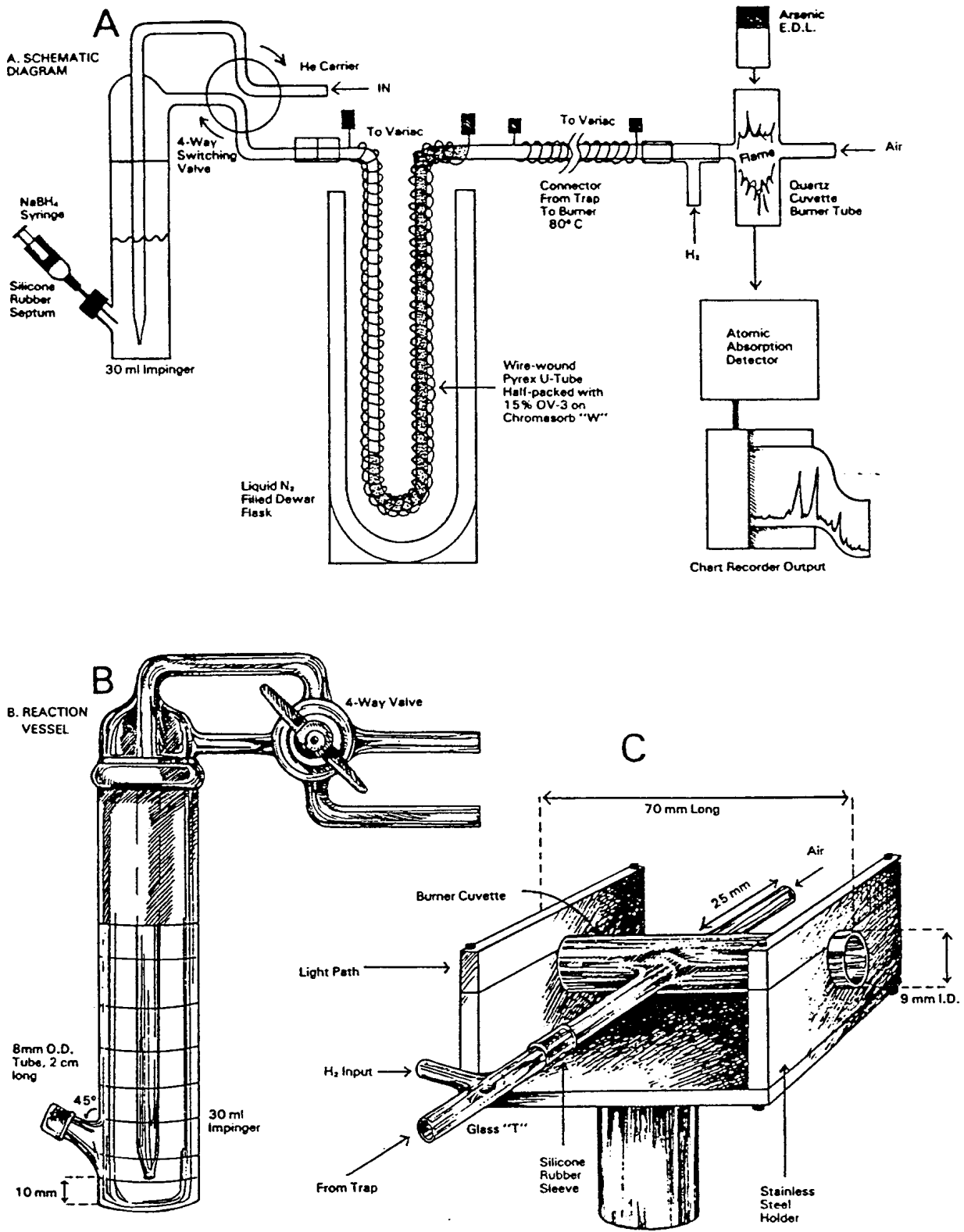

Figure 2-1. Arsenic Speciation Apparatus: (a) Schematic Diagram, (b) Reaction Vessel, (c) Quartz Cuvette Burner Tube.

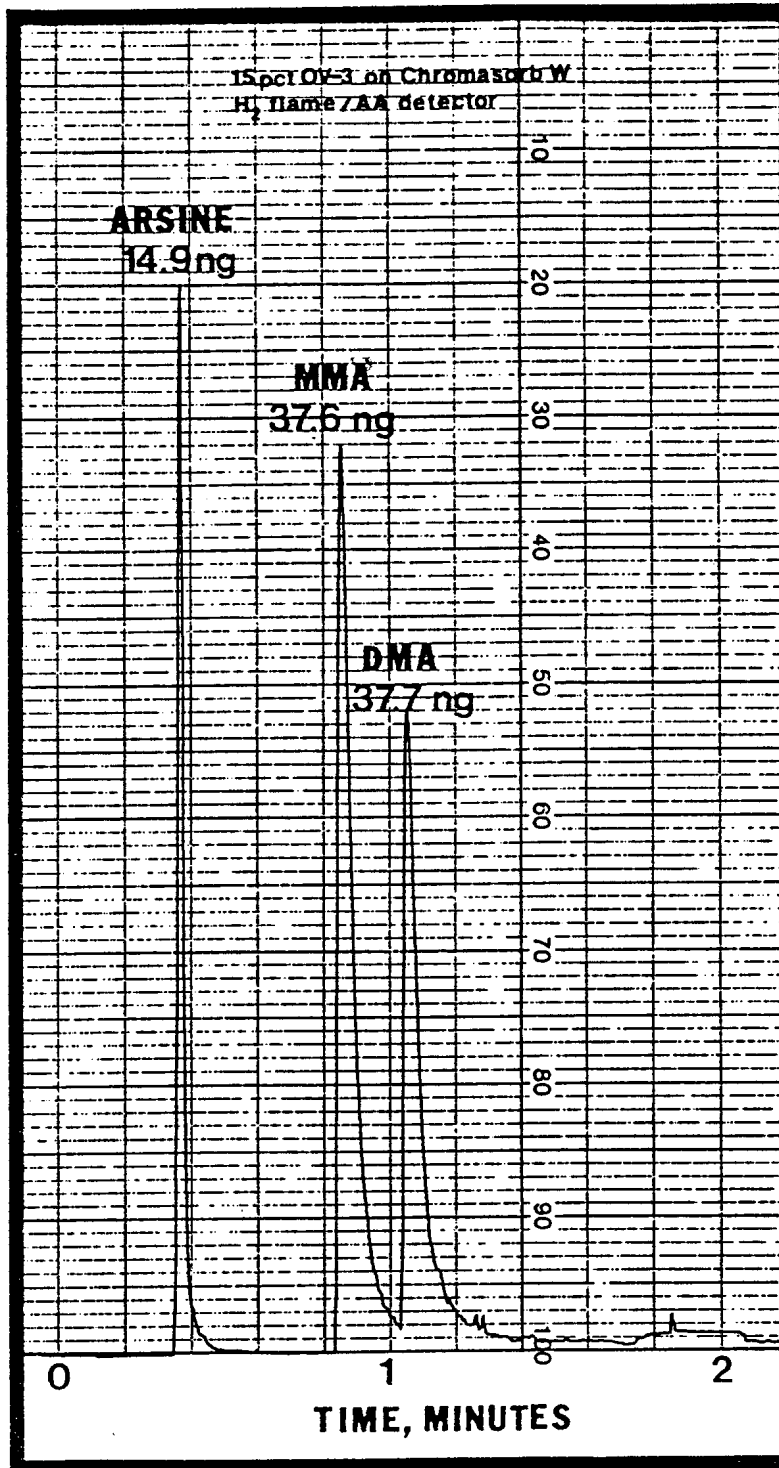

Figure 2-2. Typical chromatogram of arsenic hydride species. Vertical axis absorbance, horizontal axis time.

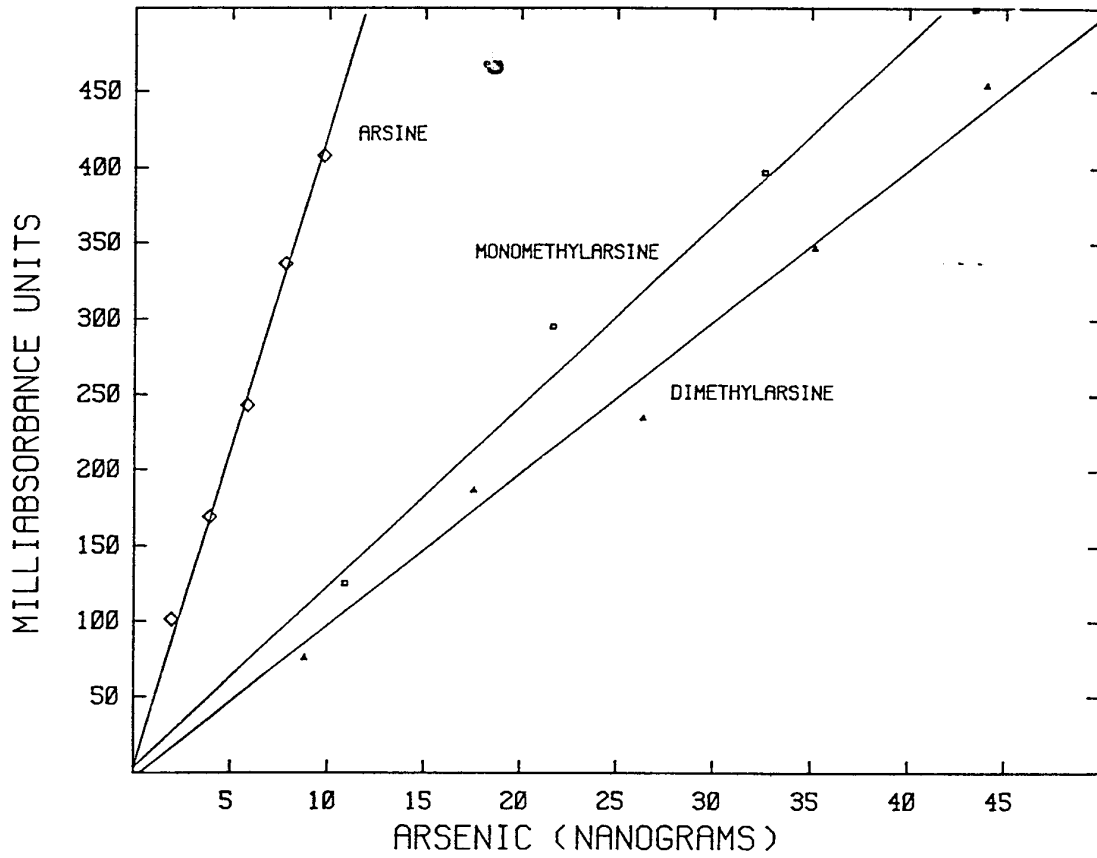

Figure 2-3. Standard curves, absorbance versus concentration for arsenic hydride species, atomic absorption detector.

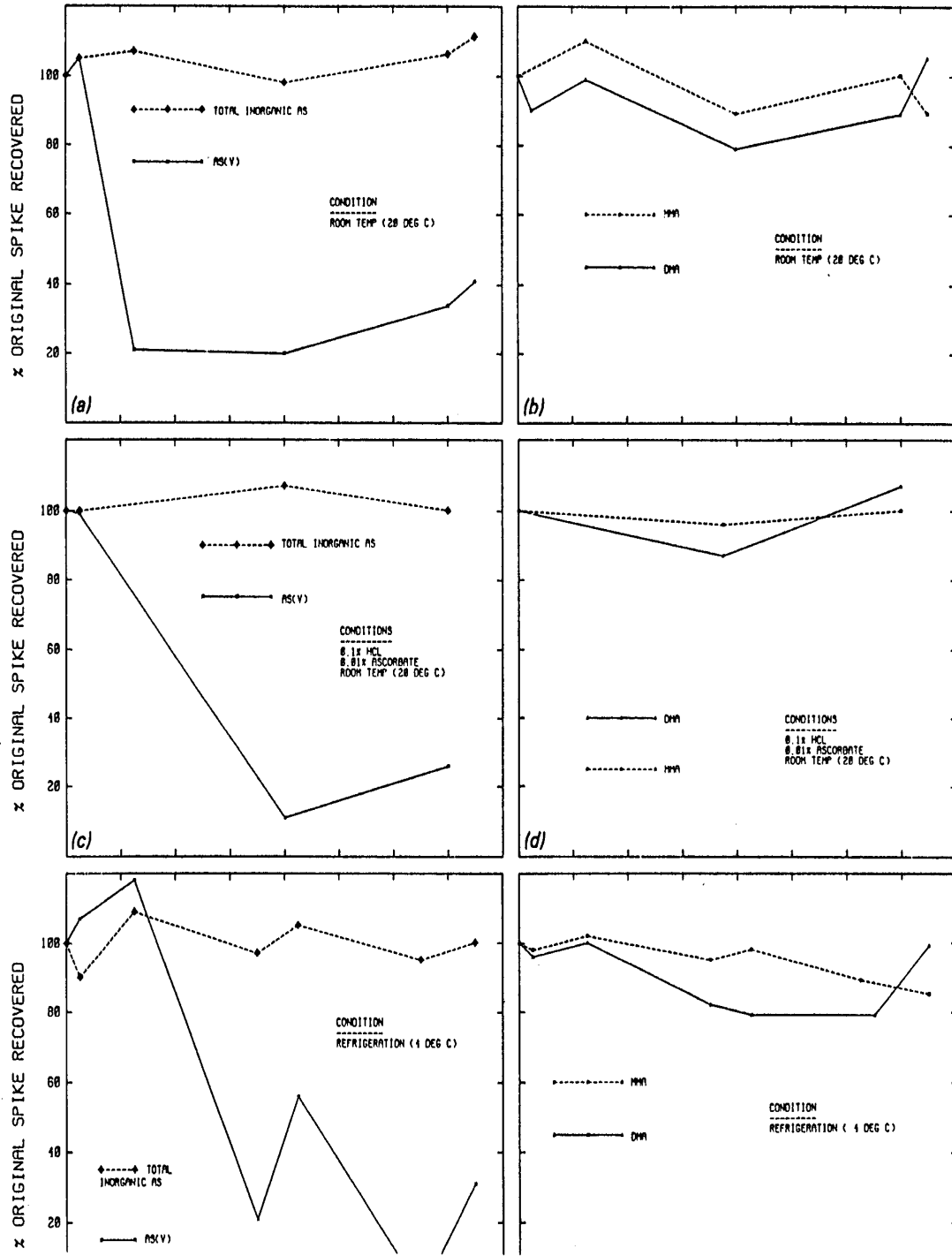

Figure 2-4a-p. Results of aqueous arsenic species storage tests. Plotted are the percentages of soluble arsenic species remaining versus storage time.

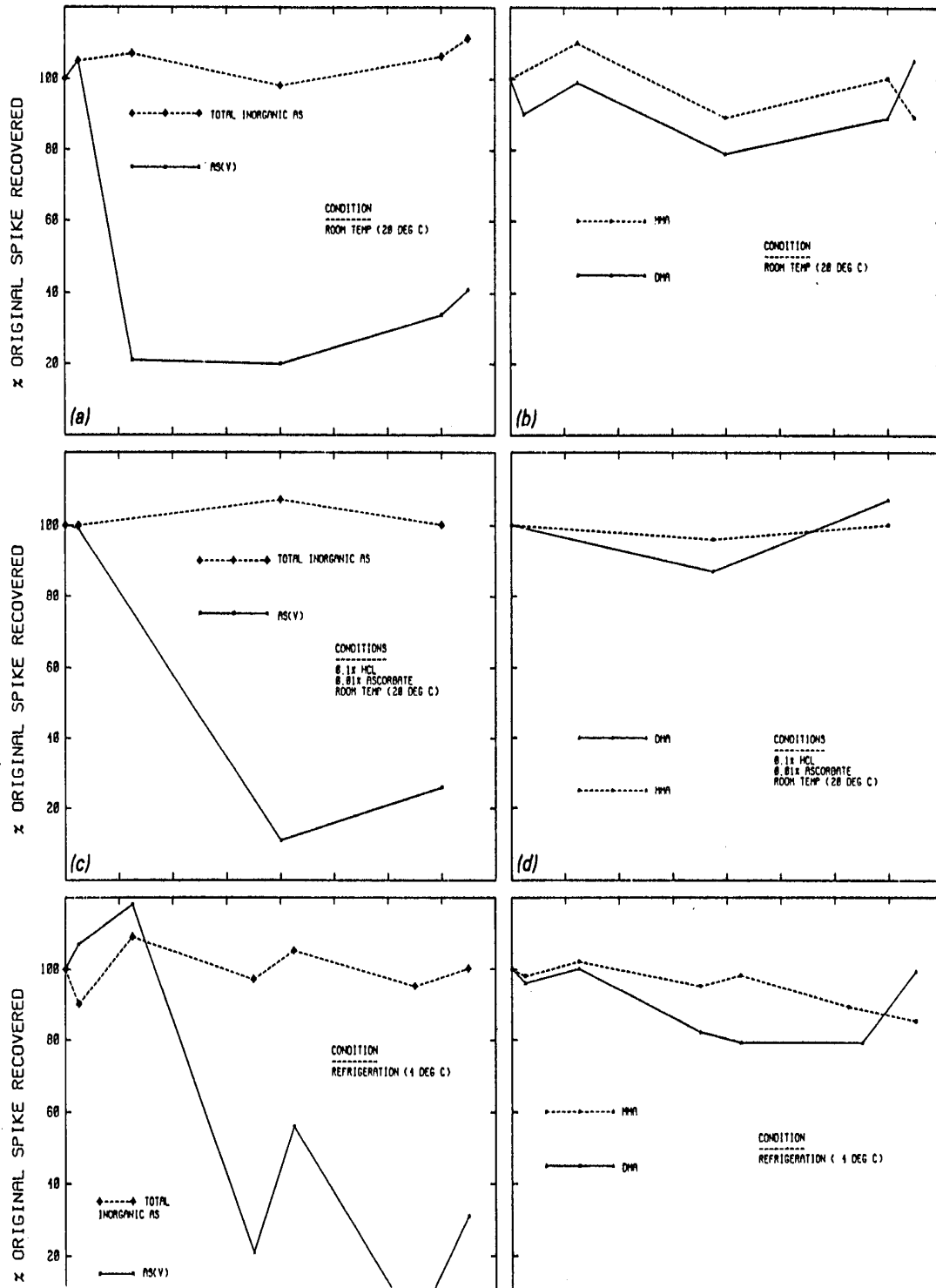

Figure 2-4a-p. (continued)

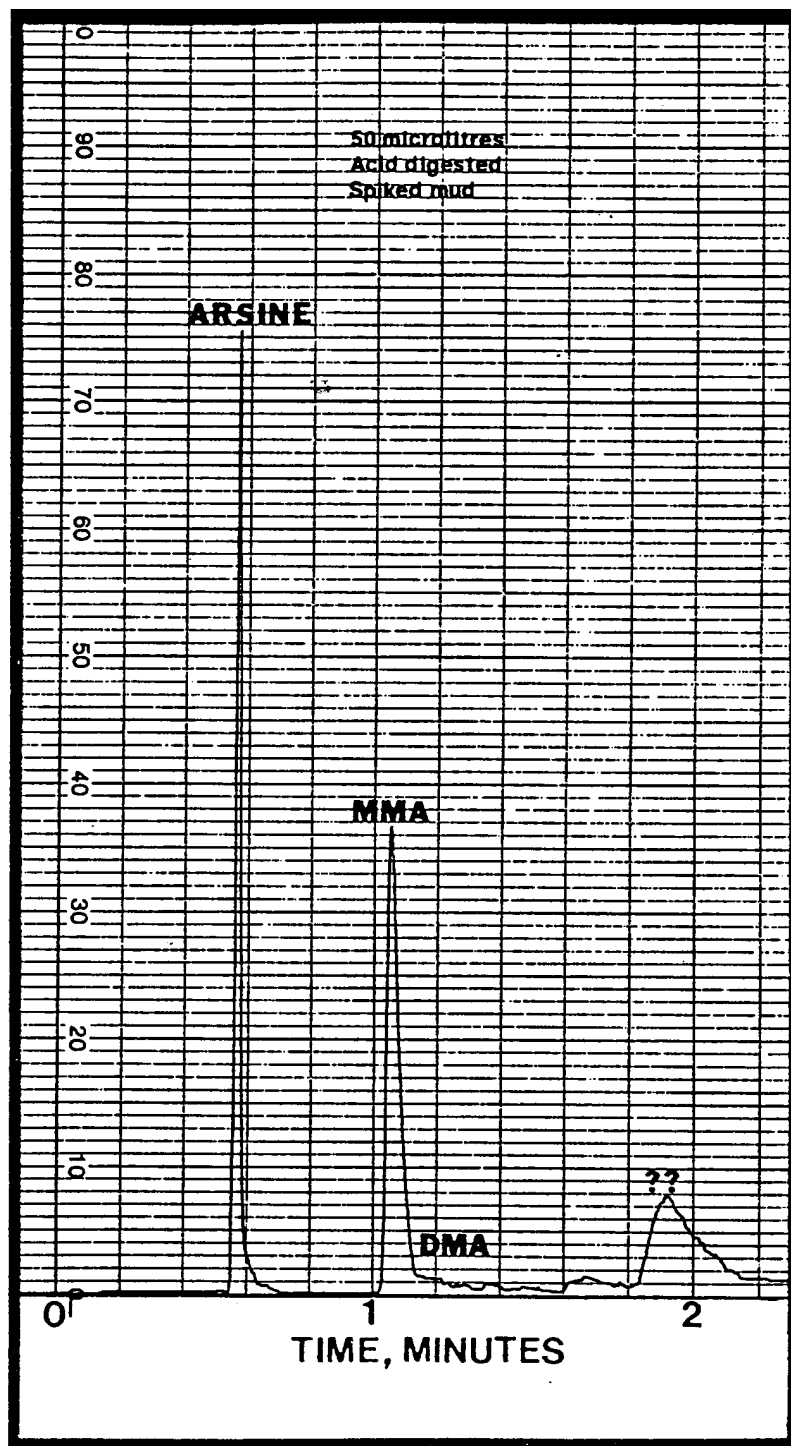

Figure 2-5. Chromatogram of digested ($\text{HNO}_3/\text{H}_2\text{SO}_4$) spiked Lake Washington mud. Vertical axis absorbance, horizontal axis time. Note absence of DMA peak and presence of unidentified higher boiling compound.

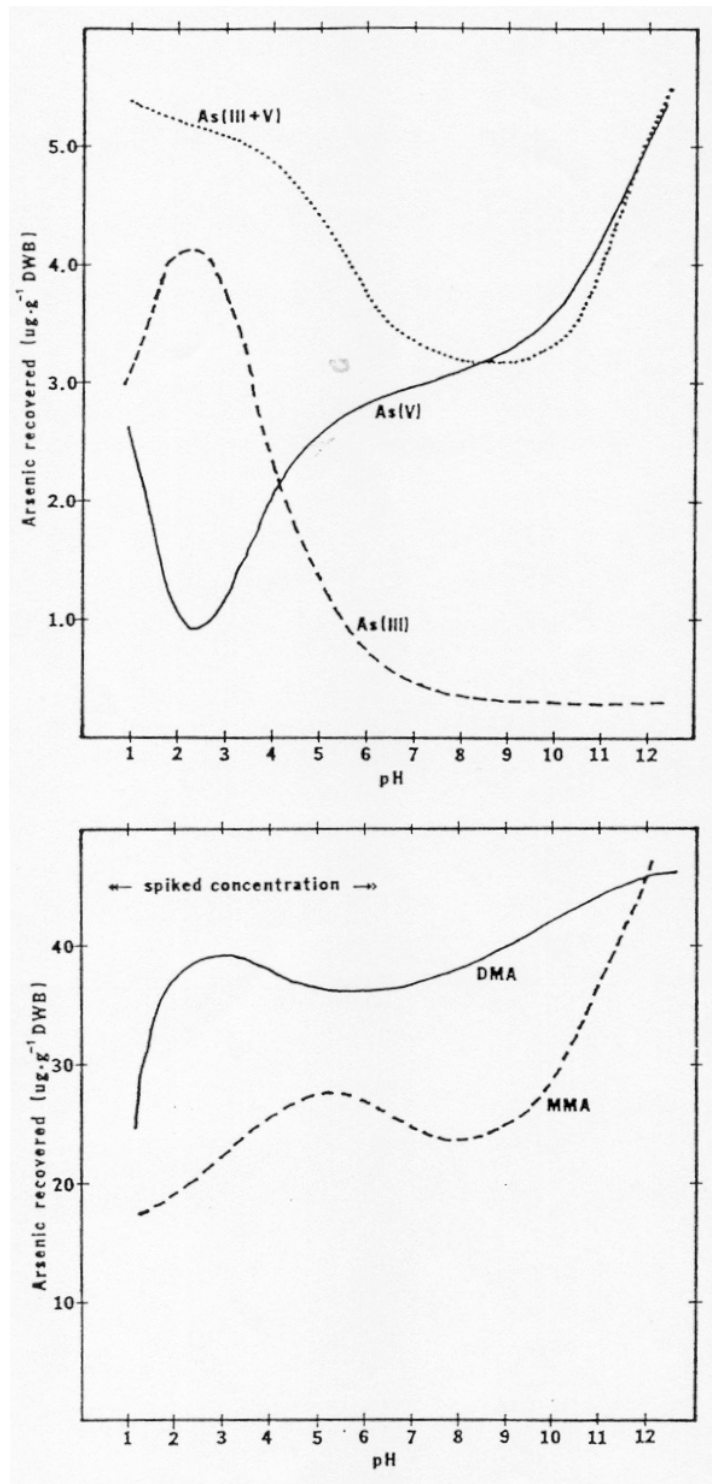

Figure 2-6. Arsenic species released from sediments as a function of solution pH. Plot of arsenic in sediment leached, µg g⁻¹ dry weight basis (DWB), versus pH of leachate.

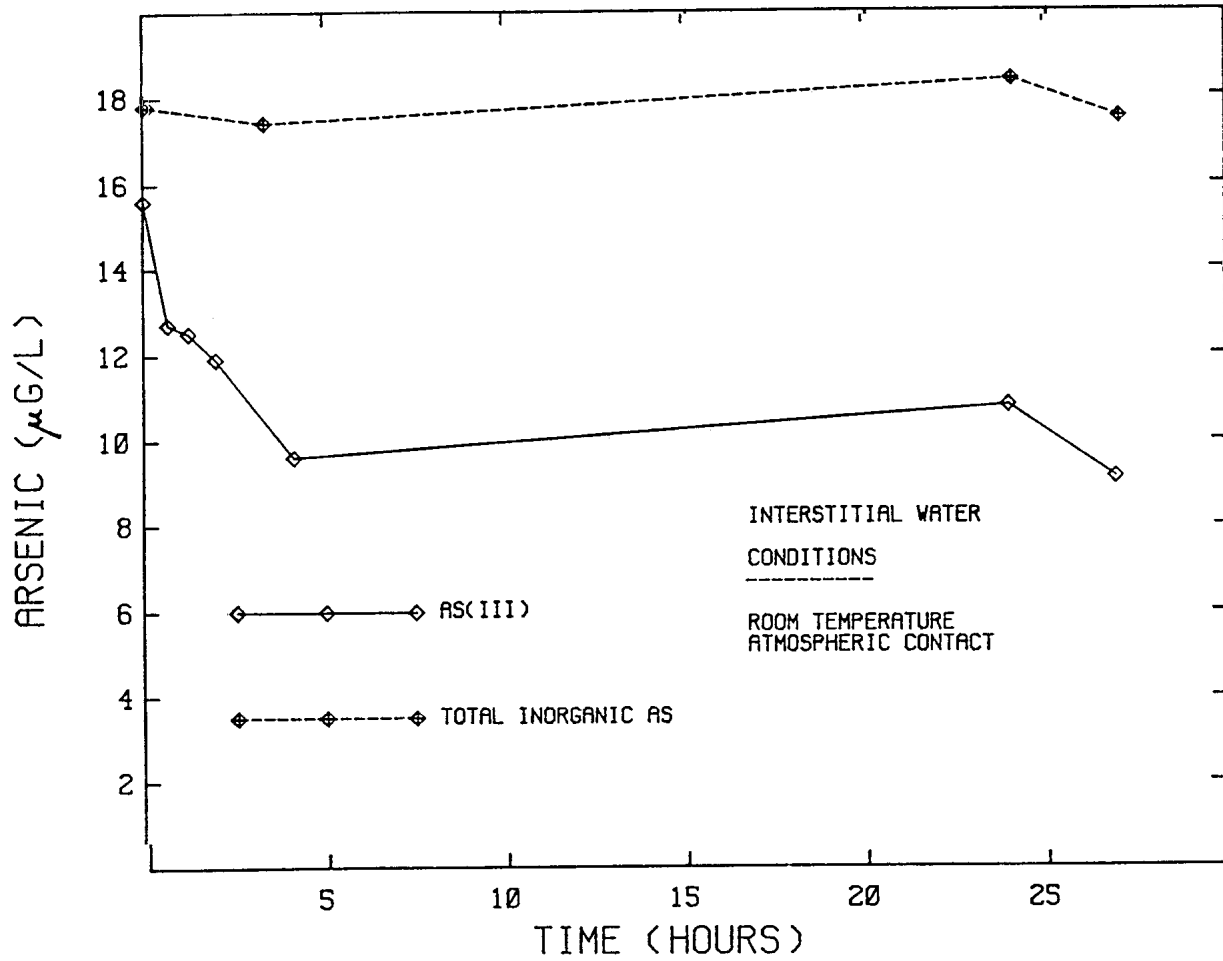

Figure 2-7. Plot of the concentration of As(III) and total inorganic arsenic versus storage time in interstitial water.

Table 2-1

Optimal Flows and Pressures for Gases
 in the Hydride Generation System

Gas	Flow rate ml • min ⁻¹	Pressure lb • in ⁻²
He	150	10
H ₂	350	20
Air	180	20

Table 2-2

Reduction Products and Their Boiling Points
 of Various Aqueous Arsenic Species

Aqueous form	Reduction product	B.P., °C
As(III), arsenous acid, HAsO ₂	AsH ₃	-55
As(V), arsenic acid, H ₃ AsO ₄	AsH ₃	-55
MMA, CH ₃ AsO(OH) ₂	CH ₃ AsH ₂	2
DMA, (CH ₃) ₂ AsO(OH)	(CH ₃) ₂ AsH	35.6

Table 2-3

Replicate Determinations of Total Inorganic Arsenic in Some Standard Waters

Replicate	Total (inorganic) arsenic, $\mu\text{g}\cdot\text{l}^{-1}$	
	NASS-1 Seawater	NBS River water
1	1.579	81.5
2	1.556	74.5
3	1.591	71.8
4	1.493	79.0
5	1.529	79.3
N	5	5
\bar{X}	1.550	77.2
S	0.040	4.0
RSD	2.6%	5.2%
Certified	1.65	76.0
\pm	0.19	7.0

\bar{M} = number of replicates.
 \bar{X} = mean
 S = + one standard deviation
 RSD = relative standard deviation

Table 2-4

Precision Data for Three Arsenic Species, Illustrating The Decrease in Precision with Increasing Boiling Point of Species. These Samples Were Spiked River Water Used in Water Storage Tests

Replicate	Arsenic concentrations, $\text{ng}\cdot\text{l}^{-1}$		
	Inorganic arsenic	MMA	DMA
N (8-24-83)	3	3	3
\bar{X}	937	2483	2173
S	44	79	181
RSD	4.7%	3.2%	8.3%
N (9-11-83)	3	4	4
\bar{X}	800	2342	2393
S	24	165	260
RSD	3.0%	7.0%	10.9%

Table 2-5

Total Inorganic Arsenic in Standard Sediments by HNO₃/H₂SO₄

Replicate	Total (inorganic) arsenic $\mu\text{g}\cdot\text{g}^{-1}$ dry weight basis			
	MESS-1 Estuarine sediment	BCSS-1 Estuarine sediment	NBS-1646 Estuarine sediment	NBS-1648 Air particulate matter
1	8.9	10.9	9.8	123.0
2	8.8	8.5	10.0	136.0
3	8.8	9.4	9.8	115.0
4	9.6	9.8	8.5	-
5	10.1	10.7	11.0	-
N	5	5	5	3
X	9.2	9.9	9.8	125.0
S	0.6	1.0	0.9	11.0
RSD	6.5%	10.1%	9.2%	8.8%
Certified	10.6	11.1	11.6	115.0
\pm	1.2	1.4	1.3	10.0

Table 2-6

Comparison of X-ray Fluorescence Spectroscopy and Hydride Generation Aa in the Determination of Total Arsenic Environmental Sediments. All Represent Total Inorganic Arsenic by Hot Acid Digestion Except (*) Slwm, Which Is the Sum of Species by Leaching

Types of Sediment	Total arsenic, $\mu\text{g}\cdot\text{g}^{-1}$ dry weight basis			
	XRF		Hydride AA	
Lake Washington (silt)	14.6 + 0.1	n=3	14.5 + 1.1	n=6
Spiked Lake Washington (silt)	124.1 + 3.4	n=3	120.0 + 7.5	n=5*
BCSS-1, clean estuarine (mud)	11.7 + 0.7	n=3	9.9 + 1.0	n=5
Contaminated Puget Sound (sandy)	108.0 + 24.0	n=3	93.0 + 21.0	n=3
Duwamish River (sand)	8.0	n=1	2.6	n=1

Table 2-7

Recovery of Arsenic Species from Spiked Lake Washington Mud by Selective Leaching

Arsenic species	$\mu\text{g}\cdot\text{g}^{-1}$ Arsenic, dry weight basis			
	Lake Washington mud	Spike added	Total recovered	Percent recovery
As(III)	2.2 + 0.3	5.8	8.2 + 14	103%
As(V)	4.4 + 0.3	9.5	13.5 + 17	96%
MMA	<0.8	58.0	51.3 + 6.0	88%
DMA	<0.8	54.0	47.0 + 4.2	87%

Table 2-8

Thirty-day Storage Results for Arsenic Speciation in Sediments

Lake Washington mud

Arsenic species	$\mu\text{g} \cdot \text{g}^{-1}$ Arsenic, dry weight basis		
	Initial concentration	Concentrations after 30-day aging	
		Refrigerated, 0-4°C	Frozen, -18°C
As(III)	2.2 + 0.3	2.2 + 0.4	2.3 + 0.3
As(V)	4.4 + 0.3	5.2 + 0.4	5.4 + 0.4
MMA	<0.8	<0.8	<0.8
DMA	<0.8	<0.8	<0.8

Spiked Lake Washington mud

Arsenic species	$\mu\text{g} \cdot \text{g}^{-1}$ Arsenic, dry weight basis		
	Initial concentration	Concentrations after 30-day aging	
		Refrigerated, 0-4°C	Frozen, -18°C
As(III)	8.2 ± 1.4	7.1 ± 2.7	9.9 ± 1.3
As(V)	13.5 ± 1.7	13.8 ± 1.0	16.0 ± 0.5
MMA	51.3 ± 6.0	39.9 ± 1.6	46.2 ± 3.5
DMA	47.0 ± 4.2	46.5 ± 3.2	40.0 ± 2.4

Table 2-9

Arsenic Speciation of Spiked Lake Washington Mud
 Interstitial Water K_d Values Represent [As (Dry Weight Sediment)]/[As (Interstitial Water)]

Species	Arsenic concentration $\mu\text{g} \cdot \text{g}^{-1}$		
	Dry sediment	Interstitial water	K_d
As(V)	20	<0.002	>10,000
As(III)	5.2	0.014	371
MMA	40	0.11	364
DMA	38	1.72	23

Table 2-10

Arsenic Speciation Intercomparison Exercise

Sample	$\mu\text{g } \ell^{-1}$							
	AS (III)		As (V)		MMA		DMW	
	BNW	Andreae	BNW	Andreae	BNW	Andreae	BNW	Andreae
DRW	0.061 ± 0.004	0.067	0.042 ± 0.008	0.023	<0.01	0.002	<0.01	0.067
SDRW	0.061 ± 0.005	0.066	0.468 ± 0.028	0.421	1.96 ± 0.11	1.67	1.92 ± 0.13	1.82
FA	0.052 ± 0.006	0.031	12.9 ± 0.2	12.0	<0.01	ND	<0.01	ND

Intercomparison exercise results with Meinrat 0. Andreae for arsenic speciation in limnological samples. DRW is filtered Dungeness River water; SDRW is Dungeness River water spiked with nominally $0.45 \mu\text{g} \cdot \ell^{-1}$ As (V), and $2 \mu\text{g} \cdot \ell^{-1}$ each DMA and MMA. FA is the filtrate of 1000 mg Q-1 NBS coal fly ash leached with DRW. BNW results are the mean of (3) determinations. ND means not detected. \pm = one standard deviation.

Table 2-11

Precision of Arsenic Speciation HYCO Reservoir
(February 1984)

Replicate	Sediment As, Sta. 5 $\mu\text{g g}^{-1}$ dry wt			Interstitial As, Sta. 5 $\mu\text{g L}^{-1}$			Water column, Sta. 4 $\mu\text{g L}^{-1}$		
	Total	AS (V)	AS (III)	Total	As (V)	AS (III)	Total	As (V)	As (III)
1	38.33	25.15	13.18	75.8	41.1	34.7	1.222	1.128	0.094
2	36.61	21.74	14.87	67.1	29.9	37.2	1.082	0.983	0.099
3	25.27	15.24	10.03	77.2	32.0	45.2	1.186	1.079	0.107
4	21.28	12.75	8.53	--	--	--	--	--	--
5	29.49	17.26	12.23	--	--	--	--	--	--
6	28.71	16.97	11.74	--	--	--	--	--	--
N	6	6	6	3	3	3	3	3	3
X	29.95	18.19	11.76	73.4	34.4	39.0	1.163	1.063	0.100
S	6.53	4.51	2.26	5.5	6.0	5.5	0.073	0.074	0.007
RSD	21.8%	24.8%	19.2%	7.5%	17.4%	14.1%	6.3%	6.9%	6.6%

REFERENCES

1. Braman, R. S., L. L. Johnson, C. C. Foreback, J. M. Ammons and J. L. Bricker. "Separation and determination of nanogram amounts of inorganic arsenic and methylarsenic compounds." *Analytical Chemistry* 49 (4):621-625 (1977).
2. Andreae, M. O. "Determination of arsenic species in natural waters." *Analytical Chemistry* 49:820, May 1977.
3. Andreae, M. O. "Methods of Seawater Analysis." Arsenic (by hydride generation/AAS), pp. 168-173 Verlag Chemie, Florida, (1983).
4. Maher, W. A. "Determination of inorganic and methylated arsenic species in marine organisms and sediments." *Analytica Chimica Acta* 126:157-165 (1981).

APPENDIX I

QUALITY ASSURANCE AND QUALITY CONTROL GUIDANCE

APPENDIX I

QUALITY ASSURANCE(QA) AND QUALITY CONTROL (QC) GUIDANCE

I.1 GENERAL QA AND QC CONSIDERATIONS

The primary objective of the specific QA and QC guidance provided in this document is to ensure that

- Appropriate data quality objectives or requirements are established **prior** to sample collection and analysis.
- Samples are collected, processed, and analyzed according to scientifically valid, cost-effective, standardized procedures.
- The integrity and security of samples and data are maintained at all times.
- Recordkeeping and documentation procedures are adequate to ensure the traceability of all samples and data from initial sample collection through final reporting and archiving and to ensure the verifiability and defensibility of reported results.
- Data quality is assessed, documented, and reported properly.
- Reported results are complete, accurate, and comparable with those from other similar monitoring programs.

I.2 QA PLAN REQUIREMENTS

To ensure the quality, defensibility, and comparability of the data used to determine exposure assessments and fish consumption advisories, it is essential that an effective QA program be developed as part of the overall design for each monitoring program. The specific QA activities should be documented in a written QA Project Plan (QAPP) or in a combined Work/QA Plan and should be implemented strictly throughout all phases of the monitoring program.

The QAPP should follow the guidelines and requirements specified in *EPA Guidance for Quality Assurance Project Plans* (EPA QA/G-5) and *EPA Requirements for Quality Assurance Project Plans for Environmental Data* (EPA

QA/R-5), where applicable. To obtain the type and quality of environmental data needed for decision making or a specified end use, the QAPP needs to provide a project-specific strategy for applying QA and quality control (QC) procedures.

The QAPP should be composed of standardized, recognizable elements that cover the entire project. These elements should be organized under four general categories that correspond to the planning, implementation, assessment, and validation phases of the project. Although project-specific tailoring of the EPA guidance for developing QA plans is encouraged, all required information must be included either in full or by reference to appropriate standard operating procedures (SOPs). The following summarizes the pertinent elements of a QAPP for each phase of the project.

1. Project Management

- a. A historical and scientific perspective of the project including a description of the problem to be solved or the decision to be made
- b. A clear statement of the project goals and the approach to be used and an overview of the work to be performed and the schedule of implementation
- c. A description of the program organization and personnel roles and responsibilities, including responsibility for ensuring adherence to the QA plan
- d. Specification of data quality objectives in terms of accuracy, precision, representativeness, and completeness, for data generated from each type of measurement system
- e. Identification of special training for project personnel
- f. A description of the procedure for obtaining approval for substantive changes in the monitoring program
- g. Detailed description of health and safety procedures

2. Measurement and Data Acquisition

- a. Detailed descriptions of field sample collection and handling procedures, including documentation of
 - Target species and size (age) class
 - Sampling site locations
 - Target contaminants
 - Sampling times/schedules

-
- Numbers of samples and sample replication strategy
 - Sample collection procedures
 - Sample processing procedures, including sample identification, labeling, preservation, and storage conditions
 - Sample shipping procedures
- b. A detailed description of chain-of-custody procedures, including specification of standard chain-of-custody forms and clear assignment of field and laboratory personnel responsibilities for sample custody
- c. Detailed descriptions of laboratory procedures for sample receipt, storage, and preparation, including specification of the kinds of samples to be prepared for analyses (e.g., composite vs. individual, whole body vs. fillet, replicates)
- d. Detailed descriptions of the analytical methods used for quantitation of target contaminants and percent lipid determination
- e. Detailed descriptions of methods routinely used to assess data accuracy, precision, and completeness, including
- Internal QC checks using field, reagent, or method blanks; spiked samples; split samples; QC samples prepared from standard reference materials; and replicate analyses
 - Calibration checks
 - Data quality assessments
- f. Detailed descriptions of preventive maintenance procedures for sampling and analysis equipment
- g. Detailed descriptions of calibration procedures for all measurement instruments, including specification of reference materials used for calibration standards and calibration schedules
- h. Detailed descriptions of recordkeeping and documentation procedures, including requirements for
- Maintaining field and laboratory logs and notebooks
 - Use of standard data collection and reporting forms
 - Making changes to original records
 - Number of significant figures to be recorded for each type of data
 - Units of reporting
 - Routine procedures to assess the accuracy and completeness of records

3. Assessment and Oversight
 - a. Detailed descriptions of data management and reporting procedures, including requirements for
 - Technical reports
 - QA and QC reports
 - Data coding procedures
 - Database specifications
 - QA review of reported data
 - Data storage and archiving procedures
 - b. Detailed descriptions of procedures for internal QC performance and/or systems audits for sampling and analysis programs
 - c. Detailed descriptions of procedures for external QA performance and/or systems audits for sampling and analysis programs, including participation in certified QA proficiency testing or interlaboratory comparison programs
 - d. Detailed descriptions of corrective action procedures in both sampling and analysis programs, including
 - Criteria and responsibility for determining the need for corrective action
 - Procedures for ensuring that effective corrective action has been taken
 - Procedures for documenting and reporting corrective actions
4. Data Validation and Usability
 - a. Provide the criteria to be used in reviewing and validating the data and for deciding the degree to which each data item has met its quality specification
 - b. Describe the process to be used for validating and verifying data, including the chain of custody for data throughout the project
 - c. Include detailed descriptions of data analysis procedures, including
 - Statistical treatment of data
 - Data summary formats (e.g., plots, tables)
 - d. Precisely define and interpret how validation issues differ from verification issues

Guidance for addressing each of the QA or QC elements outlined above, including a list of recommended standard reference materials and external QA or interlaboratory comparison programs for the analyses of target analytes, is incorporated in the appropriate sections of this guidance document. The EPA guidance and requirements documents (EPA QA/G-5 and EPA QA.R-5) should be referenced for more detailed discussions of the elements to be included in the QA plan (available at http://es.epa.gov/ncercqa/qaqa_docs.html).

APPENDIX J

RECOMMENDED PROCEDURES FOR PREPARING WHOLE FISH COMPOSITE HOMOGENATE SAMPLES

APPENDIX J

RECOMMENDED PROCEDURES FOR PREPARING WHOLE FISH COMPOSITE HOMOGENATE SAMPLES

J.1 GENERAL GUIDELINES

Laboratory processing to prepare whole fish composite samples (diagrammed in Figure J-1) involves

- Inspecting individual fish for foreign material on the surface and rinsing if necessary
- Weighing individual fish
- Examining each fish for morphological abnormalities (optional)
- Removing scales or otoliths for age determination (optional)
- Determining the sex of each fish (optional)
- Preparing individual whole fish homogenates
- Preparing a composite whole fish homogenate.

Whole fish should be shipped on wet or blue ice from the field to the sample processing laboratory if next-day delivery is assured. Fish samples arriving in this manner (chilled but not frozen) should be weighed, scales and/or otoliths removed, and the sex of each fish determined within 48 hours of sample collection. The grinding/homogenization procedure may be carried out more easily and efficiently if the sample has been frozen previously (Stober, 1991). Therefore, the samples should then be frozen (≤ -20 °C) in the laboratory prior to being homogenized.

If the fish samples arrive frozen (i.e., on dry ice) at the sample processing laboratory, precautions should be taken during weighing, removal of scales and/or otoliths, and sex determination to ensure that any liquid formed in thawing remains with the sample. **Note:** The liquid will contain target analyte contaminants and lipid material that should be included in the sample for analysis.

The thawed or partially thawed whole fish should then be homogenized individually, and equal weights of each homogenate should be combined to form the composite sample. Individual homogenates and/or composite homogenates may be frozen; however, frozen individual homogenates must be rehomogenized before compositing, and frozen composite homogenates must be rehomogenized before aliquotting for analysis. The maximum holding time from sample collection to analysis for mercury is 28 days at ≤ -20 °C; for all other analytes, the holding time is 1 year at ≤ -20 °C (Stober, 1991). Recommended container materials,

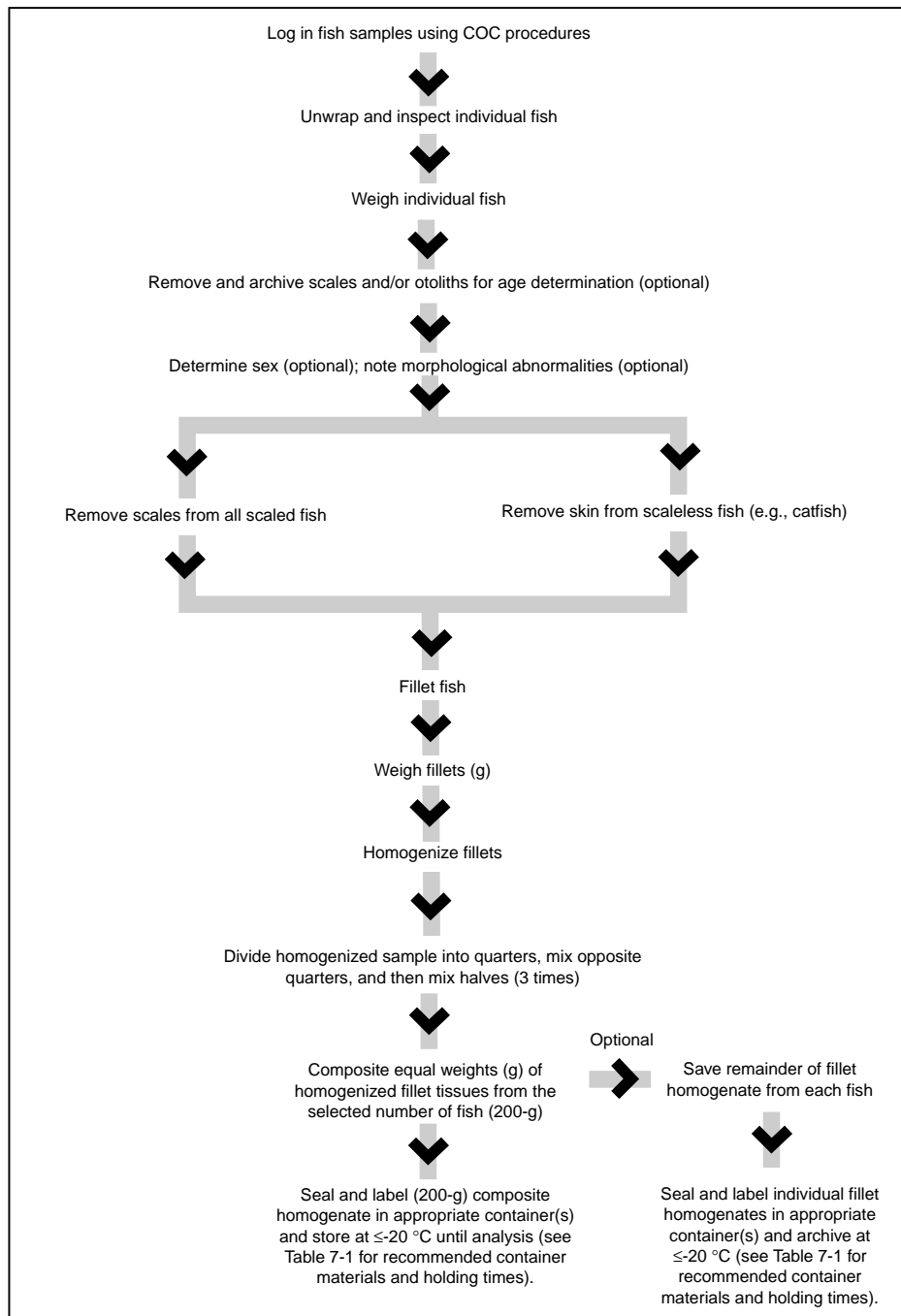

COC = Chain of custody.

Figure J-1. Laboratory sample preparation and handling for whole fish composite homogenate samples.

preservation temperatures, and holding times are given in Table J-1. **Note:** Holding times in Table J-1 are maximum times recommended for holding samples from the time they are received at the laboratory until they are analyzed. These holding times are based on guidance that is sometimes administrative rather than technical in nature; there are no promulgated holding time criteria for tissues (U.S. EPA, 1995b). If states choose to use longer holding times, they must demonstrate and document the stability of the target analyte residues over the extended holding times.

J.2 SAMPLE PROCESSING PROCEDURES

Fish sample processing procedures are discussed in more detail in the sections below. Each time custody of a sample or set of samples is transferred from one person to another during processing, the Personal Custody Record of the chain-of-custody (COC) form that originated in the field (Figure 6-8) must be completed and signed by both parties so that possession and location of the samples can be traced at all times (see Section 7.1). As each sample processing procedure is performed, it should be documented directly in a bound laboratory notebook or on standard forms that can be taped or pasted into the notebook. The use of a standard form is recommended to ensure consistency and completeness of the record. Several existing programs have developed forms similar to the sample processing record for whole fish composite samples shown in Figure J-2.

J.2.1 Sample Inspection

Individual fish received for filleting should be unwrapped and inspected carefully to ensure that they have not been compromised in any way (i.e., not properly preserved during shipment). Any specimen deemed unsuitable for further processing and analysis should be discarded and identified on the sample processing record.

J.2.2 Sample Weighing

A wet weight should be determined for each fish. All samples should be weighed on balances that are properly calibrated and of adequate accuracy and precision to meet program data quality objectives. Balance calibration should be checked at the beginning and end of each weighing session and after every 20 weighings in a weighing session.

Fish shipped on wet or blue ice should be weighed directly on a foil-lined balance tray. To prevent cross contamination between individual fish, the foil lining should be replaced after each weighing. Frozen fish (i.e., those shipped on dry ice) should be weighed in clean, tared, noncontaminating containers if they will thaw before the weighing can be completed. Liquid from the thawed sample must be

Table J-1. Recommendations for Container Materials, Preservation, and Holding Times for Fish, Shellfish, and Turtle Tissues from Receipt at Sample Processing Laboratory to Analysis

Analyte	Matrix	Sample container	Storage	
			Preservation	Holding time ^a
Mercury	Tissue (whole specimens, homogenates)	Plastic, borosilicate glass, quartz, and PTFE	Freeze at ≤ -20 °C	28 days ^b
Other metals	Tissue (whole specimens, homogenates)	Plastic, borosilicate glass, quartz, and PTFE	Freeze at ≤ -20 °C	6 months ^c
Organics	Tissue (whole specimens, homogenates)	Borosilicate glass, quartz, PTFE, and aluminum foil	Freeze at ≤ -20 °C	1 year ^d
Metals and organics	Tissue (whole specimens, homogenates)	Borosilicate glass, quartz, and PTFE	Freeze at ≤ -20 °C	28 days (mercury); 6 months (for other metals); and 1 year (for organics)
Lipids	Tissue (whole specimens, homogenates)	Plastic, borosilicate glass, quartz, PTFE	Freeze at ≤ -20 °C	1 year

PTFE = Polytetrafluoroethylene for Teflon.

^a Maximum holding times recommended by U.S. EPA (1995b).

^b This maximum holding time is also recommended by the Puget Sound Estuary Program (1990). The California Department of Fish and Game (1990) and the USGS National Water Quality Assessment Program (Crawford and Luoma, 1993) recommend a maximum holding time of 6 months for all metals, including mercury.

^c This maximum holding time is also recommended by the California Department of Fish and Game (1990), the 301(h) monitoring program (U.S. EPA, 1986), and the USGS National Water Quality Assessment Program (Crawford and Luoma, 1993). The Puget Sound Estuary Program (1990) recommends a maximum holding time of 2 years.

^d This maximum holding time is also recommended by the Puget Sound Estuary Program (1990). The California Department of Fish and Game (1990) and the USGS National Water Quality Assessment Program (Crawford and Luoma, 1993) recommend a more conservative maximum holding time of 6 months. EPA (1995a) recommends a maximum holding time of 1 year at ≤ -10 °C for dioxins and dibenzofurans.

Sample Processing Record for Fish Contaminant Monitoring Program — Whole Fish Composites

Project No. _____ Sampling Date and Time: _____

STUDY PHASE: Screening ; Intensive: Phase I Phase II

SITE LOCATION

Site Name/Number: _____

County/Parish: _____ Lat./Long.: _____

State Waterbody Segment Number: _____ Waterbody Type: _____

Bottom Feeder – Species Name: _____

Composite Sample #: _____ Number of Individuals: _____

Fish #	Weight (g)	Scales/Otoliths Removed (✓)	Sex (M, F)	Homogenate Prepared (✓)	Weight of homogenate taken for composite (g)
001	_____	_____	_____	_____	_____
002	_____	_____	_____	_____	_____
003	_____	_____	_____	_____	_____
004	_____	_____	_____	_____	_____
005	_____	_____	_____	_____	_____
006	_____	_____	_____	_____	_____
007	_____	_____	_____	_____	_____
008	_____	_____	_____	_____	_____
009	_____	_____	_____	_____	_____
010	_____	_____	_____	_____	_____
Analyst Initials/Date	_____/_____	_____/_____	_____/_____	_____/_____	_____/_____
Total Composite Homogenate Weight					_____

Predator – Species Name: _____

Composite Sample #: _____ Number of Individuals: _____

Fish #	Weight (g)	Scales/Otoliths Removed (✓)	Sex (M, F)	Homogenate Prepared (✓)	Weight of homogenate taken for composite (g)
001	_____	_____	_____	_____	_____
002	_____	_____	_____	_____	_____
003	_____	_____	_____	_____	_____
004	_____	_____	_____	_____	_____
005	_____	_____	_____	_____	_____
006	_____	_____	_____	_____	_____
007	_____	_____	_____	_____	_____
008	_____	_____	_____	_____	_____
009	_____	_____	_____	_____	_____
010	_____	_____	_____	_____	_____
Analyst Initials/Date	_____/_____	_____/_____	_____/_____	_____/_____	_____/_____
Total Composite Homogenate Weight					_____

Notes: _____

Figure J-2. Example of a sample processing record for fish contaminant monitoring program—whole fish composites.

kept in the container as part of the sample because it will contain lipid material that has separated from the tissue (Stober, 1991).

All weights should be recorded to the nearest gram on the sample processing record and/or in the laboratory notebook.

J.2.3 Age Determination

Age provides a good indication of the duration of exposure to pollutants (Versar, 1982). A few scales or otoliths (Jearld, 1983) should be removed from each fish and delivered to a fisheries biologist for age determination. For most warm water inland gamefish, 5 to 10 scales should be removed from below the lateral line and behind the pectoral fin. On soft-rayed fish such as trout and salmon, the scales should be taken just above the lateral line (WDNR, 1988). For catfish and other scaleless fish, the pectoral fin spines should be clipped and saved (Versar, 1982). The scales, spines, or otoliths may be stored by sealing them in small envelopes (such as coin envelopes) or plastic bags labeled with, and cross-referenced by, the identification number assigned to the tissue specimen (Versar, 1982). Removal of scales, spines, or otoliths from each fish should be noted (by a check mark) on the sample processing record.

J.2.4 Sex Determination (Optional)

To determine the sex of a fish, an incision should be made on the ventral surface of the body from a point immediately anterior to the anus toward the head to a point immediately posterior to the pelvic fins. If necessary, a second incision should be made on the left side of the fish from the initial point of the first incision toward the dorsal fin. The resulting flap should be folded back to observe the gonads. Ovaries appear whitish to greenish to golden brown and have a granular texture. Testes appear creamy white and have a smooth texture (Texas Water Commission, 1990). The sex of each fish should be recorded on the sample processing record.

J.2.5 Assessment of Morphological Abnormalities (Optional)

Assessment of gross morphological abnormalities in finfish is optional. This assessment may be conducted in the field (see Section 6.3.1.5) or during initial inspection at the central processing laboratory prior to filleting. States interested in documenting morphological abnormalities should consult Sinderman (1983) and review recommended protocols for fish pathology studies used in the Puget Sound Estuary Program (1990).

J.2.6 Preparation of Individual Homogenates

To ensure even distribution of contaminants throughout tissue samples, whole fish must be ground and homogenized prior to analyses.

Smaller whole fish may be ground in a hand crank meat grinder (fish < 300 g) or a food processor (fish 300-1,000 g). Larger (>1,000 g) fish may be cut into 2.5-cm cubes with a food service band saw and then ground in either a small or large homogenizer. To avoid contamination by metals, grinders and homogenizers used to grind and blend tissue should have tantalum or titanium blades and/or probes. Stainless steel blades and probes have been found to be a potential source of nickel and chromium contamination (due to abrasion at high speeds) and should be avoided.

Grinding and homogenization of biological tissue, especially skin from whole fish samples, is easier when the tissue is partially frozen (Stober, 1991). Chilling the grinder/homogenizer briefly with a few chips of dry ice will reduce the tendency of the tissue to stick to the grinder.

The ground sample should be divided into quarters, opposite quarters mixed together by hand, and the two halves mixed back together. The grinding, quartering, and hand mixing should be repeated two more times. If chunks of tissue are present at this point, the grinding/homogenizing should be repeated. No chunks of tissue should remain because these may not be extracted or digested efficiently. If the sample is to be analyzed for metals only, the ground tissue may be mixed by hand in a polyethylene bag (Stober, 1991). Homogenization of each individual fish should be noted on the sample processing record. At this time, individual whole fish homogenates may be either composited or frozen and stored at ≤ -20 °C in cleaned containers that are noncontaminating for the analyses to be performed (see Table J-1).

J.2.7 Preparation of Composite Homogenates

Composite homogenates should be prepared from equal weights of individual homogenates. If individual whole fish homogenates have been frozen, they should be thawed partially and rehomogenized prior to compositing. Any associated liquid should be maintained as a part of the sample. The weight of each individual homogenate that is used in the composite homogenate should be recorded, to the nearest gram, on the sample processing record.

Each composite homogenate should be blended by dividing it into quarters, mixing opposite quarters together by hand, and mixing the two halves together. The quartering and mixing should be repeated at least two more times. If the sample is to be analyzed only for metals, the composite homogenate may be mixed by hand in a polyethylene bag (Stober, 1991). At this time, the composite homogenate may be processed for analysis or frozen and stored at ≤ -20 °C (see Table J-1).

The remainder of each individual homogenate should be archived at ≤ -20 °C with the designation "Archive" and the expiration date recorded on the sample label. The location of the archived samples should be indicated on the sample processing record under "Notes."

It is essential that the weights of individual homogenates yield a composite homogenate of adequate size to perform all necessary analyses. Weights of individual homogenates required for a composite homogenate, based on the number of fish per composite and the weight of composite homogenate recommended for analyses of all screening study target analytes (see Table 4-1), are given in Table J-2. The total composite weight required for intensive studies may be less than in screening studies if the number of target analytes is reduced significantly.

The recommended sample size of 200 g for screening studies is intended to provide sufficient sample material to (1) analyze for all recommended target analytes (see Table 4-1) at appropriate detection limits, (2) meet minimum QA and QC requirements for the analyses of replicate, matrix spike, and duplicate matrix spike samples (see Section 8.3.3.4), and (3) allow for reanalysis if the QA and QC control limits are not met or if the sample is lost. However, sample size requirements may vary among laboratories and the analytical methods used. Therefore, it is the responsibility of each program manager to consult with the analytical laboratory supervisor to determine the actual weights of composite homogenates required to analyze for all selected target analytes at appropriate detection limits.

J.3 REFERENCES

- California Department of Fish and Game. 1990. *Laboratory Quality Assurance Program Plan*. Environmental Services Division, Sacramento, CA.
- Crawford, J.K., and S.N. Luoma. 1993. *Guidelines for Studies of Contaminants in Biological Tissues for the National Water-Quality Assessment Program*. USGS Open-File Report 92-494. U.S. Geological Survey, Lemoyne, PA.
- Jearld, A. 1983. Age determination. pp. 301-324. In: *Fisheries Techniques*. L.A. Nielsen and D. Johnson (eds.). American Fisheries Society, Bethesda, MD.
- Puget Sound Estuary Program. 1990 (revised). Recommended protocols for fish pathology studies in Puget Sound. Prepared by PTI Environmental Services, Bellevue, WA. In: *Recommended Protocols and Guidelines for Measuring Selected Environmental Variables in Puget Sound*. Region 10, U.S. Environmental Protection Agency, Seattle, WA. (Looseleaf)
- Sinderman, C. J. 1983. An examination of some relationships between pollution and disease. *Rapp. P. V. Reun. Cons. Int. Explor. Mer.* 182:37-43.
- Stober, Q. J. 1991. *Guidelines for Fish Sampling and Tissue Preparation for Bioaccumulative Contaminants*. Environmental Services Division, Region 4, U.S. Environmental Protection Agency, Athens, GA.

- Texas Water Commission. 1990. *Texas Tissue Sampling Guidelines*. Texas Water Commission, Austin, TX.
- U.S. EPA (U.S. Environmental Protection Agency). 1986. *Bioaccumulation Monitoring Guidance: 4. Analytical Methods for U.S. EPA Priority Pollutants and 301(h) Pesticides in Tissues from Marine and Estuarine Organisms*. EPA-503/6-90-002. Office of Marine and Estuarine Protection, Washington, DC.
- U.S. EPA (U.S. Environmental Protection Agency). 1995a. *Method 1613b. Tetra- through Octa-Chlorinated Dioxins and Furans by Isotope Dilution HRGC/HRMS*. Final Draft. Office of Water, Office of Science and Technology, Washington, DC.
- U.S. EPA (Environmental Protection Agency). 1995b. *QA/QC Guidance for Sampling and Analysis of Sediments, Water, and Tissues for Dredged Material Evaluations—Chemical Evaluations*. EPA 823-B-95-001. Office of Water, Washington, DC, and Department of the Army, U.S. Army Corps of Engineers, Washington, DC.
- Versar, Inc. 1982. *Sampling Protocols for Collecting Surface Water, Bed Sediment, Bivalves and Fish for Priority Pollutant Analysis--Final Draft Report*. EPA Contract 68-01-6195. Prepared for U.S. EPA Office of Water Regulations and Standards. Versar, Inc., Springfield, VA.
- WDNR (Wisconsin Department of Natural Resources). 1988. *Fish Contaminant Monitoring Program—Field and Laboratory Guidelines (1005.1)*. Madison, WI.

APPENDIX K

GENERAL PROCEDURES FOR REMOVING EDIBLE TISSUES FROM FRESHWATER TURTLES

APPENDIX K

GENERAL PROCEDURES FOR REMOVING EDIBLE TISSUES FROM FRESHWATER TURTLES

1. Turtles brought to the processing laboratory on wet, blue, or dry ice should be placed in a freezer for a minimum of 48 hours prior to resection. Profound hypothermia can be employed to induce death (Frye, 1994) Decapitation of alert animals is not recommended because there is evidence that decapitation does not produce instantaneous loss of consciousness (Frye, 1994).
2. The turtle should be placed on its back with the plastron (ventral plate) facing upward. The carapace and plastron are joined by a bony bridge on each side of the body extending between the fore and hindlimbs (Figure K-1). Using a bone shears, pliers, or sharp knife, break away the two sides of the carapace from the plastron between the fore and hind legs on each side of the body.
3. Remove the plastron to view the interior of the body cavity. At this point, muscle tissue from the forelimbs, hindlimbs, tail (posterior to the anus), and neck can be resected from the body. The muscle tissue should be skinned and the bones should be removed prior to homogenization of the muscle tissue. Typically, the muscle tissue is the primary tissue consumed, and turtle meat sold in local markets usually contains lean meat and bones only (Liner, 1978).

Dietary and culinary habits concerning which turtle tissues are edible, however, differ greatly among various populations. In some populations, the liver, heart, eggs, fatty deposits, and skin are also used (Liner, 1978). Therefore only general information on the types of turtle tissues most frequently considered edible can be presented here. State staff familiar with the dietary and culinary habits of the turtle-consuming populations within their jurisdictions are the best judge of which edible tissues should be included as part of the tissue samples used to assess the health risks to the turtle-consuming public.

4. Several of the tissue types that are considered edible include the fatty deposits found in various parts of the body, the heart, liver (usually with the gall bladder removed), and the eggs (if the specimen is a female). These edible tissues are shown in Figure K-2.

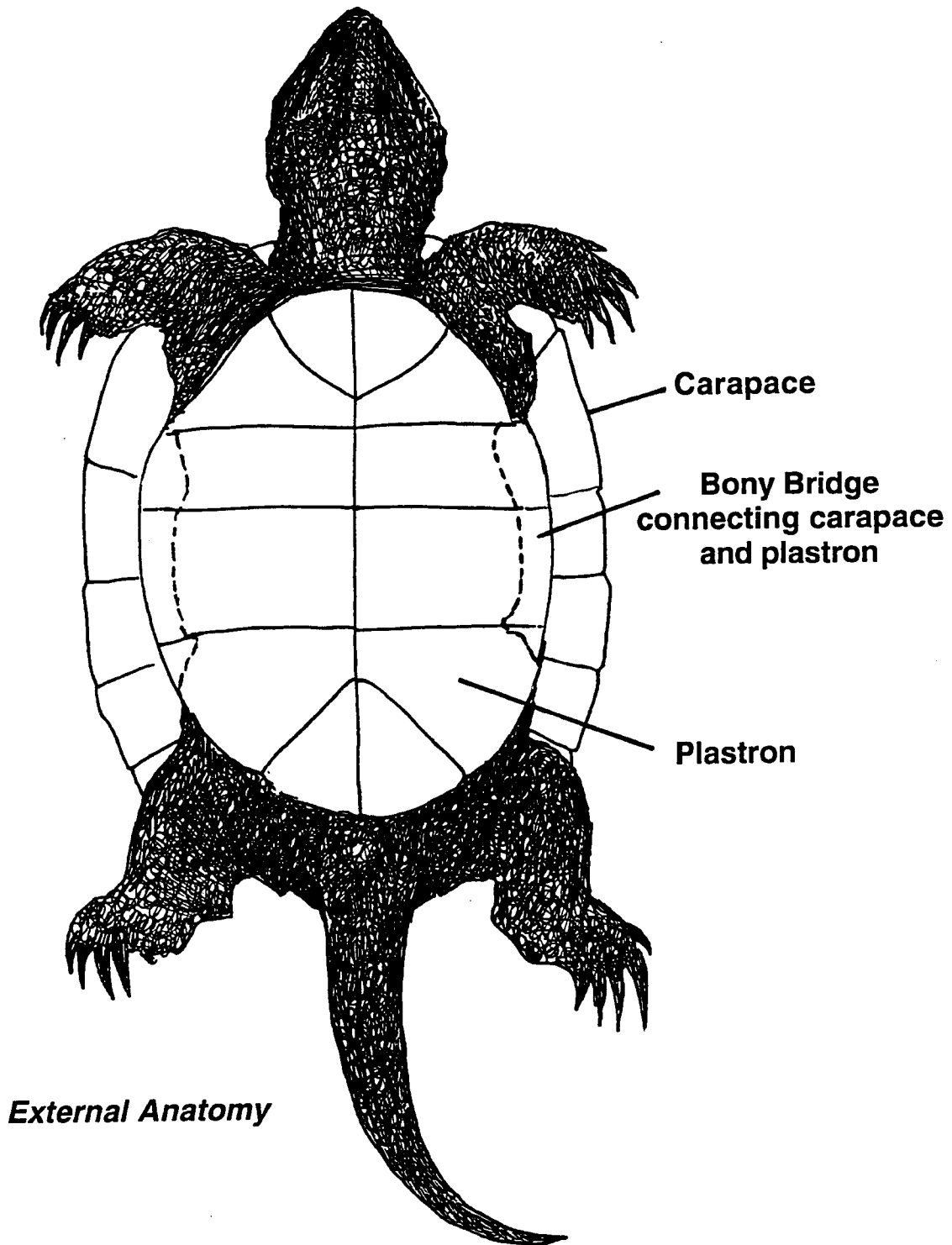

Source: Ashley, 1962.

Figure K-1.

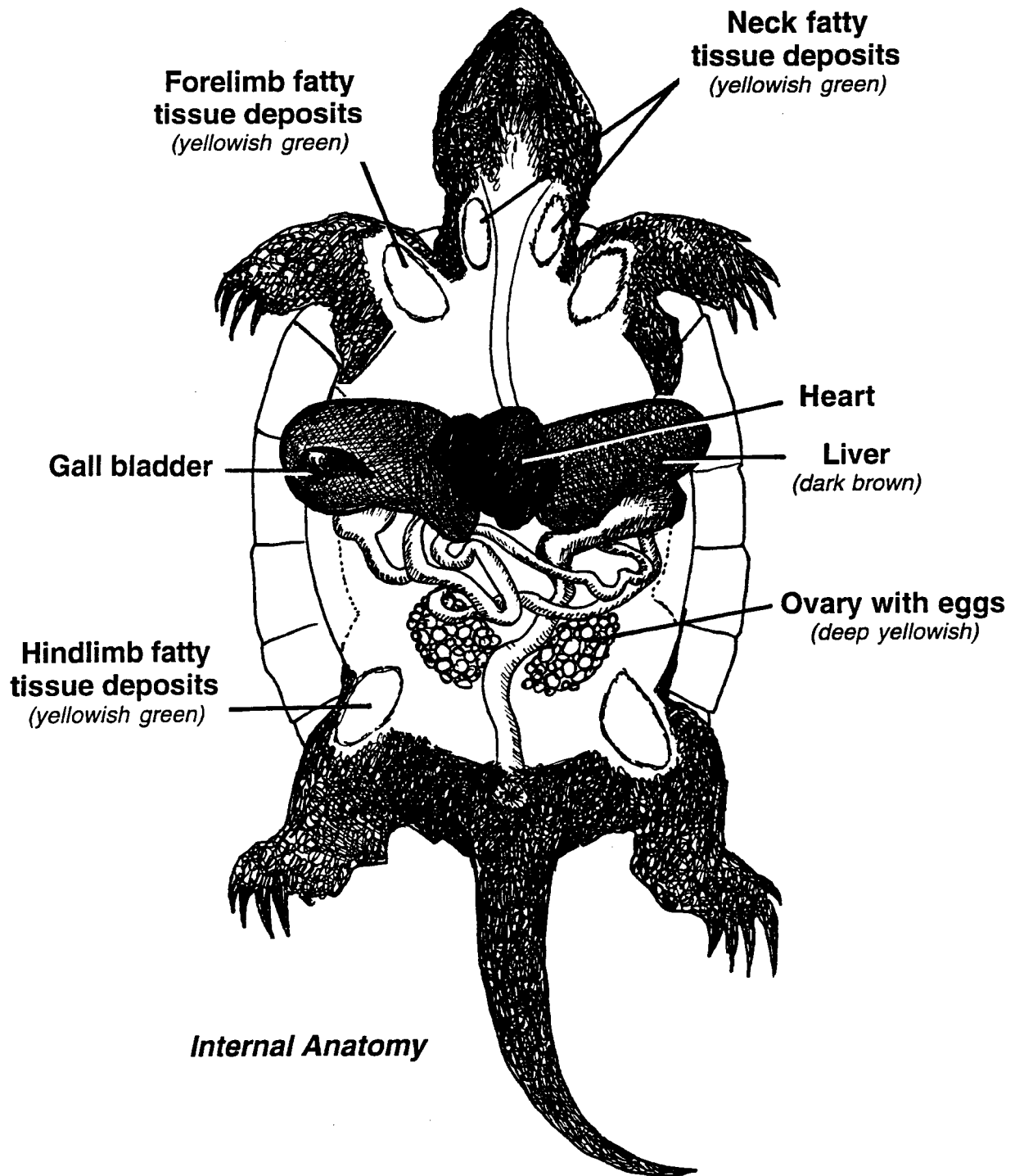

Source: Ashley, 1962.

Figure K-2.

- Masses of yellowish-green fatty deposits may be removed from above the forelimbs and from above and in front of the hindlimbs. Fatty deposits can also be found at the base of the neck near the point where the neck enters the body cavity.
- The centrally located heart is positioned anterior to the liver.
- The large brownish liver is the predominant tissue in the body cavity and is an edible tissue eaten by some populations. Note: The small greenish-colored gall bladder lies on the dorsal side of the right lobe of the liver (not visible unless the liver is lifted upward and turned over). The gall bladder is usually removed and discarded by consumers because of its acrid taste (Liner, 1978).
- If the turtle specimen is a female, ovaries containing bright yellow-colored spherical eggs of varying sizes are located posterior to the liver and lie against the dorsal body wall.

Note: The fatty deposits, liver tissue, and eggs are highly lipophilic tissues and have been shown to accumulate chemical contaminants at concentrations 10 to more than 100 times the concentrations reported from muscle tissue (Bryan et al., 1987; Hebert et al., 1993; Olafsson et al., 1983, 1987; Ryan et al., 1986; Stone et al., 1980). States may wish to resect the fatty tissues, liver, heart, and eggs for inclusion in the turtle muscle tissue sample to obtain a conservative estimate of the concentration to which the turtle-consuming public would be exposed. Alternatively, states may want to retain these tissues for individual analysis. Some states already advise their residents who consume turtles to remove all fatty tissues (Minnesota Department of Health, 1994; New York State Department of Health, 1994) and not to consume the liver and eggs (New York State Department of Health, 1994). These cleaning procedures are recommended as a risk-reducing strategy.

REFERENCES

- Ashley, L.M. 1962. *Laboratory Anatomy of the Turtle*. W.C. Brown Company Publishers, Dubuque, IA.
- Bryan, A.M., P.G. Olafsson, and W.B. Stone. 1987. Disposition of low and high environmental concentrations of PCBs in snapping turtle tissues. *Bull. Environ. Contam. Toxicol.* 38:1000-1005.
- Frye, F.L. 1994. *Reptile Clinician's Handbook: A Compact Clinical and Surgical Reference*. Krieger Publishing Company, Malabar, FL.

- Hebert, C.E., V. Glooschenko, G.D. Haffner, and R. Lazar. 1993. Organic contaminants in snapping turtle (*Chelydra serpentina*) populations from Southern Ontario, Canada. *Arch. Environ. Contam. Toxicol.* 24:35-43.
- Liner, E.A. 1978. *A Herpetological Cookbook: How to Cook Amphibians and Reptiles*. Privately printed, Houma, LA.
- Minnesota Department of Health. 1994. *Minnesota Fish Consumption Advisory*. Minneapolis, MN.
- New York State Department of Health. 1994. *Health Advisory-Chemicals in Sportfish and Game 1994-1995*. #40820042. Division of Environmental Health Assessment, Albany, NY.
- Olafsson, P.G., A.M. Bryan, B. Bush, and W. Stone. 1983. Snapping turtles—A biological screen for PCBs. *Chemosphere* 12 (11/12):1525-1532.
- Olafsson, P.G., A.M. Bryan, and W. Stone. 1987. PCB congener specific analysis: A critical evaluation of toxic levels in biota. *Chemosphere* 16 (10-12):2585-2593.
- Ryan, J.J., P.Y. Lau, and J.A. Hardy. 1986. 2,3,7,8, Tetrachlorodibenzo-p-dioxin and related dioxans and furans in snapping turtle (*Chelydra serpentina*) tissues from the upper St. Lawrence River. *Chemosphere* 15 (5):537-548.
- Stone, W.B., E. Kiviat, and S.A. Butkas. 1980. Toxicants in snapping turtles. *New York Fish and Game Journal* 27 (1):39-50.

APPENDIX L

GENERAL PROCEDURES FOR REMOVING EDIBLE TISSUES FROM SHELLFISH

Source: UNC Sea Grant Publication. 1988. UNC-SG-88.02. The Water Resources Institute, North Carolina State University, Raleigh, NC

Heading, peeling and deveining shrimp

1

To head a shrimp, hold it in one hand. With your thumb behind shrimp head, push head off. Be sure to push just the head off so that you do not lose any meat.

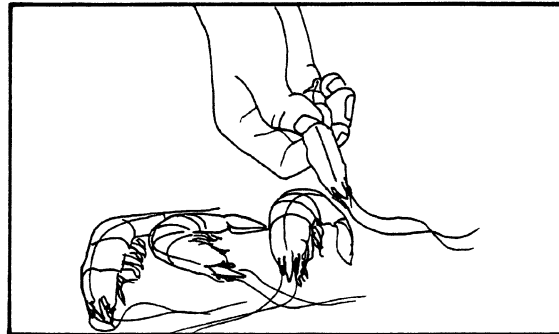

2

If using a deveiner, insert it at head end, just above the vein.

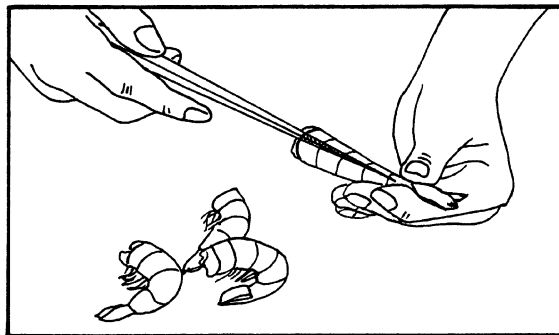

3

Push through shrimp to the tail and split and remove shell. This removes vein at the same time.

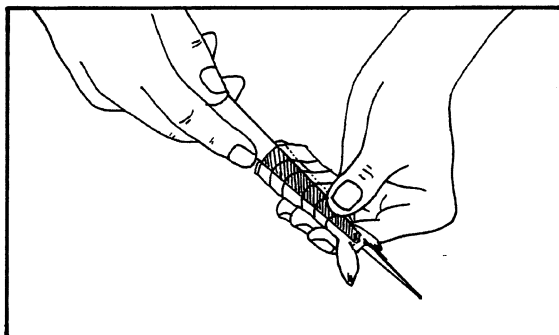

4

If you prefer to use a paring knife, shell shrimp with your fingers or knife. Then use knife to gently remove vein.

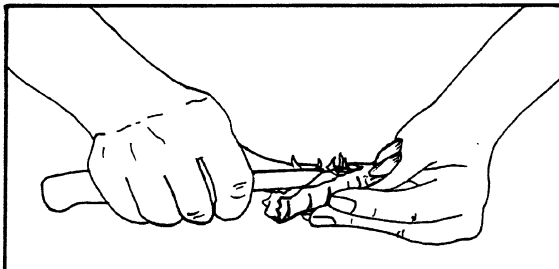

Source: UNC Sea Grant. 1988. Publication UNC-SG-88-02. The Water Resources Research Institute, North Carolina State University, Raleigh, NC.

1

Hold crab in one hand and cut across body just behind eyes to remove eyes and mouth.

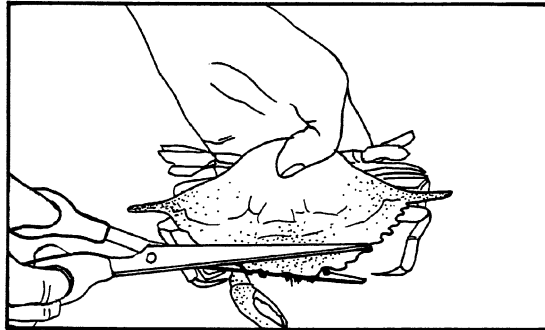
**2**

Turn crab on its back. Lift and remove apron and vein attached to it.

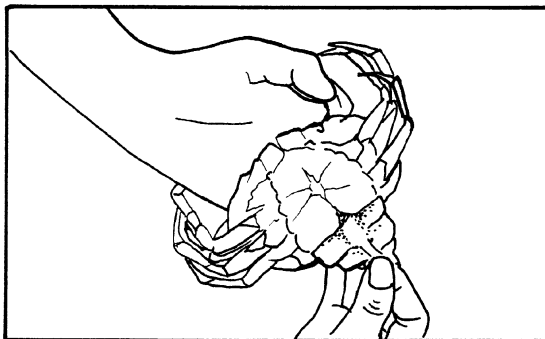
**3**

Turn crab over and lift one side of top shell.

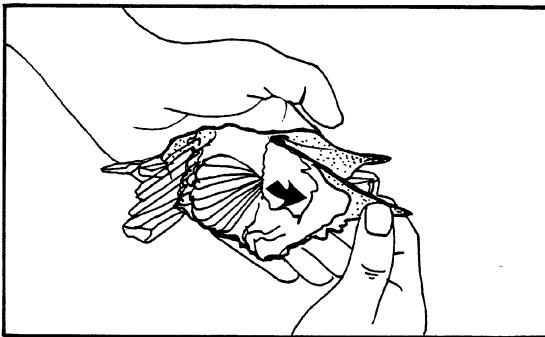
**4**

With a small knife, scrape off grayish-feathery gills. Repeat procedure on other side.

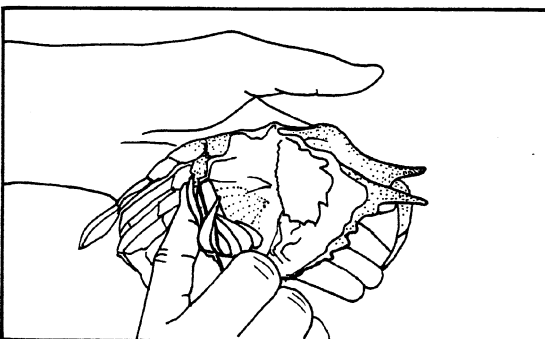

1

Hold crab in one hand. Turn crab over and stab straight down at point of apron with a knife.

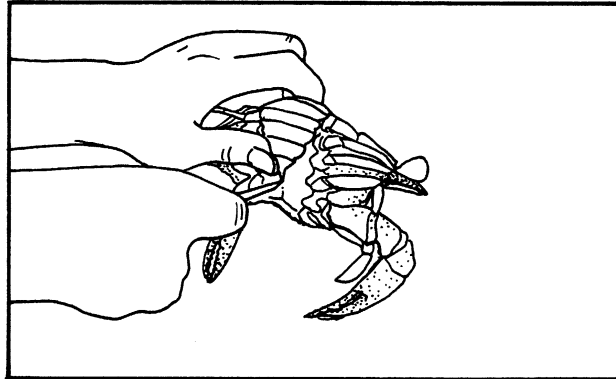

2

Make two cuts from this point to form a V-pattern that will remove mouth.

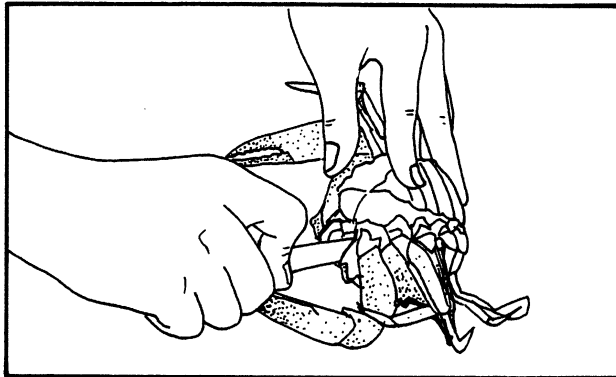

3

Do not remove knife after making second cut. Firmly press crab shell to cutting surface without breaking back shell. With other hand, grasp crab by legs and claws on the side where you are holding knife, and pull up. This should pull crab body free from back shell.

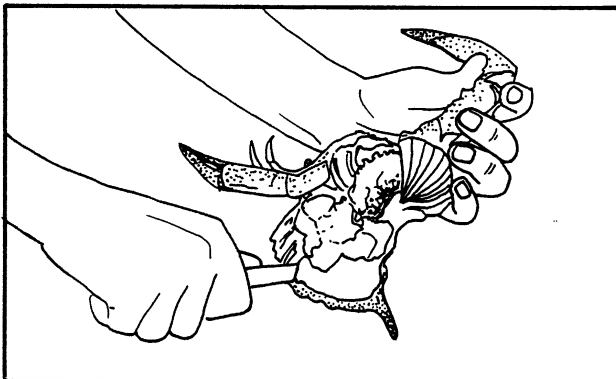

4

Remove gray, feathery gills, which are attached just above legs. Cut and scrape upward to remove gills.

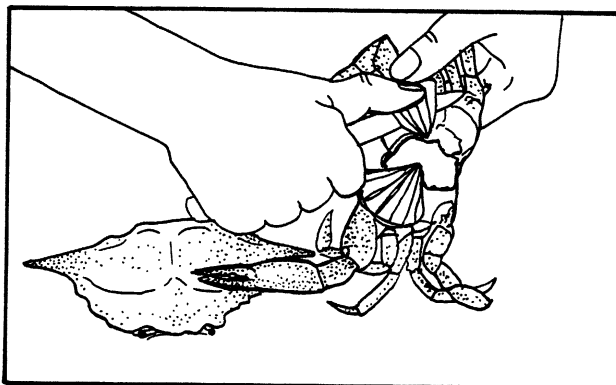

5

Remove all loose material—viscera and eggs—from body cavity.

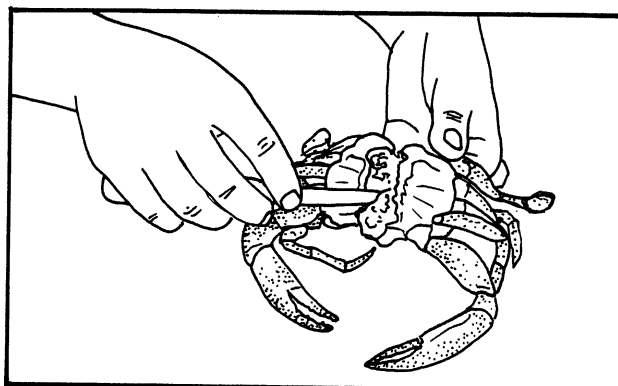

6

If apron did not come loose with shell, remove it.

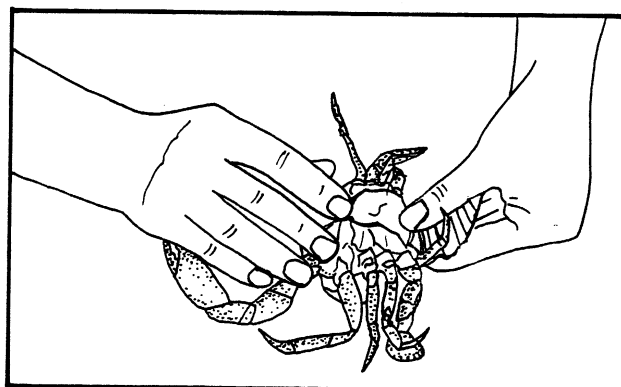

1

Oyster shells are especially sharp; be sure to wear gloves to protect your hands. Chip off a small piece of shell from the thin lip of the oyster until there is a small opening.

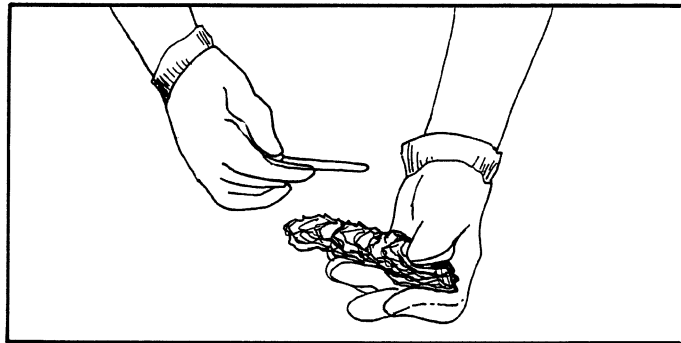
**2**

Insert knife blade into the opening and cut muscle free from top and bottom shells.

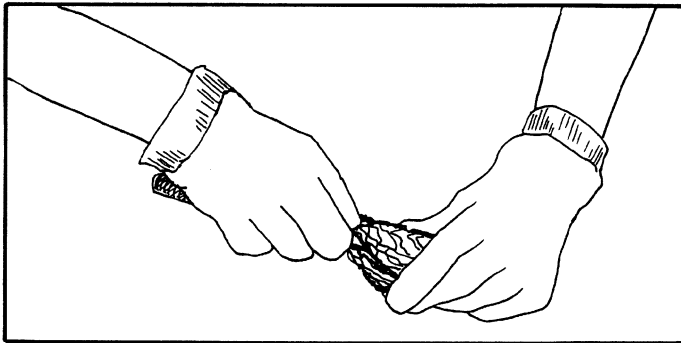
**3**

Remove oyster meat from the shell.

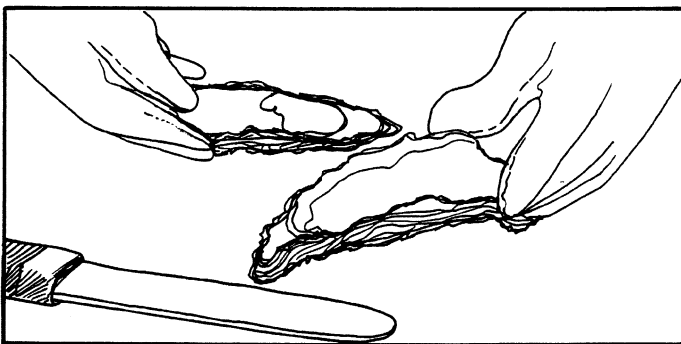

1

In the back of clam near the hinge is a black ligament. Toward the front where ligament ends is a weak spot. Insert your knife at this spot.

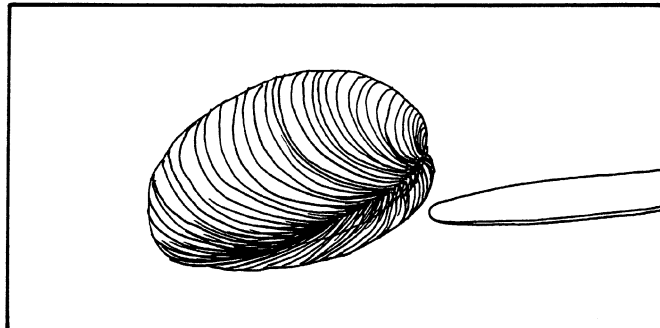
**2**

Inside are two muscles. Run the knife around the shell to sever both muscles.

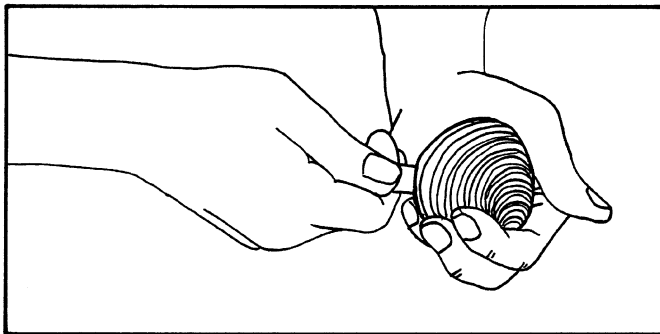
**3**

Now insert the knife blade into the front of the shell and separate the two shells.

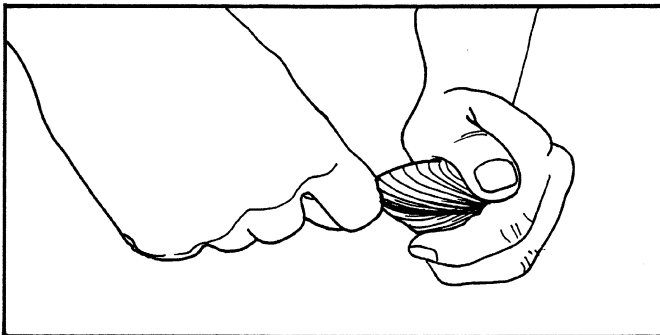
**4**

Scrape the meat free from the top and bottom shell.

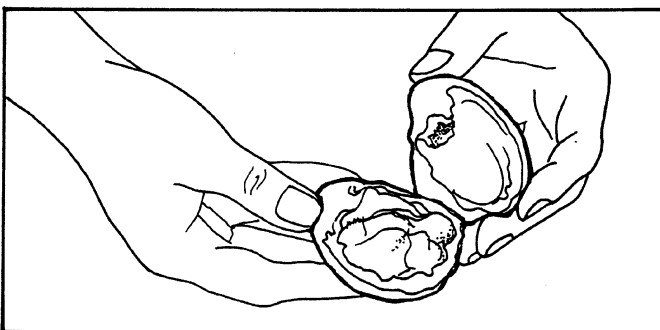

APPENDIX M

SOURCES OF REFERENCE MATERIALS AND STANDARDS

APPENDIX M

SOURCES OF REFERENCE MATERIALS AND STANDARDS

M.1 SOURCES OF REFERENCE MATERIALS

Analytical reference materials for priority pollutants and related compounds are currently produced for: organic quality control samples; organic solution standards; organic neat standards; inorganic quality control standards; and solid matrix quality control standards as listed below.

Note: Mention of trade names or commercial products does not constitute endorsement or recommendation for use. Identification of retailers of these products does not constitute their endorsement.

M.2 RETAILERS OF ORGANIC QUALITY CONTROL SAMPLES

Accustandard
125 Market Street
New Haven, CT 06513
Tel: 203-786-5290
FAX: 203-786-5287
Contact: Mike Bolgar

Aldrich Chemical Company, Inc.
940 West Saint Paul Avenue
Milwaukee, WI 53233
Tel: 414-273-3850
FAX: 800-962-9591

Analytical Products Group
2730 Washington Boulevard
Belpre, OH 45714
Tel: 704-423-4200
FAX: 704-423-5588
1-800-272-4442
Contact: Tom Coyner/
Melissa McNamara

Crescent Chemical Corporation
1324 Motor Parkway
Hauppauge, NY 11788
Tel: 516-348-0333

FAX: 516-348-0913
Contact: Fran Seiss

Environmental Research Associates
5540 Marshall Street
Arvada, CO 80002
Tel: 303-431-8454
FAX: 303-421-0159
Contact: Mark Carter

NSI Environmental Solutions, Inc.
P. O. Box 12313
2 Triangle Drive
Research Triangle Park, NC 27709
Tel: 1-800-234-7837 or
1-919-549-8980
FAX: 1-919-544-0334

Restek Corporation
110 Benner Circle
Bellefonte, PA 16823
Tel: 814-353-1300
FAX: 814-353-1309
Contact: Eric Steindle

Supelco
Supelco Park
Bellefonte, PA 16823-0048
Tel: 800-247-6628 or
814-359-3441
FAX: 814-359-3044

Ultra Scientific
250 Smith Street
North Kingstown, RI 02852
Tel: 401-294-9400
FAX: 401-295-2330

M.3 RETAILERS OF ORGANIC SOLUTION STANDARDS

Absolute Standards, Inc.
P.O. Box 5585
Hamden, NJ 06518-0585
Tel: 800-368-1131
FAX: 800-410-2577
Contact: Jack Criscio

NSI Environmental Solutions, Inc.
P.O. Box 12313
2 Triangle Drive
Research Triangle Park, NC 27709
Tel: 800-234-7837 or 919-549-8980
FAX: 919-544-0334
Contact: Zora Bunn

Accustandard
125 Market St.
New Haven, CT 06513
Tel: 203-786-5290
FAX: 203-786-5287
Contact: Mike Bolgar

Research Technology Corporation
2931 Soldier Springs Road
P. O. Box 1346
Laramie, WY 82070
Tel: 307-742-6343
FAX: 307-745-7936
Contact: Robert Rucinski

Alameda Chemical and Scientific
922 East Southern Pacific Drive
Phoenix, AZ 85034
Tel: 602-256-7044
FAX: 602-256-6566
Contact: Jim Stauffer

Cambridge Isotope Laboratories
50 Frontage Road
Andover, MA 01801-5413
Tel: 800-322-1174 or
978-749-8000
FAX: 978-749-2768
Contact: Jim Grim

M.4 RETAILERS OF NEAT ORGANIC STANDARDS

Accustandard
125 Market St.
New Haven, CT 06513
Tel: 203-786-5290
FAX: 203-786-5287
Contact: Mike Bolgar

NSI Environmental Solutions, Inc.
P. O. Box 12313
2 Triangle Drive
Research Triangle Park, NC 27709
Tel: 1-800-234-7837 or
1-919-549-8980
FAX: 1-919-544-0334

M.5 RETAILERS OF INORGANIC QUALITY CONTROL SAMPLES

SPEX Industries, Inc.
203 Norcross Ave.
Metuchen, NJ 08840
Tel: 732-549-7144 or
1-800-522-7739
FAX: 732-603-9647

NSI Environmental Solutions, Inc.
P. O. Box 12313
2 Triangle Drive
Research Triangle Park, NC 27709
Tel: 1-800-234-7837 or
1-919-549-8980
FAX: 1-919-544-0334

M.6 RETAILERS OF SOLID MATRIX QUALITY CONTROL SAMPLES

Fisher Scientific
711 Forbes Avenue (Corporate
address)
Pittsburgh, PA 15219
Tel: 1-800-227-6701
FAX: 1-800-926-1166

NSI Environmental Solutions, Inc.
P. O. Box 12313
2 Triangle Drive
Research Triangle Park, NC 27709
Tel: 1-800-234-7837 or
1-919-549-8980
FAX: 1-919-544-0334

M.7 RECOMMENDED PUBLICATIONS ON CERTIFIED STANDARDS AND REFERENCE MATERIALS

- **Standard and Reference Materials for Marine Science (NOAA, 1992). Available from**

Dr. Adrianna Cantillo
National Ocean Service
National Oceanic and Atmospheric Administration
U.S. Department of Commerce
1305 East West Highway
Silver Spring, MD 20910

This catalog lists approximately 2,000 reference materials from 16 producers and includes information on their use, sources, matrix type, analyte concentrations, proper use, availability, and costs. Reference materials are categorized as follows: ashes, gases, instrumental performance, oils, physical properties, rocks, sediments, sludges, tissues, and waters. This catalog has been published independently by both NOAA and IOC/UNEP and is available in electronic form from the Office of Ocean Resources, Conservation, and Assessment, NOAA/NOS.

- **Biological and Environmental Reference Materials for Trace Elements, Nuclides and Organic Microcontaminants (Toro et al., 1990). Available from**

Dr. R.M. Parr
Section of Nutritional and Health-Related Environmental Studies
International Atomic Energy Agency
P.O. Box 100
A-1400 Vienna, Austria

This report contains approximately 2,700 analyte values for 117 analytes in 116 biological and 77 nonbiological environmental reference materials from more than 20 sources. Additional information on cost, sample size available, and minimum amount of material recommended for analysis is also provided.

M.8 REFERENCES

- NOAA (National Oceanic and Atmospheric Administration). 1992. *Standard and Reference Materials for Marine Science*. Third Edition. U.S. Department of Commerce, Rockville, MD.
- Toro, E. C., R. M. Parr, and S. A. Clements. 1990. *Biological and Environmental Reference Materials for Trace Elements, Nuclides and Organic Microcontaminants: A Survey*. IAEA/RL/128(Rev. 1). International Atomic Energy Agency, Vienna, Austria.

APPENDIX N

STATISTICAL METHODS FOR COMPARING SAMPLES: SPATIAL AND TEMPORAL CONSIDERATIONS

APPENDIX N

STATISTICAL METHODS FOR COMPARING SAMPLES: SPATIAL AND TEMPORAL CONSIDERATIONS

The primary objective of Tier 2 intensive studies is to assess the magnitude and geographic extent of contamination in selected target species by determining whether the mean contaminant concentration exceeds the screening value (SV) for any target analyte. Secondary objectives of intensive studies may include defining the geographical region where fish contaminant concentrations exceed screening values (SVs), identifying geographic distribution of contaminant concentrations, and, in conjunction with historical or future data collection, assessing changes in fish contaminant concentrations over time. This appendix discusses some of the statistical methods that may be used to compare fish contaminant levels measured at different locations or over time.

The recommended statistical approach for comparing replicated contaminant measurements between two or more groups is outlined below and in Figure N-1. For each type of test, several options are provided, each of which may be appropriate in specific cases. State staff should consult a statistician as to the specific statistical tests to use for a particular data set.

Statistical tests of significant differences between means (or other measures of central tendency) can be divided into parametric and nonparametric types. Parametric tests assume that the contaminant concentrations in the population being sampled are normally distributed and that the population variances in the groups being tested are not significantly different from each other (Gilbert, 1987). If either of these assumptions is violated, a nonparametric test may be more appropriate. However, nonparametric tests should be used only when necessary because the power of parametric tests generally is greater than the power of nonparametric tests when the assumptions of the parametric test have been met (Sokal and Rohlf, 1981).

Because the populations of many environmental measurements are not normally distributed, logarithmic transformation is often performed on the sampled data (Gilbert, 1987). However, transformation may not be appropriate in all cases. If the data are sampled from a population that is normally distributed, then there is no need for transformation (Figure N-1).

If the assumptions of normality and equality of variance are met, parametric tests of significant differences between means, such as the one-way Analysis of

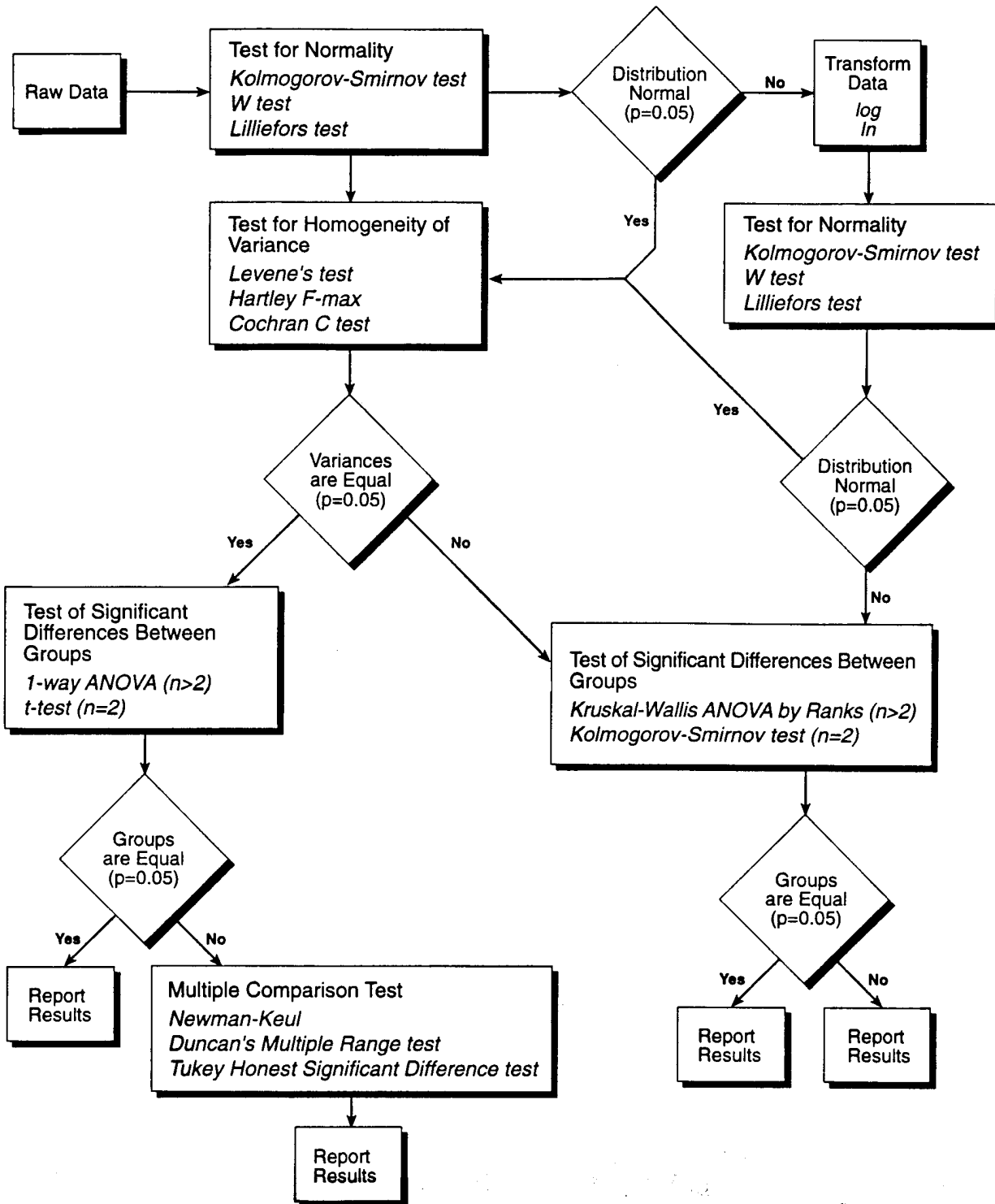

Figure N-1. Statistical approach to testing for significant differences between different groups of contaminant monitoring data.

Variance (ANOVA) and the *t*-test, should be performed. If three or more groups are compared using the ANOVA that results in a significant difference, the difference in mean concentrations between two group means can be further investigated using a multiple comparison test (Figure N-1). These tests indicate which specific means are significantly different from each other, rather than just indicating that one or more means are different, as the ANOVA does.

If the underlying assumptions for parametric testing are not met, nonparametric tests of significance can be employed. Nonparametric tests of significant differences in central tendencies are often performed on transformed data, that is, the ranks. Multiple comparison tests comparable to those used for parametric data sets are not available for nonparametric data sets. For data sets including three or more groups, a series of two-sample tests can be performed that can yield similar information to that derived from multiple comparison tests.

Because the concentrations of contaminants, particularly nonpolar organics, are often correlated with the percentage of lipid in a tissue sample (see Section 8.1.2), contaminant data are often normalized to the lipid concentration before statistical analyses are performed. This procedure can, in some instances, improve the power of the statistical tests. States wishing to examine the relationship between contaminant concentrations and percentage of lipid should refer to Hebert and Keenleyside (1995) for a discussion of the possible statistical approaches.

Intensive studies may include the collection of fish contaminant data from several locations within a region of interest or for multiple time periods (e.g., seasons or years) from a single location, or a combination of both. Data from intensive studies such as these may be used to perform spatial (i.e., between stations) or temporal (i.e., over time) analyses. It should be noted that these types of analyses, if performed, are performed in addition to the statistical comparisons of mean target analyte concentrations with SVs described in Section 6.1.2.7. It is only the latter type of comparison that should be used to make decisions regarding the necessity of performing risk assessments and the issuance of fish consumption advisories. Spatial and temporal comparisons of contaminant data, however, may yield important information about the variability of target analyte concentrations in specific populations of a particular target species.

N.1 SPATIAL COMPARISON OF STATIONS

Intensive studies also may involve the collection of contaminant data from multiple stations within a waterbody of interest. The stations could be located in different lakes within a single drainage basin, upstream and downstream of a point source of concern along a single river, or randomly located within a single waterbody if an estimate of random spatial variability is desired. The use of an example will serve to illustrate how a spatial analysis of contaminant data might be performed. In this example, a state has determined from a screening study on a river that cadmium is present in a target species at 20 ppm, which is two times the state selected SV of 10 ppm. An intensive survey was undertaken in which eight

Table N-1. Hypothetical Cadmium Concentrations (ppm) in Target Species A at Three River Locations

Replicate samples	Station 1	Station 2	Station 3
1	20	28	33
2	18	27	30
3	25	34	30
4	22	28	28
5	21	30	20
6	22	29	39
7	23	30	31
8	21	29	30
Mean	21.5	29.4	31.3
Standard deviation	2.07	2.13	3.45
p-Value for <i>t</i> -test with SV	<0.001	<0.001	<0.001
p-Value for W test	0.97	0.83	0.78
p-Value for Levene's test		0.52	
p-Value for ANOVA		<0.0001	
p-Value for Duncan's-1 vs. 2		<0.0001	
p-Value for Duncan's-1 vs. 3		>0.0001	
p-Value for Duncan's-2 vs. 3		0.17	

samples were collected from three locations on the river of potential concern and analyzed for cadmium. The results of the analyses for each location and the statistical comparisons between the three groups are presented in Table N-1.

The mean cadmium concentration at each of three locations was more than twice the selected SV of 10 ppm (Table N-1). The most important statistical test, as indicated in Section 6.1.2.7, is a comparison of the mean target analyte concentration for each location with the appropriate SV for that target analyte using a *t*-test. These tests must be performed before any analysis of spatial trends is performed. The results of the *t*-tests indicate that each of the three mean tissue concentrations is significantly greater than the SV (Table N-1). By itself, these results indicate that a risk assessment is warranted.

A general statistical flowchart for comparing contaminant concentration data from several stations is presented in Figure N-1. The cadmium data in Table N-1 may be additionally analyzed using the tests in Figure N-1. All of the statistical tests in Figure N-1 can be performed using commercial statistical software packages. By performing a spatial analysis of the data, the details of the risk assessment might be further refined. For example, one component of a fish advisory is often the establishment of risk-based consumption limits (see Volume 2 of this series). In order to calculate these limits, an estimate of the contaminant concentration in the target species must be available. In the example shown in Table N-1, there

are three estimates of cadmium concentration. A spatial analysis of these data can help to identify which of the concentrations (if any) to use in establishing risk-based consumption limits.

The initial steps in the flowchart on Figure N-1 are to determine whether parametric or nonparametric statistical tests should be used. The first step is to test whether each of the three groups of data are from populations that are normally distributed. Three tests that may be used for this purpose are the Kolmogorov-Smirnov test for normality (Massey, 1951), Shapiro and Wilk's W test (Shapiro et al., 1968; Royston, 1982), and Lilliefors' test (Lilliefors, 1967). The results for the W test on each of the three groups of data indicate that each group was sampled from populations that are normally distributed (Table N-1). The next step is to test for homogeneity of variances between the three groups. Three tests that may be used for this purpose are Levene's test (Milliken and Johnson, 1984), the Hartley F-max test (Sokal and Rohlf, 1981), and the Cochran C test (Winer, 1962). The result of Levene's test indicates that the variances of the three groups of data are not significantly different from each other (Table N-1). These test results mean that parametric statistics (the left side of Figure N-1) are appropriate for this dataset.

An appropriate parametric test to perform to determine whether the three mean cadmium concentrations are significantly different from each other is a 1-way ANOVA. The result of this test indicates that the three means are significantly different (Table N-1). What this result does not show, however, is whether each mean concentration is significantly different from both of the other mean concentrations. For this answer, multiple comparison tests can be used to perform all possible pairwise comparisons between each mean.

Three tests that can be used to perform a multiple comparison are the Newman-Keul test (Sokal and Rohlf, 1981), Duncan's Multiple Range test (Hays, 1988; Milliken and Johnson, 1984), and the Tukey Honest Significant Difference test (Hays, 1988; Milliken and Johnson, 1984). Three pairwise comparisons are possible between three means (1 vs. 2, 1 vs. 3, and 2 vs. 3). The results of Duncan's Multiple Range test indicate that the mean concentration at station 1 (21.5 ppm) is significantly lower than the mean concentrations at both station 2 (29.4 ppm) and station 3 (31.3 ppm), which in turn are not significantly different from each other. Therefore, to be most conservative (i.e., protective), the state could use the mean of the 16 replicate samples from stations 2 and 3 to calculate risk-based consumption limits. In this example, use of the concentration from any single station would not truly represent the potential contaminant exposure to fish consumers in the waterbody of concern.

N.2 TEMPORAL COMPARISON OF STATIONS

Both screening and intensive studies are often repeated over time to ensure that public health is adequately protected. By examining monitoring data from several time periods from a single site, it may be possible to detect trends in contaminant

concentrations in fish tissues. Trend analysis data should never be used to conduct risk assessments. Procedures for conducting risk assessments are adequately covered elsewhere in this document (see Section 6.1.2.7). Trend analysis may, however, be useful for monitoring the effects of various environmental changes or policies on the contaminant concentrations in the target species. For example, a state may have issued a fish advisory for a contaminant for which the source is known or suspected. Source control for this contaminant is the obvious solution to the environmental problem. An evaluation of the effectiveness of the source control may be made easier by trend analysis. The state would still need to perform statistical calculations comparing data from each sampling site to the selected SV, but trend analysis could yield valuable information about the success of remediation efforts even if the fish advisory remained in place because of SV exceedances.

Trend analysis can be performed using the statistical framework outlined in Figure N-1, but complexities in pollution data collected over time may make this approach unsuitable in some instances. The types of complexities for which other statistical approaches might be warranted can be divided into four groups: (1) changes in sampling and/or analysis procedures, (2) seasonality, and (3) correlated data (Gilbert, 1987). Each of these subjects is discussed briefly here.

Changes in the designation of an analytical laboratory to perform analyses or changes in sampling and/or analytical procedures are not uncommon in long-term monitoring programs. These changes may result in shifts in the mean or variance of the measured values, which could be incorrectly attributed to natural or manmade changes in the processes generating the pollution (Gilbert, 1987). Ideally, when changes occur in the methods used by the monitoring program, comparative studies should be performed to estimate the magnitude of these changes.

Seasonality may introduce variability that masks any underlying long-term trend. Statistically, this problem can be alleviated by removing the cycle before applying tests or by using tests unaffected by cycles (Gilbert, 1987). Such tests will not be discussed here. States interested in performing temporal analyses with data for which a seasonal effect is hypothesized should consult the nonparametric test developed by Sen (1968) or the seasonal Kendall test (Hirsch et al., 1982).

Measurements of contaminant concentrations taken over relatively short periods of time are likely to be positively correlated. Most statistical tests, however, including those in Figure N-1, require uncorrelated data. Gilbert (1987) discusses several methods for performing the required analyses in these cases.

Temporal trends in contaminant concentrations may be detected by regression analyses, whereby the hypothesis is tested that concentrations are not changing in a predictable fashion (usually linear) over time. If the hypothesis is rejected, a trend may be inferred. States interested in performing regression analyses should

consult statistics textbooks such as Gilbert (1987) or Snedecor and Cochran (1980).

N.3 REFERENCES

- Gilbert, R.O. 1987. *Statistical Methods for Environmental Pollution Monitoring*. Van Nostrand Reinhold Company, New York, NY. 320 pp.
- Hays, W.L. 1988. *Statistics*. Fourth Edition. CBS College Publishing, New York, NY.
- Hebert, C.E. and K.A. Keenleyside. 1995. To normalize or not to normalize? Fat is the question. *Environmental Toxicology and Chemistry* 14(5):801-807.
- Hirsch, R.M., J.R. Slack, and R.A. Smith. 1982. Techniques of trend analysis for monthly water quality data. *Water Resources Research* 18:107-121.
- Lilliefors, H.W. 1967. The Kolmogorov-Smirnov test for normality with mean and variance unknown. *J. Amer. Stat. Assoc.* 62:399-402.
- Massey, F.J., Jr. 1951. The Kolmogorov-Smirnov test for goodness of fit. *J. Amer. Stat. Assoc.* 46:68-78.
- Milliken, G.A., and D.E. Johnson. 1984. *Analysis of Messy Data: Volume 1. Designed Experiments*. Van Nostrand Reinhold Company, New York, NY.
- Royston, J.P. 1982. An extension of Shapiro and Wilk's W test for normality to large samples. *Applied Statistics* 31:115-124.
- Sen, P.K. 1968. On a class of aligned rank order tests in two-way layouts. *Annals of Mathematical Statistics* 39:1115-1124.
- Shapiro, S.S., M.B. Wilk, and H.J. Chen. 1968. A comparative study of various tests of normality. *J. Amer. Stat. Assoc.* 63:1343-1372.
- Snedecor, G.W., and W.G. Cochran. 1980. *Statistical Methods*. 7th edition. Iowa State University Press, Ames, IA.
- Sokal, R.R., and F.J. Rohlf. 1981. *Biometry. The Principles and Practice of Statistics in Biological Research*. Second Edition. W.H. Freeman and Company, New York, NY. 859 pp.
- Winer, B.J. 1962. *Statistical Principles in Experimental Design*. McGraw-Hill, New York, NY.

Annex X:

References

Annex X: References

Annex I: Indicative Tables of most consumed species of fish and seafood for different (sub) regions. JRC Technical Report 2010.

Bustamante P, Caurant F, Fowler SW, Miramand P. Cephalopods as a vector for the transfer of cadmium to top marine predators in the north-east Atlantic Ocean. *Sci. Total Environ.* 1998; 220: 71–80.

Commission Regulation (EU) No 835/2011 amending Regulation (EC) No 1881/2006 as regards maximum levels for polycyclic aromatic hydrocarbons in foodstuffs.

Commission Regulation (EU) No 836/2011 amending Regulation (EC) No 333/2006 laying down the methods of sampling and analysis for the official control of the levels of lead, cadmium, mercury, inorganic tin, 3-MCPD and benzo(a)pyrene in foodstuffs

EC (2010). Guidance Document No: 25 Guidance on chemical monitoring of sediment and biota under the Water Framework Directive

EU Commission Regulation (EC) No 333/2007, laying down the methods of sampling and analysis for the official control of the levels of lead, cadmium, mercury, inorganic tin, 3-MCPD and benzo(a)pyrene in foodstuffs

EU Commission Regulation (EC) No 644/2017), laying down methods of sampling and analysis for the official control of levels of dioxins and dioxin-like PCBs in certain foodstuffs

EU Commission Regulation (EC) No 836/2011 amending (EC) No 333/2007 laying down the methods of sampling and analysis for the official control of the levels of lead, cadmium, mercury, inorganic tin, 3-MCPD and benzo(a)pyrene in foodstuffs

EU Commission Regulation (EC) No 1881/2006, setting maximum levels for certain contaminants in seafood (Annex II)

ICES/OSPAR (2018). CEMP Guidelines for Monitoring Contaminants in Biota. Technical Annexes: 1) organic contaminants; 2) metals; 3) parent and alkylated PAHs; 8) chlorobiphenyls

JRC (2010). Marine Strategy Framework Directive. Technical Report of Task Group 9: Contaminants in fish and other seafood

UNEP/FAO/IOC/IAEA (1987). Reference methods No 6 (Rev. 1): Guidelines for monitoring chemical contaminants in marine organisms.

UNEP/FAO/IOC/IAEA (1988). Reference methods No 7 (Rev. 2): Sampling of selected marine organisms and sample preparation for trace metal analysis

UNEP/MAP (2019a). UNEP/MED WG.467/5. IMAP Guidance Factsheets: Update for Common Indicators 13, 14, 17, 18, 20 and 21: New proposal for candidate indicators 26 and 27;

UNEP (2019b). UNEP/MED WG.463/6. Monitoring Protocols for IMAP Common Indicators related to pollution;

UNEP (2019b) UNEP/MED WG.467/8. Data Standards and Data Dictionaries for Common Indicators related to pollution and marine litter.

US EPA (2000). Guidance for Assessing Chemical Contaminant Data for Use in Fish Advisories Volume 1 Fish Sampling and Analysis. Third Edition (Annex VIII)